

IFBC NO. 21-TA003698JH
26th STREET WEST AT 30TH AVENUE WEST
INTERSECTION IMPROVEMENTS
PROJECT NO. 6092460
(NIGP 913-27)
MAY 05, 2021

Manatee County BCC
Procurement Division
1112 Manatee Avenue West Ste 803
Bradenton, FL 34205
purchasing@mymanatee.org



ADVERTISEMENT

**INVITATION FOR BID CONSTRUCTION, NO. 21-TA003698JH
26th STREET WEST AT 30TH AVENUE WEST INTERSECTION IMPROVEMENTS**

Manatee County, a political subdivision of the State of Florida (hereinafter referred to as County), will receive sealed bids from individuals, corporations, partnerships, and other legal entities authorized to do business in the State of Florida, to provide 26th Street west at 30th Avenue West Intersection Improvements , as specified in this Invitation for Bid Construction to include upgrade to mast-arm supports, and add westbound left and right turn lanes..

DATE, TIME AND PLACE DUE:

The Due Date and Time for submission of Bids in response to this IFBC is **June 11, 2021 at 2:00 PM ET**. Bids must be delivered to the following location: Manatee County Administration Building, 1112 Manatee Ave. W., Suite 803, Bradenton, FL 34205 prior to the Due Date and Time.

SOLICITATION INFORMATION CONFERENCE:

A non-mandatory Information Conference will be held at 9:30 AM on May 14, 2021 via Zoom® meeting at the link below. Attendance to non-mandatory information conferences is not required, but is strongly encouraged.

DEADLINE FOR QUESTIONS AND CLARIFICATION REQUESTS:

The deadline to submit all questions, inquiries, or requests concerning interpretation, clarification or additional information pertaining to this Invitation for Bid Construction to the Manatee County Procurement Division is May 21, 2021. Questions and inquiries should be submitted via email to the Designated Procurement Contact shown below.

Important: A prohibition of lobbying is in place. Review Section A.13 carefully to avoid violation and possible sanctions.

DESIGNATED PROCUREMENT CONTACT: Jeb Hayter, Procurement Agent
(941) 749-3055, Fax (941) 749-3034
Email: jeb.hayter@mymanatee.org
Manatee County Financial Management Department
Procurement Division

AUTHORIZED FOR RELEASE: _____

Table of Contents

Section A, Information to Bidders

Section B, Bid Forms to be completed and returned with Bid

- Appendix A, Minimum Qualifications
- Appendix B, Bidder's Questionnaire
- Appendix C, Environmental Crimes Certification
- Appendix D, Florida Trench Safety Act
- Appendix E, ePayables Application
- Appendix F, Scrutinized Company Certification
- Appendix G, Hold Harmless
- Appendix H, Insurance Statement
- Appendix I, Acknowledgement of Addenda
- Appendix J, Affidavit of No Conflict
- Appendix K, Bid Pricing Form

Section C, Bid Attachments

- Bid Attachment 1- Insurance and Bond Requirements
- Bid Attachment 2 - Contract Documents
- Bid Attachment 3 - Special Provisions
- Bid Attachment 4 - Plans / Drawings
- Bid Attachment 5 - Geotechnical Engineering Report
- Bid Attachment 6 - Lighting Design Memorandum
- Bid Attachment 7 - Southwest Florida Water Management District Permit
- Bid Attachment 8 - Florida Department Of Environmental Protection Permit

Section D, Sample Construction Agreement with General Conditions of the Construction Agreement and Agreement Exhibits

SECTION A, INFORMATION FOR BIDDERS

To receive consideration, entities who submit a response to this Invitation for Bid Construction (Bidders) must meet the minimum qualification requirements and comply with the following instructions. Bid responses (Bids) will be accepted from single business entities, joint ventures, partnerships or corporations.

A.01 BID DUE DATE

The Due Date and Time for submission of Bids in response to this Invitation for Bid Construction (IFBC) is **June 11, 2021 at 2:00 PM ET**. Bids must be delivered to the following location: Manatee County Administration Building, 1112 Manatee Ave. W., Suite 803, Bradenton, FL 34205 and time stamped by a Procurement representative prior to the Due Date and Time.

Bids received after the Due Date and Time will not be considered. It will be the sole responsibility of the Bidder to deliver its Bid to the Manatee County Procurement Division for receipt on or before the Due Date and Time. If a Bid is sent by U.S. Mail, courier or other delivery services, the Bidder will be responsible for its timely delivery to the Procurement Division. Bids delayed in delivery will not be considered, will not be opened at the public opening, and arrangements will be made for their return at the Bidder's request and expense.

A.02 SOLICITATION INFORMATION CONFERENCE:

A non-mandatory Information Conference will be held at 10:00 AM on May 14, 2021 via Zoom® meeting at the link below. Attendance to non-mandatory information conferences is not required, but is strongly encouraged.

Zoom® Link: <https://manateecounty.zoom.us/j/86234080899>

Attendance to mandatory information conferences and/or site visits are required to meet the minimum qualification requirements of the IFBC. Attendance to non-mandatory information conferences is not required, but is strongly encouraged.

A.03 PUBLIC OPENING OF BIDS

Bids will be opened immediately following the Due Date and Time at the Manatee County Administration Building, Suite 803 in the presence of County officials. Bidders or their representatives may attend the Bid opening.

Zoom® Link: <https://manateecounty.zoom.us/j/81366199089>

Manatee County will make public at the opening the names of the business entities which submitted a Bid and the total bid price submitted. No review or analysis of the Bids will be conducted at the Bid opening.

A.04 SUBMISSION OF BIDS

The contents of the Bid sealed package must include:

- One (1) bound original clearly identifying Bidder and marked "ORIGINAL".
- One (1) electronic format copy clearly identifying Bidder.

Electronic format copy should be submitted on a Universal Serial Bus (USB) portable flash memory drive or compact disc (CD) in Microsoft Office® or Adobe Acrobat® portable document format (PDF) in one continuous file. Do not password protect or otherwise encrypt electronic Bid copies. Electronic copies must be searchable and contain an identical Bid to the original.

Submit the Bid package in a sealed container with the following information clearly marked on the outside of the package: IFBC NO. 21-TA003698JH, 26th Street West at 30th Avenue West Intersection Improvements, Bidder's name, and Bidder's address. Bids must be delivered to the Manatee County Procurement Division prior to the Due Date and Time at the following address:

Manatee County Procurement Division
1112 Manatee Ave. West, Ste. 803
Bradenton, FL 34205

A.05 DISTRIBUTION OF SOLICITATION DOCUMENTS

All documents issued pursuant to this IFBC are distributed electronically and available for download at no charge at www.mymanatee.org > *Bids and Proposals*. Documents may be viewed and downloaded for printing using Adobe Reader® software.

At its sole discretion, the County may utilize third-party providers to distribute proposals. Visit the third-party's website for more information regarding this service. Participation in the third-party system is not a requirement for doing business with Manatee County.

Additionally, the IFBC and all related documents are available for public inspection at the Manatee County Procurement Division, 1112 Manatee Avenue West, Suite 803, Bradenton, FL 34205. Call (941) 749-3014 to schedule an appointment. Documents are available between the hours of 8:00 A.M. and 5:00 P.M., Monday through Friday, with the exception of County holidays.

As a courtesy, Manatee County notifies the Manatee County Chamber of Commerce and the Manatee County Black Chamber of Commerce of all active solicitations, who then distributes the information to its members.

A.06 EXAMINATION OF BID DOCUMENTS AND SITE(S)

It is the responsibility of each bidder before submitting a bid, to (a) examine the IFBC documents thoroughly; (b) visit the Project Site(s) to become familiar with local conditions that may affect cost, progress, performance, or furnishing of the Work; (c) consider federal, state, and local codes, laws, and regulations that may affect costs, progress, performance, or furnishing of the Work; (d) study and carefully correlate bidder's observations with the IFBC documents; and (e) notify County in writing of all conflicts, errors, or discrepancies in the IFBC documents.

Each bidder may, at bidder's own expense, make or obtain any additional examinations, investigations, explorations, tests and studies, and obtain any additional information and data which pertain to the physical conditions at or contiguous to the Project Site(s) or otherwise which may affect cost, progress, performance or furnishing of the Work and which bidder deems necessary to determine his bid for performing and furnishing the Work in accordance with the time, price and other terms and conditions of the IFBC documents. County will provide each bidder access to the site(s) to conduct such explorations and tests.

Bidder shall fill all holes, clean up and restore the Project Site(s) to its former condition upon completion of such explorations. The lands upon which the Work is to be performed, rights-of-way and easements for access thereto, and other lands designated for use by successful bidder in performing the Work are identified in the IFBC documents.

All additional lands and access thereto required for temporary construction facilities or storage of materials and equipment are to be provided by successful bidder. Easements for permanent structures or permanent changes in existing structures are to be obtained and paid for by County unless otherwise provided in the IFBC documents.

Inspection of the Project Site(s) is a requirement to be considered for award of this bid. Prior to submitting a bid, each bidder shall examine the Project Site(s) and all conditions thereon fully familiarizing themselves with the full scope of the Work. Failure to become familiar with Project Site conditions will in no way relieve the successful bidder from the necessity of furnishing any materials or performing any Work that is required to complete the Project in accordance with the Project Plans and Specifications. Bidder shall acknowledge inspection of the Project Site(s) on his/her signed, submitted Bid Form.

A.07 ADDENDA

Any interpretations, corrections or changes to this IFBC will be made by addenda. Addenda will be posted on the Procurement Division's web page of the County website at <http://www.mymanatee.org/purchasing> > *Bids and Proposals*. For those solicitations that are advertised on a third-party website, addenda will also be posted on the third-party's distribution system on the 'Planholders' link.

All addenda are a part of the IFBC and each Bidder will be bound by such addenda. It is the responsibility of each Bidder to read and comprehend all addenda issued. Failure of any Bidder to acknowledge an issued addendum in its Bid will not relieve the Bidder from any obligation contained therein.

A.08 BID FORMS

Bids must include the forms provided in this IFBC. If needed, additional pages may be attached to a form. Bidders must fully complete and execute all Bid Forms. Bid Forms must be executed by an authorized official of the company who has the legal authority to bind the company.

A.09 BID EXPENSES

All costs incurred by Bidder in responding to this IFBC will be the sole responsibility of the Bidder.

A.10 QUESTION AND CLARIFICATION PERIOD

Each Bidder shall examine all IFBC documents and will judge all matters relating to the adequacy and accuracy of such documents. Any questions or requests concerning interpretation, clarification or additional information pertaining to this IFBC, including the sample Agreement, shall be made in writing via email to the Manatee County Procurement Division to the Designated Procurement Contact or to purchasing@mymanatee.org. All questions received and responses given will be provided to potential bidders via an addendum to this IFBC.

Manatee County will not be responsible for oral interpretations given by other sources including County staff, representative, or others. The issuance of a written addendum by the

Procurement Division is the only official method whereby interpretation, clarification or additional information will be given.

A.11 FALSE OR MISLEADING STATEMENTS

Bids which contain false or misleading statements, or which provide references which do not support an attribute or condition claimed by the Bidder, may be rejected. If, in the opinion of the County, such information was intended to mislead the County in its evaluation of the Bid, and the attribute, condition or capability is a requirement of this IFBC. Such Bidder will be disqualified from consideration for this IFBC and may be disqualified from submitting a response on future solicitation opportunities with the County.

A.12 CONFIDENTIALITY OF SECURITY RELATED RECORDS

- a. Pursuant to Florida Statutes § 119.071(3), the following records (hereinafter referred to collectively as “the Confidential Security Records”) are confidential and exempt from the disclosure requirements of Florida Statutes § 119.07(1):
 - i. A Security System Plan or portion thereof for any property owned by or leased to County or any privately owned or leased property held by County.
 - ii. Building plans, blueprints, schematic drawings, and diagrams, including draft, preliminary, and final formats, which depict the internal layout and structural elements of a building, arena, stadium, water treatment facility, or other structure owned or operated by County.
 - iii. Building plans, blueprints, schematic drawings, and diagrams, including draft, preliminary, and final formats, which depict the internal layout or structural elements of an attractions and recreation facility, entertainment or resort complex, industrial complex, retail and service development, office development, or hotel or motel development in the possession of, submitted to County.
- b. Successful Bidder agrees that, as provided by Florida Statute, it shall not, as a result of a public records request, or for other reason disclose the contents of, or release or provide copies of the Confidential Security Records to any other party absent the express written authorization of County’s Property Management Director or to comply with a court order requiring such release or disclosure. To the extent successful Bidder receives a request for such records, it shall immediately contact the County’s designated Contract administrator who shall coordinate County’s response to the request.

A.13 LOBBYING

After the issuance of any IFBC, prospective bidders, bidders, or their agents, representatives or persons acting at the request of such bidder shall not contact, communicate with or discuss any matter relating to the IFBC with any officer, agent or employee of Manatee County other than the Procurement Official or the contact identified in this IFBC, pursuant to the Manatee County Code of Laws. This prohibition includes copying such persons on all written communication, including email correspondence. This requirement begins with the issuance of an IFBC and ends upon execution of the final Agreement or when the IFBC has been cancelled. Violators of this prohibition shall be subject to sanctions as provided in the Manatee County Code of Laws.

A.14 UNBALANCED BIDDING PROHIBITED

County recognizes that large and/or complex projects will often result in a variety of methods, sources, and prices. However, where in the opinion of the County such variation does not appear to be justified given bid requirements and industry and market conditions, the Bid will

be presumed to be unbalanced. Examples of unbalanced Bids will include:

- a. Bids showing omissions, alterations of form, additions not specified, or required conditional or unauthorized alternate bids.
- b. Bids quoting prices that substantially deviate, either higher or lower, from those included in the Bids of competitive Bidders for the same line item unit costs.
- c. Bids where the unit costs offered are in excess of, or below reasonable cost analysis values.

In the event County determines that a Bid is presumed unbalanced, it will request the opportunity to and reserves the right to, review all source quotes, bids, price lists, letters of intent, and other supporting documentation which the Bidder obtained and upon which the Bidder relied upon to develop its Bid. County reserves the right to deem any presumptive unbalanced Bid where the Bidder is unable to demonstrate the validity and/or necessity of the unbalanced unit costs as non-responsive.

A.15 FRONT LOADING OF BID PRICING PROHIBITED

Prices offered for performance and/or acquisition activities which occur early in the Project Schedule, such as mobilization; clearing and grubbing; or maintenance of traffic; that are substantially higher than pricing of competitive bidders within the same portion of the Project Schedule, will be presumed to be front loaded. Front loaded bids could reasonably appear to be an attempt to obtain unjustified early payments creating a risk of insufficient incentive for the bidder to complete the Work or otherwise creating an appearance of an undercapitalized bidder.

In the event County determines that a bid is presumed to be front loaded, it will request the opportunity to, and reserves the right to, review all source quotes, bids, price lists, letters of intent, and other documents which the bidder obtained and upon which the bidder relied upon to develop the pricing or acquisition timing for these bid items. County reserves the right to reject as nonresponsive any presumptive front-loaded bids where the bidder is unable to demonstrate the validity and/or necessity of the front-loaded costs.

A.16 WITHDRAWAL OR REVISION OF BIDS

Bidders may withdraw Bids under the following circumstances:

- a. If Bidder discovers a mistake(s) prior to the Due Date and Time. Bidder may withdraw its Bid by submitting a written notice to the Procurement Division. The notice must be received in the Procurement Division prior to the Due Date and Time for receiving Bids. A copy of the request shall be retained, and the unopened Bid returned to the Bidder; or
- b. After the Bids are opened but before a contract is signed, Bidder alleges a material mistake of fact if:
 1. The mistake is clearly evident in the solicitation document; or
 2. Bidder submits evidence which clearly and convincingly demonstrates that a mistake was made in the Bid. Request to withdraw a Bid must be in writing and approved by the Procurement Official.

A.17 IRREVOCABLE OFFER

Any Bid may be withdrawn up until the Due Date and Time. Any Bid not so withdrawn shall, upon opening, constitute an irrevocable offer for a period of ninety (90) days to provide the

goods or services set forth in this IFBC or until one or more of the Bids have been duly accepted by County, whichever occurs first.

A.18 RESERVED RIGHTS

County reserves the right to accept or reject any and/or all bids, to waive irregularities and minor technicalities, and to request resubmission. Also, County reserves the right to accept all or any part of the bid and to increase or decrease quantities to meet additional or reduced requirements of County. Any sole response received by the first submission date may or may not be rejected by County depending on available competition and current needs of County. For all items combined, the bid of the lowest, responsive, responsible bidder will be accepted, unless all bids are rejected.

The lowest, responsible bidder shall mean that Bidder who makes the lowest Bid to sell goods and/or services of a quality which meets or exceeds the quality of goods and/or services set forth in the IFBC documents or otherwise required by County.

To be responsive, a Bidder shall submit a Bid which conforms in all material respects to the requirements set forth in the IFBC.

To be a responsible bidder, the bidder shall have the capability in all respects to perform fully the bid requirements, and the tenacity, perseverance, experience, integrity, reliability, capacity, facilities, equipment, and credit which will assure good faith performance.

Also, County reserves the right to make such investigation as it deems necessary to determine the ability of any bidder to furnish the service requested. Information County deems necessary to make this determination shall be provided by the bidder. Such information may include, but shall not be limited to current financial statements, verification of availability of equipment and personnel, and past performance records.

A.19 APPLICABLE LAWS

Bidder must be authorized to transact business in the State of Florida. All applicable laws and regulations of the State of Florida and ordinances and regulations of Manatee County will apply to any resulting Agreement. Any involvement with the Manatee County Procurement Division shall be in accordance with the Manatee County Procurement Ordinance as amended.

A.20 COLLUSION

By submitting a bid in response to this IFBC, Bidder certifies that it has not divulged, discussed or compared its bid with any other bidder, and has not colluded with any other bidder or parties to this bid whatsoever. Further, Bidder, and in the case of a joint bid each party thereto, certifies as to their own organization, that in connection with this IFBC that:

- a. All prices and/or cost data submitted have been arrived at independently, without consultation, communication, or agreement, for the purpose of restricting competition, as to any matter relating to such prices and/or cost data, with any other bidder or with any competitor;
- b. All prices and/or cost data quoted for this bid have not been knowingly disclosed by the Bidder and will not knowingly be disclosed by the Bidder, prior to the scheduled opening, directly or indirectly to any other bidder or to any competitor;

- c. No attempt has been made, or will be made, by Bidder to induce any other person or firm to submit or not to submit a bid for the purpose of restricting competition;
- d. The only person or persons interested in this bid is/are named in Bidder's Bid and that no person other than those identified has any interest in the Bid or in the resulting Agreement to be entered into.
- e. No person or agency has been employed or retained to solicit or secure the resulting Agreement upon an agreement or understanding or a commission, percentage, brokerage, or contingent fee except bona fide employees or established commercial agencies maintained by Bidder for purpose of doing business.

A.21 CODE OF ETHICS

With respect to this and any bid, if a Bidder violates, directly or indirectly, the ethics provisions of the Manatee County Procurement Code and/or Florida criminal or civil laws related to public procurement, including but not limited to Florida Statutes Chapter 112, Part II, Code of Ethics for Public Officers and Employees, such Bidder will be ineligible for award to perform the work described in this IFBC, and may be disqualified from submitting on any future quote or bid requests to supply goods or services to Manatee County. By submitting a bid, the Bidder represents to County that all statements made, and materials submitted are truthful, with no relevant facts withheld.

A.22 PUBLIC CONTRACTING AND ENVIRONMENTAL CRIMES

A person or affiliate who has been placed on the convicted vendor list following a conviction for a public entity crime, as that term is defined in Section 287.133, Florida Statutes, may not submit a bid to provide any goods or services to a public entity; may not submit a bid with a public entity for the construction or repair of a public building or public work; may not submit bids on leases of real property to a public entity; may not be awarded or perform Work as a contractor, supplier, Subcontractor, or consultant under an agreement with any public entity; and may not transact business with any public entity in excess of the threshold amount provided in Section 287.017, Florida Statutes, for CATEGORY TWO for a period of thirty-six (36) months following the date of being placed on the convicted list.

In addition, the Manatee County Code of Laws prohibits the award of any bid to any person or entity who/which has, within the past five (5) years, been convicted of, or admitted to in court or sworn to under oath, a public entity crime or of any environmental law that, in the reasonable opinion of the Procurement Official, establishes reasonable grounds to believe the person or business entity will not conduct business in a responsible matter.

To ensure compliance with the foregoing, the Code requires all persons or entities desiring to do business with County to execute and file with the Purchasing Official an affidavit, executed under the pain and penalties of perjury, confirming that person, entity and any person(s) affiliated with the entity, does not have such a record and is therefore eligible to seek and be awarded business with County. In the case of a business entity other than a partnership or a corporation, such affidavit shall be executed by an authorized agent of the entity. In the case of a partnership, such affidavit shall be executed by the general partner(s). A Public Contracting and Environmental Crimes Certification form is attached herein for this purpose.

A.23 SCRUTINIZED COMPANIES

Florida Statutes § 287.135, as amended from time to time, may contain limitations on the part of a company to conduct business with the County. Submission of a response to this

solicitation shall be subject to all procedural requirements contained within that statute including the submission of any required certification of eligibility to contract with the County. It shall be the responsibility of the company responding to this solicitation to concurrently review the current version of the statute and ensure it is compliant. To the extent a certification is required, it shall be provided on the form located at Appendix F *Vendor Certification Regarding Scrutinized Companies Lists*.

A.24 AGREEMENT

The successful Bidder will be required to execute the Agreement, a sample of which is attached hereto and made a part hereof. The County will transmit the Agreement to the successful Bidder for execution. The successful Bidder agrees to deliver the required number of duly executed copies of the Agreement, with any other required documents, to the County within ten calendar days of receipt.

A.25 LEGAL NAME

Bidders shall clearly indicate the full legal name, including any d/b/a, address, email address, and telephone number on the Bid Form. Bid Forms shall be signed above the typed or printed name and title of the signer. The signer must be an official of the organization and have the authority to bind the bidder to the submitted bid.

When bidder is a partnership, the Bid Form shall be signed in the name of the firm and by all partners required under the terms of the partnership agreement. When a corporation is a bidder, the authorized corporate officers shall sign.

Bidders who are corporations or limited partnerships shall provide a certified copy of their permit to transact business in the State of Florida, preferably along with the Bid Form, or within forty-eight (48) hours after request by County.

When submitting a bid as a joint venture, it must have filed paper documents with the Division of Profession's Construction Industry Licensing Board prior to submitting a bid.

A.26 DISCOUNTS

All discounts must be incorporated in the prices contained in the bid and not shown separately. Unless otherwise specified in this IFBC, pricing must be all inclusive, including delivery costs. The prices indicated on the Pricing Form shall be the prices used in determining award.

A.27 TAXES

Manatee County is exempt from Federal Excise and State Sales Taxes. (F.E.T. Cert. No. 59-78-0089K; Florida Sales Tax Exempt Cert. No. 85-8012622206C-6). Therefore, the Bidder is prohibited from delineating a separate line item in its bid for any sales or service taxes.

The successful Bidder will be responsible for the payment of taxes of any kind, including but not limited to sales, consumer, use, and other similar taxes payable on account of the work performed and/or materials furnished under the award in accordance with all applicable laws and regulations.

A.28 QUALITY

Unless otherwise specifically provided in the IFBC documents, all goods provided shall be new, the latest make or model, of the best quality, of the highest grade of workmanship, and of the most suitable for the purpose intended.

Unless otherwise specifically provided in the IFBC documents, reference to any equipment, material, article or patented process, by trade name, brand name, make or catalog number, shall be regarded as establishing a standard of quality and shall not be construed as limiting competition.

A.29 AUTHORIZED PRODUCT REPRESENTATION

Bidder, by virtue of submitting the name and specifications of a manufacturer's product, will be required to furnish the named manufacturer's product. Failure to do so may, in the County's sole discretion, be deemed a material breach of the resulting agreement and shall constitute grounds for County's immediate termination of the resulting agreement.

A.30 ROYALTIES AND PATENTS

The successful Bidder shall pay all royalties and license fees for equipment or processes in conjunction with the equipment and/or services being furnished. Successful Bidder shall defend all suits or claims for infringement of any patent, trademark or copyright, and shall save County harmless from loss on account thereof, including costs and attorney's fees.

A.31 AMERICANS WITH DISABILITIES ACT

Manatee County does not discriminate upon the basis of any individual's disability status. This non-discrimination policy involves every aspect of County's functions including one's access to participation, employment, or treatment in its programs or activities. Anyone requiring reasonable accommodation for an information conference or bid opening should contact the person named on the cover page of this document at least twenty-four (24) hours in advance of either activity.

A.32 EQUAL EMPLOYMENT OPPORTUNITY

In accordance with Title VI of the Civil Rights Act of 1964, Title 15, Part 8 of the Code of Federal Regulations and the Civil Rights Act of 1992, Manatee County hereby notifies all Bidders that it will affirmatively ensure minority business enterprises are afforded full opportunity to participate in response to this IFBC and will not be discriminated against on the grounds of race, color, national origin, religion, sex, age, handicap, or marital status in consideration of award.

A.33 MINORITY AND/OR DISADVANTAGED BUSINESS ENTERPRISES

The State of Florida Office of Supplier Diversity provides the certification process and maintains the database of certified MBE/DBE firms. Additional information may be obtained at https://www.dms.myflorida.com/agency_administration/office_of_supplier_diversity_osd or by calling (850) 487-0915.

A.34 DELIVERY

Unless otherwise specified, all prices shall include all delivery cost (FOB Destination).

A.35 MATHEMATICAL ERRORS

- a. Bid pricing forms without imbedded mathematical formulas: In the event of multiplication/extension error(s), the unit price shall prevail. In the event of addition error(s) the extension totals will prevail. In the event the dollar amount for contract contingency is omitted, it will be added to the total price of the Bid.

- b. Bid pricing forms with imbedded mathematical formulas: Interactive bid pricing forms that contain mathematical formulas may be provided to automate lengthy and complex bid forms. In the event bid pricing forms with imbedded formulas are used and a multiplication/extension error(s) is discovered in the formula, the unit price entered by the Bidder shall prevail.
- c. Bidder shall assume the responsibility and accuracy of the information input in the bid pricing form and therefore shall verify that the calculations are correct before submitting its Bid.
- d. Regardless of the type of bid pricing form used, all Bids shall be reviewed mathematically by the County using these standards.

A.36 SUBCONTRACTORS

The successful bidder will obtain prior written approval from the County for any subcontractor(s) and the work each will perform. A subcontractor is defined as any entity performing work within the scope of the project who is not an employee of the successful Bidder.

Bidders subcontracting any portion of the work shall include a list of subcontractors along with their bid. The list shall include: name and address of subcontractor, type of work to be performed and the percent of the contract amount to be subcontracted.

A.37 E-Verify

Prior to the employment of any person under this contract, the successful Bidder shall utilize the U.S. Department of Homeland Security's E-Verify system to verify the employment eligibility of (a) all persons employed during the contract term by the successful Bidder to perform employment duties within Florida and (b) all persons, including subcontractors, assigned by the successful Bidder to perform work pursuant to the contract with Manatee County. For more information on this process, please refer to United States Citizenship and Immigration Service site at: <http://www.uscis.gov/>.

Only those individuals determined eligible to work in the United States shall be employed under this contract.

By submission of a bid in response to this IFBC, the successful Bidder commits that all employees and subcontractors will undergo e-verification before placement on this contract.

The successful Bidder shall maintain sole responsibility for the actions of its employees and subcontractors. For the life of the contract, all employees and new employees brought in after contract award shall be verified under the same requirement stated above.

A.38 DISCLOSURE

Upon receipt, all inquiries and responses to inquiries related to this IFBC become "Public Records," and shall be subject to public disclosure consistent with Florida Statutes, Chapter 119.

Bids become subject to disclosure thirty (30) days after the opening or if a notice of intent to award decision is made earlier than this time as provided by Florida Statutes § 119.071(1)(b). No announcement or review of the bids shall be conducted at the public opening.

Based on the above, County will receive bids at the time and date stated and will make public at the opening the names of the business entities of all that submitted a bid.

If County rejects all bids and concurrently notices its intent to reissue the solicitation, the rejected bids are exempt from public disclosure until such time as County provides notice of an intended decision concerning the reissued solicitation or until County withdraws the reissued solicitation. A bid is not exempt for longer than twelve (12) months after the initial notice rejecting all bids.

Pursuant to Florida Statutes 119.0701, to the extent successful Bidder is performing services on behalf of the County, successful Bidder must:

- a. Keep and maintain public records required by public agency to perform the service.
- b. Upon request from the public agency's custodian of public records, provide the public agency with a copy of the requested records or allow the records to be inspected or copied within a reasonable time at a cost that does not exceed the cost provided in Florida Statutes, Chapter 119, or as otherwise provided by law.
- c. Ensure that public records that are exempt or confidential and exempt from public records disclosure requirements are not disclosed except as authorized by law for the duration of the contract term and following completion of the contract if the successful Bidder does not transfer the records to the public agency.
- d. Upon completion of the contract, transfer, at no cost, to the public agency all public records in possession of contractor or keep and maintain public records required by the public agency to perform the service. If the successful Bidder transfers all public records to the public agency upon completion of the contract, the successful Bidder shall destroy any duplicate public records that are exempt or confidential and exempt from public records disclosure requirements. If the successful Bidder keeps and maintains public records upon completion of the contract, the successful Bidder shall meet all applicable requirements for retaining public records. All records stored electronically must be provided to the public agency, upon request from public agency's custodian of public records, in a format that is compatible with the information technology systems of the public agency.

IF THE SUCCESSFUL BIDDER HAS QUESTIONS REGARDING THE APPLICATION OF CHAPTER 119, FLORIDA STATUTES, TO THE SUCCESSFUL BIDDER'S DUTY TO PROVIDE PUBLIC RECORDS RELATING TO ANY RESULTING CONTRACT, CONTACT COUNTY'S CUSTODIAN OF PUBLIC RECORDS AT:

Phone: (941) 742-5845

Email: debbie.scaccianoce@mymanatee.org

Mail: Manatee County BCC

Attn: Records Manager

1112 Manatee Ave W.

Bradenton, FL 34205.

A.39 LOCAL PREFERENCE

Local business is defined as a business legally authorized to engage in the sale of the goods and/or services, and which certifies within its Bid that for at least six (6) full months prior to the advertisement of this IFBC it has maintained a physical place of business in Manatee, Desoto, Hardee, Hillsborough, Pinellas or Sarasota County with at least one full-time employee at that location.

Local preference shall not apply to the following categories of agreements:

- a. Purchases or agreements which are funded, in whole or in part, by a governmental or other funding entity, where the terms and conditions governing the funds prohibit the preference.
- b. Any bid announcement which specifically provides that local preference, as set forth in this section, is suspended due to the unique nature of the goods or services sought, the existence of an emergency as found by either the County Commission or County Administrator, or where such suspension is, in the opinion of the County Attorney, required by law.
- c. For a competitive solicitation for construction services in which fifty percent (50%) or more of the cost will be paid from state.
- d. To qualify for local preference under this section, **a local business must certify to County** by completing an **"Affidavit as to Local Business Form,"** which is available for download at www.mymanatee.org/vendor. Click on "Affidavit for Local Business" to access and print the form. Complete, notarize, and mail the notarized original to the following address: Manatee County Procurement Division, 1112 Manatee Avenue West, Suite 803, Bradenton, FL 34205.
- e. It is the responsibility of the bidder to ensure accuracy of the Affidavit as to Local Business and notify County of any changes affecting same.

A.40 VENDOR REGISTRATION

Registering your business will provide Manatee County a sourcing opportunity to identify suppliers of needed goods and services and identify local businesses. To register as a supplier with the County go to www.mymanatee.org/vendor. For assistance with supplier registration, call the Procurement Division main number at (941) 749-3014. Office hours are Monday – Friday, 8:00 A.M. to 5:00 P.M., excluding County holidays.

A link to Vendor Registration is listed on the Procurement Division's web page at <http://www.mymanatee.org/home/government/departments/financial-management/purchasing.html>. Click on "Register as a Vendor", then "Vendor Registration Form". Registration is not mandatory to submit a Bid.

A.41 ENVIRONMENTAL SUSTAINABILITY

All bidders are encouraged to use as many environmentally preferable "green" products, materials, as supplies, as possible to promote a safe and healthy environment. Environmentally preferable are products or services that have a reduced adverse effect on the environment.

Bidder shall acknowledge in its Bid if Bidder has an environmental sustainability initiative. In addition, Bidder shall submit with its Bid a brief summary of Bidder's environmental sustainability initiative. This information will be used as a determining factor in the award decision when all other factors, including local preference, are otherwise equal.

A.42 ePAYABLES

Manatee County Board of County Commissioners and the Manatee County Clerk of the Circuit Court have partnered to offer the ePayables program, which allows payments to be made to vendors via credit cards.

The Clerk of the Circuit Court will issue a unique credit card number to vendor after goods are delivered or services rendered, vendors submit invoices to the remit to address on the purchase order. When payments are authorized, an email notification is sent to the vendor. The email notification includes the invoice number(s), invoice date(s), and amount of payment. There is no cost for vendors to participate in this program; however, there may be a charge by the company that processes your credit card transactions.

If Bidder is interested in participating in this program, complete the ePayables Application attached herein and return the completed form via email to tina.mancini@manateeclerk.com.

A.43 BASIS OF AWARD

County will not make award to a Bidder who is delinquent in payment of any taxes, fees, fines, contractual debts, judgments, or any other debts due and owed to the County, or is in default on any contractual or regulatory obligation to the County. By submitting this solicitation response, Bidder attests that it is not delinquent in payment of any such debts due and owed to the County, nor is it in default on any contractual or regulatory obligation to the County. In the event the Bidder's statement is discovered to be false, bidder will be subject to suspension and/or debarment and the County may terminate any award it has with bidder.

Award shall be to the lowest, responsive, responsible bidder(s) meeting specifications which includes delivery time requirements, qualification requirements, and having the lowest total offer for requirements listed on the Bid Form for the Work as set forth in this IFBC. Bid prices shall include costs for furnishing all labor, equipment and/or materials for the completion of the Work to the County's satisfaction, in accordance with and in the manner set forth and described in the IFBC documents and within the prescribed time.

Multiple schedules for completion of Work shall be considered. Two bids shall be submitted and considered, Bid 'A' based on 330 calendar days completion time and Bid 'B' based on 400 calendar days completion time. County, at its sole discretion, shall select either Bid 'A' or Bid 'B', whichever is in the best interest of the County. Only one (1) award will be made.

In evaluating Bids, County shall consider the qualifications of the Bidders; and if required, may also consider the qualifications of the subcontractors, suppliers, and other persons and organizations proposed. County may also consider the operating costs, maintenance requirements, performance data and guarantees of major items of materials and equipment proposed for incorporation in the Work.

Whenever two or more responsive, responsible bids which are equal with respect to price and all other evaluation factors are received, the bid from the local business shall be given preference in award.

Whenever two or more responsive, responsible bids which are equal with respect to price are received, and both or neither of these bids are from a local business, the award shall be determined by a chance drawing, coin toss, or similar tie-breaking method conducted by the Procurement Division and open to the public.

Bidder acknowledges that County has, or may hire, others to perform work similar to or the same as that which is within the scope of work of this IFBC. In the event that the successful Bidder cannot meet the delivery time or availability requirements of materials, the County, at its sole discretion can obtain the goods and services from other sources.

A.44 SCOPE OF WORK

The successful Bidder shall furnish and install all materials, equipment and labor which is reasonably inferable and necessary for the proper completion of the Work specified in this IFBC, whether specifically indicated in the IFBC or not.

The successful Bidder shall furnish all shop drawings, work drawings, labor, materials, equipment, tools, services and incidentals necessary to complete all Work required by these Specifications.

The successful Bidder shall perform the Work complete, in place and ready for continuous service and shall include any repairs, replacements, and / or restoration required as a result of damages caused prior to acceptance by the County.

The Scope of Work consist of upgrade to mast-arm supports, and add westbound left and right turn lanes.

A.45 COMPLETION OF WORK

The Work will be completed and ready for final inspection within the specified calendar days from the date the Contract Time commences to run. Completion time shall be based on Bid 'A' for 330 calendar days or Bid 'B' based on 400 calendar days time at the County's sole discretion.

A.46 LIQUIDATED DAMAGES

If the successful Bidder fails to achieve substantial completion of the Work within the contract time and as otherwise required by the Agreement (to include not only the entire Work but any portion of the Work as set forth therein), the County shall be entitled to retain or recover from the successful Bidder, as liquidated damages and not as a penalty, the sum of \$2,048.00 per calendar day, commencing upon the first day following expiration of the contract time and continuing until the actual date of substantial completion.

Such liquidated damages are hereby agreed to be a reasonable estimate of damages the County will incur because of delayed completion of the Work. The County may deduct liquidated damages as described in this paragraph from any unpaid amounts then or thereafter due the successful bidder under this Agreement. Any liquidated damages not so deducted from any unpaid amounts due the successful bidder shall be payable to the County at the demand of the County, together with interest from the date of the demand at the maximum allowable rate.

A.47 CONTRACT CONTINGENCY WORK

Contract contingency is a monetary allowance used solely at County's discretion to handle unexpected conditions as required to satisfactorily complete the Work in accordance with the IFBC documents. A Field Directive must be issued by an authorized County representative to authorize use of contract contingency funds.

The percentage for contract contingency is listed on the Bid Form. Bidder shall enter the dollar amount for contract contingency based on the percentage of the total base bid. The total contract award will include contract contingency.

Appropriate uses of contract contingency include increases to existing bid item quantities that do not change the initial Scope of Work, which may be directed by County staff; modification items not originally bid which were unforeseen yet necessary during the Work to provide a

safe, complete Project and that do not change the initial Scope of Work; and unanticipated conflicts and/or design changes required during construction which are necessary to provide a safe, complete Project and that do not change the initial Scope of Work.

Inappropriate uses of contract contingency include anything that changes the initial Scope of Work, including the Contract Sum and Contract Time, and adding bid items not previously contemplated that change the initial Scope of Work.

A.48 LICENSES AND PERMITS

The successful Bidder shall be solely responsible for obtaining all necessary license and permit fees, including, but not limited to, all license fees, permit fees, impact fees, or inspection fees, and responsible for the costs of such fees. Successful Bidder is solely responsible for ensuring all work complies with all Federal, State, local, and Manatee County ordinances, orders, codes, laws, rules, regulations, directives, and guidelines.

A.49 PROTEST

Any actual bidder, proposer, or contractor who is aggrieved in connection with the notice of intent to award of a contract with a value greater than \$250,000 where such grievance is asserted to be the result of a violation of the requirements of the Manatee County Procurement Code or any applicable provision of law by the officers, agents, or employees of the County, may file a protest to the Procurement Official.

Protest must be in writing and delivered via email at purchasing@mymanatee.org or by hand delivery to the Procurement Division at 1112 Manatee Avenue West, Suite 803, Bradenton, FL 34205 by 5:00 p.m. on the fifth business day following the date of posting of the Notice of Intent to Award on the County website. There is no stay of the procurement process during a protest. The Procurement Official shall have the authority to settle and resolve a protest concerning the intended award of a contract.

For additional information regarding the County protest process, visit the Procurement Division webpage on the County website.

A.50 ACCESSIBILITY

The County is committed to making its documents and information technologies accessible to individuals with disabilities by meeting the requirements of Section 504 of the Rehabilitation Act and best practices (w3C WCAG 2). **For assistance with accessibility regarding this solicitation, contact the Manatee County Procurement Division via email at purchasing@mymanatee.org or by phone at 941-748-4501 X3014.**

Successful Bidder shall ensure all its electronic information, documents, applications, reports, and deliverables required under this Agreement are in a format that meets the requirements of Section 504 of the Rehabilitation Act and best practices (w3C WCAG 2).

Where not fully compliant with these requirements and best practices, Successful Bidder shall provide clear points of contact for each document and information technology to direct users in how to obtain alternate formats. Further, successful Bidder shall develop accommodation strategies for those non-compliant resources and implement strategies to resolve the discrepancies.

A.51 SOLICITATION SCHEDULE

The following schedule has been established for this Solicitation process. Refer to the County's

website (www.mymanatee.org > Business > *Bids & Proposals*) for meeting locations and updated information pertaining to any revisions to this schedule.

| Scheduled Item | Scheduled Date |
|--|----------------------------|
| A non-mandatory Information Conference will be held via Zoom® meeting. Attendance to non-mandatory information conferences is not required, but is strongly encouraged | May 14, 2021 9:30 AM, ET |
| Question and Clarification Deadline | May 21, 2021 |
| Final Addendum Posted | May 28, 2021 |
| Bid Response Due Date and Time | June 11, 2021, 2:00 PM, ET |
| Due Diligence Review Completed | June 29, 2021 |
| Projected Award | July, 2021 |

NOTE: Any statements contained in the Scope of Work, Bid Summary, Construction Agreement, General Conditions of the Construction Agreement and/or Exhibits which vary from the information in Section A, Information for Bidders, shall have precedence over the Information for Bidders.

END OF SECTION A

SECTION B, BID FORMS

(To be completed and returned with Bid)

APPENDIX A, MINIMUM QUALIFICATIONS

APPENDIX A, MINIMUM QUALIFICATIONS

IFBC No. 21-TA003698JH

Bidders must submit the information and documentation requested in this Attachment that confirms Bidder meets the following minimum qualification requirement(s):

1. Must have been registered with the State of Florida, Division of Corporations to do business in Florida.

No documentation is required. The County will verify registration.

2. Bidder, or its representative(s), has made an inspection of the construction site for work specified in this IFBC on or after the date of advertisement of this IFBC and prior to the Due Date and Time.

Bidder must submit a statement on company letterhead and signed by an authorized official of Bidder that Bidder, or its representative(s), has made an inspection of the construction site, listing the date of the inspection and the individuals, by name, who conducted the inspection.

3. Bidder must be a Florida Department of Transportation (FDOT) Pre-Qualified Contractor in the category of "Traffic Signal" **or** must have a General Contractor's license issued by the Florida Department of Business and Professional Regulation **and** subcontract with an FDOT Pre-Qualified Contractor in the category of "Traffic Signal" for a period of at least three (3) consecutive years since April 1, 2018. License must be current and valid through the Due Date for submission of bids for this IFBC.

If bidding as an FDOT Pre-Qualified Contractor no documentation is required. The County will verify that the Bidder is listed in the FDOT database as a Pre-Qualified Traffic Signal Contractor.

If bidding as a General Contractor, the Bidder must subcontract with an FDOT Pre-Qualified Contractor in the category of "Traffic Signal" and provide the name of that FDOT Pre-Qualified subcontractor with their Appendix A- Bidder's Questionnaire. Provide a copy of Bidder's General Contractor's license issued by the Florida Department of Business and Professional Regulation and the County will verify that Bidder's subcontractor is listed in the FDOT database as a Pre-Qualified Traffic Signal Contractor.

4. Bidder has provided signalized Intersection Improvements for at least three (3) projects since April 1, 2018 in which each project included the following components: (i) Traffic Signals, (ii) Signing and pavement marking, (iii) Lighting, (iv) Milling and resurfacing, (v) Concrete curb and sidewalk, (vi) Utilities.

Provide the following information for the three (3) qualifying project references.

- a) Name of client**
- b) Project name**
- c) Location (City/State)**
- d) Client contact name**
- e) Contact phone**
- f) Contact email**
- g) Service dates (Start/End)**

5. Bidder, on the day the bid is submitted, has a certified or registered Qualifying Agent, as required by Section 489.119, Florida Statutes, and that Qualifying Agent has been the same Qualifying Agent of Bidder for a period of at least two (2) consecutive years, since April 1, 2019.

Submit a copy of Bidder's Qualifying Agent's registration or certification along with supporting documentation confirming Qualifying Agent has been the Qualifying Agent for Bidder for two (2) years, since April 1, 2019.

6. Bidder is not on the Florida Department of Management Services Suspended, Debarred, Convicted Vendor Lists.

No documentation is required. The County will verify

7. If Bidder is submitting as a joint venture must file the required documents with the Florida Department of Business and Professional Regulation as required by Florida Statute Section 489.119, prior to the Due Date and Time.

If Bidder is not a joint venture, provide a statement to that effect. If Bidder is a joint venture, provide a copy of Bidder's approved filing with the Florida Department of Business and Professional Regulation.

8. Bidder has no reported conflict of interests in relation to this IFBC.

Submit a fully completed copy of Appendix J If applicable, on a separate page disclose the name of any officer, director or agent who is also an employee of the County. Disclose the name of any County employee who owns, directly or indirectly, any interest in the Bidder's firm or any of its branches. If no conflicts of interests are present, Bidder must submit a statement to that affect.

END OF APPENDIX A

APPENDIX B, BIDDER'S QUESTIONNAIRE

Bidder must fully complete and return this form with its Bid. Bidder warrants the truth and accuracy of all statements and answers herein contained. (Attach additional pages if necessary.)

THIS QUESTIONNAIRE MUST BE COMPLETED AND SUBMITTED WITH YOUR BID

1. Contact Information:

FEIN #: _____
License #: _____
License Issued to: _____
Date License Issued (MM/DD/YR): _____
Company Name: _____
Physical Address: _____
City: _____ State of Incorporation: _____ Zip Code: _____
Phone Number: () _____ Fax Number: () _____
Email address: _____

2. Bidding as: an individual __; a partnership __; a corporation __; a joint venture __

3. If a partnership, list names and addresses of partners; if a corporation, list names of officers, directors, shareholders, and state of incorporation; if joint venture, list names and address of ventures' and the same if any venture are a corporation for each such corporation, partnership, or joint venture:

4. Bidder is authorized to do business in the State of Florida: Yes No

For how many years? _____

5. Your organization has been in business (under this firm's name) as a

Is this firm in bankruptcy? _____

6. Attach a list of projects where this specific type of Work was performed.

BIDDER: _____

7. Is this firm currently contemplating or in litigation? Provide summary details.

8. Have you ever been assessed liquidated damages under a contract during the past five (5) years? If so, state when, where (contact name, address and phone number) and why.

9. Have you ever failed to complete Work awarded to you? Or failed to complete projects within contract time? If so, state when, where (contact name, address, phone number) and why.

10. Have you ever been debarred or prohibited from providing a bid to a governmental entity? If yes, name the entity and describe the circumstances.

11. Will you subcontract any part of this Work? If so, describe which portion(s) and to whom.

12. If any part of work will be subcontracted, list MBE/DBE/WBE/VETERAN to be utilized. Include the estimated dollar amount of the portion of Work each will perform.

BIDDER: _____

13. What equipment do you own to accomplish this Work? (A listing may be attached)

14. What equipment will you purchase/rent for the Work? (Specify which)

15. If applicable to the Work for this IFBC, Drilling Supervisor Qualifications: Contractor shall provide a boring specialist who shall remain on the project site during the entirety of the directional boring operation. This includes, but is not limited to, drilling fluid preparation, seaming, boring and pulling. The boring specialist shall have a minimum of five (5) years' experience in supervising directional bores of similar nature, diameter, materials and lengths. (Reference: Specification Section 02619, Horizontal Directional Drilling).

Provide the contact information for a minimum of three (3) projects wherein the boring specialist has performed this type of work, diameter, materials and lengths.

Boring specialist's name: _____

Boring specialist's years of experience in supervising directional bores _____

Provide contact name, and contact number for projects:

16. If applicable to the Work for this IFBC, Pipe Fusion Qualifications: All boring and fusing equipment shall be certified for operation. The Contractor responsible for thermal butt fusing pipe and fittings shall have manufacturer certification for performing such work or a minimum of five (5) years of experience performing this type of work.

Thermal butt fusing pipe and fittings contractor or subcontractor's name: _____

Attach a copy of contractor's/subcontractor's manufacturer certification to this Questionnaire

OR

Provide contractor's/subcontractor's years of experience in thermal butt fusing pipe and fittings _____

If manufacturer certification is not provided, include contact name, and contact number for projects that confirms five years of experience:

BIDDER: _____

17. If applicable to the Work for this IFB, Pipe Bursting Qualifications: The Contractor shall be certified by the manufacturer of the pipe bursting system that they are fully trained licensed installer of the manufacturer's pipe bursting system. Contractor shall provide a letter to the County documenting this requirement. (Reference: Specification Section 02619A, Pipe Bursting (PB) of Existing Mains).

18. List the following regarding the surety which is providing the bond(s):

Surety's Name: _____

Address: _____

Name, address, phone number and email of surety's resident agent for service of process in Florida:

Agent's Name: _____

Address: _____

Phone: _____

Email: _____

19. Is Bidder a local business as defined in Section A.38, Local Preference?

Yes

No

If yes, by signing below Bidder certifies that for at least six months prior to the advertisement date of this IFB it has maintained a physical place of business in Manatee, Desoto, Hardee, Hillsborough, Pinellas or Sarasota counties with at least one full-time employee at that location.

BIDDER: _____

BY: _____

PRINTED NAME: _____

TITLE/DATE: _____

PHYSICAL ADDRESS OF QUALIFYING LOCAL LOCATION: _____

NAME OF QUALIFYING EMPLOYEE AT LOCAL LOCATION: _____

BIDDER: _____

20. Confirm if Bidder has an environmental sustainability initiative as defined in Section A.41.

Yes No

If yes, submit a brief summary (2-3 paragraphs) of the environmental sustainability initiative.

BIDDER: _____

APPENDIX C, ENVIRONMENTAL CRIMES CERTIFICATION

SWORN STATEMENT PURSUANT TO ARTICLE V, MANATEE COUNTY PROCUREMENT CODE

Bidder must fully complete and return this form with its Bid. This form must be signed and sworn to in the presence of a notary public or other official authorized to administer oaths.

This sworn statement is submitted to the Manatee County Board of County Commissioners by

_____ [Print individual's name and title]

for _____ [Print name of entity submitting sworn statement]

whose business address is _____

and (if applicable) its Federal Employer Identification Number (FEIN) is _____. If the entity has no FEIN, include the Social Security Number of the individual signing this sworn statement: _____.

I understand that no person or entity shall be awarded or receive an Owner’s Agreement for public improvements, procurement of goods or services (including professional services) or an Owner’s lease, franchise, concession or management agreement, or shall receive a grant of Owner’s monies unless such person or entity has submitted a written certification to Owner that it has not:

(1) been convicted of bribery or attempting to bribe a public officer or employee of Manatee County, the State of Florida, or any other public entity, including, but not limited to the Government of the United States, any state, or any local government authority in the United States, in that officer's or employee's official capacity; or

(2) been convicted of an agreement or collusion among bidders or prospective bidders in restraint of freedom of competition, by agreement to bid a fixed price, or otherwise; or

(3) been convicted of a violation of an environmental law that, in the sole opinion of Owner’s Purchasing Official, reflects negatively upon the ability of the person or entity to conduct business in a responsible manner; or

(4) made an admission of guilt of such conduct described in items (1), (2) or (3) above, which is a matter of record, but has not been prosecuted for such conduct, or has made an admission of guilt of such conduct, which is a matter of record, pursuant to formal prosecution. An admission of guilt shall be construed to include a plea of nolo contendere; or

(5) where an officer, official, agent or employee of a business entity has been convicted of or has admitted guilt to any of the crimes set forth above on behalf of such an entity and pursuant to the direction or authorization of an official thereof (including the person committing the offense, if he is an official of the business entity), the business shall be chargeable with the conduct herein above set forth. A business entity shall be chargeable with the conduct of an affiliated entity, whether wholly owned, partially owned, or one which has common ownership or a common Board of Directors. For purposes of this Form, business entities are affiliated if, directly or indirectly, one business entity controls or has the power to control another business entity, or if an individual or group of individuals controls or has the power to control both entities. Indicia of control shall include, without limitation, interlocking management or ownership, identity of interests among family members, shared organization of a business entity following the ineligibility of a business entity under this

Article, or using substantially the same management, ownership or principles as the ineligible entity.
(Continued)

Any person or entity who claims that this Article is inapplicable to him/her/it because a conviction or judgment has been reversed by a court of competent jurisdiction shall prove the same with documentation satisfactory to Owner's Purchasing Official. Upon presentation of such satisfactory proof, the person or entity shall be allowed to contract with Owner.

I UNDERSTAND THAT THE SUBMISSION OF THIS FORM TO THE CONTRACTING OFFICER FOR MANATEE COUNTY IS VALID THROUGH DECEMBER 31 OF THE CALENDAR YEAR IN WHICH IT IS FILED. I ALSO UNDERSTAND THAT ANY AGREEMENT OR BUSINESS TRANSACTION SHALL PROVIDE FOR SUSPENSION OF PAYMENTS, OR TERMINATION, OR BOTH, IF THE CONTRACTING OFFICER OR COUNTY ADMINISTRATOR DETERMINES THAT **SUCH** PERSON OR ENTITY HAS MADE FALSE CERTIFICATION.

[Signature]

STATE OF _____
COUNTY OF _____

Sworn to and subscribed before me this ____ day of _____, 20____ by _____

Who is personally known / has produced _____ as identification
[Type of identification]

My commission expires _____

Notary Public Signature

[Print, type or stamp Commissioned name of Notary Public]

Signatory Requirement - In the case of a business entity other than a partnership or a corporation, this affidavit shall be executed by an authorized agent of the entity. In the case of a partnership, this affidavit shall be executed by the general partner(s). In the case of a corporation, this affidavit shall be executed by the corporate president.

APPENDIX D, FLORIDA TRENCH SAFETY ACT

Bidder must fully complete and return this form with its Bid. This form must be signed in the presence of a notary public or by an officer authorized to administer oaths.

1. This Sworn Statement is submitted with **IFBC NO. 21-TA003698JH**
2. This Sworn Statement is submitted by _____ whose business address is _____ and, if applicable, its Federal Employer Identification Number (FEIN) is _____. If the entity has no FEIN, include the Social Security Number of the individual signing this sworn statement _____.
3. Name of individual signing this Sworn Statement is: _____, Whose relationship to the above entity is: _____.
4. The Trench Safety Standards that will be in effect during the construction of this project shall include, but are not limited to: Laws of Florida, Chapters 90-96, TRENCH SAFETY ACT, and OSHA RULES AND REGULATIONS 29 CFR 1926.650 Subpart P, effective October 1, 1990.
5. The undersigned assures that the entity will comply with the applicable Trench Safety Standards and agrees to indemnify and hold harmless the County and Engineer of Record, and any of their agents or employees from any claims arising from the failure to comply with said standard.

6. The undersigned has appropriated the following costs for compliance with the applicable standards:

| <u>Trench Safety Measure (Description)</u> | <u>Units of Measure Unit (LF, SY)</u> | <u>Quantity</u> | <u>Unit Cost</u> | <u>Extended Cost</u> |
|--|---------------------------------------|-----------------|------------------|----------------------|
| a. _____ | _____ | _____ | \$ _____ | _____ |
| b. _____ | _____ | _____ | \$ _____ | _____ |
| c. _____ | _____ | _____ | \$ _____ | _____ |
| d. _____ | _____ | _____ | \$ _____ | _____ |

7. The undersigned intends to comply with these standards by instituting the following procedures:

THE UNDERSIGNED, in submitting this bid, represents that they have reviewed and considered all available geotechnical information and made such other investigations and tests as they may deem necessary to adequately design the trench safety system(s) to be utilized on this project.

 (Authorized signature / Title)

SWORN to and subscribed before me this _____ day of _____, 20____.
(Impress official seal)

Notary Public, State of Florida: _____

My commission expires: _____



Angelina M. Colonnese

CLERK OF THE CIRCUIT COURT AND COMPTROLLER OF MANATEE COUNTY

1115 Manatee Avenue West, Bradenton, Florida 34205 - Phone (941) 749-1800 Fax (941) 741-4082, P.O. Box 25400, Bradenton, Florida 34206 - www.manateeclerk.com

Bidder must fully complete and return this form with its Bid.

APPENDIX E: ePAYABLES APPLICATION

Company name _____

Contact person _____

Phone number _____

Email Address _____

FINANCE USE ONLY

.....

Open orders: YES or NO

PEID _____

CREATE DATE _____

CONFIRMED WITH

Name and phone number

IFAS _____

BANK _____

INITIALS _____

Return completed form Via email to:

tina.mancini@manateeclerk.com

Via fax to: (941) 741-4011

Via mail:

PO Box 1000

Bradenton, FL 34206

Revised: September 30, 2015

“Pride in Service with a Vision to the Future”

Clerk of the Circuit Court – Clerk of Board of County Commissioners – County Comptroller – Auditor and Recorder

APPENDIX F, SCRUTINIZED COMPANY CERTIFICATION

This certification is required pursuant to Florida State Statute Section 287.135.

As of July 1, 2011, a company that, at the time of bidding or submitting a proposal for a new contract or renewal of an existing contract, is on the Scrutinized Companies with Activities in Sudan List or the Scrutinized Companies with Activities in the Iran Petroleum Energy Sector List is ineligible for, and may not bid on, submit a proposal for, or enter into or renew a contract with an agency or local governmental entity for goods or services of \$1 million or more.

Bidder must fully complete and return this form with its Bid.

Company _____ FID or EIN No. _____

Address _____

City _____ State _____ Zip _____

I, _____, as a representative of _____
certify and affirm that this company is not on the Scrutinized Companies with Activities in Sudan List or the Scrutinized Companies with Activities in the Iran Petroleum Energy Sector List.

Signature

Title

Printed Name

Date

APPENDIX G
MANATEE COUNTY, A POLITICAL SUBDIVISION OF THE STATE OF FLORIDA
INDEMNITY AND HOLD HARMLESS
 IFBC No. 21-TA003698JH

Bidder must fully complete and return this form with its Bid.

Bidder shall defend, indemnify and hold harmless the County and all of the County’s officers, agents, employees, and volunteers from and against all claims, liability, loss and expense, including reasonable costs, collection expenses, attorneys’ fees, and court costs which may arise because of the negligence (whether active or passive), misconduct, or other fault, in whole or in part (whether joint, concurrent, or contributing), of Respondent, its officers, employees, representatives and agents in performance or non-performance of its obligations under the Contract/Agreement. Bidder recognizes the broad nature of this indemnification and hold harmless clause, as well as the provision of a legal defense to the County when necessary, and voluntarily makes this covenant and expressly acknowledges the receipt of such good and valuable consideration provided by the County in support of these indemnification, legal defense and hold harmless contractual obligations in accordance with the laws of the State of Florida. This clause shall survive the termination of this Contract/Agreement. Compliance with any insurance requirements required elsewhere within this Contract/Agreement shall not relieve Bidder of its liability and obligation to defend, hold harmless and indemnify the County as set forth in this article of the Contract/Agreement.

Nothing herein shall be construed to extend the County’s liability beyond that provided in section 768.28, Florida Statutes.

| | |
|-----------------------------------|-------------|
| PROJECT NUMBER AND/OR NAME | |
| INSURANCE AGENT | |
| RESPONDENT SIGNATURE | DATE |

Acknowledgement:

STATE OF _____ COUNTY OF _____

The foregoing instrument was acknowledged before me this _____ day of _____,

20____ by _____ [FULL LEGAL NAME], who is

personally known to me / has produced _____ as
 identification.

Notary Signature _____

Print Name _____

APPENDIX H, INSURANCE STATEMENT

Bidder must fully complete and return this form with its Bid.

THE UNDERSIGNED has read and understands the insurance requirements of this IFBC applicable to any contract resulting from this solicitation and shall provide the insurances required by this Appendix within ten (10) days from the date of Notice of Intent to Award.

Bidder Name: _____ Date: _____

Signature
(Authorized
Official): _____

Printed Name/Title: _____

Insurance Agency: _____

Agent Name: _____ Agent Phone: _____

APPENDIX I, ACKNOWLEDGMENT OF ADDENDA

The undersigned acknowledges receipt of the following addenda:

| | |
|--------------------|----------------|
| Addendum No. _____ | Date Received: |
| Addendum No. _____ | Date Received: |
| Addendum No. _____ | Date Received: |
| Addendum No. _____ | Date Received: |
| Addendum No. _____ | Date Received: |
| Addendum No. _____ | Date Received: |
| Addendum No. _____ | Date Received: |
| Addendum No. _____ | Date Received: |
| Addendum No. _____ | Date Received: |
| Addendum No. _____ | Date Received: |

Print or type Bidder's information below:

| | |
|--|--|
| _____ | _____ |
| Name of Bidder | Telephone Number |
| _____ | _____ |
| Street Address | City/State/Zip |
| _____ | |
| Email Address | |
| _____ | _____ |
| Print Name & Title of Authorized Officer | Signature of Authorized Official Date |

APPENDIX J, AFFIDAVIT OF NO CONFLICT

COUNTY OF _____
STATE OF _____

BEFORE ME, the undersigned authority, this ____ day of _____, 20____ personally appeared, _____, a principal with full authority to bind _____ (hereinafter the "Affiant"), who being first duly sworn, deposes and says:

(a) is not currently engaged or will not become engaged in any obligations, undertakings or contracts that will require the Affiant to maintain an adversarial role against the County or that will impair or influence the advice, recommendations or quality of work provided to the County; and

(b) has provided full disclosure of all potentially conflicting contractual relationships and full disclosure of contractual relationships deemed to raise a question of conflict(s); and

(c) has provided full disclosure of prior work history and qualifications that may be deemed to raise possible question of conflict(s).

Affiant makes this affidavit for the purpose of inducing Manatee County, a political subdivision of the State of Florida, to enter into an Agreement for 26th Street west at 30th Avenue West Intersection Improvements.

If applicable, on a separate page Bidder shall disclose the name of any officer, director or agent of Bidder who is also an employee of the County and the name of any County employee who owns, directly or indirectly, any interest in the Bidder's firm or any of its branches. If no conflicts of interest are present, submit a statement to that affect.

Signature

Print Name

SUBSCRIBED to and sworn before me this ____ day of _____, 20__.

[Notary Seal]

Notary Public

My commission expires: _____

Notary Signature

Print Name

Personally known OR produced identification. Type of identification produced _____
_____.

APPENDIX K, BID PRICING FORM

IFBC No. 21-TA003698JH 26th street West at 30th Avenue West Intersection Improvements

Total Bid Price/Offer for Bid "A": \$ _____ Complete. Based on a completion time of 330 calendar days.

Total Bid Price/Offer for Bid "B": \$ _____ Complete. Based on a completion time of 400 calendar days.

We, the undersigned, hereby declare that we have carefully reviewed the IFBC Documents in their entirety and with full knowledge and understanding of the Bid information and all its requirements, submit this Bid, which is complete in meeting each specification, term, and condition contained therein.

As Bidder, we understand that the IFBC documents, including but not limited to, all specifications, terms, and conditions shall be made a part of any resulting Agreement between County and the successful Bidder. Failure by successful Bidder to comply with such specifications, terms and conditions shall result in Agreement default, whereupon, the defaulting successful Bidder shall be required to pay for all re-procurement costs, damages, and attorney fees as incurred by County, and agrees to forfeit its bid bond.

Authorized Signature(s): _____

**Name and Title of Above
Signer(s):** _____

Date: _____

APPENDIX K, BID PRICING FORM

IFBC No. 21-TA003698JH

26TH STREET WEST AT 30TH AVENUE WEST INTERSECTION IMPROVEMENTS

BID 'A' BASED ON 330 CALENDAR DAYS COMPLETION

Bidders must provide prices for each line item for their bid to be considered responsive

| PAY ITEM NO. | FDOT ITEM NUMBER | DESCRIPTION | TOTAL PROJECT QTY. | UNITS | BID PRICE PER UNIT (\$) | TOTAL BID PRICE (\$) |
|---|------------------|---|--------------------|-------|-------------------------|----------------------|
| I. ROADWAY & BRIDGE (TRANSPORTATION) | | | | | | |
| 1. | 101 1 | MOBILIZATION | 1.00 | LS | | \$0.00 |
| 2. | 102 1 | MAINTENANCE OF TRAFFIC (MOT) | 1.00 | LS | | \$0.00 |
| 3. | 102 71 13 | TEMPORARY BARRIER, F&I, LOW PROFILE, CONCRETE | 460.00 | LF | | \$0.00 |
| 4. | 104 10 3 | SEDIMENT BARRIER | 183.00 | LF | | \$0.00 |
| 5. | 104 18 | INLET PROTECTION SYSTEM | 9.00 | EA | | \$0.00 |
| 6. | 110 1 1 | CLEARING AND GRUBBING (0.86 AC) | 1.00 | LS | | \$0.00 |
| 7. | 110 4 10 | REMOVAL OF EXISTING CONCRETE | 285.00 | SY | | \$0.00 |
| 8. | 120 1 | REGULAR EXCAVATION | 400.00 | CY | | \$0.00 |
| 9. | 120 6 | EMBANKMENT | 75.00 | CY | | \$0.00 |
| 10. | 160 4 | TYPE B STABILIZATION | 900.00 | SY | | \$0.00 |
| 11. | 285 701 | OPTIONAL BASE (BASE GROUP 01) | 185.00 | SY | | \$0.00 |
| 12. | 285 704 | OPTIONAL BASE (BASE GROUP 04) | 75.00 | SY | | \$0.00 |
| 13. | 285 709 | OPTIONAL BASE (BASE GROUP 09) | 560.00 | SY | | \$0.00 |
| 14. | 327 70 6 | MILLING EXIST ASPH PAVT, 1 1/2" AVG DEPTH | 2,765.00 | SY | | \$0.00 |
| 15. | 334 1 13 | SUPERPAVE ASPHALTIC CONCRETE, TRAFFIC C | 49.50 | TN | | \$0.00 |
| 16. | 337 7 83 | ASPHALT FRICTION COURSE, TRAFFIC C, FC-12.5, PG 76-22 | 289.00 | TN | | \$0.00 |
| 17. | 425 1 521 | INLETS, DT BOT, TYPE C, < 10' | 2.00 | EA | | \$0.00 |
| 18. | 425 1 525 | INLETS, DT BOT, TYPE C, PARTIAL | 3.00 | EA | | \$0.00 |
| 19. | 425 1 555 | INLETS, DT BOT, TYPE E, PARTIAL | 1.00 | EA | | \$0.00 |
| 20. | 425 2 61 | MANHOLES, P-8, <10' | 1.00 | EA | | \$0.00 |
| 21. | 425 2 63 | MANHOLES, P-8, PARTIAL | 1.00 | EA | | \$0.00 |
| 22. | 425 6 | VALVE BOXES, ADJUST | 1.00 | EA | | \$0.00 |
| 23. | MC-202.2 | MANATEE COUNTY CURB INLET TYPE 202.2 | 1.00 | EA | | \$0.00 |
| 24. | 430 175 112 | PIPE CULVERT, OPTIONAL MATERIAL, ROUND, 12" S/CD | 15.00 | LF | | \$0.00 |
| 25. | 430 175 115 | PIPE CULVERT, OPTIONAL MATERIAL, ROUND, 15" S/CD | 28.00 | LF | | \$0.00 |
| 26. | 430 175 118 | PIPE CULVERT, OPTIONAL MATERIAL, ROUND, 18" S/CD | 4.00 | LF | | \$0.00 |
| 27. | 440 1 50 | UNDERDRAIN, TYPE V | 424.00 | LF | | \$0.00 |
| 28. | 440 73 2 | UNDERDRAIN OUTLET PIPE, 6" | 36.00 | LF | | \$0.00 |
| 29. | 515 1 2 | PIPE HANDRAIL - GUIDERAIL, ALUMINUM | 294.00 | LF | | \$0.00 |
| 30. | 520 1 10 | CONCRETE CURB & GUTTER, TYPE F | 442.00 | LF | | \$0.00 |
| 31. | 522 1 | CONCRETE SIDEWALK AND DRIVEWAYS, 4" THICK | 75.00 | SY | | \$0.00 |
| 32. | 522 2 | CONCRETE SIDEWALK AND DRIVEWAYS, 6" THICK | 178.00 | SY | | \$0.00 |
| 33. | 527 2 | DETECTABLE WARNINGS | 100.00 | SF | | \$0.00 |
| 34. | 570 1 2 | PERFORMANCE TURF, SOD | 2,000.00 | SY | | \$0.00 |
| SUBTOTAL (ROADWAY & BRIDGE) | | | | | | \$0.00 |

Bidder Name: _____

Authorized Signature: _____

| PAY ITEM NO. | FDOT ITEM NUMBER | DESCRIPTION | TOTAL PROJECT QTY. | UNITS | BID PRICE PER UNIT (\$) | TOTAL BID PRICE (\$) |
|--|------------------|---|--------------------|-------|-------------------------|----------------------|
| II. SIGNING AND PAVEMENT MARKING (TRANSPORTATION) | | | | | | |
| 35. | 700 1 11 | SINGLE POST SIGN, F&I GROUND MOUNT, UP TO 12 SF | 1.00 | AS | | \$0.00 |
| 36. | 700 1 50 | SINGLE POST SIGN, RELOCATE | 6.00 | AS | | \$0.00 |
| 37. | 700 1 74 | SINGLE POST SIGN, F&I CUSTOM, 31+ SF | 2.00 | AS | | \$0.00 |
| 38. | 700 3 101 | SIGN PANEL, F&I GROUND MOUNT, UP TO 12 SF | 3.00 | EA | | \$0.00 |
| 39. | 710 90 | PAINTED PAVEMENT MARKINGS, FINAL SURFACE | 1.00 | LS | | \$0.00 |
| 40. | 711 11 123 | THERMOPLASTIC, STANDARD, WHITE, SOLID, 12" FOR CROSSWALK AND ROUNDABOUT | 382.00 | LF | | \$0.00 |
| 41. | 711 11 125 | THERMOPLASTIC, STANDARD, WHITE, SOLID, 24" FOR STOP LINE AND CROSSWALK | 173.00 | LF | | \$0.00 |
| 42. | 711 11 160 | THERMOPLASTIC, STANDARD, WHITE, MESSAGE | 1.00 | EA | | \$0.00 |
| 43. | 711 11 170 | THERMOPLASTIC, STANDARD, WHITE, ARROW | 7.00 | EA | | \$0.00 |
| 44. | 711 11 224 | THERMOPLASTIC, STANDARD, YELLOW, SOLID, 18" FOR DIAGONAL OR CHEVRON | 87.00 | LF | | \$0.00 |
| 45. | 711 11 241 | THERMOPLASTIC, STANDARD, YELLOW, 2-4 DOTTED GUIDELINE/6-10 DOTTED EXTENSION, 6" | 0.019 | GM | | \$0.00 |
| 46. | 711 14 125 | THERMOPLASTIC, PREFORMED, WHITE, SOLID, 24" FOR CROSSWALK | 216.00 | LF | | \$0.00 |
| 47. | 711 16 101 | THERMOPLASTIC, STANDARD-OTHER SURFACES, WHITE, SOLID, 6" | 0.232 | GM | | \$0.00 |
| 48. | 711 16 131 | THERMOPLASTIC, OTHER SURFACES, WHITE, SKIP, 6", 10-30 SKIP OR 3-9 LANE DROP | 0.023 | GM | | \$0.00 |
| 49. | 711 16 201 | THERMOPLASTIC, STANDARD-OTHER SURFACES, YELLOW, SOLID, 6" | 0.316 | GM | | \$0.00 |
| SUBTOTAL (SIGNING AND PAVEMENT MARKING) | | | | | | \$0.00 |

Bidder Name: _____

Authorized Signature: _____

| PAY ITEM NO. | FDOT ITEM NUMBER | DESCRIPTION | TOTAL PROJECT QTY. | UNITS | BID PRICE PER UNIT (\$) | TOTAL BID PRICE (\$) |
|---|------------------|---|--------------------|-------|-------------------------|----------------------|
| III. SIGNALIZATION & LIGHTING (TRANSPORTATION) | | | | | | |
| 50. | 630 2 11 | CONDUIT, FURNISH & INSTALL, OPEN TRENCH | 120.00 | LF | | \$0.00 |
| 51. | 630 2 12 | CONDUIT, FURNISH & INSTALL, DIRECTIONAL BORE | 320.00 | LF | | \$0.00 |
| 52. | 632 7 1 | SIGNAL CABLE- NEW OR RECONSTRUCTED INTERSECTION, FURNISH & INSTALL | 1.00 | PI | | \$0.00 |
| 53. | 633 1 121 | FIBER OPTIC CABLE, F&I, UNDERGROUND,2-12 FIBERS | 155.00 | LF | | \$0.00 |
| 54. | 633 2 31 | FIBER OPTIC CONNECTION, INSTALL, SPLICE | 4.00 | EA | | \$0.00 |
| 55. | 633 3 12 | FIBER OPTIC CONNECTION HARDWARE, F&I, SPLICE TRAY | 1.00 | EA | | \$0.00 |
| 56. | 633 3 15 | FIBER OPTIC CONNECTION HARDWARE, F&I, PRETERMINATED PATCH PANEL | 1.00 | EA | | \$0.00 |
| 57. | 633 3 51 | FIBER OPTIC CONNECTION HARDWARE, MODIFY SPLICE ENCLOSURE | 1.00 | EA | | \$0.00 |
| 58. | 633 8 1 | MULTI-CONDUCTOR COMMUNICATION CABLE, F&I, MVDS & CCTV | 1,010.00 | LF | | \$0.00 |
| 59. | 635 2 11 | PULL & SPLICE BOX, F&I, 17" x 30" COVER SIZE | 15.00 | EA | | \$0.00 |
| 60. | 639 1 122 | ELECTRICAL POWER SERVICE, F&I, UNDERGROUND, METER PURCHASED BY CONTRACTOR | 1.00 | AS | | \$0.00 |
| 61. | 639 1 620 | ELECTRICAL POWER SERVICE, REMOVE COMPLETE SERVICE | 1.00 | AS | | \$0.00 |
| 62. | 639 2 1 | ELECTRICAL SERVICE WIRE, FURNISH & INSTALL | 100.00 | LF | | \$0.00 |
| 63. | 639 4 6 | EMERGENCY GENERATOR - PORTABLE, INSTALL HOUSING ONLY | 1.00 | EA | | \$0.00 |
| 64. | 641 2 12 | PRESTRESSED CONCRETE POLE, F&I, TYPE P-II SERVICE POLE | 1.00 | EA | | \$0.00 |
| 65. | 641 2 80 | PRESTRESSED CONCRETE POLE, COMPLETE POLE REMOVAL- POLE 30' AND GREATER | 4.00 | EA | | \$0.00 |
| 66. | 646 1 11 | ALUMINUM SIGNALS POLE, FURNISH & INSTALL PEDESTAL | 5.00 | EA | | \$0.00 |
| 67. | 649 21 13 | STEEL MAST ARM ASSEMBLY, FURNISH AND INSTALL, DOUBLE ARM 60-50' | 2.00 | EA | | \$0.00 |
| 68. | 650 1 14 | TRAFFIC SIGNAL, FURNISH & INSTALL ALUMINUM, 3 SECTION, 1 WAY | 10.00 | AS | | \$0.00 |
| 69. | 650 1 16 | TRAFFIC SIGNAL, FURNISH & INSTALL ALUMINUM, 4 SECTION, 1 WAY | 2.00 | AS | | \$0.00 |
| 70. | 650 1 19 | TRAFFIC SIGNAL, FURNISH & INSTALL ALUMINUM, 5 SECTION CLUSTER, 1 WAY | 3.00 | AS | | \$0.00 |
| 71. | 653 1 11 | PEDESTRIAN SIGNAL, FURNISH & INSTALL LED COUNTDOWN, 1 WAY | 4.00 | AS | | \$0.00 |
| 72. | 653 1 12 | PEDESTRIAN SIGNAL, FURNISH & INSTALL LED COUNTDOWN, 2 WAY | 1.00 | AS | | \$0.00 |
| 73. | 660 3 11 | VEHICLE DETECTION SYSTEM- MICROWAVE, FURNISH & INSTALL CABINET EQUIPMENT | 1.00 | EA | | \$0.00 |
| 74. | 660 3 12 | VEHICLE DETECTION SYSTEM- MICROWAVE, FURNISH & INSTALL, ABOVE GROUND EQUIPMENT | 6.00 | EA | | \$0.00 |
| 75. | 660 6 121 | VEHICLE DETECTION SYSTEM- AVI, BLUETOOTH, FURNISH & INSTALL, CABINET EQUIPMENT | 1.00 | EA | | \$0.00 |
| 76. | 660 6 122 | VEHICLE DETECTION SYSTEM- AVI, BLUETOOTH, FURNISH & INSTALL, ABOVE GROUND EQUIPMENT | 1.00 | EA | | \$0.00 |

Bidder Name: _____

Authorized Signature: _____

| PAY ITEM NO. | FDOT ITEM NUMBER | DESCRIPTION | TOTAL PROJECT QTY. | UNITS | BID PRICE PER UNIT (\$) | TOTAL BID PRICE (\$) |
|---|------------------|---|--------------------|-------|-------------------------|----------------------|
| 77. | 665 1 12 | PEDESTRIAN DETECTOR, FURNISH & INSTALL, ACCESSIBLE | 6.00 | EA | | \$0.00 |
| 78. | 670 5 111 | TRAFFIC CONTROLLER ASSEMBLY, F&I, NEMA, 1 PREEMPTION | 1.00 | AS | | \$0.00 |
| 79. | 670 5 600 | TRAFFIC CONTROLLER ASSEMBLY, REMOVE CONTROLLER WITH CABINET | 1.00 | AS | | \$0.00 |
| 80. | 682 1 113 | ITS CCTV CAMERA, F&I, DOME PTZ ENCLOSURE - PRESSURIZED, IP, HIGH DEFINITION | 1.00 | EA | | \$0.00 |
| 81. | 684 1 1 | MANAGED FIELD ETHERNET SWITCH, FURNISH & INSTALL | 1.00 | EA | | \$0.00 |
| 82. | 685 1 12 | UNINTERRUPTIBLE POWER SUPPLY, FURNISH AND INSTALL, ONLINE/DOUBLE CONVERSION | 1.00 | EA | | \$0.00 |
| 83. | 700 3 201 | SIGN PANEL, FURNISH & INSTALL OVERHEAD MOUNT, UP TO 12 SF | 8.00 | EA | | \$0.00 |
| 84. | 700 5 22 | INTERNALLY ILLUMINATED SIGN, FURNISH & INSTALL, OVERHEAD MOUNT, 12-18 SF | 6.00 | EA | | \$0.00 |
| 85. | 700 11 391 | ELECTRONIC DISPLAY SIGN, FURNISH & INSTALL OVERHEAD MOUNT - AC POWERED, BLANK OUT SIGN, UP TO 12 SF | 1.00 | AS | | \$0.00 |
| 86. | 715 1 12 | LIGHTING CONDUCTORS, F&I, INSULATED, NO. 8-6 | 1,075.00 | LF | | \$0.00 |
| 87. | 715 5 31 | LUMINAIRE & BRACKET ARM- ALUMINUM, F&I NEW LUMINAIRE AND ARM ON NEW/EXISTING POLE | 2.00 | EA | | \$0.00 |
| SUBTOTAL (SIGNALIZATION & LIGHTING) | | | | | | \$0.00 |
| TOTAL (SECTIONS I, II, III) | | | | | | \$0.00 |
| CONTRACT CONTINGENCY FOR SECTIONS I, II, III (USED ONLY WITH COUNTY APPROVAL) | | | | | 10% | \$0.00 |
| TRANSPORTATION CONSTRUCTION TOTAL | | | | | | \$0.00 |
| IV. POTABLE WATER (UTILITIES) | | | | | | |
| 88. | MC-1 | MOBILIZATION | 1.00 | LS | | \$0.00 |
| 89. | MC-2 | 4"-6" GATE VALVES (RESTRAINED JOINT) | 4.00 | EA | | \$0.00 |
| 90. | MC-3 | 4"-6" DUCTILE IRON PIPE (RESTRAINED JOINT), WATER | 189.00 | LF | | \$0.00 |
| 91. | MC-4 | 4"-6" DUCTILE IRON FITTINGS (RESTRAINED JOINT), WATER | 10.00 | EA | | \$0.00 |
| 92. | MC-5 | HYDRANT RELOCATION | 1.00 | EA | | \$0.00 |
| 93. | MC-6 | SODDING | 100.00 | SY | | \$0.00 |
| 94. | MC-7 | PAVEMENT REPAIR AND ROAD RESTORATION | 240.00 | SY | | \$0.00 |
| 95. | MC-8 | WATER SERVICE REPLACEMENTS | 2.00 | EA | | \$0.00 |
| 96. | MC-9 | 4" AC/DI ADAPTER | 2.00 | EA | | \$0.00 |
| 97. | MC-10 | SAMPLE POINT | 3.00 | EA | | \$0.00 |
| 98. | MC-11 | REMOVE 4" AC WATER MAIN | 165.00 | LF | | \$0.00 |
| 99. | MC-12 | REMOVE 6" PVC WATER MAIN | 55.00 | LF | | \$0.00 |
| 100. | MC-13 | RECORD DRAWINGS | 1.00 | LS | | \$0.00 |
| SUBTOTAL (POTABLE WATER) | | | | | | \$0.00 |
| CONTRACT CONTINGENCY FOR SECTION IV (USED ONLY WITH COUNTY APPROVAL) | | | | | 10% | \$0.00 |
| UTILITIES CONSTRUCTION TOTAL | | | | | | \$0.00 |
| TOTAL BID "A" SECTIONS I, II, III, IV (TRANSPORTATION AND UTILITIES) with Contract Contingency - Based on Completion Time of 330 Calendar Days | | | | | | \$0.00 |

Bidder Name: _____

Authorized Signature: _____

APPENDIX K, BID PRICING FORM

IFBC No. 21-TA003698JH

26TH STREET WEST AT 30TH AVENUE WEST INTERSECTION IMPROVEMENTS

BID 'B' BASED ON 400 CALENDAR DAYS COMPLETION

Bidders must provide prices for each line item for their bid to be considered responsive

| PAY ITEM NO. | FDOT ITEM NUMBER | DESCRIPTION | TOTAL PROJECT QTY. | UNITS | BID PRICE PER UNIT (\$) | TOTAL BID PRICE (\$) |
|---|------------------|---|--------------------|-------|-------------------------|----------------------|
| I. ROADWAY & BRIDGE (TRANSPORTATION) | | | | | | |
| 1. | 101 1 | MOBILIZATION | 1.00 | LS | | \$0.00 |
| 2. | 102 1 | MAINTENANCE OF TRAFFIC (MOT) | 1.00 | LS | | \$0.00 |
| 3. | 102 71 13 | TEMPORARY BARRIER, F&I, LOW PROFILE, CONCRETE | 460.00 | LF | | \$0.00 |
| 4. | 104 10 3 | SEDIMENT BARRIER | 183.00 | LF | | \$0.00 |
| 5. | 104 18 | INLET PROTECTION SYSTEM | 9.00 | EA | | \$0.00 |
| 6. | 110 1 1 | CLEARING AND GRUBBING (0.86 AC) | 1.00 | LS | | \$0.00 |
| 7. | 110 4 10 | REMOVAL OF EXISTING CONCRETE | 285.00 | SY | | \$0.00 |
| 8. | 120 1 | REGULAR EXCAVATION | 400.00 | CY | | \$0.00 |
| 9. | 120 6 | EMBANKMENT | 75.00 | CY | | \$0.00 |
| 10. | 160 4 | TYPE B STABILIZATION | 900.00 | SY | | \$0.00 |
| 11. | 285 701 | OPTIONAL BASE (BASE GROUP 01) | 185.00 | SY | | \$0.00 |
| 12. | 285 704 | OPTIONAL BASE (BASE GROUP 04) | 75.00 | SY | | \$0.00 |
| 13. | 285 709 | OPTIONAL BASE (BASE GROUP 09) | 560.00 | SY | | \$0.00 |
| 14. | 327 70 6 | MILLING EXIST ASPH PAVT, 1 1/2" AVG DEPTH | 2,765.00 | SY | | \$0.00 |
| 15. | 334 1 13 | SUPERPAVE ASPHALTIC CONCRETE, TRAFFIC C | 49.50 | TN | | \$0.00 |
| 16. | 337 7 83 | ASPHALT FRICTION COURSE, TRAFFIC C, FC-12.5, PG 76-22 | 289.00 | TN | | \$0.00 |
| 17. | 425 1 521 | INLETS, DT BOT, TYPE C, < 10' | 2.00 | EA | | \$0.00 |
| 18. | 425 1 525 | INLETS, DT BOT, TYPE C, PARTIAL | 3.00 | EA | | \$0.00 |
| 19. | 425 1 555 | INLETS, DT BOT, TYPE E, PARTIAL | 1.00 | EA | | \$0.00 |
| 20. | 425 2 61 | MANHOLES, P-8, <10' | 1.00 | EA | | \$0.00 |
| 21. | 425 2 63 | MANHOLES, P-8, PARTIAL | 1.00 | EA | | \$0.00 |
| 22. | 425 6 | VALVE BOXES, ADJUST | 1.00 | EA | | \$0.00 |
| 23. | MC-202.2 | MANATEE COUNTY CURB INLET TYPE 202.2 | 1.00 | EA | | \$0.00 |
| 24. | 430 175 112 | PIPE CULVERT, OPTIONAL MATERIAL, ROUND, 12" S/CD | 15.00 | LF | | \$0.00 |
| 25. | 430 175 115 | PIPE CULVERT, OPTIONAL MATERIAL, ROUND, 15" S/CD | 28.00 | LF | | \$0.00 |
| 26. | 430 175 118 | PIPE CULVERT, OPTIONAL MATERIAL, ROUND, 18" S/CD | 4.00 | LF | | \$0.00 |
| 27. | 440 1 50 | UNDERDRAIN, TYPE V | 424.00 | LF | | \$0.00 |
| 28. | 440 73 2 | UNDERDRAIN OUTLET PIPE, 6" | 36.00 | LF | | \$0.00 |
| 29. | 515 1 2 | PIPE HANDRAIL - GUIDERAIL, ALUMINUM | 294.00 | LF | | \$0.00 |
| 30. | 520 1 10 | CONCRETE CURB & GUTTER, TYPE F | 442.00 | LF | | \$0.00 |
| 31. | 522 1 | CONCRETE SIDEWALK AND DRIVEWAYS, 4" THICK | 75.00 | SY | | \$0.00 |
| 32. | 522 2 | CONCRETE SIDEWALK AND DRIVEWAYS, 6" THICK | 178.00 | SY | | \$0.00 |
| 33. | 527 2 | DETECTABLE WARNINGS | 100.00 | SF | | \$0.00 |
| 34. | 570 1 2 | PERFORMANCE TURF, SOD | 2,000.00 | SY | | \$0.00 |
| SUBTOTAL (ROADWAY & BRIDGE) | | | | | | \$0.00 |

Bidder Name: _____

Authorized Signature: _____

| PAY ITEM NO. | FDOT ITEM NUMBER | DESCRIPTION | TOTAL PROJECT QTY. | UNITS | BID PRICE PER UNIT (\$) | TOTAL BID PRICE (\$) |
|--|------------------|---|--------------------|-------|-------------------------|----------------------|
| II. SIGNING AND PAVEMENT MARKING (TRANSPORTATION) | | | | | | |
| 35. | 700 1 11 | SINGLE POST SIGN, F&I GROUND MOUNT, UP TO 12 SF | 1.00 | AS | | \$0.00 |
| 36. | 700 1 50 | SINGLE POST SIGN, RELOCATE | 6.00 | AS | | \$0.00 |
| 37. | 700 1 74 | SINGLE POST SIGN, F&I CUSTOM, 31+ SF | 2.00 | AS | | \$0.00 |
| 38. | 700 3 101 | SIGN PANEL, F&I GROUND MOUNT, UP TO 12 SF | 3.00 | EA | | \$0.00 |
| 39. | 710 90 | PAINTED PAVEMENT MARKINGS, FINAL SURFACE | 1.00 | LS | | \$0.00 |
| 40. | 711 11 123 | THERMOPLASTIC, STANDARD, WHITE, SOLID, 12" FOR CROSSWALK AND ROUNDABOUT | 382.00 | LF | | \$0.00 |
| 41. | 711 11 125 | THERMOPLASTIC, STANDARD, WHITE, SOLID, 24" FOR STOP LINE AND CROSSWALK | 173.00 | LF | | \$0.00 |
| 42. | 711 11 160 | THERMOPLASTIC, STANDARD, WHITE, MESSAGE | 1.00 | EA | | \$0.00 |
| 43. | 711 11 170 | THERMOPLASTIC, STANDARD, WHITE, ARROW | 7.00 | EA | | \$0.00 |
| 44. | 711 11 224 | THERMOPLASTIC, STANDARD, YELLOW, SOLID, 18" FOR DIAGONAL OR CHEVRON | 87.00 | LF | | \$0.00 |
| 45. | 711 11 241 | THERMOPLASTIC, STANDARD, YELLOW, 2-4 DOTTED GUIDELINE/6-10 DOTTED EXTENSION, 6" | 0.019 | GM | | \$0.00 |
| 46. | 711 14 125 | THERMOPLASTIC, PREFORMED, WHITE, SOLID, 24" FOR CROSSWALK | 216.00 | LF | | \$0.00 |
| 47. | 711 16 101 | THERMOPLASTIC, STANDARD-OTHER SURFACES, WHITE, SOLID, 6" | 0.232 | GM | | \$0.00 |
| 48. | 711 16 131 | THERMOPLASTIC, OTHER SURFACES, WHITE, SKIP, 6", 10-30 SKIP OR 3-9 LANE DROP | 0.023 | GM | | \$0.00 |
| 49. | 711 16 201 | THERMOPLASTIC, STANDARD-OTHER SURFACES, YELLOW, SOLID, 6" | 0.316 | GM | | \$0.00 |
| SUBTOTAL (SIGNING AND PAVEMENT MARKING) | | | | | | \$0.00 |

Bidder Name: _____

Authorized Signature: _____

| PAY ITEM NO. | FDOT ITEM NUMBER | DESCRIPTION | TOTAL PROJECT QTY. | UNITS | BID PRICE PER UNIT (\$) | TOTAL BID PRICE (\$) |
|---|------------------|---|--------------------|-------|-------------------------|----------------------|
| III. SIGNALIZATION & LIGHTING (TRANSPORTATION) | | | | | | |
| 50. | 630 2 11 | CONDUIT, FURNISH & INSTALL, OPEN TRENCH | 120.00 | LF | | \$0.00 |
| 51. | 630 2 12 | CONDUIT, FURNISH & INSTALL, DIRECTIONAL BORE | 320.00 | LF | | \$0.00 |
| 52. | 632 7 1 | SIGNAL CABLE- NEW OR RECONSTRUCTED INTERSECTION, FURNISH & INSTALL | 1.00 | PI | | \$0.00 |
| 53. | 633 1 121 | FIBER OPTIC CABLE, F&I, UNDERGROUND,2-12 FIBERS | 155.00 | LF | | \$0.00 |
| 54. | 633 2 31 | FIBER OPTIC CONNECTION, INSTALL, SPLICE | 4.00 | EA | | \$0.00 |
| 55. | 633 3 12 | FIBER OPTIC CONNECTION HARDWARE, F&I, SPLICE TRAY | 1.00 | EA | | \$0.00 |
| 56. | 633 3 15 | FIBER OPTIC CONNECTION HARDWARE, F&I, PRETERMINATED PATCH PANEL | 1.00 | EA | | \$0.00 |
| 57. | 633 3 51 | FIBER OPTIC CONNECTION HARDWARE, MODIFY SPLICE ENCLOSURE | 1.00 | EA | | \$0.00 |
| 58. | 633 8 1 | MULTI-CONDUCTOR COMMUNICATION CABLE, F&I, MVDS & CCTV | 1,010.00 | LF | | \$0.00 |
| 59. | 635 2 11 | PULL & SPLICE BOX, F&I, 17" x 30" COVER SIZE | 15.00 | EA | | \$0.00 |
| 60. | 639 1 122 | ELECTRICAL POWER SERVICE, F&I, UNDERGROUND, METER PURCHASED BY CONTRACTOR | 1.00 | AS | | \$0.00 |
| 61. | 639 1 620 | ELECTRICAL POWER SERVICE, REMOVE COMPLETE SERVICE | 1.00 | AS | | \$0.00 |
| 62. | 639 2 1 | ELECTRICAL SERVICE WIRE, FURNISH & INSTALL | 100.00 | LF | | \$0.00 |
| 63. | 639 4 6 | EMERGENCY GENERATOR - PORTABLE, INSTALL HOUSING ONLY | 1.00 | EA | | \$0.00 |
| 64. | 641 2 12 | PRESTRESSED CONCRETE POLE, F&I, TYPE P-II SERVICE POLE | 1.00 | EA | | \$0.00 |
| 65. | 641 2 80 | PRESTRESSED CONCRETE POLE, COMPLETE POLE REMOVAL- POLE 30' AND GREATER | 4.00 | EA | | \$0.00 |
| 66. | 646 1 11 | ALUMINUM SIGNALS POLE, FURNISH & INSTALL PEDESTAL | 5.00 | EA | | \$0.00 |
| 67. | 649 21 13 | STEEL MAST ARM ASSEMBLY, FURNISH AND INSTALL, DOUBLE ARM 60-50' | 2.00 | EA | | \$0.00 |
| 68. | 650 1 14 | TRAFFIC SIGNAL, FURNISH & INSTALL ALUMINUM, 3 SECTION, 1 WAY | 10.00 | AS | | \$0.00 |
| 69. | 650 1 16 | TRAFFIC SIGNAL, FURNISH & INSTALL ALUMINUM, 4 SECTION, 1 WAY | 2.00 | AS | | \$0.00 |
| 70. | 650 1 19 | TRAFFIC SIGNAL, FURNISH & INSTALL ALUMINUM, 5 SECTION CLUSTER, 1 WAY | 3.00 | AS | | \$0.00 |
| 71. | 653 1 11 | PEDESTRIAN SIGNAL, FURNISH & INSTALL LED COUNTDOWN, 1 WAY | 4.00 | AS | | \$0.00 |
| 72. | 653 1 12 | PEDESTRIAN SIGNAL, FURNISH & INSTALL LED COUNTDOWN, 2 WAY | 1.00 | AS | | \$0.00 |
| 73. | 660 3 11 | VEHICLE DETECTION SYSTEM- MICROWAVE, FURNISH & INSTALL CABINET EQUIPMENT | 1.00 | EA | | \$0.00 |
| 74. | 660 3 12 | VEHICLE DETECTION SYSTEM- MICROWAVE, FURNISH & INSTALL, ABOVE GROUND EQUIPMENT | 6.00 | EA | | \$0.00 |
| 75. | 660 6 121 | VEHICLE DETECTION SYSTEM- AVI, BLUETOOTH, FURNISH & INSTALL, CABINET EQUIPMENT | 1.00 | EA | | \$0.00 |
| 76. | 660 6 122 | VEHICLE DETECTION SYSTEM- AVI, BLUETOOTH, FURNISH & INSTALL, ABOVE GROUND EQUIPMENT | 1.00 | EA | | \$0.00 |

Bidder Name: _____

Authorized Signature: _____

| PAY ITEM NO. | FDOT ITEM NUMBER | DESCRIPTION | TOTAL PROJECT QTY. | UNITS | BID PRICE PER UNIT (\$) | TOTAL BID PRICE (\$) |
|---|------------------|---|--------------------|-------|-------------------------|----------------------|
| 77. | 665 1 12 | PEDESTRIAN DETECTOR, FURNISH & INSTALL, ACCESSIBLE | 6.00 | EA | | \$0.00 |
| 78. | 670 5 111 | TRAFFIC CONTROLLER ASSEMBLY, F&I, NEMA, 1 PREEMPTION | 1.00 | AS | | \$0.00 |
| 79. | 670 5 600 | TRAFFIC CONTROLLER ASSEMBLY, REMOVE CONTROLLER WITH CABINET | 1.00 | AS | | \$0.00 |
| 80. | 682 1 113 | ITS CCTV CAMERA, F&I, DOME PTZ ENCLOSURE - PRESSURIZED, IP, HIGH DEFINITION | 1.00 | EA | | \$0.00 |
| 81. | 684 1 1 | MANAGED FIELD ETHERNET SWITCH, FURNISH & INSTALL | 1.00 | EA | | \$0.00 |
| 82. | 685 1 12 | UNINTERRUPTIBLE POWER SUPPLY, FURNISH AND INSTALL, ONLINE/DOUBLE CONVERSION | 1.00 | EA | | \$0.00 |
| 83. | 700 3 201 | SIGN PANEL, FURNISH & INSTALL OVERHEAD MOUNT, UP TO 12 SF | 8.00 | EA | | \$0.00 |
| 84. | 700 5 22 | INTERNALLY ILLUMINATED SIGN, FURNISH & INSTALL, OVERHEAD MOUNT, 12-18 SF | 6.00 | EA | | \$0.00 |
| 85. | 700 11 391 | ELECTRONIC DISPLAY SIGN, FURNISH & INSTALL OVERHEAD MOUNT - AC POWERED, BLANK OUT SIGN, UP TO 12 SF | 1.00 | AS | | \$0.00 |
| 86. | 715 1 12 | LIGHTING CONDUCTORS, F&I, INSULATED, NO. 8-6 | 1,075.00 | LF | | \$0.00 |
| 87. | 715 5 31 | LUMINAIRE & BRACKET ARM- ALUMINUM, F&I NEW LUMINAIRE AND ARM ON NEW/EXISTING POLE | 2.00 | EA | | \$0.00 |
| SUBTOTAL (SIGNALIZATION & LIGHTING) | | | | | | \$0.00 |
| TOTAL (SECTIONS I, II, III) | | | | | | \$0.00 |
| CONTRACT CONTINGENCY FOR SECTIONS I, II, III (USED ONLY WITH COUNTY APPROVAL) | | | | | 10% | \$0.00 |
| TRANSPORTATION CONSTRUCTION TOTAL | | | | | | \$0.00 |
| IV. POTABLE WATER (UTILITIES) | | | | | | |
| 88. | MC-1 | MOBILIZATION | 1.00 | LS | | \$0.00 |
| 89. | MC-2 | 4"-6" GATE VALVES (RESTRAINED JOINT) | 4.00 | EA | | \$0.00 |
| 90. | MC-3 | 4"-6" DUCTILE IRON PIPE (RESTRAINED JOINT), WATER | 189.00 | LF | | \$0.00 |
| 91. | MC-4 | 4"-6" DUCTILE IRON FITTINGS (RESTRAINED JOINT), WATER | 10.00 | EA | | \$0.00 |
| 92. | MC-5 | HYDRANT RELOCATION | 1.00 | EA | | \$0.00 |
| 93. | MC-6 | SODDING | 100.00 | SY | | \$0.00 |
| 94. | MC-7 | PAVEMENT REPAIR AND ROAD RESTORATION | 240.00 | SY | | \$0.00 |
| 95. | MC-8 | WATER SERVICE REPLACEMENTS | 2.00 | EA | | \$0.00 |
| 96. | MC-9 | 4" AC/DI ADAPTER | 2.00 | EA | | \$0.00 |
| 97. | MC-10 | SAMPLE POINT | 3.00 | EA | | \$0.00 |
| 98. | MC-11 | REMOVE 4" AC WATER MAIN | 165.00 | LF | | \$0.00 |
| 99. | MC-12 | REMOVE 6" PVC WATER MAIN | 55.00 | LF | | \$0.00 |
| 100. | MC-13 | RECORD DRAWINGS | 1.00 | LS | | \$0.00 |
| SUBTOTAL (POTABLE WATER) | | | | | | \$0.00 |
| CONTRACT CONTINGENCY FOR SECTION IV (USED ONLY WITH COUNTY APPROVAL) | | | | | 10% | \$0.00 |
| UTILITIES CONSTRUCTION TOTAL | | | | | | \$0.00 |
| TOTAL BID "B" SECTIONS I, II, III, IV (TRANSPORTATION AND UTILITIES) with Contract Contingency - Based on Completion Time of 400 Calendar Days | | | | | | \$0.00 |

Bidder Name: _____

Authorized Signature: _____

SECTION C, BID ATTACHMENTS

BID ATTACHMENT 1, INSURANCE AND BOND REQUIREMENTS

The CONTRACTOR will not commence work under the resulting Agreement until all insurance coverages indicated by an "X" herein have been obtained. The CONTRACTOR shall obtain and submit to the Procurement Division within ten (10) calendar days from the date of notice of intent to award, at its expense, the following minimum amounts of insurance (inclusive of any amounts provided by an umbrella or excess policy): Work under this Agreement cannot commence until all insurance coverages indicated herein have been obtained on a standard ACORD form (inclusive of any amounts provided by an umbrella or excess policy):

Automobile Liability Insurance Required Limits

Coverage must be afforded under a per occurrence policy form including coverage for all owned, hired and non-owned vehicles for bodily injury and property damage of not less than:

- \$1,000,000 Combined Single Limit; OR
- \$ 500,000 Bodily Injury and \$500,000 Property Damage
- \$10,000 Personal Injury Protection (No Fault)
- \$500,000 Hired, Non-Owned Liability
- \$10,000 Medical Payments

This policy shall contain severability of interests' provisions.

Commercial General Liability Insurance Required Limits (per Occurrence form only; claims-made form is not acceptable)

Coverage shall be afforded under a per occurrence policy form, policy shall be endorsed and name 'Manatee County, a political subdivision of the State of Florida' as an Additional Insured, and include limits not less than:

- \$1,000,000 Single Limit Per Occurrence
- \$2,000,000 Aggregate
- \$1,000,000 Products/Completed Operations Aggregate
- \$1,000,000 Personal and Advertising Injury Liability
- \$50,000 Fire Damage Liability
- \$10,000 Medical Expense, and
- \$1,000,000, Third Party Property Damage
- \$ Project Specific Aggregate (Required on projects valued at over \$10,000,000)

This policy shall contain severability of interests' provisions.

Employer's Liability Insurance

Coverage limits of not less than:

- \$100,000 Each Accident
- \$500,000 Disease Each Employee
- \$500,000 Disease Policy Limit

- Worker’s Compensation Insurance**
- US Longshoremen & Harbor Workers Act**
- Jones Act Coverage**

Coverage limits of not less than:

- Statutory workers’ compensation coverage shall apply for all employees in compliance with the laws and statutes of the State of Florida and the federal government.
- If any operations are to be undertaken on or about navigable waters, coverage must be included for the US Longshoremen & Harbor Workers Act and Jones Act.

Should ‘leased employees’ be retained for any part of the project or service, the employee leasing agency shall provide evidence of Workers’ Compensation coverage and Employer’s Liability coverage for all personnel on the worksite and in compliance with the above Workers’ Compensation requirements. NOTE: Workers’ Compensation coverage is a firm requirement. Elective exemptions are considered on a case-by-case basis and are approved in a very limited number of instances.

Aircraft Liability Insurance Required Limits

Coverage shall be afforded under a per occurrence policy form, policy shall be endorsed and name ‘Manatee County a political subdivision of the State of Florida’ as an Additional Insured, and include limits not less than:

- \$ Each Occurrence Property and Bodily Injury with no less than \$100,000 per passenger each occurrence or a ‘smooth’ limit.
- \$ General Aggregate.

Un-Manned Aircraft Liability Insurance (Drone)

Coverage shall be afforded under a per occurrence policy form, policy shall be endorsed and name ‘Manatee County a political subdivision of the State of Florida’ as an Additional Insured, and include limits not less than:

- \$ Each Occurrence Property and Bodily Injury; Coverage shall specifically include operation of Unmanned Aircraft Systems (UAS), including liability and property damage.
- \$ General Aggregate

Installation Floater Insurance

When the contract or agreement **does not** include construction of, or additions to, above ground building or structures, but does involve the installation of machinery or equipment, Installation Floater Insurance shall be afforded under a per occurrence policy form, policy shall be endorsed and name “Manatee County, a political subdivision of the State of Florida” as an Additional Insured, and include limits not less than:

- 100% of the completed value of such addition(s), building(s), or structure(s)

Professional Liability and/or Errors and Omissions (E&O) Liability Insurances

Coverage shall be afforded under either an occurrence policy form or a claims-made policy form. If the coverage form is on a claims-made basis, then coverage must be maintained for a minimum of three years from termination of date of the contract. Limits must not be less than:

- \$ 1,000,000 Bodily Injury and Property Damage Each Occurrence
- \$ 2,000,000 General Aggregate

Builder's Risk Insurance

When the contract or agreement includes the construction of roadways and/or the addition of a permanent structure or building, including the installation of machinery and/or equipment, Builder's Risk Insurance shall be afforded under a per occurrence policy form, policy shall be endorsed and name "Manatee County, a political subdivision of the State of Florida" as an Additional Insured, and include limits not less than:

- An amount equal to 100% of the completed value of the project, or the value of the equipment to be installed
- The policy shall not carry a self-insured retention/deductible greater than \$10,000

Coverage shall be for all risks and include, but not be limited to, storage and transport of materials, equipment, supplies of any kind whatsoever to be used on or incidental to the project, theft coverage, and Waiver of Occupancy Clause Endorsement, where applicable.

Cyber Liability Insurance

Coverage shall comply with Florida Statute 501.171, shall be afforded under a per occurrence policy form, policy shall be endorsed and name 'Manatee County, a political subdivision of the State of Florida' as an Additional Insured, and include limits not less than:

- \$ Security Breach Liability
- \$ Security Breach Expense Each Occurrence
- \$ Security Breach Expense Aggregate
- \$ Replacement or Restoration of Electronic Data
- \$ Extortion Threats
- \$ Business Income and Extra Expense
- \$ Public Relations Expense

NOTE: Policy must not carry a self-insured retention/deductible greater than \$25,000.

Hazardous Materials Insurance (As Noted Below)

Hazardous materials include all materials and substances that are currently designated or defined as hazardous by the law or rules of regulation by the State of Florida or federal government.

All coverage shall be afforded under either an occurrence policy form or a claims-made policy form, and the policy shall be endorsed and name 'Manatee County, a political subdivision of the State of Florida' as an Additional Insured. If the coverage form is on a claims-made basis, then coverage must be maintained for a minimum of three years from termination of date of the contract. Limits must not be less than:

Pollution Liability

Amount equal to the value of the contract, subject to a \$1,000,000 minimum, for Bodily Injury and Property Damage to include sudden and gradual release, each claim and aggregate.

Asbestos Liability (If handling within scope of Contract)

Amount equal to the value of the contract, subject to a \$1,000,000 minimum, for Bodily Injury and Property Damage to include sudden and gradual release, each claim and aggregate.

Disposal

When applicable, CONTRACTOR shall designate the disposal site and furnish a Certificate of Insurance from the disposal facility for Environmental Impairment Liability Insurance covering liability.

- Amount equal to the value of the contract, subject to a \$1,000,000 minimum, for Liability for Sudden and Accidental Occurrences, each claim and an aggregate.
- Amount equal to the value of the contract, subject to a \$1,000,000 minimum, for Liability for Non-Sudden and Accidental Occurrences, each claim and an aggregate.

Hazardous Waste Transportation Insurance

CONTRACTOR shall designate the hauler and have the hauler furnish a Certificate of Insurance for Automobile Liability insurance with Endorsement MCS-90 for liability arising out of the transportation of hazardous materials. EPA identification number shall be provided.

All coverage shall be afforded under either an occurrence policy form or a claims-made policy form and the policy shall be endorsed and name "Manatee County, a political subdivision of the State of Florida" as an Additional Insured. If the coverage form is on a claims-made basis, then coverage must be maintained for a minimum of three years from termination of date of the contract. Limits must not be less than:

- Amount equal to the value of the contract, subject to a \$1,000,000 minimum, per accident.

Liquor Liability Insurance

Coverage shall be afforded under a per occurrence policy form, policy shall be endorsed and name "Manatee County, a political subdivision of the State of Florida" as an Additional Insured, and include limits not less than:

- \$1,000,000 Each Occurrence and Aggregate

Garage Keeper’s Liability Insurance

Coverage shall be required if the maintenance, servicing, cleaning or repairing of any County motor vehicles is inherent or implied within the provision of the contract.

Coverage shall be afforded under a per occurrence policy form, policy shall be endorsed and name “Manatee County, a political subdivision of the State of Florida” as an Additional Insured, and include limits not less than:

- Property and asset coverage in the full replacement value of the lot or garage.

Bailee’s Customer Liability Insurance

Coverage shall be required for damage and/or destruction when County property is temporarily under the care or custody of a person or organization, including property that is on, or in transit to and from the person or organization’s premises. Perils covered should include fire, lightning, theft, burglary, robbery, explosion, collision, flood, earthquake and damage or destruction during transportation by a carrier.

Coverage shall be afforded under a per occurrence policy form, policy shall be endorsed and name “Manatee County, a political subdivision of the State of Florida” as an Additional Insured, and include limits not less than:

- Property and asset coverage in the full replacement value of the County asset(s) in the CONTRACTOR’S care, custody and control.

Hull and Watercraft Liability Insurance

Coverage shall be afforded under a per occurrence policy form, policy shall be endorsed and name “Manatee County, a political subdivision of the State of Florida” as an Additional Insured, and include limits not less than:

- \$ Each Occurrence
- \$ General Aggregate
- \$ Fire Damage Liability
- \$10,000 Medical Expense, and
- \$ Third Party Property Damage
- \$ Project Specific Aggregate (Required on projects valued at over \$10,000,000)

Other [Specify]

BOND REQUIREMENTS

Bid Bond

A Bid Bond in the amount of \$_____ or _5% of the total offer. Bid bond shall be submitted with the sealed response and shall include project name, location, and / or address and project number. In lieu of the bond, the bidder may file an alternative form of security in the amount of \$_____ or ___5_% of the total offer. in the form of a money order, a certified check, a cashier's check, or an irrevocable letter of credit issued to Manatee County. NOTE: A construction project over \$200,000 requires a Bid Bond in the amount of 5% of the total bid offer.

Payment and Performance Bond

A Payment and Performance Bond shall be submitted by Successful Bidder for 100% of the award amount and shall be presented to Manatee County within ten (10) calendar days of issuance of the notice of intent to award. NOTE: A construction project over \$200,000 requires a Payment and Performance Bond.

INSURANCE REQUIREMENTS

I. THE POLICIES BELOW ARE TO CONTAIN, OR BE ENDORSED TO CONTAIN, THE FOLLOWING PROVISIONS:

1. Commercial General Liability and Automobile Liability Coverages

- a. **“Manatee County, a Political Subdivision of the State of Florida,” is to be named as an Additional Insured in respect to:** Liability arising out of activities performed by or on behalf of the successful Bidder, his agents, representatives, and employees; products and completed operations of the successful Bidder; or automobiles owned, leased, hired or borrowed by the successful Bidder. The coverage shall contain no special limitation(s) on the scope of protection afforded to the County, its officials, employees or volunteers.

In addition to furnishing a Certificate of Insurance, the successful Bidder shall provide the endorsement that evidences Manatee County being listed as an Additional Insured. This can be done in one of two ways: (1) an endorsement can be issued that specifically lists “Manatee County, a Political Subdivision of the State of Florida,” as Additional Insured; or, (2) an endorsement can be issued that states that all Certificate Holders are Additional Insured with respect to the policy.

- b. The successful Bidder's insurance coverage shall be primary insurance with respect to the County, its officials, employees and volunteers. Any insurance or self-insurance maintained by the County, its officials, employees or volunteers shall be excess of successful Bidder's insurance and shall be non-contributory.
- c. The insurance policies must be on an occurrence form.

2. Workers' Compensation and Employers' Liability Coverages

The insurer shall agree to waive all rights of subrogation against the County, its officials, employees and volunteers for losses arising from work performed by the successful Bidder for the County.

II. GENERAL INSURANCE PROVISIONS APPLICABLE TO ALL POLICIES:

1. Prior to the execution of contract, or issuance of a Purchase Order, and then annually upon the anniversary date(s) of the insurance policy's renewal date(s) for as long as this contract remains in effect, successful Bidder shall furnish the County with a Certificate(s) of Insurance (using an industry accepted certificate form, signed by the Issuer, with applicable endorsements, and containing the solicitation or contract number, and title or description) evidencing the coverage set forth above and naming “Manatee County, a Political Subdivision of the State of Florida” as an Additional Insured on the applicable coverage(s) set forth above.
2. If the policy contains an aggregate limit, confirmation is needed in writing (letter, email, etc.) that the aggregate limit has not been eroded to procurement representative when supplying Certificate of Insurance.

In addition, when requested in writing from the County, successful Bidder will provide the County with a certified copy of all applicable policies. The address where such certificates and certified policies shall be sent or delivered is as follows:

Manatee County, a Political Subdivision of the State of Florida
Attn: Risk Management Division
1112 Manatee Avenue West, Suite 969
Bradenton, FL 34205

3. The project's solicitation number and title shall be listed on each certificate.
 4. successful Bidder shall provide thirty (30) days written notice to the Risk Manager of any cancellation, non-renewal, termination, material change, or reduction in coverage of any insurance policies to procurement representative including solicitation number and title with all notices.
 5. successful Bidder agrees that should at any time successful Bidder fail to meet or maintain the required insurance coverage(s) as set forth herein, the County may terminate this contract.
 6. The successful Bidder waives all subrogation rights against Manatee County, a Political Subdivision of the State of Florida, for all losses or damages which occur during the contract and for any events occurring during the contract period, whether the suit is brought during the contract period or not.
 7. The successful Bidder has sole responsibility for all insurance premiums and policy deductibles.
 8. It is the successful Bidder's responsibility to ensure that his agents, representatives and subcontractors comply with the insurance requirements set forth herein. successful Bidder shall include his agents, representatives, and subcontractors working on the project or at the worksite as insured under its policies, or successful Bidder shall furnish separate certificates and endorsements for each agent, representative, and subcontractor working on the project or at the worksite. All coverages for agents, representatives, and subcontractors shall be subject to all of the requirements set forth to the procurement representative.
 9. All required insurance policies must be written with a carrier having a minimum A.M. Best rating of A- FSC VII or better. In addition, the County has the right to review the successful Bidder's deductible or self-insured retention and to require that it be reduced or eliminated.
- III. Successful Bidder understands and agrees that the stipulated limits of coverage listed herein in this insurance section shall not be construed as a limitation of any potential liability to the County, or to others, and the County's failure to request evidence of this insurance coverage shall not be construed as a waiver of successful Bidder's obligation to provide and maintain the insurance coverage specified.
- IV. The enclosed Hold Harmless Agreement shall be signed by the successful Bidder and shall become a part of the contract.

- V.** Successful Bidder understands and agrees that the County does not waive its immunity, and nothing herein shall be interpreted as a waiver of the County's rights, including the limitation of waiver of immunity, as set forth in Florida Statutes 768.28, or any other statutes, and the County expressly reserves these rights to the full extent allowed by law.

- VI.** No award shall be made until the Procurement Division has received the Certificate of Insurance and Hold Harmless Agreement in accordance with this section.

[Remainder of page intentionally left blank]

BID ATTACHMENT 2, CONTRACT DOCUMENTS

CONTRACT DOCUMENTS

FOR

30th Avenue and 26th Street
UTILITY RELOCATION

PROJECT # 6092460

NOVEMBER 2020

PROJECT OWNER:

County of Manatee, Florida
c/o Manatee County Procurement Division
1112 Manatee Avenue West
Bradenton, Florida 34205
(941) 748-3014

PREPARED BY:

Engineering Division
Manatee County Public Works Department
1022 26th Avenue East
Bradenton, Florida 34208
(941) 708-7450

AMENDED BY:

HDR
2601 Cattlemen Road, Suite 400
Sarasota, Florida 34232
(941) 342-2700

INFRASTRUCTURE ENGINEERING STANDARD SPECIFICATIONS

| | | |
|----------------|--|-----|
| SECTION 01005 | GENERAL REQUIREMENTS | 5 |
| SECTION 01010 | SUMMARY OF WORK | 16 |
| SECTION 01015 | CONTROL OF WORK | 18 |
| SECTION 01030 | SPECIAL PROJECT PROCEDURES | 22 |
| SECTION 01045 | CUTTING AND PATCHING | 26 |
| SECTION 01050 | FIELD ENGINEERING AND SURVEYING | 28 |
| SECTION 01090 | REFERENCE STANDARDS | 29 |
| SECTION 01150 | MEASUREMENT AND PAYMENT | 32 |
| SECTION 01152 | REQUESTS FOR PAYMENT | 38 |
| SECTION 01153 | CHANGE ORDER PROCEDURES | 39 |
| SECTION 01200 | PROJECT MEETINGS | 42 |
| SECTION 01310 | CONSTRUCTION SCHEDULE & PROJECT RESTRAINTS | 44 |
| SECTION 01340 | SHOP DRAWINGS, PROJECT DATA AND SAMPLES | 49 |
| SECTION 01370 | SCHEDULE OF VALUES | 55 |
| SECTION 01380 | CONSTRUCTION PHOTOGRAPHS | 56 |
| SECTION 01410 | TESTING AND TESTING LABORATORY SERVICES | 58 |
| SECTION 01510 | TEMPORARY AND PERMANENT UTILITIES | 60 |
| SECTION 01570 | TRAFFIC REGULATION | 62 |
| SECTION 01580 | PROJECT IDENTIFICATION AND SIGNS | 64 |
| SECTION 01590 | COUNTY'S FIELD OFFICE | 67 |
| SECTION 01600 | MATERIAL AND EQUIPMENT | 69 |
| SECTION 01620 | STORAGE AND PROTECTION | 71 |
| SECTION 01700 | CONTRACT CLOSEOUT | 73 |
| SECTION 01710 | CLEANING | 76 |
| SECTION 01720 | PROJECT RECORD DOCUMENTS | 78 |
| SECTION 01730 | OPERATING AND MAINTENANCE DATA | 81 |
| SECTION 01740 | WARRANTIES AND BONDS | 84 |
| DIVISION 2 | SITE WORK | 86 |
| SECTION 02064 | MODIFICATIONS TO EXISTING STRUCTURES, PIPING AND EQUIPMENT | 86 |
| SECTION 02100 | SITE PREPARATION | 91 |
| SECTION 02220 | EXCAVATION, BACKFILL, FILL AND GRADING FOR STRUCTURES | 93 |
| SECTION 02221 | TRENCHING, BEDDING AND BACKFILL FOR PIPE | 97 |
| SECTION 02223 | EXCAVATION BELOW GRADE AND CRUSHED STONE OR SHELL REFILL | 103 |
| SECTION 02260 | FINISH GRADING | 104 |
| SECTION 02276 | TEMPORARY EROSION AND SEDIMENTATION CONTROL | 106 |
| SECTION 02325 | ROAD AND RAILROAD CROSSINGS | 108 |
| SECTION 02355 | LUMBER LEFT IN PLACE | 111 |
| SECTION 02444 | FENCING | 112 |
| SECTION 02480 | LANDSCAPING | 119 |
| SECTION 02485 | SEEDING AND SODDING | 124 |
| SECTION 02513 | ASPHALT CONCRETE PAVING | 127 |
| SECTION 02575 | PAVEMENT REPAIR AND RESTORATION | 136 |
| SECTION 02590 | WATER SERVICES ON PRIVATE PROPERTY | 139 |
| SECTION 02614 | STEEL PIPE AND FITTINGS | 143 |
| SECTION 02615 | DUCTILE IRON PIPE AND FITTINGS | 149 |
| SECTION 02616 | DISINFECTING POTABLE WATER PIPE LINES | 152 |
| SECTION 02617 | INSTALLATION AND TESTING OF PRESSURE PIPE | 154 |
| SECTION 02618 | PIPELINE CLEANING | 158 |
| SECTION 02619 | HORIZONTAL DIRECTIONAL DRILLING | 161 |
| SECTION 02619A | PIPE BURSTING OF GRAVITY SANITARY SEWER MAINS | 171 |
| SECTION 02620 | POLYETHYLENE (HDPE) PIPE AND FITTING | 176 |

| | | |
|----------------|---|-----|
| SECTION 02622 | POLYVINYL CHLORIDE (PVC) PIPE AND FITTINGS (AWWA SPECIFICATIONS C-900 & C-905) | 178 |
| SECTION 02623 | POLYVINYL CHLORIDE (PVC) PIPE (GRAVITY SEWER) | 181 |
| SECTION 02625 | FIBERGLASS MANHOLES | 190 |
| SECTION 02626 | SANITARY SEWER GRAVITY MAIN REHABILITATION | 197 |
| SECTION 02627 | SANITARY SEWER MANHOLE REHABILITATION | 209 |
| SECTION 02628 | SANITARY SEWER MANHOLE AND WET WELL FIBERGLASS LINERS | 216 |
| SECTION 02640 | VALVES AND APPURTENANCES | 220 |
| SECTION 02720 | SANITARY SEWER BYPASS PUMPING | 235 |
| DIVISION 3 | CONCRETE | 238 |
| SECTION 03200 | CONCRETE REINFORCEMENT | 238 |
| SECTION 03300 | CAST-IN-PLACE CONCRETE | 241 |
| SECTION 03350 | CONCRETE FINISHES | 246 |
| SECTION 03410 | PRECAST CONCRETE STRUCTURES | 249 |
| SECTION 03500 | LIFT STATION SPECIFICATION | 257 |
| DIVISION 4 | MASONRY | 275 |
| SECTION 04220 | MASONRY | 275 |
| DIVISION 5 | METALS | 281 |
| SECTION 05500 | MISCELLANEOUS METAL | 281 |
| SECTION 05550 | AIR RELEASE ENCLOSURE | 287 |
| SECTION 05600 | METAL BUILDINGS | 290 |
| DIVISION 6 | WOOD AND PLASTIC | 291 |
| SECTION 06100 | ROUGH CARPENTRY | 291 |
| SECTION 06200 | FINISH CARPENTRY | 293 |
| SECTION 06600 | FIBERGLASS REINFORCED POLYMER (FRP) PRODUCTS AND FABRICATIONS | 296 |
| SECTION 06900 | WEIRS, BAFFLES AND SUPPORTS | 301 |
| DIVISION 7 | THERMAL AND MOISTURE PROTECTION | 303 |
| SECTION 07100 | WATERPROOFING, DAMPPROOFING AND CAULKING | 303 |
| DIVISION 8 | DOORS AND WINDOWS | 306 |
| SECTION 08100 | METAL DOORS AND FRAMES | 306 |
| SECTION 08200 | FIBERGLASS REINFORCED PLASTIC DOORS AND FRAMES | 309 |
| SECTION 08331 | OVERHEAD DOORS | 313 |
| DIVISION 9 | PAINTING | 317 |
| SECTION 09150 | CEMENT PLASTER (STUCCO) | 317 |
| SECTION 09865 | SURFACE PREPARATION AND SHOP PRIME PAINTING | 320 |
| SECTION 09900 | PAINTING | 322 |
| SECTION 09901 | ROOF COATING AND MEMBRANE SYSTEM - NOXYDE | 347 |
| SECTION 09970 | SURFACE PROTECTION SPRAY SYSTEM | 354 |
| DIVISION 10 | SPECIALTIES | 361 |
| SECTION 10520 | FIRE EXTINGUISHERS | 361 |
| DIVISION 11 | EQUIPMENT | 362 |
| SECTION 11210 | VERTICAL TURBINE PUMPS | 362 |
| SECTION 11215 | DIESEL BACKUP PUMP | 367 |
| SECTION 11225 | STATIC MIXERS | 377 |
| DIVISION 13 | SPECIAL CONSTRUCTION | 381 |
| SECTION 13350 | LIFT STATION REHABILITATION | 381 |
| SECTION 13350A | WET WELL CLEANING | 384 |
| DIVISION 14 | CONVEYING SYSTEMS | 386 |
| SECTION 14600 | HOISTS AND CRANES | 386 |
| DIVISION 15 | MECHANICAL | 389 |
| SECTION 15094 | PIPE HANGERS AND SUPPORTS | 389 |
| SECTION 15400 | PLUMBING | 395 |

| | | |
|----------------|----------------------------------|-----|
| SECTION 15500 | AIR CONDITIONING SYSTEM | 404 |
| SECTION 15600 | FUEL PIPING | 409 |
| DIVISION 16 | ELECTRICAL | 412 |
| SECTION 16050 | ELECTRICAL - GENERAL PROVISIONS | 412 |
| SECTION 16108 | MISCELLANEOUS EQUIPMENT | 417 |
| SECTION 16110 | CONDUITS AND FITTINGS | 420 |
| SECTION 16120 | WIRES AND CABLES | 424 |
| SECTION 16150 | MOTORS | 428 |
| SECTION 16152 | INVERTER DUTY MOTORS | 433 |
| SECTION 16160 | PANELBOARDS | 438 |
| SECTION 16231 | EMERGENCY GENERATOR SET | 441 |
| SECTION 16231A | PORTABLE EMERGENCY GENERATOR SET | 455 |
| SECTION 16370 | VARIABLE FREQUENCY DRIVES | 470 |
| SECTION 16450 | GROUNDING | 477 |
| SECTION 16921 | 480 VOLT MOTOR CONTROL CENTER | 480 |

This specification includes by reference the Manatee County Public Works Standards, Part I Utilities Standards Manual approved February 2020.

All items and/or materials furnished and installed shall conform to the Manatee County Approved Products List. All items listed in the submittal requirements under each section shall be required to be submitted for review and/or acceptance.

DIVISION 1 GENERAL REQUIREMENTS

SECTION 01005 GENERAL REQUIREMENTS

PART 1 GENERAL

1.01 SCOPE AND INTENT

A. Description

The work to be done consists of the furnishing of all labor, materials and equipment, and the performance of all work included in this Contract.

B. Work Included

The Contractor shall furnish all labor, superintendence, materials, plant, power, light, heat, fuel, water, tools, appliances, equipment, supplies, shop drawings, working drawings and other means of construction necessary or proper for performing and completing the work. He shall obtain and pay for all required permits necessary for the work, other than those permits such as the DEP permit and railroad permit, which may have already been obtained. He shall perform and complete the work in the manner best calculated to promote rapid construction consistent with safety of life and property and to the satisfaction of the County, and in strict accordance with the Contract Documents. The Contractor shall clean up the work and maintain it during and after construction, until accepted, and shall do all work and pay all incidental costs. He shall repair or restore all structures and property that may be damaged or disturbed during performance of the work.

The cost of incidental work described in these General Requirements, for which there are no specific Contract Items, shall be considered as part of the general cost of doing the work and shall be included in the prices for the various Contract Items. No additional payment will be made.

The Contractor shall be solely responsible for the adequacy of his workmanship, materials and equipment.

C. Public Utility Installations and Structures

Public utility installations and structures shall be understood to include all poles, tracks, pipes, wires, conduits, house service connections, vaults, manholes and all other appurtenances and facilities pertaining thereto.

The Contractor shall protect all installations and structures from damage during the work. Access across any buried public utility installation or structure shall be made only in such locations and by means approved by the County. All required protective devices and construction shall be provided by the Contractor at his expense. All existing public utilities damaged by the Contractor, which are shown on the Plans or have been located in the field by the utility, shall be repaired by the Contractor, at his expense, as approved by the County. No separate payment shall be made for such protection or repairs to public utility installations or structures.

Public utility installations or structures owned or controlled by the County or other governmental body, which are required by this contract to be removed, relocated, replaced

or rebuilt by the Contractor not identified in any separate bid item shall be considered as a part of the general cost of doing the work and shall be included in the prices bid for the various contract items. No separate payment shall be made.

Where public utility installations or structures owned or controlled by the County or other governmental body are encountered during the course of the work, and are not indicated on the Plans or in the Specifications, and when, in the opinion of the County, removal, relocation, replacement or rebuilding is necessary to complete the work under this Contract, such work shall be accomplished by the utility having jurisdiction, or such work may be ordered, in writing by the County, for the contractor to accomplish. If such work is accomplished by the utility having jurisdiction, it will be carried out expeditiously and the Contractor shall give full cooperation to permit the utility to complete the removal, relocation, replacement or rebuilding as required. If such work is accomplished by the Contractor, it will be in accordance with the General and Supplemental General Conditions.

The Contractor shall give written notice to County and other governmental utility departments and other owners of public utilities of the location of his proposed construction operations, at least forty-eight hours in advance of breaking ground in any area or on any unit of the work. This can be accomplished by making the appropriate contact with the "Sunshine State One-Call of Florida, Inc. Call Center ("Call Sunshine") and per all requirements provided for in the Florida Underground Facilities Damage Prevention and Safety Act (Florida Statutes, Title XXXIII, Chapter 556).

The maintenance, repair, removal, relocation or rebuilding of public utility installations and structures, when accomplished by the Contractor as herein provided, shall be done by methods approved by the County.

1.02 PLANS AND SPECIFICATIONS

A. Plans

When obtaining data and information from the Plans, figures shall be used in preference to scaled dimensions, and large-scale drawings in preference to small-scale drawings.

B. Copies Furnished to Contractor

The Contractor shall furnish each of the subcontractors, manufacturers, and material men such copies of the Contract Documents as may be required for their work. Additional copies of the Plans and Specifications, when requested, may be furnished to the Contractor at cost of reproduction.

C. Supplementary Drawings

When, in the opinion of the County, it becomes necessary to explain more fully the work to be done or to illustrate the work further or to show any changes which may be required, drawings known as Supplementary Drawings, with specifications pertaining thereto, will be prepared by the County and five paper prints thereof will be given to the Contractor.

D. Contractor to Check Plans and Data

The Contractor shall verify all dimensions, quantities and details shown on the Plans, Supplementary Drawings, Schedules, Specifications or other data received from the County, and shall notify him of all errors, omissions, conflicts, and discrepancies found

therein. Failure to discover or correct errors, conflicts or discrepancies shall not relieve the Contractor of full responsibility for unsatisfactory work, faulty construction or improper operation resulting therefrom nor from rectifying such conditions at his own expense. He will not be allowed to take advantage of any errors or omissions, as full instructions will be furnished by the County, should such errors or omissions be discovered. All schedules are given for the convenience of the County and the Contractor and are not guaranteed to be complete. The Contractor shall assume all responsibility for the making of estimates of the size, kind, and quality of materials and equipment included in work to be done under the Contract.

E. Specifications

The Technical Specifications consist of three parts: General, Products and Execution. The General Section contains General Requirements which govern the work. Products and Execution modify and supplement these by detailed requirements for the work and shall always govern whenever there appears to be a conflict.

F. Intent

All work called for in the Specifications applicable to this Contract, but not shown on the Plans in their present form, or vice versa, shall be of like effect as if shown or mentioned in both. Work not specified in either the Plans or in the Specifications, but involved in carrying out their intent or in the complete and proper execution of the work, is required and shall be performed by the Contractor as though it were specifically delineated or described.

The apparent silence of the Specifications as to any detail, or the apparent omission from them of a detailed description concerning any work to be done and materials to be furnished, shall be regarded as meaning that only the best general practice is to prevail and that only material and workmanship of the best quality is to be used, and interpretation of these Specifications shall be made upon that basis.

The inclusion of the Related Requirements (or work specified elsewhere) in the General part of the specifications is only for the convenience of the Contractor, and shall not be interpreted as a complete list of related Specification Sections.

1.03 MATERIALS AND EQUIPMENT

A. Manufacturer

All transactions with the manufacturers or subcontractors shall be through the Contractor, unless the Contractor shall request, in writing to the County, that the manufacturer or subcontractor deal directly with the County. Any such transactions shall not in any way release the Contractor from his full responsibility under this Contract.

Any two or more pieces or material or equipment of the same kind, type or classification, and being used for identical types of services, shall be made by the same manufacturer.

B. Delivery

The Contractor shall deliver materials in ample quantities to insure the most speedy and uninterrupted progress of the work so as to complete the work within the allotted time. The Contractor shall also coordinate deliveries in order to avoid delay in, or impediment of, the progress of the work of any related Contractor.

C. Tools and Accessories

The Contractor shall, unless otherwise stated in the Contract Documents, furnish with each type, kind or size of equipment, one complete set of suitably marked high grade special tools and appliances which may be needed to adjust, operate, maintain or repair the equipment. Such tools and appliances shall be furnished in approved painted steel cases, properly labeled and equipped with good grade cylinder locks and duplicate keys.

Spare parts shall be furnished as specified.

Each piece of equipment shall be provided with a substantial nameplate, securely fastened in place and clearly inscribed with the manufacturer's name, year of manufacture, serial number, weight and principal rating data.

D. Installation of Equipment.

The Contractor shall have on hand sufficient proper equipment and machinery of ample capacity to facilitate the work and to handle all emergencies normally encountered in work of this character.

Equipment shall be erected in a neat and workmanlike manner on the foundations at the locations and elevations shown on the Plans, unless directed otherwise by the County during installation. All equipment shall be correctly aligned, leveled and adjusted for satisfactory operation and shall be installed so that proper and necessary connections can be made readily between the various units.

The Contractor shall furnish, install and protect all necessary anchor and attachment bolts and all other appurtenances needed for the installation of the devices included in the equipment specified. Anchor bolts shall be as approved by the County and made of ample size and strength for the purpose intended. Substantial templates and working drawings for installation shall be furnished.

The Contractor shall furnish all materials and labor for, and shall properly bed in non-shrink grout, each piece of equipment on its supporting base that rests on masonry foundations.

Grout shall completely fill the space between the equipment base and the foundation. All metal surfaces coming in contact with concrete or grout shall receive a coat of coal tar epoxy equal to Koppers 300M or provide a 1/32-inch neoprene gasket between the metal surface and the concrete or grout.

E. Service of Manufacturer's Engineer

The Contract prices for equipment shall include the cost of furnishing (as required by equipment specifications sections) a competent and experienced engineer or superintendent who shall represent the manufacturer and shall assist the Contractor, when required, to install, adjust, test and place in operation the equipment in conformity with the Contract Documents. After the equipment is placed in permanent operation by the County, such engineer or superintendent shall make all adjustments and tests required by the County to prove that such equipment is in proper and satisfactory operating condition, and shall instruct such personnel as may be designated by the County in the proper operation and maintenance of such equipment.

1.04 INSPECTION AND TESTING

A. General

Inspection and testing of materials will be performed by the County unless otherwise specified.

For tests specified to be made by the Contractor, the testing personnel shall make the necessary inspections and tests and the reports thereof shall be in such form as will facilitate checking to determine compliance with the Contract Documents. Three (3) copies of the reports shall be submitted and authoritative certification thereof must be furnished to the County as a prerequisite for the acceptance of any material or equipment.

If, in the making of any test of any material or equipment, it is ascertained by the County that the material or equipment does not comply with the Contract, the Contractor will be notified thereof and he will be directed to refrain from delivering said material or equipment, or to remove it promptly from the site or from the work and replace it with acceptable material, without cost to the County.

Tests of electrical and mechanical equipment and appliances shall be conducted in accordance with recognized test codes of the ANSI, ASME, or the IEEE, except as may otherwise be stated herein.

The Contractor shall be fully responsible for the proper operation of equipment during tests and instruction periods and shall neither have nor make any claim for damage which may occur to equipment prior to the time when the County formally takes over the operation thereof.

B. Costs

All inspection and testing of materials furnished under this Contract will be performed by the County or duly authorized inspection engineers or inspections bureaus without cost to the Contractor, unless otherwise expressly specified.

The cost of shop and field tests of equipment and of certain other tests specifically called for in the Contract Documents shall be borne by the Contractor and such costs shall be deemed to be included in the Contract price.

Materials and equipment submitted by the Contractor as the equivalent to those specifically named in the Contract may be tested by the County for compliance. The Contractor shall reimburse the County for the expenditures incurred in making such tests on materials and equipment which are rejected for non-compliance.

C. Inspections of Materials

The Contractor shall give notice in writing to the County, at least two weeks in advance of his intention to commence the manufacture or preparation of materials especially manufactured or prepared for use in or as part of the permanent construction. Such notice shall contain a request for inspection, the date of commencement and the expected date of completion of the manufacture or preparation of materials. Upon receipt of such notice, the County will arrange to have a representative present at such times during the manufacture as may be necessary to inspect the materials or he will notify the Contractor that the inspection will be made at a point other than the point of manufacture, or he will notify the

Contractor that inspection will be waived. The Contractor must comply with these provisions before shipping any material. Such inspection shall not release the Contractor from the responsibility for furnishing materials meeting the requirements of the Contract Documents.

D. Certificate of Manufacture

When inspection is waived or when the County so requires, the Contractor shall furnish to him authoritative evidence in the form of Certificates of Manufacture that the materials to be used in the work have been manufactured and tested in conformity with the Contract Documents. These certificates shall be notarized and shall include copies of the results of physical tests and chemical analyses, where necessary, that have been made directly on the product or on similar products of the manufacturer.

E. Shop Tests of Operating Equipment

Each piece of equipment for which pressure, duty, capacity, rating, efficiency, performance, function or special requirements are specified shall be tested in the shop of the maker in a manner which shall conclusively prove that its characteristics comply fully with the requirements of the Contract Documents. No such equipment shall be shipped to the work until the County notifies the Contractor, in writing, that the results of such tests are acceptable.

The cost of shop tests and of furnishing manufacturer's preliminary and shop test data of operating equipment shall be borne by the Contractor.

F. Preliminary Field Tests

As soon as conditions permit, the Contractor shall furnish all labor, materials, and instruments and shall make preliminary field tests of equipment. If the preliminary field tests disclose any equipment furnished under this Contract which does not comply with the requirements of the Contract Documents, the Contractor shall, prior to the acceptance tests, make all changes, adjustments and replacements required. The furnishing Contractor shall assist in the preliminary field tests as applicable.

G. Final Field Tests

Upon completion of the work and prior to final payment, all equipment and piping installed under this Contract shall be subjected to acceptance tests as specified or required to prove compliance with the Contract Documents.

The Contractor shall furnish labor, fuel, energy, water and all other materials, equipment and instruments necessary for all acceptance tests, at no additional cost to the County. The Supplier shall assist in the final field tests as applicable.

H. Failure of Tests

Any defects in the materials and equipment or their failure to meet the tests, guarantees or requirements of the Contract Documents shall be promptly corrected by the Contractor. The decision of the County as to whether or not the Contractor has fulfilled his obligations under the Contract shall be final and conclusive. If the Contractor fails to make these corrections or if the improved materials and equipment, when tested, shall again fail to meet the guarantees of specified requirements, the County, notwithstanding its partial payment for

work, and materials and equipment, may reject the materials and equipment and may order the Contractor to remove them from the site at his own expense.

In case the County rejects any materials and equipment, then the Contractor shall replace the rejected materials and equipment within a reasonable time. If he fails to do so, the County may, after the expiration of a period of thirty (30) calendar days after giving him notice in writing, proceed to replace such rejected materials and equipment, and the cost thereof shall be deducted from any compensation due or which may become due the Contractor under his Contract.

I. Final Inspection

During such final inspections, the work shall be clean and free from water. In no case will the final pay application be prepared until the Contractor has complied with all requirements set forth and the County has made his final inspection of the entire work and is satisfied that the entire work is properly and satisfactorily constructed in accordance with the requirements of the Contract Document.

1.05 TEMPORARY STRUCTURES

A. Temporary Fences

If, during the course of the work, it is necessary to remove or disturb any fence or part thereof, the Contractor shall, at his own expense, if so ordered by the County, provide a suitable temporary fence which shall be maintained until the permanent fence is replaced. The County shall be solely responsible for the determination of the necessity for providing a temporary fence and the type of temporary fence to be used.

1.06 TEMPORARY SERVICES

A. First Aid

The Contractor shall keep upon the site, at each location where work is in progress, a completely equipped first aid kit and shall provide ready access thereto at all times when people are employed on the work.

1.07 LINES AND GRADES

A. Grade

All work under this Contract shall be constructed in accordance with the lines and grades shown on the Plans, or as given by the County. The full responsibility for keeping alignment and grade shall rest upon the Contractor.

B. Safeguarding Marks

The Contractor shall safeguard all points, stakes, grade marks, monuments and bench marks made or established on the work, bear the cost of reestablishing them if disturbed, and bear the entire expense of rectifying work improperly installed due to not maintaining or protecting or removing without authorization such established points, stakes and marks.

The Contractor shall safeguard all existing and known property corners, monuments and marks adjacent to but not related to the work and, if required, shall bear the cost of reestablishing them if disturbed or destroyed.

C. Datum Plane

All elevations indicated or specified refer to the Mean Sea Level Datum of the NAVD 1988 and/or NGVD 1929.

1.08 ADJACENT STRUCTURES AND LANDSCAPING

A. Responsibility

The Contractor shall also be entirely responsible and liable for all damage or injury as a result of his operations to all other adjacent public and private property, structures of any kind and appurtenances thereto met with during the progress of the work. The cost of protection, replacement in their original locations and conditions or payment of damages for injuries to such adjacent public and private property and structures affected by the work, whether or not shown on the Plans, and the removal, relocation and reconstruction of such items called for on the Plans or specified shall be included in the various Contract Items and no separate payments will be made therefore. Where such public and private property, structures of any kind and appurtenances thereto are not shown on the Plans and when, in the opinion of the County, additional work is deemed necessary to avoid interference with the work, payment therefore will be made as provided for in the General Conditions.

Contractor is expressly advised that the protection of buildings, structures, tunnels, tanks, pipelines, etc. and related work adjacent and in the vicinity of his operations, wherever they may be, is solely his responsibility. Conditional inspection of buildings or structures in the immediate vicinity of the project which may reasonably be expected to be affected by the Work shall be performed by and be the responsibility of the Contractor.

Contractor shall, before starting operations, make an examination of the interior and exterior of the adjacent structures, buildings, facilities, etc., and record by notes, measurements, photographs, etc., conditions which might be aggravated by open excavation and construction. Repairs or replacement of all conditions disturbed by the construction shall be made to the satisfaction of the County. This does not preclude conforming to the requirements of the insurance underwriters. Copies of surveys, photographs, reports, etc., shall be given to the County.

Prior to the beginning of any excavations, the Contractor shall advise the County of all buildings or structures on which he intends to perform work or which performance of the project work will affect.

B. Protection of Trees

1. All trees and shrubs shall be adequately protected by the Contractor with boxes and otherwise and in accordance with ordinances governing the protection of trees. No excavated materials shall be placed so as to injure such trees or shrubs. Trees or shrubs destroyed by negligence of the Contractor or his employees shall be replaced by him with new stock of similar size and age, at the proper season and at the sole expense of the Contractor.

2. Beneath trees or other surface structures, where possible, pipelines may be built in short tunnels, backfilled with excavated materials, except as otherwise specified, or the trees or structures carefully supported and protected from damage.
3. The County may order the Contractor, for the convenience of the County, to remove trees along the line or trench excavation. If so ordered, the County will obtain any permits required for removal of trees. Such tree removal ordered shall be paid for under the appropriate Contract Items.

C. Lawn Areas

Lawn areas shall be left in as good condition as before the starting of the work. Where sod is to be removed, it shall be carefully removed, and later replaced, or the area where sod has been removed shall be restored with new sod.

D. Restoration of Fences

Any fence, or part thereof, that is damaged or removed during the course of the work shall be replaced or repaired by the Contractor and shall be left in as good a condition as before the starting of the work. The manner in which the fence is repaired or replaced and the materials used in such work shall be subject to the approval of the County. The cost of all labor, materials, equipment, and work for the replacement or repair of any fence shall be deemed included in the appropriate Contract Item or items, or if no specific Item is provided therefore, as part of the overhead cost of the work, and no additional payment will be made therefore.

1.09 PROTECTION OF WORK AND PUBLIC

A. Barriers and Lights

During the prosecution of the work, the Contractor shall put up and maintain at all times such barriers and lights as will effectually prevent accidents. The Contractor shall provide suitable barricades, red lights, "danger" or "caution" or "street closed" signs and watchmen at all places where the work causes obstructions to the normal traffic or constitutes in any way a hazard to the public, in accordance with state and local requirements.

B. Smoke Prevention

A strict compliance with ordinances regulating the production and emission of smoke will be required. No open fires will be permitted.

C. Noise

The Contractor shall eliminate noise to as great an extent as practicable at all times. Air compressing plants shall be equipped with silencers and the exhaust of all engines or other power equipment shall be provided with mufflers. In the vicinity of hospitals and schools, special care shall be used to avoid noise or other nuisances. The Contractor shall strictly observe all local regulations and ordinances covering noise control.

D. Access to Public Services

Neither the materials excavated nor the materials or plant used in the construction of the work shall be so placed as to prevent free access to all fire hydrants, valves or manholes.

E. Dust prevention

The Contractor shall prevent dust nuisance from his operations or from traffic by keeping the roads and/or construction areas sprinkled with water at all times.

1.10 CUTTING AND PATCHING

The Contractor shall do all cutting, fitting or patching of his portion of the work that may be required to make the several parts thereof join and coordinate in a manner satisfactory to the County and in accordance with the Plans and Specifications. The work must be done by competent workmen skilled in the trade required by the restoration.

1.11 CLEANING

A. During Construction

During construction of the work, the Contractor shall, at all times, keep the site of the work and adjacent premises as free from material, debris and rubbish as is practicable and shall remove the same from any portion of the site if, in the opinion of the County, such material, debris, or rubbish constitutes a nuisance or is objectionable. The Contractor shall remove from the site all of his surplus materials and temporary structures when no further need therefore develops.

B. Final Cleaning

At the conclusion of the work, all equipment, tools, temporary structures and materials belonging to the Contractor shall be promptly taken away, and he shall remove and promptly dispose of all water, dirt, rubbish or any other foreign substances.

The Contractor shall thoroughly clean all equipment and materials installed by him and shall deliver such materials and equipment undamaged in a bright, clean, polished and new operating condition.

1.12 MISCELLANEOUS

A. Protection Against Siltation and Bank Erosion

1. The Contractor shall arrange his operations to minimize siltation and bank erosion on construction sites and on existing or proposed water courses and drainage ditches.
2. The Contractor, at his own expense, shall remove any siltation deposits and correct any erosion problems as directed by the County which results from his construction operations.

B. Protection of Wetland Areas

The Contractor shall properly dispose of all surplus material, including soil, in accordance with Local, State and Federal regulations. Under no circumstances shall surplus material be disposed of in wetland areas as defined by the Florida Department of Environmental Protection or Southwest Florida Water Management District.

C. Existing Facilities

The work shall be so conducted to maintain existing facilities in operation insofar as is possible. Requirements and schedules of operations for maintaining existing facilities in service during construction shall be as described in the Special Provisions.

D. Use of Chemicals

All chemicals used during project construction or furnished for project operation, whether herbicide, pesticide, disinfectant, polymer, reactant, or of other classification, must show approval of either EPA or USDA. Use of all such chemicals and disposal of residues shall be in strict conformance with instructions.

PART 2 PRODUCTS (NOT USED)

PART 3 EXECUTION (NOT USED)

END OF SECTION

SECTION 01010 SUMMARY OF WORK

PART 1 GENERAL

1.01 WORK COVERED BY CONTRACT DOCUMENTS/REQUIREMENTS INCLUDED

- A. Construction of the potable water main and appurtenance are as part of the roadway along 30th Avenue and 26th Street. The work included in this contract consists of the following:
 - 1. Construct approximately 118 linear feet (LF) of 4-inch ductile iron water main, valves, air release valves, fittings, and appurtenances (restrained joint) and tie-to existing 4-inch AC water main,
 - 2. Relocate existing fire hydrant assembly and tie to new 6-inch ductile iron water main,
 - 3. Construct approximately 71 LF of 6-inch ductile iron water main, valves, fittings, and appurtenances (restrained joint) and tie-to existing 6-inch PVC water main,
 - 4. Remove approximately 55 LF of existing 6" PVC water main and appurtenances, and
 - 5. Remove approximately 165 LF of existing 4" AC water main and appurtenances.
- B. The Contractor shall furnish all shop drawings, working drawings, labor, materials, equipment, tools, services and incidentals necessary to complete all work required by these Specifications and as shown on the Contract Drawings.
- C. The Contractor shall perform the work complete, in place and ready for continuous service and shall include any repairs, replacements, and/or restoration required as a result of damages caused prior to acceptance by the County.
- D. The Contractor shall furnish and install all materials, equipment and labor which is reasonably and properly inferable and necessary for the proper completion of the work, whether specifically indicated in the Contract Documents or not.

1.02 CONTRACTS

Construct all the Work under a single contract.

1.03 WORK SEQUENCE

- A. All work done under this Contract shall be done with a minimum of inconvenience to the users of the system or facility. The Contractor shall coordinate his work with private property owners such that existing utility services are maintained to all users to the maximum extent possible.
- B. The Contractor shall, if necessary and feasible, construct the work in stages to accommodate the County's use of the premises during the construction period; coordinate the construction schedule and operations with the County's Representative.
- C. The Contractor shall, where feasible, construct the Work in stages to provide for public convenience and not close off public use of any facility until completion of construction to provide alternative usage.

1.04 CONSTRUCTION AREAS

- A. The Contractor shall: Limit his use of the construction areas for work and for storage, to allow for:

1. Work by other Contractors.
2. County's Use.
3. Public Use.

- B. Coordinate use of work site under direction of County's Representative.
- C. Assume full responsibility for the protection and safekeeping of products under this Contract, stored on the site.
- D. Move any stored products under the Contractor's control, which interfere with operations of the County or separate contractor.
- E. Obtain and pay for the use of additional storage of work areas needed for Contractor operations.

1.05 COUNTY OCCUPANCY

- A. It is assumed that portions of the Work will be completed prior to completion of the entire Work. Upon completion of construction of each individual facility, including testing, if the County, at its sole discretion, desires to accept the individual facility, the Contractor will be issued a dated certificate of completion and acceptance for each individual facility. The County will assume ownership and begin operation of the individual facility on that date and the three-year guaranty period shall commence on that date. The County has the option of not accepting the entire work as a whole until it is completed, tested and approved by the County.

1.06 PARTIAL COUNTY OCCUPANCY

The Contractor shall schedule his operations for completion of portions of the Work, as designated, for the County's occupancy prior to substantial completion of the entire work.

PART 2 PRODUCTS (NOT USED)

PART 3 EXECUTION (NOT USED)

END OF SECTION

SECTION 01015 CONTROL OF WORK

PART 1 GENERAL

1.01 WORK PROGRESS

The Contractor shall furnish personnel and equipment which will be efficient, appropriate and adequately sized to secure a satisfactory quality of work and a rate of progress which will insure the completion of the work within the time stipulated in the Contract. If at any time such personnel appears to the County to be inefficient, inappropriate, or insufficient for securing the quality of work required for producing the rate of progress aforesaid, he may order the Contractor to increase the efficiency, change the character, or increase the personnel and equipment and the Contractor shall conform to such order. Failure of the County to give such order shall in no way relieve the Contractor of his obligations to secure the quality of the work and rate of progress required.

1.02 PRIVATE LAND

The Contractor shall not enter or occupy private land outside of easements, except by permission of the affected property owner.

1.03 WORK LOCATIONS

Work shall be located substantially as indicated on the drawings, but the County reserves the right to make such modifications in locations as may be found desirable to avoid interference with existing structures or for other reasons.

1.04 OPEN EXCAVATIONS

- A. All open excavations shall be adequately safeguarded by providing temporary barricades, caution signs, lights and other means to prevent accidents to persons and damage to property. The Contractor shall, at his own expense, provide suitable and safe bridges and other crossings for accommodating travel by pedestrians and workmen. Bridges provided for access to private property during construction shall be removed when no longer required. If the excavation becomes a hazard, or if it excessively restricts traffic at any point, the County may require special construction procedures such as limiting the length of open trench, prohibiting stacking excavated material in the street and requiring that the trench shall not remain open overnight.
- B. The Contractor shall take precautions to prevent injury to the public due to open trenches. All trenches, excavated material, equipment, or other obstacles which could be dangerous to the public shall be barricaded and well lighted at all times when construction is not in progress.

1.05 DISTRIBUTION SYSTEMS AND SERVICES

- A. The Contractor shall avoid interruptions to water, telephone, cable TV, sewer, gas, or other related utility services. He shall notify the County and the appropriate agency well in advance of any requirement for dewatering, isolating, or relocating a section of a utility, so that necessary arrangements may be made.
- B. If it appears that utility service will be interrupted for an extended period, the County may order the Contractor to provide temporary service lines at the Contractor's expense.

Inconvenience of the users shall be kept to the minimum, consistent with existing conditions. The safety and integrity of the systems are of prime importance in scheduling work.

1.06 PROTECTION AND RELOCATION OF EXISTING STRUCTURES AND UTILITIES

- A. The Contractor shall assume full responsibility for the protection of all buildings, structures and utilities, public or private, including poles, signs, services to building utilities, gas pipes, water pipes, hydrants, sewers, drains and electric and telephone cables and other similar facilities, whether or not they are shown on the Drawings. The Contractor shall carefully support and protect all such structures and utilities from injury of any kind. Any damage resulting from the Contractor's operation shall be repaired by the Contractor at his expense.
- B. The Contractor shall bear full responsibility for obtaining locations of all underground structures and utilities (including existing water services, drain lines and sewers). Services to buildings shall be maintained and all costs or charges resulting from damage thereto shall be paid by the Contractor.
- C. Protection and temporary removal and replacement of existing utilities and structures as described in this Section shall be a part of the work under the Contract and all costs in connection therewith shall be included in the unit prices established in the Bid.
- D. If, in the opinion of the County, permanent relocation of a utility owned by the County is required, the County may direct the Contractor, in writing, to perform the work. Work so ordered will be paid for at the Contract unit prices, if applicable, or as extra work as classified in the General Conditions. If relocation of a privately owned utility is required, the County will notify the utility to perform the work as expeditiously as possible. The Contractor shall fully cooperate with the County and utility and shall have no claim for delay due to such relocation. The Contractor shall notify public utility companies in writing at least 48 hours (excluding Saturdays, Sundays and legal holidays) before excavating near their utilities.

1.07 TEST PITS

Test pits for the purpose of locating underground pipeline or structures in advance of the construction shall be excavated and backfilled by the Contractor immediately after the utility location and the surface shall be restored in a manner equal or better than the original condition. No separate payment will be made.

1.08 CARE AND PROTECTION OF PROPERTY

- A. The Contractor shall be responsible for the preservation of all public and private property and shall use every precaution necessary to prevent damage thereto. If any direct or indirect damage is done to public or private property by or on account of any act, omission, neglect, or misconduct in the execution of the work on the part of the Contractor, such property shall be restored by the Contractor, at his expense, to a condition equal or better to that existing before the damage was done, or he shall make good the damage in another manner acceptable to the County.
- B. All sidewalks which are disturbed by the Contractor's operations shall be restored to their original or better condition by the use of similar or comparable materials. All curbing shall be restored in a condition equal to the original construction and in accordance with the best modern practice.
- C. Along the location of this work, all fences, walks, bushes, trees, shrubbery and other

physical features shall be protected and restored in a thoroughly workmanlike manner unless otherwise shown on the drawings. Fences and other features removed by the Contractor shall be replaced in the location indicated by the County as soon as conditions permit. All grass areas beyond the limits of construction which have been damaged by the Contractor shall be regraded and sodded to equal or exceed original conditions.

- D. Trees close to the work which drawings do not specify to be removed, shall be boxed or otherwise protected against injury. The Contractor shall trim all branches that are liable to damage because of his operations, but in no case shall any tree be cut or removed without prior notification to the County. All injuries to bark, trunk, limbs and roots of trees shall be repaired by dressing, cutting and painting according to approved methods, using only approved tools and materials.
- E. The protection, removal and replacement of existing physical features along the line of work shall be a part of the work under the Contract and all costs in connection therewith shall be included in the unit and/or lump sum prices established under the items in the Bid.

1.09 MAINTENANCE OF TRAFFIC

- A. Open pits, trenches, unpaved streets, debris, or other obstructions due to construction that will prevent the normal flow of traffic during an extended construction stoppage, for any reason, shall be minimized. In the event an extended construction stoppage is found to be necessary, Contractor shall, at his own expense, provide normal traffic flow during extended construction stoppage. Extended stoppage will be defined by the County.
- B. All excavated material shall be placed so that vehicular and pedestrian traffic may be maintained at all times. If the Contractor's operations cause traffic hazards, he shall repair the road surface, provide temporary roadways, erect wheel guards or fences, or take other safety measures which are satisfactory to the County.
- C. Any changes to the traffic pattern require a Traffic Control Plan as detailed in section 01570 of this specification..

1.10 WATER FOR CONSTRUCTION PURPOSES

- A. In locations where public water supply is available, the Contractor may purchase water for all construction purposes.
- B. The Contractor shall be responsible for paying for all water tap fees incurred for the purpose of obtaining a potable water service or temporary use meter.

1.11 MAINTENANCE OF FLOW

The Contractor shall at his own cost, provide for the flow of sewers, drains and water courses interrupted during the progress of the work and shall immediately cart away and remove all offensive matter. The entire procedure of maintaining existing flow shall be fully discussed with the County well in advance of the interruption of any flow.

1.12 CLEANUP

During the course of the work, the Contractor shall keep the site of his operations in as clean and neat a condition as is possible. He shall dispose of all residue resulting from the

construction work and at the conclusion of the work, he shall remove and haul away any surplus excavation, broken pavement, lumber, equipment, temporary structures and any other refuse remaining from the construction operations and shall leave the entire site of the work in a neat and orderly condition.

1.13 COOPERATION WITHIN THIS CONTRACT

- A. All firms or person authorized to perform any work under this Contract shall cooperate with the General Contractor and his subcontractors or trades and shall assist in incorporating the work of other trades where necessary or required.
- B. Cutting and patching, drilling and fitting shall be carried out where required by the trade or subcontractor having jurisdiction, unless otherwise indicated herein or directed by the County.

1.14 PROTECTION OF CONSTRUCTION AND EQUIPMENT

- A. All newly constructed work shall be carefully protected from injury in any way. No wheeling or walking or placing of heavy loads on it shall be allowed and all portions injured shall be reconstructed by the Contractor at his own expense.
- B. All structures shall be protected in a manner approved by the County. Should any of the floors or other parts of the structures become heaved, cracked, or otherwise damaged, all such damaged portions of the work shall be completely repaired and made good by the Contractor, at his own expense and to the satisfaction of the County. If, in the final inspection of the work, any defects, faults, or omissions are found, the Contractor shall cause the same to be repaired or removed and replaced by proper materials and workmanship without extra compensation for the materials and labor required. Further, the Contractor shall be fully responsible for the satisfactory maintenance and repair of the construction and other work undertaken herein, for at least the warranty period described in the Contract.
- C. Further, the Contractor shall take all necessary precautions to prevent damage to any structure due to water pressure during and after construction and until such structure is accepted and taken over by the County.

1.15 CONSTRUCTION WITHIN RIGHT-OF-WAY

Where pipe lines are installed within FDOT right-of-way, all excavation backfill and compaction for the purpose of reconstructing roadways and/or adjacent slopes contiguous thereto shall be in accordance with FDOT or Manatee County Standards and Specifications, whichever is applicable. Contractor shall satisfy the authorized representative of the FDOT with respect to proper safety procedures, construction methods, required permitting, etc., within the FDOT right-of-way.

PART 2 PRODUCTS (NOT USED)
PART 3 EXECUTION (NOT USED)

END OF SECTION

SECTION 01030 SPECIAL PROJECT PROCEDURES

PART 1 GENERAL

1.01 PERMITS

Upon notice of award, the Contractor shall immediately apply for all applicable permits not previously obtained by the County to do the work from the appropriate governmental agency or agencies. No work shall commence until all applicable permits have been obtained and copies delivered to the County. The costs for obtaining all permits shall be borne by the Contractor.

1.02 CONNECTIONS TO EXISTING SYSTEM

The Contractor shall perform all work necessary to locate, excavate and prepare for connections to the existing systems all as shown on the Drawings or where directed by the County. The cost for this work and for the actual connection shall be included in the price bid for the project and shall not result in any additional cost to the County. The termination point for each contract shall be as shown on the Contract Drawings.

1.03 RELOCATIONS

The Contractor shall be responsible for the coordination of the relocation of structures, including but not limited to light poles, power poles, signs, sign poles, fences, piping, conduits and drains that interfere with the positioning of the work as set out on the Drawings. No relocation of the items under this Contract shall be done without approval from the County.

1.04 EXISTING UNDERGROUND PIPING, STRUCTURES AND UTILITIES

- A. The attention of the Contractor is drawn to the fact that during excavation, the possibility exists of the Contractor encountering various utility lines not shown on the Drawings. The Contractor shall exercise extreme care before and during excavation to locate and flag these lines as to avoid damage to the existing lines.
- B. It is the responsibility of the Contractor to ensure that all utility or other poles, the stability of which may be endangered by the close proximity of excavation, are temporarily stayed in position while work proceeds in the vicinity of the pole and that the utility or other companies concerned be given reasonable advance notice.
- C. The existing utility locations are shown without express or implied representation, assurance, or guarantee that they are complete or correct or that they represent a true picture of underground piping to be encountered. The Contractor shall be responsible for notifying the various utility companies to locate their respective utilities in advance of construction in conformance with all requirements provided for in the Florida Underground Facilities Damage Prevention and Safety Act (Florida Statutes, Title XXXIII, Chapter 556).
- D. The existing piping and utilities that interfere with new construction shall be rerouted as shown, specified, or required. Before any piping and utilities not shown on the Drawings are disturbed, the Contractor shall notify the County and shall provide suggestions on how best to resolve the issue.

- E. The Contractor shall exercise care in any excavation to locate all existing piping and utilities. All utilities which do not interfere with complete work shall be carefully protected against damage. Any existing utilities damaged in any way by the Contractor shall be restored or replaced by the Contractor at his expense as directed by the County.
- F. It is intended that wherever existing utilities such as water, sewer, gas, telephone, electrical, or other service lines must be crossed, deflection of the pipe within recommended limits and cover shall be used to satisfactorily clear the obstruction unless otherwise indicated in the Drawings. However, when in the opinion of the County this procedure is not feasible, he may direct the use of fittings for a utilities crossing as detailed on the Drawings. No deflections will be allowed in gravity sanitary sewer lines or in existing storm sewer lines.

1.05 SUSPENSION OF WORK DUE TO WEATHER

Refer to FDOT Standards and Specifications Book, Section 8.

1.06 HURRICANE PREPAREDNESS PLAN

- A. Within 30 days of the date of Notice to Proceed, the Contractor shall submit to the County a Hurricane Preparedness Plan. The plan should outline the necessary measures which the Contractor proposes to perform at no additional cost to the County in case of a hurricane warning.
- B. In the event of inclement weather, or whenever County shall direct, Contractor shall insure that he and his Subcontractors shall carefully protect work and materials against damage or injury from the weather. If, in the opinion of the County, any portion of work or materials is damaged due to the failure on the part of the Contractor or Subcontractors to protect the work, such work and materials shall be removed and replaced at the expense of the Contractor.

1.07 POWER SUPPLY

Electricity as may be required for construction and permanent power supply shall be secured and purchased by the Contractor.

1.08 SALVAGE

Any existing equipment or material, including, but not limited to, valves, pipes, fittings, couplings, etc., which is removed or replaced as a result of construction under this project may be designated as salvage by the County and if so shall be protected for a reasonable time until picked up by the County. Any equipment or material not worthy of salvaging, as directed by the County, shall be disposed of by the Contractor at no additional cost.

1.09 DEWATERING

- A. The Contractor shall do all groundwater pumping necessary to prevent flotation of any part of the work during construction operations with his own equipment.
- B. The Contractor shall pump out water and wastewater which may seep or leak into the excavations for the duration of the Contract and with his own equipment. He shall dispose of this water in an appropriate manner.

1.10 ADDITIONAL PROVISIONS

- A. Before commencing work on any of the existing pipelines, structures or equipment, the Contractor shall notify the County, in writing, at least 10 calendar days in advance of the date he proposes to commence such work.
- B. The Contractor shall provide, at his own expense, all necessary temporary facilities for access to and for protection of, all existing facilities. The County's personnel must have ready access at all times to the existing facilities. The Contractor is responsible for all damage to existing structures, equipment and facilities caused by his construction operations and must repair all such damage when and as ordered by the County.

1.11 CONSTRUCTION CONDITIONS

The Contractor shall strictly adhere to the specific requirements of the governmental unit(s) and/or agency(ies) having jurisdiction over the work. Wherever there is a difference in the requirements of a jurisdictional body and these Specifications, the more stringent shall apply.

1.12 PUBLIC NUISANCE

- A. The Contractor shall not create a public nuisance including but not limited to encroachment on adjacent lands, flooding of adjacent lands, excessive noise or dust.
- B. Sound levels must meet Manatee County Ordinance #87-34, (which amends Ordinance 81-3, The Manatee County Noise Control Ordinance). Sound levels in excess of such ordinance are sufficient cause to have the work halted until equipment can be quieted to these levels. Work stoppage by the County for excessive noise shall not relieve the Contractor of the other portions of this specification.
- C. No extra charge may be made for time lost due to work stoppage resulting from the creation of a public nuisance.

1.13 WARRANTIES

- A. All material supplied under these Specifications shall be warranted by the Contractor and the manufacturers for a period of three (3) years. Warranty period shall commence on the date of County acceptance.
- B. The material shall be warranted to be free from defects in workmanship, design and materials. If any part of the system should fail during the warranty period, it shall be replaced at no expense to the County. All material and installation costs shall be 100% borne by the Contractor.
- C. The manufacturer's warranty period shall run concurrently with the Contractor's warranty or guarantee period. No exception to this provision shall be allowed. The Contractor shall be responsible for obtaining warranties from each of the respective suppliers or manufacturers for all the material specified under these contract specifications,
- D. In the event that the manufacturer is unwilling to provide a three-year warranty commencing at the time of County acceptance, the Contractor shall obtain from the manufacturer a four (4) year warranty starting at the time of equipment delivery to the job site. This four-year

warranty shall not relieve the Contractor of the three-year warranty starting at the time of County acceptance of the equipment.

1.14 FUEL STORAGE & FILLING

- A. If the contractor is storing fuel on site, or doing his own fuel filling of portable equipment (other than hand-held equipment), he is responsible for any required response, clean-up or reporting required, at no additional cost to the county.
- B. The Contractor shall prepare and submit a fuel storage / spill abatement plan prior to start of construction if required.

PART 2 PRODUCTS (NOT USED)

PART 3 EXECUTION (NOT USED)

END OF SECTION

SECTION 01045 CUTTING AND PATCHING

PART 1 GENERAL

1.01 REQUIREMENTS INCLUDED

- A. The Contractor shall be responsible for all cutting, fitting and patching, including excavation and backfill, required to complete the work or to:
1. Make its several parts fit together properly.
 2. Uncover portions of the work to provide for installation of ill-timed work.
 3. Remove and replace defective work.
 4. Remove and replace work not conforming to requirements of Contract Documents.
 5. Provide penetrations of non-structural surfaces for installation of piping and electrical conduit.

PART 2 PRODUCTS

2.01 MATERIALS

Comply with specifications and standards for each specific product involved.

PART 3 EXECUTION

3.01 INSPECTION

- A. Inspect existing conditions of project, including elements subject to damage or to movement during cutting and patching.
- B. After uncovering work, inspect conditions affecting installation of products, or performance of work.
- C. Report unsatisfactory or questionable conditions to County. Do not proceed with work until County has provided further instructions.

3.02 PREPARATION

- A. Provide adequate temporary support as necessary to assure structural value to integrity of affected portion of work.
- B. Provide devices and methods to protect other portions of project from damage.
- C. Provide protection from elements for that portion of the project which may be exposed by cutting and patching work and maintain excavations free from water.

3.03 PERFORMANCE

- A. Execute cutting and demolition by methods which will prevent damage to other work and will provide proper surfaces to receive installation of repairs.
- B. Execute excavating and backfilling by methods which will prevent settlement or damage to other work.

- C. Fit and adjust products to provide a finished installation to comply with specified products, functions, tolerances and finishes.
- D. Restore work which has been cut or removed; install new products to provide completed work in accordance with the requirements of the Contract Documents.
- E. Replace surfaces airtight to pipes, sleeves, ducts, conduit and other penetrations through surfaces.
- F. Refinish entire surfaces as necessary to provide an even finish to match adjacent finishes.

END OF SECTION

SECTION 01050 FIELD ENGINEERING AND SURVEYING

PART 1 GENERAL

1.01 REQUIREMENTS INCLUDED

- A. The Contractor shall provide and pay for field surveying service required for the project.
- B. The Contractor shall furnish and set all necessary stakes to establish the lines and grades as shown on the Contract Drawings and layout each portion of the Work of the Contract.

1.02 QUALIFICATION OF SURVEYOR AND ENGINEER

All construction staking shall be conducted by or under the supervision of a Florida Registered Professional Surveyor and Mapper. The Contractor shall be responsible for the layout of all such lines and grades, which will be subject to verification by the County.

1.03 SURVEY REFERENCE POINTS

- A. Existing basic horizontal and vertical control points for the Project are designated on the Contract Drawings.
- B. Locate and protect all survey monumentation, property corners and project control points prior to starting work and preserve all permanent reference points during construction. All costs associated with the replacement of all survey monumentation, property corners and project control points shall be borne by the Contractor.

Make no changes or relocations without prior written notice to County.

Report to County when any reference point is lost or destroyed, or requires relocation because of necessary changes in grades or locations.

Require surveyor to replace project control points which may be lost or destroyed.

Establish replacements based on original survey control.

1.04 PROJECT SURVEY REQUIREMENTS

The Contractor shall establish temporary bench marks as needed, referenced to data established by survey control points.

1.05 RECORDS

The Contractor shall employ a Professional Engineer or Surveyor registered in the State of Florida to verify survey data and properly prepare record drawings per Section 01720.

PART 2 PRODUCTS (NOT USED)

PART 3 EXECUTION (NOT USED)

END OF SECTION

SECTION 01090 REFERENCE STANDARDS

PART 1 GENERAL

1.01 REQUIREMENTS

Abbreviations and acronyms used in Contract Documents to identify reference standards.

- A. Application: When a standard is specified by reference, comply with requirements and recommendations stated in that standard, except when requirements are modified by the Contract Documents, or applicable codes established stricter standards.
- B. Publication Date: The most recent publication in effect on the date of issue of Contract Documents, except when a specific publication date is specified.

1.03 ABBREVIATIONS, NAMES AND ADDRESSES OR ORGANIZATIONS

Obtain copies of reference standards direct from publication source, when needed for proper performance of work, or when required for submittal by Contract Documents.

| | |
|--------|--|
| AA | Aluminum Association 818 Connecticut Avenue, N.W. Washington, DC 20006 |
| AASHTO | American Association of State Highway and Transportation Officials 444 North Capital Street, N.W. Washington, DC 20001 |
| ACI | American Concrete Institute Box 19150 Reford Station Detroit, MI 48219 |
| AI | Asphalt Institute Asphalt Institute Building College Park, MD 20740 |
| AISC | American Institute of Steel Construction 1221 Avenue of the Americas New York, NY 10020 |
| AISI | American Iron and Steel Institute 1000 16th Street NW Washington, DC 20036 |
| ANSI | American National Standards Institute 1430 Broadway New York, NY 10018 |
| ASHRAE | American Society of Heating, Refrigerating and Air Conditioning Engineers 1791 Tullie Circle, N.E. Atlanta, GA 30329 |

| | |
|---------------|---|
| ASME | American Society of Mechanical Engineers 345 East 47th Street New York, NY 10017 |
| ASTM | American Society for Testing and Materials 1916 Race Street Philadelphia, PA 19103 |
| AWWA | American Water Works Association 6666 West Quincy Avenue Denver, CO 80235 |
| AWS | American Welding Society 2501 N.W. 7th Street Miami, FL 33125 |
| CRSI | Concrete Reinforcing Steel Institute 180 North LaSalle Street, Suite 2110 Chicago, IL 60601 |
| FDEP | Florida Department of Environmental Protection 3900 Commonwealth Blvd. Tallahassee, Florida 32399 |
| FDOT | Florida Department of Transportation Standards Specifications for Road and Bridge Construction Maps & Publication Sales - Mail Station 12 605 Suwannee St. Tallahassee, FL 32399-0450 |
| FS | Federal Specification General Services Administration Specifications and Consumer Information Distribution Section (WFSIS) Washington Navy Yard, Bldg. 197 Washington, DC 20407 |
| MCPW UTIL STD | Manatee County Utility Engineering 4410-B 66th St. W. Bradenton, FL 34210 |
| MLSFA | Metal Lath/Steel Framing Association 221 North LaSalle Street Chicago, IL 60601 |
| MMA | Monorail Manufacturer's Association 1326 Freeport Road Pittsburgh, PA 15238 |
| NAAMM | National Association of Architectural Metal Manufacturers 221 North LaSalle Street Chicago, IL 60601 |
| NEMA | National Electrical Manufacturer's Assoc. |

2101 L Street N.W.
Washington, DC 20037

- OHSA Occupational Safety and Health Assoc.
5807 Breckenridge Pkwy., Suite A
Tampa, FL 33610-4249
- PCA Portland Cement Association
5420 Old Orchard Road
Skokie, IL 20076
- PCI Prestressed Concrete Institute
20 North Wacker Drive
Chicago, IL 60606
- SDI Steel Door Institute
712 Lakewood Center North
Cleveland, OH 44107
- SMACNA Sheet Metal and Air Conditioning Contractor's National Association
8224 Old Court House Road
Vienna, VA 22180
- SSPC Steel Structures Painting Council
402 24th Street, Suite 600
Pittsburgh, PA 15213
- SWFWMD Southwest Florida Water Management District
2379 Broad Street
Brooksville, FL 34604-6899
- UL Underwriter's Laboratories, Inc.
333 Pfingston Road
Northbrook, IL 60062

PART 2 PRODUCTS (NOT USED)

PART 3 EXECUTION (NOT USED)

END OF SECTION

SECTION 01150 MEASUREMENT AND PAYMENT

PART 1 GENERAL

1.01 SCOPE

- A. The scope of this section of the Contract Documents is to further define the items included in each Bid Item in the Bid Form section of the Contract Documents. Payment will be made based on the specified items included in the description in this section for each bid item. All components in contact with potable water to be NSF61 certified. Bid Items to be in accordance with and meet requirements of these Specifications, County Standards and County Approved Products List (or equal)
- B. All contract prices included in the Bid Form section will be full compensation for all shop drawings, working drawings, labor, materials, tools, equipment and incidentals necessary to complete the construction as shown on the Drawings and/or as specified in the Contract Documents to be performed under this Contract. Actual quantities of each item bid on a unit price basis will be determined upon completion of the construction in the manner set up for each item in this section of the Specifications. Payment for all items listed in the Bid Form will constitute full compensation for all work shown and/or specified to be performed under this Contract.

1.02 ESTIMATED QUANTITIES

The quantities shown are approximate and are given only as a basis of calculation upon which the award of the Contract is to be made. The County does not assume any responsibility for the final quantities, nor shall the Contractor claim misunderstanding because of such estimate of quantities. Final payment will be made only for satisfactorily completed quantity of each item.

1.03 WORK OUTSIDE AUTHORIZED LIMITS

No payment will be made for work constructed outside the authorized limits of work.

1.04 MEASUREMENT STANDARDS

Unless otherwise specified for the particular items involved, all measurements of distance shall be taken horizontally or vertically.

1.05 AREA MEASUREMENTS

In the measurement of items to be paid for on the basis of area of finished work, the lengths and/or widths to be used in the calculations shall be the final dimensions measured along the surface of the completed work within the neat lines shown or designated.

1.06 LUMP SUM ITEMS

Where payment for items is shown to be paid for on a lump sum basis, no separate payment will be made for any item of work required to complete the lump sum items. Lump sum contracts shall be complete, tested and fully operable prior to request for final payment. Contractor may be required to provide a break-down of the lump sum totals.

1.07

UNIT PRICE ITEM

Separate payment will be made for the items of work described herein and listed on the Bid Form. Any related work not specifically listed, but required for satisfactory completion of the work shall be considered to be included in the scope of the appropriate listed work items.

No separate payment will be made for the following items and the cost of such work shall be included in the applicable pay items of work. Final payments shall not be requested by the Contractor or made by the County until as-built (record) drawings have been submitted and approved by the County.

1. Project signs and photographs.
2. Removal, repair, replacement or relocation of all signs, walls, private irrigation systems and related items.
3. Rubbish and spoil removal.
4. Shop Drawings, Working Drawings.
5. Clearing, grubbing and grading except as hereinafter specified.
6. Trench excavation, including necessary pavement removal and rock removal, except as otherwise specified.
7. Dewatering and disposal of surplus water.
8. Structural fill, backfill, and grading.
9. Replacement of unpaved roadways, and shrubbery plots.
10. Cleanup and miscellaneous work.
11. Foundation and borrow materials, except as hereinafter specified.
12. Flushing, pigging, and tie-ing into existing main.
 - a. Flushing, pigging, and tie-in plan must be submitted and approved prior to work.
13. Testing and placing system in operation.
 - a. Including all necessary testing to place main into operation.
 - i. Bacteriological Testing
 - ii. Pressure Testing
 - b. All permanent and temporary materials, equipment, labor and appurtenances necessary for testing and acquiring clearances.
14. Any material and equipment required to be installed and utilized for the tests.
15. Pipe, structures, pavement replacement, asphalt and shell driveways and/or appurtenances included within the limits of lump sum work, unless otherwise shown.
16. Pipe identification tape, tracer wire, tracer wire boxes, tie-ing into existing tracer and continuity testing.
17. Maintaining the existing quality of service during construction.
18. Appurtenant work as required for a complete and operable system.
19. Obtaining and paying fees for all necessary permits to perform work and fees for clearances /requests to place main into service from permitting agency.
20. Maintenance of Traffic and Pedestrians.
 - a. Placing and removing all traffic signs and barriers.
21. Tree protection.
22. Clearing and grubbing.
23. Erosion Control.
 - a. Minimum silt fence along length of project disturbed area.
 - b. Erosion control methods must meet requirements of Manatee County and other governing agencies.
24. Seeding and hydromulching.

BID ITEM NO. MC-1: MOBILIZATION

Measurement and payment for this Bid Item shall include full compensation for the required 100 percent (100%) Performance Bond, 100 Percent (100%) Payment Bond, all required insurance for the project and the Contractor's mobilization and demobilization costs as shown in the Bid Form. Mobilization includes, but it not limited to: preparation and movement of personnel, equipment, supplies and incidentals such as safety and sanitary supplies/ facilities

Payment for mobilization shall not exceed 10 percent (10%) of the total Contract cost unless the Contractor can prove to the County that his actual mobilization cost exceeds 10 percent (10%).

Partial payments for this Bid Item will be made in accordance with the following schedule:

| Percent of Original Contract Amount: | Percent Allowable Payment of Mobilization/Demobilization Bid Item Price: |
|--------------------------------------|--|
| 5 | 25 |
| 10 | 35 |
| 25 | 45 |
| 50 | 50 |
| 75 | 75 |
| 100 | 100 |

These payments will be subject to the standard retainage provided in the Contract. Payment of the retainage will be made after completion of the work and demobilization.

BID ITEM NO. MC-2: 4" - 6" GATE VALVES (RESTRAINED JOINT)

Payment for all work included in this Bid Item shall be made at the applicable Contract unit price bid per each valve for furnishing and installing the listed diameter valve, valve box, cover, tracer wire, identification disc, and concrete pad and as shown on the Contract Drawings and listed on the Bid Form. Payment to include polyethylene wrap; all valves are to be encased in polyethylene (polywrapped). Payment shall represent full compensation for all labor, material, excavation, including rock as necessary, bedding, backfill, compaction, mechanical joint restraints, tracer wire, tracer wire splices, tracer wire boxes, testing and disinfection, surface restoration (roadway or sodding/landscape) to pre-construction condition not covered by other pay items, and equipment required to complete these Bid Items.

BID ITEM NO. MC-3: 4" - 6" DUCTILE IRON PIPE (RESTRAINED JOINT), WATER

Payment for all work included in this Bid Item shall be made at the applicable Contract unit price bid per the schedule of prices for furnishing and installing the listed diameter ductile iron water main (cement-lined) (AWWA C111 and AWWA C151) pipe as shown on the Contract Drawings and listed in the Bid Form. Measurement and Payment shall be made for the actual length of the listed diameter pipe installed and will represent full compensation for all labor, materials, excavation, including rock, dewatering, bedding, backfill, compaction, testing and disinfection, mechanical joint restraints (all joints to be restrained), tracer wire, tracer wire splices, tracer wire boxes, surface restoration (roadway or sodding/landscape) to pre-construction condition not covered by other pay items, and equipment required to complete these Bid Items. Payment to include polyethylene wrap; all ductile iron pipe is to be encased in polyethylene (polywrapped). No additional compensation will be made for excavation below

the bottom of the pipe, for rock removal or bedding and backfill materials, or for repair of any trench settlement. Payment to include thrust blocks noted on Drawings. Thrust blocks to be in accordance with County Standards; see detail UG-7.

BID ITEM NO. MC-4: 4" - 6" DUCTILE IRON FITTINGS (RESTRAINED JOINT), WATER

Payment for all work included in these Bid Items will be made at the applicable Contract unit price bid for furnishing and installing each ductile iron fitting (cement-lined) as shown on the Contract Drawings and listed on the Bid Form. Payment to include polyethylene wrap; all ductile iron fittings is to be encased in polyethylene (polywrapped). Payment shall represent full compensation for all labor, material, equipment, excavation, including rock, bedding, backfill, compaction, mechanical joint restraints (all fittings to be restrained with mechanical restraints), and post restraining existing main with mechanical restraints per County Standards, tracer wire, tracer wire splices, tracer wire boxes, testing and disinfection, surface restoration (roadway or sodding/landscape) to pre-construction condition not covered by other pay items, and all equipment, materials and labor necessary required to complete these Bid Items.

BID ITEM NO. MC-5: HYDRANT RELOCATION

Payment for all work included in this Bid Item will be made at the applicable Contract unit price bid per each (EA) hydrant relocation, including hydrant lead, tapping sleeve and tapping valve or tee and gate valve as necessary, removal and cleaning of existing hydrant assembly, and relocation and installation of the hydrant assembly to the new location as shown on the Contract Drawings and listed on the Bid Form. Payment shall represent full compensation for all labor, materials, equipment, testing and disinfection, surface restoration (roadway or sodding/landscape) to pre-construction condition not covered by other pay items, and all equipment, materials and labor necessary to complete this Bid Item, ready for approval and acceptance by the County.

BID ITEM NO. MC-6: SODDING

Measurement shall be per square yards of sod installed, alive and growing.

Payment will be per actual quantity of square yards of sodding, seeding and mulching installed and accepted.

The unit bid price shall include, but is not limited to, cutting down the existing ground to accept sod, installation, watering, and all labor, materials, necessary equipment, and incidentals necessary to complete this bid item, ready for approval and acceptance by the County.

Sod placed at the edge of the roadway shall not create a "dam" and impede storm water runoff from existing the roadway and entering the stormwater conveyance system.

BID ITEM NO. MC-7: PAVEMENT REPAIR AND ROAD RESTORATION

Payment for all work included under this Bid Item will be made at the Contract unit price bid per square yard of base, subbase and tonnage of asphalt for furnishing, installing and testing the road restoration pavement section within these Specifications and as listed on the Bid Form. Measurement will be based on the actual number of square yards of road restoration installed, tested, complete and approved. The measurement will be from face of curb to face of curb or as specified, but not greater than the width of the existing roadway prior to construction. Payment will include complete restoration of the roadway section in accordance with the applicable details on the Contract Drawings, but not less than 1-1/2 inches of FDOT

Type III asphaltic concrete, the necessary base, subbase or compacted suitable excavation material all in accordance with these Specifications. No payment for restoration of a private driveway within or outside the right-of-way shall be made under this Bid Item. Payment shall include all items and incidentals necessary to complete the road restoration in accordance with the requirements of Manatee County ready for approval and acceptance by the County.

BID ITEM NO. MC-8: WATER SERVICE REPLACEMENTS

Payment for Bid Item water service replacements shall be based on the actual number of services furnished and installed in the locations shown on the plans or as directed by the County at the Contract Unit price of each (EA). Payment shall include costs for labor, equipment, materials and appurtenances shown and noted in Detail UW-21. Payment shall include 1" tapping saddle (with stainless steel straps), 1" corporation stop (SST), tracer wire and tracer wire splices, 1" polyethylene (for services not under pavement) or 1" stainless steel (for under pavement), curb stop (SST), connection to exiting meter box, disconnection and removal of existing water service line, and all items necessary to construct the water service and removal of existing service complete, in accordance with Detail UW-21 and ready for service. Payment shall include surveying, excavation, dewatering, sheeting and shoring, backfilling, compaction, excess material removal, testing, clean-up, all labor, materials, pavement saw cutting and removal (as needed), temporary and final pavement (as needed), surface restoration not covered by other pay items, and labor, material, and equipment necessary to furnish and install the ARV and enclosure and make them ready for service.

BID ITEM NO. MC-9: 4" AC / DI ADAPTER

Payment for all work included in this Bid Item will be made at the applicable Contract Unit price per each (EA) for furnishing and installing ductile iron (DI) to asbestos cement (AC) pipe transition adapters, size as noted on the drawings. Adapter body to be ductile iron, hardware to be stainless steel, and gasket to be EPDM. Adapter to have 250 psi pressure rating minimum. Payment will be made for each DI to AC adapter installed and will represent full compensation for excavation, including rock, sheeting and shoring, bedding, backfill, compaction, testing and equipment, surface restoration (roadway or sodding/landscape) to pre-construction condition not covered by other pay items, and all equipment, materials and labor required to complete this Bid Item in accordance with County Standards.

BID ITEM NO. MC-10: SAMPLE POINT

Payment for this Bid Item (temporary sample points) will be made at the Contract Unit Price of each (EA) and shall include furnishing and installing necessary tapping saddle (double stainless steel straps), 3/4-inch PET tubing, corporation stop, 3/4-inch curb stop, 3/4-inch hose bib, removal of piping and valves up to corporation stop, corporation stop plug once ready for abandonment, backfill, surface restoration (roadway or sodding/landscape) to pre-construction condition not covered by other pay items, and all equipment, materials and labor necessary furnishing all material, labor, tools, and equipment and all incidental and related work required to complete the work.

BID ITEM NO. MC-11: REMOVE 4" AC WATER MAIN

Payment for this Bid Item will be at the applicable contract unit price of linear feet (LF) and shall include all labor, materials and equipment. Pipe removal shall include removal and disposal of asbestos cement potable water main and appurtenances. Provide all labor, equipment and materials to remove the pipeline and appurtenances (such as valves, valve boxes, concrete collars, ARVs and enclosures (and manholes), casing, fittings, and other materials and

appurtenances) as designated on the plans or directed by the Engineer.

The removal of pipe shall include, but may not be limited to excavation, dewatering, backfill, compaction, shoring, removing the pipeline and appurtenances, proper and legal removal and dispose of removed materials (personnel must have required certifications and PPE to remove and dispose of asbestos cement pipe), proper disposal of water within pipeline, cutting of any existing pipe to accommodate removal, removing all concrete vaults as required (if any found), backfilling and compacting, surface restoration (roadway or sodding/ landscape) to pre-construction condition not covered by other pay items, and all equipment, materials and labor necessary to complete work to satisfactory of County.

BID ITEM NO. MC-12: REMOVE 6" PVC WATER MAIN

Payment for this Bid Item will be at the applicable contract unit price of linear feet (LF) and shall include all labor, materials and equipment. Pipe removal shall include removal and disposal of polyvinyl chloride (PVC) potable water main and appurtenances. Provide all labor, equipment and materials to remove the pipeline and appurtenances (such as valves, valve boxes, concrete collars, ARVs and enclosures (and manholes), casing, fittings, and other materials and appurtenances) as designated on the plans or directed by the Engineer.

The removal of pipe shall include, but may not be limited to excavation, dewatering, backfill, compaction, shoring, removing the pipeline and appurtenances, proper and legal removal and dispose of removed materials, proper disposal of water within pipeline, cutting of any existing pipe to accommodate removal, removing all concrete vaults as required (if any found), backfilling and compacting, surface restoration (roadway or sodding/ landscape) to pre-construction condition not covered by other pay items, and all equipment, materials and labor necessary to complete work to satisfactory of County.

BID ITEM NO. MC-13: RECORD DRAWINGS

Payment for all work included under this Bid Item shall be made at the Contract lump sum price bid listed in the Bid Form and shall represent full compensation for all labor, materials and equipment required to generate and provide record drawings approved and accepted by the County. Record drawings shall be in strict accordance with Section 1.14 of the Manatee County Public Work Utility Standards.

PART 2 PRODUCTS (NOT USED)

PART 3 EXECUTION (NOT USED)

END OF SECTION

SECTION 01152 REQUESTS FOR PAYMENT

PART 1 GENERAL

1.01 REQUIREMENTS INCLUDED

Submit Applications for Payment to the Project Manager or as directed at the preconstruction meeting, in accordance with the schedule established by Conditions of the Contract and Agreement between County and Contractor.

1.02 FORMAT AND DATA REQUIRED

- A. Submit payment requests in the form provided by the County with itemized data typed in accordance with the Bid Form.
- B. Provide construction photographs in accordance with Contract Documents.

1.03 SUBSTANTIATING DATA FOR PROGRESS PAYMENTS

- A. When the County requires substantiating data, Contractor shall submit suitable information with a cover letter.
- B. Submit one copy of data and cover letter for each copy of application.

1.04 PREPARATION OF APPLICATION FOR FINAL PAYMENT

Fill in application form as specified for progress payments.

1.05 SUBMITTAL PROCEDURE

- A. Submit applications for payment at the times stipulated in the Agreement.
- B. Number: Three (3) copies of each application; all signed and certified by the Contractor.

PART 2 PRODUCTS (NOT USED)

PART 3 EXECUTION (NOT USED)

END OF SECTION

SECTION 01153 CHANGE ORDER PROCEDURES

PART 1 GENERAL

1.01 DEFINITION

- A. Change Order: A written order signed by the Owner, the Architect/Engineer and the Contractor authorizing a change in the Project Plans and/or Specifications and, if necessary, a corresponding adjustment in the Contract Sum and/or Contract Time, pursuant to Article V of the General Conditions of the Construction Agreement.
- B. Administrative Change Adjustment: Minor change order under 10% of project cost or 20% time, does not have to be Board approved.
- C. Field Directive: A written order issued by Owner which orders minor changes in the Work not involving a change in Contract Time, to be paid from the Owner's contingency funds.
- D. Field Order: Minor change to contract work that does not require adjustment of contract sum or expected date of completion.

1.02 REQUIREMENTS INCLUDED

- A. The Contractor shall promptly implement change order procedures:
 - 1. Provide full written data required to evaluate changes.
 - 2. Maintain detailed records of work done on a time-and-material/force account basis.
 - 3. Provide full documentation to County on request.
- B. The Contractor shall designate a member of the Contractor's organization who:
 - 1. Is authorized to accept changes to the Work.
 - 2. Is responsible for informing others in the Contractor's employ of the authorized changes into the Work.

1.03 PRELIMINARY PROCEDURES

- A. Project Manager may initiate changes by submitting a Request to Contractor. Request will include:
 - 1. Detailed description of the change, products, costs and location of the change in the Project.
 - 2. Supplementary or revised Drawings and Specifications.
 - 3. The projected time extension for making the change.
 - 4. A specified period of time during which the requested price will be considered valid.
 - 5. Such request is for information only and is not an instruction to execute the changes, nor to stop work in progress.
- B. Contractor may initiate changes by submitting a written notice to the Project Manager, containing:
 - 1. Description of the proposed changes.
 - 2. Statement of the reason for making the changes.
 - 3. Statement of the effect on the Contract Sum and the Contract Time.

4. Statement of the effect on the work of separate contractors.
5. Documentation supporting any change in Contract Sum or Contract Time, as appropriate.

1.04 FIELD ORDER CHANGE

- A. In lieu of a Change Order, the Project Manager may issue a Field Order for the Contractor to proceed with additional work within the original intent of the Project.
- B. Field Order will describe changes in the work, with attachments of backup information to define details of the change.
- C. Contractor must sign and date the Field Order to indicate agreement with the terms therein.

1.05 DOCUMENTATION OF PROPOSALS AND CLAIMS

- A. Support each quotation for a lump sum proposal and for each unit price which has not previously been established, with sufficient substantiating data to allow the County to evaluate the quotation.
- B. On request, provide additional data to support time and cost computations:
 1. Labor required.
 2. Equipment required.
 3. Products required.
 - a. Recommended source of purchase and unit cost.
 - b. Quantities required.
 4. Taxes, insurance and bonds.
 5. Credit for work deleted from Contract, similarly documented.
 6. Overhead and profit.
 7. Justification for any change in Contract Time.
- C. Support each claim for additional costs and for work done on a time-and-material/force account basis, with documentation as required for a lump-sum proposal.
 1. Name of the County's authorized agent who ordered the work and date of the order.
 2. Date and time work was performed and by whom.
 3. Time record, summary of hours work and hourly rates paid.
 4. Receipts and invoices for:
 - a. Equipment used, listing dates and time of use.
 - b. Products used, listing of quantities.
 - c. Subcontracts.

1.06 PREPARATION OF CHANGE ORDERS

- A. Project Manager will prepare each Change Order.
- B. Change Order will describe changes in the Work, both additions and deletions, with attachments as necessary to define details of the change.
- C. Change Order will provide an accounting of the adjustment in the Contract Sum and in the Contract Time.

1.07 LUMP SUM/FIXED PRICE CHANGE ORDER

- A. Project Manager initiates the form, including a description of the changes involved and attachments based upon documents and proposals submitted by the Contractor, or requests from the County, or both.
- B. Once the form has been completed, all copies should be sent to Contractor for approval. After approval by Contractor, all copies should be sent to County for approval. The County will distribute executed copies after approval by the Board of County Commissioners.

1.08 UNIT PRICE CHANGE ORDER

- A. Contents of Change Orders will be based on, either:
 - 1. County's definition of the scope of the required changes.
 - 2. Contractor's Proposal for a change, as approved by the County.
 - 3. Survey of completed work.
- B. The amounts of the unit prices to be:
 - 1. Those stated in the Agreement.
 - 2. Those mutually agreed upon between County and Contractor.

1.09 TIME AND MATERIAL/FORCE ACCOUNT CHANGE ORDER/CONSTRUCTION CHANGE AUTHORIZATION

- A. Refer to Article V.5.6 of the General Conditions of the Construction Agreement.

1.10 CORRELATION WITH CONTRACTOR'S SUBMITTALS

- A. Periodically revise Schedule of Values and Application for Payment forms to record each change as a separate item of work, and to record the adjusted Contract Sum.
- B. Periodically revise the Construction Schedule to reflect each change in Contract Time. Revise sub schedules to show changes for other items of work affected by the changes.
- C. Upon completion of work under a Change Order, enter pertinent changes in Record Documents.

PART 2 PRODUCTS (NOT USED)

PART 3 EXECUTION (NOT USED)

END OF SECTION

SECTION 01200 PROJECT MEETINGS

PART 1 GENERAL

1.01 REQUIREMENTS INCLUDED

- A. The County shall schedule the pre-construction meeting, periodic progress meetings and special meetings, if required, throughout progress of work.
- B. Representatives of contractors, subcontractors and suppliers attending meetings shall be qualified and authorized to act on behalf of the entity each represents.
- C. The Contractor shall attend meetings to ascertain that work is expedited consistent with Contract Documents and construction schedules.

1.02 PRE-CONSTRUCTION MEETING

A. Attendance:

- 1. County's Engineer.
- 2. County's Project Manager
- 3. Contractor.
- 4. Resident Project Representative.
- 5. Related Labor Contractor's Superintendent.
- 6. Major Subcontractors.
- 7. Major Suppliers.
- 8. Others as appropriate.

B. Suggested Agenda:

- 1. Distribution and discussion of:
 - a. List of major subcontractors.
 - b. Projected Construction Schedules.
 - c. Coordination of Utilities
- 2. Critical work sequencing.
- 3. Project Coordination.
 - a. Designation of responsible personnel.
 - b. Emergency contact persons with phone numbers.
- 4. Procedures and processing of:
 - a. Field decisions.
 - b. Submittals.
 - c. Change Orders.
 - d. Applications for Payment.
- 5. Procedures for maintaining Record Documents.
- 6. Use of premises:
 - a. Office, work and storage areas.
 - b. County's REQUIREMENTS.
- 7. Temporary utilities.
- 8. Housekeeping procedures.
- 9. Liquidated damages.
- 10. Equal Opportunity Requirements.
- 11. Laboratory testing.
- 12. Project / Job meetings: Progress meeting, other special topics as needed.

PART 2 PRODUCTS (NOT USED)

PART 3 EXECUTION (NOT USED)

END OF SECTION

SECTION 01310 CONSTRUCTION SCHEDULE & PROJECT RESTRAINTS

PART 1 GENERAL

1.01 GENERAL

- A. Construction under this contract must be coordinated with the County and accomplished in a logical order to maintain utilization and flow through existing facilities and public properties and rights-of-way and to allow construction to be completed within the time allowed by Contract Documents and in the manner set forth in the Contract.

1.02 CONSTRUCTION SCHEDULING GENERAL PROVISIONS

- A. No work shall be done between 7:00 p.m. and 7:00 a.m. nor on weekends or legal holidays without written permission of the County. However, emergency work may be done without prior permission.
- B. Night work may be established by the Contractor as regular procedure with the written permission of the County. Such permission, however, may be revoked at any time by the County if the Contractor fails to maintain adequate equipment and supervision for the proper execution and control of the work at night.
- C. Due to potential health hazards and requirements of the State of Florida and the U.S. Environmental Protection Agency, existing facilities must be maintained in operation.
- D. The Contractor shall be fully responsible for providing all temporary piping, plumbing, electrical hook-ups, lighting, temporary structure, or other materials, equipment and systems required to maintain the existing facility's operations. All details of temporary piping and temporary construction are not necessarily shown on the Drawings or covered in the Specifications. However, this does not relieve the Contractor of the responsibility to insure that construction will not interrupt proper facility operations.
- E. The Contractor shall designate an authorized representative of his firm who shall be responsible for development and maintenance of the schedule and of progress and payment reports. This representative of the Contractor shall have direct project control and complete authority to act on behalf of the Contractor in fulfilling the commitments of the Contractor's schedule.

PART 2 PRODUCTS

2.01 GENERAL REQUIREMENTS

- A. The Contractor shall submit a critical path schedule as described herein.
- B. The planning, scheduling, management and execution of the work is the sole responsibility of the Contractor. The progress schedule requirement is established to allow County to review Contractor's planning, scheduling, management and execution of the work; to assist County in evaluating work progress and make progress payments and to allow other contractors to cooperate and coordinate their activities with those of the Contractor.

2.02 FORM OF SCHEDULES

- A. Prepare schedules using the latest version of Microsoft Project, or other County approved

software, in the form of a horizontal bar chart diagram. The diagram shall be time-scaled and sequenced by work areas. Horizontal time scale shall identify the first work day of each week.

- B. Activities shall be at least as detailed as the Schedule of Values. Activity durations shall be in whole working days. In addition, man-days shall be shown for each activity or tabulated in an accompanying report.
- C. Diagrams shall be neat and legible and submitted on sheets at least 8-1/2 inches by 11 inches suitable for reproduction. Scale and spacing shall allow space for notations and future revisions.

2.03 CONTENT OF SCHEDULES

- A. Each monthly schedule shall be based on data as of the last day of the current pay period.
- B. Description for each activity shall be brief, but convey the scope of work described.
- C. Activities shall identify all items of work that must be accomplished to achieve substantial completion, such as items pertaining to Contractor's installation and testing activities; items pertaining to the approval of regulatory agencies; contractor's time required for submittals, fabrication and deliveries; the time required by County to review all submittals as set forth in the Contract Documents; items of work required of County to support pre-operational, startup and final testing; time required for the relocation of utilities. Activities shall also identify interface milestones with the work of other contractors performing work under separate contracts with County.
- D. Schedules shall show the complete sequence of construction by activities. Dates for beginning and completion of each activity shall be indicated as well as projected percentage of completion for each activity as of the first day of each month.
- E. Submittal schedule for shop drawing review, product data, and samples shall show the date of Contractor submittal and the date approved submittals will be required by the County, consistent with the time frames established in the Specifications.
- F. For Contract change orders granting time extensions, the impact on the Contract date(s) shall equal the calendar-day total time extension specified for the applicable work in the Contract change orders.
- G. For actual delays, add activities prior to each delayed activity on the appropriate critical path(s). Data on the added activities of this type shall portray all steps leading to the delay and shall further include the following: separate activity identification, activity description indicating cause of the delay, activity duration consistent with whichever set of dates below applies, the actual start and finish dates of the delay or, if the delay is not finished, the actual start date and estimated completion date.
- H. For potential delays, add an activity prior to each potentially delayed activity on the appropriate critical path(s). Data for added activities of this type shall include alternatives available to mitigate the delay including acceleration alternatives and further show the following: separate activity identification, activity description indicating cause of the potential delay and activity duration equal to zero work days.

2.04 SUPPORTING NARRATIVE

- A. Status and scheduling reports identified below shall contain a narrative to document the project status, to explain the basis of Contractor's determination of durations, describe the Contract conditions and restraints incorporated into the schedule and provide an analysis pertaining to potential problems and practical steps to mitigate them.
- B. The narrative shall specifically include:
 - 1. Actual completion dates for activities completed during the monthly report period and actual start dates for activities commenced during the monthly report period.
 - 2. Anticipated start dates for activities scheduled to commence during the following monthly report period.
 - 3. Changes in the duration of any activity and minor logic changes.
 - 4. The progress along the critical path in terms of days ahead or behind the Contract date.
 - 5. If the Monthly Status Report indicates an avoidable delay to the Contract completion date or interim completion dates as specified in the Agreement, Contractor shall identify the problem, cause and the activities affected and provide an explanation of the proposed corrective action to meet the milestone dates involved or to mitigate further delays.
 - 6. If the delay is thought to be unavoidable, the Contractor shall identify the problem, cause, duration, specific activities affected and restraints of each activity.
 - 7. The narrative shall also discuss all change order activities whether included or not in the revised/current schedule of legal status. Newly introduced change order work activities and the CPM path(s) that they affect, must be specifically identified. All change order work activities added to the schedule shall conform with the sequencing and Contract Time requirements of the applicable Change Order.
 - 8. Original Contract date(s) shall not be changed except by Contract change order. A revision need not be submitted when the foregoing situations arise unless required by County. Review of a report containing added activities will not be construed to be concurrence with the duration or restraints for such added activities; instead the corresponding data as ultimately incorporated into the applicable Contract change order shall govern.
 - 9. Should County require additional data, this information shall be supplied by Contractor within 10 calendar days.

2.05 SUBMITTALS

- A. Contractor shall submit estimated and preliminary progress schedules (as identified in the Terms and Conditions of the Contract and the General Conditions), monthly status reports, a start-up schedule and an as-built schedule report all as specified herein.
- B. All schedules, including estimated and preliminary schedules, shall be in conformance with the Contract Documents.
- C. The finalized progress schedule discussed in the Contract Documents shall be the first monthly status report and as such shall be in conformance with all applicable specifications contained herein.
- D. Monthly Status Report submittals shall include a time-scaled (days after notice to proceed) diagram showing all contract activities and supporting narrative. The initial detailed schedule shall use the notice to proceed as the start date. The finalized schedule, if

concurrent with by County, shall be the work plan to be used by the contractor for planning, scheduling, managing and executing the work.

- E. The schedule diagram shall be formatted as above. The diagram shall include (1) all detailed activities included in the preliminary and estimated schedule submittals, (2) calendar days prior to substantial completion, (3) summary activities for the remaining days. The critical path activities shall be identified, including critical paths for interim dates, if possible.
- F. The Contractor shall submit progress schedules with each application for payment.

2.06 MONTHLY STATUS REPORTS

- A. Contractor shall submit detailed schedule status reports on a monthly basis with the Application for Payment. The first such status report shall be submitted with the first Application for Payment and include data as of the last day of the pay period. The Monthly Report shall include a "marked-up" copy of the latest detailed schedule of legal status and a supporting narrative including updated information as described above. The Monthly Report will be reviewed by County and Contractor at a monthly schedule meeting and Contractor will address County's comments on the subsequent monthly report. Monthly status reports shall be the basis for evaluating Contractor's progress.
- B. The "marked-up" diagram shall show, for the latest detailed schedule of legal status, percentages of completion for all activities, actual start and finish dates and remaining durations, as appropriate. Activities not previously included in the latest detailed schedule of legal status shall be added, except that contractual dates will not be changed except by change order. Review of a marked-up diagram by County will not be construed to constitute concurrence with the time frames, duration, or sequencing for such added activities; instead the corresponding data as ultimately incorporated into an appropriate change order shall govern.

2.07 STARTUP SCHEDULE

- A. At least 60 calendar days prior to the date of substantial completion, Contractor shall submit a time-scaled (days after notice to proceed) diagram detailing the work to take place in the period between 60 days prior to substantial completion, together with a supporting narrative. County shall have 10 calendar days after receipt of the submittal to respond. Upon receipt of County's comments, Contractor shall make the necessary revisions and submit the revised schedule within 10 calendar days. The resubmittal, if concurred with by County, shall be the Work Plan to be used by Contractor for planning, managing, scheduling and executing the remaining work leading to substantial completion.
- B. The time-scaled diagram shall use the latest schedule of legal status for those activities completed ahead of the last 60 calendar days prior to substantial completion and detailed activities for the remaining 60-day period within the time frames outlined in the latest schedule of legal status.
- C. Contractor will be required to continue the requirement for monthly reports, as outlined above. In preparing this report, Contractor must assure that the schedule is consistent with the progress noted in the startup schedule.

2.08 REVISIONS

- A. All revised Schedule Submittals shall be made in the same form and detail as the initial submittal and shall be accompanied by an explanation of the reasons for such revisions, all of which shall be subject to review and concurrence by County. The revision shall incorporate all previously made changes to reflect current as-built conditions. Minor changes to the approved submittal may be approved at monthly meetings; a minor change is not considered a revision in the context of this paragraph.
- B. A revised schedule submittal shall be submitted for review when required by County.

PART 3 EXECUTION (NOT USED)

END OF SECTION

SECTION 01340 SHOP DRAWINGS, PROJECT DATA AND SAMPLES

PART 1 GENERAL

1.01 REQUIREMENTS INCLUDED

- A. The Contractor shall submit to the County for review and approval: working drawings, shop drawings, test reports and data on materials and equipment (hereinafter in this section called data) that have been produced within the last three (3) years, and material samples (hereinafter in this section called samples) as are required for the proper control of work, including, but not limited to those working drawings, shop drawings, data and samples for materials and equipment specified elsewhere in the Specifications and in the Contract Drawings. Submittals may be done electronically via PDF documents.
- B. The Contractor is to maintain an accurate updated submittal log and will bring this log to each scheduled progress meeting with the County. The County will provide the initial submittal log in electronic format. The electronic log (excel file) shall be passed back and forth between the Contractor and the County for each submittal package. This log shall include the following items:
1. Submittal description and number assigned.
 2. Date to County.
 3. Date returned to Contractor (from County).
 4. Status of Submittal (No exceptions taken, returned for confirmation or resubmittal, rejected).
 5. Date of Resubmittal and Return (as applicable).
 6. Date material released (for fabrication).
 7. Projected date of fabrication.
 8. Projected date of delivery to site.
 9. Projected date and required lead time so that product installation does not delay contact.
 10. Status of O&M manuals submitted.

1.03 CONTRACTOR'S RESPONSIBILITY

- A. It is the duty of the Contractor to check all drawings, data and samples prepared by or for him before submitting them to the County for review. Each and every copy of the Drawings and data shall bear Contractor's stamp showing that they have been so checked. Shop drawings submitted to the County without the Contractor's stamp will be returned to the Contractor for conformance with this requirement. Shop drawings shall indicate any deviations in the submittal from requirements of the contract Documents.
- B. The Contractor shall ensure that all submitted cut sheets, product sheets, product documentation, etc. are current versions of the product information and are not older than three (3) years. Product certification(s) shall be no older than three (3) years. Any submitted documents found to be beyond the acceptable date ranges shall be rejected.
- C. Determine and verify:
1. Field measurements.
 2. Field construction criteria.
 3. Catalog numbers and similar data.
 4. Conformance with Specifications and indicate all variances from the Specifications.

- D. The Contractor shall furnish the County a schedule of Shop Drawing submittals fixing the respective dates for the submission of shop and working drawings, the beginning of manufacture, testing and installation of materials, supplies and equipment. This schedule shall indicate those that are critical to the progress schedule.
- E. The Contractor shall not begin any of the work covered by a drawing, data, or a sample returned for correction until a revision or correction thereof has been reviewed and returned to him, by the County, with No Exceptions Taken or Approved As Noted.
- F. The Contractor shall submit to the County all drawings and schedules sufficiently in advance of construction requirements to provide no less than twenty-one (21) calendar days for checking and appropriate action from the time the County receives them. Submittals are to be scheduled, submitted, reviewed, and approved prior to the acquisition of the material or equipment. Coordinate scheduling, sequencing, preparing, and processing of submittals with performance of work so that work will not be delayed by submittal processing. Allow time for potential resubmittal.
- G. No delay costs or time extensions will be allowed for time lost in late submittals or resubmittals.
- H. All material & product submittals, other than samples, may be transmitted electronically as a pdf file. All returns to the contractor will be as a pdf file only unless specifically requested otherwise.
- I. The Contractor shall be responsible for and bear all cost of damages which may result from the ordering of any material or from proceeding with any part of work prior to the completion of the review by County of the necessary Shop Drawings.

1.04 COUNTY'S REVIEW OF SHOP DRAWINGS AND WORKING DRAWINGS

- A. The County's review of drawings, data and samples submitted by the Contractor shall cover only general conformity to the Specifications, external connections and dimensions which affect the installation.
- B. The review of drawings and schedules shall be general and shall not be construed:
 - 1. As permitting any departure from the Contract requirements.
 - 2. As relieving the Contractor of responsibility for any errors, including details, dimensions and materials.
 - 3. As approving departures from details furnished by the County, except as otherwise provided herein.
- C. If the drawings or schedules as submitted describe variations and show a departure from the Contract requirements which the County finds to be in the interest of the County and to be so minor as not to involve a change in Contract Price or time for performance, the County may return the reviewed drawings without noting any exception.
- D. When reviewed by the County, each of the Shop and Working Drawings shall be identified as having received such review being so stamped and dated. Shop Drawings stamped "REJECTED" and with required corrections shown shall be returned to the Contractor for correction and resubmittal.

- E. Resubmittals will be handled in the same manner as first submittals. On resubmittals, the Contractor shall direct specific attention, in writing or on resubmitted Shop Drawings, to revisions other than the corrections requested by the County on previous submissions. The Contractor shall make any corrections required by the County.
- F. If the Contractor considers any correction indicated on the drawings to constitute a change to the Contract Drawings or Specifications, the Contractor shall give written notice thereof to the County.
- G. The County shall review a submittal/resubmittal a maximum of three (3) times after which cost of review shall be borne by the Contractor. The cost of engineering shall be equal to the County's actual payroll cost.
- H. When the Shop and Working Drawings have been completed to the satisfaction of the County, the Contractor shall carry out the construction in accordance therewith and shall make no further changes therein except upon written instructions from the County.
- I. No partial submittals shall be reviewed. Incomplete submittals shall be returned to the Contractor and shall be considered not approved until resubmitted.

1.05 SHOP DRAWINGS

- A. When used in the Contract Documents, the term "Shop Drawings" shall be considered to mean Contractor's plans for material and equipment which become an integral part of the Project. These drawings shall be complete and detailed. Shop Drawings shall consist of fabrication, drawings, setting drawings, schedule drawings, manufacturer's scale drawings and wiring and control diagrams. Cuts, catalogs, pamphlets, descriptive literature and performance and test data, shall be considered only as supportive to required Shop Drawings as defined above.
- B. Drawings and schedules shall be checked and coordinated with the work of all trades involved, before they are submitted for review by the County and shall bear the Contractor's stamp of approval and original signature as evidence of such checking and coordination. Drawings or schedules submitted without this stamp of approval and original signature shall be returned to the Contractor for resubmission.
- C. Each Shop Drawing shall have a blank area 3-1/2 inches by 3-1/2 inches, located adjacent to the title block. The title block shall display the following:
 - 1. Number and title of the drawing.
 - 2. Date of Drawing or revision.
 - 3. Name of project building or facility.
 - 4. Name of contractor and subcontractor submitting drawing.
 - 5. Clear identification of contents and location of the work.
 - 6. Specification title and number.
- D. If drawings show variations from Contract requirements because of standard shop practice or for other reasons, the Contractor shall describe such variations in his letter of transmittal. If acceptable, proper adjustment in the contract shall be implemented where appropriate. If the Contractor fails to describe such variations, he shall not be relieved of the responsibility of executing the work in accordance with the Contract, even though such drawings have been reviewed.

- E. Data on materials and equipment shall include, without limitation, materials and equipment lists, catalog sheets, cuts, performance curves, diagrams, materials of construction and similar descriptive material. Materials and equipment lists shall give, for each item thereon, the name and location of the supplier or manufacturer, trade name, catalog reference, size, finish and all other pertinent data.
- F. For all mechanical and electrical equipment furnished, the Contractor shall provide a list including the equipment name and address and telephone number of the manufacturer's representative and service company so that service and/or spare parts can be readily obtained.
- G. All manufacturers or equipment suppliers who proposed to furnish equipment or products shall submit an installation list to the County along with the required shop drawings. The installation list shall include at least five installations where identical equipment has been installed and have been in operation for a period of at least one (1) year.
- H. Only the County will utilize the color "red" in marking shop drawing submittals.

1.06 SUBMITTAL PREPARATION

- A. Each submittal is to be complete and in sufficient detail to allow ready determination of compliance with contract requirements.
- B. Collect required data for each specific material, product, unit of work, or system into a single submittal. Prominently mark choices, options, and portions applicable to the submittal. Partial submittals will not be accepted for expedition of construction effort. Submittal will be returned without review if incomplete.
- C. If available product data is incomplete, provide Contractor-prepared documentation to supplement product data and satisfy submittal requirements.
- D. All irrelevant or unnecessary data shall be removed from the submittal to facilitate accuracy and timely processing. Submittals that contain the excessive amount of irrelevant or unnecessary data will be returned with review.
- E. Provide a transmittal form for each submittal with the following information:
 - 1. Project title, location and number.
 - 2. Construction contract number.
 - 3. Date of the drawings and revisions.
 - 4. Name, address, and telephone number of subcontractor, supplier, manufacturer, and any other subcontractor associated with the submittal.
 - 5. List paragraph number of the specification section and page number; and sheet number of the contract drawings by which the submittal is required.
 - 6. When a resubmission, the resubmittal document name shall remain the same, but shall add an alphabetic suffix on submittal description. For example, submittal 18 would become 18A, to indicate resubmission.
 - 7. Product identification and location in project.
- F. The Contractor is responsible for reviewing and certifying that all submittals are in compliance with contract requirements before submitting to the County for review.
- G. Stamp, sign, and date each submittal transmittal form indicating action taken.

- H. Stamp used by the Contractor on the submittal transmittal form to certify that the submittal meets contract requirements is to be similar to the following:

| |
|---|
| <p>CONTRACTOR (Firm Name)</p> <p>____ Approved</p> <p>____ Approved with corrections as noted on submittal data and/or attached sheet(s).</p> <p>I certify that the following document and information has been verified to be is not more than three (3) years old.</p> <p>SIGNATURE: _____</p> <p>TITLE: _____</p> <p>DATE: _____</p> |
|---|

1.07 WORKING DRAWINGS

- A. When used in the Contract Documents, the term "working drawings" shall be considered to mean the Contractor's fabrication and erection drawings for structures such as roof trusses, steelwork, precast concrete elements, bulkheads, support of open cut excavation, support of utilities, groundwater control systems, forming and false work; underpinning; and for such other work as may be required for construction of the project.
- B. Copies of working drawings as noted above, shall be submitted to the County where required by the Contract Documents or requested by the County and shall be submitted at least thirty (30) days (unless otherwise specified by the County) in advance of their being required for work.
- C. Working drawings shall be signed by a registered Professional Engineer, currently licensed to practice in the State of Florida and shall convey, or be accompanied by, calculation or other sufficient information to completely explain the structure, machine, or system described and its intended manner of use. Prior to commencing such work, working drawings must have been reviewed without specific exceptions by the County, which review will be for general conformance and will not relieve the Contractor in any way from his responsibility with regard to the fulfillment of the terms of the Contract. All risks of error are assumed by the Contractor; the County and Engineer shall not have responsibility therefor.

1.08 SAMPLES

- A. The Contractor shall furnish, for the review of the County, samples required by the Contract Documents or requested by the County. Samples shall be delivered to the County as specified or directed. The Contractor shall prepay all shipping charges on samples. Materials or equipment for which samples are required shall not be used in work until reviewed by the County.
- B. Samples shall be of sufficient size and quantity to clearly illustrate:
 - 1. Functional characteristics of the product, with integrally related parts and attachment devices.

2. Full range of color, texture and pattern.
 3. A minimum of two samples of each item shall be submitted.
- C. Each sample shall have a label indicating:
1. Name of product.
 2. Name of Contractor and Subcontractor.
 3. Material or equipment represented.
 4. Place of origin.
 5. Name of Producer and Brand (if any).
 6. Location in project.
(Samples of finished materials shall have additional markings that will identify them under the finished schedules.)
 7. Reference specification paragraph.
- D. The Contractor shall prepare a transmittal letter in triplicate for each shipment of samples containing the information required above. He shall enclose a copy of this letter with the shipment and send a copy of this letter to the County. Review of a sample shall be only for the characteristics or use named in such and shall not be construed to change or modify any Contract requirements.
- E. Reviewed samples not destroyed in testing shall be sent to the County or stored at the site of the work. Reviewed samples of the hardware in good condition will be marked for identification and may be used in the work. Materials and equipment incorporated in work shall match the reviewed samples. If requested at the time of submission, samples which failed testing or were rejected shall be returned to the Contractor at his expense.

1.09 APPROVED SUBMITTALS

- A. County approval of submittals is not to be construed as a complete check, and indicates only that the general method of construction, materials, detailing, and other information are satisfactory.
- B. County approval of a submittal does not relieve the Contractor of the responsibility for any error which may exist. The Contractor is responsible for fully complying with all contract requirements and the satisfactory construction of all work, including the need to check, confirm, and coordinate the work of all subcontractors for the project. Non-compliant material incorporated in the work will be removed and replaced at the Contractor's expense.
- C. After submittals have been approved, no resubmittal for the purpose of substituting materials or equipment will be considered unless accompanied by an explanation of why a substitution is necessary.
- D. Retain a copy of all approved submittals at project site, including approved samples.

PART 2 PRODUCTS (NOT USED)

PART 3 EXECUTION (NOT USED)

END OF SECTION

SECTION 01370 SCHEDULE OF VALUES

PART 1 GENERAL

1.01 REQUIREMENTS INCLUDED

- A. The Contractor shall submit to the County a Schedule of Values allocated to the various portions of the work, within 10 days after date of Notice to Proceed.
- B. Upon request of the County, the Contractor shall support the values with data which will substantiate their correctness.
- C. The Schedule of Values shall be used only as the basis for the Contractor's Applications for Payment.

1.02 FORM AND CONTENT OF SCHEDULE OF VALUES

- A. Schedule of Values will be considered for approval by County upon Contractor's request. Identify schedule with:
 - 1. Title of Project and location.
 - 2. Project number.
 - 3. Name and address of Contractor.
 - 4. Contract designation.
 - 5. Date of submission.
- B. Schedule of Values shall list the installed value of the component parts of the work in sufficient detail to serve as a basis for computing values for progress payments during construction.
- C. Follow the table of contents for the Contract Document as the format for listing component items for structures:
 - 1. Identify each line item with the number and title of the respective major section of the specification.
 - 2. For each line item, list sub values of major products or operations under item.
- D. Follow the bid sheets included in this Contract Documents as the format for listing component items for pipe lines.
- E. The sum of all values listed in the schedule shall equal the total Contract sum.

PART 2 PRODUCTS (NOT USED)

PART 3 EXECUTION (NOT USED)

END OF SECTION

SECTION 01380 CONSTRUCTION PHOTOGRAPHS

PART 1 GENERAL

1.01 REQUIREMENTS INCLUDED

- A. The Contractor shall employ a competent photographer to take construction record photographs or perform video, recording including furnishing all labor, materials, equipment and incidentals necessary to obtain photographs and/or video recordings of all construction areas.
- B. Preconstruction record information shall consist of video recordings on digital video disks (DVD).
- C. Construction progress information shall consist of photographs and digital photographs on a recordable compact disc (CD-R).

1.02 QUALIFICATIONS

- A. All photography shall be done by a competent camera operator who is fully experienced and qualified with the specified equipment.
- B. For the video recording, the audio portion should be done by a person qualified and knowledgeable in the specifics of the Contract, who shall speak with clarity and diction so as to be easily understood.

1.03 PROJECT PHOTOGRAPHS

- A. Provide one print of each photograph with each pay application.
- B. Provide one recordable compact disc with digital photographs with each pay application.
- C. Negatives:
 - 1. All negatives shall remain the property of photographer.
 - 2. The Contractor shall require that photographer maintain negatives or protected digital files for a period of two years from date of substantial completion of the project.
 - 3. Photographer shall agree to furnish additional prints to County at commercial rates applicable at time of purchase. Photographer shall also agree to participate as required in any litigation requiring the photographer as an expert witness.
- D. The Contractor shall pay all costs associated with the required photography and prints. Any parties requiring additional photography or prints shall pay the photographer directly.
- E. All project photographs shall be a single weight, color image. All finishes shall be smooth surface and glossy and all prints shall be 8 inches x 10 inches.
- F. Each print shall have clearly marked on the back, the name of the project, the orientation of view, the date and time of exposure, name and address of the photographer and the photographers numbered identification of exposure.
- G. All project photographs shall be taken from locations to adequately illustrate conditions prior

to construction, or conditions of construction and state of progress. The Contractor shall consult with the County at each period of photography for instructions concerning views required.

1.04 VIDEO RECORDINGS

- A. Video recording shall be done along all routes that are scheduled for construction. Video recording shall include full, recording of both sides of all streets and the entire width of easements plus 10 feet on each side on which construction is to be performed. All video recording shall be in full color.
- B. A complete view, in sufficient detail with audio description of the exact location shall be provided.
- C. The engineering plans shall be used as a reference for stationing in the audio portion of the recordings for easy location identification.
- D. Two complete sets of video recordings shall be delivered to the County on digital video disks (DVD) for the permanent and exclusive use of the County prior to the start of any construction on the project.
- E. All video recordings shall contain the name of the project, the date and time of the video recording, the name and address of the photographer and any other identifying information required.
- F. Construction shall not start until preconstruction video recordings are completed, submitted and accepted by the County. In addition, no progress payments shall be made until the preconstruction video recordings are accepted by the County.

PART 2 PRODUCTS (NOT USED)

PART 3 EXECUTION (NOT USED)

END OF SECTION

SECTION 01410 TESTING AND TESTING LABORATORY SERVICES

PART 1 GENERAL

1.01 REQUIREMENTS INCLUDED

- A. County shall employ and pay for the services of an independent testing laboratory to perform testing specifically indicated on the Contract Documents or called out in the Specifications. County may elect to have materials and equipment tested for conformity with the Contract Documents at any time.
1. Contractor shall cooperate fully with the laboratory to facilitate the execution of its required services.
 2. Employment of the laboratory shall in no way relieve the Contractor's obligations to perform the work of the Contract.

1.02 LIMITATIONS OF AUTHORITY OF TESTING LABORATORY

- A. Laboratory is not authorized to:
1. Release, revoke, alter or enlarge on requirements of Contract Documents.
 2. Approve or accept any portion of the Work.
 3. Perform any duties of the Contractor.

1.03 CONTRACTOR'S RESPONSIBILITIES

- A. Cooperate with laboratory personnel; provide access to Work and/or to Manufacturer's operations.
- B. Secure and deliver to the laboratory adequate quantities of representational samples of materials proposed to be used and which require testing.
- C. Provide to the laboratory the preliminary design mix proposed to be used for concrete, and other material mixes which require control by the testing laboratory.
- D. Materials and equipment used in the performance of work under this Contract are subject to inspection and testing at the point of manufacture or fabrication. Standard specifications for quality and workmanship are indicated in the Contract Documents. The County may require the Contractor to provide statements or certificates from the manufacturers and fabricators that the materials and equipment provided by them are manufactured or fabricated in full accordance with the standard specifications for quality and workmanship indicated in the Contract Documents. All costs of this testing and providing statements and certificates shall be a subsidiary obligation of the Contractor and no extra charge to the County shall be allowed on account of such testing and certification.
- E. Furnish incidental labor and facilities:
1. To provide access to work to be tested.
 2. To obtain and handle samples at the project site or at the source of the product to be tested.
 3. To facilitate inspections and tests.
 4. For storage and curing of test samples.

- F. Notify laboratory sufficiently in advance of operations to allow for laboratory assignment of personnel and scheduling of tests.
 - 1. When tests or inspections cannot be performed due to insufficient notice, Contractor shall reimburse County for laboratory personnel and travel expenses incurred due to Contractor's negligence.
- G. Employ and pay for the services of the same or a separate, equally qualified independent testing laboratory to perform additional inspections, sampling and testing required for the Contractor's convenience and as approved by the County.
- H. If the test results indicate the material or equipment complies with the Contract Documents, the County shall pay for the cost of the testing laboratory. If the tests and any subsequent retests indicate the materials and equipment fail to meet the requirements of the Contract Documents, the contractor shall pay for the laboratory costs directly to the testing firm or the total of such costs shall be deducted from any payments due the Contractor.

PART 2 PRODUCTS (NOT USED)

PART 3 EXECUTION (NOT USED)

END OF SECTION

SECTION 01510 TEMPORARY AND PERMANENT UTILITIES

PART 1 GENERAL

1.01 REQUIREMENTS INCLUDED

The Contractor shall be responsible for furnishing all requisite temporary utilities, i.e., power, water, sanitation, etc. The Contractor shall obtain and pay for all permits required as well as pay for all temporary usages. The Contractor shall remove all temporary facilities upon completion of work.

1.02 REQUIREMENTS OF REGULATORY AGENCIES

- A. Comply with National Electric Code.
- B. Comply with Federal, State and Local codes and regulations and with utility company requirements.
- C. Comply with County Health Department regulations.

PART 2 PRODUCTS

2.01 MATERIALS, GENERAL

Materials for temporary utilities may be "used". Materials for electrical utilities shall be adequate in capacity for the required usage, shall not create unsafe conditions and shall not violate requirements of applicable codes and standards.

2.02 TEMPORARY ELECTRICITY AND LIGHTING

Arrange with the applicable utility company for temporary power supply. Provide service required for temporary power and lighting and pay all costs for permits, service and for power used.

2.03 TEMPORARY WATER

- A. The Contractor shall arrange with Manatee County Utilities Customer Service office to provide water for construction purposes, i.e., meter, pay all costs for installation, maintenance and removal, and service charges for water used.
- B. The Contractor shall protect piping and fitting against freezing.

2.04 TEMPORARY SANITARY FACILITIES

- A. The Contractor shall provide sanitary facilities in compliance with all laws and regulations.
- B. The Contractor shall service, clean and maintain facilities and enclosures.

PART 3 EXECUTION

3.01 GENERAL

- A. The Contractor shall maintain and operate systems to assure continuous service.

- B. The Contractor shall modify and extend systems as work progress requires.

3.02 REMOVAL

- A. The Contractor shall completely remove temporary materials and equipment when their use is no longer required.
- B. The Contractor shall clean and repair damage caused by temporary installations or use of temporary facilities.

END OF SECTION

SECTION 01570 TRAFFIC REGULATION

PART 1 GENERAL

1.01 REQUIREMENTS INCLUDED

- A. The Contractor shall be responsible for providing safe and expeditious movement of traffic through construction zones. A construction zone is defined as the immediate areas of actual construction and all abutting areas which are used by the Contractor and which interfere with the driving or walking public.
- B. The Contractor shall remove temporary equipment and facilities when no longer required, restore grounds to original or to specified conditions.

1.02 TRAFFIC CONTROL

- A. The necessary traffic control shall include, but not be limited to, such items as proper construction warning signs, signals, lighting devices, markings, barricades, channelization and hand signaling devices. The Contractor shall be responsible for installation and maintenance of all devices and detour routes and signage for the duration of the construction period. The Contractor shall utilize the appropriate traffic plan from the FDOT Maintenance of Traffic Standards, Series 600 of the FDOT Roadway & Traffic Design Standards, Latest Edition.
- B. Should there be the necessity to close any portion of a roadway carrying vehicles or pedestrians the Contractor shall submit a Traffic Control Plan (TCP) at least 5 days before a partial or full day closure, and at least 8 days before a multi-day closure. TCP shall be submitted, along with a copy of their accreditation, by a certified IMSA or ATSA Traffic Control Specialist.
 - 1. At no time will more than one (1) lane of a roadway be closed to vehicles and pedestrians without an approved road closure from the County Transportation Department. With any such closings, adequate provision shall be made for the safe expeditious movement of each.
 - 2. All traffic control signs must be in place and inspected at least 1 day in advance of the closure. Multi-day closures notification signs shall be in place at least 3 days in advance of the closure. All signs must be covered when no in effect, and checked twice a day by the Worksite Traffic Supervisor when they are in effect.
- C. The Contractor shall be responsible for removal, relocation, or replacement of any traffic control device in the construction area which exists as part of the normal preconstruction traffic control scheme. Any such actions shall be performed by the Contractor under the supervision and in accordance with the instructions of the applicable highway department unless otherwise specified.
- D. The Contractor will consult with the County immediately on any vehicular or pedestrian safety or efficiency problem incurred as a result of construction of the project.
- E. The Contractor shall provide ready access to businesses and homes in the project area during construction. The Contractor shall be responsible for coordinating this work with affected homeowners.
- F. When conditions require the temporary installation of signs, pavement markings and traffic

barriers for the protection of workers and traffic, the entire array of such devices shall be depicted on working drawings for each separate stage of work. These drawings shall be submitted to the County for review and approval prior to commencement of work on the site.

- G. Precast concrete traffic barriers shall be placed adjacent to trenches and other excavations deeper than six inches below the adjacent pavement surface.

PART 2 PRODUCTS (NOT USED)

PART 3 EXECUTION (NOT USED)

END OF SECTION

SECTION 01580 PROJECT IDENTIFICATION AND SIGNS

PART 1 GENERAL

1.01 REQUIREMENTS INCLUDED

- A. Furnish, install and maintain County project identification signs.
- B. Remove signs on completion of construction.
- C. Allow no other signs to be displayed except for traffic control and safety.

1.02 PROJECT IDENTIFICATION SIGN (COUNTY)

- A. Two painted sign, of not less than 32 square feet (3 square meters) area, with painted graphic content to include:
 - 1. Title of Project.
 - 2. Name of County.
 - 3. Names and titles of authorities as directed by County.
 - 4. Prime Contractor.
- B. Graphic design, style of lettering and colors: As approved by the County.
- C. Erect on the site at a lighted location of high public visibility, adjacent to main entrance to site, as approved by the County

1.03 INFORMATIONAL SIGNS

- A. Painted signs with painted lettering, or standard products.
 - 1. Size of signs and lettering: as required by regulatory agencies, or as appropriate to usage.
 - 2. Colors: as required by regulatory agencies, otherwise of uniform colors throughout project.
- B. Erect at appropriate locations to provide required information.

1.04 QUALITY ASSURANCE

- A. Sign Painter: Professional experience in type of work required.
- B. Finishes, Painting: Adequate to resist weathering and fading for scheduled construction period.

1.05 PUBLIC NOTIFICATION

- A. Door Hangers: The Contractor shall generate and distribute door hangers to all residents who will be impacted by project construction.
 - 1. Residents impacted include anyone who resides inside, or within 500 feet of project limits of construction.

3.01 PROJECT IDENTIFICATION SIGN

- A. Paint exposed surface or supports, framing and surface material; one coat of primer and one coat of exterior paint.
- B. Paint graphics in styles, size and colors selected.

3.02 MAINTENANCE

The Contractor shall maintain signs and supports in a neat, clean condition; repair damages to structures, framing or sign.

3.03 REMOVAL

The Contractor shall remove signs, framing, supports and foundations at completion of project.

END OF SECTION

SECTION 01590 COUNTY'S FIELD OFFICE

PART 1 GENERAL

1.01 REQUIREMENTS INCLUDED

Contractor shall furnish, install and maintain one temporary field office during the entire construction period for the sole use of the County.

1.02 OTHER REQUIREMENTS

- A. Prior to installation of the County's field office, the Contractor shall consult with the County on location, access and related facilities.
- B. All site use approvals shall be obtained by the Contractor.
- C. Upon completion of construction, the Contractor shall remove the field office and restore the site to its original condition.

1.03 REQUIREMENTS FOR FACILITIES

- A. Construction:
 - 1. The field office shall be structurally sound, weather tight, with floors raised aboveground.
 - 2. At Contractor's option, portable or mobile buildings may be used.
- B. Office for Field Engineer:
 - 1. A separate office for sole use of the County with secure entrance doors, key and lock shall be provided.
 - 2. Area: 250 sq. ft. minimum, with minimum dimension of 8 feet.
 - 3. Windows:
 - a. Minimum of three (3).
 - b. Operable sash and insect screens.
 - c. Locate field office to provide maximum view of construction areas.
 - 4. Furnishings:
 - a. Two standard size chairs and desks with three drawers each.
 - b. One drafting table: 39"x72"x36" high, with one equipment drawer.
 - c. One metal, double-door storage cabinet with lock and key.
 - d. One plan rack to hold a minimum of six sets of project drawings.
 - e. One standard four-drawer legal-size metal filing cabinet with lock and key.
 - f. Six linear feet of bookshelves.
 - g. One swivel arm chair.
 - h. Two straight chairs.
 - i. One drafting table stool.
 - j. One waste basket.
 - k. One tackboard, 36"x30".
 - l. One fire extinguisher.
 - m. One first aid kit.
 - 5. Services:
 - a. Adequate lighting.
 - b. Exterior lighting at entrance door.

- c. Automatic heating and mechanical cooling equipment to maintain comfort conditions.
- d. Minimum of four 110 volt duplex electric convenience outlets, at least one on each wall.
- e. Electric distribution panel: Two circuits minimum 110 volt, 60 hertz service.
- f. Convenient access to drinking water and toilet facilities.
- g. Telephone: One private direct line instrument.
- h. Fax: combination fax/duplicator.

PART 2 PRODUCTS

2.01 MATERIALS, EQUIPMENT, FURNISHINGS

May be new or used, but must be serviceable, adequate for required purpose and must adhere to all applicable codes or regulations including the Manatee County Building Codes.

PART 3 EXECUTION

3.01 PREPARATION

Fill and grade site as necessary for temporary structure to provide positive surface drainage.

3.02 INSTALLATION

- A. Construct temporary field office on proper foundation and provide connections for all utility services.
 - 1. Secure portable or mobile building when used.
 - 2. Provide steps and landings at entrance doors.

END OF SECTION

SECTION 01600 MATERIAL AND EQUIPMENT

PART 1 GENERAL

1.01 REQUIREMENTS INCLUDED

- A. Material and equipment incorporated into the work:
1. Conform to applicable specifications and standards.
 2. Comply with size, make, type and quality specified, or as specifically approved in writing by the County.
 3. Manufactured and Fabricated Products:
 - a. Design, fabricate and assemble in accordance with the best engineering and shop practices.
 - b. Manufacture like parts of duplicate units to standard sizes and gages, to be interchangeable.
 - c. Two or more items of the same kind shall be identical and manufactured by the same manufacturer.
 - d. Products shall be suitable for service conditions.
 - e. Equipment capacities, sizes and dimensions shown or specified shall be adhered to unless variations are specifically approved in writing.
 4. Do not use material or equipment for any purpose other than that for which it is specified.
 5. All material and equipment incorporated into the project shall be new.

1.02 MANUFACTURER'S INSTRUCTIONS

- A. When Contract Documents require that installation of work shall comply with manufacturer's printed instructions, obtain and distribute copies of such instructions to parties involved in the installation, including two copies to County. Maintain one set of complete instructions at the job site during installation and until completion.
- B. Handle, install, connect, clean, condition and adjust products in strict accordance with such instructions and in conformity with specified requirements. Should job conditions or specified requirements conflict with manufacturer's instructions, consult with County prior to proceeding. Do not proceed with work without clear instructions.

1.03 TRANSPORTATION AND HANDLING

- A. Arrange deliveries of products in accordance with construction schedules, coordinate to avoid conflict with work and conditions at the site.
1. Deliver products in undamaged condition, in manufacturer's original containers or packaging, with identifying labels intact and legible.
 2. Immediately on delivery, inspect shipments to assure compliance with requirements of Contract Documents and approved submittals and that products are properly protected and undamaged.
- B. Provide equipment and personnel to handle products by methods to prevent soiling or damage to products or packaging.

1.04 SUBSTITUTIONS AND PRODUCT OPTIONS

Contractor's Options:

1. For products specified only by reference standard, select any product meeting that standard.
2. For products specified by naming one or more products or manufacturers and "or equal", Contractor must submit a request for substitutions of any product or manufacturer not specifically named in a timely manner so as not to adversely affect the construction schedule.

PART 2 PRODUCTS (NOT USED)

PART 3 EXECUTION (NOT USED)

END OF SECTION

SECTION 01620 STORAGE AND PROTECTION

PART 1 GENERAL

1.01 REQUIREMENTS INCLUDED

Provide secure storage and protection for products to be incorporated into the work and maintenance and protection for products after installation and until completion of Work.

1.02 STORAGE

- A. Store products immediately on delivery and protect until installed in the Work, in accord with manufacturer's instructions, with seals and labels intact and legible.
- B. Exterior Storage
 - 1. Provide substantial platform, blocking or skids to support fabricated products above ground to prevent soiling or staining.
 - a. Cover products, subject to discoloration or deterioration from exposure to the elements, with impervious sheet coverings. Provide adequate ventilation to avoid condensation.
 - b. Prevent mixing of refuse or chemically injurious materials or liquids.
- C. Arrange storage in manner to provide easy access for inspection.

1.03 MAINTENANCE OF STORAGE

- A. Maintain periodic system of inspection of stored products on scheduled basis to assure that:
 - 1. State of storage facilities is adequate to provide required conditions.
 - 2. Required environmental conditions are maintained on continuing basis.
 - 3. Surfaces of products exposed to elements are not adversely affected. Any weathering of products, coatings and finishes is not acceptable under requirements of these Contract Documents.
- B. Mechanical and electrical equipment which requires servicing during long term storage shall have complete manufacturer's instructions for servicing accompanying each item, with notice of enclosed instructions shown on exterior of package.
 - 1. Equipment shall not be shipped until approved by the County. The intent of this requirement is to reduce on-site storage time prior to installation and/or operation. Under no circumstances shall equipment be delivered to the site more than one month prior to installation without written authorization from the County.
 - 2. All equipment having moving parts such as gears, electric motors, etc. and/or instruments shall be stored in a temperature and humidity controlled building approved by the County until such time as the equipment is to be installed.
 - 3. All equipment shall be stored fully lubricated with oil, grease, etc. unless otherwise instructed by the manufacturer.
 - 4. Moving parts shall be rotated a minimum of once weekly to insure proper lubrication and to avoid metal-to-metal "welding". Upon installation of the equipment, the Contractor shall start the equipment, at least half load, once weekly for an adequate period of time to insure that the equipment does not deteriorate from lack of use.
 - 5. Lubricants shall be changed upon completion of installation and as frequently as

- required, thereafter during the period between installation and acceptance.
6. Prior to acceptance of the equipment, the Contractor shall have the manufacturer inspect the equipment and certify that its condition has not been detrimentally affected by the long storage period. Such certifications by the manufacturer shall be deemed to mean that the equipment is judged by the manufacturer to be in a condition equal to that of equipment that has been shipped, installed, tested and accepted in a minimum time period. As such, the manufacturer will guaranty the equipment equally in both instances. If such a certification is not given, the equipment shall be judged to be defective. It shall be removed and replaced at the Contractor's expense.

1.04 PROTECTION AFTER INSTALLATION

- A. Provide protection of installed products to prevent damage from subsequent operations. Remove when no longer needed, prior to completion of work.
- B. Control traffic to prevent damage to equipment and surfaces.
- C. Provide coverings to protect finished surfaces from damage.

PART 2 PRODUCTS (NOT USED)

PART 3 EXECUTION (NOT USED)

END OF SECTION

SECTION 01700 CONTRACT CLOSEOUT

PART 1 GENERAL

1.01 REQUIREMENTS INCLUDED

Comply with requirements stated in Conditions of the Contract and in Specifications for administrative procedures in closing out the work.

1.02 SUBSTANTIAL COMPLETION

- A. The Contractor shall submit the following items when the Contractor considers the work to be substantially complete:
 - 1. A written notice that the work, or designated portion thereof, is substantially complete.
 - 2. A list of items to be completed or corrected.
- B. Within a reasonable time after receipt of such notice, the County shall make an inspection to determine the status of completion.
- C. Project record documents and operations and maintenance manuals must be submitted before the project shall be considered substantially complete.
- D. If the County determines that the work is not substantially complete:
 - 1. The County shall notify the Contractor in writing, stating the reasons.
 - 2. The Contractor shall remedy the deficiencies in the work and send a second written notice of substantial completion to the County.
 - 3. The County shall reinspect the work.
- E. When the County finds that the work is substantially complete:
 - 1. The Engineer shall prepare and deliver to the County a tentative Certificate of Substantial Completion (Manatee County Project Management Form PMD-8) with a tentative list of the items to be completed or corrected before final payment.
 - 2. The Engineer shall consider any objections made by the County as provided in Conditions of the Contract. When the Engineer considers the work substantially complete, he will execute and deliver to the County a definite Certificate of Substantial Completion (Manatee County Project Management Form PMD-8) with a revised tentative list of items to be completed or corrected.

1.03 FINAL INSPECTION

- A. When the Contractor considered the work to be complete, he shall submit written certification stating that:
 - 1. The Contract Documents have been reviewed.
 - 2. The work has been inspected for compliance with Contract Documents.
 - 3. The work has been completed in accordance with Contract Documents.
 - 4. The equipment and systems have been tested in the presence of the County's representative and are operational.
 - 5. The work is completed and ready for final inspection.

- B. The County shall make an inspection to verify the status of completion after receipt of such certification.
- C. If the County determines that the work is incomplete or defective:
 - 1. The County shall promptly notify the Contractor in writing, listing the incomplete or defective work.
 - 2. The Contractor shall take immediate steps to remedy the stated deficiencies and send a second written certification to County that the work is complete.
 - 3. The County shall reinspect the work.
- D. Upon finding the work to be acceptable under the Contract Documents, the County shall request the Contractor to make closeout submittals.
- E. For each additional inspection beyond a total of three (3) inspections for substantial and final completion due to the incompleteness of the work, the Contractor shall reimburse the County's fees.

1.04 CONTRACTOR'S CLOSEOUT SUBMITTALS TO COUNTY

- A. Project Record Documents (prior to substantial completion).
- B. Operation and maintenance manuals (prior to substantial completion).
- C. Warranties and Bonds.
- D. Evidence of Payment and Release of Liens: In accordance with requirements of General and Supplementary Conditions.
- E. Certification letter from Florida Department of Transportation and Manatee County Department of Transportation, as applicable.
- F. Certificate of Insurance for Products and Completed Operations.
- G. Final Reconciliation, Warranty Period Declaration, and Contractor's Affidavit (Manatee County Project Management Form PMD-9).

1.05 FINAL ADJUSTMENT OF ACCOUNTS

- A. Submit a final statement of accounting to the County.
- B. Statement shall reflect all adjustments to the Contract Sum:
 - 1. The original Contract Sum.
 - 2. Additions and deductions resulting from:
 - a. Previous Change Orders
 - b. Unit Prices
 - c. Penalties and Bonuses
 - d. Deductions for Liquidated Damages
 - e. Other Adjustments
 - 3. Total Contract Sum, as adjusted.
 - 4. Previous payments.

5. Sum remaining due.

- C. Project Management shall prepare a final Change Order, reflecting approved adjustments to the Contract Sum which were not previously made by Change Orders.

1.06 FINAL APPLICATION FOR PAYMENT

Contractor shall submit the final Application for Payment in accordance with procedures and requirements stated in the Conditions of the Contract.

PART 2 PRODUCTS (NOT USED)

PART 3 EXECUTION (NOT USED)

END OF SECTION

SECTION 01710 CLEANING

PART 1 GENERAL

1.01 REQUIREMENTS INCLUDED

Execute cleaning during progress of the work and at completion of the work, as required by the General Conditions.

1.02 DISPOSAL REQUIREMENTS

Conduct cleaning and disposal operations to comply with all Federal, State and Local codes, ordinances, regulations and anti-pollution laws.

PART 2 PRODUCTS

2.01 MATERIALS

- A. Use only those cleaning materials which will not create hazards to health or property and which will not damage surfaces.
- B. Use only those cleaning materials and methods recommended by manufacturer of the surface material to be cleaned.
- C. Use cleaning materials only on surfaces recommended by cleaning material manufacturer.

PART 3 EXECUTION

3.01 DURING CONSTRUCTION

- A. Execute periodic cleaning to keep the work, the site and adjacent properties free from accumulation of waste materials, rubbish and wind-blown debris, resulting from construction operations.
- B. Provide on-site containers for the collection of waste materials, debris and rubbish.
- C. Remove waste materials, debris and rubbish from the site periodically and dispose of at legal disposal areas away from the site.

3.02 DUST CONTROL

- A. Clean interior spaces prior to the start of finish painting and continue cleaning on an as-needed basis until painting is finished.
- B. Schedule operations so that dust and other contaminants resulting from cleaning process will not fall on wet or newly-coated surfaces.

3.03 FINAL CLEANING

- A. Employ skilled workmen for final cleaning.
- B. Broom clean exterior paved surfaces; rake clean other surfaces of the grounds.

- C. Prior to final completion or County occupancy, Contractor shall conduct an inspection of sight-exposed interior and exterior surfaces and all work areas to verify that the entire work is clean.

END OF SECTION

SECTION 01720 PROJECT RECORD DOCUMENTS

PART 1 STANDARDS

1.01 MINIMUM RECORD DRAWING STANDARDS FOR ALL RECORD DRAWINGS SUBMITTED TO MANATEE COUNTY

- A. Record drawings shall be submitted to at least the level of detail in the contract documents. It is anticipated that the original contract documents shall serve as at least a background for all record information. Original drawings in CAD format may be requested of the County.
- B. Drawings shall meet the criteria of paragraph 2.04 D above and as mentioned in Section 1.14 Record Drawings in the Manatee County Public Works Standards, Part I Utilities Standards Manual approved June 2015.

PART 2 STANDARDS

2.01 REQUIREMENTS INCLUDED

- A. Contractor shall maintain at the site for the County one record copy of:
 - 1. Drawings.
 - 2. Specifications.
 - 3. Addenda.
 - 4. Change Orders and other modifications to the Contract.
 - 5. County's field orders or written instructions.
 - 6. Approved shop drawings, working drawings and samples.
 - 7. Field test records.
 - 8. Construction photographs.

2.02 MAINTENANCE OF DOCUMENTS AND SAMPLES

- A. Store documents and samples in Contractor's field office apart from documents used for construction.
 - 1. Provide files and racks for storage of documents.
 - 2. Provide locked cabinet or secure storage space for storage of samples.
- B. File documents and samples in accordance with CSI format.
- C. Maintain documents in a clean, dry, legible, condition and in good order. Do not use record documents for construction purposes.
- D. Make documents and samples available at all times for inspection by the County.

2.03 MARKING DEVICES

- A. Provide felt tip marking pens for recording information in the color code designated by the County.

2.04 RECORDING DRAWINGS PREPARATION

- A. Record information concurrently with construction progress.

- B. Do not conceal any work until required information is recorded.
- C. Drawings; Legibly mark to record actual construction:
1. All underground piping with elevations and dimensions. Changes to piping location. Horizontal and vertical locations of underground utilities and appurtenances, referenced to permanent surface improvements. Actual installed pipe material, class, etc. Locations of drainage ditches, swales, water lines and force mains shall be shown every 200 feet (measured along the centerline) or alternate lot lines, whichever is closer. Dimensions at these locations shall indicate distance from centerline of right-of-way to the facility.
 2. Field changes of dimension and detail.
 3. Changes made by Field Order or by Change Order.
 4. Details not on original contract drawings.
 5. Equipment and piping relocations.
 6. Locations of all valves, fire hydrants, manholes, water and sewer services, water and force main fittings, underdrain cleanouts, catch basins, junction boxes and any other structures located in the right-of-way or easement, shall be located by elevation and by station and offset based on intersection P.I.'s and centerline of right-of-way. For facilities located on private roads, the dimensioning shall be from centerline of paving or another readily visible baseline.
 7. Elevations shall be provided for all manhole rim and inverts; junction box rim and inverts; catch basin rim and inverts; and baffle, weir and invert elevations in control structures. Elevations shall also be provided at the PVI's and at every other lot line or 200 feet, whichever is less, of drainage swales and ditches. Bench marks and elevation datum shall be indicated.
 8. Slopes for pipes and ditches shall be recalculated, based on actual field measured distances, elevations, pipe sizes, and type shown. Cross section of drainage ditches and swales shall be verified.
 9. Centerline of roads shall be tied to right-of-way lines. Elevation of roadway centerline shall be given at PVI's and at all intersections.
 10. Record drawings shall show bearings and distances for all right-of-way and easement lines, and property corners.
 11. Sidewalks, fences and walls, if installed at the time of initial record drawing submittal, shall be located every 200 feet or alternate lot lines, whichever is closer. Dimensions shall include distance from the right-of-way line and the back of curb and lot line or easement line.
 12. Sanitary sewer mainline wyes shall be located from the downstream manhole. These dimensions shall be provided by on-site inspections or televising of the sewer following installation.
 13. Elevations shall be provided on the top of operating nuts for all water and force main valves.
 14. Allowable tolerance shall be ± 6.0 inches for horizontal dimensions. Vertical dimensions such as the difference in elevations between manhole inverts shall have an allowable tolerance of $\pm 1/8$ inch per 50 feet (or part thereof) of horizontal distance up to a maximum tolerance of ± 2 inch.
 15. Properly prepared record drawings on mylar, together with two copies, shall be certified by a design professional (Engineer and/or Surveyor registered in the State of Florida), employed by the Contractor, and submitted to the County.
- D. Specifications and Addenda; Legibly mark each Section to record:

1. Manufacturer, trade name, catalog number and supplier of each product and item of equipment actually installed.
 2. Changes made by field order or by change order.
- E. Shop Drawings (after final review and approval):
1. Five sets of record drawings for each process equipment, piping, electrical system and instrumentation system.

2.05 SUBMITTAL

- A. Prior to substantial completion and prior to starting the bacteria testing of water lines, deliver signed and sealed Record Documents and Record Drawings to the County. These will be reviewed and verified by the inspector. If there are any required changes or additions, these shall be completed and the entire signed and sealed set resubmitted prior to final pay application.
- B. The Contractor shall employ a Professional Engineer or Surveyor registered in the State of Florida to verify survey data and properly prepare record drawings. Record drawings shall be certified by the professional(s) (Engineer or Surveyor licensed in Florida), as stipulated by the Land Development Ordinance and submitted on signed and sealed paper drawings, signed and dated mylar drawings together with an AutoCAD version on a recordable compact disk (CD).
- C. The CD shall contain media in AutoCad Version 2004 or later, or in any other CAD program compatible with AutoCad in DWG or DXF form. All fonts, line types, shape files, external references, or other pertinent information used in the drawing and not normally included in AutoCad shall be included on the media with a text file or attached noted as to its relevance and use.
- D. Accompany submittal with transmittal letter, containing:
1. Date.
 2. Project title and number.
 3. Contractor's name and address.
 4. Title and number of each Record Document.
 5. Signature of Contractor or his authorized representative.

Note: The data required to properly prepare these record drawings shall be obtained at the site, at no cost to the County by the responsible design professional or his/her duly appointed representative. The appointed representative shall be a qualified employee of the responsible design professional or a qualified inspector retained by the responsible design professional on a project-by-project basis.

PART 3 EXECUTION (NOT USED)

END OF SECTION

SECTION 01730 OPERATING AND MAINTENANCE DATA

PART 1 GENERAL

1.01 REQUIREMENTS INCLUDED

- A. Compile product data and related information appropriate for County's maintenance and operation of products furnished under Contract.

Prepare operating and maintenance data as specified in this and as referenced in other pertinent sections of Specifications.

- B. Instruct County's personnel in maintenance of products and equipment and systems.
- C. Provide three (3) sets of operating and maintenance manuals for each piece of equipment provided within this Contract.

1.02 FORM OF SUBMITTALS

- A. Prepare data in form of an instructional manual for use by County's personnel.

- B. Format:

1. Size: 8-1/2 inch x 11 inch
2. Paper: 20 pound minimum, white, for typed pages
3. Text: Manufacturer's printed data or neatly typewritten
4. Drawings:
 - a. Provide reinforced punched binder tab, bind in with text.
 - b. Fold larger drawings to size of text pages.
5. Provide fly-leaf for each separate product or each piece of operating equipment.
 - a. Provide typed description of product and major component parts of equipment.
 - b. Provide indexed tabs.
6. Cover: Identify each volume with typed or printed title "OPERATING AND MAINTENANCE INSTRUCTIONS". List:
 - a. Title of Project.
 - b. Identity of separate structures as applicable.
 - c. Identity of general subject matter covered in the manual.

- C. Binders:

1. Commercial quality three-ring binders with durable and cleanable plastic covers.
2. Maximum ring size: 1 inch.
3. When multiple binders are used, correlate the data into related consistent groupings.

1.03 MANUAL FOR EQUIPMENT AND SYSTEMS

- A. Submit three copies of complete manual in final form.

- B. Content for each unit of equipment and system, as appropriate:

1. Description of unit and component parts.
 - a. Function, normal operating characteristics and limiting conditions.

- b. Performance curves, engineering data and tests.
- c. Complete nomenclature and commercial number of replaceable parts.
- 2. Operating Procedures:
 - a. Start-up, break-in, routine and normal operating instructions.
 - b. Regulation, control, stopping, shut-down and emergency instructions.
 - c. Summer and winter operating instructions.
 - d. Special operating instructions.
- 3. Maintenance Procedures:
 - a. Routine operations.
 - b. Guide to "trouble-shooting".
 - c. Disassembly, repair and reassembly.
 - d. Alignment, adjusting and checking.
- 4. Servicing and lubricating schedule.
 - a. List of lubricants required.
- 5. Manufacturer's printed operating and maintenance instructions.
- 6. Description of sequence of operation by control manufacturer.
- 7. Original manufacturer's parts list, illustrations, assembly drawings and diagrams required for maintenance.
 - a. List of predicted parts subject to wear.
 - b. Items recommended to be stocked as spare parts.
- 8. As installed control diagrams by controls manufacturer.
- 9. Each contractor's coordination drawings.
 - a. As installed color coded piping diagrams.
- 10. Charts of valve tag numbers, with location and function of each valve.
- 11. List of original manufacturer's spare parts, manufacturer's current prices and recommended quantities to be maintained in storage.
- 12. Other data as required under pertinent sections of specifications.

C. Content, for each electric and electronic system, as appropriate:

- 1. Description of system and component parts.
 - a. Function, normal operating characteristics and limiting conditions.
 - b. Performance curves, engineering data and tests.
 - c. Complete nomenclature and commercial number of replaceable parts.
- 2. Circuit directories of panelboards.
 - a. Electrical service.
 - b. Controls.
 - c. Communications.
- 3. As-installed color coded wiring diagrams.
- 4. Operating procedures:
 - a. Routine and normal operating instructions.
 - b. Sequences required.
 - c. Special operating instructions.
- 5. Maintenance procedures:
 - a. Routine operations.
 - b. Guide to "trouble-shooting".
 - c. Disassembly, repair and reassembly.
 - d. Adjustment and checking.
- 6. Manufacturer's printed operating and maintenance instructions.
- 7. List of original manufacturer's spare parts, manufacturer's current prices and recommended quantities to be maintained in storage.
- 8. Prepare and include additional data when the need for such data becomes apparent during instruction of County's personnel.

- D. Prepare and include additional data when the need for such data becomes apparent during instruction on County's personnel.
- E. Additional requirements for operating and maintenance data: Respective sections of Specifications.

1.04 SUBMITTAL SCHEDULE

- A. Submit one copy of completed data in final form fifteen days prior to substantial completion.
 - 1. Copy will be returned after substantial completion, with comments (if any).
- B. Submit two copies of approved data in final form. Final acceptance will not be provided until the completed manual is received and approved.

1.05 INSTRUCTION OF COUNTY'S PERSONNEL

- A. Prior to final inspection or acceptance, fully instruct County's designated operating and maintenance personnel in operation, adjustment and maintenance of products, equipment and systems.
- B. Operating and maintenance manual shall constitute the basis of instruction.
 - 1. Review contents of manual with personnel in full detail to explain all aspects of operations and maintenance.

PART 2 PRODUCTS (NOT USED)

PART 3 EXECUTION (NOT USED)

END OF SECTION

SECTION 01740 WARRANTIES AND BONDS

PART 1 GENERAL

1.01 REQUIREMENTS INCLUDED

- A. Compile specified warranties and bonds.
- B. Compile specified service and maintenance contracts.
- C. Co-execute submittals when so specified.
- D. Review submittals to verify compliance with Contract Documents.
- E. Submit to County for review and transmittal.

1.02 SUBMITTAL REQUIREMENTS

- A. Assemble warranties, bonds and service and maintenance contracts, executed by each of the respective manufacturers, suppliers and subcontractors.
- B. Number of original signed copies required: Two each.
- C. Table of Contents: Neatly typed, in orderly sequence. Provide complete information for each item.
 - 1. Product or work item.
 - 2. Firm, with name of principal, address and telephone number.
 - 3. Scope.
 - 4. Date of beginning of warranty, bond or service and maintenance contract.
 - 5. Duration of warranty, bond or service maintenance contract.
 - 6. Provide information for County's personnel:
 - a. Proper procedure in case of failure.
 - b. Instances which might affect the validity of warranty or bond.
 - 7. Contractor, name of responsible principal, address and telephone number.

1.03 FORM OF SUBMITTALS

- A. Prepare in duplicate packets.
- B. Format:
 - 1. Size 8-1/2 inch x 11 inch punched sheets for standard 3-ring binder. Fold larger sheets to fit into binders.
 - 2. Cover: Identify each packet with typed or printed title "WARRANTIES AND BONDS". List:
 - a. Title of Project.
 - b. Name of Contractor.
- C. Binders: Commercial quality, three-ring, with durable and cleanable plastic covers.

1.04 TIME OF SUBMITTALS

- A. Make submittals within ten days after date of substantial completion and prior to final request for payment.
- B. For items of work, where acceptance is delayed materially beyond date of substantial completion, provide updated submittal within ten days after acceptance, listing date of acceptance as start of warranty period.

1.05 SUBMITTALS REQUIRED

- A. Submit warranties, bonds, service and maintenance contracts as specified in respective sections of Specifications.
- B. Approval by the County of all documents required under this section is a pre-requisite to requesting a final inspection and final payment

PART 2 PRODUCTS (NOT USED)

PART 3 EXECUTION (NOT USED)

END OF SECTION

DIVISION 2 SITE WORK

SECTION 02064 MODIFICATIONS TO EXISTING STRUCTURES, PIPING AND EQUIPMENT

PART 1 GENERAL

1.01 SCOPE OF WORK

Furnish all labor, materials, equipment and incidentals required to modify, alter and/or convert existing structures as shown or specified and as required for the installation of piping, mechanical equipment and appurtenances. Existing piping and equipment shall be removed and dismantled as necessary for the performance of facility alterations in accordance with the requirements herein specified.

PART 2 PRODUCTS

- A. Epoxy mortar shall be fiberglass fiber mixed with an epoxy filler.
- B. Non-shrink grout shall be a sand-cement, non-metallic formulation, having a 28-day strength of 4,000 psi and 0.0 percent shrinkage per ASTM C1090.
- C. Liners to be installed in existing manholes and wetwells shall be spray-applied, monolithic, reinforced urethane resin. Urethane resin-based manhole liner material shall be resistant to hydrogen sulfide gas, and other common contents found in a sanitary sewer environment.
- D. Approved manhole and wet well liner products are Raven 405, SprayWall, Green Monster, or SpectraShield.

PART 3 EXECUTION

3.01 GENERAL

- A. Cut, repair, reuse, excavate, demolish or otherwise remove parts of the existing structures or appurtenances, as indicated on the construction drawings, or as necessary to complete the work as required. Dispose of surplus materials resulting from the above work in an approved manner. The work shall include all necessary cutting and bending of reinforcing steel, structural steel, or miscellaneous metal work found embedded in the existing structures.
- B. Dismantle and remove all existing equipment, piping, and other appurtenances required for the completion of the work. Where called for or required, cut existing pipelines for the purpose of making connections thereto.
- C. Anchor bolts for equipment and structural steel to be removed shall be cut off one inch below the concrete surface. Surfaces shall then be refinished using non-shrink grout or epoxy mortar or as indicated on the construction drawings. Repairs to the interior surfaces of existing concrete structures in sanitary sewers shall be made with epoxy mortar. Repairs to be made on other existing concrete surfaces using non-shrink grout shall be made using a bonding agent such as Acrylbond by Concrete Producers Solutions or an equal approved by the County. Remove all dirt, curing compounds, sealers, paint, rust or other foreign material, and etch with muriatic acid solution. Flush with clean water and while still damp,

apply a coating of the bonding agent. Place the new grout patch onto the treated area immediately.

- D. At the time that a new connection is made to an existing pipeline, additional new piping, extending to and including a new valve, shall be installed. Pipe restraint devices, if required, shall also be installed as required. At the time when a new potable or reclaimed water service is installed, a pipe locator tracer wire shall be installed and connected to the tracer wire at the main.
- E. No existing structure, equipment, or appurtenance shall be shifted, cut, removed, or otherwise altered except with the express approval of and only to the extent approved by the County. All existing valve boxes, fire hydrants, air release valve cabinets, and manholes shall be relocated to meet the new finished grade elevations after construction.
- F. When removing materials or portions of existing utility pipelines or structures or when making openings in walls and partitions, take all precautions and use all necessary barriers and other protective devices so as not to damage the structures beyond the limits necessary for the new work, and not to damage the structures or contents by falling or flying debris. Unless otherwise approved by the County, saw-cutting, rotary core-boring, or line drilling will be required in removing material from existing concrete structures or pipes.
- G. Materials and equipment removed in the course of making alterations and additions shall remain the property of the County, except that items not salvageable, as determined by the County, shall be disposed of off the work site.
- H. All alterations to existing utility pipes and structures shall be done at such time and in such a manner as to comply with the approved time schedule. Before any part of the work is started, all tools, equipment, and materials shall be assembled and made ready so that the work can be completed without delays.
- I. All cutting of existing concrete or other material to provide suitable bonding to new work shall be done in a manner to meet the requirements of the respective section of these Standards covering the new work. When not covered, the work shall be carried on in the manner and to the extent directed by the County or per the construction drawings.
- J. Surfaces of seals visible in the completed work shall be made to match as nearly as possible the adjacent surfaces.
- K. Non-shrink cementitious grout shall be used for setting wall castings, sleeves, leveling pump bases, doweling anchors into existing concrete and elsewhere as shown on the construction drawings. The surface to which grout is to be applied shall be wetted to facilitate good bonding.
- L. Where necessary or required for the purpose of making connections; cut existing pipelines in a manner to provide an approved joint. Where required, use flanges, couplings, or adapters, all as required.
- M. Provide flumes, hoses, piping, pumps and well points, and other related items to divert or provide suitable plugs, bulkheads, or other means to hold back the flow of water or other liquids, all as required in the performance of the work.
- N. Care shall be taken not to damage any part of existing buildings or foundations or outside structures.

- O. Prior to entering confined spaces in sanitary sewer structures, conduct an evaluation of the atmosphere within, in accordance with local, state, and federal regulations. Provide ventilation equipment and other equipment as required to assure safe working conditions.

3.02 CONNECTING TO EXISTING PIPING AND EQUIPMENT

The Contractor shall verify exact location, material, alignment, joint, etc. of existing piping and equipment prior to making the connections called out in the Drawings. The verifications shall be performed with adequate time to correct any potential alignment or other problems prior to the actual time of connection. A County Inspector must be present for all tie-ins for a visual inspection.

3.03 REMOVAL AND ABANDONMENT OF ASBESTOS CEMENT PIPE AND APPURTENANCES

- A. All work associated with the removal or abandonment of existing asbestos cement pipe and appurtenances shall be performed by a licensed asbestos removal Contractor registered in the State of Florida.
- B. The asbestos Contractor shall contact the appropriate regulatory agencies prior to removal or abandonment of any asbestos material and shall obtain all required permits and licenses and issue all required notices. The cost for all fees associated with permits, licenses and notices to the governing regulatory agencies shall be borne by the asbestos Contractor.
- C. All work associated with removal or abandonment of asbestos cement pipe and appurtenances shall be performed in accordance with the standards listed below and all other applicable local, State, or Federal standards.

- (1) Florida Administrative Code, Chapter 62-257, ASBESTOS PROGRAM
- (2) Title 40 CFR, Part 61, Subpart M, NATIONAL EMISSION STANDARD FOR ASBESTOS
- (3) Occupational Safety and Health Act, Title 29 CFR
- (4) Title 40 CFR, Part 763, ASBESTOS
- (5) Florida Statute Title XXXII, Chapter 469, ASBESTOS ABATEMENT

- D. All asbestos cement pipe sections indicated on the construction drawings to be removed, and all related tees, valves, fittings and appurtenances shall be removed in their entirety and disposed of by the asbestos Contractor in accordance with this Section. Asbestos cement nipples between tees and valves shall be replaced. After removal of the pipelines, all excavations shall be backfilled in accordance with the applicable provisions of the Trenching and Excavation Section of these Standards. The cost of disposing of the removed materials shall be borne by the asbestos Contractor.
- E. The cutting of existing asbestos-cement (A/C, a.k.a. "Transite") pipe shall be by hand tools only. No powered machine cutting is allowed. Removal of all fragments of pipe shall be double bagged prior to shipment. Longer sections of pipe removed may be shipped without double bagging. An asbestos manifest form must accompany each shipment of such pipe or pipe material waste to the Manatee County Lena Road Landfill. Prior to each shipment, a minimum of 24 hours notice to the Landfill field office (telephone (941) 748-5543) is required.

3.04 IN-PLACE GROUTING OF EXISTING PIPE

- A. Where water and wastewater utility pipes are to be abandoned in place, they shall be filled with a nonshrinking sand-cement grout. When such pipes are made of asbestos-cement materials, the abandonment activities shall be performed by a licensed asbestos Contractor. It is completely the Contractor's responsibility to obtain all regulatory clearances and provide documentation in cases where they have determined that an asbestos-cement pipe abandonment activity by in-place grouting does not require a licensed asbestos Contractor.
- B. The ends of the pipe sections to be grout-filled shall be capped or plugged with suitable pipe fittings. The grout material shall be of suitable properties and the pumping pressure shall be such that the pipe sections are filled completely with grout. All above ground features shall be removed: hydrants, meters, valve & meter boxes, pads, vaults, etc. Existing tees, crosses, and valves left in service shall be plugged and restrained.
- C. The County shall be given timely notice so that the County's representative may be present to monitor all pipe grouting operations. Provide standpipes and/or additional means of visual inspection as required to determine if adequate grout material has filled the entire pipe sections.
- D. All tees, crosses, and valves left in service shall be plugged and restrained.

3.05 SPRAY-APPLIED LINERS

- A. Use a high-pressure water spray to remove all foreign material from the walls and bench of the structure. Loose or protruding masonry materials shall be removed using a hammer and chisel. Fill any voids, holes or cracks using a hand trowel with epoxy mortar to form a uniform surface. Place covers over all pipe openings to prevent extraneous material from entering the pipes. Block or divert sewer flow from entering the structure. Any infiltration leaks shall be stopped by using such methods as approved by the County.
- B. The liner material shall be sprayed onto the invert, bench and wall areas. The sprayed-on material shall be applied such that the entire structure is lined with a structurally enhanced monolithic liner. The thickness of the wall liner material shall be such that it will withstand the hydraulic load generated by the surrounding groundwater table, using a factor of safety of two, and using the assumption that the groundwater table is at the level of the top of the structure. The invert and bench liner material shall be the same thickness as that required for the base of the wall.
- C. Special care shall be used to provide a smooth transition between the intersecting pipelines and the manhole inverts such that flow is not impaired. Remove concrete material from the existing manhole base channel in depth to the required thickness of the new liner material.
- D. No active sewer flow shall be allowed in the newly lined structure, nor shall any vacuum tests be performed, until the liner material has had adequate time to cure, as recommended by the liner material manufacturer.
- E. Install the coating systems per manufacturer's recommendation and completely protect the structure from corrosion. The liner or coating systems must extend and seal onto manhole ring, onto and around pipe openings and any other protrusions, and completely cover the bench and flow invert. Provide a five (5)-year unlimited warranty on all workmanship and products. The work includes the surface preparation and application of the coating or liner system, and shall protect the structure for at least five (5) years from all leaks and from failure due to corrosion from exposure to corrosive gases such as hydrogen sulfide.

3.06 CONNECTION TO EXSTING MANHOLE

- A. Where required or as indicated on the construction drawings, make connection of new pipelines to existing manhole structures. If pipe stub-outs of the correct size and position are not available, make connections by removing a portion of the manhole wall by mechanical rotary core boring. The connection between pipe and concrete manhole shall be complete with resilient seals meeting the requirements of ASTM C923.
- B. A new channel shall be formed in the manhole base by removing and reforming or by providing new concrete to convey the new flow into the existing channel in accordance with the standard requirements for new sewer manhole structures. Flow direction shall not change by more than 90 degrees within the manhole base.
- C. Repair internal coating of existing manholes cored during connection of new sewers by applying approved coating material as listed above in accordance with the manufacturer's recommendations. If existing manhole has an internal coating other than that listed above, sandblast the interior of the existing manhole and apply an approved coating in accordance with the manufacturer's recommendations.
- D. When connecting a force main to an existing manhole, the force main termination manhole and the next two manholes downstream shall be rehabilitated and lined with a currently approved liner. If the existing manholes are lined with a non-conforming liner according to Part 2.D above, the existing liner shall be removed and replaced, unless otherwise noted on the plans or with written approval by the County.

END OF SECTION

SECTION 02100 SITE PREPARATION

PART 1 GENERAL

1.01 SCOPE OF WORK

- A. This Section covers clearing, grubbing and stripping of the project site and/or along the pipeline route.
- B. The Contractor shall clear and grub all of the area within the limits of construction or as required, which includes, but is not limited to utility easements. The width of the area to be cleared shall be reviewed by the County prior to the beginning of any clearing.
- C. The Contractor's attention is directed to any Soil Erosion and Sediment Control Ordinances in force in Manatee County. The Contractor shall comply with all applicable sections of these ordinances.

PART 2 PRODUCTS (NOT USED)

PART 3 EXECUTION

3.01 CLEARING

The surface of the ground, for the area to be cleared and grubbed shall be completely cleared of all timber, brush, stumps, roots, grass, weeds, rubbish and all other objectionable obstructions resting on or protruding through the surface of the ground. However, trees shall be preserved as hereinafter specified unless otherwise designated by the County. Clearing operations shall be conducted so as to prevent damage to existing structures and installations and to those under construction, so as to provide for the safety of employees and others. Soil erosion control devices such as hay bales and silt fences shall be installed to satisfy all Federal, State and County requirements.

3.02 GRUBBING

Grubbing shall consist of the complete removal of all stumps, roots larger than 1-1/2 inches in diameter, matted roots, brush, timber, logs and any other organic or metallic debris not suitable for foundation purposes, resting on, under or protruding through the surface of the ground to a depth of 18 inches below the subgrade. All depressions excavated below the original ground surface for or by the removal of such objects, shall be refilled with suitable materials and compacted to a density conforming to the surrounding ground surface.

3.03 STRIPPING

In areas so designated, topsoil shall be stockpiled. Topsoil so stockpiled shall be protected until it is placed as specified. The County shall have the option to receive all excess topsoil materials. The Contractor shall pay all equipment and labor cost to deliver excess top soil material to a remote site chosen by the County within a five mile radius of the construction site. Should County not choose to receive any or all excess topsoil materials, the Contractor shall dispose of said material at no additional cost to County.

3.04 DISPOSAL OF CLEARED AND GRUBBED MATERIAL

The Contractor shall dispose of all material and debris from the clearing and grubbing

operation by hauling such material and debris off site. The cost of disposal (including hauling) of cleared and grubbed material and debris shall be considered a subsidiary obligation of the Contractor; the cost of which shall be included in the prices bid for the various classes of work.

3.05 PRESERVATION OF TREES

Those trees which are not designated for removal by the County shall be carefully protected from damage. The Contractor shall erect such barricades, guards and enclosures as may be considered necessary by him for the protection of the trees during all construction operation.

3.06 PRESERVATION OF DEVELOPED PRIVATE PROPERTY

- A. The Contractor shall exercise extreme care to avoid unnecessary disturbance of developed private property adjacent to proposed project site. Trees, shrubbery, gardens, lawns and other landscaping, which are not designated by the County to be removed, shall be replaced and replanted to restore the construction easement to the condition existing prior to construction.
- B. All soil preservation procedures and replanting operations shall be under the supervision of a nursery representative experienced in such operations.
- C. Improvements to the land such as fences, walls, outbuildings and other structures which of necessity must be removed, shall be replaced with equal quality materials and workmanship.
- D. The Contractor shall clean up the construction site across developed private property directly after construction is completed upon approval of the County.

3.07 PRESERVATION OF PUBLIC PROPERTY

The appropriate paragraphs of these Specifications shall apply to the preservation and restoration of public lands, parks, rights-of-way, easements and all other damaged areas. This includes, but is not limited to the trimming of trees damaged by contractor's equipment.

END OF SECTION

SECTION 02220 EXCAVATION, BACKFILL, FILL AND GRADING FOR STRUCTURES

PART 1 GENERAL

1.01 SCOPE OF WORK

- A. Structural excavation shall consist of the removal of material for the construction of foundations for structures and other excavation designated on the drawings or in these specifications.
- B. Structural excavation and backfill shall consist of furnishing material, if necessary and placing and compacting backfill material around structures to the lines and grades designated on the drawings, as specified or directed by the County.
- C. Structural excavation and backfill shall include the furnishing of all materials, equipment and other facilities which may be necessary to perform the excavations, place and compact the backfill, install sheeting and bracing, and carry out any necessary dewatering. It shall also include the wasting or disposal of surplus excavated material in a manner and in locations approved by the County.
- D. The Contractor is responsible for the protection of every tree which is scheduled to remain in the project area. This includes trees which may or may not be shown on the plans. Every tree shall be adequately protected in place at no additional cost to the County. This includes, but is not limited to, protecting the root systems and adjusting grades as necessary for tree/root protection.

1.02 QUALITY ASSURANCE

- A. Testing Agency:
 - 1. In place soil compaction tests shall be performed by a qualified testing laboratory.
 - 2. Compaction tests shall be taken every 500 feet, except in the road crossings or road shoulders. Tests are to be taken according to current FDOT Standards.
- B. Reference Standards:
 - 1. American Society for Testing and Materials (ASTM):
 - a. ASTM D1557, Moisture-Density Relations of Soils Using 10-lb. (4.5-kg) Rammer and 18-in. (457-mm) Drop.

1.03 JOB CONDITIONS

- A. The Contractor shall provide, operate and maintain all necessary pumps, discharge lines, well points, etc., in sufficient number and capacity to keep all excavation, bases, pits, etc., free from seepage, standing or running water at all times throughout the period of construction.
- B. The Contractor shall assume all responsibility for the security of the excavation required, employing bracing, lining or other accepted means necessary to accomplish same.
- C. Excavated areas shall be cleared of all debris, water, slush, muck, clay and soft or loose earth and shall be conditioned to the entire satisfaction of the County.

- D. All excavated material unsuitable for use or which will not be used shall be disposed of in a manner consistent with State and County regulation.
- E. All unsuitable organic materials, roots, logs, etc., found during excavation shall be removed by the Contractor and the trench shall be refilled with suitable material.

PART 2 PRODUCTS

2.01 MATERIAL FOR CONTROLLED FILL

- A. Composition: Only approved material free from organic matter and lumps of clay, shall be used for backfill. Excavated earth free from debris or organic material may be used for backfilling foundations or fill.
- B. Crushed stone and shell shall meet or exceed current FDOT Standards.

2.02 UNSUITABLE MATERIAL

Unsuitable material shall be defined as highly organic soil per ASTM D2487 Group PT. This includes, but is not limited to, such items as topsoil, roots, vegetable matter, trash, debris, and clays that cannot be dried sufficiently to obtain specified compaction.

PART 3 EXECUTION

3.01 INSPECTION

- A. The Contractor shall verify that work preceding the affected work of this Section has been satisfactorily completed.
- B. Conditions adversely affecting the work of this Section shall be corrected to the satisfaction of the County.

3.02 REMOVAL OF UNSUITABLE MATERIALS

- A. The Contractor shall remove unsuitable material from within the limits of the Work.
- B. Materials meeting requirements for controlled fill shall be stockpiled as necessary and in such a manner satisfactory to the County.
- C. All material excavated shall be placed so as to minimize interference with public travel and to permit proper access for inspection of the work.

3.03 EXCAVATION

- A. When concrete or shell subbase footing is to rest on an excavated surface, care shall be taken not to disturb the natural soil. Final removal and replacement of the foundation material and subbase compaction to grade shall not be made until just before the concrete or masonry is placed.
- B. When any structural excavation is completed, the Contractor shall notify the County who will make an inspection of the excavation. No concrete or masonry shall be placed until the excavation has been approved by the County.

- C. The elevations of the footing bottom and the base slab as shown on the Drawings, shall be considered as approximate and the County may order in writing, such changes in dimensions or elevations of the footings and slab base as necessary to secure satisfactory foundations.
- D. All excavation shall be made within an area bounded by lines five feet outside and parallel to the exterior walls of the structure to allow for correct forming, shoring and inspection of foundation work. Pouring of concrete against earth side walls shall not be permitted.
- E. If the ground is excavated below the grade called for by the Drawings or becomes unstable due to the Contractor's carelessness or operations, the ground shall be excavated to undisturbed native soil before continuing concreting operations.
- F. If in the opinion of the County, the material at or below the normal grade of the bottom of the trench is unsuitable for pipe or structure foundation, it shall be removed to the depth directed by the County and if so directed, replaced by crushed stone or washed shell.

3.04 STRUCTURAL BACKFILL

- A. Structural backfill shall not be placed until the footings or other portions of the structure or facility have been inspected by the County and approved for backfilling.
- B. A minimum of 1-1/2" layer of lean concrete shall be placed as a working mat for the concrete base slabs and footings if required by the County.
- C. Fill shall be placed in uniform layers not more than 12" thick and compacted to a minimum of 98 percent of the maximum density determined by ASTM D1557, Method A or C, or as directed by the County. The Contractor shall securely tamp the backfill with pneumatic rammer around all wall foundations. The method of compaction shall be satisfactory to the County.
- D. Compaction of structural backfill by ponding and jetting may be permitted when, as determined by the County: the backfill material is of such character that it will be self-draining when compacted; foundation materials will not soften or be otherwise damaged by the applied water; no damage from hydrostatic pressure will result to the structure. Ponding and jetting within two feet below finished subgrade shall not be permitted in roadway areas. At the discretion of the County, ponding and jetting may be permitted with compaction layers not to exceed four feet.
- E. Surplus material not used on-site shall be removed and disposed of off-site by the Contractor. In no case shall surplus material be deposited on adjacent lands. Fill used for grading shall be placed in layers not to exceed 12 inches in thickness and shall be compacted to a density equal or greater to that of the surrounding natural ground.

3.05 BACKFILLING AROUND STRUCTURES

- A. Common fill and structural fill are specified for use as backfill against the exterior walls of the structures. Fill shall be placed in layers having a maximum thickness of eight (8) inches in loose state and shall be compacted sufficiently to prevent settlement. If compaction is by rolling or ramming, material shall be wetted down as required. Where material can be suitably compacted by jetting or puddling, the Contractor may use one of these methods. No boulders shall be allowed to roll down the slopes and hit the walls.

- B. Backfilling shall be carried up evenly on all walls of an individual structure simultaneously. A variation of two (2) feet in elevation will be the maximum allowable. No backfill shall be allowed against walls until the walls and their supporting slabs, if applicable, have attained sufficient strength. Backfilling shall be subjected to approval by the County.
- C. In locations where pipes pass through building walls, the Contractor shall take the following precautions to consolidate the refill up to an elevation of at least one foot above the bottom of the pipes:
 - 1. Place structural fill in such areas for a distance of not less than three feet either side of the center line of the pipe in level layers not exceeding 6-inches in depth.
 - 2. Wet each layer to the extent directed and thoroughly compact each layer with a power tamper to the satisfaction of the County.
 - 3. Structural fill shall be of the quality specified under Part 2 of this Section.
- D. The surface of filled areas shall be graded to smooth true lines, strictly conforming to grades indicated on the grading plan. No soft spots or uncompacted areas shall be allowed in the work.
- E. Temporary bracing shall be provided as required during construction of all structures to protect partially completed structures against all construction loads, hydraulic pressure and earth pressure. The bracing shall be capable of resisting all loads applied to the walls as a result of backfilling.

3.06 FIELD QUALITY CONTROL

- A. The density of soil in place shall be a minimum of 95 percent in accordance with ASTM test 1557-70T, Method A or C.

END OF SECTION

SECTION 02221 TRENCHING, BEDDING AND BACKFILL FOR PIPE

PART 1 GENERAL

1.01 SCOPE OF WORK

- A. The Contractor shall furnish all labor, materials, equipment and incidentals necessary to perform all dewatering, excavation, backfill, fill, grading, trench protection or other related work required to complete the piping work shown on the Drawings and specified herein. The work shall include, but not be limited to: vaults; duct conduit; pipe; roadways and paving; backfilling; required fill or borrow operations; grading; disposal of surplus and unsuitable materials; and all related work such as sheeting, bracing and dewatering.
- B. Prior to commencing work, the Contractor shall examine the site and review test borings if available, or undertake his own subsurface investigations and take into consideration all conditions that may affect his work.
- C. The Contractor is responsible for the protection of every tree which is scheduled to remain in the project area. This includes trees which may or may not be shown on the plans. Every tree shall be adequately protected in place at no additional cost to the County. This includes, but is not limited to protecting the root systems and adjusting grades as necessary for tree/root protection.

1.02 PROTECTION

- A. Sheeting and Bracing in Excavations:
 - 1. In connection with construction of underground structures, the Contractor shall properly construct and maintain cofferdams. These shall consist of: sheeting and bracing as required to support the sides of excavations, to prevent any movement which could in any way diminish the width of the excavation below that necessary for proper construction and to protect adjacent structures, existing yard pipe and/or foundation material from disturbance, undermining, or other damage. Care shall be taken to prevent voids outside of the sheeting, but if voids are formed, they shall be immediately filled and rammed.
 - 2. Trench sheeting for pipes: no sheeting is to be withdrawn if driven below, mid-diameter of any pipe and no wood sheeting shall be cut off at a level lower than one foot above the top of any pipe unless otherwise directed by the County. During the progress of the work, the County may direct the Contractor in writing to leave additional wood sheeting in place. If steel sheeting is used for trench sheeting, removal shall be as specified above, unless written approval is given for an alternate method of removal.
 - 3. All sheeting and bracing not left in place shall be carefully removed in such a manner as not to endanger the construction or other structures, utilities, existing piping, or property. Unless otherwise approved or indicated on the Drawings or in the Specification, all sheeting and bracing shall be removed after completion of the piping or structure, care being taken not to disturb or otherwise injure the pipeline or finished masonry. All voids left or caused by withdrawal of sheeting shall be immediately refilled with sand by ramming with tools specifically made for that purpose, by watering, or as may otherwise be directed.

4. The Contractor shall construct, to the extent he deems it desirable for his method of operation, the cofferdams and sheeting outside the neat lines of the pipeline trench or foundation unless otherwise indicated on the Drawings or directed by the County. Sheeting shall be plumb and securely braced and tied in position. Sheeting, bracing and cofferdams shall be adequate to withstand all pressures to which the pipeline or structure will be subjected. Pumping, bracing and other work within the cofferdam shall be done in a manner to avoid disturbing any construction of the pipeline or the enclosed masonry. Any movement or bulging which may occur shall be corrected by the Contractor at his own expense so as to provide the necessary clearances and dimensions.
5. Drawings of the cofferdams and design computations shall be submitted to the County and approved prior to any construction. However, approval of these drawings shall not relieve the Contractor of the responsibility for the cofferdams. The drawings and computations shall be prepared and stamped by a Registered Professional Engineer in the State of Florida and shall be in sufficient detail to disclose the method of operation for each of the various stages of construction, if required, for the completion of the pipeline and substructures.

B. Dewatering, Drainage and Flotation

1. The Contractor shall construct and place all pipelines, concrete work, structural fill, bedding rock and limerock base course, in-the-dry. In addition, the Contractor shall make the final 24" of excavation for this work in-the-dry and not until the water level is a minimum of 18 below proposed bottom of excavation.
2. The Contractor shall, at all times during construction, provide and maintain proper equipment and facilities to remove promptly and dispose of properly all water entering excavation and keep such excavations dry so as to obtain a satisfactory undisturbed subgrade foundation condition until the fill, structure, or pipes to be built thereon have been completed to such extent that they will not be floated or otherwise damaged by allowing water levels to return to natural elevations. At all times during the construction operations, the groundwater levels shall be maintained at an elevation 18 inches below the lowest level where structures are being installed.
3. Dewatering shall at all times be conducted in such a manner as to preserve the natural undisturbed bearing capacity of the subgrade soils at proposed bottom of excavation.
4. Wellpoints may be required for dewatering the soil prior to final excavation for deeper in-ground structures or piping and for maintaining the lowered groundwater level until construction has been completed to avoid the structure, pipeline, or fill from becoming floated or otherwise damaged. Wellpoints shall be surrounded by suitable filter sand and no fines shall be removed by pumping. Pumping from wellpoints shall be continuous and standby pumps shall be provided.
5. The Contractor shall furnish all materials and equipment to perform all work required to install and maintain the proposed drainage systems for handling groundwater and surface water encountered during construction of structures, pipelines and compacted fills.
6. Where required, the Contractor shall provide a minimum of two operating groundwater observation wells at each structure to determine the water level during

construction of the pipeline or structure. Locations of the observation wells shall be at structures and along pipelines as approved by the County prior to their installation. The observation wells shall be extended to 6 inches above finished grade, capped with screw-on caps protected by 24" x 24" wide concrete base and left in place at the completion of this Project.

7. Prior to excavation, the Contractor shall submit his proposed method of dewatering and maintaining dry conditions to the County for approval. Such approval shall not relieve the Contractor of the responsibility for the satisfactory performance of the system. The Contractor shall be responsible for correcting any disturbance of natural bearing soils for damage to pipeline or structures caused by an inadequate dewatering system or by interruption of the continuous operation of the system as specified.
8. As part of his request for approval of a dewatering system, the Contractor shall demonstrate the adequacy of the proposed system and wellpoint filter sand by means of a test installation. Discharge water shall be clear, with no visible soil particles in a one quart sample. Discharge water shall not flow directly into wetlands or Waters of the State as defined by FDEP and SWFWMD.
9. During backfilling and construction, water levels shall be measured in observation wells located as directed by the County.
10. Continuous pumping will be required as long as water levels are required to be below natural levels.

PART 2 PRODUCTS

2.01 MATERIALS

A. General

1. Materials for use as fill and backfill shall be described below and shall be from an FDOT certified pit. For each material, the Contractor shall notify the County of the source of the material and shall furnish the County, for approval, a representative sample weighing approximately 50 pounds, at least ten calendar days prior to the date of anticipated use of such material.
2. Additional materials shall be furnished as required from off-site sources and hauled to the site.

B. Bedding - shall conform to FDOT Standard Specifications for Road and Bridge Construction, Section 901 Coarse Aggregate, and shall be either coarse aggregate of Size No. 57 or coarse sand of Size No. 9. Washed shell size No.57 may be used as an alternate bedding material.

C. Structural Fill

1. Structural fill in trenches shall be used below spread footing foundations, slab-on-grade floors and other structures as backfill within three feet of the below grade portions of structures.

2. Shall be either soil classification A-1, A-2 or A-3, per AASHTO M-145, and shall be free of organic matter, lumps of clay or marl, muck, compressible materials, and rock exceeding 2.5 inches in diameter. Broken concrete, masonry, rubble or other similar materials shall not be used as backfill. Minimum acceptable density shall be 98 percent of the maximum density as determined by AASHTO T-180.
- D. Selected Common Fill - shall have the same material classification and requirements as Structural Fill, as described above.
- E. Common Fill
1. Shall be either soil classification A-1, A-2, A-3, A-4, A-5 or A-6, per AASHTO M-145, and shall be free of organic matter, lumps of clay or marl, muck, compressible materials and rock exceeding 2.5 inches in diameter. Broken concrete, masonry, rubble or other similar materials shall not be used as backfill.
 2. Material falling within the above specification, encountered during the excavation, may be stored in segregated stockpiles for reuse. All material which, in the opinion of the County, is not suitable for reuse shall be spoiled as specified herein for disposal of unsuitable materials by the Contractor.
- E. Unsuitable Material - soil classification A-7 and A-8, per AASHTO M-145, shall not be used as backfill material.

PART 3 EXECUTION

3.01 EXCAVATION

- A. Excavate trenches and pits for structures to the elevations indicated on the construction drawings. Take special care to avoid over-excavating or disturbing the bottom of the trench or pit, so that the soil at the bottom of the hole remains in a naturally compacted condition. Excavate to widths sufficient to provide adequate working room to install the required structures. Do not excavate the final layer of soil to the designed grade until just before placing the bedding, foundation, pipe, structure, or masonry work required. Remove boulders, rocks, logs or any unforeseen obstacles encountered.
- B. In case the foundation soil found at the bottom of the trench or pit is soft, plastic or mucky, or does not conform to the soils classification specified as suitable foundation material, over-excavation to a greater depth will be required. Soils not meeting the classification required for foundation material shall be removed to a depth at least four inches below the bottom of the pipe, bedding or structure bottom elevation. Rock, boulders or other hard or lumpy material shall be removed to a depth 12 inches below the bottom of the pipe, bedding or structure bottom elevation. Remove muck, clay or other soft material to a depth as needed to establish a firm foundation.
- C. Where possible, the sides of trenches should be vertical up to at least the spring line of the installed pipe.
- D. Trench excavation shall be performed in accordance with Florida Statute Title XXXIII, Chapter 553, Part III, Trench Safety Act.

3.02 BACKFILLING

- A. Backfill materials shall be placed on solid, firm, naturally compacted or compacted to 98 percent of the maximum dry density of the material as determined by AASHTO T-180, dry or dewatered in place soil foundations.
- B. Where over-excavation is required due to nonconforming soil classification or rocky, unstable, or otherwise undesirable soil conditions, place Structural Fill or Selected Common Fill in the over-excavated zone up to the base of the bedding material layer. Compact the over-excavated zone to 98 percent of the maximum dry density of the material as determined by AASHTO T-180.
- C. When backfilling in an over-excavated zone where moist or watery conditions exist, backfill shall be coarse No. 9 sand or a mixture of No. 57 coarse aggregate with either No. 9 coarse sand, A-1, or A-3 material.
- D. After compaction, backfill material in the over-excavation zone shall form a solid and firm foundation on which to build up successive layers of backfill and structures.
- E. Bedding materials shall be placed on solid, firm soil foundations and shall be compacted to 98 percent of the maximum dry density of the material as determined by AASHTO T-180.
- F. Concrete and masonry structures shall be backfilled using Structural Fill. Backfilling and compaction shall be underneath the structure and carried up evenly on all walls of an individual structure simultaneously. The maximum allowable difference in backfill elevations shall be two feet. No backfilling shall be allowed against concrete or masonry walls until the walls and their supporting slabs have been in place at least seven days or until the specified 28-day strength has been attained. Compaction of Structural Fill underneath the base and along the walls shall be 98 percent of the maximum dry density of the material as determined by AASHTO T-180. The Structural Fill shall be either dried or shall have water added so that the moisture content of the material is within a range that will allow the required density to be achieved.
- G. Trenching backfill for pipe installation shall be Selected Common Fill for the pipe bedding zone. The pipe bedding envelope shall begin at the level four inches, six inches, or nine inches, depending on pipe diameter, below the bottom of the pipe, and shall extend vertically up to a level 12 inches above the top of the pipe. Where the in-place soil material within the four inch, six inch, or nine inch pipe bedding zone beneath the bottom of the pipe meets the soil classification for Selected Common Fill, undercutting of the trench below the bottom of the pipe will not be required. In this case, loosen the soil in the bottom of the trench immediately below the middle third of the pipe diameter, and place the pipe upon it. Where the in-place soil material within the pipe bedding zone does not meet the soil classification for Selected Common Fill, undercutting shall be required, and the bedding zone shall be backfilled with Selected Common Fill. In this case, place the pipe bedding material and leave it in a moderately firm uncompacted condition under the middle third of the pipe diameter, and compact the outer portions of the trench bottom to 98 percent of the maximum dry density. Soils that were over-excavated due to rocky, soft or otherwise unsuitable soil foundation conditions shall also be replaced with Selected Common Fill. Compaction of Selected Common Fill shall be 98 percent of the maximum dry density as determined by AASHTO T-180. Such backfill material shall have an optimized moisture content that will allow the required density to be achieved.
- H. Pipe sections for gravity flow systems shall be laid with spigots downstream and bells upstream. Excavate for pipe bells before laying pipe. Lay pipe true to the lines and grades indicated on the construction plans. Place backfill material on both sides of the pipe and

compact to 98 percent of the maximum dry density of the material as determined by AASHTO T-180. Take special care to effectively fill and compact the material in the haunch areas under the sides of the pipe.

- I. For pipes that are not installed under roadways or driveways, trenching backfill for pipe installation shall be Common Fill above the pipe envelope zone, and shall be compacted to 95 percent of the maximum dry density of the material as determined by AASHTO T-180, and shall have moisture content optimized to allow the required density. For pipes that are installed under roadways or driveways, trenching backfill for pipe installation shall be Selected Common Fill above the pipe envelope zone, and shall be compacted to 98 percent of the maximum dry density of the material as determined by AASHTO T-180, and shall have moisture content optimized to allow the required density. Selected Common Backfill shall be placed in layers not to exceed 6 inches. Common Backfill shall be placed in layers not to exceed 12 inches.
- J. Backfill compaction tests shall be performed every 500 feet in pipe line trenches and for every utility structure. Test reports shall be presented to the County Inspector.

3.03 GRADING AND CLEAN UP

- A. Surplus and unsuitable soil materials not used on-site shall be removed and disposed of off-site in a manner that is consistent with state and local regulations. In no case shall surplus or unsuitable material be deposited on-site or on adjacent lands.
- B. The surface of backfilled areas shall be graded smooth and true to the lines and grades indicated on the construction plans. No soft spots or uncompacted areas shall be allowed in the work.
- C. Upon completion of the work, leave the work areas and all adjacent areas in a neat and presentable condition, clear of all temporary structures, rubbish and surplus materials. Pile any salvageable materials that have been removed in neat piles for pickup by County crews, unless otherwise directed.

END OF SECTION

**SECTION 02223 EXCAVATION BELOW GRADE AND CRUSHED STONE OR SHELL
REFILL**

PART 1 GENERAL

1.01 SCOPE OF WORK

- A. If in the opinion of the County, the material at or below the normal grade of the bottom of the trench is unsuitable for pipe or structure foundation, it shall be removed to the depth directed by the County and replaced by crushed stone or washed shell.

PART 2 PRODUCTS (NOT USED)

PART 3 MATERIALS

3.01 EXCAVATION AND DRAINAGE

- A. Whatever the nature of unstable material encountered or the groundwater conditions, trench stabilization shall be complete and effective.
- B. Should the Contractor excavate below the grade shown on the Contract drawings because of negligence or for his own convenience; due to failure in properly dewatering the trench; disturbs the subgrade before dewatering is sufficiently complete; he shall be directed by the County to excavate below grade. The work of excavating below grade and furnishing and placing the approved refill material shall be performed at the Contractor's expense.

3.02 REFILL

- A. Soils not meeting the classification required for foundation material shall be removed to a depth at least four inches below the bottom of the pipe, bedding or structure bottom elevation. Rock, boulders or other hard or lumpy material shall be removed to a depth 12 inches below the bottom of the pipe, bedding or structure bottom elevation. Remove muck, clay or other soft material to a depth as needed to establish a firm foundation.

END OF SECTION

SECTION 02260 FINISH GRADING

PART 1 GENERAL

1.01 WORK INCLUDED

- A. The Contractor shall finish grade sub-soil.
- B. The Contractor shall cut out areas to receive stabilizing base course materials for paving and sidewalks.
- C. The Contractor shall place, finish grade and compact top soil.

1.02 PROTECTION

The Contractor shall prevent damage to existing fencing, trees, landscaping, natural features, bench marks, pavement and utility lines. Damage shall be corrected at no cost to the County.

PART 2 PRODUCTS

- A. Topsoil: Shall be friable loam free from subsoil, roots, grass, excessive amount of weeds or other organics, stones, and foreign matter; acidity range (pH) of 5.5 to 7.5; containing a minimum of 4 percent and a maximum of 25 percent organic matter. The Contractor may use topsoil stockpiles on site if they conform to these requirements.

PART 3 EXECUTION

3.01 SUB-SOIL PREPARATION

- A. The Contractor shall rough grade sub-soil systematically to allow for a maximum amount of natural settlement and compaction. Uneven areas and low spots shall be eliminated. Debris, roots, branches or other organics, stones, and sub-soil shall be removed by the Contractor and disposed of in a manner consistent with the latest Manatee County Standards as well as any affected regulatory agency. Should contaminated soil be found, the Contractor shall notify the County.
- B. The Contractor shall cut out areas to sub-grade elevation to stabilize base material for paving and sidewalks and shall be compacted to 98 percent of the maximum dry density of the material as determined by AASHTO T-180, and shall have moisture content optimized to allow the required density.
- C. The Contractor shall bring sub-soil to required profiles and contour grades gradually; and blend slopes into level areas.
- D. The Contractor shall slope the structure grade a minimum of two (2) inches in ten (10) feet unless indicated otherwise on the Drawings.
- E. The Contractor shall cultivate sub-grade to a depth of 3 inches where the topsoil is to be placed. He shall repeat cultivation in areas where equipment use has compacted sub-soil.
- F. The Contractor shall not make grade changes which causes water to flow onto adjacent lands.

3.02 PLACING TOPSOIL

- A. The Contractor shall place topsoil in areas where seeding, sodding and planting is to be performed. He shall place from the following minimum depths, up to finished grade elevations:
 - 1. 6 inches for seeded areas
 - 2. 4-1/2 inches for sodded areas
 - 3. 24 inches for shrub beds
 - 4. 18 inches for flower beds
- B. The Contractor shall use topsoil in a dry state as determined by the County. He shall place the material during dry weather.
- C. The Contractor shall use fine grade topsoil eliminating rough and low areas to ensure positive drainage. He shall maintain levels, profiles and contours of the sub-grades.
- D. The Contractor shall remove stone, roots, grass, weeds, debris, and other organics or foreign material while spreading the material.
- E. The Contractor shall manually spread topsoil around trees, plants and structures to prevent damage which may be caused by grading equipment.
- F. The Contractor shall lightly compact and place the topsoil.

3.03 SURPLUS MATERIAL

- A. The Contractor shall remove surplus sub-soil and topsoil from site at his expense.
- B. The Contractor shall leave stockpile areas and entire job site clean and raked, ready for landscaping operations.

END OF SECTION

SECTION 02276 TEMPORARY EROSION AND SEDIMENTATION CONTROL

PART 1 GENERAL

1.01 DESCRIPTION

- A. The work specified in this Section consists of the design, provision, maintenance and removal of temporary erosion and sedimentation controls as necessary.
- B. Temporary erosion controls include, but are not limited to: grassing, mulching, netting, watering, and the reseeding of on-site surfaces and spoil and borrow area surfaces, interceptor ditches at ends of berms and other such work at those locations which will ensure that erosion during construction will be either eliminated or maintained within acceptable limits as established by the County.
- C. Temporary sedimentation controls include, but are not limited to: silt dams, traps, barriers, and appurtenances at the foot of sloped surfaces which shall ensure that sedimentation pollution will be either eliminated or maintained within acceptable limits as established by the County.
- D. The Contractor is responsible for providing effective temporary erosion and sediment control measures during construction or until final controls become effective.

1.02 REFERENCE DOCUMENTS

- A. Florida Building Code.
- B. FDEP/COE Dredge and Fill Regulations and/or Permit as applicable.
- C. SWFWMD Permit Regulations and/or Permit as applicable.
- D. Florida Stormwater, Erosion and Sedimentation Control Inspector's Manual.

PART 2 PRODUCTS

2.01 EROSION CONTROL

- A. Netting - fabricated of material acceptable to the County.
- B. Seed and sod.

2.02 SEDIMENTATION CONTROL

- A. Bales - clean, seed free cereal hay type.
- B. Netting - fabricated of material acceptable to the County.
- C. Filter stone - crushed stone conforming to Florida Dept of Transportation specifications.
- D. Concrete block - hollow, non-load-bearing type.
- E. Concrete - exterior grade not less than one inch thick.

PART 3 EXECUTION

3.01 EROSION CONTROL

A. Minimum procedures for grassing shall be:

1. Scarify slopes to a depth of not less than six inches and remove large clods, rock, stumps, roots larger than 1/2 inch in diameter and debris.
2. Sow seed within twenty-four (24) hours after the ground is scarified with either mechanical seed drills or rotary hand seeders.
3. Apply mulch loosely and to a thickness of between 3/4-inch and 1-1/2 inches.
4. Apply netting over mulched areas on sloped surfaces.
5. Roll and water seeded areas in a manner which will encourage sprouting of seeds and growing of grass. Reseed areas which exhibit unsatisfactory growth. Backfill and seed eroded areas.

3.02 SEDIMENTATION CONTROL

A. The Contractor shall install and maintain silt dams, traps, barriers, and appurtenances as shown on the approved descriptions and working drawings. Deteriorated hay bales and dislodged filter stone shall be replaced by the Contractor at his expense.

3.03 PERFORMANCE

A. The Contractor, at his own expense, shall immediately take whatever steps are necessary to correct any deficiencies of the temporary erosion and sediment control measures employed if they fail to produce results or do not comply with the requirements of the State of Florida or any other federal, governmental or regulatory agency.

END OF SECTION

SECTION 02325 ROAD AND RAILROAD CROSSINGS

PART 1 GENERAL

1.01 SCOPE OF WORK

The Contractor shall furnish all labor, equipment, materials and incidentals required to install road or railroad crossings as shown on the Drawings and as specified herein.

1.02 OPERATIONS ON MANATEE COUNTY OR STATE OF FLORIDA PROPERTY

- A. All work affecting Manatee County, Florida Department of Transportation, any other governmental agency's right-of-way or facilities, or railroad right-of-way shall be carried out to the full satisfaction of the applicable Department's authorized representative. The Contractor shall be responsible to meet any and all requirements of the Department of Transportation, railroad, or other agency pertaining to the specific project and shall conduct all his work accordingly.
- B. Prior to the start of the jacking operation, a detailed jacking plan shall be submitted to the County for review and approval. No work shall be permitted until the submittals are accepted. A Bore Path Report shall be submitted with in three (3) days of completion of the bore.
- C. Prior to construction, a minimum of three working days written notice prior to start of the actual work shall be given to the County and to the Florida Department of Transportation or other applicable agency.
- D. The Contractor shall install, maintain and leave in place any sheeting, underpinning, cribbing and other related items (other than that required for the jacking pits) to support any structures or facility on the right-of-way owned by either Manatee County, Florida Dept. of Transportation or other governmental agency or railroad entity. The Contractor, at his expense, may be directed by the Department of Transportation, other applicable agency, or the County, to leave sheeting in place.
- E. The Contractor shall perform all necessary soil test borings to determine actual soil conditions and shall utilize the results of said borings to determine the procedures required for each jack and bore operation, including, but not limited to, the presence of rock and necessary dewatering requirements.
- F. No wires, equipment, or other appurtenances shall be permitted to be placed across or pass across State property without the express written permission of the Department of Transportation's authorized representative.
- G. All equipment used by the Contractor on State property may be inspected by the State and shall not be used if it is deemed unsatisfactory by an authorized State representative. State highways shall be kept free of obstructions at all times.
- H. No blasting shall be permitted under or adjacent to any State highways.
- I. The Contractor shall be responsible for all damages arising from his negligence or failure to comply with any State or Manatee County regulations or requirements or deviations from the Contract Documents.

- J. All State highway crossings shall be performed and completed in a manner fully satisfactory to the Department of Transportation and Manatee County.
- K. Traffic control requirements and procedures are detailed in Section 01570 of this specification.

1.03 SHOP DRAWINGS

The Contractor shall furnish working drawings showing all fabrication and construction details for the jacked crossings.

1.04 SUBMITTALS

- A. Contractor shall submit a Jacking Plan that includes the following:
 - 1. Site layout plan for entry and exit pit locations, drawn to scale, depicting the position of all required equipment, access points, existing facilities to remain in place, existing traffic lanes to be maintained in operation, office trailers and storage sites.
 - 2. Qualification information on jack/bore contractor.
 - 3. Manufacturer's information on equipment to be used.
 - 4. Methods and materials for retaining walls for jacking and receiving pits.
- B. Bore Report that details final alignment, dimensions, and record documentation.

PART 2 PRODUCTS

2.01 MATERIALS

Sleeve, carrier pipe, skids, insulation, bulkheads, etc. shall be per contract plans.

PART 3 EXECUTION

3.01 JACKING SLEEVE

- A. The Contractor shall provide all labor, material, equipment and appurtenances required for jacking the sleeves beneath the roadway or railroad tracks. The steel sleeve shall be welded steel pipe and jacked in one continuous operation at the locations shown on the drawings. Once the operation starts, jacking shall not be discontinued. Proper alignment and elevation of the sleeves shall be consistently maintained throughout the jacking operation.
- B. The Contractor shall shore the jacking pits with sheeting or such other materials as required. Sheeting shall be driven to a sufficient depth below the invert of the steel sleeve to resist any pressure developed by the soil outside the jacking pit. Sheeting shall terminate not less than 3-feet, 6-inches above existing grade.
- C. The sections of steel sleeve shall be field welded in accordance with the applicable portions of AWWA C-206 for field welded water pipe joints. Steel sleeve shall receive one coat of Tnemec 46H-413 Hi-Build Tnemec-tar applied in accordance with manufacturer's recommendation.
- D. At the completion of the jacking operations, the Contractor shall be required to leave all sheeting in place. The top of the sheeting shall be cut off 36-inches below finished grade.

- E. The Contractor shall be responsible for preventing voids outside the steel sleeves. Should they occur, the Contractor may be directed to fill them with grout in a method approved by the County. The Contractor shall exercise care in the sleeve removal to prevent voids.
- F. The Contractor shall be responsible for furnishing, installing and removing the thrust block or restraint which was employed in driving the sleeve forward. No additional payment for the jacking restraint shall be made other than the unit price for this item. The entire jacking operation shall be discussed and accepted by the County prior to commencing jack and bore operation. After completion, the backup structures shall be removed in part or whole to permit construction of the pipeline in the sleeve.

3.02 INSTALLING PIPE IN SLEEVE

- A. The Contractor shall install the pipe in full conformity with the Contract Documents. The pipe shall be installed to the lines and grades required within the sleeve and placed to the approval of the County. The pipe shall be braced to the side and the top of the sleeve to prevent flotation or motion.
- B. A bulkhead shall be placed at the ends of the sleeve to keep the surrounding soil and material from migrating into the voids in the sleeve..

3.03 TESTING

The pipe shall be tested as provided in the Contract Document.

END OF SECTION

SECTION 02355 LUMBER LEFT IN PLACE

PART 1 GENERAL

1.01 SCOPE OF WORK

The Contractor shall furnish and install shoring and sheeting as necessary to provide adequate safety.

PART 2 PRODUCTS

2.01 MATERIALS

Wood for shoring and sheeting shall be green, rough cut hardwood planking.

PART 3 EXECUTION

3.01 INSTALLATION

- A. The Contractor shall furnish, install and maintain sheeting and bracing required to support the sides of excavations, to prevent any movement which could in any way diminish the width of the excavation below which is necessary for proper construction and to protect adjacent structures from undermining or other damage. If the County determines that insufficient or improper supports have been provided, he may order additional supports to be installed at the expense of the Contractor. Compliance with such orders shall not relieve or release the Contractor from his responsibility for the sufficiency of such supports. Care shall be taken to prevent voids outside of the sheeting. Should voids form, they shall be immediately filled and rammed.
- B. The Contractor shall embed and leave in place all sheeting, bracing and other related items as shown on the Contract Drawings. The County may direct that sheeting and bracing timber be cut off at a specified elevation. No additional payment or compensation shall be made for this work.
- C. Sheeting and bracing not left in place shall be removed carefully in such manner as not to endanger other structures, utilities, property, or proposed construction.
- D. The County may order sheeting and bracing to be left in place; however, this shall not relieve the Contractor from liability for damages to persons or property due to negligence or the failure on the part of the Contractor to leave in place sufficient sheeting and bracing to prevent any caving or moving of the ground.
- E. The Contractor shall receive no payment other than that included in the pipe bid item price for any timber used for sheeting bracing, or other related items.

END OF SECTION

SECTION 02444 FENCING

PART 1 GENERAL

1.01 SCOPE OF WORK

- A. Furnish all labor, material, equipment and incidentals necessary for complete installation of vinyl coated chain link fence system with privacy decorative slatting. The fencing shall be installed according to manufacturer's specifications unless otherwise directed or authorized by the County.
- B. The Contractor's security fencing is at his expense and option and is not covered in this Section.

1.02 QUALITY ASSURANCE

- A. Standards of Manufacture shall comply with the standards of the Chain Link Fence Manufacturer's Institute for "Galvanized Steel Chain Link Fence Fabric" and as herein specified.
- B. Provide each type of steel fence and gates as a complete unit produced by a single manufacturer, including, but not limited to accessories, fittings, fasteners and appurtenances complete and ready for use.
- C. Acceptable Manufacturers: Anchor, Cyclone, or approved equal
- D. Erector Qualifications: The Contractor or approved subcontractor, must have a minimum of two years experience in similar fence installation.

1.03 SUBMITTALS

- A. Product Data:

For Steel Fences and Gates, the Contractor shall submit for review and approval to the County, five (5) copies of the manufacturer's technical data, details of fabrication, installation instructions and procedures for steel fences and gates. The Contractor shall be responsible for a copy of each instruction to be given to the Installer.

- B. Samples:

The Contractor shall submit two samples approximate size 6-inches long, or 6-inches square of fabric material, framework members and typical accessories to the County for review and approval.

- C. Certificates:

The Contractor shall provide manufacturer's certification that materials meet or exceed the Contract Document requirements.

PART 2 PRODUCTS

2.01 GENERAL

- A. The pipe sizes indicated are commercial pipe sizes.
- B. The tube sizes indicated are nominal outside dimension.
- C. Framework and appurtenances shall be finished with not less than minimum weight of zinc per sq. ft. and shall comply with the following:
 - 1. Pipe: ASTM A53 (1.8 oz. zinc psf)
 - 2. Square tubing: ASTM A 123 (2.0 oz. zinc psf)
 - 3. Hardware and Accessories: ASTM A 153 (zinc weight per Table I).
- D. All fence components shall be galvanically compatible.
- E. Vinyl coatings for fabric, posts, rails, gates, and all other fittings and components shall be thermally fused polyvinyl chloride; heavy mil coating per ASTM F 668.

2.02 FABRIC

Fabric shall be 0.148 inch (9 gage) steel wire, 2-inch diamond mesh and both top and bottom salvages shall be twisted and barbed for fabric over 60-inches high. Finish shall be hot dipped galvanized, ASTM A 392, Class II.

2.03 POSTS, RAILS AND BRACES

- A. End, Corner and Pull Posts:

The Contractor shall furnish end, corner and pull posts of the minimum size of 3" (2-1/2-inch min. OD) pipe weighing 3.65 pounds min. per linear ft.

- B. Line Post:

The Contractor shall furnish line posts of the minimum size of 2.5" Post (2-3/8-inch min. OD) pipe weighing 2.72 pounds min. per linear foot. Post shall be spaced 8 foot o.c. maximum, unless otherwise indicated:

- C. Gate Posts:

The Contractor shall furnish 4" (3-1/2-inch min. OD) gate posts for supporting a 6 feet wide, single gate leaf, or one leaf of a double gate installation, for nominal gate width; weighing 5.79 pounds min. per linear foot.

- D. Top Rails:

The Contractor shall furnish 1-5/8-inch min. Sch 40 vinyl coated top rail pipe weighing 2.27 pounds min. per linear, unless otherwise indicated.

- E. Post Brace Assembly:

The Contractor shall furnish bracing assemblies at the end, gate, at both sides of corner and pull posts, with the horizontal brace located at mid-height of the fabric. Use 1-5/8-inch min. OD pipe weighing 2.27 pounds min. per linear foot for horizontal brace and 3/8-inch diameter rod with turnbuckles for diagonal truss.

F. Tension Wire:

The Contractor shall furnish tension wire consisting of galvanized 0.177 inch (7 gage) coiled spring wire as per ASTM A824 at the bottom of the fabric only.

G. Barbed Wire Supporting Arms (only when specified):

The Contractor shall furnish pressed steel, wrought iron, or malleable iron barbed wire supporting arms, complete with provisions for anchorage to posts and attaching three rows of barbed wire to each arm. Supporting arms may be attached either to posts or integral with post top weather cap. The Contractor shall provide a single 45 degree arm for each post where indicated.

H. Barbed Wire (only when specified):

The Contractor shall furnish barbed wire. It shall be 2 strand, 12-1/2 gauge wire with 14 gauge, 4-point barbs spaced 5-inch o.c., galvanized, complying with ASTM A121, Class 3.

I. Post Tops:

The Contractor shall furnish post tops. Tops shall be pressed steel, wrought iron, or malleable iron of ASTM F626 designed as a weathertight closure cap (for tubular posts). The Contractor shall furnish one cap for each post unless equal protection is afforded by a combination of post top cap and barbed wire supporting arm. The Contractor shall furnish caps with openings to permit through passage of the top rail.

J. Stretcher Bars:

The Contractor shall furnish stretcher bars. Bars shall be one piece lengths equal to the full height of the fabric, with a minimum cross-section of 3/16-inch x 3/4-inch. The Contractor shall provide one stretcher bar for each gate and end post and two bars for each corner and pull post, except where fabric is integrally woven into the post.

K. Stretcher Bar Bands:

The Contractor shall furnish stretcher bar bands. Bands shall be steel, wrought iron, or malleable iron, a maximum space of 15-inch o.c. to secure stretcher bars to end, corner, pull and gate posts.

2.04 GATES

A. The Contractor shall provide a 6 feet high, 6 feet wide fabricated gate perimeter frames of 1-5/8-inch min. OD pipe tubular members weighting 2.27 pounds min. per linear foot. Additional horizontal and vertical members shall ensure proper gate operation and attachment of fabric, hardware and accessories. The maximum space of the frame members shall not be more than 8-inches apart.

B. The Contractor shall assemble gate frames by welding or with special malleable or pressed steel fittings and rivets for rigid connections. He shall use the same fabric width as for the fence, unless otherwise indicated in the Contract Documents or authorized by the County. He shall install the fabric with stretcher bars at vertical edges. The bars may also be used at the top and bottom edges. The contractor shall attach stretchers to the gate frame at a maximum spacing of 15-inch o.c. He shall attach the hardware with rivets or by other means

which will prevent removal or breakage.

- C. The Contractor shall install diagonal cross-bracing consisting of 3/8-inch diameter adjustable length truss rods on gates as necessary to ensure frame rigidity without sag or twist.
- D. The Contractor shall install barbed wire above the gates, (only when specified). He shall extend the end members of gate frames 12-inches above the top member which will be prepared for three strands of wire. The Contractor shall provide necessary clips for securing wire to extensions.
- E. Gate Hardware:
 - 1. The Contractor shall furnish the following hardware and accessories for each gate.
 - a. Hinges: Pressed or forged steel or malleable iron to suit gate size, non-lift-off type, offset to permit 180 degrees gate opening. Provide 1-1/2 pair of hinges for each leaf over six feet nominal height.
 - b. Latch: Forked type of plunger-bar type to permit operation from either side of gate with padlock eye as integral part of latch.
 - c. Keeper: Provide keeper for all vehicle gates, which automatically engages the gate leaf and holds it in the open position until manually released.
 - d. Double Gates: Provide gate stops for double gates, consisting of mushroom type of flush plate with anchors. Set in concrete to engage the center drip drop rod or plunger bar. Include locking device and padlock eyes as an integral part of the latch, using one padlock for locking both gate leaves.
 - e. Where gates are between masonry piers, provide "J" with 4-inch square anchor plate to masonry contractor for building in.

2.05 MISCELLANEOUS MATERIALS AND ACCESSORIES

- A. Wire Ties: The Contractor shall tie fabric to line posts. He shall use 9 gauge wire ties spaced 12-inches o.c. For tying fabric to rails and braces, he shall use 9 gauge wire ties spaced 24-inches o.c. For tying fabric to tension wire, he shall use 11 gauge hog rings spaced 24-inches o.c. The finish of ties shall match the fabric finish.
- B. Concrete: The Contractor shall provide portland cement concrete in compliance with ASTM C-150 and the Contract Documents. Aggregates shall comply with ASTM C-33. The Contractor shall mix the materials to obtain a minimum 28-day compressive strength of 3,000 psi, using a minimum of 4 sacks of cement per cubic yard, a maximum size aggregate of 1-inch, a maximum 3-inch slump and air entrainment of 2 percent to 4 percent.
- C. Privacy Decorative Slating (PDS) shall be PVC, bottom locking, non-fin type, sized to match the fabric height and color in both the fence and gates.

PART 3 EXECUTION

3.01 INSTALLATION

- A. The Contractor shall not start the fence installation prior to the final grade completion, and the finish elevations established, unless otherwise authorized by the County.

B. The Contractor shall repair damaged coatings in the shop or in the field by recoating utilizing manufacturers recommended repair compounds and as applied per manufacturer's recommendations.

C. Excavation:

1. For post footings, the Contractor shall drill holes in firm, undisturbed or compacted soil of the diameters and spacings shown or called out in the Contract Documents.
 - a. For holes not shown or called out on the Contract Documents, the Contractor shall excavate minimum diameters recommended by the fence manufacturer.
 - b. Post holes shall be in true alignment and of sufficient size to provide a permanent concrete foundation. Concrete shall be poured against undisturbed earth sides and bottom. All holes shall be 48-inches deep with posts and corner posts placed in the concrete to a depth of 36-inches. The gate posts shall be set in the concrete to a depth of 42-inches below the surface in firm, undisturbed soil. Holes shall be well centered on the posts. A minimum diameter of 12-inches shall be required for all corner and line post holes; 18-inches min. shall be required for all gate post holes.
 - c. Excavated soil shall be removed from the County's property.
 - d. If solid rock is encountered near the surface, the Contractor shall drill into rock at least 12-inches for line posts and at least 18-inches for end, pull, corner or gate posts. Hole shall be drilled to at least 1-inch greater diameter than the largest dimension of the post to be place.
 - e. If the Contractor encounters solid rock below solid overburden, he shall drill to the full depth required; however, rock penetration need not exceed the minimum depths specified.

D. Setting Posts:

1. The Contractor shall remove loose and foreign materials from the sides and bottoms of holes, and moisten soil prior to placing concrete.
 - a. Center and align posts in holes above bottom of excavation.
 - b. Place concrete around posts in a continuous pour and vibrate or tamp for consolidation. Check each post for vertical and top alignment and hold in position during placement and finishing operations. The top of concrete shall extend 2-inches above finish grade.
 - c. Trowel finish tops of footings and slope or dome to direct water away from posts. Extend footings for gate posts to the underside of bottom hinge. Set keeps, stops, sleeves and other accessories into concrete as required.
 - d. Keep exposed concrete surfaces moist for at least 7 days after placement, or cure with membrane curing materials, or other acceptable curing method.
 - e. Grout-in posts set into sleeved holes, concrete constructions, or rock excavations with non-shrink portland cement grout, or other acceptable grouting material.

E. Concrete Strength:

The Contractor shall allow the concrete to attain at least 75% of its minimum 28-day compressive strength no sooner than 7 days after placement, before rails, tension wires, barbed wire, or fabric is installed. The Contractor shall not stretch and tension fabric or wires and shall not hang gates until the concrete has attained its full design strength.

F. Top Rails:

The Contractor shall run the rail continuously through post caps or extension arms and bend to radius for curved runs. He shall provide expansion coupling as recommended by fencing manufacturer.

G. Brace Assemblies:

The Contractor shall install braces so that posts are plumb when diagonal rod is under proper tension.

H. Tension Wire:

The Contractor shall install tension wires by weaving through the fabric and tying to each post with not less than 0.177 inch (7 gage) galvanized wire, or by securing the wire to the fabric.

I. Fabric:

The Contractor shall leave approximately 3-inches between finish grade and bottom salvage, except where the bottom of the fabric extends into the concrete. He shall pull the fabric taut and tie it to posts, rails and tension wires. He shall install fabric on the security side of the fence and anchor it to the framework so that the fabric remains in tension after the pulling force is released.

J. Stretcher Bars:

The Contractor shall thread through or clamp the bars to the fabric 4-inches o.c. and secure them to posts with metal bands spaced 15-inches o.c.

K. Barbed Wire (only when specified):

The Contractor shall install 3 parallel wires on each extension arm on the security side of fence, unless otherwise indicated. He shall pull the wire taut and fasten securely to each extension arm.

L. Gate:

The Contractor shall install gates plumb, level and secure for full opening without interference. He shall install ground-set items in concrete for anchorage, as recommended by the fence manufacturer. He shall adjust hardware for smooth operation and lubricate where necessary.

M. Tie Wires:

The Contractor shall use U-shaped wire, conforming to the diameter of the attached pipe,

and shall clasp the pipe and fabric firmly with twisted ends of at least 2 full turns. He shall bend the end of the wire to minimize hazard to persons or clothing.

N. Fasteners:

The Contractor shall install nuts for tension band and hardware bolts on the side of fence opposite the fabric side. Pen ends of bolts or score threads to prevent removal of nuts.

3.02 INSTALLATION

Fence shall be constructed such that each run of fence between corner posts or gate posts has equal spacing between the line posts. Spacing shall not exceed 8 feet.

END OF SECTION

SECTION 02480 LANDSCAPING

PART 1 GENERAL

1.10 SCOPE OF WORK

- A. The Contractor shall furnish all labor, materials, equipment, and incidentals required to install trees, ground cover, and shrubs, to place accessory planting materials, to maintain and guarantee all planted areas. All work shall be in strict accordance with sound nursery practice and shall include maintenance and watering of all of the work of this Contract until final completion and acceptance by the County.
- B. The landscaping shall be performed by a contractor or subcontractor who specializes in landscaping and who is fully familiar and experienced in projects of this type and scope. The landscaping contractor or subcontractor shall be subject to the approval of the County.
- C. The Contractor shall provide all landscaping complete and ready for use as specified in the Contract Documents and as shown on the Drawings.

1.02 SUBMITTALS

- A. The Contractor shall submit to the County for review and approval, shop drawings and complete written maintenance instructions for each type of plant furnished under this Contract.
- B. The Contractor shall submit representative samples of any or all of required accessory planting materials as requested by the County.

1.03 OBSTRUCTIONS BELOW GROUND

- A. The County may change the location of plant material if underground construction, utilities or obstructions are encountered in excavation of planting areas or pits.
- B. The Contractor shall make such changes without additional compensation from the County.

PART 2 PRODUCTS

2.01 MATERIALS

- A. Plant species and size shall conform to those indicated in the Plant List and in plan locations shown on the Drawings. Nomenclature shall conform to the Florida Department of Agriculture: "Grades and Standards for Nursery Plants". The designated authority for identification of plants shall be in conformance with FDOT Standard Specification Section 580-2.1.1 Plants.
- B. Plants shall be sound, healthy, vigorous, free from plant diseases, insects, pests, or their eggs and shall have healthy normal root systems. Plants shall be nursery grown stock, freshly dug. No heeled in, cold storage, or collected stock shall be accepted.
- C. Shape and Form
 - 1. Plant material shall be symmetrical, typical for the variety and species, and shall conform to the measurements specified in the Plant List.

2. Plants used where symmetry is required shall be matched as nearly as possible.
 3. Plants shall not be pruned prior to delivery except as authorized by the County.
 4. All plants shall have been transplanted or root pruned at least once in the past three years.
 5. Unless otherwise noted, street trees shall be free of branches up to six feet, with the single leader well branched, and with straight trunks.
 6. Shrubs shall have been transplanted twice, have fully developed root systems, be heavily canned with foliage to base, fulfill dimensions required, and be typical of species.
 7. Ground covers shall have sturdy fibrous root systems and shall be heavily leafed.
- D. Measurement: The height and/or width of trees shall be measured from the ground or across the normal spread of branches with the plants in their normal position. This measurement shall not include the immediate terminal growth.
- E. Substitutions in plant species or size shall be made only with the written approval of the County.
- F. Ground cover plants shall be planted in beds of four inches of approved topsoil. The beds shall be thoroughly disked into the soil. The compacted and settled finished surface shall be set to the required grade. Plants shall be spaced as described in the Contract Documents or shown on the Contract Drawings, or otherwise directed by the County in accordance with the best practices of the trade.
- G. Planting Soil
1. Soil for backfilling around plants and planting beds shall be a good grade of garden loam as approved by the County. Soil shall be free of heavy clay, coarse sand, stones, lumps, sticks, or other foreign material. The soil shall not be delivered or used in a muddy condition.
 2. The soil shall be taken from ground that has never been stripped. There shall be a slight acid reaction to the soil with no excess of calcium or carbonate. The soil shall be free from excess weeds or other objectionable material.
 3. Soil for trees and shrubs shall be delivered in a loose, friable condition. All trees shall average approximately one cubic yard per tree, except Sabal Palmetto, which shall be planted with clean sand. There shall be a minimum of 4-inches of planting soil in ground cover areas and 1/8 cubic yard per shrub or vine.
 4. No marl shall be allowed in ground cover planting beds.
- H. Before plants are backfilled with planting soil, fertilizer tablets, Agriform 20-10-5 or equal, shall be placed in each pit. The Contractor shall provide three tablets for each tree and one for each shrub or vine.
- I. Tree Staking: All tree staking and bracing shall be included herein in accordance with sound nursery practice and shall be in accordance with the Contract Documents. The Contractor shall furnish all materials required for staking and bracing as approved.
- J. Landscaping stones shall be inert and nonleaching. The Contractor shall provide physical samples for approval prior to installation. Crushed limerock shall not be acceptable.

PART 3 EXECUTION

3.01 PLANTING PROCEDURES

- A. Plant Locations: All plants shall be located as shown on the Drawings, to dimensions if shown, to scale if not dimensioned. Large areas or beds shall be scaled and the plants spaced evenly. Approval by the County is required before any plants may be installed.
- B. Tree Pits: Pits for trees shall be at least two feet greater in diameter than the specified diameter of the ball. Pits shall be of sufficient depth to allow a 12-inch layer of planting soil under the ball when it is set to grade. Bottom of pit shall be loosened prior to backfilling.
- C. Digging and Handling
 - 1. Plants shall be handled at all times so that roots or balls are adequately protected from sun or drying winds. Tops or roots of plant allowed to dry out will be rejected.
 - 2. Balled and burlapped plants shall be moved with firm, natural balls of soil, not less than one foot diameter of ball to every one inch caliper of trunk, and a depth of not less than 2/3 of ball diameter. No plant shall be accepted when the ball of earth surrounding its roots has been cracked or broken. All trees, except palms, shall be dug with ball and burlapped. Root pruning shall have been done at minimum of four weeks before planting at the job.
 - 3. Bare root plants shall be dug with spread of root and of sufficient depth to insure full recovery of plant.
- D. Cabbage Palms (Sable Palmetto):
 - 1. Cabbage Palms shall be taken from moist black sand areas. Only a minimum of fronds shall be removed from the crown to facilitate moving and handling. Clear trunk or overall height shall be as specified after the minimum of fronds have been removed.
 - 2. Cabbage Palms buds shall be tied to a suitable support with a burlap strip, to be left in place until the tree is well established in its new location.
 - 3. Cabbage Palms shall be planted in sand, thoroughly washed in during planting operations, and with a dished or saucer depression left at the soil line for future waterings. Palms with marred or burned trunks will be accepted at the discretion of the County only.
 - 4. Trees moved by winch or crane shall be thoroughly protected from chain marks, girdling or bark slippage by means of burlap, wood battens, or other approved method.
- E. When balled or burlapped plants are set, planting soil shall be carefully tamped under and around the base of the balls to prevent voids. All burlap, rope, wires, etc., shall be removed from the sides and tops of balls, but no burlap shall be pulled from underneath. Roots of bare rooted plants shall be properly spread out and planting soil carefully worked in among them.
- F. All plants shall be set straight or plumb, in locations shown on the Drawings. Except as otherwise specified, plants shall be planted in pits which shall be set at such level that, after settlement, they bear the same relation to the finished grade or the surrounding ground as they bore to the grade of the soil from which they are taken.
- G. Pruning shall be carefully done by experienced plantsmen. Prune immediately upon acceptance by the County, including any broken branches, thinning small branches and tipping back main branches (except main leaders).
- H. Excess soil and debris shall be disposed of off the project site unless ordered stockpiled by the County.

3.02 NORMAL MAINTENANCE OF PLANT MATERIALS

- A. Plant material maintenance shall begin when planting operations start and shall extend until final acceptance of work.
- B. Maintain all plant materials under this Contract to the satisfaction of the County. Maintenance shall include necessary watering, cultivation, weeding, pruning, spraying, tightening and repair to guy wires, removal of dead material, resetting, and other work required to conform with referenced standards and accepted nursery standards as approved.
- C. Plant materials which are in a tilted or in a leaning position shall be properly righted.
- D. After final acceptance by the County and until one calendar year after acceptance of all plantings, the landscaping contractor or subcontractor shall make monthly inspections of materials and report in writing to the County the conditions of the plants and the necessary requirements to keep the plants in a healthy growing condition.

3.03 TREE AND PLANT PROTECTION

- A. The Contractor shall remove all trees (if any) within the limit of landscaping shown on the detail sheet except those designated to be salvaged (if any). Prior to removal of said trees, the Contractor shall obtain a tree removal permit, if required. All other trees in the vicinity of the work shall be protected against damage by the Contractor until all work under the Contract has been completed.
- B. Consult with the County, and remove agreed-on roots and branches which interfere with construction. Employ qualified tree surgeon to remove, and to treat cuts.
- C. Provide temporary barriers to a height of six feet around each group of trees and plants.
- D. Protect root zones of trees and plants
 - 1. Do not allow vehicular traffic or parking.
 - 2. Do not store materials or products.
 - 3. Prevent dumping or refuse or chemically injurious materials or liquids.
 - 4. Prevent puddling or continuous running water.
- E. Carefully supervise excavating, grading, and filling, and subsequent construction operations, to prevent damage.
- F. In case of inadvertent damage to any tree or plant by the Contractor or any of his subcontractors or employees, the Contractor shall provide replacement of each such damaged tree or plant with a new one of acceptable type, size and quality.
- G. Completely remove barricades, including foundations, when construction has progressed to the point that they are no longer needed, and when approved by the County.
- H. Clean and repair damage caused by installation, fill and grade the areas of the site to required elevations and slopes, and clean the area.

3.04 GUARANTEE

The life and satisfactory condition of all plant material planted shall be guaranteed by the Contractor for a minimum of one calendar year. Guarantee shall include complete replacement with material of the same kind and size as in the original work if not in a healthy condition, as determined by the County, at the end of the guarantee period.

3.05 REPLACEMENT

- A. At the end of the guarantee period, any plant required under this Contract that is dead or not in satisfactory growth as determined by the County, shall be removed. Plants replaced shall be guaranteed for 90 days after date of replacement.
- B. Replacement of plants necessary during guarantee period shall be the responsibility of the Contractor, except for possible replacements of plants resulting from removal, vandalism, acts of neglect on the part of others, or acts of God.
- C. All replacements shall be plants of the same kind and size as specified in the Drawings. They shall be furnished and planted as herein specified. The cost shall be the responsibility of the Contractor.

END OF SECTION

SECTION 02485 SEEDING AND SODDING

PART 1 GENERAL

1.01 SCOPE OF WORK

- A. The Contractor shall furnish all labor, materials and equipment necessary to satisfactorily return all construction areas to their original conditions or better.
- B. Work shall include furnishing and placing seed or sod, fertilizing, planting, watering and maintenance until acceptance by County.

1.02 RELATED WORK NOT INCLUDED

Excavation, filling and grading required to establish elevation shown on the Drawings are included under other sections of these Specifications.

1.03 QUALITY ASSURANCE

- A. It is the intent of this Specification that the Contractor is obliged to deliver a satisfactory stand of grass as specified. If necessary, the Contractor shall repeat any or all of the work, including grading, fertilizing, watering and seeding or sodding at no additional cost to the County until a satisfactory stand is obtained. For purposes of grassing, a satisfactory stand of grass is herein defined as a full lawn cover over areas to be sodded or seeded, with grass free of weeds, alive and growing, leaving no bare spots larger than 3/4 square yard within a radius of 8 feet.
- B. All previously grassed areas where pipelines are laid shall be sodded. All sodding and grassing shall be installed in accordance with these Specifications or as directed by the County.

PART 2 PRODUCTS

2.01 MATERIALS

- A. Fertilizer: The fertilizer shall be of the slow-release type meeting the following minimum requirements: 12 percent nitrogen, 8 percent phosphorus, 8 percent potassium; 40 percent other available materials derived from organic sources. At least 50 percent of the phosphoric acid shall be from normal super phosphate or an equivalent source which will provide a minimum of two units of sulfur. The amount of sulfur shall be indicated on the quantitative analysis card attached to each bag or other container. Fertilizer shall be uniform in composition, dry and free flowing delivered to sites in original unopened containers bearing manufacturer's statement or guarantee.
- B. Seeding/Grassing: The Contractor shall grass all unpaved areas disturbed during construction which do not require sod. All grassing shall be completed in conformance with FDOT Specifications, Sections 570 and 981. The grassed areas shall be mulched and fertilized in accordance with FDOT Specifications, except that no additional payment will be made for mulching, fertilizing and/or watering.
- C. Sodding: Sod shall be provided as required on the construction drawings or at locations as directed by the County in accordance with Florida Department of Transportation, Specifications Section 575 and 981. The Contractor shall furnish bahia grass sod or match

existing sod. Placement and watering requirements shall be in accordance with FDOT Specifications Section 575, except that no additional payment will be made for placement and/or watering. This cost shall be included in the Contract price bid for sodding.

- D. Topsoil: Topsoil stockpiled during excavation may be used as necessary. If additional topsoil is required to replace topsoil removed during construction, it shall be obtained off site at no additional cost to the County. Topsoil shall be fertile, natural surface soil, capable of producing all trees, plants and grassing specified herein.
- E. Water: It is the Contractor's responsibility to supply all water to the site, as required during seeding and sodding operations and through the maintenance period and until the work is accepted. The Contractor shall make whatever arrangements that may be necessary to ensure an adequate supply of water to meet the needs for his work. He shall also furnish all necessary hose, equipment, attachments and accessories for the adequate irrigation of lawns and planted areas as may be required. Water shall be suitable for irrigation and free from ingredients harmful to plant life.

PART 3 EXECUTION

3.01 INSTALLATION

- A. When the trench backfill has stabilized sufficiently, the Contractor shall commence work on lawns and grassed areas, including fine grading as necessary and as directed by the County.
- B. Finish Grading: Areas to be seeded or sodded shall be finish graded, raked, and debris removed. Soft spots and uneven grades shall be eliminated. The County shall approve the finish grade of all areas to be seeded or sodded prior to seed or sod application.
- C. Areas to be sodded shall be excavated or cut-down to accept the approximate 2" thick sod, so finish grade matches existing. Sod shall not be thrown over top of existing sod or debris.
- D. Protection: Seeded and sodded areas shall be protected against traffic or other use by placing warning signs or erecting barricades as necessary. Any areas damaged prior to acceptance by the County shall be repaired by the Contractor as directed by the County.

3.02 CLEANUP

Soil or similar materials spilled onto paved areas shall be removed promptly, keeping those areas as clean as possible at all times. Upon completion of seeding and sodding operations, all excess soil, stones and debris remaining shall be removed from the construction areas.

3.03 LANDSCAPE MAINTENANCE

- A. Any existing landscape items damaged or altered during construction by the Contractor shall be restored or replaced as directed by the County.
- B. Maintain landscape work for a period of 90 days immediately following complete installation of work or until County accepts project. Watering, weeding, cultivating, restoration of grade, mowing and trimming, protection from insects and diseases, fertilizing and similar operations as needed to ensure normal growth and good health for live plant material shall be included at no additional cost to the County.

3.04**REPAIRS TO LAWN AREAS DISTURBED BY CONTRACTOR'S OPERATORS**

Lawn areas planted under this Contract and all lawn areas damaged by the Contractor's operation shall be repaired at once by proper soil preparation, fertilizing and sodding, in accordance with these Specifications.

END OF SECTION

SECTION 02513 ASPHALT CONCRETE PAVING

PART 1 GENERAL

1.01 SCOPE OF WORK

The Contractor shall furnish all labor, materials and equipment necessary to complete all milling asphalt pavement and asphalt concrete paving (including restoration of driveways) as called out on the Contract Documents or as shown on the Drawings.

1.02 QUALITY ASSURANCE

- A. Qualifications of Asphalt Concrete Producer: The only materials permitted shall be furnished by a bulk asphalt concrete producer exclusively engaged in the production of hot-mix, hot-laid asphalt concrete.
- B. Qualification of Testing Agency: The County may employ a commercial testing laboratory to conduct tests and evaluations of asphalt concrete materials and design. The Contractor shall:
 - 1. Provide asphalt concrete testing and inspection service acceptable to County.
 - 2. Include sampling and testing asphalt concrete materials proposed, and tests and calculations for asphalt concrete mixtures.
 - 3. Provide field testing facilities for quality control testing during paving operations.
- C. Requirements of Regulatory Agencies: The Contractor shall comply with the applicable requirements of:
 - 1. Manatee County Utility Operations Department
 - 2. Manatee County Transportation Department
 - 3. State of Florida Dept. of Transportation

1.03 PAVING QUALITY REQUIREMENTS

- A. General: In addition to other specified conditions, the Contractor shall comply with the following minimum requirements:
 - 1. In-place asphalt concrete course shall be tested for compliance with requirements for density, thickness and surface smoothness.
 - 2. Final surface shall be provided of uniform texture, conforming to required grades and cross sections.
 - 3. A minimum of four inch diameter pavement specimens for each completed course shall be taken from locations as directed by the County.
 - 4. Holes from test specimens shall be repaved as specified for patching defective work.
- B. Density:
 - 1. When subjected to 50 blows of standard Marshall hammer on each side of an in place material specimen, densities shall be comparable to a laboratory specimen of same asphalt concrete mixture.
 - 2. The minimum acceptable density of in-place course material shall be 98% of the recorded laboratory specimen density.

- C. Thickness: In-place compacted thicknesses shall not be acceptable if less than the minimum thicknesses shown on the Drawings.
- D. Surface Smoothness:
 - 1. Finished surface of each asphalt concrete course shall be tested for smoothness, using a 10 ft. straightedge applied parallel to and at right angles to centerline of paved areas.
 - 2. Surface areas shall be checked at intervals directed by County.
 - 3. Surfaces shall not be acceptable if they exceed the following:
 - a. Base Course: 1/4 in. in 10 ft.
 - b. Surface Course: 3/16 in. in 10 ft.
 - c. Crowned Surfaces:
 - (1) Test crowned surfaces with a crown template, centered and at right angles to the crown.
 - (2) Surfaces will not be acceptable if varying more than 1/4 in. from the template.

1.04 SUBMITTALS

- A. Samples: The Contractor may be required to provide samples of materials for laboratory testing and job-mix design.
- B. Test Reports: The Contractor shall submit laboratory reports for following materials tests:
 - 1. Coarse and fine aggregates from each material source and each required grading:
 - a. Sieve Analysis: ASTM C 136 (AASHTO T 27).
 - b. Unit Weight of Slag: ASTM C29 (AASHTO T 19).
 - c. Soundness: ASTM C 88 (AASHTO T 104) for surface course aggregates only.
 - d. Sand Equivalent: ASTM D 2419 (AASHTO T 176).
 - e. Abrasion of Coarse Aggregate: ASTM C131 (AASHTO T 96), for surface course aggregates only.
 - 2. Asphalt cement for each penetration grade:
 - a. Penetration: ASTM D5 (AASHTO T49).
 - b. Viscosity (Kinematic): ASTM D2170 (AASHTO T 201).
 - c. Flash Point: ASTM D92 (AASHTO T 48).
 - d. Ductility: ASTM D 113 (AASHTO T 51).
 - e. Solubility: ASTM D 4 (AASHTO T 44).
 - f. Specific Gravity: ASTM D 70 (AASHTO T 43).
 - 3. Job-mix design mixtures for each material or grade:
 - a. Bulk Specific Gravity for Coarse Aggregate: ASTM C 117(AASHTO T 85).
 - b. Bulk Specific Gravity for Fine Aggregate: ASTM C 128(AASHTO T 84).
 - 4. Uncompacted asphalt concrete mix: Maximum Specific Gravity: ASTM D 2041 (AASHTO T 209).
 - 5. Compacted asphalt concrete mix:
 - a. Bulk Density: ASTM D 1188 (AASHTO T 166).
 - b. Marshall Stability and Flow: ASTM D 1559.
 - 6. Density and voids analysis:
 - a. Provide each series of asphalt concrete mixture test specimens, in accordance with A.I. MS-2 "Mix Design Methods for Asphalt Concrete".
 - b. Use Marshall method of mix design unless otherwise directed or acceptable to the County.
 - c. Report the quantity of absorbed asphalt cement in pounds of dry aggregate,

- percent air voids, and percent voids in mineral aggregate.
7. Sampling and testing of asphalt concrete mixtures for quality control during paving operations:
 - a. Uncompacted asphalt concrete mix.
 - (1) Asphalt Cement Content: ASTM D 2172 (AASHTO T 164).
 - (2) Penetration of Recovered Asphalt Cement: ASTM D 5(AASHTO T 49).
 - (3) Ductibility of Recovered Asphalt Cement: ASTM D 113(AASHTO T 51).
 - b. Compacted asphalt concrete mix:
 - (1) Bulk Density: ASTM D 1188 (AASHTO T 166).
Marshall Stability and Flow: ASTM D1559).
 - c. Perform at least one test for each day's paving.
 8. Asphalt plant inspection: ASTM D 290.
 9. Additional testing:
 - a. Retesting shall be required if previous tests indicate insufficient values, or if directed by the County.
 - b. Testing shall continue until specified values have been attained.
 10. Asphalt concrete materials which do not comply with specified requirements shall not be permitted in the work.

1.05 JOB CONDITIONS

A. Weather Limitations:

1. Apply bituminous prime and tack coats only when the ambient temperature in the shade is 50 degrees F. and when the temperature has not been below 35 degrees F. for 12 hours immediately prior to application.
2. Do not apply when the base surface is wet or contains an excess of moisture which would prevent uniform distribution and the required penetration.
3. Construct asphalt concrete surface course only when atmospheric temperature is above 40 degrees F., when the underlying base is dry, and when weather is not rainy.
4. Base course may be placed when air temperature is not below 30 degrees F. and rising, when acceptable to the County.

B. Grade Control: Establish and maintain the required lines and grades, including crown and cross-slope, for each course during construction operations.

C. Traffic Control: Maintain vehicular and pedestrian traffic during paving operations, as required for other construction activities.

PART 2 PRODUCTS

2.01 MATERIALS

A. Soil Cement or Shell Base Course: as specified in FDOT Section 270, "Material for Base and Stabilized Base", and as called for in the Contract Documents.

B. Aggregate for Asphalt Concrete, General:

1. Sound, angular crushed stone, crushed gravel, or crushed slag: ASTM D 692.
2. Sand, stone, or slag screening: ASTM D 1073.

3. Provide aggregate in gradations for various courses to comply with local highway standards.
- C. Surface Course Aggregates:
1. Provide natural sand, unless sand prepared from stone, slag, or gravel or combinations are required to suit local conditions.
- D. Asphalt Cement: Comply with ASTM D 946 for 85-100 penetration grade.
- E. Prime Coat:
1. Cut-back liquid asphalt.
 2. Medium-Curing type: ASTM D 2027, Grade MC-70.

2.02 ASPHALT-AGGREGATE MIXTURES

- A. Job-mix criteria:
1. Provide job-mix formulas for each required asphalt-aggregate mixture.
 2. Establish a single percentage of aggregate passing each required sieve size, a single percentage of asphalt cement to be added to aggregate, and a single temperature at which asphalt concrete is to be produced.
 3. Comply with the mix requirements of local governing highway standards.
 4. Maintain material quantities within allowable tolerances of the governing standards.

2.03 TRAFFIC AND PARKING MARKING MATERIALS

- A. Traffic lane marking paint with chlorinated rubber base.
- B. Factory mixed, quick drying and non bleeding, FS TT-P-115C, Type III.
- C. Color: Driving Lane Dividers - White
 No Parking Zone - Yellow
 Parking Dividers - White

PART 3 EXECUTION

3.01 SURFACE PREPARATION

- A. Subbase Preparation:
1. The Contractor shall remove from the area all organic substance encountered to a depth of six or eight inches (6" or 8"), or to such depth and width as directed by the County. The entire area shall be plowed and dragged prior to placing a stabilizing additive, if required to meet minimum bearing value.
 2. Subbase shall be compacted to a minimum density of 98 percent of the maximum as determined by the Modified Proctor Density AASHTO T180, and shall have a minimum bearing value of 40 pounds per square inch as determined by the Florida Bearing Test.
- B. Base Course:

1. Check subgrade for conformity with elevations and section immediately before placing base material.
2. Place base material in compacted layers not more than 6 inches thick, unless continuing tests indicate the required results are being obtained with thicker layers.
3. In no case will more than 8-inches of compacted base be placed in one lift.
4. Spread, shape, and compact all base material deposited on the subgrade during the same day.
5. Compact base course material to be not less than 98% of maximum density: ASTM D 1557, Method D (98 percent maximum density: AASHTO T-180).
6. Test density of compacted base course: ASTM D 2167.
7. Conduct one test for each 250 sq. yds. of in-place material, but in no case not less than one daily for each layer.

C. Loose and Foreign Material:

1. Remove loose and foreign material from compacted subbase surface immediately before application of paving.
2. Use power brooms or blowers, and brooming as required.
3. Do not displace subbase material.

D. Prime Coat:

1. Uniformly apply at rate of 0.20 to 0.5 gal. per sq. yd. over compacted and cleaned subbase surface.
2. Apply enough material to penetrate and seal, but not flood the surface.
3. Allow to cure and dry as long as required to attain penetration and evaporation of volatile, and in no case less than 24 hours unless otherwise acceptable to the County.
4. Blot excess asphalt with just enough sand to prevent pick-up under traffic.
5. Remove loose sand before paving.

E. Tack Coat:

1. Dilute material with equal parts of water and apply to contact surfaces of previously constructed asphalt concrete or portland cement concrete and similar surfaces.
2. Apply at rate of 0.05 to 0.15 gal. per sq. yd. of surface.
3. Apply tack coat by brush to contact surfaces of structures projecting into or abutting asphalt concrete pavement.
4. Allow surfaces to dry until material is at condition of tackiness to receive pavement.

3.02 MANHOLE FRAME / VALVE BOX ADJUSTMENTS (IF APPLICABLE)

A. Placing Manhole frames:

1. Surround manhole frames set to elevation with a ring of compacted asphalt concrete base prior to paving.
2. Place asphalt concrete mixture up to 1 in. below top of frame, slope to grade, and compact by hand tamping.

B. Adjust manhole frames to proper position to meet paving.

C. If permanent covers are not in place, provide temporary covers over openings until completion of rolling operations.

- D. Set cover manhole frames to grade, flush with surface of adjacent pavement.

3.03 PREPARING THE MIXTURE

- A. Comply with ASTM D 995 for material storage, control, and mixing, and for plant equipment and operation.
- B. Stockpiles:
 - 1. Keep each component of the various-sized combined aggregates in separate stockpiles.
 - 2. Maintain stockpiles so that separate aggregate sizes shall not be intermixed.
- C. Heating:
 - 1. Heat the asphalt cement at the mixing plant to viscosity at which it can be uniformly distributed throughout mixture
 - 2. Use lowest possible temperature to suit temperature-viscosity characteristics of asphalt.
 - 3. Do not exceed 350 degrees F. (176.6 degrees C.).
- D. Aggregate:
 - 1. Heat-dry aggregates to reduce moisture content to not more than 2.0%.
 - 2. Deliver dry aggregate to mixer at recommended temperature to suit penetration grade and viscosity characteristics of asphalt cement, ambient temperature, and workability of mixture.
 - 3. Accurately weigh or measure dry aggregates and weigh or meter asphalt cement to comply with job-mix formula requirements.
- E. Mix aggregate and asphalt cement to achieve 90-95% of coated particles for base mixtures and 85-90% of coated particles for surface mixture, when tested in accordance with ASTM D 2489.
- F. Transporting:
 - 1. Transport asphalt concrete mixtures from mixing site in trucks having tight, clean compartments.
 - 2. Coat hauling compartments with a lime-water mixture to prevent asphalt concrete mixture from sticking.
 - 3. Elevate and drain compartment of excess solution before loading mix.
 - 4. Provide covers over asphalt concrete mixture when transporting to protect from weather and to prevent loss of heat.
 - 5. During periods of cold weather or for long-distance deliveries, provide insulation around entire truck bed surfaces.

3.04 EQUIPMENT

- A. Provide size and quantity of equipment to complete the work specified within project time schedule.
- B. Bituminous Pavers: Self-propelled that spread hot asphalt concrete mixtures without tearing, shoving or gouging surfaces, and control pavement edges to true lines without use

of stationary forms.

C. Rolling Equipment:

1. Self-propelled, steel-wheeled and pneumatic-tired rollers that can reverse direction without backlash.
2. Other type rollers may be used if acceptable to the County.

D. Hand Tools: Provide rakes, lutes, shovels, tampers, smoothing irons, pavement cutters, portable heaters, and other miscellaneous small tools to complete the work specified.

3.05 PLACING THE MIX

A. Place asphalt concrete mixture on prepared surface, spread and strike-off using paving machine.

B. Spread mixture at a minimum temperature of 225 degrees F. (107.2 degrees C.).

C. Inaccessible and small areas may be placed by hand.

D. Place each course at thickness so that when compacted, it will conform to the indicated grade, cross-section, finish thickness, and density indicated.

E. Paver Placing:

1. Unless otherwise directed, begin placing along centerline of areas to be paved on crowned section, and at high side of sections on one-way slope, and in direction of traffic flow.
2. After first strip has been placed and rolled, place succeeding strips and extend rolling to overlap previous strips.
3. Complete base courses for a section before placing surface courses.
4. Place mixture in continuous operation as practicable.

F. Hand Placing:

1. Spread, tamp, and finish mixture using hand tools in areas where machine spreading is not possible, as acceptable to County.
2. Place mixture at a rate that will insure handling and compaction before mixture becomes cooler than acceptable working temperature.

G. Joints:

1. Carefully make joints between old and new pavements, or between successive days' work, to ensure a continuous bond between adjoining work.
2. Construct joints to have same texture, density and smoothness as adjacent sections of asphalt concrete course.
3. Clean contact surfaces free of sand, dirt, or other objectionable material and apply tack coat.
4. Offset transverse joints in succeeding courses not less than 24 inches.
5. Cut back edge of previously placed course to expose an even, vertical surface for full course thickness.
6. Offset longitudinal joints in succeeding courses not less than 6 inches.
7. When the edges of longitudinal joints are irregular, honeycombed, or inadequately compacted, cut back unsatisfactory sections to expose an even, vertical surface for

full course thickness.

3.06 COMPACTING THE MIX

- A. Provide sufficient rollers to obtain the required pavement density.
- B. Begin rolling operations as soon after placing when the mixture will bear weight of roller without excessive displacement.
- C. Do not permit heavy equipment, including rollers to stand on finished surface before it has thoroughly cooled or set.
- D. Compact mixture with hot hand tampers or vibrating plate compactors in areas inaccessible to rollers.
- E. Start rolling longitudinally at extreme lower side of sections and proceed toward center of pavement. Roll to slightly different lengths on alternate roller runs.
- F. Do not roll centers of sections first under any circumstances.
- G. Breakdown Rolling:
 - 1. Accomplish breakdown or initial rolling immediately following rolling of transverse and longitudinal joints and outside edge.
 - 2. Operate rollers as close as possible to paver without causing pavement displacement.
 - 3. Check crown, grade, and smoothness after breakdown rolling.
 - 4. Repair displaced areas by loosening at once with lutes or rakes and filling, if required, with hot loose material before continuing rolling.
- H. Second Rolling:
 - 1. Follow breakdown rolling as soon as possible, while mixture is hot and in condition for compaction.
 - 2. Continue second rolling until mixture has been thoroughly compacted.
- I. Finish Rolling:
 - 1. Perform finish rolling while mixture is still warm enough for removal of roller marks.
 - 2. Continue rolling until roller marks are eliminated and course has attained specified density.
- J. Patching:
 - 1. Remove and replace defective areas.
 - 2. Cut-out and fill with fresh, hot asphalt concrete.
 - 3. Compact by rolling to specified surface density and smoothness.
 - 4. Remove deficient areas for full depth of course.
 - 5. Cut sides perpendicular and parallel to direction of traffic with edges vertical.
 - 6. Apply tack coat to exposed surfaces before placing new asphalt concrete mixture.

3.07 MARKING ASPHALT CONCRETE PAVEMENT

- A. Cleaning:
 - 1. Sweep surface with power broom supplemented by hand brooms to remove loose material and dirt.
 - 2. Do not begin marking asphalt concrete pavement until acceptable to the County.
- B. Apply paint with mechanical equipment.
 - 1. Provide uniform straight edges.
 - 2. Not less than two separate coats in accordance with manufacturer's recommended rates.

3.08 CLEANING AND PROTECTION

- A. Cleaning: After completion of paving operations, clean surfaces of excess or spilled asphalt materials to the satisfaction of the County.
- B. Protection:
 - 1. After final rolling, do not permit vehicular traffic on asphalt concrete pavement until it has cooled and hardened, and in no case sooner than 6 hours.
 - 2. Provide barricades and warning devices as required to protect pavement.
 - 3. Cover openings of structures in the area of paving until permanent coverings are placed (if applicable).

END OF SECTION

SECTION 02575 PAVEMENT REPAIR AND RESTORATION

PART 1 GENERAL

1.01 SCOPE OF WORK

The Contractor shall furnish all labor, materials, equipment, obtain County or State right-of-way permits and incidentals required and remove and replace pavements over trenches excavated for installation of water or sewer lines and appurtenances as shown on the Contract Drawings.

1.02 GENERAL

- A. The Contractor shall take before and after photographs.
- B. The Contractor shall repair in a manner satisfactory to the County or State, all damage done to existing structures, pavement, driveways, paved areas, curbs and gutters, sidewalks, shrubbery, grass, trees, utility poles, utility pipe lines, conduits, drains, catch basin, flagstones, or stabilized areas or driveways and including all obstructions not specifically named herein, which results from this Project.
- C. The Contractor shall keep the surface of the backfilled area of excavation in a safe traffic bearing condition and firm and level with the remaining pavement until the pavement is restored in the manner specified herein. All surface irregularities that are dangerous or obstructive to traffic are to be removed. The repair shall conform to applicable requirements of Manatee County Transportation Department requirements for pavement repair and as described herein, including all base, subbase and asphalt replacement.
- D. All materials and workmanship shall meet or exceed the County requirements and as called for in the Contract Documents and nothing herein shall be construed as to relieve the Contractor from this responsibility.
- E. All street, road and highway repair shall be made in accordance with the FDOT and County details indicated on the Drawings and in accordance with the applicable requirements and approval of affected County and State agencies.

PART 2 PRODUCTS

2.01 PAVEMENT SECTION

- A. Asphaltic concrete shall consist of asphalt cement, coarse aggregate, fine aggregate and mineral filler conforming to FDOT Type S-III Asphalt. Pavement replacement thickness shall match that removed but in no case shall be less than 1-1/2" compacted thickness. All asphalt concrete pavement shall be furnished, installed and tested in accordance with FDOT Specifications for Road and Bridge Construction.
- B. Asphalt or crushed concrete or approved equal base material shall be furnished and installed under all pavement sections restored under this Contract. Asphalt base shall have a minimum 6" compacted thickness, meet requirements for FDOT ABC III (Minimum Marshall Stability of 1000) and be furnished, installed and tested in accordance with the requirements of the FDOT Standards. Crushed concrete base shall be 10" minimum compacted thickness. Crushed concrete aggregate material shall have a minimum LBR of

140 compacted to 98% T-180 AASHTO density. Asphalt base and crushed concrete base are acceptable. Other bases shall be submitted for approval.

- C. Prime and tack will be required and applied in accordance with Section 300 - FDOT Specifications: Prime and Tack Coat for Base Courses.

PART 3 EXECUTION

3.01 CUTTING PAVEMENT

- A. The Contractor shall saw cut in straight lines and remove pavement as necessary to install the new pipelines and appurtenances and for making connections to existing pipelines.
- B. Prior to pavement removal, the Contractor shall mark the pavement for cuts nearly paralleling pipe lines and existing street lines. Asphalt pavement shall be cut along the markings with a rotary saw or other suitable tool. Concrete pavement shall be scored to a depth of approximately two (2) inches below the surface of the concrete along the marked cuts. Scoring shall be done by use of a rotary saw, after which the pavement may be broken below the scoring with a jackhammer or other suitable equipment.
- C. The Contractor shall not machine pull the pavement until it is completely broken and separated along the marked cuts.
- D. The pavement adjacent to pipe line trenches shall neither be disturbed nor damaged. If the adjacent pavement is disturbed or damaged, irrespective of cause, the Contractor shall remove and replace the pavement. In addition, the base and sub-base shall be restored in accordance with these Specifications, Florida Dept. of Transportation Standard Specifications and as directed by the County.

3.02 PAVEMENT REPAIR AND REPLACEMENT

- A. The Contractor shall repair, to meet or exceed original surface material, all existing concrete or asphaltic pavement, driveways, or sidewalks cut or damaged by construction under this Contract. He shall match the original grade unless otherwise specified or shown on the Drawings. Materials and construction procedures for base course and pavement repair shall conform to those of the Florida Dept. of Transportation.
- B. The Contractor's repair shall include the preparation of the subbase and base, place and maintain the roadway surface, any special requirements whether specifically called for or implied and all work necessary for a satisfactory completion of this work. Stabilized roads and drives shall be finished to match the existing grade. Dirt roads and drives shall have the required depth of backfill material as shown on the Contract Drawings.
- C. The asphaltic concrete repairs shall be in accordance with the Manatee County Public Works Standards, Part I Utilities Standards Manual, Detail UG-12. The asphaltic concrete repairs shall extend the full width and length of the excavation or to the limits of any damaged section. The edge of the pavement to be left in place shall be cut to a true edge with a saw or other approved method so as to provide a clean edge to abut the repair. The line of the repair shall be reasonably uniform with no unnecessary irregularities. The existing asphalt beyond the excavation or damaged section shall be milled 25' back from the saw cut. Final overlay shall match existing with no discernable "bump" at joint.

3.03 MISCELLANEOUS RESTORATION

Sidewalks or driveways cut or damaged by construction shall be restored in full sections or blocks to a minimum thickness of four inches. Concrete curb or curb and gutter shall be restored to the existing height and cross section in full sections or lengths between joints. RCP pipe shall be repaired or installed in accordance with manufacturer's specifications. Grassed yards, shoulders and parkways shall be restored to match the existing sections with grass sod of a type matching the existing grass.

3.04 SPECIAL REQUIREMENTS

The restoration of all surfaces, as described herein, disturbed by the installation of pipelines shall be completed as soon as is reasonable and practical. The complete and final restoration of both paved and shell stabilized roads within a reasonable time frame is of paramount importance. To this end, the Contractor shall, as part of his work schedule, complete the restoration of any area of road within five weeks after removing the original surface. Successful leak testing shall be performed prior to restoring any area of road. All restoration and replacement or repairs are the responsibility of the Contractor.

3.05 CLEANUP

After all repair and restoration or paving has been completed, all excess asphalt, dirt and other debris shall be removed from the roadways. All existing storm sewers and inlets shall be checked and cleaned of any construction debris.

3.06 MAINTENANCE OR REPAIR

All wearing surfaces shall be maintained by the Contractor in good order suitable for traffic prior to completion and acceptance of the work.

END OF SECTION

SECTION 02590 WATER SERVICES ON PRIVATE PROPERTY

PART 1 GENERAL

1.01 SCOPE OF WORK

Furnish all labor, materials, equipment and incidentals necessary for complete installation of potable water services for and on the lots identified on the Drawings when authorized by the County and Property Owner. The Contractor shall construct water service lines on private property from the proposed County meter to a connection point within the customer's water system. In addition, the Contractor shall remove the existing water meter and box assembly and cap and abandon the existing water service at the service line, or as directed by the County. Backflow Preventers and associated Thermal Expansion Tanks and vacuum breakers on all outside hose bibbs shall be installed by the Contractor where cross connection risks are present, as required by the applicable County Ordinances and Plumbing Codes. Installation of Expansion Tanks will often require the Contractor to access inside existing buildings and coordinate work and timing with individual property owners.

1.02 GENERAL

- A. The work shall include furnishing and installing a pipe, fittings, valves, and appurtenances necessary to convey water from the customer's water meter at the property line to the house service connection, including restoration of all lawns, drives, walkways, plants, customer private property, and other activities necessary to restore the site to a condition equal to or better than that which existed prior to construction. The Contractor shall carefully examine the Drawings and shall be responsible for the proper fittings of materials and equipment in each building and on each lot or site. All work shall comply with local code requirements.
- B. Plumbing fixtures, devices and pipe shall be installed in such a manner to prohibit a cross connection or interconnection between a potable water supply and a polluted supply. The plumbing installation shall further prohibit the backflow of sewage, polluted water, or waste into the water supply system. The Contractor shall install vacuum breakers on all outside hose bibbs where backflow preventers are required.
- C. Required materials not covered by the Specifications shall meet the requirements of the local Plumbing Code, other applicable State and Local Ordinances and Codes, the AWWA, NSF, and shall conform to accepted plumbing practice.
- D. The Contractor shall coordinate all work called for in the Contract Documents with the County Meter Superintendent and other involved parties, and shall establish a work plan to install the new water service lines which results in minimal impact to customer private property.
- E. All work on customer service lines conducted on private property shall be performed by a plumber licensed in Manatee County and experienced in furnishing and installing potable water plumbing systems.
- F. Upon completion of water service construction on private property, the Contractor shall obtain a Building Department inspection and approval to place the system into operation.
- G. Pipe openings shall be closed with caps or plugs during installation. Fixtures and

equipment shall be tightly covered and protected against dirt, water and chemical or mechanical injury. Upon completion of all work, the fixtures, materials and equipment shall be thoroughly cleaned, adjusted and operated.

1.03 SUBMITTALS

- A. The Contractor shall submit to the Engineer for review and approval in accordance with the Contract Documents: complete shop drawings, working drawings, and product data for all materials and equipment furnished under this Section. The Contractor shall meet with each property owner to coordinate the routing of the water service line on private property prior to the commencement of any work and shall document the agreed upon route on a sketch signed and dated by all parties and submit them to the Engineer.

1.04 CODES, ORDINANCES AND PERMITS

- A. The Contractor shall comply with all of the laws, ordinances, and codes, rules and regulations of the local and state authorities having jurisdiction over any of the work specified herein. He shall apply and pay for all necessary permits, including Manatee County Building Permits for all lots. Up to 11 permits at \$75 each may be required, with up to 10 adjacent lots on each permit.
- B. If any part of the Plans and Specifications conflict with existing laws and codes, the Contractor shall call it to the Engineer's attention prior to the commencement of work.

1.05 GUARANTEE

- A. The Contractor shall warrant all labor and materials free from defects for a period of one (1) year from the date of acceptance and shall, upon notification during this period, promptly repair or replace any defective items of material or equipment at no additional cost.

1.06 ACCESSIBILITY

- A. The Contractor shall inform himself fully regarding the peculiarities and limitations of the space available for the installation of all material in this Contract.
- B. The Contractor is responsible for obtaining access to the private properties identified on the Drawings. The County will issue notices to the Owners of the Properties requesting their cooperation with the Contractor.

PART 2 PRODUCTS

2.01 MATERIALS

- A. Refer to Manatee County Utility Standards (Manual) for details. All pipe, fittings, materials, and appurtenances shall be furnished and installed to meet the requirements of this project and the requirements of the Florida Building Code - Plumbing, and Residential Chapter 29 (Water Supply & Distribution).
- B. If required by site specific conditions, the Backflow Preventer, Thermal Expansion Tank, and vacuum breakers shall be in accordance with Manatee County Utility Standards, latest edition and are subject to the approval of the Engineer.

- C. Water service pipe shall be per Section 02620 of these Specifications.
- D. A dielectric coupling shall be provided between ferrous and nonferrous materials.
- E. The Contractor shall furnish certified statements from the manufacturer that the material conforms to the requirements specified above.

PART 3 EXECUTION

3.01 PLANNING AND COORDINATION

- A. The Contractor shall coordinate with each water customer, property owner and the County Meter Superintendent to establish a reasonable plan and location for installation of each new customer water service line. The Contractor shall perform exploratory work and have all materials in hand at the commencement of construction to reduce the risk of delays in completion of the work associated with lack of materials.
- B. The Contractor shall schedule the installation of the new water service lines to coordinate with the installation of the new County water line, water services and water meters as a part of this project. The Contractor shall carefully schedule the work of subcontractor licensed plumbers to ensure that customer water service disruption is minimized and is not interrupted for longer than the period specified in the Specifications. The Contractor shall schedule the inspection of the work by Manatee County Building officials as necessary to allow for timely use of the new customer service.
- C. The County will provide new and/or existing water meters to the Contractor to install in proposed meter boxes. The Contractor shall remove existing meters from meter boxes as part of this Contract, return the meters to the County Meter Division, and shall verify with the County Meter Division which meters shall be reinstalled new and which will be reused. Just prior to removing an existing meter from service, the Contractor shall notify the customer, record the existing meter reading, and record the serial number prior to returning meters to the County meter division.

3.02 PRIVATE WATER SERVICE CONSTRUCTION

- A. The Contractor shall install new 1 inch diameter water service lines at a location on the customer's property that is agreed to by the property owner, minimizes impact to existing site features and private property improvements and which most directly connects the new water meter location with the connection point for the customers water service.
- B. The new water service connection on private property shall include new customer service line from the new meter location to the agreed upon point of connection with the customer house water service line; piping, fittings, valves, and appurtenances, excavation and backfill as required; restoration of grass, shrubs, drives, walkways, and other customer property damaged by construction and related work required to result in a new customer service line system that meets code requirements.

3.03 STERILIZATION

The entire potable water collection and distribution system shall be thoroughly sterilized with a

solution of not less than 50 parts per million of available chlorine. The sterilizing solution shall be allowed to remain in the system for a period of three hours after which time all valves and faucets shall be opened and the system shall be flushed with clean water until the residual chlorine content is not greater than 0.92 parts per million, unless otherwise directed.

END OF SECTION

SECTION 02614 STEEL PIPE AND FITTINGS

PART 1 GENERAL

1.01 SCOPE OF WORK

- A. Furnish all labor, materials, equipment, and incidentals required and install, complete, ready for operation and field test all steel pipe as shown on the drawings and specified herein.
- B. Steel pipe shall include black steel, galvanized steel, and stainless steel pipe and fittings.
- C. Provide steel pipe only where specifically called out on the drawings.

1.02 DESCRIPTION OF SYSTEM

- A. All of the equipment specified herein is intended to be standard steel pipe for use in transporting certain chemicals and liquids as shown on the drawings and specified herein.

1.03 QUALIFICATIONS

- A. All steel pipe shall be furnished by a single manufacturer who is fully experienced, reputable and qualified in the manufacture of the steel pipe to be furnished. The equipment shall be designed, constructed, installed in accordance with the best practices and methods and shall comply with all these specifications.
- B. Steel pipe and fittings shall conform to all applicable standards of ASTM, ANSI and AWWA.

1.04 SUBMITTALS

- A. Submit to the County for approval in accordance with the General Conditions and Section 01340, shop drawings to include dimensioning and technical specifications for all pipe to be furnished.

PART 2 MATERIALS

2.01 STEEL PIPE AND FITTINGS FOR PIPING

- A. Black Steel Pipe: All black steel pipe shall be seamless, Grade B and in conformance with ASTM Designation A-53 and ANSI B36.10.
- B. Galvanized Steel Pipe:
 - 1. Galvanized steel pipe for plant and potable water service shall be hot-dipped, zinc coated galvanized, Grade A, electric resistance welded, Schedule 40 conforming to ASTM Designation A120. All joints shall be threaded joints. Threaded joints shall be made up with a stiff mixture of graphite and mineral oil, or an approved, nontoxic, nonhardening, pipe joint compound applied to the male thread only. After having been set up, a joint shall not be backed off unless the joint is completely broken, the threads cleaned and new compound applied. All joints shall be airtight. A sufficient number of unions shall be provided to allow for convenient removal of piping. Fittings for galvanized steel pipe shall be galvanized malleable iron, 150 psi service rating.
 - 2. Where flanged connections are indicated or otherwise required for connection to

flanged valves, fittings, and appurtenances, they shall be made up using companion type flanges. Where flanged fittings are indicated or otherwise required, they shall be made up using thread galvanized steel nipples and steel companion type flanges. Companion flanges shall be steel, 150-psi ANSI Standard flat face flanges of the threaded type. Flanges shall be spot-faced on the back around each bolt hole.

3. All exposed threads, wrench marks, or other damage to the zinc coating, shall be protected by the application of two coats of a heavy consistency, bituminous paint, or with two wraps of an approved vinyl or polyvinyl pressure sensitive tape. Bituminous paint shall be equal to Koppers Bitumastic No. 50, brush applied. Tape shall be equal to 3M Company Scotchrap No. 50, 0.010-inch thick, installed as recommended by 3M Company over a primer.

C. **Stainless Steel Pipe:**

Stainless steel pipe shall be provided as shown on the drawings. Pipe shall be Schedule 40S, Type 316L, annealed, white pickle finish and shall be in accordance with ASTM Specification A312 and ANSI B36.19. Where indicated on the Drawings, holes shall be drilled in the pipe at the factory by the manufacture.

D. **Steel Pipe Sleeves:**

Sleeves for pipe that passes through floors and walls shall be galvanized Schedule 40 steel pipe conforming to ASTM Designation A120. Sleeve dimensions shall conform to the details shown on the drawings. Sleeve ends shall be cut and ground smooth. Sleeves shall be flush with walls and ceilings, but shall extend above the floor as shown on the drawings. Sleeves for use with mechanical type seals shall be sized in conformance with the seal manufacturer's requirements.

2.02 **STEEL PIPE FOUR (4) INCHES AND LARGER**

- A. Except as modified or supplemented herein, all steel pipe, fittings and specials shall conform to the applicable requirements of the following standard specifications latest editions:

AWWA Standards

| | |
|------|--|
| C200 | Steel Water Pipe 6 Inches and Larger |
| C203 | Coal-Tar Protecting Coatings and Linings for Steel Water Pipelines - Enamel and Tape-Hot-Applied. |
| C205 | Cement-Mortar Protective Lining and Coating for Steel Water Pipe - 4 inches and larger - Shop Applied. |
| C206 | Field Welding of Steel Water Pipe |
| C207 | Steel Pipe Flanges for Waterworks Service - Sizes 4 inches through 144 inches, Class D. |
| C208 | Dimensions for Steel Water Pipe Fittings |

- B. All steel pipe shall be manufactured and tested in accordance with the standards set forth in AWWA C200 latest edition for fabricated or mill type water pipe. The pipe shall be made from sheet or plate rolled into sections having longitudinal or spirally formed butt-welded

seams. Girth seams shall be butt welded and shall be at least 8 feet apart except in specials and fittings. The steel shall conform to the standards established in Section 2 and Section 3 AWWA C200.

1. Minimum Physical Properties of Steel Plate or Sheet:

- a. All steel pipe, specials and fittings shall be manufactured from steel plate or sheet having a specified minimum yield of 35,000 psi and specified minimum tensile of 60,000 psi. Test reports verifying the actual physical and chemical properties of the piping must be submitted to the County as soon as possible after manufacturing and fabrication. The test reports shall state the hydrotest pressure applied to all sections of straight pipe and to straight pipe used in fabrication of specials and fittings.
- b. All steel pipe, specials and fittings shall be manufactured or fabricated to the diameter as shown on the drawings. The normal size shall be the outside diameter of 14 inches and larger. For sizes less than 14 inches, the pipe shall be the normal steel pipe dimensions as listed in ASTM A53 specification. All diameters of steel pipe, specials and fittings shall have minimum nominal wall thicknesses as stated herein below:

| <u>Diameter</u> | <u>Minimum Wall Thickness</u> |
|-----------------|-------------------------------|
| 54" | .375 |
| 48" | .375 |
| 42" | .375 |
| 36" | .375 |
| 30" | .375 |
| 24" & smaller | .250 |

C. All fittings and specials shall be provided with ends as required for installation and shall be fabricated to the dimensions as shown on the drawings. All fittings shall be fabricated in accordance with the standards set forth in AWWA C208 latest edition. Fittings and specials shall be fabricated from hydrostatically tested pipe meeting AWWA C200 and will not require any further hydrostatic test in the shop. In reducing sections, the wall thickness will be governed by the largest end. Elimination of joints shown on the drawings must be approved by the County prior to the fabrication process.

D. Flanged and Coupling Standards:

- 1. All flanges, bolts, nuts and gaskets shall meet standards established in AWWA C207. Flanges shall be Class D suitable for pressure up to and including 150 psi with facing and drilling as stated in Section 3 of C207. Procedure for attachment of flanges shall be in accordance with Section 10 of AWWA C207. Blind flanges shall conform in diameter drilling and thickness to the flanges to which they attach and shall produce a watertight joint under the specified test pressure.
- 2. Mechanical couplings shall be Dresser Style 38, Rockwell Style 411 or equal. The middle ring of each coupling shall have a minimum thickness at least equal to that specified for the size of pipe on which the coupling is to be used and shall be 7 inches long for pipe 30 inches and smaller, 10 inches long for pipe 36 inches and larger. The pipe stop shall be omitted from the inner surface of the middle rings and the couplings shall be cleaned and shop

primed with the manufacturer's standard rust inhibitive primer. The filter backwash header and where shown on the drawings shall the mechanically coupled joints be restrained with harness bolts and lugs. Joint harnesses, where applicable, shall conform to the details on the drawings. Lugs shall be attached to the pipe in the shop and coated as specified for the adjacent pipe. The dimensions shall be stated in AWWA M011 19.8.

- E. Pipe supports, anchors, blocking and hangers shall be fabricated in accordance with the details shown on the drawings and shall be installed complete with all accessories required for proper operation of the system. Should it be necessary to modify the details for proper installation, all such modifications shall be subject to approval by the County. Lugs required for anchorage of the piping system shall be attached in the shop and coated as the adjacent pipe.
- F. All steel pipe, fittings, specials and appurtenances shall be prepared, primed, coated and lined as specified herein below:
 - 1. Exterior surfaces of all steel pipe, fittings, specials, flanges, anchors and pipe supports exposed in above ground or interior locations shall be thoroughly cleaned in the shop by blasting with grit, shot or sand to SSPC SP6. One coat of primer shall be applied to the cleaned dry surface in a proper workmanship like manner and as recommended by the primer manufacturer. The primer shall be subject to approval of the County and compatible to the finish coat as specified in the paid section of the specifications. Field painting of the installed system shall be as specified in the painting section.
 - 2. Interior surfaces of all steel pipe, fittings, and specials, which are to be installed exposed aboveground or in interior locations shall be thoroughly cleaned in the shop by blasting with grit, shot or sand to SSPC SP6. Two coats of paint shall be applied to the interior of the pipe at the shop. The paint coats shall be Koppers Bitumastic Super Tank Solution applied at a minimum of 8 mils D.F.T. per coat.
 - 3. Exterior surfaces of all steel pipe, fittings and specials which are to be installed underground and in manholes which will not be encased in concrete shall be coated in the shop with coal tar enamel in accordance with the standards established in AWWA C203-78, except as modified or supplemented herein.
 - 4. The exterior coating system for below ground steel pipe shall consist of coal tar enamel, fibrous glass mat, asbestos pipelines felt wrap and finally wrapped with kraft paper and shall be applied by the procedure described in AWWA C203. The coating shall be held back 12 inches from ends to be mechanically coupled with uncoated areas primed with coal tar primer. The coating system must be done in the shop by an established pipe coating applicator acceptable to the coating materials manufacture and the County. Repairs of the any damage to the coating system incurred during the shipment and the field coating of couplings and ends where coatings have held back for joints shall be done by experienced and qualified personnel approved by the County. Procedure for such field coating shall be as described in AWWA C203.
 - 5. The interior surfaces of all steel pipe, fittings, and specials which are to be installed below ground shall be cleaned and lined with cement mortar conforming to the standards set forth in AWWA C205-80. All work performed in the lining process shall be done in a thorough and workmanship like manner by trained personnel under the supervision of experienced men

skilled in the operations they supervise. The lining thickness shall be as follows:

| Pipe Size (Inches) | Coating Thickness (Inches) | Tolerance (Inches) |
|-----------------------|-------------------------------|-----------------------|
| 4-10 | 1/4 | -1/32 + 1/32 |
| 11-23 | 5/16 | -1/16 + 1/8 |
| 24-36 | 3/8 | -1/16 + 1/8 |
| over 36 | 1/2 | -1/16 + 1/8 |

Handling and transporting of cement mortar lined pipe shall be in accordance with Section 6 of AWWA C205 and Section 2.14 of AWWA C203.

6. The interior surface of all steel air piping shall be coated with a two part epoxy coating system equivalent to 7.0 mils DFT of Mobil Chemical 78-D-7 followed by 7.0 mils DFT of Mobil Chemical 78-W-3 or equal.

2.03 STEEL PIPE AND FITTING AND CHLORINE GAS PIPING

- A. If steel pipes are used for chlorine gas lines, they shall be Schedule 80 seamless steel pipe conforming to ASTM A120. All joints shall be threaded. Threaded joints shall be made up with a cement prepared from litharge and glycerin, or teflon tape. The cement shall be applied to the male thread only. Fitting except unions, shall be carbon steel 2,000 pounds CWP. Unions shall be of the flanged, ammonia type, either two-bolt or four-bolt square.

PART 3 EXECUTION

3.01 INSTALLATION AND TESTING

- A. Steel pipe shall be installed true to alignment and rigidly supported anchors shall be provided where indicated.

After installation, the piping shall be tested by undergoing a four-hour pressure test at 20 percent above the designed operating pressure plant water supply lines. If any joint or pipe proves to be defective, it shall be repaired to the satisfaction of the County.

- B. Screwed joints shall be made up with good quality thread compound and applied to the male thread only. After having been set up, a joint must not be backed off unless the joint is completely broken, the threads cleaned and new compound applied. All joints shall be air tight.
- C. Stainless steel pipe shall have threaded joints or otherwise as required and shall be installed as shown on the Drawings.
- D. Sleeves of the proper size shall be installed for pipes passing through floors and walls as indicated on the drawings. Sleeves shall be given a prime coat of rust inhibitive primer such as Koppers No. 621, or equal.
- E. When cutting of pipe is required, the cutting shall be done by machine in a neat workmanlike manner without damage to the pipe. Cut ends shall be smooth and at right angles to the axis of the pipe.
- F. All field welding shall be in accordance with the American Welding Society Standards. The

strength of the field weld shall develop the strength of the pipe. Welds shall receive a field coating of paint as specified in Section 09900 and as approved by the County.

- G. All galvanized steel pipe thread shall be clean, machine cut, and all pipe shall be reamed before erection. Each length of pipe as erected shall be up-ended and rapped to dislodge dirt and scale.
- H. All galvanized steel piping shall have a sufficient number of unions to allow convenient removal of piping. Unions shall be compatible with pipe.

3.02 PAINTING

- A. Pipe and fittings exposed to view, except stainless steel, shall receive a prime coating of rust inhibitive primer such as Koppers 621 or equal. Prior to prime coating, all surfaces shall be cleaned of all mill scale, rust, dirt, grease and other foreign matter.
- B. All piping and fittings exposed to view except stainless steel pipe shall be painted as specified.

END OF SECTION

SECTION 02615 DUCTILE IRON PIPE AND FITTINGS

PART 1 GENERAL

1.01 SCOPE OF WORK

- A. The Contractor shall furnish all labor, materials, equipment and incidentals required to install ductile iron pipe and restrained joint ductile iron pipe and cast iron or ductile iron restrained joint fittings, complete, as shown on the Drawings and specified in these Standards.
- B. Fittings are noted on the drawings for the Contractor's convenience and do not relieve him from laying and jointing different or additional items where required.
- C. The Contractor shall furnish all labor, materials, equipment and incidentals required to install push-on joint or restrained joint ductile iron pipe, complete as shown on the Drawings and Specifications.
- D. Newly installed pipe shall be kept clean and free of all foreign matter. All DI pipe installed underground shall be poly wrapped unless noted otherwise on the plans.

1.02 SUBMITTALS

- A. The Contractor shall submit to the County, within ten days after receipt of Notice to Proceed, a list of materials to be furnished, the names of the suppliers and the appropriate shop drawings for all ductile iron pipe and fittings.
- B. The Contractor shall submit the pipe manufacturer's certification of compliance with the applicable sections of the Specifications.

PART 2 PRODUCTS

2.01 MATERIALS

- A. Ductile iron pipe shall conform to AWWA C150 and AWWA C151. Pipe shall be Pressure Class 350. All ductile iron pipe used in above ground applications shall be Special Thickness Class 53. All pipe materials used in potable water systems shall comply with NSF Standard 61.
- B. Unrestrained joint pipe shall be supplied in lengths not to exceed 21 ft. and shall be either the rubber-ring compression-type push-on joint or standard mechanical joint pipe as manufactured by the American Cast Iron Pipe Company, U.S. Pipe and Foundry Company, or an approved equal.
- C. All mechanical joint fittings shall be pressure rated for 350 psi for sizes 4-24 inches and 250 psi for sizes 30 inches and larger. All flanged fittings shall be pressure rated for 250 psi for all sizes. All fittings shall meet the requirements of AWWA C110 or AWWA C153.
- D. Rubber gaskets shall conform to AWWA C111 for mechanical and push-on type joints and shall be Ethylene Propylene Diene Monomer (EPDM) rubber for potable water and reclaimed water pipelines. Standard gaskets shall be such as Fastite as manufactured by American Cast Iron Pipe Company, or an approved equal. Acrylonitrile butadiene (NBR) gaskets shall be used for potable water mains that are located in soil that is contaminated with low molecular-weight petroleum products or non-chlorinated organic solvents or non-

aromatic organic solvents. Fluorocarbon (FKM) gaskets shall be used for potable water mains that are located in soil that is contaminated with aromatic hydrocarbons or chlorinated hydrocarbons. Fluorocarbon (FKM) gaskets shall be used where both classes of contaminants are found.

- E. Water Main and Reclaimed Water Main Coatings: All ductile iron pipe used in water and reclaimed water systems shall have a standard thickness cement lining on the inside in accordance with AWWA C104 and a standard 1-mil asphaltic exterior coating per AWWA C151. All ductile iron or gray iron fittings used in water and reclaimed water systems shall have standard thickness cement linings on the inside per AWWA C104 and an asphaltic exterior coating or they shall have factory-applied fusion bonded epoxy coatings both inside and outside in accordance with AWWA C550.
- F. Wastewater Main Coatings: All ductile iron pipe and fittings used in wastewater sewer systems shall have a factory applied dry film thickness 40-mil Protecto 401 or 40-mil Novocoat SP2000W amine cured novalac ceramic epoxy lining on the inside. The interior lining application is to be based on the manufacturer's recommendation for long-term exposure to raw sewage. To ensure a holiday-free lining, documentation must be provided, prior to shipment, showing each section of lined pipe has passed holiday testing at the time of production per ASTM G62. The lining shall have a minimum one year warranty covering failure of the lining and bond failure between liner and pipe.

Exterior coatings for ductile iron pipe and fittings used in wastewater systems shall be either an asphaltic coating per AWWA C151 or a factory-applied epoxy coating per AWWA C550.

- G. Thrust restraint devices shall be provided at all horizontal and vertical bends and fittings, in casings under roads and railroads and at other locations specifically indicated on the construction drawings. Thrust restraint devices shall be either concrete thrust blocks or restraining glands as manufactured by Star Pipe Products, Stargrip 3000 and 3100, Allgrip 3600, or as manufactured by EBAA Iron Sales, Megaflange, 2000 PV, or other approved equal restraining gland products. Restrained joints, where used, shall be installed at bend and fitting locations and at pipe joint locations both upstream and downstream from the bends or fittings at distances as required by these Standards. Restrained joint pipe fittings shall be designed and rated for the following pressures:

- 350 psi for pipe sizes up to and including 24" diameter
- 250 psi for pipe sizes 30" diameter and above

2.02 DETECTION

- A. Pipe shall have a 3-inch wide warning tape of the proper color placed directly above the pipe 12 inches below finished grade or a 6-inch warning tape between 12 inches and 24 inches below finished grade.
- B. Pipe shall have a solid, 10 gauge, high strength, copper clad steel wire with a polyethylene jacket of appropriate color installed along the pipe alignment as detailed in these standards. Tracer wire shall be manufactured by Copperhead Industries or Manatee County approved equal.

2.03 IDENTIFICATION

- A. Each length of pipe and each fitting shall be marked with the name of the manufacturer, size and class, lining type, and shall be clearly identified as ductile iron pipe. All gaskets shall be marked with the name of the manufacturer, size and proper insertion direction.
- B. All ductile iron pipe 12 inches and smaller shall be entirely polyethylene-wrapped blue for water mains, purple (Pantone 522 C) for reclaimed water mains and green for sewer mains, per AWWA C105.
- C. All ductile iron pipe greater than 12 inches shall be spiral wrapped with color coded polyethylene at a six-inch minimum spacing, If soil testing, in accordance with AWWA C105, indicates that the soil at the site is corrosive, the ductile iron pipe shall be entirely polyethylene-wrapped with color coded polyethylene.
- D. Poly-wrap shall be by V-Bio™ Enhanced Polyethylene Encasement (or equivalent).
- E. All above ground potable water mains and appurtenances shall be painted safety blue.

END OF SECTION

SECTION 02616 DISINFECTING POTABLE WATER PIPE LINES

PART 1 GENERAL

1.01 SCOPE OF WORK

The Contractor shall furnish all labor, materials, equipment and incidentals required to clean and disinfect potable water pipe lines. This work is required to place all types of pipe into service as potable water lines.

1.02 CLEANING WATER MAINS

At the conclusion of the work, the Contractor shall thoroughly clean all of the new pipes to remove all dirt, stones, pieces of wood or other material which may have entered during the construction period per Section 02618.

1.03 DISINFECTING & BACTERIOLOGICAL TESTING OF POTABLE WATER PIPE LINES

- A. All record drawing requirements must be submitted to the County prior to starting the bacteriological testing of the water lines.
- B. After the new potable water pipelines have been hydrostatically tested, or after existing potable water pipelines have been modified or repaired, they shall be cleaned, disinfected and sampled and tested for the presence of coliform organisms in accordance with AWWA C651.
- C. The County Inspector shall have been notified and shall be present at the time of the introduction of the chlorine disinfectant and water from the supply system into the main.
- D. At the end of the chlorine contact period, the chlorine residual shall be determined by sampling and testing, and the results shall be reported to the regulatory agencies with the County and State. The pipelines shall then be flushed thoroughly with clean potable water until chlorine measurements show that the concentration is no higher than the chlorine concentration that is acceptable for domestic use.
- E. Discharge flows from cleaning or flushing operations, and heavily chlorinated water from disinfecting operations, shall be disposed of in a manner consistent with US EPA, FDEP and SWFWMD regulations. Chapter 62-302 F.A.C. water quality standard for residual chlorine in Class III waters is <0.01 mg/L (ppm).
- F. After final flushing and before the new main is connected to the distribution system, sampling and analysis of the replacement water shall be performed by an approved laboratory or by the Department of Health. Sampling locations shall be as required by AWWA C651 or as determined by the FDEP representative. Pipelines that are tested and return an unsatisfactory test result shall be reflushed and resampled, or re-disinfected, or otherwise reconditioned, until a satisfactory result is attained.
- G. No potable water main shall be placed into service until the results of the bacteriological tests are satisfactory and the FDEP has provided the County with a written letter of acceptance. Potable water services, fire service, and fire hydrant leads that are exempt from a permit from the FDEP but still require bacteriological sampling in accordance with Chapter 62-555, Florida Administrative Code, shall not be placed into service until the results of the

bacteriological tests are satisfactory and the Manatee County Public Works Engineering Department has provided written acceptance.

- H. Special disinfecting procedures when approved by the County, may be used where the method outlined above is not practical.

END OF SECTION

SECTION 02617 INSTALLATION AND TESTING OF PRESSURE PIPE

PART 1 GENERAL

Reference Section 1.9, Installation of Pipelines in the Manatee County Public Works Utility Standards Part 1-Utility Standards Manual.

1.01 GENERAL

- A. Furnish and install pipe, fittings, valves, fire hydrants, services, and all other appurtenances and incidentals complete and in-place as required by the construction drawings.
- B. Where potable or reclaimed water mains are to be installed under pavement, in parking lots, etc., the main shall be DI or protected by a steel casing pipe.
- C. All pipe crossing state or federal roads or local arterials & thoroughfares shall be installed in a casing pipe.
- D. Services under any kind of pavement shall be Type "L" copper or Schedule 40 stainless steel.
- E. Water mains 16-inches and larger shall be ductile iron. High density polyethylene or PVC (for 16" only). The use of HDPE pipe must be authorized by the County prior to ordering and installation.
- F. Soil testing in accordance with AWWA C105 shall be performed during the design phase to determine if the soil is corrosive to ductile iron pipe. One (1) soil test shall be performed for pipe lengths under 500 lineal feet, with an additional soil test every 500 of additional ductile iron pipe to be installed. The soil testing shall be performed by a Florida licensed geotechnical engineering and signed and sealed report shall be supplied to the County for review prior to installation of the ductile iron pipe for evaluation. The soil testing results shall be used to determine if additional requirements for the installation of ductile iron pipe and/or the restrained joints is warranted.
- G. Ductile iron pipe, with gasket materials as required in these Standards, shall be used in soil that is contaminated with low molecular-weight petroleum products, aromatic hydrocarbons, chlorinated hydrocarbons or organic solvents.
- H. Trees shall not be planted or located within 10 feet of any potable water main, reclaimed water main, sanitary force main or gravity sanitary sewer main that is owned and maintained by County. With prior approval, an approved root barrier may be used with 5 feet of clearance.
- I. All distribution waterlines that enter private property become private lines and shall have a back-flow preventer installed at the right-of-way. BFP can be part of a meter assembly or a BFP / detector check assembly.

1.02 HANDLING AND STORAGE

- A. Prior to installation, all pipe and fittings shall be inspected. Cracked, broken, or otherwise defective materials not in compliance with these standards shall not be used and shall be removed from the project site.

- B. The pipeline installer shall take care in the handling, storage and installation of the pipe and fittings to prevent injury to the materials or coatings. Use proper implements, tools and facilities for the safe and proper protection of the work. Lower the pipe and fittings from the truck to the ground and from the ground into the trench in a manner to avoid any physical damages. Under no circumstances shall the pipe or fittings be dropped onto the ground or into the trenches.
- C. The pipeline installer shall not distribute material on the job site faster than it can be used to good advantage. Unless otherwise approved by the County, installer shall not distribute more than one week's supply of material in advance of laying. Any materials not to be installed within two weeks of delivery shall be protected from the sunlight, atmosphere and weather by suitable enclosures or protective wrapping until ready for installation. Stored PVC pipe shall be placed on suitable racks with bottom tiers raised above the ground to avoid damage. Storage of pipe on the job site shall be done in accordance with the pipe manufacturer's written instructions.

1.03 SURVEY MARKINGS

- A. As a marker for the Surveyor, a PVC pipe marker or 2" x 4" marker shall be inserted by the Contractor on the top of pipe for potable water mains, reclaimed water mains and sanitary force mains at intervals no greater than 200 feet apart and at locations where there is a substantial grade change. The pipe markers shall indicate the pipe diameter and shall be labeled PWM in "safety" blue, RWM in purple, and FM in green, for potable water mains, reclaimed water mains and sanitary force mains, respectively. The Contractor is responsible for making the aforementioned markers available to the Surveyor. The Contractor shall field locate the mains and fittings when markers are not made available to the Surveyor.
- B. As a marker for the Surveyor, a PVC pipe marker or 2" x 4" marker shall be inserted by the Contractor on the top of all pipe fittings (other than sanitary sewer service wyes, potable water saddles and reclaimed water saddles). The markers for fittings shall indicate the type of fitting and shall be labeled PWF in "safety" blue, RWF in purple, and FMF in green, for potable water fittings, reclaimed water fittings, and sanitary force main fittings, respectively. The Contractor is responsible for making the aforementioned markers available to the Surveyor. The Contractor shall field locate the mains and fittings when markers are not made available to the Surveyor.
- C. A PVC pipe marker or 2" x 4" marker shall be inserted by the Contractor at the beginning and end of each horizontal directional drill (HDD). The HDD Contractor shall provide a certified report and bore log indicating the horizontal and vertical location every 25 linear feet or less along the pipe.
- D. A 2" PVC pipe marker with a painted end cap shall be inserted by the Contractor at the ROW line indicating each individual new service location or stub out. The marker shall be a 6 foot length of PVC pipe inserted 2 feet into the ground and shall be painted "safety" blue for potable water, purple for reclaimed water, and green for sewer.

1.04 PROCEDURE FOR TESTING WATER LINES, FORCE MAINS AND RECLAIMED WATER LINES

- A. A 48-hour notice is needed prior to testing. A letter stating the reasons testing should be scheduled ahead of other jobs must accompany all emergency testing requests.

- B. County and Contractor must be present for all testing, except for testing tapping valves and sleeves.
- C. HYDROSTATIC TESTING
 1. Refer to Manatee County Public Works Utility Standards Part 1-Utility Standards Manual Section 1.8.7.

1.05 INSPECTION/TESTING PROCEDURE COVERING BORED PIPE LINES OR CASING AND CONDUITS INSTALLED ACROSS PREVIOUSLY TESTED AND/OR COUNTY ACCEPTED WATER AND SEWER PIPE WITHIN DEVELOPMENT PROJECTS UNDER ACTIVE CONSTRUCTION

- A. Prior to testing water and sewer lines, every effort will be made to install sleeves for underground utilities that will cross these water and sewer lines or services.
- B. Where it has not been possible to pre-install sleeves prior to testing and bores or conduits are required, it is the responsibility of the utility company and/or their Contractor performing the work to provide Manatee County Utility Operations Department or the Engineer of Record with accurate horizontal and vertical as-built information of the sleeves, bores and conduits installed by said utility company. This applies to all bores and conduits crossing water and sewer lines.
- C. Procedures to be followed for installation of conduits, pipe lines and bores that will cross, or be closer than 5'-0" horizontally and 18 inches vertically to, previously tested water and sewer lines that are still under the ownership of the developer/contractor.
 1. Notify the County and obtain the best as-built information available. Allow sufficient time for the County to field locate the existing pipe lines.
 2. Submit drawings of proposed location to the County and Manatee County Utility Operations Dept. Utility Locations Section for review.
 3. Obtain a County Right-of-Way Use Permit if the work area is within a dedicated area of right-of-way.
 4. Perform installation in the presence of a County representative. Call (941) 792-8811, ext. 5061 or ext. 5069 with at least two (2) working days notice.
 5. Submit two (2) copies of as-built information to the County to incorporate into the record drawings to be submitted to the County.
 6. Failure to follow steps 2) thru 5) will result in additional charges for retesting the previously tested water and sewer lines.
- D. Procedures to be followed for installation of conduits, pipe lines and bores crossing or closer than 5'-0" horizontally and 18 inches vertically to previously tested water and sewer lines that have been previously accepted by Manatee County:
 1. Obtain record drawing information from the County.
 2. If roadway has been dedicated to Manatee County, obtain Right-of-Way Use Permit and copy the Project Management Department Locations Section with proposed location drawing.
 3. Follow procedures in "Sunshine State One-Call", paying special attention to the requirements of Section VII.
- E. Should water or sewer lines be damaged during the bore pipe line or casing installation, the cost of any repairs and retesting will be paid for by the utility company that installed the bore. The actual clearance between a bored casing crossing a water or sewer pipe should not be

less than 18 inches.

1.06 DETECTION

- A. Direct buried pipe shall have 3" detectable metallic tape of the proper color placed directly above the pipe and 12" below finished grade or 6" detectable tape between 12" and 24" below finished grade.
- B. Direct buried or horizontal directional drilled non-metallic pipe shall also have tracer wire installed along the pipe alignment. The tracer wire to be used shall be a solid, 10 gauge, high strength, copper clad steel wire with a polyethylene jacket of appropriate color manufactured by Copperhead Industries or Manatee County approved equal.

END OF SECTION

SECTION 02618 PIPELINE CLEANING

PART 1 GENERAL

1.01 SCOPE OF WORK

- A. The Contractor shall furnish all labor, materials, equipment and incidentals required to clean all new lines 4" and larger, and existing pipelines as specified in this specification and as indicated on the Drawings.
- B. This work shall include the furnishing and installation of all pig launching and retrieval devices and the appropriate pigs for the cleaning procedure, and all necessary excavations, shutdowns, fittings and valves required.

1.02 RELATED WORK

- A. The contractor is responsible for all necessary supply water.
- B. The contractor is responsible for all necessary bypass pumping.
- C. The contractor is responsible for the proper disposal of any materials removed from the pipe lines as a result of the cleaning procedure.

1.03 SUBMITTALS

- B. The Contractor shall submit prior to construction, a cleaning plan, Shop Drawings, and layout diagram for approval to the County.
- B. The Contractor shall submit to the County a list of materials to be furnished, and the names of suppliers.

1.04 QUALIFICATIONS

- A. The Contractor performing this work shall be fully qualified, experienced and equipped to complete this work expeditiously and in a satisfactory manner.
- B. The Contractor shall also be capable of providing crews as needed to complete this work without undue delay.
- C. The County reserves the right to approve or disapprove the Contractor, based on the submitted qualifications.

PART 2 PRODUCTS

2.01 GENERAL

- A. The contractor shall be responsible for furnishing pigs in sufficient numbers and sizes, of appropriate densities, coatings and configurations to properly clean the piping systems.
- B. All pigs used for the cleaning of sewer or reclaimed water lines shall not be used in the cleaning of potable water lines.

2.02 MATERIALS

- A. The pig launching and retrieval equipment shall be of the latest design and construction and shall include the means to maintain constant monitoring of the in-line flows and pressures of the system being cleaned and the constant location of the cleaning pigs in the system. Launching and retrieval systems shall be fabricated, designed and manufactured according to ANSI standards and capable of withstanding working pressures of 150 psi. Launching and receiving devices shall be sized one diameter larger than the system to which it will be attached with a minimum length of 2.5 times the diameter.
- B. The contractor shall have available for immediate use an electronic pig detector for use in the system being cleaned to provide a means of tracking the passage of the pig in the system to locate areas of potential or suspected blockage and other disparities in the system.
- C. The pig shall be constructed of elastomer polyurethane with an open cell construction and a density equal to or suitable for use in the piping system being cleaned. Pig configuration shall consist of a parabolic nose with a concave base and coated with a resilient surface material that will maintain a peripheral seal and will effectively clean the piping system without over abrading the interior pipe wall. Pig characteristics shall include the ability to navigate through 90 degree bends, 180 degree turns, bi-directional fittings, full port valves, reduce its cross sectional area and return to its original design configuration and be propelled by hydraulic pressure.

PART 3 EXECUTION

3.01 PIPELINE CLEANING

- A. The cleaning of the pipe line shall be done by the controlled and pressurized passage of a polyurethane pig of varying dimensions, coatings and densities as determined by the County through the piping system.
- B. A series of pigs shall be entered into the system at a point as near to the beginning as is logistically and mechanically feasible.
- C. A launching assembly shall be used as the entrance point for the pig. This assembly shall allow for the following:
 - 1. The entering of pigs into the system by providing the means to induce flow from an external source, independent of the flows and pressures immediately available from the system, on the back of the pig to develop sufficient pressure to force the pig through the system.
 - 2. A means to control and regulate the flow.
 - 3. A means to monitor the flows and pressures.
 - 4. A means to connect and disconnect from the system without any disruption to the operation of the system.
- D. The pig shall be removed or discharged from the system at a point as near to the end as is logistically and mechanically feasible.
- E. The contractor shall be responsible for the retrieval of the pig at the discharge point. This may include setting a trap that will not disrupt normal flow and operations but will capture the pig and any debris. A retrieval assembly may also be used but said assembly shall be able to connect and disconnect from the system without any disruption to the operation of

the system.

- F. Alternative launching and retrieval methods shall be done with the prior approval of the County.
- G. Any pig that cannot progress through the piping system shall be located by the contractor and removed by excavation of the pipe in order to remove the blockage. All pipe repairs shall be the responsibility of the contractor and shall be performed with as little disruption to the system as possible.
- H. Any increase in pressure that cannot be accounted for, i.e. fittings or valves or additional cleaning runs, shall be investigated, per the Engineers' approval, by locating the pig at the beginning of the increased pressure and excavating to determine the cause of the pressure increase. All pipe repairs shall be the responsibility of the contractor and shall be performed with as little disruption to the system as possible.
- I. Final flushing of the cleansed lines shall be performed after the last successful run of the pig as determined by the County. The contractor shall be responsible for all applicable flushing and disinfection requirements for potable water lines.

3.02 ACCEPTANCE

- A. The contractor shall maintain and provide a report at the end of the cleaning procedure containing the following:
 - 1. The pressures in the pipe during the pigging procedure.
 - 2. Any inline problems encountered during the procedure including all excavations with detailed locations, reason for the excavation and any corrective measures taken to the pipeline.
 - 3. A record of the pigs used, their sizes, styles and other pertinent information regarding what materials were used during the cleaning.
 - 4. An analysis of the condition of the pipeline before and after the cleaning procedure.

END OF SECTION

SECTION 02619 HORIZONTAL DIRECTIONAL DRILLING

PART 1 GENERAL

1.01 SCOPE

The Contractor shall furnish all labor, materials, equipment and incidentals required to install all pipe, fittings and appurtenances as shown on the Drawings and specified in the Contract Documents by Horizontal Directional Drilling (HDD).

1.02 GENERAL

- A. All existing structures, water and sewer lines, storm drains, utilities, driveways, sidewalks, signs, mail boxes, fences, trees, landscaping, and any other improvement or facility in the construction area that the Contractor disturbs for his own construction purposes shall be replaced to original condition at no additional cost to the County.
- B. For "Navigable Waters of the U.S." reference 33 of the Code of Federal Regulations, Part 329.
- C. For "Waters of the U.S." reference 33 of the Code of Federal Regulations, Part 323.
- D. For "Waters of the State" reference Section 62-301 of the Florida Administrative Code.

1.03 TESTING

- A. In place soil compaction tests shall be performed by a qualified testing laboratory.
- B. Compaction tests shall be taken at every excavation, except in the road crossings or road shoulders; tests are to be taken according to current FDOT Standards.
- C. All pipe shall be tested in accordance with the appropriate material specifications.
- D. Reference Standards: American Society for Testing and Materials (ASTM), D1557, Moisture-Density Relations of Soils Using 10-lb. Rammer and 18-in. Drop.
- E. The density of soil in place shall be a minimum of 95 percent in accordance with ASTM test 1557-70T, Method A or C.

1.04 QUALIFICATIONS

- A. Pipe Manufacture: All pipe and fittings shall be furnished by a single manufacturer who is fully experienced, reputable and qualified in the manufacture of the items to be furnished.
- B. Drilling Supervisor: The Contractor shall provide a competent boring specialist who shall remain on the project site during the entirety of the directional boring operation. This includes, but is not limited to, drilling fluid preparation, seaming, boring and pulling. The boring specialist shall have a minimum of five years of experience in supervising directional bores of similar nature, diameter, materials and lengths.
- C. Pipe Fusion: All boring and fusing equipment shall be certified for operation. The Contractor responsible for thermal butt fusing pipe and fittings shall have manufacturer certification for performing such work or a minimum of five years of experience performing this type of work.

If no certification is available, written documentation of the required work experience shall be submitted for approval.

- D. Drilling Fluid Specialist: The personnel responsible for supervising the supply, mixing, monitoring fluid quality, pumping and re-circulation system proposed for the drilling fluid shall have a written certification issued by the Drilling Fluid manufacturer for performing such work or a minimum of five years of experience performing this type of work. If no certification is available, written documentation of the required work experience for the proposed personnel shall be submitted for review and approval.

1.05 SUBMITTALS

- A. Detailed description including specifications and catalog cuts for:
1. Shop drawings and catalog data for all HDD equipment.
 2. The pipe manufacturer's maximum degree of radial bending allowed for the pipe when full and when empty and pullback force recommended setting.
 3. Steering and tracking devices including specific tracer wire.
 4. Drilling fluids; the drilling fluid submittal shall include the ratio of mixture to water, including any additives, based on the Contractor's field observations prior to construction, knowledge and experience with drilling in similar conditions, and any soil data provided in the Contract Documents, which shall be verified by the fluid specialist.
 5. Shop drawings for the breakaway swivel, including the method of setting the swivels' break point and set point to be used.
 6. Shop drawings for sizing of the mandrel for pull through testing
 7. Pipe assembly procedure, details of support devices, and staging area layout including methods to avoid interference with local streets, driveways, and sidewalks.
 8. Details of pipe fusion procedures and copies of the fusion technician qualification certification or documentation.
 9. Drilling fluid technician qualification certification or documentation
- B. If the Contractor proposes any changes to the pull-back distance or profile shown on the drawings, he may be required to submit a complete design for the proposed pipe including an analysis for pull-back forces, external loads including full hydrostatic pressure if empty, external forces due to borehole collapse, ovalization during pull-back, thermal stress while exposed to Sun-light, shortening after release of pull-back force, and tensile stress during pull-back.
- C. Bore Plan: For all contiguous piping installations over 300 feet in length or any installations for piping larger than 4" in diameter, the Contractor shall submit a Bore Plan that includes the following:
1. Contact information and experience for the drilling fluid specialist.
 2. The number of passes the bore will include to get the product pipe installed.
 3. The pilot bore and all reaming bore sizes including the final pullback with the product pipe.
 4. Drilling rod length in feet.
 5. The pilot bore, pre-ream bores (if any) and pullback production rate in minutes per (drilling) rod to maintain adequate mud flow.
 6. Details of the entry and exit pit locations along with entry and exit angles for the bore, drawn to scale, depicting the position of all required equipment, access points, existing facilities to remain in place, existing traffic lanes to be maintained in

- operation, office trailers and storage sites.
7. The method of fusing or joining pipe of adjacent bores to ensure that the joint is on grade with the installed pipe.
- D. Furnish a Bore Path Report to the County within seven days of the completion of each bore path. Data collected by the County Representative does not relieve the Contractor from the responsibility of recording his own data. Include the following in the report:
1. Location of project, project name and number
 2. Name of person collecting data, including title, position and company name
 3. Investigation site location (Contract plans station number or reference to a permanent structure within the project right-of-way)
 4. Driller's Log & identification of the detection method used
 5. Elevations and offset dimensions of installed pipe as referenced to the drawings
 6. Data log of pullback force during product pipe installation
 7. All failed bores. Include length of pipe left in place and explanation of failed installation.

PART 2 PRODUCTS

2.01 MATERIALS

- A. Incidental materials that may or may not be used to install the product depending on field requirements are not paid for separately and will be included in the cost of the installed product.
- B. Drilling Fluids shall use a mixture of bentonite clay or other approved stabilizing agent mixed with potable water with a pH of 8.5 to 10.0 to create the drilling fluid for lubrication and soil stabilization. Vary the fluid viscosity to best fit the soil conditions encountered. Contractor shall have appropriate additives for drilling fluid available for different soil conditions that may be encountered. Do not use any other chemicals or polymer surfactants in the drilling fluid without written consent from the County. Certify to the County in writing that any chemicals to be added are environmentally safe and not harmful or corrosive to the product pipe.
- C. For drilling operations that will be below waters of the State of Florida, only bentonite free drilling fluids shall be used. Acceptable products are BioMax, manufactured by M-I Swaco, Inc., P.O. Box 2216, Laurel, Mississippi 39440, Phone: (800) 731-7331 or Bio-Bore, manufactured by Baroid Drilling Fluids, Inc., P.O. Box 1675, Houston, Texas 77251, Phone: (731) 987-5900 or approved equal.
- D. Identify the source of water for mixing the drilling fluid. Approvals and permits are required for obtaining water from such sources as streams, rivers, ponds or fire hydrants. Any water source used other than potable water may require a pH test.
- E. The tracer wire to be used for all directional drills shall be a solid, 10 gauge, high strength, copper clad steel wire with a polyethylene jacket of appropriate color manufactured by Copperhead Industries or Manatee County approved equal.
- F. Breakaway connectors shall be supplied by DCD Design & Manufacturing, Condux International, Inc. or approved equal.

PART 3 EXECUTION

3.01 SITE CONDITIONS

- A. Carry out excavation for entry, exit, recovery pits, slurry sump pits, or any other excavation as specified in the Contract documents. Sump pits are required to contain drilling fluids if vacuum devices are not operated throughout the drilling operation, unless approved by the County.
- B. Within 48 hours of completing installation of the boring product, clean the work site of all excess slurry or spoils. Take responsibility for the removal and final disposition of excess slurry or spoils. Ensure that the work site is restored to pre-construction conditions or as identified on the plans.
- C. Exposure of product pipe to sunlight shall be limited to 14 consecutive days unless approved by the County.
- D. The pipe shall be supported at intervals along its length with rollers or Teflon pads to minimize frictional forces when being pulled, and to hold the pipe above the ground. Surface cuts or scratches greater than or equal to the maximum defect depth in 3.08 E are not acceptable.

3.02 DAMAGE RESTORATION & REMEDIATION

- A. The Contractor shall take responsibility for restoration for any damage caused by heaving, settlement, separation of pavement, escaping drilling fluid (frac-out), or the directional drilling operation, at no cost to the County.
- B. When required by the County, provide detailed plans which show how damage to any roadway facility will be remedied. These details will become part of the Record Drawings Package. Remediation Plans must follow the same guidelines for development and presentation of the Record Drawings. When remediation plans are required, they must be approved by the County before any work proceeds.
- C. For HDD operations that will be below waters of the State of Florida, the contractor shall be responsible for any damage caused by the drilling operation, including, but not limited to, fracturing of the channel bottom. Any State or Federal required environmental cleanup due to the release of drilling fluids into State waters shall be at the Contractor's expense. The Contractor may at his own expense increase the depth of his drilling operations upon the approval from the County.

3.03 QUALIFICATIONS FOR REJECTION OF DIRECTIONAL BORE

- A. The County may reject any portion of the work that is deemed to be non-responsive to the Contract requirements or not in conformance with approved plans and submittals, and for other factors including the following:
 - 1. Failed Bore: When there is any indication that the installed product has sustained damage, stop all work, notify the County and investigate damage. The County may require a pressure and / or mandrel test at no additional cost to the County and shall have a County representative present during the test. Perform all testing within 24 hours unless otherwise approved by the County. Furnish a copy of the test results and all bore logs to the County for review and approval. The County is allowed up to

5 working days to approve or determine if the product installation is not in compliance with the specifications.

2. Obstructions: If an obstruction is encountered during boring which prevents completion of the installation in accordance with the design location and specification, the pipe may be taken out of service and left in place at the discretion of the County.
3. Pull-back Failure: If the installed breakaway device should fail during pull back.
4. Loss of Drilling Fluids: If the drilling fluid is "lost" during the pull back of the product and cannot be regained within the required timeframe of the manufacturer or if more than a reasonable amount of fluid is used to fill an unknown void and flow cannot be regained. No pipe shall be pulled without visible flow of drilling fluid.
5. Test Failure: If the pipe shall fail a hydraulic pressure test or mandrel test as specified by the County.
6. Damaged Pipe: If at any time when the product is pulled back and any exposed areas have a greater than allowable "gouging" or visible marring of the pipe per the table in 3.08 E.
7. Alignment Tolerance Exceeded: If the vertical and horizontal limits are not within tolerances.
8. Defective Material: Any other defect in material or workmanship which would affect the quality, performance, or installation life of the installed pipeline.

- B. Remediation: All rejected bores shall be at the Contractors expense to correct and provide a satisfactory installed product. The Contractor shall submit to the County a revised installation plan and procedure for approval before resuming work. The County may require non-compliant installations to be filled with excavatable flowable fill or to be completely removed at no additional cost to the County.

3.04 PRODUCT LOCATING AND TRACKING

- A. The County recognizes walkover, wire line, and wire line with surface grid verification, or any other system as approved by the County, as the accepted methods of tracking directional bores. Use a locating and tracking system capable of ensuring that the proposed installation is installed as intended. The locating and tracking system must provide information on:
1. Clock and pitch information
 2. Depth
 3. Transmitter temperature
 4. Battery status
 5. Position (x,y)
 6. Azimuth, where direct overhead readings (walkover) are not possible (i.e. sub aqueous)
- B. Ensure proper calibration of all equipment before commencing directional drilling operation.
- C. Prepare the Driller's Log. Take and record alignment readings or plot points such that elevations on top of and offset dimensions from the center of the product to a permanent fixed feature are provided. Such permanent fixed feature must have prior approval of the County. Provide elevations and dimensions at all bore alignment corrections (vertical and horizontal) with a minimum distance between points of 10 feet. Provide a sufficient number of elevations and offset distances to accurately plot the vertical and horizontal alignment of the installed product.

- D. Installation Location Tolerances:
- a. It shall be the Contractors responsibility to notify the County when the pilot bore activities are taking place. The Contractor shall provide the County a printout of the completed pilot bore path for review prior to pull back of the product.
 - b. The location of the initial bored hole shall be deemed acceptable by the County if the deviations of the bore from the design alignment or approved adjustments do not exceed the following tolerances:
 1. Profile (vertical):
 - a. max. slope does not exceed 2% (2.0 feet within a length of 100 feet).
 - b. No reverse curvature within 200 feet
 - c. No vertical deviations greater than ten (10) percent of depth of cover over the length of the bore.
 2. Alignment (horizontal):
 - a. 3.0 feet within a length of 200 feet
 - b. No reverse curvature
 - c. Total deviation not to exceed 2.0 feet
 - c. If the pilot bore does deviate from the above criteria, the Contractor shall notify the County prior to pull back. The County, at its discretion, may require the Contractor to pull back and re-drill the pilot bore to correct any deviations.

3.05 PRODUCT BORE HOLE DIAMETER

Minimize potential damage from soil displacement/settlement by limiting the ratio of the bore hole to the product size. The size of the back reamer bit or pilot bit, if no back reaming is required, will be limited relative to the product diameter to be installed as follows:

Table 2-1. Recommended Relationship between Product Diameter and Reamed Diameter

| Product Diameter | Reamed Diameter |
|---|---------------------------|
| < 8" | Diameter of product + 4" |
| 8" - 24" | Diameter of product x 1.5 |
| > 24" | Diameter of product + 12" |
| *Horizontal Directional Drilling Good Practices Guidelines - HDD Consortium | |

3.06 EQUIPMENT REQUIREMENTS

- A. The HDD equipment selected by the Contractor shall be capable of drilling, steering, tracking, reaming and installing the pipeline through all the subsurface conditions that may be present at the site.
- B. Match equipment to the size of pipe being installed. Obtain the County's approval for installations differing from the above chart. Ensure that the drill rod can meet the bend radius required for the proposed installation.
- C. All HDD equipment shall have an electronic data logger to record pull back force during all pipe installations.
- D. All HDD equipment that has the capability to exceed the maximum recommended pulling

force shall have a breakaway swivel properly attached to the product pipe that will release if the pullback force exceeds the pipe manufacturers recommended pulling force.

3.07 THRUST / PULLBACK REQUIREMENTS

The Contractor shall provide as part of the required working drawings submittal complete data regarding the operational and maximum thrust or pulling forces to be used for the initial drill head and back-reamer installations, and the final pull-back of the pipe. Gages or other measurement tools shall be used to monitor the forces being used.

3.08 INSTALLATION PROCESS

- A. Ensure adequate removal of soil cuttings and stability of the bore hole by monitoring the drilling fluids such as the pumping rate, pressures, viscosity and density during the pilot bore, back reaming and pipe installation. Relief holes can be used as necessary to relieve excess pressure down hole. Obtain the County's approval of the location and all conditions necessary to construct relief holes to ensure the proper disposition of drilling fluids is maintained and unnecessary inconvenience is minimized to other facility users.
- B. The Contractor shall determine the pull-back rate in order to allow the removal of soil cuttings without building excess down-hole pressure and to avoid local heaving, or spills. Contain excess drilling fluids at entry and exit points until they are recycled and separated from excavated materials, or removed from the site or vacuumed during drilling operations. Ensure that entry and exit pits and storage tanks are of sufficient size to contain the expected return of drilling fluids and soil cuttings. The bored hole shall always be maintained full of drilling fluids for support of surfaces, and the fluid re-circulation equipment shall operate continuously until the pipe installation is completed and accepted by the County.
- C. Ensure that all drilling fluids are disposed of or recycled in a manner acceptable to the appropriate local, state, or federal regulatory agencies. When drilling in suspected contaminated ground, test the drilling fluid for contamination and appropriately dispose of it. Remove any excess material upon completion of the bore. If in the drilling process it becomes evident that the soil is contaminated, contact the County immediately. Do not continue drilling without the County's approval.
- D. The timing of all boring processes is critical. Install a product into a bore hole within the same day that the pre-bore is completed to ensure necessary support exists. Once pullback operations have commenced, the operation shall continue without interruption until the pipe is completely pulled into the borehole.
- E. All prepared pipe that is being used for installation shall be adequately supported off the ground along the entire length to avoid damaging of the material during pullback due to ground surface conditions. Surface cuts or scratches greater than or equal to the maximum defect depth are not acceptable.

| Pipe Size | Max. Defect Depth |
|-----------|-------------------|
| In. | In. |
| 4 | 1/16 |
| 6 | 1/11 |
| 8 | 5/32 |
| 10 | 3/16 |
| 12 | 1/4 |

- F. The drilling fluid specialist shall remain on the project site during the entirety of the directional boring operation to ensure proper mixture and production of drilling fluids needed for the bore.
- G. Upon successful completion of the pilot hole, the borehole shall be reamed to a minimum of 25 percent greater than the outside diameter of the pipe being installed.
- H. For bores with more than two radii of curvature (entrance and exit), the borehole should be reamed up to 50 percent larger than the outside diameter of the carrier pipe. Prereaming may be necessary dependent on size of material to be pulled.
- I. Additional passes for prereaming may be required for larger pipe. Incremental increases shall be used as needed until appropriate bore hole size has been achieved.
- J. Prereaming must be accomplished with no product attached to the reamer head on all bore pipe 6" and larger. The bore product maybe pulled back on final pass of prereaming upon prior approval from the County.
- K. After reaming the borehole to the required diameter, the pipe shall be pulled through the hole. In front of the pipe shall be a breakaway swivel and barrel reamer to compact the borehole walls.
- L. The Contractor shall not attempt to ream at a rate greater than the drilling equipment and drilling fluid system are designed to safely handle.
- M. Install all piping such that their location can be readily determined by electronic designation (tracer wire) after installation.
 - 1. For all pipe installations, externally attach two (2) tracer wires; see Section 2.01 - Materials, Part I. above, to the top of product pipe and secure in place with duct tape or 10-mil thickness polyethylene pressure sensitive tape at every joint and at 5 foot intervals.
- N. Connect any break in the conductor line before construction with an electrical clamp, or solder, and coat the connection with a rubber or plastic insulator to maintain the integrity of the connection from corrosion. Clamp connections must be made of brass or copper and of the butt end type with wires secured by compression. Soldered connections must be made by tight spiral winding of each wire around the other with a finished length minimum of 3 inches overlap. Tracking conductors must extend 2 feet beyond bore termini. Test conductors for continuity. Each conductor that passes must be identified as such by removing the last 6 inches of the sheath. No deductions are allowed for failed tracking conductors. Upon completion of the directional bore, the Contractor shall demonstrate to the County that the wire is continuous and unbroken through the entire run of the pipe by providing full signal conductivity (including splices) when energizing for the entire run in the presence of the County Representative. If the wire is broken, the Contractor shall repair or replace it at no additional cost to the County.

3.09 PIPELINE TESTING

A. HYDROSTATIC TESTING

1. Refer to Manatee County Public Works Utility Standards Part 1-Utility Standards Manual Section 1.8.7.

B. MANDREL DEFLECTION TESTING PROCESS

1. The deflection test for flexible pipe systems shall be performed by pulling a mandrel through the pipe line. The mandrel shall have a diameter equal to 80 percent of the inside diameter of the pipe system being tested. When the mandrel cannot be pulled through the pipe line the Contractor shall locate and correct the defect to the satisfaction of the County. After the defect is corrected and trench backfilled, the section of line shall then be retested to compliance.
2. Deflection tests shall be performed not sooner than 24 hours after completion of the pipe pull-back. The Contractor shall take measures to ensure the pipe is clean as not to interfere with the mandrel test.
3. The mandrel types that can be used are:
 - a. a rigid, nonadjustable, odd number of legs (9 legs minimum), mandrel having an effective length not less than its nominal diameter; and (2) be fabricated of steel, fitted with pulling rings at each end, stamped or engraved on some segment other than a runner indicating the pipe material specification, nominal size and be furnished in a suitable carrying case labeled with the same data as stamped or engraved on the mandrel.
 - b. If approved by the County, a smaller diameter piece of similar pipe material that is approximately double the nominal diameter in length and meets the 80% reduction of the inside diameter of the pipe being tested. The pipe length may need to be adjusted to ensure the pipe section cannot become skewed and become lodged; this may cause the test to fail.
4. The mandrel shall be pulled through the pipe by hand to ensure that maximum allowable deflections have not been exceeded or that "necking" has not occurred. Prior to use, the mandrel shall be inspected by County personnel. Use of an unapproved mandrel or a mandrel altered or modified after inspection will invalidate the test. If the mandrel fails to pass, the pipe will be deemed overdeflected or necked.
5. Overdeflected or necked pipe shall be abandoned and reinstalled. The replaced pipe shall be tested for deflection not sooner than 24 hours after installation.

D. The following deficiencies in the flexible pipe system installation shall be corrected by the Contractor at no cost to the County:

1. Overdeflections
2. Stretched or "Necked" Pipe
3. Damaged Pipe
4. Improper Pipe Welds
5. Infiltration Points
6. Debris in the line

E. The County will not accept a credit, maintenance bond, or any other form of compensation in lieu of corrective measures that may be required to correct any sections of flexible pipe system that are improperly installed or do not meet the requirements of these specifications.

In addition, all corrective measures proposed by the Contractor shall be approved by the County. In addition, should repairs of the flexible pipe system be accomplished by the use of any unauthorized materials or procedure, the County will require replacement of those substandard portions or repairs made to conform to the requirements of these specifications.

END OF SECTION

SECTION 02619A PIPE BURSTING OF GRAVITY SANITARY SEWER MAINS

PART 1 GENERAL

1.01 SCOPE

The Contractor shall furnish all labor, materials, equipment, tools, and all other required incidentals for the replacement of existing mains by Pipe Bursting method. The Pipe Bursting process is defined as the trenchless reconstruction of existing mains by the simultaneous insertion of liner pipe within the bore of the existing pipe, by breaking and expanding the existing pipe. The scope includes reconnection of existing service connections, television inspection of the newly rehabilitated pipe (if applicable), and complete installation in accordance with the contract documents.

1.02 GENERAL

- A. All existing structures, water and sewer lines, storm drains, utilities, driveways, sidewalks, signs, mail boxes, fences, trees, landscaping, and any other improvement or facility in the construction area that the Contractor disturbs for his own construction purposes shall be replaced to original condition at no additional cost to the County.

1.03 TESTING

- A. In place soil compaction tests shall be performed by a qualified testing laboratory.
- B. Compaction tests shall be taken at every excavation, except in the road crossings or road shoulders; tests are to be taken according to current FDOT Standards.
- C. All pipe shall be tested in accordance with the appropriate material specifications.
- D. Reference Standards: American Society for Testing and Materials (ASTM), D1557, Moisture-Density Relations of Soils Using 10-lb. Rammer and 18-in. Drop.
- E. The density of soil in place shall be a minimum of 98 percent in accordance with ASTM test 1557-70T, Method A or C. inside the right-of-way.
- F. The density of soil in place shall be a minimum of 95 percent in accordance with ASTM test 1557-70T, Method A or C. outside the right-of-way.

1.04 QUALIFICATION REQUIREMENTS

- A. The Contractor shall be certified by the manufacturer of the pipe bursting system that they are fully trained licensed installer of the manufacturer's pipe bursting system. Contractor must provide a letter to the County documenting this requirement.
- B. The Contractor shall have a minimum of three (3) years verifiable experience using the pipe bursting method while meeting the following criteria (based on pipe size for this particular job):
- A minimum total of 100,000 LF of completed pipe bursting footage.
 - A minimum total of 50,000 LF of upsizing where similar sized diameter increases have been successfully completed in pipe diameters of 8-inch to 12-inch range.
 - A minimum total of 25,000 LF of pipe bursting experience on diameters 18-inch and

larger.

- C. Personnel performing pipe bursting must be certified by the manufacturer of the pipe bursting system in having successfully completed training in:
 - Operating bursting head
 - Installing proposed replacement pipe.
 - Operation and maintenance of all equipment to be used
- D. Reference
 - Provide a list of minimum three previous projects completed in the last three years by the contractor/installer in where an existing main was successfully rehabilitated using the pipe bursting method. Include contact names, addresses and phone numbers of agencies involved.

1.05 WARRANTY

- A. In addition to the standard pipe warranty, the Contractor shall provide in writing a warranty for a period of three (3) years for all the work including material, installation, and pressure testing at no additional to the County.
- B. Unless otherwise specified, the warranty period shall begin after the Certificate of Acceptance is issued for the Contract.

1.06 SUBMITTALS

The Contractor shall furnish the following documents made in a timely manner so that project schedule can be met:

- A. Process Demonstration
 - 1. Submit detailed installation procedures including pipe bursting method to be used.
 - 2. Method of construction and restoration of existing water and/or sewer service connections. This shall include detail drawings and written description of the entire construction procedure to install pipe, bypass wastewater flow (if required), and reconnection of water and/or sewer service connections.
- B. Testing Documentations
 - 1. Television inspection reports along with video made after new pipe installation.

PART 2 PRODUCT

2.01 MATERIALS

- A. Liner Pipe shall be high-density polyethylene pipe and meet the applicable requirements of Section 02620 Polyethylene (PE) Pressure Pipe.
 - 1. Sizes of the insertions to be used shall be as shown on the plans or to renew the existing main to its original or greater than original flow capacity.

PART 3 EXECUTION

3.01 DELIVERY, STORAGE AND HANDLING

- A. Transport, handle and store pipe and fittings as recommended by manufacturer. If new pipe

and fittings become damaged before or during installation, it shall be repaired as recommended by the manufacturer or replaced as required by the County, at the Contractor's expense, before proceeding further. Deliver, store and handle other materials as required to prevent damage.

- B. Exposure of product pipe to sunlight shall be limited to 14 consecutive days unless approved by the County.
- C. The pipe shall be supported at intervals along its length with rollers or Teflon pads to minimize frictional forces when being pulled, and to hold the pipe above the ground. Surface cuts or scratches greater than or equal to the maximum defect depth in 3.08 E are not acceptable.

3.02 OBSTRUCTION REMOVAL

- A. Identify any point repairs required, such as dropped joints, intruding service connections, collapsed pipe, sags in main or any other obstructions prior to the pipe bursting process. The Contractor shall remove all obstructions to perform pipe bursting operation, as necessary.
- B. The contractor shall notify the inspector for approval to make an excavation after having exhausted all other options to remove any obstruction or retrieve any pipe bursting tool or camera from the existing main.

3.03 BY-PASS PUMPING

- A. The Contractor, when and where required, will divert wastewater flows for the cleaning, pipe bursting, television inspection, point repairs, obstruction removals, or other related work in this project as required to complete the work.
- B. The Contractor shall be responsible for continuity of water and sanitary sewer service to each facility connected to the section of existing main during the execution of the work.
- C. If sewage backup and/or spills occurs and/or enters buildings, the Contractor shall be responsible for clean up, repair, property damage cost and claims.

3.04 INSERTION PIT OR ACCESS PIT

- A. Insertion or access pits shall be efficiently located so that total the number of pits are minimized and footage of liner pipe installed in a single pull is maximized. Where possible, use existing manholes and excavations at point repair locations for insertion pits.
- B. To facilitate long insertion runs, intermediate insertion pits may be allowed at the most advantageous location to provide for replacement pipe to be installed in both directions. When insertion pits are required in the lanes of traffic, the operation shall be limited to one (1) lane of traffic or one-half (1/2) of the roadway, whichever is less.
- C. Insertion pits shall be only as large as required to accommodate the equipment. All pit dimensions and locations shall be approved by the County in writing, prior to beginning work.
- D. Manholes may be placed at insertion pit location as directed by the County.
- E. In the event the pipe bursting process requires the excavation of an insertion pit, the pipe through the pit shall be bedded in the required bedding material.

3.05 PIPE BURSTING AND LINER INSERTION

- A. Equipment used to perform the work shall be located away from buildings so as to minimize noise impact. Provide silencers or other devices to meet County noise ordinance.
- B. The Contractor shall install all pulleys, rollers, bumpers, alignment control devices and other equipment required to protect existing structures, and to protect the pipe from damage during installation. Lubrication may be used as recommended by the manufacturer. Under no circumstances will the pipe be stressed beyond its elastic limit.
- C. The installed pipe shall be allowed the manufacturer's recommended amount of time, but not less than four (4) hours, for cooling and relaxation due to tensile stressing prior to any reconnection of service lines, sealing of the annulus or backfilling of the insertion pit. Sufficient excess length of new pipe, but not less than four (4) inches, shall be allowed to protrude into a structure to provide for occurrence.
- D. Following the relaxation period, the annular space may be sealed. Sealing shall be made with materials approved by the County and/or his representative and shall extend a minimum of eight (8) inches into the structure wall in such a manner as to form a smooth, uniform, watertight joint.
- E. The new pipe shall be placed without damaging the pipe joints or completed pipe sections. Any pipe which has been damaged during installation shall be replaced by the Contractor.

3.06 PIPE JOINING

- A. The polyethylene pipe shall be assembled and joined at the site using the thermal butt-fusion method to provide a leak proof joint. Threaded or solvent-cement joints and connections are not permitted. All equipment and procedures used shall be used in strict compliance with the manufacturer's recommendations. Fusing shall be accomplished by personnel certified as fusion technicians by a manufacturer of polyethylene pipe and/or fusing equipment.
- B. The butt-fused joint shall be true alignment and shall have uniform roll-back-beads resulting from the use of proper temperature and pressure. The joint shall be allowed adequate cooling time before removal of pressure. When cool, all weld beads shall then be removed from both the inside and outside surface such that the joint surfaces shall be smooth. The fused joint shall be watertight and shall have tensile strength equal to that of the pipe. All joints shall be subject to acceptance by the County and/or his representative prior to insertion.
- C. All defective joints shall be cut out and replaced at no cost to the County. Any section of the pipe with a gash, blister, abrasion, nick, scar or other deleterious fault greater in depth than ten percent (10%) of the wall thickness, shall not be used and must be removed from the site. However, a defective area of the pipe may be cut out and the joint fused in accordance with the procedures stated above. In addition, any section of pipe having other defects such as concentrated ridges, discoloration, excessive spot roughness, pitting, variable wall thickness or any other defect of manufacturing or handling as determined by the County and/or his representative shall be discarded and not used.
- D. Terminal sections of pipe that are joined within the insertion pit shall be connected with a full circle pipe repair clamp. The butt gap between pipe ends shall not exceed one-half (1/2) inch.

3.07 EXTERNAL SERVICE CONNECTIONS

- A. In providing re-connection of existing services, select service connection pipe diameter must match existing service. Any existing sewer service smaller than 6" shall be upsize to minimum of 6".
- B. All service connections shall be identified, located and excavated prior to the pipe insertion to expedite reconnection. Upon commencement, pipe insertion shall be continuous and without interruption, except as approved by the County. Upon completion of insertion of the new pipe, the Contractor shall expedite the reconnection of services to minimize any inconvenience to the customers.
- C. At all points where the polyethylene pipe has been exposed, as in starter excavations, at service connection fittings, outside of manholes, etc., the Contractor shall encase the pipe and fittings in minimum of 6-inches of concrete or flowable backfill. If flowable backfill is used, the Contractor shall remove all debris, and create a void along each side of the pipe at the spring line to undisturbed soil, in preparation for the flowable backfill. Width of the void shall not exceed (main outside diameter + 2ft.) or (service line outside diameter + 2ft.).

3.08 FIELD TESTING

- A. Tests for compliance with this specification shall be made as specified herein and in accordance with the applicable ASTM Specification. A certificate with this specification shall be furnished, upon request, by the manufacturer for all material furnished under this specification. Polyethylene plastic pipe and fittings may be rejected for failure to meet any requirements of this specification.

3.09 POST-PIPE BURSTING TELEVISION INSPECTION (GRAVITY ONLY)

- A. Upon completion of pipe bursting operation and reconnection of the service laterals, the Contractor shall perform television inspection of the rehabilitated wastewater main.

3.10 FINAL CLEANUP

- A. Upon completion of installation, testing and inspection, clean and restore project area affected by work of this section.

END OF SECTION

SECTION 02620 POLYETHYLENE (HDPE) PIPE AND FITTING

PART 1 GENERAL

1.01 SCOPE OF WORK

- A. The Contractor shall furnish all labor, materials, equipment and incidentals required to install polyethylene pressure pipe, fittings and appurtenances as shown on the Drawings and specified in the Contract Documents and these Standards.
- B. Newly installed pipe shall be kept clean and free of all foreign matter & gouges.
- C. All pipe shall be correctly color coded / identified.

1.02 QUALIFICATIONS

All polyethylene pipe, fittings and appurtenances shall be furnished by a single manufacturer who is fully experienced, reputable and qualified in the manufacture of the items to be furnished.

1.03 SUBMITTALS

- A. The Contractor shall submit to the County, within ten days after receipt of Notice to Proceed, a list of materials to be furnished, the names of the suppliers and the appropriate shop drawings for all polyethylene pipe and fittings.
- B. The Contractor shall submit the pipe manufacturer's certification of compliance with the applicable sections of the Specifications.
- C. The Contractor shall submit shop drawings showing installation method and the proposed method and specialized equipment to be used.

PART 2 PRODUCTS

2.01 POLYETHYLENE PRESSURE PIPE

- A. Polyethylene pipe 4" diameter and larger shall be high-density bimodal PE3408/PE 100/PE4710 polyethylene resin with a minimum cell classification of 445574 per ASTM D3350, Class 160, DR 11, Performance Pipe DriscoPlex 4000, or an approved equal, meeting the requirements of AWWA C906. All pipe materials used in potable water systems shall comply with NSF Standard 61. Outside diameters of water, reclaimed water and pressure sewer HDPE pipes shall be ductile-iron sizing system (DIPS).
- B. Polyethylene pipe 3 inches in diameter (for potable water and reclaimed water), and 3 inches in diameter and smaller (for wastewater grinder pump force mains) shall be high-density PE 3408 polyethylene, per ASTM D2737, Pressure Class 160, iron pipe size (IPS) outside diameter, DR 11, Performance Pipe DriscoPlex 4100 or an approved equal, meeting the requirements of ASTM D 3035 and AWWA C901.
- C. Polyethylene tubing 2 inches in diameter and smaller for potable water and reclaimed water shall be high density PE 3408 polyethylene resin per ASTM D2737, Pressure Class 200, Copper Tube Size (CTS), SDR 9, Performance Pipe DriscoPlex 5100, Endot EndoPure, Charter Plastics or an approved equal, meeting the requirements of AWWA C901. Butt

fusion or CTS brass connections shall be used. All pipe materials used in potable water systems shall comply with NSF Standard 61.

2.02 JOINTS

- A. Where PE pipe is joined to PE pipe, it shall be by thermal butt fusion. Thermal fusion shall be accomplished in accordance with the written instructions of the pipe manufacturer and fusion equipment supplier. The installer of the thermal butt fused PE pipe shall have received training in heat fusion pipe joining methods and shall have had experience in performing this type of work.
- B. Flanged joints, mechanical joints and molded fittings for 4" and larger pipe shall be in accordance with AWWA C906. Mechanical joints and fittings for 3" and smaller pipe & tubing shall meet the requirements of: AWWA C901, ASTM D 3350 and ASTM D 3140.

2.03 DETECTION

- A. Direct buried HDPE pipe shall have 3" detectable metallic tape of the proper color placed directly above the pipe and 12" below finished grade or 6" detectable tape between 12" and 24" below finished grade.
- B. Direct buried or horizontal directional drilled HDPE pipe shall also have tracer wire installed along the pipe alignment. The tracer wire to be used shall be a solid, 10 gauge, high strength, copper clad steel wire with a polyethylene jacket of appropriate color manufactured by Copperhead Industries or Manatee County approved equal.

2.04 IDENTIFICATION

- A. Pipe shall bear identification markings in accordance with AWWA C906.
- B. Pipe shall be color coded blue for water, purple (Pantone 522 C) for reclaimed water or green for pressure sewer using a solid pipe color or embedded colored stripes. Where stripes are used, there shall be a minimum of three stripes equally spaced.

PART 3 EXECUTION

3.01 INSTALLING POLYETHYLENE PRESSURE PIPE AND FITTINGS

All polyethylene pressure pipe shall be installed by direct bury, directional bore, or a method approved by the County prior to construction. If directional bore is used, or if directed by the County, the entire area of construction shall be surrounded by silt barriers during construction.

3.02 INSPECTION AND TESTING

All pipelines shall remain undisturbed for 24 hours to develop complete strength at all joints. All pipelines shall be subjected to a hydrostatic pressure and leak testing. Refer to Manatee County Public Works Utility Standards Part 1-Utility Standards Manual Section 1.8.7.

END OF SECTION

**SECTION 02622 POLYVINYL CHLORIDE (PVC) PIPE AND FITTINGS
(AWWA SPECIFICATIONS C-900 & C-905)**

PART 1 GENERAL

1.01 SCOPE OF WORK

- A. Furnish all labor, materials, equipment and incidentals required to install the PVC piping, iron fittings and other appurtenances complete and ready for use as indicated on the construction drawings.
- B. Provide and install complete all fittings and appurtenances not noted specifically on the construction plans as required to complete the utility system in accordance with these Standards.

1.02 DESCRIPTION OF SYSTEM

The Contractor shall install the piping in the locations as shown on the Drawings.

1.03 QUALIFICATIONS

All plastic pipe, fittings and appurtenances shall be furnished by a single manufacturer who is fully experienced, reputable, qualified and specializes in the manufacture of the items to be furnished. The pipe and fittings shall be designed, constructed and installed in accordance with the best practices and methods and shall comply with these Specifications.

1.04 SUBMITTALS

- A. The Contractor shall submit shop drawings to the County including, but not limited to, dimensions and technical specifications for all piping.
- B. The Contractor shall submit to the County, samples of all materials specified herein.
- C. The Contractor shall submit and shall comply with pipe manufacturer's recommendation for handling, storing and installing pipe and fittings.
- D. The Contractor shall submit pipe manufacturer's certification of compliance with these Specifications.

1.05 TOOLS

The Contractor shall supply special tools, solvents, lubricants, and caulking compounds required for proper installation.

PART 2 PRODUCTS

2.01 MATERIALS

- A. Polyvinyl chloride (PVC) pressure pipe, 4 - 12 inches in diameter, shall be Class 235, DR 18, meeting the requirements of AWWA C900 used for potable and reclaimed water. Mains shall be cast-iron-pipe-equivalent outside diameters (also known as ductile iron pipe size (DIPS)). Each length of pipe shall be hydrostatically tested to four times its pressure class of the pipe by the manufacturer in accordance with AWWA C900.

- B. Polyvinyl chloride (PVC) pressure pipe, 14 inches in diameter, shall be ductile iron pipe size (DIPS) outside diameter and shall meet the requirements of AWWA C905. Pipe used in water, sewer, and reclaimed water service shall be DR 18 and Pressure Class 235. Each length of pipe shall be hydrostatically tested at twice its pressure class in accordance with AWWA C905. Pipe shall be furnished in standard lengths of approximately 20 feet.

PVC pipe shall not be used for potable and reclaimed water mains 16 inches and larger.

- C. Polyvinyl chloride (PVC) pressure pipe, 2-3 inches in diameter, shall be Pressure Rated 200, SDR21, conforming to ASTM D2241, and shall have Iron Pipe Size (IPS) outside diameters. SDR 21 PVC pipe 2-3 inches in diameter shall not be used for working pressures greater than 125 psi. PVC pipe shall not be used in applications, which require pipes that are less than 2 inches in diameter for wastewater force mains. PVC Pipe shall not be used in applications which require pipes that are less than 3 inches in diameter for potable water piping and reclaimed water piping.
- D. Standard PVC pressure pipe joints shall be bell and spigot push-on type with elastomeric ring seals. Ring seal gaskets used at push-on joints shall conform to ASTM F 477 and shall be EPDM rubber for potable and reclaimed water pipes.
- E. Lubricant furnished for lubricating the push-on joints in potable water pipes shall be nontoxic, water soluble, shall not support the growth of bacteria, shall have no deteriorating effects on the gasket or pipe material, and shall not impart color, taste, or odor to the water, and shall be an approved substance per NSF 61.
- F. Thrust restraint devices shall be provided at all horizontal and vertical bends and fittings, in casings under roads and railroads and at other locations as indicated on the construction drawings. Thrust restraint devices for PVC pipe and fittings shall be either concrete thrust blocks or restraining glands as manufactured by Star Pipe Products, Stargrip 3000 and 3100, Allgrip 3600, or as manufactured by EBAA Iron Sales, Megaflange, 2000PV or other approved equal restraining gland products. Restrained joints, where used, shall be installed at bend and fitting locations and at pipe joint locations both upstream and downstream from bends or fittings at distances as required by these Standards.
- G. All fittings for PVC pipe shall be ductile iron or gray iron with mechanical joints and shall conform to AWWA C110 or AWWA C153 and to the applicable sections of these Standards for ductile iron and gray iron fittings.
- H. All pipe materials used in potable water systems shall comply with NSF Standard 61.

PART 3 EXECUTION

3.01 INSTALLATION

The Contractor shall install the plastic pipe in strict accordance with the manufacturer's technical data and printed instructions.

3.02 DETECTION

- A. Direct buried pipe shall have 3" warning tape of the proper color placed directly above the pipe 12" below finished grade or 6" warning tape between 12" and 24" below grade.

- B. PVC pipe shall have a solid, 10 gauge, high strength, copper clad steel wire with a polyethylene jacket of appropriate color installed along the pipe alignment as detailed in these standards. Tracer wire shall be manufactured by Copperhead Industries or Manatee County approved equal.

3.03 IDENTIFICATION

- A. PVC pipe shall bear identification markings in accordance with AWWA C900, AWWA C905 or ASTM D2241.
- B. PVC pipe shall be color coded blue for water, purple (Pantone purple 522C) for reclaimed water or green for pressure sewer using a solid pipe color pigment.

3.04 INSPECTION AND TESTING

All pipelines shall remain undisturbed for 24 hours to develop complete strength at all joints. All pipelines shall be subjected to a hydrostatic pressure and leak testing. Refer to Manatee County Public Works Utility Standards Part 1-Utility Standards Manual Section 1.8.7. Prior to testing, the pipe lines shall be supported in a manner approved by the County to prevent movement during tests.

END OF SECTION

SECTION 02623 POLYVINYL CHLORIDE (PVC) PIPE (GRAVITY SEWER)

PART 1 GENERAL

1.01 SCOPE OF WORK

- A. The Contractor shall furnish all labor, equipment, materials, pipe and incidentals and shall construct gravity sewers, complete, as shown on the drawings and as herein specified.
- B. The work shall include furnishing, laying and testing gravity sewer pipe.

1.02 SUBMITTALS DURING CONSTRUCTION

- A. The Contractor shall submit prior to construction, Shop Drawings, Working Drawings and Samples for approval to the County.
- B. The Contractor shall submit to the County not less than fourteen (14) calendar days after the date of the Notice to Proceed, a list of materials to be furnished, the names of suppliers and an expected schedule of delivery of materials to the site.
- C. The Contractor shall furnish in duplicate to the County sworn certificates that all tests and inspections required by the Specifications under which the pipe is manufactured have been satisfied.
- D. The pipe manufacturer shall inspect all pipe joints for out-of-roundness and pipe ends for squareness. The Contractor shall furnish to the County, a manufacturer's Notarized Affidavit stating all pipe meets the requirements of ASTM, ASCE, ANSI, the Contract Documents, as well as all applicable standards regarding the joint design with respect to square ends and out-of-round joint surfaces.

1.03 INSPECTION AND TESTS

- A. All pipe and accessories installed under this Contract shall be inspected and tested as required by the Standard Specifications to which the material is manufactured. The pipe shall be tested at the place of manufacture or taken to an independent laboratory by the manufacturer.
- B. Each length of pipe shall be subject to inspection and approval at the factory, point of delivery and site of work. Sample of pipe to be tested shall be selected at random by the County or the testing laboratory and shall be delivered by the Contractor to the testing laboratory approved by the County.
- C. When the specimens tested conform to applicable standards, all pipe represented by such specimens shall be considered acceptable based on the test parameters measured. Copies of test reports shall be submitted to the County prior to the pipe installation. Acceptable pipe shall be stamped with an appropriate monogram under the supervision of the testing laboratory.
- D. All pipe test specimens failing to meet the applicable standards shall be rejected. The Contractor may provide two additional test specimens from the same shipment or delivery for each failed specimen. The pipe shall be acceptable if both of these additional specimens meet the requirements of the applicable standards.

- E. Pipe which has been deemed unacceptable by the County shall be removed from the work site by the Contractor and shall be replaced with acceptable pipe.

PART 2 MATERIALS

2.01 GENERAL

- A. The sizes of gravity sewer pipe shall be shown on the Drawings.
- B. Each length of pipe shall bear the name or trademark of the manufacturer, the location of the manufacturing plant and the class or strength classification of the pipe. The markings shall be plainly visible on the pipe barrel.

2.02 POLYVINYL CHLORIDE (PVC) GRAVITY SEWER PIPE

- A. Polyvinyl chloride (PVC) gravity sewer pipe and fittings, 4-15 inches in diameter, shall be SDR 26, meeting the requirements of ASTM D 3034. Joining of pipe sections and fittings shall be by water-tight push-on joints using elastomeric gaskets in accordance with ASTM D 3212.
- B. Polyvinyl chloride (PVC) pipe, 16-48 inches in diameter, for gravity sewers, shall be DR 25, with cast-iron (CI) outside diameter, meeting the requirements of AWWA C905.
- C. All PVC sewer pipe bell ends shall be field inspected for out-of-roundness and spigot ends shall be field inspected for out-of-roundness and for squareness of the pipe end. Any materials not in conformance with the tolerances of ASTM D 3212 or AWWA C905 shall be removed from the work site.
- D. All PVC sewer pipe sections shall also be field inspected for excessive cross-section deflection. Any pipe section visually found to have a pipe deflection, before installation, of 2 percent of the Base Inside Diameter or greater shall be removed from the work site. After installation and backfill, pipe deflection shall not be allowed to be 5 percent or greater of the Base Inside Diameter. Any length of pipe found installed having excessive deflection shall be dug up and either reinstalled or removed from the work site.
- E. Six inch PVC fittings for sewer laterals shall also be SDR 26, molded in one piece, with elastomeric joints in accordance with ASTM D-3034. Fittings not currently available in molded form may be fabricated in accordance with ASTM D-3034 with manufacturer's standard pipe bells and gaskets.

2.03 JOINING PVC GRAVITY SEWER AND FITTING

- A. The PVC joints shall be of the push-on type with a single rubber gasket conforming to ASTM F 477.
- B. Wyes and riser fittings shall be gasketed connections. Rubber doughnuts are not to be used.
- C. Joints between pipes of different materials shall be made using stainless steel shielded couplings (as provided by Fernco) or Protecto 401 mechanical joint connections. Metal piping shall not be threaded into plastic fittings, valves, or couplings, nor shall plastic piping be threaded into metal valves, fittings, or couplings.

2.04 INDENTIFICATION AND DETECTION

- A. PVC gravity sewer pipe shall bear identification markings in accordance with ASTM D 3034 or AWWA C905.
- B. PVC gravity sewer pipe shall be color-coded green using a solid pipe color pigment.

PART 3 EXECUTION

3.01 PIPE DISTRIBUTION

The Contractor shall not distribute material on the job faster than it can be used to good advantage. He shall unload pipe, which cannot be physically lifted by workers from the trucks, by a forklift or other approved means. He shall not drop pipe of any size from the bed of the truck to the ground. He shall not distribute more than one weeks supply of material in advance of laying, unless otherwise approved by the County.

3.02 PIPE PREPARATION AND HANDLING

- A. The Contractor shall inspect all pipe and fittings prior to lowering them into trench. Cracked, broken, or otherwise defective materials are not acceptable and shall not be used. The Contractor shall clean the ends of the pipe thoroughly. He shall remove foreign matter and dirt from inside of pipe and keep the pipe clean during and after laying.
- B. The Contractor shall use proper implements, tools and facilities for the safe and proper protection of the work. He shall lower the pipe into the trench in a manner to avoid any physical damage to the pipe, remove all damaged pipe from the job site and under no circumstances shall the pipe be dropped or dumped into trenches.

3.03 LINE AND GRADE

- A. The Contractor shall not deviate more than 1/2-inch for line and 1/4-inch for grade from the line design and design grade established by the County provided that such variation does not result in a level or a reverse sloping invert. He shall measure the grade at the pipe invert and not at the top of the pipe. The Contractor shall furnish, set and control the line and grade by laser beam method. Other methods of controlling line and grade may be submitted to the County for approval if using the laser beam method proves to be impractical because of other conditions.
- B. The Contractor shall use the laser beam method of maintaining line and grade. The Contractor shall submit evidence to the County that a qualified operator shall handle the equipment during the course of construction. A "Caution-Laser Light" placard shall be displayed in a conspicuous place. When "in the pipe" method is used, grade boards shall be installed for the first 50 feet of pipe. The Contractor shall check the line and grade at any additional points at which offset stakes have been placed and when requested by the County. A fan shall be provided to circulate the air if bending of the beam due to air temperature variations becomes apparent with "in the pipe" units. However excessive air velocity shall not be permitted to cause pulsating or vibrating of the beam. If, in the opinion of the County, the beam cannot be accurately controlled, this method of setting line and grade shall be discontinued. When the above ground method is used, the set-up shall be checked with the three grade boards including one set at the upstream manhole. If the laser has a gradient indicator, two boards may be used to check the set-up. The grade board at the up-stream manhole shall be retained to check into as pipe laying progresses.

3.04 PREPARATION OF TRENCH

- A. The Contractor shall provide pipe bedding material under all the pipe for the full trench width. The minimum depth of bedding material below the pipe barrel shall be as follows

Minimum Depth of

| <u>Pipe Size</u> | <u>Bedding Under Pipe Barrel</u> |
|------------------|----------------------------------|
| 15" & Smaller | 4 inches |
| 18" to 36" | 6 inches |
| 42" & Large | 9 inches |

- B. The depth of pipe bedding material under the pipe bell shall not be less than three inches under normal trench conditions.
- C. The Contractor shall hand-grade bedding to proper grade ahead of the pipe laying operation. The bedding shall provide a firm, unyielding support along the entire pipe length.
- D. Should the Contractor excavate the trench below the required depth for pipe bedding material placement without direction from the County, the Contractor shall fill the excess depth with pipe bedding material as specified herein to the proper subgrade.
- E. The Contractor shall excavate bell holes at each joint to permit proper assembly and inspection of the entire joint.

3.05 DEWATERING

The Contractor shall prevent water from entering the trench during excavation and pipe laying operations to properly grade the bottom of the trench and allow for proper compaction of the backfill. Pipe shall not be laid in water.

3.06 LAYING AND JOINTING PIPE AND FITTINGS

- A. The Contractor shall lay pipe upgrade with spigot ends pointing in direction of flow. After a section of pipe has been lowered into the prepared trench, he shall clean the end of the pipe to be joined, the inside of the joint and, if applicable, the rubber ring immediately prior to joining the pipe. The Contractor shall assemble the joint in accordance with the recommendations of the manufacturer of the type of joint used. He shall provide all special tools and appliances required for the jointing assembly.
- B. The Contractor shall lay all pipe uniformly to line and grade so that the finished sewer shall present a uniform bore. Variations from line and grade in excess of the tolerances specified under LINE AND GRADE are not acceptable and the work shall be rejected.
- C. The Contractor shall check the pipe for alignment and grade after the joint has been made. The pipe bedding shall form a continuous and uniform bearing and support for the pipe barrel between joints. Sufficient pressure shall be applied to the joint to assure that the joint is "home" as defined in the standard installation instructions provided by the pipe manufacturer. The Contractor shall place sufficient pipe cover material to secure the pipe from movement prior to installing the next joint to assure proper pipe alignment and joint makeup.

- D. Pipe 21" and smaller intended to be in straight alignment shall be laid so that the inside joint space does not exceed 3/8" in width. If interior joints on 24" and larger pipe laid either in straight alignment or on a curve are greater than 3/8", the Contractor shall thoroughly clean the joint surfaces and fill and seal the entire joint with premixed mortar conforming to ASTM C-387 only after the trench has been backfilled, unless otherwise approved by the County. Trowel smooth on the inside surface. Water shall not be allowed to rise in or around, or pass over any joint before it has substantially set.
- E. When the Contractor lays pipe within a movable trench shield, he shall take all necessary precautions to prevent pipe joints from pulling apart when moving the shield ahead.
- F. The Contractor shall prevent excavated or other foreign material from getting into the pipe during the laying operation. He shall close and lock the open end of the last laid section of pipe to prevent entry of foreign material or creep of the gasketed joints when laying operations cease, at the close of the day's work, or whenever the workers are absent from the job.
- G. The Contractor shall plug or close off the pipes which are stubbed off with temporary plugs.
- H. The Contractor shall take all necessary precautions to prevent the "uplift" or floating of the line prior to the completion of the backfilling operation.
- I. The Contractor shall make connections of non-reinforced pipe to manholes or concrete structures, so that a standard pipe joint is located at a minimum of 18" outside the edge of structure.
- J. When field cutting and/or machining the pipe is necessary, the Contractor shall use only tools and methods recommended by the pipe manufacturer and approved by the County.
- K. Service lateral shall be constructed by the Contractor as shown on the standard sewer details and located approximately as shown on the Contract Drawings.

3.07 LAYING PLASTIC PIPE

- A. Polyvinyl chloride (PVC) pipe shall be installed by the Contractor in accordance with the instructions of the manufacturer, as shown on the Drawings and as called out in the Contract Documents.
- B. The Contractor shall lay the pipe, bedding and backfill to lines and grade shown on the Drawings and called out in the Contract Documents. Blocking under the pipe will not be permitted.
- C. The Contractor shall install a green metallic tape as shown in these Standards below finish grade along the entire pipeline PVC sewer main pipe route.
- D. The Contractor shall use care in the handling, storage and installation of pipe. Storage of pipe on the job site shall be done in accordance with the pipe manufacturer's recommendation.

3.08 BACKFILL IN THE PIPE ZONE

- A. The pipe zone shall be considered to include the full width of the excavated trench from the bottom of the trench to a point above the top outside surface of the barrel of the pipe.

- B. The Contractor shall pay particular attention to the area of the pipe zone from the flow line to the springline of the pipe to insure that firm support is obtained to prevent any lateral movement of the pipe during the final backfilling of the pipe zone.
- C. The Contractor shall take care to insure that the pipe does not rest directly on the bell or pipe joint, but is uniformly supported on the barrel throughout its entire length.
- D. After the pipe is laid by the Contractor to line and grade, he shall place and carefully compact pipe bedding material for the full width of the trench to the springline of the pipe. He shall place the material around the pipe in 6-inch layers and thoroughly hand tamp with approved tamping sticks supplemented by "walking in" and slicing with a shovel to assure that all voids are filled.
- E. The Contractor shall backfill and carefully compact the area above the pipe springline with pipe cover material to a point 12" above the top outside surface of the pipe barrel. Pipe bedding material may, at the Contractor's option, be substituted for pipe cover material.

3.09 EXCESS TRENCH WIDTH

- A. Normal trench widths shall be as shown on the Drawings. If the normal trench width below the top of the pipe is exceeded for any reason, the Contractor shall furnish an adequate support for the pipe. The County may determine that the pipe being used is strong enough for the actual trench width or the Contractor may furnish a stronger pipe or a concrete cradle for approval.
- B. Concrete thickness under the pipe shall be one-third of the nominal diameter of the pipe, but not less than four inches. Concrete block or brick may be used for adjusting and maintaining proper grade and elevation of pipe. After the pipe is laid to line and grade, the Contractor shall place 3,000 psi concrete under the pipe for the full width of the trench to form a cradle of the required length and thickness with the concrete brought up to a level equal to 1/4 of the inside pipe diameter below the springline of the pipe. Start and terminate the concrete cradle at the face of a pipe bell or collar. Do not encase pipe joints at the ends of the concrete cradle.
- C. After the concrete has taken initial set, the Contractor shall place cover material over the concrete cradle and up to a level 12" above the pipe barrel and for the full width of the trench. Cover material shall be placed by hand or by equally careful means.

3.10 CONNECTING DISSIMILAR PIPE MATERIALS

The Contractor shall use the following method to connect dissimilar pipe materials. Use concrete closure collars only when approved by the County and then only to make connections between dissimilar pipe when standard rubber gasketed joints or shielded couplings are impracticable. Before the closure collars are poured, wash the pipe to remove all loose material and soil from the surface on which the concrete will be placed. Wet nonmetallic pipe thoroughly prior to pouring the collars. Wrap and securely fasten a light gauge of sheet metal or building-felt around the pipe to insure that no concrete shall enter the line. Place reinforcement as shown on the plans. Make entire collar in one pour using 3,000 psi concrete and extend a minimum 12" on each side of the joint. The minimum thickness around the outside diameter of the pipe shall be 6". No collar shall be poured in water. After the collars are poured and have taken their initial set, cure by covering with well-moistened earth.

3.11 PIPE BULKHEADS

- A. Connections for future sewers shall be bulkheaded by the Contractor in the following manner:
1. All wyes and bell-and-spigot pipe sewers 18" in diameter or smaller shall be bulkheaded with caps or disc stoppers with factory-fabricated resilient joints. The disk or cap shall be banded or otherwise secured to withstand all test pressures without leakage.
 2. Connections 21" and 24" in diameter shall be bulkheaded with a four-inch brick wall, using clay brick or concrete brick. The wall shall be capable of withstanding all test pressures without leakage.
 3. Connections 27" in diameter and larger shall be bulkheaded with an eight-inch wall, using clay brick or concrete brick. The wall shall be capable of withstanding all test pressures without leakage.

3.12 AIR TEST FOR GRAVITY SEWERS - GENERAL

- A. Gravity sewers shall be required to pass the low pressure air test. All pipelines shall remain undisturbed for 24 hours to develop complete strength at all joints. Refer to Manatee County Public Works Utility Standards Part 1-Utility Standards Manual Section 1.8.10.
- B. Air loss rates may be measured by the County. These tests shall be performed by the Contractor under the observation of the County Inspector.
- C. The groundwater height above the installed pipe shall be determined by attaching a transparent plastic tube to a pipe nipple in the manhole and using the plastic tube as a manometer. A test hole may be dug directly above the sewer main for visual inspection.
- D. The ends of branches, laterals, tees, wyes and stubs included in a test section shall be plugged to prevent air leakage. All plugs shall be secured to prevent blowout due to internal pressure. A test section is defined as the length of sewer between manholes.
- E. The Contractor shall repair all visible leaks in manholes and pipe, even if the leakage test requirements are met.

3.13 TELEVISION INSEPTION OF GRAVITY SEWERS

- A. TV inspection of the entire length of the inside of new gravity sewer mains shall be conducted by the Contractor. The County Inspector shall have been notified and shall be present during the TV inspection.
- B. The sewer pipelines shall be thoroughly cleaned of all dirt, debris or obstructions before the TV inspection. Water shall be added to the upstream manhole until it is seen flowing from the most downstream point of the system to be inspected.
- C. The TV camera shall be a self-propelled, 360 degree pan-head, high resolution, color type and shall have dual DVD recording capability. The camera shall be equipped with a depth gauge calibrated to ¼-inch increments to accurately record the depth of the water in the pipeline. A calibration report shall be submitted with each digital video disk (DVD), which shall include a drawing of the depth gauge, indicating the marks on the gauge, and what depth each mark represents.

- D. The County Inspector shall be present and will observe the TV monitor along with the camera operator as the camera progresses through the pipe. All pipelines will be inspected with the camera progressing in an upstream direction when possible. The camera operator shall record the manhole numbers and the distance the camera has progressed from the downstream manhole as the inspection proceeds. The operator shall stop the progress of the camera and record the distance at all locations along the pipeline where unusual or defective features are encountered. The operator shall record the distance and depth of the water in the pipe at all locations where the depth is greater than or equal to 75% of the maximum depth as listed in the table below. The camera operator shall make records where cracked, dented or deformed pipe is found, or at joints that are not properly installed, or where infiltration is observed, or at any other abnormality or where any other defective feature is encountered.
- E. Pipe grade between manholes shall not deviate by more than the maximum depth as list below from the design grade line, as measured with the television (TV) camera's depth gauge during the TV inspection, provided that such deviation does not result in a level or a reverse slope. Joint deflection and longitudinal pipe deflection between manholes that exceeds the maximum depth or more than two deflections that exceed 75% of the maximum depth, as measured with the television camera's depth gauge during the TV inspection, shall not be accepted.

| Pipe Sizes | Water Holding Depth (inches) | |
|---------------------|------------------------------|---------|
| | | Maximum |
| 8 inch to 15 inch | | 1.00 |
| 18 inch to 21 inch | | 2.00 |
| 24 inch and greater | | 2.50 |

- F. At the end of the inspections, or at the end of the day, one original digital video disk (DVD) of the TV record shall be submitted to the County Inspector along with the written inspection report and depth gauge calibration for evaluation. The County's representative shall be the sole judge of whether any information imparted by the TV test DVD will cause the County to accept or reject the pipe test section.

3.14 PIPE RING DEFLECTION TESTING OF GRAVITY SEWERS (MANDREL)

- A. The Contractor shall perform a pipe ring deflection test on all new gravity sanitary sewer mains. The rigid ball or mandrel used for the ring deflection test shall have a diameter not less than 95 percent of the base inside diameter or average inside diameter of the pipe depending on which is specified in the ASTM C 3034, to which the pipe is manufactured. The test shall be performed without mechanical pulling devices.
- B. The allowable ring deflection is 5 percent of the inside pipe diameter. Pipes that have a ring deflection that exceeds this amount shall not be accepted.

3.15 FINAL SEWER CLEANING

- A. Prior to final acceptance and final manhole-to-manhole inspection of the sewer system by the County, the Contractor shall flush and clean all parts of the system, remove all accumulated construction debris, rocks, gravel, sand, silt and other foreign material from

the sewer system at or near the closest downstream manhole.

- B. During the final manhole-to-manhole inspection of the sewer system, the County may require the Contractor to reflush and clean any section or portion of the line if any foreign matter is still present in the system.

END OF SECTION

SECTION 02625 FIBERGLASS MANHOLES

PART 1 GENERAL

1.01 SCOPE OF WORK

- A. The Contractor shall furnish all materials, labor and equipment and construct manholes consisting of fiberglass as shown on the Drawings and as specified herein.
- B. Fiberglass reinforced polyester manholes shall be manufactured from commercial grade polyester or vinyl ester resin with fiberglass reinforcements. Manholes shall be a one piece unit manufactured to meet or exceed all specifications of A.S.T.M. D-3753, latest addition. Manholes shall be manufactured by an established national manufacturer exclusively producing FRP sanitary sewer manholes.
- C. The manufacture, dimensions, material and construction methods shall be available for inspection and approved by the County in advance of construction. The County reserves the right to inspect the facilities of the supplier and the manufacturer if they are different.
- D. Intercept manholes shall be either free standing fiberglass or precast concrete with one piece fiberglass liner. Intercept manholes are defined as manholes with a force main discharging into them followed by gravity manholes to the lift station. They are further defined as other than straight through flow, such as tees or drop inlet. Manholes where turbulence and release of hydrogen sulfide gas is anticipated are also considered intercept manholes.

1.02 SUBMITTALS

The Contractor shall submit shop drawings showing details of construction, reinforcing, joints, openings and all other specified details, including traffic wheel load rating, to the County for review and approval.

1.03 INSPECTION

- A. The quality of all materials, the process of manufacture and the finished sections shall be subject to inspection and approval by the County or authorized representative of the County. Such inspection may be made at the place of manufacture, on site, or both locations. The fiberglass section may be inspected prior to unloading from the delivery truck and marked by the inspector showing acceptance or rejection. However, discovery of failure at any time to meet the requirements of these Specifications is cause for rejection.
- B. Sections rejected after delivery to the job shall be marked for identification and shall be removed from the job at once. All sections which are damaged after delivery as determined by the County, shall be rejected. Sections already installed, shall be removed and replaced entirely at the Contractor's expense.
- C. At the time of inspection, the sections shall be examined for compliance with ASTM D-3753, latest revision, these Specifications and with the approved manufacturer's drawings. All sections shall be inspected for general appearance, dimension, blisters, cracks, roughness, soundness, etc. The surface shall be free of defect.
- D. Imperfections may be repaired subject to the approval of the County and after demonstration by the manufacturer that strong and permanent repairs result.

PART 2 PRODUCTS

2.01 FIBERGLASS MATERIALS

- A. Resin: The resins used shall be a commercial grade unsaturated polyester resin.
- B. Reinforcing Materials: The reinforcing materials shall be commercial Grade "E" type glass in the form of continuous roving and chop roving, and shall have a coupling agent that will provide a suitable bond between the glass reinforcement and the resin.
- C. Interior Surfacing Material: The inner surface exposed to the chemical environment shall be a resin-rich layer of 0.010 to 0.020" thick. The inner surface layer exposed to the corrosive environment shall be followed with a minimum of two passes of chopped roving of minimum length 0.5" (13 mm) to maximum length of 2.0" (50.8 mm) and shall be applied uniformly to an equivalent weight of 3 oz/ft². Each pass of chopped roving shall be well-rolled prior to the application of additional reinforcement. The combined thickness of the inner surface and interior layer shall not be less than 0.10" (2.5 mm).
- D. Interior Surface: The surface shall be free of crazing, delamination, blisters larger than 0.5" in diameter and wrinkles of 0.125" or greater in depth. Surface pits may be permitted if they are less than 0.75" in diameter and less than 0.0625" deep. Voids that may not be broken with finger pressure and that are entirely below the resin surface shall be permitted if they are less than 0.5" in diameter and less than 0.0625" thick.
- E. Wall Construction Procedure: After inner layer has been applied, the manhole wall shall be constructed with chop and continuous strand filament wound manufacturing process which insures continuous reinforcement and uniform strength and composition. The cone section, if produced separately, shall be affixed to the barrel section at the factory with resin-glass reinforced joint resulting in a one piece unit. Seams shall be fibreglassed on the inside and the outside using the same glass-resin jointing procedure.
- F. Exterior Surface: There shall be a UV inhibitor consisting of gray pigment added to the exterior resin coat for a minimum thickness .125" to prevent degradation during aboveground storage.
- G. Repairs: All manhole repairs shall meet all requirements of the Contract Documents.
- H. Manhole Lengths: Manhole lengths shall be measured in 6" increments +/- 2".
- I. Diameter Tolerance: Tolerance of inside diameter shall be +/- 1% of required manhole diameter.
- J. Load Rating: The complete manhole shall have a minimum dynamic-load rating of 16,000 lbs. when tested in accordance with A.S.T.M. D-3753. To establish this rating, the complete manhole shall not leak, crack, or suffer other damage when load tested to 40,000 lbs. and shall not deflect vertically downward more than 0.25 in. at the point of load application when loaded to 24,000 lb. This testing criteria shall not relieve the manufacturer of the responsibility for providing manholes that may sustain, without damage, all legal Florida wheel loads.
- K. Stiffness: The manhole cylinder shall have the minimum pipe-stiffness values shown in table below when tested in accordance with A.S.T.M. D-3753 Table 1.

| MANHOLE LENGTH IN FT. | F/-Y, PSI (k Pa) |
|-----------------------|------------------|
| 3 - 6.5 | 0.72 (4.96) |
| 7 - 12.5 | 1.26 (8.69) |
| 13 - 20.5 | 2.01 (13.86) |
| 21 - 25.5 | 3.02 (20.82) |
| 26 - 35 | 5.24 (36.13) |

- L. Soundness: The Contractor shall insure that in order to determine soundness, the manufacturer shall apply an air or water pressure test to the manhole test sample. Test pressure shall be not less than 3 psig or greater than 5 psig. The manufacturer shall inspect the entire manhole for leaks while holding at the established pressure. Leakage through the laminate shall be cause for failure of the test. Refer to A.S.T.M. D-3753 8.6.
- M. Chemical Resistance: Test in accordance with A.S.T.M. D-3753 8.7.
- N. Manhole Bottom: Manholes may require resin fiber-reinforced bottoms. Bottom shall have a minimum of three 1-1/2" deep x 3-1/2" wide stiffening ribs completely enclosed with resin fiber-reinforcement and have a minimum 3" anti-flotation ring. Manhole bottom shall be a minimum of 5/16" thick and designed to resist all pressures induced by water, soil and wheel loads with a maximum deflection of 1/4".
- O. Fillers and Additives: Fillers shall be inert to the environment and manhole construction. Sand shall not be an approved filler. Additives, such as thixotropic agents, catalysts, promoters, etc., may be added as required by the specific manufacturing process to be used to meet the requirements of the Contract Documents. The resulting reinforced-plastic material shall meet the requirements of the Contract Documents.

2.02 MANHOLE FRAMES AND LIDS

Manhole frames and lids shall meet ASTM A48, Specification for Gray Iron Castings, Class 30 or Grade 60-45-12 Ductile Iron meeting the requirements of ASTM A536, Specification of Ductile Iron Casting. Cast in a true symmetrical pattern of tough, dense and even grained iron, free from warping, scales, lumps, blisters, sandholes or any defects of any kind. Provide indented pattern lids with lettering as shown on the Drawings. Machine or grind frames and lids at touching surfaces to provide firm seats and prevent rocking. Remove and replace any set not matching perfectly. All frames and covers shall be designed to withstand an HS20 wheel loading as defined by AASHTO specifications.

2.03 MANHOLE INSERTS

All sanitary sewer manholes installed shall require watertight manhole inserts. Inserts shall be as manufactured by FRW Industries, Conroe, Texas or approved equal. Inserts shall be complete with a self-cleaning relief valve. Relief valve shall operate on a pressure differential of 1/2 psi. Neoprene gaskets shall be installed under the insert lip to insure a leakproof seal.

PART 3 MANUFACTURE

3.01 MANUFACTURE OF FIBERGLASS MANHOLES

- A. Manhole cylinders, manway reducers, and connectors shall be manufactured from glass fiber-reinforced polyester or using a combination of chop and continuous filament wound process.
- B. Interior Access: All installed manholes shall be designed so that they support a ladder or step system. All ladder or step systems shall be installed in accordance with the manufacturer's recommendations.
- C. Manway Reducer: For 48" diameter manholes, manway reducers shall be concentric with respect to the larger portion of the manhole diameter. Larger manholes may have concentric or eccentric manway reducer openings.
- D. Cover and Ring Support: A typical ring and cover plate shall be supported without damage to the manhole. Normal installation shall include 6" to 18" of concrete grade rings between fiberglass manhole and cover plate ring.

3.02 EXTERIOR SURFACE

The exterior surface shall be relatively smooth with no sharp projections. Hand-work finish may be acceptable if enough resin is present to eliminate fiber show. The exterior surface shall be free of blisters larger than 0.5" in diameter, delamination or fiber show. For manholes intended to be anchored into concrete bases, there shall be an antiflotation anchor ring or rings provided around the bottom of the fiberglass wall.

3.03 PHYSICAL PROPERTIES

| | Hoop Direction | Axial Direction |
|-------------------------------|-----------------------|-----------------------|
| a. Tensile Strength (psi) | 18,000 | 5,000 |
| b. Tensile Modulus (psi) | 0.6 x 10 ⁶ | 0.7 x 10 ⁶ |
| c. Flexural Strength (psi) | 26,000 | 4,500 |
| d. Flexural Modulus (psi) | 1.4 x 10 ⁶ | 0.7 x 10 ⁶ |
| e. Compressive Strength (psi) | 18,000 | 12,000 |

3.04 TEST METHODS

All tests shall be performed as specified in A.S.T.M. D-3753 latest addition, Section 8. Test method D-790 and test method D-695.

3.05 QUALITY CONTROL

Each manhole shall be tested and meet all required ASTM D-3753 designations for dimensional requirements, hardness, and workmanship. Test records shall be forwarded to the County.

3.06 CERTIFICATION

As a basis of acceptance, the manufacturer shall provide an independent certification consisting of a copy of the manufacturer's test reports along with a copy of the test results certifying that representative manhole samples have been tested, and inspected in accordance with the provisions of this Specification and meet all requirements of same.

3.07 SHIPPING AND HANDLING

The Contractor shall not drop or impact the fiberglass manhole. An approved method of lifting the fiberglass manhole is by inserting a 4"x4"x30" timber into the top of manhole with cable attached or by a nylon sling or "choker" connection around center of manhole. Use of chains or cables in contact with the manhole surface is prohibited. The Contractor is advised that whatever method he chooses to install the manhole, it is his responsibility to handle and install it in a manner so as not to cause damage.

PART 4 CONCRETE

- A. **Fiberglass Bottom:** The Contractor may use concrete to form the bench area and invert. Concrete also may be used on the top of anti-flotation ring and around the reducer section as required to resist buoyancy.
- B. **Concrete Bottom:** The Contractor shall lower the manhole into the wet concrete until it reaches the proper elevation. A minimum of 6" of fiberglass manhole shall be inserted into the wet concrete below flow line prior to making the manhole plumb. The concrete shall extend a minimum of one foot from the outside wall of the manhole and a minimum of 6" above influent lines. Concrete shall form the bench and invert area and rise a minimum of 4" above influent lines. Concrete may be required by the County around the reducer section to resist buoyancy as well as other forces due to water and soil pressures. Concrete bases shall be at least 16" thick and properly reinforced to resist pull out of the fiberglass manhole.
- C. **Concrete Collar:** Design of the concrete collars required to distribute traffic wheel loadings shall be included in the design of manholes. The design shall be signed and sealed by a Florida licensed Professional Engineer. This design shall also include any requirements for the support of the manhole lid and frame.

PART 5 MANHOLE CONSTRUCTION

- A. **FIBERGLASS MANHOLE INSTALLATION:** The Contractor shall set fiberglass section vertical and in true alignment. All manholes shall meet the following installation tolerances:

The finished manhole shall not be out of plumb by more than 3/8" per 10 feet of height. For manholes exceeding 40'-0" high, the variation from plumb shall not exceed 1-1/2". Any jog or offset of wall surface each side of a joint shall not exceed 1/2". Variation in the joint width around the circumference of the manhole shall not exceed 3/8".
- B. **GRADE ADJUSTMENT:** The Contractor shall set precast concrete grade rings on top of manhole slabs and precast concrete manhole cones to provide grade adjustment in setting manhole frames.
- C. **BACKFILL:** Unless otherwise shown on the Drawings, sand, crushed stone, or pea gravel shall be used for backfill around the manhole for a minimum distance of one foot from the outside surface and extending from the bottom of the excavation to the top of the reducer section. Suitable material chosen from the excavation may be used for the remainder of the backfill. The material chosen shall be free of large lumps or clods, which will not readily break down under compaction. This material will be subject to approval by County.
- D. **BACKFILL PROCEDURE:** The Contractor shall place backfill in maximum layers of 12 inches loose measure and mechanically tamp to 95% Standard Proctor Density, unless otherwise approved by County. Flooding shall not be permitted. Backfill shall be placed in such a manner as to prevent any wedging action against the fiberglass manhole structure.

E. MARKING AND IDENTIFICATION: Each manhole shall be marked on the inside and outside with the following information:

1. Manufacturer's name or trademark.
2. Manufacturer's factory location.
3. Manufacturer's serial number.
4. Total length.

F. TESTING

1. After each manhole is constructed to grade and prior to being backfilling, each manhole shall be tested for water tightness.
 - a. Plug pipe lines and perform vacuum test. Observing all recommended safety measures, induce a backpressure of 5.0 psi equivalent to 10" Hg (mercury). The manhole assembly is considered satisfactory if the vacuum loss is less than 1" Hg for the length of time listed in the following table:

| Time of Test in Seconds | | | |
|-------------------------|--------------------------|-----|----|
| Depth Feet | Manhole Diameter in Feet | | |
| | 4 | 5 | 6 |
| 4 | 10 | 13 | 16 |
| 8 | 20 | 26 | 32 |
| 12 | 30 | 39 | 48 |
| 16 | 40 | 52 | 64 |
| 20 | 50 | 65 | 80 |
| 24 | 60 | 78 | 96 |
| T | 5 | 6.5 | 8 |

Note: Add "T" seconds for each additional 2'-0" of depth.

2. Failure to pass one of these tests requires the contractor to correct the problems and retest. The Contractor shall replace leaking gaskets and/or concrete sections and retest the completed manhole. No manhole will be accepted without successfully passing this test.

G. STUB LINES: The Contractor shall provide stub lines where shown on the Drawings or as directed by the County for the connection of future sewer lines to manholes. Provide bell end enclosed with an approved plug at the end of each stub line. Bell of stub line shall be as close to manhole exterior surface as practical. The Contractor shall accurately reference each stub line for direction and record along with the actual invert elevation. He shall furnish the County two copies of the above specified data on stub lines.

H. CONNECTION TO EXISTING MANHOLES: All piping entering existing manholes shall have resilient pipe to manhole seals per ASTM C-923.

END OF SECTION

SECTION 02626 SANITARY SEWER GRAVITY MAIN REHABILITATION

PART 1 GENERAL

1.01 DESCRIPTION

This section describes the materials and methods for the rehabilitation of sanitary sewer lines by the insertion of a fiberglass reinforced plastic or polyethylene liner pipe into the existing sewer line. All such work shall comply with these Specifications and the specific product manufacturer's recommendations. Any conflict between the product manufacturer's recommendations and any portion of the Contract Documents shall be resolved prior to beginning the work.

The Contractor shall utilize the products of one manufacturer which meet the requirements of these Specifications when relining sections of existing sewer which are straight or have minor offsets.

It shall be the Contractor's sole responsibility to insure that materials provided by the liner manufacturer will function as intended when installed in curved or offset sections of existing pipe.

1.02 DESIGN CRITERIA

Pipe, fittings and special pieces shall be designed to withstand all loadings as described below. No structural consideration is to be given to any part of the existing sewer pipe.

The following design criteria shall be utilized to develop a suitable structural and corrosion resistant design for the liner pipe for sliplining:

1. Hydrostatic Pressure - Water table shall be construed as 2' - 0" below finished grade on the entire length of the project.
2. Dead Loads - Invert of pipe and finish grade elevations are shown on the plan and profile drawings. Assume soil weight of 120 pounds per cubic foot and soil modulus of elasticity (E') of 2000 psi.
3. Live Loads - Highway loads are based on HS20-44 (A.A.S.H.T.O. Latest Edition). Railroad loadings are Cooper E 80 (A.R.E.A. Latest Edition).
4. Corrosion - Pipe carries domestic waste and shall be resistant to sulfuric acid attack resulting from hydrogen sulfide oxidation.
5. Buckling - Pipe design shall incorporate a safety factor of 2.5 for buckling strength calculations, in accordance with Section A2.5 of Appendix "A of AWWA C-950.

1.03 SUBMITTALS

After award of the Contract, (5) five copies of the pipe design and installation procedure shall be submitted by the Contractor. Contractor shall provide design in accordance with the operating load conditions described under Design Criteria. Complete pipe design shall include both structural and corrosion resistant design elements. Submittal shall address the Contractor's proposed method(s) to accomplish the following:

1. Install liner pipe through the existing pipe, including line deflections and curves and location of insertion pits.
2. Install grout in annular space between liner pipe and existing sewer pipe and details on proposed grout mix to be used.

3. Technical data on pipe including information on pipe materials, physical properties and dimensions.

Before beginning work, the Contractor shall submit for approval, the vendor's specific technical data with complete information on resin and material composition, physical properties of pipe, and pipe dimensions pertinent to this job. A certificate of "Compliance with Specification" shall also be furnished for all materials to be supplied.

PART 2 PRODUCTS

2.01 MATERIALS AND WORKMANSHIP

A. Workmanship:

1. All liner pipe delivered to the job site will be inspected prior to installation for the following:
 - a. Inside surfaces of each pipe section shall be free of bulges, dents, ridges, and other defects that result in a variation of inside diameter of more than 1/8 - inch.
 - b. The interior and exterior surfaces of the pipe shall be completely free from pinholes, cracks, pits, or defects which is detrimental to the intended use of product. No pipe will be installed which has apparent holes or openings which will permit the passage of liquid or gases through the pipe wall.
 - c. Joint sealing surfaces shall be completely free of dents, bumps or other surface irregularities which will affect the proper seals of the joints.
 - d. Factory repairs shall not be permitted.
 - e. On site repairs shall not be permitted. Segments of pipe having cuts or gouges in excess of 5% of the wall thickness shall be cut and removed.

The following materials are approved for installation as a liner pipe in the existing gravity sewer pipe:

B. Centrifugally Cast Fiberglass Pipe:

1. Fiberglass Materials: Polyester resin pipe conforming to AWWA C-950, Type 2, Grade 4, Liner D. The pipe shall also meet the stain corrosion resistant requirements of ASTM D-3681 and chemical requirements and joint tightness requirements of ASTM D-3262. Certified test data proving conformance with specifications shall be required from the pipe manufacturer.
2. Fiberglass Pipe:
 - a. General "Hobas"
Pipe stiffness of 36 psi shall be used. The pipe shall be lined with liner pipe as listed in the table of pipe liner sizes included herein.
 - b. General "Equivalent"
If equivalent pipe is used, it shall meet all the design and hydraulic conditions obtained by the "Hobas" pipe described above. All necessary calculations and literature shall be submitted to the County prior to approval.
 - 1) Pipe diameter shall be the largest diameter liner pipe available that can be installed into the existing ductile iron pipe. Actual pipe diameter utilized shall be approved by County prior to manufacturing and delivery.
 - 2) Pipe shall be field connected with bell and spigot meeting the performance requirements of ASTM D-3262. An o-ring or profile type

- elastomeric gasket meeting the requirements of ASTM F-477 shall be used to affect a positive leakproof sealing system at each joint.
- 3) The pipe produced shall have a minimum stiffness factor requirement of 36 psi at 5% deflection when tested in accordance with ASTM D-2412.

PIPE WALL THICKNESS AT 36 PSI PIPE STIFFNESS

| NOMINAL DIAMETER (inches) | OUTSIDE DIAMETER (inches) | WALL THICKNESS (inches) |
|---------------------------------|---------------------------------|-------------------------------|
| 18 | 19.5 | 0.37 |
| 20 | 21.6 | 0.40 |
| 24 | 25.8 | 0.47 |
| 30 | 32.0 | 0.58 |
| 36 | 38.3 | 0.69 |
| 42 | 44.5 | 0.80 |
| 48 | 50.8 | 0.90 |

- 4) Length: Pipe shall be furnished in maximum 20 foot lengths.
- 5) Pipes, fittings and special pieces shall be designed to withstand all jacking loads.
- 6) Pipe shall be provided with marks, where appropriate, to ensure complete installation of bell and spigot joints.

C. Filament Wound Fiberglass Pipe:

1. Fiberglass reinforced plastic pipe (FRP) shall be manufactured in accordance with AWWA C-950 and ASTM D-4184. Elastomeric gasket shall meet requirements of ASTM F-477. Pipe shall be equal to FRP as manufactured by Price Brothers Composite Pipe or another manufacturer approved prior to bid opening.
2. Pipe diameter shall be the largest diameter liner pipe available that can be installed into the existing pipe. Actual pipe diameter utilized shall be as shown in the Plans and Specifications.
3. Pipe shall have inverted bell and spigot joints meeting the performance requirements of ASTM D-3262.
4. Pipe shall be furnished in nominal 20 foot lengths.
5. Pipe, fittings and special pieces shall be designed to withstand normal jacking loads.
6. Differential longitudinal movement and rotation shall be considered in joint design. Joint seal shall be completely contained in a spigot groove.
7. Internal or external stiffening ribs or rings will not be allowed.

2.02 QUALIFICATION TESTING

- A. Pipe design shall be confirmed prior to fabrication by testing representative specimens of similar manufacture and physical properties. Pipe manufacturer shall perform the following tests, as set forth in AWWA C-950, on samples of pipe manufactured for this project or pipe manufacturer may provide test data on previously conducted tests and certify that such tests are representative of the product being furnished on this project:
1. Hydrostatic leakage test.
 2. Stiffness test.
 3. Hoop tensile strength test.

4. Axial tensile strength test or beam strength test.
5. Joint test of ASTM D-3262.

Certified test results demonstrating compliance shall be furnished to the County.

Pipe shall be field connected with an inverted bell and spigot joint or external sleeve coupling meeting the performance requirements of ASTM D-3262. An elastomeric gasket meeting the requirements of ASTM F-477 shall be used to affect a positive leakproof sealing system at each pipe joint.

B. Polyethylene Sewer Liner Pipe and Fittings:

1. Polyethylene Materials: Pipe and fittings shall be manufactured of a polyethylene resin Type III, Class C, Category 5, Grade P-34 (in accordance with ASTM D-1248) having an average specific base resin density of between 0.941 g/cc and 0.959 g/cc (in accordance with ASTM D-1505) and having an average melt index of between 0.4 g/10 minutes and 0.15 g/cc minutes maximum (in accordance with ASTM D-1238).

The polyethylene resin shall contain antioxidants and be stabilized against ultraviolet degradation to provide protection during processing and subsequent weather exposure.

The polyethylene resin compound shall have a resistance to environmental stress cracking as determined by the procedure detailed in ASTM D-1693, condition B, with sample preparation by procedure C of ASTM D-1928 for not less than 100 hours in 25% solution Iquepal CO-630 before reaching a 50% failure point F (50).

2. Polyethylene Pipe:
 - a. General "Driscopipe": SDR 26 pipe shall be used. The existing pipe shall be lined with liner pipe as listed in the table of pipe liner sizes included herein.
 - b. General "Equivalent": If equivalent pipe is used, it shall meet all the design and hydraulic conditions obtained by the "Driscopipe" described above. All necessary calculations and literature shall be submitted to the County prior to approval.

Sizes of the pipe linings to be used shall be such to restore the flow capacity to at least 95% of its original flow capacity using the maximum size lining that can be inserted into the existing lines. The original flow capacity shall be determined by use of the Manning formula for gravity flow using the diameter and gradients as determined from the Contract Plans, and using a roughness coefficient as shown in Table A. The sliplinings to be used shall be designed to withstand the long-term (50 Years) continuous external hydrostatic pressure, in feet of water head and in no case shall the Standard Dimension Ratio (SDR) exceed 26.0. The pipe manufacturer shall furnish written certification to the County that the proposed pipe and pipe sizes, pipe flows, and design strengths of the proposed materials meet or exceed the provisions in this section. This submittal shall accompany the bid proposal.

All pipe is to be manufactured from virgin materials. No rework compound except that obtained from the manufacturers own production of the same formula shall be used.

Pipe shall be homogeneous throughout, and be free of visible cracks, foreign

materials, blisters other deleterious faults.

TABLE A

| <u>Type of Pipe</u> | <u>Manning's N</u> |
|---------------------|--------------------|
| Vitrified Clay | .013 |
| Concrete | .015 |
| Ductile Iron (old) | .015 |
| Galvanized Iron | .016 |

- c. Submittal: After receipt of the bid, the successful bidder shall submit to the County for approval and evaluation a sample of the products to be used from the manufacturing source production facility that will meet or exceed the Contract Specifications along with the address of said manufacturer. Approval of the sample shall be required prior to any work on the Project.

All materials shall be supplied by the Contractor and shall be new and free from damage when delivered to the job site and prior to installation; and any defective materials discovered after installation will be removed and replaced at the Contractor's expense.

- d. Properties: The tensile strength, yield strength, elongation, and elastic modulus of the material shall be determined by ASTM D-638 along with the thermal butt fusion joints to assure the joints are stronger than the materials joined for Type III (or the type proposed with properties greater than those of Type III).
- e. Deviations: Any deviations from the above standards will be sufficient grounds to reject the proposal. Materials not meeting (or exceeding) the set standards will be sufficient basis for the rejection of the materials proposed.
- f. Testing: As previously stated, the above required test results shall be submitted according to the ASTM sections. If additional testing is requested, the County will bear the costs of the additional testing unless the materials fall below that which is specified according to the applicable ASTM standards. When the test results show results lower than required in these Specifications and/or in the applicable ASTM standards, the entire cost of testing shall be born by the Contractor.
- e. Delivery and Handling: The Contractor is responsible for making provisions to furnish labor, equipment, materials, and services necessary to order, receive, unload, store, and protect. After Award of Contract, and prior to beginning work, the Contractor shall submit to the County a schedule and location of delivery and storage. The pipe is to be trucked to the site in sections thirty eight feet (38 ft. +/- 2 inches) in length.

Upon delivery, the pipe shall be inspected by the Contractor. Any damaged pipe shall be set aside by the County or his agent who will determine if the pipe shall be accepted or rejected.

The Contractor shall make provisions for pipe storage as close to the job site as practical. The pipe shall be unloaded and placed for storage using suitable hoisting equipment and belt slings for field use.

PART 3 EXECUTION

3.01 CONSTRUCTION (ALL METHODS)

- A. General: Unless otherwise noted, the sliplining methods listed below are acceptable to the County. Should the Contractor desire to use different methods than described in these Specifications, written permission must be obtained from the County. The finished product is to be of highest quality and shall eliminate any infiltration or corrosion problems which may exist in the system.
- B. Installation Procedures:
1. No down time shall be permitted for the existing sewer line. By-passing as outlined in the following section is permitted. Alternate methods shall be submitted to the County for approval.
 2. By-Passing Existing Flows: The Contractor shall furnish equipment, materials, supplies, labor and all incidentals required to by-pass the sanitary sewer flow such that the sliplining process may be completed. The Contractor shall plug the upstream line and pump the flow to the nearest downstream manhole (or, when approved by the County, to another system all together) per Section 02720. Dumping the existing flow onto private property or streets shall not be allowed. At the end of each day, the Contractor shall make temporary tie-ins such that no service be interrupted overnight. By-passing of existing flows shall be considered an incidental part of this Contract and will not be paid for directly.
 3. Quality Assurance: The Contractor shall submit an experience statement for the design, manufacture, and installation of liner pipe for a similar application, of equal or larger diameter of the pipe included in this Project. As a minimum, the statement shall include length, size of pipe, application, type of joints and fittings installed, along with a list of clients and installation dates for these projects.

Prior to the installation of the liner pipe, the existing pipe shall be thoroughly cleaned and inspected by closed circuit television or visual inspection. The Contractor shall inspect the existing polylining in the ductile iron pipeline and ascertain where the lining is loose, hanging, etc. and may interfere with the sliplining process. Where found, the existing polylining shall be cut free, etc. so as to allow for the free passage of the sliplining pipe. Repair procedure shall be prior approved by the County.

The liner pipe shall be installed to the limits shown on the Drawings by pushing or pulling the liner pipe into the existing pipe with an approved pipe insertion system. It shall be the responsibility of the Contractor to clear the line of obstructions, solids, or dropped joints that prevent the insertion of the liner prior to beginning insertion process.

The pipe shall be guided into the existing pipe through an insertion pit constructed in accordance with these Specifications and the detail drawings. Once the insertion is initiated, the Contractor shall continue to push or pull to completion without interruption. During insertion, precautions should be taken to protect the liner pipe and prevent the rough or ragged edges or broken sewer pipe from scoring the outside of the liner as it is being pushed into the existing sewer pipe.

After insertion, the liner pipe should terminate at the inside face of each manhole or concrete structure and be sealed in accordance with these Specifications.

Also, prior to the sliplining process, a test head pull will be required to insure that proper clearance has been achieved. The Contractor shall use a steel nose cone

- (which is the same size and length as the liner pipe) for the test head pull. This item will be considered an incidental part of this Contract and will not be paid for directly.
4. Excavation: Excavations shall be completed in as small an area as is practical to complete the sliplining process. Excavation and backfill shall be in accordance with Section 02221 and FDOT. When excavating around existing utilities, the Contractor shall be responsible for protecting in place existing utilities. Prior to commencing any excavation operation, the Contractor shall contact the utility owner for the proper location of existing underground services in the areas of excavation. Asphalt and concrete shall be saw-cut to insure smooth joints.

Utility services encountered shall be excavated prior to the sliplining operation of the main pipeline to prevent blockage of the service and potential home damage. Service shall be maintained throughout the project life or until permanent tie-in can be made. At no time will excavations be left open overnight without the expressed written permission from the County. If the excavations are left open, it the Contractor's responsibility to properly barricade and otherwise safely maintain the excavated pit. Proper precautions shall be taken to protect the public, existing facilities, structures, and utilities. Traffic bearing areas, (streets, driveways, parking lots, shall be maintained until such time as they are permanently repaired.

All surface restoration materials, methods and work shall meet or exceed the quality and workmanship of the existing facilities prior to construction, and shall be in accordance with the Florida Department of Transportation and County Standards. Where dewatering is required for any segment of this project, it will be considered an incidental cost and will not be paid for directly. Access pit excavation shall paid for directly as indicated on the bid proposal.

5. Pipe Joining-Polyethylene Liner Pipe Method: Sections of polyethylene liner pipe shall be assembled and joined on the site above ground per Section 02620 in accordance with ASTM D-2657. If the County deems it necessary, the Contractor at his own expense will have a joint tensile test made in accordance with ASTM D-638.

Pipe Insertion: Immediately prior to insertion, the pipe shall be coated with a lubricant as recommended by the pipe manufacturer. Where installing of liner pipe is to be made through an access pit or manholes, the top of the existing main shall be exposed to the spring line of the main for the full length of the excavation shaft prior to removal of a section of the existing main. The insertion pipe with a pulling steel nosed cone head installed on each end shall also be lubricated and pulled into the existing pipe in such a manner as to prevent damage to the existing and new pipe. The heads shall be constructed such that sewage may flow though. The insertion pipe shall be accurately measured for proper length taking into account any thermal expansion or contractions. A power winch shall be connected to the end of the steel nosed cone pulling head so the line can be fed into the existing sewer pipe. Extreme care shall be taken so as not to damage, gouge, scratch or decrease the thickness of the liner pipe so as to not meet the SDR requirements or damage the joints of the liner pipe.

6. Grouting at Manhole Locations and Termination Points Polyethylene and Fiberglass Liners)

- A. Seal space between liner and manhole opening with mortar made with calcium aluminate cement by Lefarge Calcium Aluminates (Sewper Coat) or approved equal. The Contractor

shall apply the grout or employ an approved subcontractor for the application per Manufacturer's specifications.

- B. Filling Annular Space After the pipe liner has been inserted, the annular space between the pipe liner and the existing sewer pipe shall be filled with grout. The grout shall be worked into the annular space to provide an even, solid bedding for the pipe liner as directed and accepted by the County.
- C. Acceptable grout mixtures are tabulated per Table 1.

TABLE 1
ACCEPTABLE GROUT MIXTURES

| <u>Type and Description</u> <u>1 day</u> <u>3 day</u> <u>28 day</u> | <u>Water</u> | <u>Density</u> | <u>Yield</u> | <u>Consistency</u> |
|---|---------------|----------------|--------------|--------------------|
| | <u>gal/sk</u> | <u>lb/gal</u> | <u>ft/sk</u> | <u>Uc*</u> |
| Compressive Strength - psi 75 F | | | | |
| <u>Type I Cement - Neat</u> 1500 4000 6700 | 5.2 | 15.6 | 1.18 | 8 - 12 |
| <u>Narrow Annulus Expansive</u> 450 1400 500 50-50 Fly Ash Type I CMT + EXP + WRD | 4.4 | 15.0 | 1.10 | 2 - 4 |
| <u>Low Cost Grouts - Cement Only</u> Type I CMT + 2.5% Pregelled Bentonite 145 500 1200 | 12.7 | 12.3 | 2.20 | 5 - 10 |
| Type I CMT + Econolite-L (0.66 gal/sk) 720 1080 1500 | 11.3 | 12.7 | 2.08 | 5 - 10 |
| <u>Low Cost Grout with Fly Ash</u> 75-25 Fly Ash - Type I CMT 100 350 2300 | 4.0 | 14.9 | 1.02 | 8 - 12 |
| 87.5-12.5 Fly Ash-Type I CMT + Activators 20 230 2300 | 4.0 | 14.7 | 1.07 | 15 - 20 |
| <u>Low Cost High Sand Grout</u> Type 1 + 3.4 Parts Sand + 2.5% Pregelled Bentonite 300 750 1120 | 15.0 | 16.3 | 4.42 | 20 - 40 |
| <u>Normal Strength High Sand Grout</u> 33-67 Fly Ash - Type I CMT 3.5 Port Sand + WRD 1000 2000 4400 | 6.57 | 18.6 | 3.41 | 20 - 30 |

Expansive High Strength Grout

| | | | | | |
|------------|-----------------------|-----|------|------|---------|
| Type I CMT | 150% Sand + EXP + WRD | 5.0 | 18.5 | 2.03 | 10 - 20 |
| 5000 | 1500 10,500 | | | | |

*Uc = Units of Consistency. Equivalent to poses viscosity, but not directly related.

CMT = Cement, EXP = Expansive Admixture, WRD - Water reducing dispersant

PART 4 PRODUCTS

4.01 MATERIALS - POLYESTER FELT LINING (INSITUFORM)

The liner shall consist of polyester fiber felt tube, lined on one side with an impermeable coating and impregnated with a liquid thermo-setting resin. The materials shall be chemically resistant to withstand internal exposure to the corrosive effects of sewage liquids or gases, and solid in the surrounding ground and shall meet or exceed the following standard specifications.

| <u>Property</u> | <u>ASTM Test Method</u> | <u>Value</u> |
|-----------------------|-------------------------|--------------|
| Tensile Stress | D 638 | 3,000 psi |
| Flexural Stress | D 790 | 3,000 psi |
| Modulus of Elasticity | D 790 | 300,000 psi |

The Contractor shall also comply with all of the manufacturer's standards.

4.02 SIZING

The liner shall be fabricated to fit neatly into the circumference of the existing sewer pipe.

The length of the liner shall be that deemed necessary by the Contractor to effectively carry out the insertion and seal the liner at the inlet and outlet points. The Contractor shall verify the lengths in the field before cutting the liner to length. Individual inversion run can be made over one or more access points as determined in the field by the Contractor and approved by the County.

4.03 THICKNESS DESIGN OF INSITUFORM LINER

Refer to Table 02 for the design of the wall thickness required for insituform liner based on external pressure and three shape factor considerations. As long as the actual field conditions are within the parameters listed, this single table provides the thickness necessary. If the parameters are not met, the Contractor shall contact the County for an alternate thickness design. The thickness shall be sufficient to bear all live and dead loads encountered.

4.04 INSTALLATION OF LINE

The wet liner material shall be inserted through an existing manhole by means of an inversion process and the application of a hydrostatic head sufficient to fully extend the liner to the next designated access point. The impregnated liner materials shall be inserted into the inversion tubes with the impermeable plastic membrane side out. At the lower end of the inversion tube, the liner tube shall be turned inside out and attached to the inversion tube so that a leak proof seal is created.

The inversion head will be adjusted to be of sufficient height to invert the liner to the next access point designated and to hold the liner snug to pipe wall and to produce dimples at side connections and flared ends at the entrance and exit access points. If the use of a lubricant is recommended, such lubricant shall be as approved by INA manufacturer's standards. The INA manufacturer's standards shall be closely followed during the elevated curing temperature so as not to overstress the felt fiber and cause damage or failure of the liner prior to cure. (In certain cases, the Contractor may elect to use a Top Inversion. In this method the liner is pre- inverted to attaching to an elbow at the base of the inversion tube, the liner is attached to a top ring.)

4.05 LINER CURING

After inversion is completed, the Contractor shall supply a suitable heat source and water recirculation equipment. The equipment shall be capable of delivering hot water to the far end of the liner through a hose, which has been perforated per INA manufacturer's recommendations, to uniformly raise the water temperature in the entire liner above the temperature required to effect a cure of the resin. This temperature shall be determined by the resin/catalyst system employed.

The heat source shall be fitted with suitable monitors to gauge the temperature of the incoming and outgoing heat exchanger circulating water. Thermocouples shall be placed between the liner and invert at near and far access to determine the temperature of the liner and time of exotherm. Water temperature in the line during the cure period shall not be less than 150° or more than 200° F as measured at the heat exchanger return line.

4.06 COOL-DOWN

The Contractor shall cool the hardened liner to a temperature below 100° F before relieving the static head in the inversion tube. Cool-down may be accomplished by the introduction of cool water into the inversion tube to replace water being drained from a small hole made in the end of the liner at the at the downstream end. Care shall be taken in the release of the static head such that a vacuum will not be developed that could damage the newly installed liner.

4.07 FINISH

The finished lining shall be continuous over the entire length of an insertion run and be as free as commercially practicable from visual defects such as foreign inclusions, dry spots, pinholes, and delamination. The lining shall be impervious and free of any leakage from the pipe to the surrounding ground to the inside of the lined pipe.

Any defects which will affect, in the foreseeable future the integrity or strength of the linings, shall be repaired at Contractor's expense, in a manner mutually agreed by the County.

**TABLE 02
SPECIFIED INSITUFORM THICKNESS REQUIRED BASED ON
EXTERNAL PRESSURE AND THREE SHAPE FACTOR CONSIDERATIONS**

| Exist. Thickness | Design Thickness in Inches for 0' to 8.0' Depth | Design Thickness in Inches for 8.1' to 12' Depth | Design Thickness in Inches for 12.1' to 16' Depth | Design Thickness in Inches for 16.1' to 20' Depth | Design Thickness in Inches for 20' to 24' Depth | Design Thickness in Inches for 24.1'to 28' Depth |
|------------------|---|--|---|---|---|--|
| Pipe I.D. | | | | | | |
| 6" | 0.10 | 0.11 | 0.12 | 0.13 | 0.14 | 0.14 |
| 8" | 0.13 | 0.15 | 0.16 | 0.17 | 0.18 | 0.19 |
| 10" | 0.16 | 0.18 | 0.20 | 0.22 | 0.24 | 0.24 |
| 12" | 0.19 | 0.22 | 0.24 | 0.26 | 0.28 | 0.29 |

| | | | | | | |
|-----|------|------|------|------|------|------|
| 15" | 0.24 | 0.27 | 0.30 | 0.32 | 0.34 | 0.36 |
| 18" | 0.29 | 0.33 | 0.36 | 0.39 | 0.41 | 0.43 |
| 21" | 0.34 | 0.38 | 0.42 | 0.45 | 0.48 | 0.51 |
| 24" | 0.38 | 0.44 | 0.48 | 0.52 | 0.55 | 0.58 |
| 27" | 0.43 | 0.49 | 0.54 | 0.58 | 0.62 | 0.65 |
| 30" | 0.48 | 0.55 | 0.60 | 0.65 | 0.69 | 0.72 |
| 36" | 0.58 | 0.66 | 0.72 | 0.78 | 0.83 | 0.87 |
| 42" | 0.67 | 0.77 | 0.84 | 0.91 | 0.96 | 1.01 |
| 48" | 0.77 | 0.88 | 0.96 | 1.04 | 1.10 | 1.16 |
| 54" | 0.86 | 0.99 | 1.08 | 1.17 | 1.24 | 1.30 |
| 60" | 0.96 | 1.10 | 1.21 | 1.30 | 1.38 | 1.45 |

Table 2 is based on an open channel Insituform subjected to an external static water head equal to the total flowline depth and shape factors of worse condition than an ovality of 2%, a flat in the circumference no greater in width than 20% of the diameter, and no missing segment of pipe greater than angle of 60E on the circumference. The design is based on Insituform with a flexural modulus E of 250,000 psi and long-term behavior being taken into account by using a lower value to allow for creep. NOTE: The table recommends an Insituform thickness based upon the fiberfelt tubes currently manufactured. The thickness of Insituform after curing is dependent upon the condition of the pipe and the resin used. Fractured pipe and open joints draw off resin and can yield a lesser finished thickness.

NOTE: THIS TABLE IS FOR PIPE LINES THAT ARE NOT FULLY DETERIORATED WHERE THE DESIGN THICKNESS WAS CALCULATED WITH THE GROUNDWATER SURFACE EQUAL TO THE EXISTING GRADE.

4.08 SEALING LINER AT THE ENDS

If due to broken or misaligned pipe at the access point, the joint fails to make a tight seal, the Contractor shall apply a seal at the point. The seal shall be of a resin mixture compatible with the liner.

4.09 TV TAPES OF SEWERS

The Contractor will be required to provide, before and after, TV records of the pipe interior.

4.10 CLEANING AND OBSTACLE REMOVAL

- A. Cleaning: The Contractor shall be required to clean the existing lines to remove all sand and rubble that may inhibit insituform operation. The Contractor will not be allowed to proceed with the insituform operation until the County is satisfied that the cleaning operation has been done satisfactorily and test head pulling will not be required.
- B. Obstacle Removal: Should the removal of an obstruction require excavating to expose the pipe to permit opening of the pipe, obstacle removal and pipe repair, all applicable requirements of all articles to these Specifications shall be adhered to by the Contractor and County. Excavation for each obstacle shall be limited to the distance of twenty-five (25) linear feet along the existing sewer (i.e. fifty (50) feet, two (2) obstacles, etc.).
- C. Service Connections (If Applicable): After Insituform has been secured in place, the installer shall reconnect the existing active service connections as directed by the County. This shall generally be done without excavation, and in the case of non-man entry pipes, from the interior of the pipeline by means of a television camera and a cutting device that re-establishes them to not less than 85 percent capacity.

END OF SECTION

SECTION 02627 SANITARY SEWER MANHOLE REHABILITATION

PART 1 GENERAL

1.01 DESCRIPTION

- A. This specification consists of all work, materials, labor and equipment required for manhole rehabilitation for the purpose of eliminating infiltration and exfiltration, providing corrosion protection, adjusting final grade of manhole top, repair of voids and restoration of the structural integrity of the manhole. All such work shall comply with these Specifications and the specific product manufacturer's recommendations. Any conflict between the product manufacturer's recommendations and any portion of the Contract Documents shall be resolved prior to beginning the work.

1.02 PRODUCT AND MANUFACTURER QUALIFICATION REQUIREMENTS

- A. Since sewer products are intended to have a 50 year design life, and in order to minimize the County's risk, only proven products with substantial successful long term track records will be allowed. At a minimum, products and installers must meet all of the following criteria to be deemed commercially acceptable:
1. For a Product to be considered commercially acceptable, the product must have a minimum of two (2) million square feet and ten (10) year history of successful wastewater collection system installations in the United States. In addition, products must provide Third Party Test Results supporting the long-term performance and structural strength of the product and such data shall be satisfactory to the Owner. No product will be allowed without Independent Third Party Testing verification.
 2. For an installing Contractor to be considered commercially acceptable, the installer must have a certification from the manufacturer as a licensed and fully trained installer of the product. The installer must also have a minimum of one (1) million square feet of successful wastewater collection system installations on underground concrete/masonry structures and ten (10) years of rehabilitation experience.

1.03 SUBMITTALS:

- A. Product
1. Technical data sheets showing the physical and chemical properties.
 2. Material Safety Data Sheets (MSDS).
 3. Third Party Testing results.
 4. Verification of minimum installation requirements set forth in section 1.02.A.1 above.
- B. Installer
1. Verification of "certified applicator" status.
 2. Verification of minimum installation requirements set forth in section 1.02.A.2 above.
- C. Written certification from the product manufacturer that each of the proposed rehabilitation products is compatible with each other.
- D. Submit with Each Project:
1. Description, layout, and application sequencing plan.

2. Rehabilitation system application requirements including material handling and storage requirements, mixing and proportioning requirements (as applicable), maximum pot life, film/coating thickness, curing, testing and certification requirements of all rehabilitation materials. Product Material Safety Data Sheets.
3. Detailed instructions and methodology for finishing all pipe and manhole connections to rehabilitated manholes to prevent infiltration and exfiltration.
4. Wastewater Flow Control/Bypassing Plan.
5. Confined Space Entry Plan/Permit.
6. Plan for capturing extraneous debris during rehabilitation processes and debris disposal.

1.04 MATERIALS

- A. Refer to the latest Manatee County Public Works Utility Standards Section 12 Precast Concrete Manholes and Wetwells for material requirements and details.

1.04.1 CEMENTITIOUS MORTAR

- A. Mortar shall be made of one part Portland cement and two parts clean sharp sand. Cement shall be Type 1 and shall conform to ASTM C 150. Sand shall meet the requirements of ASTM C 144.

1.04.2 PATCHING MATERIAL

- A. A quick setting fiber reinforced cementitious material shall be used as a patching material and is to be mixed and applied according to manufacturer's recommendations.

1.04.3 HYDRAULIC CEMENT

- A. A rapid setting, high-early-strength, cementitious product specifically formulated for leak control shall be used to stop water infiltration. The material shall be mixed and applied according to the manufacturer's recommendations.

1.04.4 CHEMICAL GROUT

- A. A chemical grout shall be used for stopping very active infiltration and filling voids.

1.04.5 LINER MATERIAL

A. CEMENTITIOUS MATERIAL

1. Cementitious liner products shall be used to form a structural monolithic liner covering all interior manhole surfaces and shall have the following minimum requirements:
 - a. Compressive Strength (ASTM C109): 7,000 psi, 28days
 - b. Tensile Strength (ASTM C496): 700 psi, 28 days
 - c. Flexural Strength (ASTM C293): 1,300 psi, 28 days
 - d. Shrinkage (ASTM C596): 0.02% at 28 days
 - e. Minimum Bond (ASTM C952): 200 psi, 28 days
2. Refer to Section 09920 Sewpercoat Surface System of the specifications.

When used as the final rehabilitation liner material (no epoxy liner), product shall be made with calcium aluminate cement. Calcium aluminate is not required when the

cementitious liner is used as the underlayment for a protective coating liner application.

B. PROTECTIVE COATING LINER MATERIAL

1. The protective coating liner is to be applied where corrosion is anticipated. The protective coating liner material shall be applied over the completed cementitious liner material (without the calcium aluminate). The liner shall be spray applied or spin cast. The manufacturer of the selected protective coating liner material shall approve in writing that their protective coating liner is compatible with cementitious repair and liner material.
2. The protective coating liner material shall conform to Section 09970 Surface Protection Spray Systems of the specifications.

C. WATER

1. Water shall be clean and potable.

1.04.6 INTERNAL MANHOLE CHIMNEY SEAL MATERIAL

A. An aromatic urethane rubber material or flexible epoxy mastic used to prevent leakage of water into the manhole through the frame joint area and the area above the manhole cone and shall have the following minimum requirements:

1. Elongation (ASTM D412): 600%
2. Tensile Strength (ASTM D412): 1,150 psi
3. Adhesive Strength (ASTM D903): 175 lb. /in.
4. Tear Resistance (ASTM D1004): 155 lb. /in.

The seal shall extend from the inside of the manhole frame down to the cone or corbel of the manhole.

1.04.7 EXTERNAL MANHOLE SEAL WRAP

A. External Manhole Seal Wrap: When work consists of adjusting manholes or cone replacements, an external seal wrap shall be installed to the outside of concrete risers, steel risers and joints of the precast manhole in order to eliminate infiltration. The external seal wrap shall conform with Manatee County Public Works Department Utility Standards Section 12 and be installed in accordance with the details of the Contract Documents and the manufacturer's recommendations.

1.05 PREPARATION

- A. Perform traffic control in accordance with the approved traffic control submittal.
- B. Store materials in accordance with manufacturer's recommendations.
- C. Schedule and perform the work in a manner that does not cause or contribute to overflows or spills of sewage from the sewer system.
- D. Install devices to prevent extraneous material from entering the sewer system and to prevent upstream line from flooding the manhole. If extraneous material or debris falls into a "live" manhole during adjustment operations, the Contractor shall remove debris at no cost to the Owner.

- E. Dispose of wastes in accordance with applicable regulations.
- F. Schedule and perform any bypass pumping that will be necessary to properly rehabilitate the manhole.
- G. If present in the manhole, Contractor shall remove all access steps. Removal shall consist of neatly cutting steps flush with the wall prior to any lining installation. Contractor shall be responsible for proper disposal of steps.
- H. For manholes that are located within pavement areas and require resetting or replacement of concrete riser rings, cones, and /or frames, the Contractor shall sawcut, remove, and replace a 6 ft. x 6 ft. square or round section of pavement and base for rehabilitation operations. Costs for removal and replacement of pavement and base beyond these limits shall be borne by the Contractor.

1.06 INSTALLATION

- A. Prior to any lining all other miscellaneous work must be complete.
- B. Prior to man entry into any structure to be rehabilitated, proper ventilation and strict confined space OSHA regulations shall be followed. Failure to do so shall be grounds for removal from the project.

1.06.1 CONE REPLACEMENT

- A. The Contractor shall replace existing deteriorated manhole cone section with new precast concrete cone section. A preformed rubber gasket shall be placed in all keyways between existing manhole riser section and cone joints. Prior to backfilling, rubber external seal wraps shall be applied to the cone and manhole section joint, riser rings and frame in accordance with Manatee County Public Works Department Utility Standards. If the existing manhole is of brick construction, the cone shall be set in a full bed of mortar on the top course of bricks.

1.06.2 RISER RINGS

- A. The Contractor shall replace existing, deteriorated riser rings with new precast concrete riser rings. All manholes designated to receive casting adjustment and/or alignment shall be adjusted to meet existing finished grade unless an alternative elevation is specified. A cementitious mortar shall be placed in between individual precast concrete riser rings, and precast concrete riser ring and cone joints. The mortar shall be struck smooth with the interior surface of the manhole and floated with a sponge float to a surface profile of 8-10 mils. Prior to backfilling, rubber external seal wraps shall be applied to the cone and manhole section joint, riser rings and frame in accordance with Manatee County Public Works Department Utility Standards.

1.06.3 MANHOLE FRAME AND COVER

- A. Existing frames and covers which must be removed to facilitate manhole rehabilitation, riser reconstruction, and/or casting alignment or grade adjustments shall be salvaged, cleaned and given two coats of an approved bituminous coating by the Contractor for replacement unless determined to be defective by County. If manhole frame and/or cover are determined to be defective, Contractor shall replace with new frame and/or cover. Replacement frames and/or covers shall be furnished and installed in accordance with the Contract Documents.

Frames shall be set in full mortar bed. The mortar shall be struck smooth with the interior surface of the manhole and floated with a sponge float to a surface profile of 8-10 mils.

1.06.3.A MANHOLE FRAME AND COVER ADJUSTMENT RINGS

- A. Existing manhole covers, which must be adjusted to existing or new pavement surfaces, shall be adjusted by modifying the existing precast concrete adjustment rings to bring the entire existing ring and cover to grade.
- B. No manhole cover adjustment rings shall be allowed.

1.06.4 CEMENTITIOUS LINER

- A. Active leaks shall be stopped using hydraulic cement or chemical grout as necessary. Installation shall be in accordance with the manufacturer's recommendations.
- B. All manholes to be lined shall be cleaned and scarified with a minimum of 5,000 psi water jet at a minimum water temperature of 180 degrees F. The water jet shall hit the manhole wall surface at as near perpendicular angle as possible. Cleaning the manhole walls from the ground surface without the appropriate angled nozzles will not be accepted. Manhole surface build-up of debris and loose manhole construction materials shall be removed during the cleaning process.
- C. The intent of the surface preparation and cleaning work is to remove debris, films (oil, greases, etc or unsound, deteriorated concrete and to provide a structurally sound, clean surface that will enable lining materials to bond to the original substrate at adhesion strengths of that specified herein, a substrate pH of 8.3 is the minimum pH that will be considered acceptable to demonstrate that the surface preparation and cleaning have been properly performed.
- D. Additional aggressive surface preparation and cleaning methods may be necessary to remove carbonated cementitious lining concrete or contaminants that remain after the cleaning performed as described above. The Contractor shall test the pH of the cleaned manhole interior surface at various locations of the manhole and when the results indicate a pH less than 8.3 then additional surface preparations and cleaning will be required. As a minimum level of effort the Contractor shall either dry sand blasting or pneumatic jackhammering with a bushing bit followed by a minimum 5,000 psi water blast.
- E. Any bench, invert or service line repairs shall be made at this time using quick setting grout or repair mortar per the manufacturer's recommendations.
- F. Invert repair shall be performed on all inverts with visible damage or where infiltration is present. After blocking flow through the manhole and thoroughly cleaning the invert, quick setting patch material shall be applied to the invert in an expeditious manner. The finished invert surfaces shall have a smooth surface and form a continuous monolithic conduit with the sewer pipe entering and leaving the manhole. The bench and invert shall form a watertight seal with the manhole walls, base and pipe seal.
- G. Wastewater flow shall be controlled by methods which prevent contact with the new bench and invert for 6-8 hours after mortar placement. If 6-8 hours set time is not possible, a fast setting, high early strength mortar shall be used with provisions for flow control until concrete has set.

- H. Fill all cracks, holes and joints that have voids using non-shrink grouts in accordance with the manufacturer's recommendations.
- I. Apply Cementitious Liner Material per the Manufacturer's recommendations. Apply Cementitious Liner material so that the final thickness is 0.5-inch minimum or per the thickness required by the manufacturer's minimum specification, whichever is greater. The material shall start at the bottom of the manhole frame and extend to the water level of the invert.
- J. Finishing: Trowel the surface of the liner to create a uniform smooth finish. Caution shall be taken to prevent over working the material. Once the initial cure has taken place, the exposed surface area should be given a broom finish. Thickness may be verified at any point with a wet gage.
- K. If the cementitious lining material is not immediately coated with a protective coating liner, apply a seal coat compatible with the repair material to aid in curing and minimize recontamination of the substrate prior to application of the protective coating liner material.

1.06.5 PROTECTIVE COATING LINER

- A. Prior to any protective coating lining perform all work shown in Section 1.06.4 above.
- B. Remove any curing compounds, sealers or contaminates prior to protective coating lining.
- C. Apply protective coating lining material in accordance with the manufacturer's recommendations over the waterproofing/structural repair material shown in Section 1.06.4.
- D. Apply protective coating lining material to all internal surface area of the structure.
- E. Apply protective coating lining material in accordance to Section 09970 Surface Protection Spray System of the specifications.

1.06.6 INTERNAL MANHOLE CHINMEY SEALANT

- A. Perform all work shown in Sections 1.06.4 and 1.06.5 (if 1.06.5 is required) prior to any Internal Manhole Chimney Sealant.
- B. Clean all contaminates from manhole frame by sandblasting or mechanical methods as recommended by the chimney sealant manufacturer.
- C. Install Internal Manhole Chimney Sealant in accordance with the manufacturer's recommendations. The Contractor shall contact the manufacture for thickness recommendations however; the final liner material shall be made no less than 170 mils.

1.06.7 EXTERNAL MANHOLE SEAL WRAP

- A. When Work consists of adjusting sewer manholes or cone replacement, an external seal wrap shall be installed to the outside of concrete risers, steel risers and joints of the precast manhole in order to eliminate infiltration. Frame and cover shall be completely coated prior to installation of the external seal wrap. The external seal wrap shall be installed in accordance with the details of the Contract Documents and the manufacturer's recommendations.

1.06.8 MANHOLE INSERT

- A. If existing manhole is not equipped with a watertight manhole insert, Contractor shall furnish and install a new manhole insert per Manatee County Public Works Utility Standards Section 12 and in accordance with the manufacturer's recommendations.
- B. If existing manhole is equipped with a watertight manhole insert to prevent intrusion of storm water, the insert shall be cleaned and reinstalled by the Contractor, unless determined to be defective by the County. If insert is determined to be defective, Contractor shall furnish a new watertight manhole insert and install in accordance with manufacturer's recommendations at the completion of manhole rehabilitation operations.

1.07 TESTING

- A. After completion of any rehabilitation operation and prior to backfilling (if required), the Contractor shall conduct the following tests on the manholes:
 - 1. Visual Inspection: The County and Contractor shall make a final visual inspection. Any deficiencies in the finished system shall be marked and repaired.
- B. If a protective coating liner is applied, the following additional tests will be required:
 - 1. Wet Film Thickness Gage: During application a wet film thickness gage, meeting ASTM D4414 - Standard Practice for Measurement of Wet Film Thickness of Organic Coatings by Notched Gages, shall be used to ensure a monolithic coating and uniform thickness during application.

1.08 WARRANTY

- A. The Contractor shall guaranteed the work to be free of defects in materials and workmanship for five-year period, unless otherwise stated, after completion and acceptance of the work. The Contractor shall repair defects in materials or workmanship, which may develop during the warranty period; and any damage to other work caused by such defects or discovered within the same period at no additional cost to the County.

1.08.1 WARRANTY INSPECTIONS

- A. Conduct visual inspection prior to expiration of warranty to determine integrity of rehabilitation materials and water-tightness.
 - 1. Complete post inspection during first high groundwater period (spring or fall) following acceptance of work.
 - 2. Contractor should accompany County on inspections.
 - 3. Inspect a minimum of 25 percent of the manholes rehabilitated at locations selected by County.
 - a. Infiltration and Inflow: None
 - b. Structural Repair: Sound
 - c. If more than one manhole fails warranty inspection, inspect all manholes with similar characteristics.
 - d. Repair defects in accordance with Warranty.

END OF SECTION

SECTION 02628 SANITARY SEWER MANHOLE AND WET WELL FIBERGLASS LINERS

PART 1 GENERAL

1.01 SCOPE OF WORK

The Contractor shall furnish all labor, equipment and materials required to install fiberglass liners with the largest diameter to fit inside the structure and leave a 2" to 3" annular space for grouting purposes.

1.02 SUBMITTALS

The Contractor shall submit to the County manufacturer's data and detailed shop drawings in conformance with the Contract Documents.

1.03 GENERAL REQUIREMENTS

The Contractor shall complete work on individual manholes and wet wells without interruption to the sewage collection system. A sewage bypass system shall be used, as required and approved by the County per Section 02720.

1.04 SAFETY REQUIREMENTS

- A. The Contractor shall provide adequate traffic control and take all necessary precautions for the protection of the work and the safety of the public. This includes, but is not limited to, barricades which shall flash from sunset to sunrise, barricades of substantial construction and night visibility and suitable warning signs, placed and illuminated at night as to show in advance where construction, barricades or detours exists. Traffic control warning signs and barricades which shall be in strict accordance with the provisions of the Florida Dept. of Transportation Manual of Traffic Controls and Safety Practices for Street and Highway Construction, Maintenance and Utility Operations, latest revision.
- B. Access to fire hydrants adjacent to the work area shall be provided for fire-fighting equipment at all times.

PART 2 PRODUCTS

2.01 MASONRY

- A. Brick: ASTM C32-91 or latest revision, Specification for Sewer and Manhole Brick (made from clay or shale). Sound, hard and uniformly burned, regular and uniform in shape and size, of compact texture. Grade MA.
- B. Cement: ASTM C150-92 or most recent revisions, specification for portland cement, Type II.
- C. Sand: Washed silica sand, ASTM C144, latest revision. specification for aggregate for masonry mortar.
- D. Concrete shall be 4000 PSI chat mix.
- E. Sprayed on surface protection system shall be in accordance with Section 09970

2.02 FIBERGLASS LINERS

- A. Fiberglass Reinforced Plastic (FRP) liners shall be one-piece construction FRP plain end cylinder pipe with an integral corbel design if required. Liner diameter shall fit into the existing structure. The Contractor shall measure the existing structure prior to construction and is responsible for the liner fit. The Contractor shall submit factory certification for fiberglass liners. The reducer cone, if required, shall have a modified hemispherical shape with at least a 3-inch high FRP reinforcement collar and a 4-inch minimum width flat surface to support adjustment rings for a cast-iron ring and cover. The cylinder pipe-to-reducer cone joint shall be factory-installed. No vertical seams or joints shall be allowed.
- B. FRP liners shall be fabricated with premium grade isophthalic polyester resin, fiberglass chopped strand, woven roving and continuous reinforcements. Sand filler shall not be permitted in the FRP laminate.
- C. FRP liners shall be designed and fabricated in accordance with ASTM D3753, FRP laminate shall conform to ASTM C582 and Chemical Resistance Tests shall conform to ASTM C581. FRP liners shall be chemically resistant to normal domestic sanitary sewer environments as well as corrosive soil, groundwater and sea water environments. Manhole liners shall be designed to withstand a 16,000 pound vertical dynamic wheel load (AASHTO H-20 loading).
- D. FRP liners shall be manufactured by an established national manufacturer with at least five years experience producing FRP sanitary sewer manhole liners.
- E. All liners delivered to the job site shall be inspected for the following prior to installation:
 - 1. Inside surfaces of each section shall be free of bles, dents, ridges, and other defects that result in a variation of inside diameter of more than 1/8-inch.
 - 2. The interior and exterior surfaces of the liner shall be completely free from pinholes, cracks, pits, or defects which is detrimental to the intended use of product. No liner will be installed which has apparent holes or openings which will permit the passage of liquid or gases through the liner well.
 - 3. Factory repairs shall not be permitted.
 - 4. On site repairs shall not be permitted.
 - 5. The FRP liner shall have a warranty against defects in material and workmanship for a period of one year.

2.03 MANHOLE INSERTS

The manhole inserts shall be as manufactured by FRW Industries, Conroe, Texas or equal. Inserts shall be complete with a self-cleaning relief valve. Relief valve shall operate on a pressure differential of 1/2 psi.

PART 3 EXECUTION

3.01 MANHOLE PREPARATION

- A. All concrete manholes shall be tested with a rebound or impact hammer. Testing procedures shall be those recommended by hammer manufacturer. The test area shall be between 2 and 3 feet above the benches or any area showing visible deterioration. Any concrete manhole testing below 2800 psi will be omitted from the rehabilitation specified within this bid. The Contractor shall submit five copies of test results to the County. The

County shall have the right to verify any or all of the test results.

- B. The Contractor shall excavate an area around the top of the existing manhole sufficiently wide and deep for removal of soil, castings, ring and cover, and reducer corbel section.
- C. The Contractor shall remove the frame and cover, manhole insert and corbel cone section without damaging the existing manhole walls. Care is to be taken not to allow brick or soil to fall into the existing manhole. The Contractor shall remove or reinsert loose brick which protrude more than one inch from the interior wall of the manhole and which could interfere with the insertion of the fiberglass liner. If the shelf of the manhole invert is not level around the perimeter, form a flat shelf with mortar.
- D. The Contractor shall salvage manhole, frame and cover. Manhole inserts shall be salvaged if in working order. Corbel cone section shall be removed from site.
- E. The Contractor shall thoroughly clean manhole by high pressure water jet, 1500 psi high pressure steam acid wash, or wire brushing, then neutralize with a sodium carbonate solution. He shall remove all loose concrete, mortar, scale, brick or other deteriorated concrete or masonry prior to repair and shall prevent all scale, grit, sludge or other debris from entering the sewer system and remove and properly dispose of off the job site.
- F. The Contractor shall seal all leaks in manholes so that all infiltration is stopped. Sealing shall be accomplished by drilling from the inside of the manhole and injecting acrylamide grout to the exterior side of the manhole.

3.02 WET WELL PREPARATION

- A. Remove top slab / cover, all internal pipes, lines & fittings. Remove base grout as required.
- B. The Contractor shall thoroughly clean wet well by high pressure water jet, 1500 psi high pressure steam acid wash, or wire brushing, then neutralize with a sodium carbonate solution. He shall remove all loose concrete, mortar, scale, old liner material or other deteriorated concrete or masonry prior to repair and properly dispose of off the job site.
- C. The Contractor shall seal all leaks in so that all infiltration is stopped. Sealing shall be accomplished by drilling from the inside of the wet well and injecting acrylamide grout to the exterior side of the wet well.

3.03 FIBERGLASS LINER INSTALLATION

- A. The bottom of the liner shall be cut by the Contractor to fit the existing base as closely as possible. Cut outs in the liner shall be made to accommodate existing inlets, drops and cleanouts. Cuts shall be precisely made with a power saw specialty blade or jigsaw.
- B. The Contractor shall lower the liner into the existing structure and set it into a quick-setting grout mixture. Adequate bottom seal shall be obtained to prevent the loss of grout from the annular space. Six inches of quick-setting grout shall be placed above the bottom seal in the annular void area to insure a proper bottom seal. The Contractor shall use C-900 PVC or other County-approved corrosion-resistant pipe sleeves. Quick-setting mortar shall be used to seal around all drops, cleanouts, laterals and existing pipe.
- C. The interior of the fiberglass liner shall be braced to prevent cracking. The annular space shall be filled with a portland cement concrete.

- D. Where the corbel/cone section is removed, a new casting shall be formed to a diameter equal to the outside diameter of the existing manhole and to the height of the flat surface of the manhole liner. This area shall be filled with Portland cement concrete and may be poured at the same time as the annular space.
- E. The Contractor shall notify the Project Manager and Inspector at least 48 hours in advance, giving the start time and estimated completion time, of the liner installation.

3.04 MANHOLE GRADE ADJUSTMENT

- A. The Contractor shall set precast concrete grade rings on top of manhole to provide grade adjustment in setting manhole frames.
- B. Setting Manhole Frames:
 - 1. The existing ring and cover shall be reused and finished to grade by construction of a chimney on the flat shoulder of the manhole liner using brick and mortar precast concrete rings. The concrete rings shall be placed directly on the manhole liner.
 - 2. The Contractor shall set manhole frames and covers to match the finished grade as shown on the Contract Drawings or as directed by the County. He shall set frames on concentric manholes with the opening mortar so that the space between the top of the manhole to the bottom of the frame shall be completely filled and made watertight. He shall place a ring or mortar around the outside of the bottom flange at least one inch thick and pitched away from the frame. He shall extend the mortar to the outer edge of the masonry, finish smooth and flush with the top of the flange.
- C. Invert Reconstruction: The Contractor shall reconstruct inverts with Type II cement to provide a smooth flowing channel of similar shape and size of the sewer and connections. All inverts shall follow grades of pipes entering manholes. He shall provide a true curve of the largest radius possible for changes in direction of sewer and entering branch or branches.
- D. Miscellaneous Work
 - 1. The Contractor shall observe watertightness and repair any visible leakage.
 - 2. The Contractor shall backfill around the new casting and compact the backfill.
- E. Manhole Inserts: Watertight manhole inserts shall be installed in all rehabilitated sanitary sewer manholes. Neoprene gasket shall be installed under the lip of the insert. If the rehabilitated manhole was not equipped with a manhole insert or if the salvaged manhole insert is not in working order, the Contractor shall provide a new manhole insert.

END OF SECTION

SECTION 02640 VALVES AND APPURTENANCES

PART 1 GENERAL

1.01 SCOPE OF WORK

- A. The Contractor shall furnish all labor, materials, equipment and incidentals required and install complete and ready for operation all valves and appurtenances as shown on the Drawings and as specified herein.
- B. All of the types of valves and appurtenances shall be products of well established reputable firms who are fully experienced and qualified in the manufacture of the particular equipment to be furnished. The equipment shall be designed, constructed and installed in accordance with the best practices and methods and shall comply with these standards as applicable. Valves used in waterworks applications shall comply with Section 8 of NSF Standard 61 for mechanical devices.
- C. All of the equipment and materials specified herein are intended to be standard for use in controlling the flow of potable water, reclaimed water, wastewater, etc., depending on the applications.
- D. All valves and appurtenances shall be of the size shown on the drawings and, to the extent possible, all equipment of the same type on the project shall be from a single manufacturer.
- E. All valves and appurtenances shall have the name of the manufacturer, year of the valve and the working pressure for which they are designed cast in raised letters upon some visible part of the body.
- F. Special tools, if required for the normal operation or maintenance, shall be supplied with the equipment.
- G. All hand actuated buried valves shall have three-piece adjustable valve boxes and 2-inch square AWWA operating nuts. Provide stainless steel extension stems and alignment rings where needed to bring the operating nut to within 4 feet below the box lid.
- H. Water and reclaimed water system isolation valves shall be gate valves for sizes 2-inch through 12-inch and shall be butterfly valves for sizes 16-inch and larger.
- I. Isolation valves for sewer force main pipelines shall be gate valves, unless otherwise noted on the plans. Tapping valves shall be used for tapping force mains. Plug valves shall be full port, have a 100% circular cross section, and must have prior written authorization from the County for use.
- J. Valves shall open when turning the operating nut or wheel counterclockwise and shall close when turning clockwise.
- K. All bonnet bolts, gland bolts, flange connection bolts, nuts, washers, and other trim hardware exposed to the outside environment shall be stainless steel. Thrust collar tie-rod bolts shall be stainless steel. All MJ-type underground bolts, nuts, and washers shall be COR-TEN or stainless steel.
- L. All valves shall have a factory applied, holiday free, fusion bonded epoxy coating on the interior and exterior unless otherwise noted in the plans or the following specification. All

other painted items exposed to sunlight, including field painted box lids, etc., shall be painted the appropriate color with an epoxy type paint.

- M. No valves with a break-way stem shall be allowed.
- N. The equipment shall include, but not be limited to, the following:
 - 1. Gate valves (Sec. 2.01)
 - 2. Combination Pressure Reducing and Pressure Sustaining with Check Valves Option (Sec. 2.02)
 - 3. Ball Valves (Sec. 2.03)
 - 4. Butterfly Valves (Sec. 2.04)
 - 5. Plug Valves (Sec. 2.05)
 - 6. Valve Actuators (Sec. 2.06)
 - 7. Air Release Valves (Sec. 2.07)
 - 8. Valves Boxes (Sec. 2.08)
 - 9. Corporation Stops and Saddles (Sec. 2.09)
 - 10. Flange Adapters and Plain End Couplings (Sec. 2.10)
 - 11. Hose Bibs (Sec. 2.11)
 - 12. Swing Check Valves (Sec. 2.12)
 - 13. Hydrants (Sec. 2.13)
 - 14. Restrained Joints (Sec. 2.14)
 - 15. Tapping Sleeves and Tapping Valves (Sec. 2.15)
 - 16. Tracer Wire Boxes (Sec. 2.16)

1.02 SUBMITTALS

- A. Submit to the County within 30 days after execution of the contract a list of materials to be furnished, the names of the suppliers and the date of delivery of materials to the site.
- B. Complete shop drawings of all valves and appurtenances shall be submitted to the County for approval in accordance with the Specifications.

1.03 TOOLS

Special tools, if required for normal operation and maintenance shall be supplied with the equipment.

PART 2 PRODUCTS

2.01 GATE VALVES

- A. Where indicated on the drawings or necessary due to locations, size, or inaccessibility, chain wheel operators shall be furnished with the valves. Such operators shall be designed with adequate strength for the valves with which they are supplied and provide for easy operation of the valve. Chains for valve operators shall be galvanized.
- B. Gate valves installed underground shall be provided with a box cast in a concrete pad and a box cover. Stainless steel or equivalent valve extension stems shall be provided to place the valve operating nut no more than 4 feet deep. One valve wrench, 6 feet in length, shall be provided for every 15 valves installed.

- C. Gate valves 2 inches to 14 inches in diameter shall be resilient seated, manufactured to meet or exceed the requirements of AWWA C509 or AWWA C515 and shall be UL listed and FM approved where applicable. Valves shall have an unobstructed waterway equal to or greater than the full nominal diameter of the valve.
- D. The valves shall have a non-rising stainless steel stem to eliminate lead content. All bolts, nuts and washers shall be stainless steel to eliminate exterior corrosion and maintain fastener strength. Manufacturer shall use Never-Seez or equivalent during assembly of bolt and nut sets to prevent galling of similar metals. Stem seals shall be provided and shall be of the O-ring type, two above and one below the thrust collar. Valves that are located above grade and located in valve vaults shall be OS&Y with flanged joints.
- E. The wedge shall be ductile iron fully encapsulated with an EPDM rubber. The Elastomer type shall be permanently indicated on the disc or body of the valve. The resilient sealing mechanism shall provide zero leakage at the water working pressure when installed with the line flow in either direction.
- F. The valve body, bonnet, and bonnet cover shall meet or exceed all the requirements of AWWA C515.
- G. Valves meeting AWWA C515 requirements shall be rated for an operating pressure of 250 psi and shall be tested in accordance with AWWA C515.
- H. The valves are to have 2-inch cast or ductile iron AWWA operating nuts and shall open left or counterclockwise.
- I. The valves shall be covered by a Manufacturer's 10 year warranty on manufacturer's defects and reasonable labor costs for replacement. Warranty shall become effective from the date of purchase by the end user and delivered within 30 days from the receipt of the purchase order. For publicly owned and maintained utilities, the end user is Manatee County Government.
- J. Gate valves shall be assembled and tested in a certified ISO 9001:2000 manufacturing facility within the United States and provide their certification of meeting internationally recognized quality control procedures.

2.02 COMBINATION PRESSURE REDUCING & PRESSURE SUSTAINING WITH CHECK VALVE OPTION

- A. Pressure sustaining and check valve shall be pilot operated diaphragm actuated valve with cast iron body, bronze trim, and 125-pound flanged ends. The valve shall be hydraulically operated, diaphragm type globe valve. The main valve shall have a single removable seat and a resilient disc, of rectangular cross section, surrounded on three and a half sides. No external packing glands are permitted and there shall be no pistons operating the main valve or any controls. The valve shall be equipped with isolation valves to service the pilot system while permitting flow if necessary. Main valve and all pilot controls shall be manufactured in the United States of America. Valve shall be single chamber type, with stainless steel stem.
- B. Valve shall automatically reduce pressure for the downstream distribution network and sustain a minimum pressure in the high pressure main regardless of distribution demand, and as an option, shall also close when a pressure reversal occurs for check valve operations. The pilot system shall consist of two direct acting, adjustable, spring loaded diaphragm valves.

- C. Valve shall be cast iron or ductile iron with main valve trim of brass and bronze. The pilot control valves shall be cast brass with 303 stainless steel trim. Valve shall be similar in all respects to Cla-Val Company, Model 92-01 or a similar control valve such as Bernad Model 723, GA Industries Model 4700 or an approved equal.

2.03 BALL VALVES

- A. Ball valves for water and reclaimed water, in sizes 3/4-inch through 2-inch, shall be brass body, stem and ball per ASTM B 62, alloy 85-5-5-5, full port, full flow, 1/4-turn check, ball curb valves, rated for 300 psi, Mueller 300 (as specified in the table below), Ford B-Series, or approved equal, with compression, pack joint, flare, threaded or flanged ends as required. Ball valves for wastewater, 2-inch through 3-inch, shall be 316 stainless steel body, cap, stem and ball per ASTM A351, full port, full flow, 1/4-turn check, ball valves, steam rated for 150 psi, pressure rating 1,000 psi CWT, Apollo 76F or approved equal, with threaded or flanged ends as required.

Curb Stops for Water and Reclaimed Water

| Pipe Material | Type of Connection | Model |
|---|--------------------|-----------|
| HDPE | Compression x FIP | B-25170 * |
| HDPE | Pack Joint x FIP | P-25170 * |
| Copper | Compression x FIP | B-25170 |
| Copper | Flare x FIP | B-25166 |
| Stainless Steel | FIP x FIP Thread | B-20200 |
| * Insert required, part number per manufacturer product information | | |

- B. All valves shall be mounted in such a position that valve position indicators are plainly visible. Above grade ball valves shall have a vinyl coated lever handle. Lever handle, handle nut, and lever packing gland shall be 304 or 316 stainless steel.
- C. Potable plastic service pipe material and compression and pack joint connectors shall not be used in soil that is contaminated with low molecular-weight petroleum products, aromatic hydrocarbons, chlorinated hydrocarbons or organic solvents. Appropriate service tubing shall apply.

2.04 BUTTERFLY VALVES

- A. Butterfly valves shall conform to AWWA C504, Class 250 B, Mueller Lineseal XP11, DeZurik AWWA, Pratt HP-250II, or an approved equal.
- B. Valve seats shall be an EPDM elastomer. Valve seats 24 inches and larger shall be field adjustable and replaceable without dismounting operator disc or shaft and without removing the valve from the line. Valves 20 inches and smaller shall have bonded or mechanically restrained seats as outlined in AWWA C504.
- C. All valves shall be subject to hydrostatic and leakage tests at the point of manufacture. The hydrostatic test for Class 250 valves shall be performed with an internal hydrostatic pressure equal to 500 psi applied to the inside of the valve body of each valve. During the hydrostatic test, there shall be no leakage through the metal, the end joints or the valve shaft seal. The leakage test for the Class 250 valves shall be performed at a differential pressure of 250 psi

and against both sides of the valve. No adjustment of the valve disc shall be necessary after pressure test for normal operation of valve. All valves shall be leaktight in both directions.

- D. Butterfly valve actuators shall conform to AWWA C504. Gearing for the actuators shall be totally enclosed in a gear case. Actuators shall be capable of seating and unseating the disc against the full design pressure and shall transmit a minimum torque to the valve. Actuators shall be rigidly attached to the valve body.
- E. The valve shaft shall be constructed of 18-8, ASTM A-276, Type 304 stainless steel and designed for both torsional and shearing stresses when the valve is operated under its greatest dynamic or seating torque. Shaft shall be of either a one piece unit extending full size through the valve disc and valve bearing or it may be of a stub shaft design. Shaft bearings shall be teflon or nylon, self-lubricated type.
- F. Gearing for the operators shall be totally enclosed in a gear case in accordance with paragraph 3.8.3 of the above mentioned AWWA Standard Specification.
- G. Operators shall be capable of seating and unseating the disc against the full design pressure of velocity, as specified for each class, into a dry system downstream and shall transmit a minimum torque to the valve. Operators shall be rigidly attached to the valve body.
- H. The manufacturer shall certify that the required tests on the various materials and on the completed valves have been satisfactory and that the valves conform with all requirements of this Specification and the AWWA standard.
- I. Where indicated on the Drawings, extension stems, floor stands, couplings, stem guides, and floor boxes as required shall be furnished and installed.

2.05 PLUG VALVES

- A. Plug valves shall be eccentric, non-lubricating type with integral plug and shafts and shall be furnished with end connections and with actuating mechanisms as called for on the construction plans or as otherwise required. Valves shall seal bubble-tight or water drop-tight in both directions when tested according to the Leakage Test method of AWWA C504 with a hydrostatic pressure of 150 psi.
- B. Plug valves shall also be subjected to the internal, full body Hydrostatic Test of AWWA C504 at a pressure two times the rated pressure or a minimum pressure of 300 psi, whichever is greater. During the test, there shall be no leakage through the metal, or through the end joints or shaft seal, nor shall any part of the valve be deformed. Plug valves shall be Kennedy or Dezurik.
- C. Flanged valve ends shall be faced and drilled according to ANSI B 16.1, Class 125. Mechanical joint valve ends shall conform to AWWA C111. Threaded ends shall conform to the NPT requirements of ANSI B1.20.1.
- D. The plug valve body, bonnet and gland shall be ductile iron per ASTM A 126, Class B. The integral plug and shafts shall be cast iron ASTM A 126, Class B, or 316 stainless steel. The entire plug, except for the shafts, shall be covered with nitrile (Buna N) rubber. The rubber compound shall have been vulcanized to the metal plug and shall have a peel strength of not less than 75 pounds per inch when tested according to ASTM D 429, method B. The

valve seat shall be at least 90 percent pure nickel, welded-in overlay into the cast iron body. The top and bottom bearings shall be 316 stainless steel.

- E. Plug valves shall have a full port area of 100 percent of the nominal pipe size area.
- F. Valves shall have worm gear type actuators with 2-inch square operating nuts.
- G. Plug valves shall be installed side-ways with plug shaft horizontal so that the plug rotates upward when it opens, with the flow entering the seat end of the valve.
- H. Plug valves shall be coated inside with Protecto 401 or amine-cured novolac ceramic epoxy or another two-part epoxy suitable for sanitary sewer service which has been approved by Manatee County.

2.06 VALVE ACTUATORS

- A. Butterfly valve and plug valve actuators.

Butterfly valve and plug valve actuators shall conform to the requirements for actuators presented in AWWA C 504 and shall be either manual or motor operated. Actuators shall be capable of seating and unseating the disc against the full design pressure and velocity, as specified for each class, into a dry system downstream, and shall transmit a minimum torque to the valve. Actuators shall be rigidly attached to the valve body.

- B. Manual Actuators.

Manual actuators shall have permanently lubricated, totally enclosed gearing with handwheel and gear ratio sized on the basis of actual line pressure and velocities. Actuators shall be equipped with handwheel, position indicator, and mechanical stop-limiting locking devices to prevent over travel of the disc in the open and closed positions. They shall turn counter-clockwise to open valves. Manual actuators shall be of the traveling nut, self-locking type or of the worm gear type and shall be designed to hold the valve in any intermediate position between fully open and fully closed without creeping or fluttering. Valves located above grade shall have handwheel and position indicator, and valves located below grade shall be equipped with a 2-inch square AWWA operating nut located at ground level and cast iron extension type valve box.

- C. Motor Actuators (Modulating)

- (1) The motor actuated valve controller shall include the motor, actuator unit gearing, limit switch gearing, limit switches, position transmitter which shall transmit a 4-20 mA DC signal, control power transformer, electronic controller which will position the valve based on a remote 4-20 milliamp signal, torque switches, bored and key-wayed drive sleeve for non-rising stem valves, declutch lever and auxiliary handwheel as a self-contained unit.
- (2) The motor shall be specifically designed for valve actuator service using 480 volt, 60 Hertz, three phase power as shown, on the electrical drawings. The motor shall be sized to provide an output torque and shall be the totally enclosed, non-ventilated type. The power gearing shall consist of helical gears fabricated from heat treated alloy steel forming the first stage of reduction. The second reduction stage shall be a single stage worm gear. The worm shall be of alloy steel with carburized threads hardened and ground for high efficiency. The worm gear shall be of high tensile strength bronze with

hobbed teeth. All power gearing shall be grease lubricated. Ball or roller bearings shall be used throughout. Preference will be given to units having a minimum number of gears and moving parts. Spur gear reduction shall be provided as required.

- (3) Limit switches and gearing shall be an integral part of the valve control. The limit switch gearing shall be made of bronze and shall be grease lubricated, intermittent type and totally enclosed to prevent dirt and foreign matter from entering the gear train. Limit switches shall be of the adjustable type capable of being adjusted to trip at any point between fully opened valve and fully closed valve.
- (4) The speed of the actuator shall be the responsibility of the system supplier with regard to hydraulic requirements and response compatibility with other components within the control loop. Each valve controller shall be provided with a minimum of two rotor type gear limit switches, one for opening and one for closing. The rotor type gear limit switch shall have two normally open and two normally closed contacts per rotor. Gear limit switches must be geared to the driving mechanism and in step at all times whether in motor or manual operation. Provision shall be made for two additional rotors as described above, each to have two normally open and two normally closed contacts. Each valve controller shall be equipped with a double torque switch. The torque switch shall be adjustable and will be responsive to load encountered in either direction of travel. It shall operate during the complete cycle without auxiliary relays or devices to protect the valve, should excessive load be met by obstructions in either direction of travel. The torque switch shall be provided with double-pole contacts.
- (5) A permanently mounted handwheel shall be provided for manual operation. The handwheel shall not rotate during electric operations, but must be responsive to manual operation at all times except when being electrically operated. The motor shall not rotate during hand operation nor shall a fused motor prevent manual operation. When in manual operating position, the unit will remain in this position until motor is energized at which time the valve operator will automatically return to electric operation and shall remain in motor position until handwheel operation is desired. This movement from motor operation to handwheel operation shall be accomplished by a positive declutching lever which will disengage the motor and motor gearing mechanically, but not electrically. Hand operation must be reasonably fast. It shall be impossible to place the unit in manual operation when the motor is running. The gear limit switches and torque switches shall be housed in a single easily accessible compartment integral with the power compartment of the valve control. All wiring shall be accessible through this compartment. Stepping motor drives will not be acceptable.
- (6) The motor with its control module must be capable of continuously modulating over its entire range without interruption by heat protection devices. The system, including the operator and control module must be able to function, without override protection of any kind, down to zero dead zone.
- (7) All units shall have strip heaters in both the motor and limit switch compartments.
- (8) The actuator shall be equipped with open-stop-close push buttons, an auto-manual selector switch, and indicating lights, all mounted on the actuator or on a separate locally mounted power control station.
- (9) The electronics for the electric operator shall be protected against temporary submergence.

- (10) Actuators shall be Limitorque L120 with Modutronic Control System containing a position transmitter with a 4-20MA output signal or equal.

D. Motor Actuators (Open-Close)

- (1) The electronic motor-driven valve actuator shall include the motor, actuator gearing, limit switch gearing, limit switches, torque switches, fully machined drive sleeve, declutch lever, and auxiliary handwheel as a self-contained unit.
- (2) The motor shall be specifically designed for valve actuator service and shall be of high torque totally enclosed, nonventilated construction, with motor leads brought into the limit switch compartment without having external piping or conduit box.
- (3) The motor shall be of sufficient size to open or close the valve against maximum differential pressure when voltage to motor terminals is 10% above or below nominal voltage.
- (4) The motor shall be prelubricated and all bearings shall be of the anti-friction type.
- (5) The power gearing shall consist of helical gears fabricated from heat treated steel and worm gearing. The worm shall be carburized and hardened alloy steel with the threads ground after heat treating. The worm gear shall be of alloy bronze accurately cut with a hobbing machine. All power gearing shall be grease lubricated. Ball or roller bearings shall be used throughout.
- (6) Limit switches and gearing shall be an integral part of the valve actuator. The switches shall be of the adjustable rotor type capable of being adjusted to trip at any point between fully opened valve and fully closed valve. Each valve controller shall be provided with a minimum of two rotor type gear limit switches, one for opening and one for closing (influent valves require additional contacts to allow stopping at an intermediate position). The rotor type gear limit switch shall have two normally open and two normally closed contacts per rotor. Additional switches shall be provided if shown on the control and/or instrumentation diagrams. Limit switches shall be geared to the driving mechanism and in step at all times whether in motor or manual operation. Each valve actuator shall be equipped with a double torque switch. The torque switch shall be adjustable and will be responsive to load encountered in either direction of travel. It shall operate during the complete cycle without auxiliary relays or devices to protect the valve should excessive load be met by obstructions in either direction of travel. Travel and thrusts shall be independent of wear in valve disc or seat rings.
- (7) A permanently mounted handwheel shall be provided for manual operation. The handwheel shall not rotate during electric operation except when being electrically operated. The motor shall not rotate during hand operation, nor shall a fused motor prevent manual operation. When in manual operating position, the unit will remain in this position until motor is energized at which time the valve actuator will automatically return to electric operation and shall remain in motor position until handwheel operation is desired. Movement from motor operation to handwheel operation shall be accomplished by a positive declutching lever which will disengage the motor and motor gearing mechanically, but not electrically. Hand operation must be reasonably fast. It shall be impossible to place the unit in manual operation when the motor is running.

- (8) Valve actuators shall be equipped with an integral reversing controller and three phase overload relays, Open-Stop-Close push buttons, local-remote-manual selector switch, control circuit transformer, three-phase thermal overload relays and two pilot lights in a NEMA 4X enclosure. In addition to the above, a close coupled air circuit breaker or disconnect switch shall be mounted and wired to the valve input power terminals for the purpose of disconnecting all underground phase conductors.
- (9) The valve actuator shall be capable of being controlled locally or remotely via a selector switch integral with the actuator. In addition, an auxiliary dry contact shall be provided for remote position feedback.
- (10) Valve A.C. motors shall be designed for operation on a 480 volt, 3-phase service. Valve control circuit shall operate from a fuse protected 120 volt power supply.
- (11) Motor operators shall be as manufactured by Limitorque Corporation, Type L120 or approved equal.

2.07 AIR RELEASE VALVES

- A. Air release valves shall be automatic float operated, GA Industries fig-929 for sewer applications, Fig-920 for water and reclaimed water application, or an approved equal, with inlet size and working pressure ratings as required and NPT connections.
- B. Valve bodies shall be ductile iron per ASTM A 126, Class B. The orifice, float and linkage shall be stainless steel. The seat shall be (Buna N) nitrile elastomer.

2.08 VALVE BOXES

- A. Buried valves shall have adjustable cast iron or HDPE valve boxes. Lids shall be cast iron drop type, and shall have "WATER", "SEWER", or "RECLAIM", as applicable, cast into the top. Lids will be painted "safety" blue for potable, purple for reclaimed, and green for sanitary sewer.
- B. Cast iron boxes shall be two-piece, or three-piece, as required, screw type, Tyler Pipe, 6850 Series, Box 461-S through 668-S, with extensions, as required to make the desired box length, or an approved equal. Bottom barrel shall be 5-1/4 inches inside diameter, with a flanged bottom with sufficient bearing area to prevent settling.
- C. HDPE boxes shall be two-piece, adjustable, 1/4-inch thick minimum heavy wall, high density polyethylene, with cast iron top and stainless steel adjustable stem, Trench Adapter, as manufactured by American Flow Control, or an approved equal. Bottom barrel shall have flanged bottom to prevent settling. All bolts, screws and pins shall be stainless steel.
- D. Reclaimed Valve Boxes shall be square 9-inch x 9-inch load bearing marked "Reclaimed Water" and painted Pantone 522C purple.
- E. All valves shall either have operating nuts within 4 feet below the top of the lid or shall have extension stems with centering guides to provide an extended operating nut within 4 feet below the lid. Extension stems shall be fixed to the valve operating nut with a stainless steel fastener.
- F. All potable water, sewer, and reclaimed water grade-adjustment risers shall be cast iron material just like the valve box. No plastic or steel risers shall be allowed.

- G. A centering device BoxLok or equal shall be installed in the valve box.
- H. Stand pipe shall match color code of the system being installed, (blue for potable, Pantone purple 522 C for reclaimed, and green for sanitary sewer).

2.09 CORPORATION STOPS AND SADDLES

- A. Corporation stops for connections to ductile iron and PVC water and reclaimed water mains shall be all red brass, alloy 85-5-5-5, per ASTM B 62, and shall conform to AWWA C800. 1-inch through 2-inch corporation stops shall be ball type, 300 psi working pressure rated, with AWWA MIP threaded inlets and compression, pack joint, flare, or FIP threaded joint outlets, Mueller as shown in the table below, or an approved equal. All joints made to CTS size HDPE tubing shall use stainless steel insert stiffeners.

Corporation Stops

| Pipe Material | Type of Connection | Mueller 300 Model |
|---|---------------------------------|------------------------|
| HDPE | Compression x AWWA IP Thread | B-25028 (Saddle) * |
| HDPE | Compression x AWWA Taper Thread | B-25008 (Direct Tap) * |
| HDPE | Pack Joint x AWWA IP Thread | P-25028 (Saddle) * |
| HDPE | Pack Joint x AWWA Taper Thread | P-25008 (Direct Tap) * |
| Copper | Compression x AWWA IP Thread | B-25028 (Saddle) |
| Copper | Pack Joint x AWWA Taper Thread | B-25008 (Direct Tap) |
| Copper | Pack Joint x AWWA IP Thread | P-25028 (Saddle) |
| Copper | Pack Joint x AWWA Taper Thread | P-25008 (Direct Tap) |
| Copper | Flare x AWWA IP Thread | B-25025 (Saddle) |
| Copper | Flare x AWWA Taper Thread | B-25000 (Direct Tap) |
| Stainless Steel | FIP Thread x AWWA IP Thread | B-20046 (Saddle) |
| Stainless Steel | FIP Thread x AWWA Taper Thread | B-20045 (Direct Tap) |
| * Insert required, part number per manufacturer product information | | |

- B. Potable plastic service pipe material and compression and pack joint connectors shall not be used in soil that is contaminated with low molecular-weight petroleum products, aromatic hydrocarbons, chlorinated hydrocarbons or organic solvents. Appropriate service tubing shall apply.
- C. Water and reclaimed water service connections to PVC and DIP mains shall be made using red brass saddles, alloy 85-5-5-5, per ASTM B 62. Straps, washers and nuts shall be brass or stainless steel. No ductile iron, cast iron or steel saddles will be allowed. Saddles shall be Smith Blair 325 Bronze saddles with Stainless Steel or brass extra wide strap or equivalent.
- D. Connections to PVC sanitary force mains for services up to 2 inches shall be made using Romac Style 306 double bolt stainless steel service saddles or equivalent.
- E. Service and air release valve (ARV) connections to HDPE water, reclaimed water and sewer mains may be made using Romac Style 306H saddle or approved equal. All saddles shall be properly sized per the manufacturer product information and be installed according to the manufacturer's written instructions. Connections to HDPE mains shall not be made using narrower saddles similar to the Smith-Blair 325.

2.10 FLANGED ADAPTERS AND PLAIN END COUPLINGS

Plain end couplings and adapters shall be fusion-bonded epoxy coated carbon steel with Ethylene Propylene Diene Monomer (EPDM) rubber gaskets and stainless steel nuts, bolts and spacers. Acrylonitrile butadiene (NBR) gaskets shall be used for potable water mains that are located in soil that is contaminated with low molecular-weight petroleum products or non-chlorinated organic solvents or non-aromatic organic solvents. Fluorocarbon (FKM) gaskets shall be used for potable water mains that are located in soil that is contaminated with aromatic hydrocarbons or chlorinated hydrocarbons. Fluorocarbon (FKM) gaskets shall be used for potable water mains if the soil is contaminated with aromatic hydrocarbons or chlorinated hydrocarbons, and is also contaminated with low molecular-weight petroleum products or organic solvents. Couplings shall be Dresser Style 38, or another approved equal. Flange adapters shall have a plain end compression seal similar to the style 38, with an ANSI 125 Class flange on the opposite end, and shall be Dresser Style 128W or an approved equal. Stainless steel backup rings shall be used for force mains that are located in corrosive environments including wetwells and valve vaults.

2.11 HOSE BIBS

Hose bibs shall be 3/4" or 1" brass, polished chromium plated brass, with vacuum breaker as noted on the drawings.

2.12 SWING CHECK VALVES

- A. Check valves shall be swing type, weighted lever, conforming to AWWA C508. Valves shall be iron-body, bronze-mounted, single disk, 175 psi working pressure for 2- through 12-inch, 150 psi for 14- through 30-inch, with ANSI B16.1 Class 125 flanged ends, by Mueller; No. A-2600-6-01 (sewer), No. A-2602-6-01 (water), or AVK Series 41, or an approved equal.
- B. When there is no flow through the line, the disc shall hang lightly against its seat in practically a vertical position. When open, the disc shall swing clear of the waterway.
- C. Check valves shall have bronze seat and body rings, extended bronze or stainless steel hinge pins and stainless steel nuts and bolts on bolted covers.
- D. Valves shall be so constructed that disc and body seat may easily be removed and replaced without removing the valve from the line. Valves shall be fitted with an extended hinge arm with outside lever and weight.

2.13 HYDRANTS

Hydrants shall be dry barrel, nostalgic style, and shall be AVK Series 2780, American Darling B-84-B, Mueller Super Centurian 250, or approved equal and shall conform to AWWA C502 and UL/FM certified, and shall in addition meet the specific requirements and exceptions which follow:

- A. Hydrants shall be according to manufacturer's standard pattern or nostalgic style and of standard size, and shall have one 5-inch Storz connection or equivalent with two 2½-inch hose nozzles.
- B. Hydrant inlet connections shall have mechanical joints for 6-inch pipe.
- C. Hydrant valve opening shall have an area at least equal to that area of a 5 1/4-inch minimum diameter circle and be obstructed only by the valve rod. Each hydrant shall

be able to deliver 500 gpm minimum through its two 2 1/2 -inch hose nozzles when opened together with a loss of not more than 2 psi in the hydrant per AWWA C502.

- D. The upper and lower stem rod shall be stainless steel and shall have a breakable stem-rod coupling of stainless steel, or cast iron or ductile iron with a fusion bonded epoxy coating, with stainless steel pins and clips.
- E. Hydrants shall be hydrostatically tested as specified in AWWA C502 and shall be rated at 250 psi minimum.
- F. The operating nut shall be 1½ -inch pentagon shaped with a protective weather cover, and open counter clockwise.
- G. All nozzle threads shall be American National Standard.
- H. Each nozzle cap shall be provided with a Buna N rubber washer.
- I. All hydrants shall be traffic break away type and allow for 360 degree rotation to position the Storz connection/nozzle in the desired direction after installation.
- J. Hydrants must be capable of being extended without removing any operating parts.
- K. Hydrant extensions shall be fusion bonded epoxy coated inside and outside with a stainless steel stem. The breakaway coupling can be fusion bonded epoxy coated or stainless steel. Only one hydrant extension is allowed per hydrant.
- L. Weepholes shall be excluded from fire hydrants.
- M. Hydrant main valve closure shall be of the compression type opening against the pressure and closing with the pressure. The main valve shall be faced or covered with EPDM elastomer, which shall seat on a bronze ring.
- N. Hydrant bonnets, weather cover, nozzle section, caps and shoe shall be cast iron or ductile iron, and shall be holiday free fusion-bonded epoxy coated at the factory, per AWWA C550, inside and outside. Lower barrel shall be fusion bonded epoxy coated inside and outside. Aboveground parts shall also have a top coat of Sherwin-Williams Acrolon 218 HS acrylic polyurethane or approved equal; color Safety Yellow for fire hydrants that are connected to the potable water system or Pantone 522C purple for fire hydrants that are connected to the reclaimed water system.
- O. Exterior nuts, bolts and washers shall be stainless steel. Bronze nuts may be used below grade.
- P. All internal operating parts shall be removable without requiring excavation.

2.14

RESTRAINED JOINTS

- A. Pipe joints shall be restrained by poured-in-place concrete thrust blocks or by other mechanical methods, including tie rods, Stargrip and Allgrip, as manufactured by Star Pipe Products or Megaflange and 2000 PV, as manufactured by EBAA Iron Sales. Flanged joints may be used above ground.

- B. All T-bolts, bolts, nuts, washers, and all thread rods shall meet ASTM A-588 requirements (Cor-ten or equivalent) “weathering steel” or be 316 stainless steel. The use of rebar with welded thread is prohibited.

A certification from the supplier shall be provided to the County during the shop drawing review process ensuring all T-bolts, bolts, nuts, washers, and all thread rods meet the A-588 requirements and shall state the project name and contractor in the certification letter. If stainless steel is to be used, no certification letter is required.

- C. Restrained joints may also be Lok-Ring, as manufactured by American Cast Iron Pipe Company, or an approved equal.
- D. Restrained joint designs, which require wedges and/or shims to be driven into the joints in order to disassemble the pipe shall not be allowed.

2.15 TAPPING SLEEVES AND VALVES

- A. Tapping valves shall meet the requirements of AWWA C509/C515 with ductile iron body and shall be rated for a pressure of 250 psi. The valves shall be flanged with alignment ring by mechanical joint with a nonrising stainless steel stem. All bolts, nuts and washers shall be stainless steel. Manufacturer shall use Never-Seez or equivalent during assembly of bolt and nut sets to prevent galling of similar metals. Stem seals shall be provided and shall be of the O-ring type, two above and one below the valve’s thrust collar. Valve shall be designed for vertical burial and shall open counterclockwise. Operating nut shall be AWWA standard 2-inch square for valves 2 inches and up. Valves shall have an unobstructed waterway equal to or greater than the full nominal diameter of the valve to accommodate full size shell cutter. Gaskets shall cover the entire area of the flange surface and be 1/8-inch minimal thickness of red rubber. The wedge shall be ductile iron fully encapsulated with EPDM rubber. All bolts, nuts and washers between the sleeve and valve shall be stainless steel.
- B. Tapping sleeves and saddles shall be stainless steel, seal to the pipe by the use of a gasket compounded for water or sewer, and shall be able to withstand a pressure test of 180 psi for water lines or 150 psi for sewer force mains for one hour with no leakage in accordance with AWWA C110. A stainless steel 3/4-inch NPT test plug shall be provided for pressure testing. All bolts joining the two halves shall be stainless steel and shall be included with the sleeve or saddle; Romac SST III or Romac SST-H.

2.16 TRACER WIRE TEST STATION BOXES

Tracer wire test station boxes shall be provided at plug valves, butterfly valves, blowoff valves, gate valves, fire hydrants and backflow preventers as indicated in these Standards. Tracer wire test station boxes for yard service shall be 2 ½ inch diameter, 15 inch length, ABS plastic with a cast iron rim and lid, P200NFGT as manufactured by Bingham & Taylor, or equal approved by Manatee County. Where test boxes will be in streets or subject to vehicular traffic, use B&T Model P525RD, 5 ¼ -inch diameter or equal, centered in a separate concrete pad similar to a valve box pad.

PART 3 EXECUTION

3.01 INSTALLATION

- A. All valves and appurtenances shall be installed in the location shown, true to alignment and rigidly supported. Any damage occurring to the above items before they are installed shall be repaired to the satisfaction of the County.
- B. After installation, all valves and appurtenances shall be tested at least two hours at the working pressure corresponding to the class of pipe, unless a different test pressure is specified. If any joint proves to be defective, it shall be repaired to the satisfaction of the County.
- C. Install all floor boxes, brackets, extension rods, guides, the various types of operators and appurtenances as shown on the Drawings that are in masonry floors or walls, and install concrete inserts for hangers and supports as soon as forms are erected and before concrete is poured. Before setting these items, the Contractor shall check all plans and figures which have a direct bearing on their location and he shall be responsible for the proper location of these valves and appurtenances during the construction of the structures.
- D. Pipe for use with flexible couplings shall have plain ends as specified in the respective pipe sections.
- E. Flanged joints and mechanical joints shall be made with high strength, low alloy Corten or 316 stainless steel bolts, nuts and washers.
- F. Prior to assembly of split couplings, the grooves as well as other parts shall be thoroughly cleaned. The ends of the pipes and outside of the gaskets shall be moderately coated with petroleum jelly, cup grease, soft soap or graphite paste, and the gasket shall be slipped over one pipe end. After the other pipe has been brought to the correct position, the gasket shall be centered properly over the pipe ends with the lips against the pipes. The housing sections then shall be placed. After the bolts have been inserted, the nuts shall be tightened until the housing sections are firmly in contact, metal-to-metal, without excessive bolt tension.
- G. Prior to the installation of sleeve-type couplings, the pipe ends shall be cleaned thoroughly for a distance of 8". Soapy water may be used as a gasket lubricant. A follower and gasket, in that order, shall be slipped over each pipe to a distance of about 6" from the end.
- H. Valve boxes with concrete bases shall be installed as shown on the Drawings. Mechanical joints shall be made in the standard manner. Valve stems shall be vertical in all cases. Place cast iron box over each stem with base bearing on compacted fill and the top flush with final grade. Boxes shall have sufficient bracing to maintain alignment during backfilling. Knobs on cover shall be parallel to pipe. Remove any sand or undesirable fill from valve box.

3.02 HYDRANTS

- A. Hydrants shall be set at the locations designated by the County and/or as shown on the Drawings and shall be bedded on a firm foundation. A drainage pit on crushed stone as shown on the Drawings shall be filled with gravel or crushed stone and satisfactorily compacted. During backfilling, additional gravel or crushed stone shall be brought up around and 6" over the drain port. Each hydrant shall be set in true vertical alignment and shall be properly braced. Concrete thrust blocks shall be placed between the back of the hydrant inlet and undisturbed soil at the end of the trench. Minimum bearing area shall be as shown on the plans. Felt paper shall be placed around the hydrant elbow prior to placing concrete. CARE MUST BE TAKEN TO INSURE THAT CONCRETE DOES NOT PLUG

THE DRAIN PORTS. Concrete used for backing shall be as specified herein.

- B. When installations are made under pressure, the flow of water through the existing main shall be maintained at all times. The diameter of the tap shall be a minimum of 2" less than the inside diameter of the branch line.
- C. The entire operation shall be conducted by workmen thoroughly experienced in the installation of tapping sleeves and valves, and under the supervision of qualified personnel furnished by the manufacturer. The tapping machine shall be furnished by the Contractor if tap is larger than 12" in diameter.
- D. The Contractor shall determine the locations of the existing main to be tapped to confirm the fact that the proposed position for the tapping sleeve will be satisfactory and no interference will be encountered such as the occurrence of existing utilities or of a joint or fitting at the location proposed for the connection. No tap will be made closer than 30" from a pipe joint.
- E. Tapping valves shall be set in vertical position and be supplied with a 2" square operating nut for valves 2" and larger. The valve shall be provided with an oversized seat to permit the use of full sized cutters.
- F. Tapping sleeves and valves with boxes shall be set vertically or horizontally as indicated on the Drawings and shall be squarely centered on the main to be tapped. Adequate support shall be provided under the sleeve and valve during the tapping operation. Sleeves shall be no closer than 30" from water main joints. Thrust blocks shall be provided behind all tapping sleeves. Proper tamping of supporting earth around and under the valve and sleeve is mandatory. After completing the tap, the valve shall be flushed to ensure that the valve seat is clean.

3.03 SHOP PAINTING

Ferrous surfaces of valves and appurtenances shall receive a coating of rust-inhibitive primer. All pipe connection openings shall be capped to prevent the entry of foreign matter prior to installation.

3.04 FIELD PAINTING

All metal valves and appurtenances specified herein and exposed to view shall be painted safety blue.

3.05 INSPECTION AND TESTING

All pipelines shall remain undisturbed for 24 hours to develop complete strength at all joints. All pipelines shall be subjected to a hydrostatic pressure and leak testing. Refer to Manatee County Public Works Utility Standards Part 1-Utility Standards Manual Section 1.8.7. Prior to testing, the pipe lines shall be supported in a manner approved by the County to prevent movement during tests.

All leaks shall be repaired and lines retested as approved by the County.

END OF SECTION

SECTION 02720 SANITARY SEWER BYPASS PUMPING

PART 1 GENERAL

1.01 SCOPE

The Contractor shall furnish all labor, materials, equipment and incidentals required to maintain existing and anticipated flows within the affected portion of the collection system throughout the construction period.

1.02 PUBLIC IMPACTS

The contractor shall not create a public nuisance due to excessive noise or dust, nor impact the public with flooding of adjacent lands, discharge of raw sewage, or release of other potential hazards, nor shall he encroach on or limit access to adjacent lands. No extra charge may be made for increased costs to the contractor due to any of the above.

1.03 SUBMITTALS

- A. The Contractor shall, within 30 days of the date of the Notice to Proceed, submit to the Project Manager a detailed Pumping Plan for each site by-pass pumping will be needed. The Pumping Plan shall address all measures and systems to prevent a sanitary sewer overflow (SSO) as defined by the EPA. The Plan shall include as a minimum:
1. Working drawings and sketches showing work location, pump location, piping layout & routing. Show all proposed encroachment and access impacts on adjacent properties or facilities.
 2. Pump, control, alarm and pipe specifications or catalog cuts. Detailed sketch of controls and alarm system.
 3. Power requirements and details on methods to provide by-pass power or fueling.
 4. Calculation and determination of response times to prevent an SSO after a high water alarm. If anticipated peak flows are 750 G.P.M. or greater, an operator is required on site at all times pump is in service. If the anticipated peak flows are less than 750 G.P.M. an operator may not be required to be on site at all times; show operator on-site schedule.
 5. Procedures to be taken in case of power, pump, or piping failures; including contact names and numbers for emergency notifications.
 6. Frequency and specific responsibility for monitoring pump operation, fuel levels, pump maintenance and entire length of piping.

PART 2 PRODUCTS

2.01 EQUIPMENT

- A. Pumps:
1. By-pass pumping system shall consist of at least a primary pump and a backup pump. Each pump shall have a minimum pumping capacity of 100% of the anticipated peak flows. When bypassing a pump station, 100% of the lift station capacity (G.P.M. & T.D.H) shall be provided.
 2. Pumps shall be low noise or sound attenuated. The noise level at any operating condition, in any direction, shall not exceed 70dBA at a distance of twenty three (23)

feet (7 meters) from the pump and/or power source.

B. Controls:

The by-pass pump system shall be equipped with automatic controls and an alarm system. The automatic controls will automatically start the backup pump in the event of a high water condition or failure of the primary pump. The alarm system will immediately notify the Contractor of a pump failure or high water condition.

C. Pipe:

Pipe shall be of adequate size and capacity to match the pumps. Pipe type and materials will depend on the particulars of the site conditions, and shall be detailed in the Pumping Plan. Contractor will provide all connections.

PART 3 EXECUTION

3.01 SITE CONDITIONS

Site conditions will vary by site. Contractor is responsible to determine and address requirements such as traffic control, excavation, connections & fittings, impacts on access to adjacent properties, routing and support of by-pass piping, etc., in the Pumping Plan.

3.02 ON-SITE MONITORING

- A. All by-pass operations where the anticipated flow rates are 750 G.P.M or greater shall require an employee on-site at all times (full-time on-site monitoring attended by personnel experienced with the pumps and controls, with demonstrated ability to monitor, turn on & off, and switch between pumps while the by-pass pump system is in service.
- B. By-pass operations where the anticipated flow rates are less than 750 G.P.M may not require an employee on-site at all times while the by-pass pump system is in operation. The Contractor shall have personnel experienced with the pumps and controls on site within the calculated response time to prevent an SSO after a high water alarm.
- C. During by-pass operations, the Contractor shall have posted on site with the permit, a copy of the approved Plan and the name and 24 hour contact number of the primary response person, the job site superintendent, and the construction company owner.

3.03 OPERATIONS

- A. The Contractor is responsible for securing and providing power, fuel, site security, traffic control and all other supplies, materials and permits required for the by-pass pumping.
- B. Contractor shall demonstrate automatic pump switching and alarm system to the satisfaction of: the County inspector, Project Manager, or Lift Stations Superintendent prior to beginning by-pass pumping. Satisfactory demonstration shall be documented by the inspector's, PM's or Lift Station Superintendent's dated signature on the posted copy of the approved Pumping Plan.

3.04 DAMAGE RESTORATION & REMEDIATION

- A. The Contractor shall be responsible for any pre-pump notifications, all restoration of pre-pump conditions and any damage caused by by-pass operations.
- B. Should there be an SSO caused by or as a direct result of the by-pass pumping, the contractor is responsible for all immediate & long term response, notifications, clean up, mitigation, etc. Copies of all written response plans, notifications, documentation, mitigation plans, etc., shall be submitted to the County Project Manager.

END OF SECTION

DIVISION 3 CONCRETE

SECTION 03200 CONCRETE REINFORCEMENT

PART 1 GENERAL

1.01 WORK INCLUDED

- A. Reinforcing steel bars and welded steel wire fabric for cast-in-place concrete, complete with tie wire.
- B. Support chairs, bolsters, bar supports and spacers, for reinforcing.

1.02 QUALITY ASSURANCE

Perform concrete reinforcing work in accordance with ACI 318 unless specified otherwise in this Section.

1.03 REFERENCES

- A. ACI 318 - Building Code Requirements for Reinforced Concrete.
- B. ASTM A185 - Welded Steel Wire Fabric for Concrete Reinforcement.
- C. ASTM A615 - Deformed and Plain Billet Steel Bars for Concrete Reinforcement.
- D. CRSI 63 - Recommended practice for placing reinforcing bars.
- E. CRSI 65 - Recommended practice for placing bar supports, specifications and nomenclature.
- F. ACI 315 - American Concrete Institute - Manual of Standard Practice.

1.04 SHOP DRAWINGS

- A. Submit shop drawings in accordance with Contract Documents.
- B. Indicate bar sizes, spacings, locations and quantities of reinforcing steel and wire fabric, bending and cutting schedules and supporting and spacing devices.
- C. Manufacturer's Literature: Manufacturer's specifications and installation instructions for splice devices.

PART 2 PRODUCTS

2.01 REINFORCING

- A. Reinforcing steel: Grade 60, Minimum Yield Strength 60,000 psi, deformed billet steel bars, ASTM A615; plain finish.
- B. Welded steel wire fabric: Deformed wire, ASTM A497; smooth wire ASTM A185 in flat

sheets; plain finish.

2.02 ACCESSORY MATERIALS

- A. Tie wire: Minimum 16 gauge annealed type, or patented system accepted by County.
- B. Chairs, bolsters, bar supports, spacers: Sized and shaped for strength and support of reinforcing during construction conditions.
- C. Special chairs, bolsters, bar supports, spacers (where adjacent to architectural concrete surfaces): Stainless steel type sized and shaped as required.

2.03 FABRICATION

- A. Fabricate concrete reinforcing in accordance with ACI 315.
- B. Locate reinforcing splices, not indicated on Drawings, at points of minimum stress. Location of splices shall be reviewed by County.
- C. Where indicated, weld reinforcing bars in accordance with AWS D12.1.

PART 3 EXECUTION

3.01 PLACEMENT

- A. Reinforcing shall be supported and secured against displacement. Do not deviate from true alignment.
- B. Before placing concrete, ensure reinforcing is clean, free of loose scale, dirt, or other foreign coatings which would reduce bond to concrete.

3.02 QUALITY ASSURANCE

- A. Acceptable Manufacturers: Regularly engaged in manufacture of steel bar and welded wire fabric reinforcing.
- B. Installer Qualifications: Three years experience in installation of steel bar and welded wire fabric reinforcing.
- C. Allowable Tolerances:
 - 1. Fabrication:
 - a. Sheared length: +1 in.
 - b. Depth of truss bars: +0, -1/2 in.
 - c. Stirrups, ties and spirals: $\pm 1/4$ in.
 - d. All other bends: ± 1 in.
 - 2. Placement:
 - a. Concrete cover to form surfaces: $\pm 1/4$ in.
 - b. Minimum spacing between bars: 1 in.
 - c. Top bars in slabs and beams:
 - (1) Members 8 in. deep or less: $\pm 1/4$ in.
 - (2) Members more than 8 in.: $\pm 1/2$ in.
 - d. Crosswise of members: Spaced evenly within 2 in. of stated separation.

- e. Lengthwise of members: Plus or minus 2 in.
3. Maximum bar movement to avoid interference with other reinforcing steel, conduits, or embedded items: 1 bar diameter.

3.04 PRODUCT DELIVERY, STORAGE AND HANDLING

- A. Deliver reinforcement to project site in bundles marked with metal tags indicating bar size and length.
- B. Handle and store materials to prevent contamination.

3.05 INSTALLATION

- A. Placement:
 1. Bar Supports: CRSI 65.
 2. Reinforcing Bars: CRSI 63.
- B. Steel Adjustment:
 1. Move within allowable tolerances to avoid interference with other reinforcing steel, conduits, or embedded items.
 2. Do not move bars beyond allowable tolerances without concurrence of County.
 3. Do not heat, bend, or cut bars without concurrence of County.
- C. Splices:
 1. Lap splices: Tie securely with wire to prevent displacement of splices during placement of concrete.
 2. Splice devices: Install in accordance with manufacturer's written instructions.
 3. Do not splice bars without concurrency of County, except at locations shown on Drawings.
- D. Wire Fabric:
 1. Install in longest practicable length.
 2. Lap adjoining pieces one full mesh minimum, and lay splices with 16 gauge wire.
 3. Do not make end laps midway between supporting beams, or directly over beams of continuous structures.
 4. Offset end laps in adjacent widths to prevent continuous laps.
- E. Cleaning: Remove dirt, grease, oil, loose mill scale, excessive rust, and foreign matter that will reduce bond with concrete.
- F. Protection During Concreting: Keep reinforcing steel in proper position during concrete placement.

END OF SECTION

SECTION 03300 CAST-IN-PLACE CONCRETE

PART 1 GENERAL

1.01 WORK INCLUDED

Poured-in-place concrete slabs, thrust blocks, pile caps and pipe support cradles.

1.02 QUALITY ASSURANCE

Perform cast-in-place concrete work in accordance with ACI 318, unless specified otherwise in this Section.

1.03 TESTING LABORATORY SERVICES

- A. Inspection and testing will be performed by the testing laboratory currently under contract to Manatee County in accordance with the Contract Documents.
- B. Provide free access to work and cooperate with appointed firm.
- C. Submit proposed mix design of each class of concrete to inspection and testing firm for review prior to commencement of work.
- D. Tests of cement and aggregates may be performed to ensure conformance with requirements stated herein.
- E. Three concrete test cylinders will be taken for every 100 cu. yds. or part thereof of each class of concrete placed each day. Smaller pours shall have cylinders taken as directed by the County.
- F. One slump test will be taken for each set of test cylinders taken.

1.04 REFERENCES

- A. ASTM C33 - Concrete Aggregates
- B. ASTM C150 - Portland Cement
- C. ACI 318 - Building Code Requirements for Reinforced Concrete
- D. ASTM C260 - Air Entraining Admixtures for Concrete
- E. ASTM C94 - Ready-Mixed Concrete
- F. ACI 304 - Recommended Practice for Measuring, Mixing, Transporting and Placing Concrete
- G. ACI 305 - Recommended Practice for Hot Weather Concreting

PART 2 PRODUCTS

2.01 CONCRETE MATERIALS

- A. Cement: Moderate-Type II, High early strength-Type III, Portland type, ASTM C150.
- B. Fine and Coarse Aggregates: ASTM C33.
- C. Water: Clean and free from injurious amounts of oil, alkali, organic matter, or other deleterious material.

2.02 ADMIXTURES

- A. Air Entrainment: ASTM C260.
- B. Chemical: ASTM C494 Type A - water reducing admixture.

2.03 ACCEPTABLE MANUFACTURERS

Acceptable Products:

1. Pozzolith
2. WRDA

2.04 ACCESSORIES

Non-shrink grout: Premixed compound consisting of non-metallic aggregate, cement, water reducing and plasticizing agents; capable of developing minimum compressive strength of 2400 psi in 2 days and 7000 psi in 28 days.

2.05 CONCRETE MIXES

- A. Mix concrete in accordance with ASTM C94.
- B. Provide concrete of following strength:
 1. Required concrete strengths as determined by 28 day cylinders shall be as shown on the Drawings, but shall not be less than 3000 psi.
 2. Select proportions for normal weight concrete in accordance with ACI 301 3.8 Method 1, Method 2, or Method 3. Add air entraining agent to concrete to entrain air as indicated in ACI 301 Table 3.4.1.
 3. All mixes shall be in accordance with FDOT Specifications.
- C. Use set-retarding admixtures during hot weather only when accepted by County.
- D. Add air entraining agent to concrete mix for concrete work exposed to exterior.

2.06 FORMS

- A. Forms shall be used for all concrete masonry, including footings. Form shall be so constructed and placed that the resulting concrete will be of the shape, lines, dimensions, appearance and to the elevations indicated on the Drawings.
- B. Forms shall be made of wood, metal, or other approved material. Wood forms shall be constructed of sound lumber or plywood of suitable dimensions, free from knotholes and loose knots; where used for expose surfaces, boards shall be dressed and matched. Plywood shall be sanded smooth and fitted with tight joints between panels. Metal forms

shall be of an approved type for the class of work involved and of the thickness and design required for rigid construction.

- C. Edges of all form panels in contact with concrete shall be flush within 1/32-inch and forms for plane surfaces shall be such that the concrete will be plane within 1/16-inch in four feet. Forms shall be tight to prevent the passage of mortar and water and grout.
- D. Forms for walls shall have removable panels at the bottom for cleaning, inspection and scrubbing-in of bonding paste. Forms for walls of considerable height shall be arranged with tremies and hoppers for placing concrete in a manner that will prevent segregation and accumulation of hardened concrete on the forms or reinforcement above the fresh concrete.
- E. Molding or bevels shall be placed to produce a 3/4-inch chamfer on all exposed projecting corners, unless otherwise shown on the Drawings. Similar chamfer strips shall be provided at horizontal and vertical extremities of all wall placements to produce "clean" separation between successive placements as called for on the Plans.
- F. Forms shall be sufficiently rigid to withstand vibration, to prevent displacement or sagging between supports and constructed so the concrete will not be damaged by their removal. The Contractor shall be entirely responsible for their adequacy.
- G. Forms, including new pre-oiled forms, shall be oiled before reinforcement is placed, with an approved nonstaining oil or liquid form coating having a non-paraffin base.
- H. Before form material is re-used, all surfaces in contact with concrete shall be thoroughly cleaned, all damaged places repaired, all projecting nails withdrawn, all protrusions smoothed and in the case of wood forms pre-oiled.
- I. Form ties encased in concrete shall be designed so that after removal of the projecting part, no metal shall be within 1-inch of the face of the concrete. That part of the tie to be removed shall be at least 1/2-inch diameter or be provided with a wood or metal cone at least 1/2-inch in diameter and 1-inch long. Form ties in concrete exposed to view shall be the cone-washer type equal to the Richmond "Tyscru". Throughbolts or common wire shall not be used for form ties.

PART 3 EXECUTION

3.01 PLACING CONCRETE

- A. Place concrete in accordance with ACI 304.
- B. Notify County minimum 24 hours prior to commencement of concreting operations.
- C. Verify anchors, seats, plates and other items to be cast into concrete are placed, held securely and will not cause hardship in placing concrete. Rectify same and proceed with work.
- D. Maintain records of poured concrete items. Record date, location of pour, quantity, air temperature and test samples taken.
- E. Ensure reinforcement, inserts, embedded parts, formed expansion and contraction joints are not disturbed during concrete placement.

- F. Prepare previously placed concrete by cleaning with steel brush and applying bonding agent. Apply bonding agent in accordance with manufacturer's recommendations.
- G. Pour concrete continuously between predetermined construction and control joints. Do not break or interrupt successive pours such that cold joints occur.
- H. In locations where new concrete is dowelled to existing work, drill holes in existing concrete, insert steel dowels and pack solidly with non-shrink grout.
- I. Excessive honeycomb or embedded debris in concrete is not acceptable. Notify County upon discovery.
- J. Conform to ACI 305 when concreting during hot weather.

3.02 SCREEDING

Screed surfaces level, maintaining flatness within a maximum deviation of 1/8" in 10 feet.

3.03 PATCHING

Allow County to inspect concrete surfaces immediately upon removal of forms. Patch imperfections as directed. All patching procedures shall be submitted to and approved by the County prior to use.

3.04 DEFECTIVE CONCRETE

- A. Modify or replace concrete not conforming to required lines, details and elevations.
- B. Repair or replace concrete not properly placed resulting in excessive honeycomb and other defects. Do not patch, fill, touch-up, repair, or replace exposed architectural concrete except upon express direction of County for each individual area.

3.05 CONCRETE FINISHING

Provide concrete surfaces to be left exposed, columns, beams and joists with smooth rubbed finish.

3.06 CURING AND PROTECTION

Beginning immediately after placement, protect concrete from premature drying, excessively hot or cold temperatures and mechanical injury. Maintain concrete with minimal moisture loss at relatively constant temperature for a period of 7 days or until concrete strengths reaches 75% of the 28 day design strength.

Protection against moisture loss may be obtained with spray on curing compounds or plastic sheets. Protection against heat or cold may be obtained with insulated curing blankets or forms.

3.07 CONCRETE DRIVEWAY RESTORATION

Concrete driveways shall be restored with 6 inches of 3,000 psi concrete with W2.5 X W2.5, 6X6 wire mesh. Place ½ inch expansion joint between back of curb and new concrete. Area beneath restoration shall be mechanically tamped prior to placing concrete.

3.08 CONCRETE SIDEWALK RESTORATION

Concrete sidewalks across driveways shall be restored with 6 inches of 3,000 psi concrete with W2.5 X W2.5, 6X6 wire mesh. Place ½ inch expansion joint between back of curb and new concrete. Area beneath restoration shall be mechanically tamped prior to placing concrete.

Concrete sidewalks outside of driveways shall be restored with 4 inches of 3,000 psi concrete per FDOT Design Standards, Sections 522 & 310

END OF SECTION

SECTION 03350 CONCRETE FINISHES

PART 1 GENERAL

1.01 SCOPE OF WORK

Furnish all labor, materials, equipment and incidentals required to finish cast-in-place concrete surfaces as specified herein.

1.02 SUBMITTALS

Submit to the County as provided in the Contract Documents, the proposed chemical hardener manufacturer's surface preparation and application procedures.

1.03 SCHEDULE OF FINISHES

- A. Concrete for the Project shall be finished in the various specified manners either to remain as natural concrete or to receive an additional applied finish or material under another Section.
- B. The base concrete for the following conditions shall be finished as noted and as further specified herein:
 - 1. Exterior, exposed concrete slabs and stairs - broomed finish.
 - 2. Interior, exposed concrete slabs - steel trowel finish.
 - 3. Concrete on which process liquids flow or in contact with sludge - steel trowel finish.
 - 4. Concrete where not exposed in the finished work and not scheduled to receive an additional applied finish or material - off-form finish.
 - 5. Provide concrete surfaces to be left exposed such as walls, columns, beams and joists with smooth rubbed finish.

1.04 RESPONSIBILITY FOR CHANGING FINISHES

- A. The surface finishes specified for concrete to receive additional applied finishes or materials are the finishes required for the proper application of the actual products specified under other Sections. Where different products are approved for use, it shall be the Contractor's responsibility to determine if changes in finishes are required and to provide the proper finishes to receive these products.
- B. Changes in finishes made to accommodate product different from those specified shall be performed at no additional cost to the County. Submit the proposed new finishes and their construction methods to the County for approval.

PART 2 PRODUCTS

2.01 MATERIALS

- A. Portland cement and component materials required for finishing the concrete surfaces shall be as specified in the Contract Documents.
- B. Hardener shall be Lapidolith as manufactured by Sonneborn Building Products or approved equal. Hardener shall be used on all floors, stair treads and platforms.

PART 3 EXECUTION

3.01 FORMED SURFACES

- A. Forms shall not be stripped before the concrete has attained a strength of at least 50 percent of the ultimate design strength. This is equivalent to approximately five "100 day-degrees" of moist curing.
- B. Care shall be exercised to prevent damaging edges or obliterating the lines of chamfers, rustications, or corners when removing the forms or doing any work adjacent thereto.
- C. Clean all exposed concrete surfaces and adjoining work stained by leakage of concrete, to the satisfaction of the County.
- D. Off-form finish. Fins and other projections shall be removed as approved. Tie cone holes and other minor defects shall be filled with non-shrink grout specified under the Contract Documents.

3.02 FLOORS AND SLABS

- A. Floors and slabs shall be screeded to the established grades and shall be level with a tolerance of 1/8-inch when checked with a 10 foot straight edge, except where drains occur, in which case floors shall be pitched to drains as indicated. Failure to meet either of above shall be cause for removal, grinding, or other correction as approved by the County.
- B. Following screeding as specified above, power steel trowel as follows:
 - 1. Immediately after final screeding, a dry cement/sand shake in the proportion of 2-sacks of portland cement to 350-pounds of coarse natural concrete sand shall be sprinkled evenly over the surface at the rate of approximately 500 pounds per 1,000 square feet of floor. Neat, dry cement shall not be sprinkled on the surface. This shake shall be thoroughly floated into the surface with an approved disc type power compacting machine weighing at least 200 pounds if a 20-inch disc is used or 300 pounds if a 24-inch disc is used (such as a "Kelly Float" as manufactured by the Weisner-Rapp Corporation of Buffalo, New York). A mechanical blade-type float or trowel is not acceptable for this work.
NOTE: This operation (application of the cement/sand shake) may be eliminated at the discretion of the County if the base slab concrete exhibits adequate fattiness and homogeneity.
 - 2. In lieu of power steel troweling, small areas as defined by the County shall be compacted by hand steel troweling with the dry cement/sand shake as ordered.
 - 3. The floor or slab shall be compacted to a smooth surface and the floating operation continued until sufficient mortar is brought to the surface to fill all voids. The surfaces shall be tested with a straight edge to detect high and low spots which shall be eliminated.
 - 4. Compaction shall be continued only until thorough densification is achieved and a small amount of mortar is brought to the surface. Excessive floating shall be avoided.
- C. After Paragraph 3.02 A and B procedures are accomplished, floors and slabs for particular conditions shall be completed as scheduled in one of the following finishes:
 - 1. Wood float finish. Hand wood float, maintaining the surface tolerance to provide a

- grained, nonslip finish as approved.
 - 2. Broomed finish. Hand wood float maintaining the surface tolerance and then broom with a stiff bristle broom in the direction of drainage to provide a nonslip finish as approved.
 - 3. Steel trowel finish. Hand steel trowel to a perfectly smooth, hard even finish free from high or low spots or other defects as approved.
- D. Floors, stair treads and platforms shall be given a floor hardener. Application shall be according to manufacturer's instructions.

3.03 APPROVAL OF FINISHES

- A. All concrete surfaces will be inspected during the finishing process by the County.
- B. Surfaces which, in the opinion of the County, are unsatisfactory shall be refinished or reworked until approved by the County.

END OF SECTION

SECTION 03410 PRECAST CONCRETE STRUCTURES

PART 1 GENERAL

1.01 SCOPE OF WORK

- A. The Contractor shall furnish all materials, labor and equipment and construct valve vaults, meter vaults, concrete pipe and accessory items, consisting of precast sections as shown on the Drawings and as specified herein.
- B. The forms, dimensions, concrete and construction methods shall be approved by the County in advance of construction.
- C. These Specifications are intended to give a general description of what is required, but do not purport to cover all of the structural design details which will vary in accordance with the requirements of the plans. It is, however, intended to cover the furnishing, shop testing, delivery and complete installation of all precast structures whether specifically mentioned in these Specifications or not.
- D. The supplier of the precast items shall coordinate his work with that of the Contractor to insure that the units will be delivered and installed in the excavation provided by the Contractor, in accordance with the Contractor's construction schedule.
- E. The Contractor will ensure coordination of the precast structures fabrication with the supplier to achieve the proper structural top slab openings, spacings and related dimensions for the selected equipment frames and covers. The top slabs, frames, covers, and subsurface structures outside of roadways shall be capable of live load of 300 pounds per square foot unless noted otherwise.
- F. All interior surfaces of valve vaults and meter vaults shall be painted with two coats of coal tar epoxy paint dry film thickness of 8-mils each coat, as approved by the County.

1.02 SUBMITTALS

- A. Submit to the County in accordance with the Contract Documents, shop drawings showing details of construction, reinforcing, and joints.
- B. Shop Drawings
 - 1. Content
 - a. Dimensions and finishes.
 - b. Estimated camber.
 - c. Reinforcing and connection details.
 - d. Lifting and erection inserts.
 - e. Other items cast into members.
 - 2. Show location of unit by same identification mark placed on member.
 - 3. Include design calculations.
- C. Manufacturer's Literature: Manufacturer's recommended installation instructions.
- D. Manufacturer's certificates of material conformance with Specifications.
- E. Test Reports: Reports of tests on concrete. A minimum of three compression test cylinders will be required for each pour.

1.03 INSPECTION

- A. The quality of all materials, the process of manufacture and the finished sections shall be subject to inspection and approval by the County, or other representatives of the County. Such inspection may be made at the place of manufacture, or at the site after delivery, or at both places and the sections shall be subject to rejection at any time due to failure to meet any of the Specification requirements; even though sample sections may have been accepted as satisfactory at the place of manufacture. Sections rejected after delivery to the project site shall be marked for identification and shall be removed from the project site at once. All sections, which have been damaged after delivery will be rejected and if already installed, shall be acceptably repaired, if permitted, or removed and replaced entirely at the Contractor's expense.
- B. At the time of inspection, the sections will be carefully examined for compliance with the applicable ASTM designation and these Specifications and with the approved manufacturer's drawings.
1. All sections shall be inspected for general appearance, dimension, "scratch-strength", blisters, cracks, roughness, soundness, etc. The surface shall be dense and close-textured.
 2. All sections shall meet the manufacturing tolerance requirements of ASTM C-478 or the following casting tolerances, whichever are more severe:

| | |
|------------------|------------|
| Wall Thickness | $\pm 3/8"$ |
| Inside Diameter | $\pm 3/8"$ |
| Outside Diameter | $\pm 1/2"$ |
| Height or Length | $\pm 3/8"$ |
- C. Imperfections may be repaired, subject to the approval of the County, after demonstration by the manufacturer that strong and permanent repairs result. Repairs shall be carefully inspected before final approval. Cement mortar used for repairs shall have a minimum compressive strength of 4,000 psi at the end of 7 days and 5,000 psi at the end of 28 days, when tested in 3-inch by 6-inch cylinders stored in the standard manner. Epoxy mortar may be utilized for repairs subject to the approval of the County.

PART 2 PRODUCTS

2.01 PRECAST CONCRETE SECTIONS

- A. Precast concrete manhole grade rings, flat slab tops, conical tops, risers and base sections shall be fabricated in accordance with the material and design standards of ASTM C478, except as modified herein.
- B. Portland cement shall conform to ASTM C150, Type II, and concrete shall have a minimum compressive 28-day strength of 4,000 psi.
- C. The manufacturer shall make a minimum of four standard test cylinders for each 100 cubic yards of concrete (or part thereof) that is cast each day. These test cylinders, along with sections cast that day, shall be marked in such a way that the test results can be matched with the appropriate castings. Two cylinders shall be cured with the product until the forms are stripped. At this time, one cylinder shall be broken to ascertain that a minimum strength

of 2000 psi has been reached prior to moving the product from the forming location. The remaining two cylinders shall be cured and tested in accordance with ASTM C192 and C39. The average compressive strength for each day's production shall be greater than 4000 psi with no more than 10% of the tested cylinders falling below 4000 psi. In no case shall any cylinder strength fall below 3500 psi. All cylinder strengths shall be certified by a Florida Licensed Professional Engineer. Failure to meet these requirements for any day's production is cause for rejection of all sections cast that day.

- D. Minimum wall thickness for manholes shall be 8 inches or 1/12 the inside diameter of the manhole, whichever is greater. The minimum thickness for the bottom of the base section shall be 8 inches.
- E. Reinforcing steel shall be as specified in ASTM C478.
- F. Precast manhole structures shall be free of cracks, holes, voids, blisters or rough surfaces. Manholes shall be water-tight, and shall be generally sound and free of defects of any sort. Lift holes shall not penetrate through the wall of any manhole tops, risers or base sections. Holes passing part-way through the manhole section walls for lifting devices shall be filled with cement or epoxy grout after the manhole has been set in place.
- G. Pipe openings shall meet the recommended tolerances of the individual manufactured pipe to manhole connectors; however, the horizontal location shall be within +/- 2 degrees of arc of that detailed on the shop drawings.

2.02 MANHOLE INVERTS

- A. Benched inverts shall be provided and shall be monolithically cast or shall be a secondary casting in a cured base section as per ASTM C478.
- B. The width of the invert channel shall be the same as the inside diameter of the connected sewer pipes and shall have a "U" - shaped cross-section with the bottom of the channel shaped to correspond with the lower half of the pipe. The depth of the channel shall be a minimum of half the inside diameter of the connected pipes.
- C. The channel shall be formed smooth and streamlined, and, where the flow changes directions, shall have true curves of the largest radius possible within the manhole base. The maximum change of direction of flow within a manhole shall be 90 degrees.
- D. The channel invert slope shall be uniform through the manhole and shall have a minimum vertical drop of 1 inch from the inlet(s) to the outlet.
- E. For all manholes with pipes 16 inches in diameter and larger, the base section and invert channels shall have a pre-molded plastic liner as described in subsection 1.12.6, "Concrete Manholes and Wetwells with Protective Liners."

2.03 RESILIENT PIPE CONNECTORS

- A. Connections of manholes to pipes shall be made using resilient boot or seal connectors manufactured in accordance with ASTM C923 and shall maintain a resilient, hydrostatic seal between the pipe and the connector and between the connector and the manhole structure.

- B. Connectors shall be installed in strict accordance with the written installation instructions of the manufacturer. Non-shrink grout shall be placed in the gap between the boot or seal and the manhole invert channel, to make a smooth transition, unless otherwise directed by the manufacturer's instructions.

2.04 MANHOLE AND WETWELL JOINTS

- A. Joints between manhole sections and wetwell sections shall be modified tongue and groove, or modified bell and spigot, with a continuous elastomeric ring gasket (o-ring) joint conforming to the requirements of ASTM C443. In addition to the ring gasket, an additional sealing device shall be provided as follows:
 - (1) A minimum of six-inches wide of Rub'R-Nek RU116 elastomeric based plastic joint wrap shall be centered over the joint, on the outside of the manhole, or
 - (2) A minimum of ½-inch x ¾-inch bead of Adeka Ultra Seal P-201 hydrophilic urethane paste applied to the interior of the joint just before manhole section assembly.
- B. In addition to the requirements in subsection A, above, all joints between manhole sections, for manholes receiving turbulent flow and wetwells with a liner, shall also have a continuous strip of liner material that is a minimum of 6 inches wide weld-fused all around the inside face of the joint, per manufacturer's recommendations, or they shall have the joint filled at the inside face with a butyl rubber sealant meeting Fed. Spec A-A-272B to form a bead across the joint, so that no bare concrete inside the joint is left exposed.
- C. For standard manholes without liners, fill the joint at the inside face with non-shrink grout and strike the joint smooth and uniform with the manhole interior walls.
- D. For manholes with and without plastic liners and with concrete grade-adjustment rings, joints between the top section and the grade ring, and between grade rings, and between the grade ring and the cast iron ring frame shall be made with non-shrink cement mortar.

2.05 CONCRETE MANHOLES AND WETWELLS WITH PROTECTIVE LINERS

- A. Drop manholes, manholes with opposing flows, manholes immediately upstream of a lift station wetwell, manholes with gravity sewers greater than 12 inches in diameter, force main termination manholes and the first two manholes downstream from a force main termination manhole, and pumping station wetwells shall have a full plastic liner. The liners shall be integrally cast into the concrete tops, risers and base sections, which shall be in all other respects manufactured in accordance with ASTM C478 using Type II Portland Cement per ASTM C150. The plastic liner shall be generally chemically resistant to the wastewater environment and shall be mechanically affixed to the precast concrete manhole sections so that there can be no separation of the liner from the manhole sections during the service lifetime.
- B. The plastic liner shall have no surface degradation when exposed to nitric acid, hydrochloric acid, ammonia, sodium hydroxide, sulfuric acid, acetone, unleaded gasoline and turpentine in accordance with test method ASTM D1308, and shall not be attacked when immersed in acetone according to test method ASTM D2152.
- C. The manhole liner shall be FRP GU Liners, as manufactured by GU Florida or an approved equal. The base liner for manholes shall have preformed flow channels with water-tight gasketed pipe bell connections or boot holes that extend to the outside profile of the precast

concrete structure. FRP GU, HDPE AGRU, or PVC DURA-PLATE liners shall be installed with the remaining sections, including the cone section of the manhole.

- D. The wall thickness for manholes and wetwells with liners, including the liner thickness, shall be 8 inches minimum or 1/12 of the inside diameter, whichever is greater. The minimum thickness of the bottom of the base section shall be 8 inches under the bottom of the flow channel.
- E. Manhole cast iron frames shall be adjusted to grade with concrete grade rings same as for un-lined manholes. Lined manholes shall be equipped with a GU Liner Convertible Collar as manufactured by GU Florida or an approved equal. The collar shall form a water-tight seal to the manhole top with a GU Lip Seal rubber gasket, or approved equal. The collar shall be sealed water-tight against the base of the cast iron frame using a butyl rubber sealant.

2.06 MANHOLE RINGS AND COVERS

Rings and covers shall be gray iron castings, conforming to ASTM A48, Class 30B, and shall be pattern USF 170-CE-1, as manufactured by U.S. Foundry, with the words "MANATEE COUNTY", "SANITARY SEWER", and "(YEAR)" cast into them. Frame and cover castings shall be dense and even grained, and shall be free of blowholes, warping, or any other defects not true to pattern. Seating surfaces of covers and frames shall be machined true to prevent rocking. Castings shall be designed and tested to bear an AASHTO H-20 wheel loading with and added 30 percent impact factor and shall be Class Heavy Duty traffic bearing.

2.07 MANHOLE INSERTS

Watertight manhole inserts shall be stainless steel and are required for all sanitary sewer manholes installed. Neoprene gaskets shall be installed under the insert lip to insure a leak proof seal.

2.08 PRECAST CONCRETE MANHOLE INSTALLATION

- A. Manholes shall be installed at the end of each line; at all change in grade, size, or alignment; at all intersections; and at distances not greater than 400 feet for sewers 15 inches or less and 500 feet for sewers 18 inches or larger. Cleanouts may be used only for special conditions with approval by the County and shall not be substituted for manholes.
- B. Drop manholes shall be provided for sewers entering a manhole at an elevation 24 inches or more above the manhole lowest invert. Where the drop is less than 24 inches, the invert shall have an elevated U-channel to prevent solids deposition. Drop manholes shall be constructed with an outside drop connection and the entire outside drop connection shall be encased in concrete.
- C. Precast concrete sections shall be set vertical and in true alignment as indicated by the construction plans. Excavation, bedding foundation and backfill shall be done in accordance with the Trenching and Excavation section of these Standards. All manholes shall meet the following installation tolerances:
 - 1. The finished manholes shall not be out of plumb by more than 3/8 inch per 10 feet of height.
 - 2. Any jog or offset of the inside wall surface at a joint shall not exceed 1/2 inch.

3. Variation in the joint width around the circumference of the manhole shall not exceed 1/4 inch.

2.09 SETTING MANHOLE RINGS

Manhole rings and covers shall be set to conform accurately to the finished ground or pavement grade as indicated on the construction drawings or as directed by the County. Rings on manholes shall be set concentric with the adjusting rings and sealed so that the space between the top of the adjustment rings and the bottom flanges of the rings will be made watertight. A ring of mortar shall be placed around the outside of the bottom flange at least one inch thick and pitched to shed water away from the frame. Mortar shall be extended to the outer edge of the masonry and finished smooth and flush with the top of the flange.

2.10 SPRAY-APPLIED MANHOLE LINERS

Existing concrete or brick and mortar manhole structures that are to be modified or rehabilitated by adding a manhole liner shall have a spray-applied liner installed according to the material and procedural requirements of the "Modifications to Existing Structures, Piping and Equipment," Section 1.2 of this Manual. All recommendations of the product's manufacturer shall be followed.

2.11 PROTECTION FROM FLOODWATER INFLOW

Wastewater sewer systems shall be designed to prevent flood or surface waters from entering the collection system. Manhole rims and clean-out tops shall be elevated 4 inches above the 100-year flood level, or 8 inches above the 25-year flood level, or 4 inches above the surrounding unpaved ground surface within a 20-foot radius, whichever is highest, or the manhole covers and clean-out lids shall be designed and installed with factory-made watertight, tamper proof, sealing devices. Manholes with rims less than the above required elevations shall be PAMTIGHT as manufactured by CertainTeed, or equal as approved by Manatee County.

Cleanouts not at or above the required elevations shall have the clean-out adapter solvent welded watertight to the clean-out riser. Plugs are to be recessed square key with Teflon plumber's tape wrapped on threads to make a watertight seal.

PART 3 EXECUTION

3.01 INSTALLATION

- A. The Contractor shall be responsible for handling ground water to provide firm, dry subgrade for the structure, shall prevent water rising on new poured-in-place concrete or grouted joint sections within 24 hours after placing and shall guard against flotation or other damage resulting from ground water or flooding.
- B. A minimum of an 8-inch shell base compacted layer of washed shell or crushed stone shall be placed as a foundation for the structure's base slabs and valve and/or meter vault pits.
- C. Backfill materials around the structures and above the pipe bedding shall be select material as specified in the Contract Documents.
- D. Precast bases, conforming to all requirements of ASTM C478 and above listed requirements for precast sections, may be used.
- E. The structure shall not be set into the excavation until the installation procedure and

excavation have been approved by the County.

- F. The base may be cast-in-place concrete placed on a thoroughly compacted crushed rock subbase, (98 percent of the maximum density as determined by AASHTO T-180. The tops of the cast-in-place bases shall be shaped to mate with the precast barrel section and shall be adjusted in grade so that the top slab section is at the approximately correct elevation.
- G. Precast concrete structure sections shall be set so as to be vertical and with sections in true alignment with a 1/4-inch maximum tolerance to be allowed. The joints shall be prepared as in 2.04 above and finished flush with the adjoining surfaces. Allow joints to set for 24 hours before backfilling. Backfilling shall be done in a careful manner, bringing the fill up evenly on all sides. The Contractor shall install the precast sections in a manner that will result in a watertight joint. Leaking joints are not acceptable.
- H. Holes in the concrete sections required for handling or other purposes shall be plugged with a non-shrink grout or by grout in combination with concrete plugs.
- I. Where holes must be cut in the precast sections to accommodate pipes, cutting shall be done prior to setting them in place to prevent any subsequent jarring which may loosen the mortar joints.
- J. Frames and hatches specified and furnished shall be cast in the cover slab prior to setting. Normal installation shall include 6" to 12" of concrete grade rings between the top of the cone section and the cover plate ring slab.

ASTM A48-74, or most recent revision, Specification for Gray Iron Castings, Class 30 or Grade 60-45-10 Ductile Iron meeting the requirements of ASTM A536-72, or most recent revision, Specification for Ductile Iron Castings. Cast in a true symmetrical pattern of tough, dense and even grained iron, free from warping, scales, lumps, blisters, sandholes, or any defects of any kind. Provide indented pattern lids with lettering as shown on the Drawings. Machine or grind frames and lids at touching surfaces to provide firm seats and prevent rocking. Remove and replace any set not matching perfectly. All frames and covers shall be designed to withstand an HS20-44 wheel loading as defined by AASHTO specifications.

- K. Manhole inserts: Watertight manhole inserts shall be 316 stainless steel and are required for all sanitary sewer manholes installed. Inserts shall be as manufactured by FRW Industries, Conroe, Texas, or approved equal. Neoprene gaskets shall be installed under the insert lip to insure a leakproof seal.
- L. Penetrations and connections into precast or existing structures shall be accomplished by rotary core boring.
- M. Cast in place liners shall be repaired, fitted around penetrations, sealed at joints, etc. in accordance with the manufacturer's recommendations for that liner. As a general rule, repairs, sleeves and patches shall be welded in place, glues and sealants shall not be used unless approved by the manufacturer.

3.04 TESTING

- A. After constructed to its finished height and before being backfilled, each manhole must be visually inspected and shall meet the satisfaction of the County.
- B. If the visual inspection reveals defects, poor workmanship, or suspect installation, it shall

be at the sole discretion of the County to have the structure vacuum tested for water tightness.

1. Plug pipelines and perform vacuum test. Observing all recommended safety measures induce a backpressure of 5.0 p.s.i. equivalent to 10" Hg (mercury). The manhole assembly is considered satisfactory if the vacuum loss is less than 1" Hg for the length of time listed in the following table:

| Time of Test in Seconds | | | |
|-------------------------|--------------------------|-----|----|
| Depth Feet | Manhole Diameter in Feet | | |
| | 4 | 5 | 6 |
| 4 | 10 | 13 | 16 |
| 8 | 20 | 26 | 32 |
| 12 | 30 | 39 | 48 |
| 16 | 40 | 52 | 64 |
| 20 | 50 | 65 | 80 |
| 24 | 60 | 78 | 96 |
| T | 5 | 6.5 | 8 |

Note: Add "T" seconds for each additional 2'- of depth.

- C. Failure to pass this test requires the Contractor to correct the problems and retest. The Contractor will replace leaking gaskets and/or concrete sections and retest the completed manhole. No manhole will be accepted without successfully passing this test.

END OF SECTION

SECTION 03500 LIFT STATION SPECIFICATION

PART 1 GENERAL

Furnish all labor, materials, equipment and incidentals required to install complete automatic, underground lift stations with all required equipment installed in a concrete wet well and adjacent above-ground valve assembly (and meter). The principal items of equipment shall include two submersible motor-driven sewage pumps, valves, internal piping, automatic pumping level controls, control panel and telemetry. All materials shall be new, without defects and of the best quality. All materials furnished and all work done shall be in strict accordance with the National Electrical Code and all local requirements and codes.

All lift stations that re-pump sewage from four (4) other upstream lift stations or has a discharge flow 500 gpm or greater shall have an on-site back-up diesel pump equipped with a transducer level controls, and backup float switches. Re-pump station may require an in-line submersible magnetic flow meter (as determined by County), and a force main pressure transducer. Onsite full tanks shall not exceed 540 gallons.

Alternatively, at the discretion of the County, an electric generator equipped with an automatic power transfer switch may be installed.

1.01 STRUCTURES AND EQUIPMENT

A. Pump Station Wetwell.

All wetwells 6 feet diameter and larger, and all pump stations that are owned and maintained by Manatee County, shall be precast concrete with a full protective liner, in accordance with section 1.12, designed to accommodate the peak hour development flow from all contributing areas. The wetwell shall have a minimum of 4 feet from the lowest invert to the wetwell bottom. The pump station wetwell size shall be determined using the following formula to determine the minimum volume between the off-level elevation and the influent invert elevation:

$$\text{MIN. VOLUME (GALS.)} = \text{PUMP CAPACITY (G.P.M.)} \times 4$$

Wetwell diameters shall be 6 feet or larger. 4-foot and 5-foot diameter wetwells shall be used only for special grinder pump applications as approved by the County on a case-by-case basis. The minimum wall thickness for concrete wetwells with liners shall be as follows:

| <u>DIAMETER</u> | <u>WALL THICKNESS</u> | <u>DIAMETER</u> | <u>WALL THICKNESS</u> |
|-----------------|-----------------------|-----------------|-----------------------|
| 4' - 0" | 8" | 8' - 0" | 8" |
| 5' - 0" | 8" | 10' - 0" | 10" |
| 6' - 0" | 8" | 12' - 0" | 12" |

The pump station wetwell size and control equipment shall be designed to limit the pumping cycles of each pump to a maximum of 5 starts per hour for duplex stations and 3 starts per hour for triplex stations. Pump stations discharging through pipes 12 inches or larger shall have more than two variable speed pumps. The pump cycle off level shall be no lower than the top of the sewage pumps. The lead pump on level shall be no higher than 18 inches below the invert elevation of the influent pipe for duplex stations, and no higher than 24 inches below the invert for triplex stations.

All pump stations shall have a single gravity-flow influent pipe discharging into the wetwell. Multiple gravity pipelines and force mains upstream shall all terminate at a separate manhole before flowing into the pump station wetwell. The influent gravity sewer shall be aligned, so that the inflowing stream drops into the front side of the wet well opposite from the riser side, within an angle of 25 degrees on either side of the centerline passing between both pumps in a duplex station, or between two of the three pumps in a triplex station. As an option to the to the influent gravity sewer main entering the wetwell directly between the pumps, a plastic composite/fiberglass drop bowl and pipe (Reliner/Duran, Inc. or equal) shall be installed, as shown on Detail US-20.

B. Above-ground Valve Assembly

An above-ground valve assembly and concrete pad with three gate valves, two weighted lever swing check valves, and a pump-out connection shall be constructed adjacent to the wet well. Tri-plex stations have four gate valves and three check valves. The pump-out connection shall be equipped with a gate valve and an male aluminum quick-coupler; 4-inch for 4 inch or smaller valve assemblies; 6 inch for all others, unless otherwise specified on the plans. All valves shall have factory applied, fusion bonded epoxy coating on interior and exterior. All bolt, nuts & washers in or on the wet well or valve assembly shall be 316 stainless steel

C. A precast meter vault for a single submersible magnetic flow meter may be required following the valve assembly. It shall also have a 3-inch PVC drain installed at a 2 percent slope and with a P-trap installed inside the wet well. The meter vault shall be of adequate size to allow a minimum 18 inches clearance between all flange fittings and any concrete surfaces.

D. Entrance Hatches

The lift station wetwell and/or meter vault shall be equipped with an aluminum access cover of adequate size to permit easy removal and installation of sewage pumps and equipment. The wetwell access cover shall be a minimum 36" x 48" single (preferred) or double door. The meter valve pit access cover shall be a minimum 48" x 48" double door. All access covers shall be constructed of aluminum with a minimum load rating of 300 lbs/sq. ft. and equipped with stainless steel hinges, a recessed lifting handle which lies flush with the door surface, and a stainless steel staple which may be used to secure the door with a padlock when closed. The doors shall have a raised diamond thread pattern to provide a skid resistant surface and shall open to 90 degrees and lock automatically in that position, with a handle to release the doors for closing. The hatch assemblies shall be as manufactured by U.S. Foundry, Halliday, or an approved equal.

E. Sewage Pump Assemblies

Each pumping station shall have a minimum of two identical, totally submersible sewage pump assemblies which are rated and suitable for continuous duty, underwater operation. These units and their associated power and signal cables shall have watertight integrity to a depth of 65 feet. The pump, pump motor and associated components shall all be the products of the same manufacturer. Pump assemblies shall be painted after assembly with an approved air dry enamel which will adequately protect the exterior housings from the corrosive environment in the wastewater sewer system. Coating thickness shall be a minimum of 4 mils.

Factory testing of the pump assemblies shall be required and as a minimum, shall include:

- (1) All tests recommended by the manufacturer.
- (2) Verify the integrity of assembly and connections (no leaks, tightness of hardware, proper alignment, assembly, etc.) and that the nameplate and specified pump and pump motor (HP, Voltage, Phase and HZ) correspond.
- (3) The motor windings and seal housing chambers shall be hi-potted to test for insulation defects and moisture content. Check the resistance of the stator windings with a bridge to verify that the readings of all three phases are basically equal and within tolerance.
- (4) Energize pump motor, verify direction of rotation and that it corresponds to the nameplate.
- (5) Provide a written report of all testing with the shipped pump.

All pump assemblies shall be warranted against defects in workmanship and materials for whichever is the greater of: a 5-year pro-rated warranty from the date of purchase or as provided in the Defect Security Agreement with the County.

Month 0 -18 = 100% Month 19-31 = 75% Month 32-45 = 50% Month 46-60 = 25%

Pump motors shall have the following electrical characteristics: 230 -volt for 20 HP and lower or 460 -volt for greater than 20 HP, 3 phase, 60 hertz, minimum service factor of 1.15, continuous duty, maximum NEMA LRA/HP code of J, and NEMA Design B. Pump motors shall be non-overloading throughout the entire range of operation. The pump motors are to be induction motors which are built with moisture resistant Class F insulation. Each motor shall be capable of a minimum of 10 starts per hour without degradation of the windings. The pump motor shaft shall be made from a single, solid, forging of 303 (or better grade) stainless steel, tapered, keyed, and supported by a minimum of one heavy duty upper radial ball bearing and a minimum of one heavy duty lower thrust bearing. The bearings shall have a minimum B-10 life rating of 60,000 hours. The shaft and shaft extension shall be of minimum length and maximum diameter to reduce shaft deflection and prolong bearing life. The pump motor shall be designed for pumping at a maximum sump ambient of 40 degrees C (104 degrees F). The stator of the pump motor shall be copper wound (aluminum stator windings are not permitted) and equipped with at least two heat sensors (klixons installed in the stator end turns) which will shut the motor off in case of excessive heat built up. The heat sensors shall be connected in series with the motor starter coil so the starter is tripped if the heat sensor opens. The pump motor housing shall be oil or air filled type for cooling purposes. Oil filled motors shall use pure dielectric insulating oil. The pump motor shall be capable of operating at +/- 10% of rated voltage and +/- 5% of rated frequency without excessive heating. The pump motor shall not exceed a rise by resistance of 90 degrees C at full load over the entire performance curve. It shall be able to operate intermittently a full load while unsubmerged without damage. Power cables and signal cables shall be continuous (without splices from the pump motor to the power supply). Power cables shall be sized for operation at the rated service factor. The power cable shall be a single, multi-conductor, STW-A type that is epoxy potted and compression fitted for water tight sealing into the pump cable entry. As a minimum, the nameplate for the pump motor shall include: MODEL/SERIAL NUMBER, HORSEPOWER, VOLTAGE, FULL LOAD AMPS, FULL LOAD RPM, PHASES, FREQUENCY, NEMA LRA CODE, NEMA DESIGN, INSULATION CLASS, AMBIENT TEMPERATURE, LEAD CONNECTIONS FOR DIRECTION OF ROTATION, TYPE OF DUTY, TYPE OF BEARINGS, and PUMP IMPELLER SIZE. All electrical components used in or in conjunction with the sewage pump assembly shall be UL approved when UL approval is available for that type component.

The pumps shall be capable of pumping raw, unscreened sewage and able to pass a minimum 3-inch solid. Each pump shall have an enclosed cast iron or ductile iron impeller and shall be equipped with a bronze wear ring. The pump lifting cover, stator housing, and volute casing shall be gray cast iron, ASTM A48, Class 30. Castings shall have smooth surfaces that are devoid of blow holes or other casting defects. The pump lifting bail shall have a minimum of 4-inch diameter clear opening and shall be cast as part of the motor cover or fabricated from 316 stainless steel. All fasteners exposed to raw sewage shall be 316 stainless steel. The backside of the impeller shall have pump-out vanes to keep contaminants out of the seal area. The impeller shall be dynamically balanced, and shall be single - or multi-vaned, with an enclosed or recessed, non-clogging design. There shall be a maximum clearance of .125 inches between the seal housing and the top of the impeller. The pump shall have a minimum of two mechanical seals mounted in tandem with an oil chamber between the two seals. The oil chamber of each pump shall be equipped with an electric seal fail sensor which shall be connected to an indicating light at the control panel to annunciate a seal failure and a set of relay contacts for purposes of remote notification via the County RTU system. The unit shall be designed so that when the outer seal fails, the contaminants that enter shall not enter the bearing housing and cause damage to the bearings. The inner seal shall be replaceable without disassembly of the motor housing and without the need for special tools. As a minimum, the rotating seal faces shall be carbon and the stationary seal faces shall be ceramic. All pumps shall be center-line discharge type constructed so that the discharge flange supports the full weight of the pump. Pump assemblies shall be complete with ductile iron or gray cast iron BPIU discharge base elbows that are bolted directly to a base plate which is bolted directly to the wetwell floor, guide flange adapter and guide rails. The discharge elbow shall have an automatic coupling end facing the pump and an ANSI Class 125 flanged end ready for connection to the flange of the riser pipe. The design of the pump assembly installation shall be such that the pump will be automatically connected to the discharge piping when lowered into place along the guide rails, and shall seal leak-tight to the discharge base elbow by the weight of the pump assembly resting in the installed position. The pump base elbow shall be mounted on an ASTM A588 (COR-TEN) steel mounting plate that is level and is bolted to the wetwell floor using 3/4-inch 316 stainless steel threaded rods with Hilti HVA anchors or approved equal anchors and shall have base ell mounting bolts of 3/4-inch 316 stainless steel that are mounted in place and welded to the plate. The pump guide rails for each pump shall be constructed of two separate whole length sections of 2 inch Schedule 40, 316 stainless steel pipe set 4 inches on center.

The pump assemblies shall be easily removed for inspections or service, requiring no fasteners to be removed or disconnected, and no need for personnel to enter the confined space of the wetwell, by simply hauling up on the lift chains. The lifting chains shall be type 316 stainless steel, and shall be 1/4-inch for pumps less than 10 HP and 3/8-inch for pumps 10 HP and greater, or as required by the pump assembly weight. Chains shall be attached to the pump lifting bails using stainless steel shackles and shall extend to the inside top of the wetwell. All rails and mounting hardware shall be 316 stainless steel.

F. Riser and Fittings

All force main piping and fittings within the wetwell, valve assembly, and the meter vault from the pump base elbow to the check valve, shall be DR11 HDPE, only 90 degree molded HDPE fittings shall be used upstream of the check valves. All connections to iron bodied flange fittings in the wetwell (pump base ells) and to the valve assembly check valves shall be made using HDPE flange adapters with 316 stainless steel backup rings. No iron bodied fittings shall be located between the pump base elbow and the check valves. All HDPE connections shall be thermal fused or electro-fused. Piping from the valve assembly tee to

the first underground fitting shall be ductile iron, after the first underground fitting shall be PVC DR 14 C-900.

All flanged fittings inside the wetwell and valve assembly shall use 316 stainless steel bolts, nuts and washers. All threads shall be treated with Bostik Never-Seez anti-seizing compound or approved equal. All bolts on the flange connection at the pump base ells shall have two nuts with a lock washer between them or a nylon lock nut.

All stainless steel fasteners shall be treated with Never-Seez prior to assembly and torque according to the fitting manufacturer's recommendation. The bands around the piping shall be constructed from a minimum of 1 inch wide by 12 gauge stainless steel strap stock, shaped to fit the piping and sized to grip the piping without deforming the pipe when bolted to the braces.

For wetwells up to 6 feet in diameter and pipe less than 8 inches, the pipe support system shall be constructed using 1 5/8-inch stainless steel channel. For wetwells 8 feet in diameter and larger or pipe 8 inches and larger, the pipe support system shall be constructed using 4-inch stainless steel angle.

G. Hardware

A multi hook stainless steel hanger shall be installed inside the wetwell access opening for supporting the float switches and pump electric cables. The multi hook hanger shall be constructed from 1/4-inch x 2-inch type 316 stainless steel flat stock with individual hooks constructed of 1/4" type 316 stainless steel rod stock. Individual hangers shall be installed on each side of the upper guide rail bracket for each pump to support the pump lifting chain and power cable. The lifting chain hook shall be constructed from 3/8-inch type 316 stainless steel rod stock. The pump power cable hook shall be constructed from 1/4-inch x 1-inch type 316 stainless steel flat stock.

H. Painting and Coating

All paint and other coatings shall be applied in accordance with the product manufacturer's specifications for the surfaces being coated. All iron body valves shall have a factory applied fusion bonded epoxy coating inside and outside. All ductile iron fittings shall have a 40-mil Protecto 401 or equal epoxy on the inside in accordance with manufacturer's specifications and an asphaltic coating on the outside. No field-applied paintings or coatings shall be applied to the valves or fittings.

Stilling Well (where required)

A stilling well may be required, and if so, shall be a 6" PVC stilling well mounted such that the top is available to an open hatch cover. The bottom of the stilling well shall have two 316 stainless steel bolt all the way through both sides, passing through the center of the pipe, approximately 4" from the base of the pipe. It shall have 1/2" diameter holes drilled around the circumference at a rate of one hole per inch of length for at least the full wetted height. All mounting hardware shall be 316 stainless steel.

Magnetic Flow Meter (where required)

A flow meter may be required, and if so, flow meters installed in a separate meter vault shall be rated for continuous submergence, 0.05% accuracy with a polyurethane liner, flush electrodes, FM Class 1, Division 2, Groups A,B,C&D and shall be constructed for a flanged

mount. Meter shall be supplied with a like size spool piece. The exterior control module/transmitter shall be mounted either inside or adjacent to the lift station control panel on the same support structure per the Lift Station Supervisor.

2.01 ELECTRICAL

A. Service and Metering

The Contractor shall be responsible and shall pay for any permits, fees, and inspections required by the local power company for service installations. Three phase power shall be used unless otherwise approved by the County. Service for pump motors of 20 horsepower or smaller shall be 230 volts. For motors greater than 20 horsepower, the service voltage shall be 460. No phase converters will be accepted. All lift stations shall be equipped with a knife-type fused safety switch in a NEMA 4X stainless steel enclosure, lockable in the ON and OFF position, between the service meter and the control panel to permit servicing of the main breaker without removing the service meter. All meter bases shall be aluminum. Minimum service size shall be 100 amp. Conduit connections to the disconnect shall be sealed using Myers conduit hub connectors (disconnect side).

B. Conductors

All power conductors shall be single conductor, 600 volt, type THW or THHN stranded copper. Minimum conductor size shall be #12 AWG. ALUMINUM WIRE IS NOT PERMITTED. All control wiring shall be single conductor #14 AWG, 600 volt, type THHN stranded copper. All terminations and interconnections of control wiring shall be by means of compression-type lugs of the nylon self insulated type with an inner bronze insulation grip sleeve on identified terminal strips. All control wiring shall be color coded as indicated on the standard details.

C. Conduit

All power conductors from the utility source to the service meter shall be enclosed in PVC Schedule 80 conduit below ground and aboveground (NO I.M.C. ALLOWED). All lift stations shall be equipped with one conduit to the wet well for each pump power cables and a separate conduit to the wet well for the control (floatball) and signal cables. In lift stations with large horsepower pumps and pumps equipped with sensor cables, the conduit size and quantity shall be determined by the County. All conduit to the lift station wet well shall be minimum 2" Schedule 80 PVC and shall be run by the shortest route possible. All terminations shall be made inside the electrical control panel. All flexible conduit shall be non-metallic.

D. Control Panel

All pump stations shall have one automatic control panel, one telemetry control unit enclosure with specified TCU with assigned radio frequency and one junction control box for motor control, floats, seal fail and transducer (if required). The control panel will be ordered through Barney's Pump of Lakeland, FL. The telemetry control cabinet will be ordered through Data Flow Systems (DFS), part# DFS-00275-008-04. Specify if 480V 3 phase is needed. Enclosure must be ordered with 'NO' tower mounting brackets.

All cabinets shall be white in color unless specified otherwise.

The Order Numbers and specification are listed below.

Barney's Pumps approved panels by Manatee County

| Part# | STD. FLA | MCB/ECB | PCB | Starter | Size (Starter or OL) | Note: |
|--|--------------|---------|-----|--------------|----------------------|------------------------|
| ManCoCP240_1_3_VFD | 24 (Input) | 100 | 40 | FRN003E1S-7U | N/A | 11A Max Pump FLA (VFD) |
| ManCoCP240_1_5_VFD | 42.7 (Input) | 125 | 70 | FRN010E1S-2U | N/A | 19A Max Pump FLA (VFD) |
| ManCoCP240_3_2_SSC | 8.3 | 100 | 15 | SSR | 3-12A | Solid State Starter |
| ManCoCP240_3_3_SSC | 9.5 | 100 | 15 | SSR | 3-12A | Solid State Starter |
| ManCoCP240_3_5_SSC | 15.3 | 100 | 25 | SSR | 10-40A | Solid State Starter |
| ManCoCP240_3_7.5_SSC | 25.2 | 100 | 40 | SSR | 10-40A | Solid State Starter |
| ManCoCP240_3_10_SSC | 29.5 | 100 | 50 | SSR | 10-40A | Solid State Starter |
| ManCoCP240_3_15_SSC | 44.2 | 125 | 70 | SSR | 25-100A | Solid State Starter |
| ManCoCP240_3_20_FVNR | 54.4 | 175 | 90 | 14HUG32AF | Size 3 | Elect-mech starter |
| ManCoCP240_3_25_FVNR | 68 | 200 | 100 | 14HUG32AF | Size 3 | Elect-mech starter |
| ManCoCP480_3_2_SSC | 4.1 | 100 | 15 | SSR | 3-12A | Solid State Starter |
| ManCoCP480_3_3_SSC | 4.8 | 100 | 15 | SSR | 3-12A | Solid State Starter |
| ManCoCP480_3_5_SSC | 7.8 | 100 | 15 | SSR | 3-12A | Solid State Starter |
| ManCoCP480_3_7.5_SSC | 12.6 | 100 | 20 | SSR | 10-40A | Solid State Starter |
| ManCoCP480_3_10_SSC | 14.7 | 100 | 25 | SSR | 10-40A | Solid State Starter |
| ManCoCP480_3_15_SSC | 22.1 | 100 | 40 | SSR | 10-40A | Solid State Starter |
| ManCoCP480_3_20_SSC | 27.2 | 100 | 50 | SSR | 10-40A | Solid State Starter |
| ManCoCP480_3_25_SSC | 34 | 100 | 60 | SSR | 10-40A | Solid State Starter |
| ManCoCP480_3_30_SSC | 40.1 | 110 | 70 | SSR | 25-100A | Solid State Starter |
| ManCoCP480_3_40_FVNR | 52.2 | 125 | 80 | 14HUG32AF | Size 3 | Elec-mech Starter |
| ManCoCP480_3_50_FVNR | 70.5 | 175 | 110 | 14HUG32AF | Size 3 | Elec-mech Starter |
| All part numbers include junction box Fuji Inverters/VFD's only Part number for cabinets that are single phase does not include inverters - sold separately. | | | | | | |

The control panel, telemetry control cabinet, and motor cable junction box along with the safety switch box and electric utility power meter, shall be attached to horizontal support channels with stainless steel fastening systems designed for use with the support channel. The horizontal channels shall be 1-5/8 inch, 12 gage (or thicker) solid stainless steel channels (Uni-strut, B-Line or County approved equal), attached with stainless steel 3/8-inch all thread rod with stainless steel flat washers and nuts to two vertical 3 inch diameter stainless steel, schedule 40 posts. The 3 inch vertical pipe shall have plastic end caps or stainless steel end caps at the top and shall be anchored in concrete adjacent to

the pump station wet well. See County Standard, "Sewage Pump Station Meter & Electrical Details". No fittings shall enter from the top or back of the control panel. All fittings shall enter the side or bottom of the control panel and shall penetrate the control panel with Myers Hubs.

The overall control panel shall be a minimum of 30"x 36"x 12" deep and of adequate size to completely cover (without crowding) all wiring and components mounted inside it. It shall have provisions for the mounting of all basic and optional controls and instrumentation. Install engraved nameplates defining door mounted hardware. The electrical control panel shall have a complete wiring schematic which is laminated in plastic and attached to the inside of the outer control panel door.

All components shall be installed per the most current NEMA and NEC regulations and standards. The components shall be industrial NEMA rated (I.E.C. is not acceptable) and UL approved when UL approval is available for that particular type component. The components of the panel shall be held in place with stainless steel, slotted, plan head machine screws with star type washers. The panel shall be tapped to accept the mounting screws of the components and no self-tapping type screws shall be used. The control panel shall have the following items installed on the back plane or on aluminum "high hats" attached to the back plane, so the body of the component is flush with the dead front door to allow operation and reset of the components without opening the dead front door: main power breaker, emergency power circuit breaker, individual pump circuit breakers, control circuit breaker and G.F.I. duplex receptacle circuit breaker. The control panel shall have the following items installed directly to the back plane: individual motor starters, power distribution blocks, neutral bar assembly, grounding bar/lugs, terminal strips, 2 inch PVC panduit for control and telemetry wiring and fuses, and surge suppressor. The control panel shall have one G.F.I. duplex receptacle installed on the dead front door. The exterior of the control panel shall have one emergency generator receptacle, one flashing red light, and one audible alarm with reset button. The individual placement of all the components of the control panel shall be installed as indicated in the standard details.

E. Ratings

The controls shall be rated for the supply voltage (230 or 460 volts), 3 phase, 60 hertz. In the event that three phase power is not available at the location of the control panel, the cabinet shall be either ManCOCP240 1 3 VFD (3 hp) or ManCoCP240 1 5 VFD (5 hp) inverters. All control voltage to the wetwell shall not exceed 24 volts DC.

F. Wiring Method

All power conductors from the main circuit breaker to all other circuit breakers shall be connected via a Square D model LBA363206, Marathon #1333555, or equal power distribution block. All electrical panel components shall have individual neutral wires. All neutral wiring shall be connected via a Square D model SN12-125 neutral assembly. Wiring is to be continuous with no splices between connections. Provide a Square D model PK9GTA grounding bar at the bottom of the backplate. This grounding bar will be the central connection point of all ground wires for the system with the exception of the pump power cords and surge arresters. The pump power cords and surge arresters shall be grounded via individual ground lugs that are to be attached to the control panel back plane. Provide two 12 terminal, Ideal Model 89-208 terminal strips to make electrical connections in the control panel. One terminal strip shall be used exclusively for 24 volt connections (TB-1) and the other shall be used exclusively for 120 volt connections (TB-2). The power distribution block, neutral assembly, grounding bar and terminal strips shall be located as

indicated in the standard details. Use stainless steel screws and fasteners for all wiring connections.

G. Circuit Breakers

The panels shall be equipped with main and emergency circuit breakers for a minimum size of service of 100 amps. The main and emergency circuit breakers shall be interlocked so that when one is in the open position, the other circuit breaker must be in the closed position. There shall also be an individual circuit breaker for each pump, a control circuit breaker, a 20 amp circuit breaker for site lighting, a 20 amp circuit breaker for the flow meter (re-pump stations only) and a minimum 20 amp circuit breaker for the 120 volt GFI protected convenience outlet that is mounted on the inner control panel door. All circuit breakers shall be mounted in the control panel per the standard details. The circuit breakers shall be of the heavy duty thermal magnetic trip variety. For circuit breakers up to 100 amps, use Square D series QOU or County approved equal. For circuit breakers greater than 100 amps, use Square D "Mag Guard" series with adjustable trip for the pumps, main and emergency breakers shall be Square D QBL, HGL, or JGL.

H. Motor Starters

Pump motors shall each have a NEMA-rated, solid state or magnetic starter sized as called for on the construction plans. No starter smaller than NEMA size 1 shall be used. Starters shall be solid state, full voltage, non-reversing type. These starters shall be Siemens series ESP-100 or County approved equal with special phase loss protection and a special factory coating of the solid state circuit boards which prevents hydrogen sulfide damage. The starters shall be equipped with under voltage release and overload protection on all three phases. The motor starter contacts (if used) shall be constructed so that they may be easily replaced without removing the starter unit from its mounted position. The overload reset device shall be operable without having to open the inner swing panel.

I. Lightning Arresters

There shall be a Ditek DTK Series lightning arrester/surge suppressor installed on the incoming power source. It shall be mounted on the bottom exterior or placed inside of the safety switch enclosure and connected to the LOAD SIDE of the safety switch and overload reset.

The main circuit breaker and the RTU circuit breaker shall also each have a Ditek CM+Series lightning arrester/surge suppressor connected to the load side of the breaker wiring. These lightning arresters/surge suppressors shall be mounted with the supplied adhesive strip on the back of the "high hat" supporting the breakers. The exact model lightning arresters/surge suppressors shall be based on the voltage and number of phases of the protected circuits.

J. Liquid Level Switches and Sensors

A minimum of four float switches are to be installed in the wetwell to monitor and control liquid level height. The switches shall be a single pole mechanical type switch (as manufactured by MDI, Connery Manufacturing, or County approved equal). They shall be designed to actuate when the longitudinal axis of the float is horizontal, and deactuate when the liquid level falls one inch below the actuation elevation. The switching arrangement shall be normally open when deactivated. The output leads shall be connected in the control panel as shown in the standard details. The control voltage to the level switches shall be 24

volts DC and the switches shall be sized to operate at that voltage. In addition to the above, pump stations that re-pump sewage flows (directly or indirectly) from other pump stations shall have a Dylux model GXS3-PP300-A49-B49-50-C01-D49 pressure transmitter mounted inside a stilling well as the primary level sensor.

The wiring connecting the cable junction box to the wet well floats shall be a continuous length (no splices) of flexible rate 600 volt, minimum diameter of #18, type S.O. cable. The float switches shall have all connections made inside the junction box using crimp on spade terminals that are landed to the terminal strip. The wiring shall be installed so there is a minimum of four feet, and a maximum of 6 feet, of excess cable in the wet well for relocation of the float switches.

K. Alarms

Each pump station shall have one flashing red light and one audible alarm with silence button to signal high level conditions. An automatic shutoff timer for the horn (variable setting 0-20 minutes) is to be installed in the control panel. A flasher unit shall be installed and mounted in the control panel enclosure to operate the led flashing light attached to the uni-strut. The horn shall be mounted to the control panel as illustrated in the standard details.

L. Generator Receptacle

A generator receptacle to permit the installation of a portable emergency generator as the power source when the local utility power company power supply is lost shall be installed on the outside of the control panel as indicated on the standard details. It shall be directly connected to the emergency circuit breaker inside the control panel. The emergency and main circuit breakers shall have a mechanical interlink between them which shall allow only one source to supply power to the control panel at any given period of time. The generator receptacles shall be:

| <u>Power Supply</u> | <u>Required Receptacle</u> |
|-----------------------|----------------------------|
| 0-100 Amp, 230 Volt | Russell Stoll JRSB1044FR |
| 100-200 Amp, 230 Volt | Russell Stoll JRSB2044FR |
| 0-200 Amp, 460 Volt | Russell Stoll JRSB2034HR |

M. Seal Leak Moisture Detector

Provide for each pump a moisture sensing sensor which will detect when moisture has penetrated the seal chamber. The moisture seal detector shall be connected to the County RTU system to notify lift station maintenance personnel when a seal has allowed moisture to enter the oil chamber of the pump. An indicating lamp is to be mounted in the control panel as illustrated in the standard details to also signal the seal failure.

N. Telemetry Control Unit

The remote terminal/pump control unit shall be a complete TAC Pack TCU system as manufactured by Data Flow Systems, Inc. The unit is to be a fully programmable, dual function device. It shall be used to monitor and control SCADA equipment and it shall have all the necessary hardware and software to control three pump motor starters. Its operation is based on level inputs from a minimum of four float ball switches in the wetwell. It shall have the ability to control pump alternation, activate and deactivate remote and local alarms, and communicate with the HT3 SCADA System. It shall be equipped with RTU surge

protection and a transient filter shield. The unit shall have an uninterruptible power source and contain all the components and be electrically connected as indicated in the standard details. It shall be equipped with an antenna tower with supporting mast and coaxial cable that is required by the manufacturer for that particular system. The battery backup will be contained with the TCU in its own enclosure. The installation shall include the required FCC licensing. The antenna and mast shall be rated for 150 MPH winds. Tower heights above 20 feet must be Rohn RG-45 series.

Pump stations that re-pump sewage flows (directly or indirectly) from other pump stations will also require an Analog Monitor Module to receive input from the force main pressure transducer and flow meter.

Telemetry control and remote terminal/pump control units are not required for privately owned and maintained pump stations.

O. Grounding

Install a 5/8" x 10' copper-clad ground rod for each electrical service. Connect to the ground rod with a ground clamp and run a #6 bare copper wire to connect with the electrical panel grounding bar. Provide another, separate ground rod, tower clamp, Alpha Delta UCGC ground clamp for PolyPhaser, and #6 bare copper wire to connect directly to the antenna tower and control cabinet/TCU cabinet ground.

P. Site Lighting

A minimum 6000 lumens LED shall be mounted on the system tower for illumination of the pump station area. The manually operated light shall be a Regent Model EQ300M1 or equal, mounted on 3/4-inch galvanized rigid conduit connected to the RTU tower using 90 degree korns clamps.

3.01 GRINDER PUMP (LIFT) STATIONS

- A. Grinder pumps shall be used where the required discharge rate is low and the discharge pipe is required to be smaller than 4-inch diameter. Grinder pumping stations shall be constructed essentially to the same standards as the larger standard pumping stations, with full plastic liners, dual pumps with guide rails, control panels, RTUs, antennas and masts, etc., but sized smaller to accommodate the lesser capacity. Wetwell diameters may be smaller than 6 feet, but shall be no smaller than 4 feet. Riser pipes shall be no smaller than 1.25 inches diameter, and force mains shall be no smaller than 2 inches diameter. Ball check valves shall not be used.
- B. Grinder pumps will not be required to pass a 3-inch solid, but shall rather be capable of grinding all materials normally found in domestic raw wastewater into a pumpable slurry. The grinder cutters shall be made of 440C stainless steel hardened to Rockwell 60C. Motors shall be 230 volt, 3 phase, 60 hertz, 3450 or 1750 RPM speed, and shall otherwise meet the same requirements as for the larger standard sewage pump motors. Minimum hatch cover sizes for grinder pump station wetwells shall be 30 x 36 inches.
- C. There shall be an approved shut-off valve (tapping gate valve) installed at the connection of a grinder pump station pipeline to a County force main, and where the grinder pump station is maintained by a private entity, there shall be another approved shut-off valve (gate valve) installed at the point where the grinder pump pipeline enters the public right-of-way or public utility easement. The force main shall be at least 18 inches below the top slab within the

valve vault. A 90 degree bend, which is turned down, shall be installed 18 inches outside of the valve vault to lower the force main to obtain a minimum 3 feet of cover.

Wetwells and valve vaults for grinder lift stations may be fiberglass or HDPE plastic. If fiberglass, the resins used shall be a commercial grade unsaturated polyester or vinyl ester resin. The reinforcing materials shall be commercial Grade "E" type glass in the form of continuous roving and chop roving, and shall have a coupling agent that will provide a suitable bond between the glass reinforcement and the resin. The inner surface exposed to the chemical environment shall be a resin-rich layer of 0.010 to 0.020 inches thick. The inner surface layer exposed to the corrosive environment shall be followed with a minimum of two passes of chopped roving of minimum length 0.5 inch (13 mm) to maximum length of 2.0 inches (50.8 mm) and shall be applied uniformly to an equivalent weight of 3 oz/ft². Each pass of chopped roving shall be well-rolled prior to the application of additional reinforcement. The combined thickness of the inner surface and interior layer shall not be less than 0.10 inch (2.5 mm). The interior surface shall be free of crazing, delamination, blisters larger than 0.5-inch in diameter and wrinkles of 0.125-inch or greater in depth. Surface pits may be permitted if they are less than 0.75-inch in diameter and less than 0.0625-inch deep. Voids that may not be broken with finger pressure and that are entirely below the resin surface shall be permitted if they are less than 0.5-inch in diameter and less than 0.0625-inch thick. After inner layer has been applied, the wetwell and valve vault wall shall be constructed with chop and continuous strand filament wound manufacturing process which insures continuous reinforcement and uniform strength and composition. Wetwell and valve vaults may require resin fiber-reinforced bottoms.

Wetwell bottom shall have a minimum 3-inch anti-flotation ring. Wetwell and valve vault bottom shall be designed to resist all pressures induced by water, soil and wheel loads with a maximum deflection of 1/4-inch.

No hardware shall penetrate the wetwell walls. The wetwell wall shall include built / molded in channel supports for every 8 feet of vertical discharge piping for mounting pipe support braces and for mounting both guide rails and hooks to hang float balls, pump lifting chains, etc. at the top of the wet well. All pipe openings shall have resilient pipe to wetwell seals.

The 1:1 bottom fillet may be molded or formed fiberglass or plastic or concrete. Concrete also may be used on the top of anti-flotation ring and as required to resist buoyancy. The wetwell and valve shall resist flotation with ground water level assumed to be at finished grade. The Engineer of Record shall submit flotation calculations to Manatee County when submitting Construction Drawing approval.

All fiberglass and plastic wetwells and valve vaults located such that a vehicle may run over it shall have a minimum dynamic-load rating of 16,000 lbs. when tested in accordance with ASTM D3753. To establish this rating, the complete wetwell and valve vault shall not leak, crack, or suffer other damage when load tested to 40,000 lbs. and shall not deflect vertically downward more than 0.25 in. at the point of load application when loaded to 24,000 lbs. Thickness of fiberglass and plastic wetwells and valve vaults shall be determined by calculations submitted when submitting construction drawings for approval. The Engineer of Record shall perform the calculations or shall submit a certification that he or she reviewed calculations prepared by others and that the aforementioned requirements have been met.

The wetwell cylinder shall have the minimum pipe-stiffness values shown in table below when tested in accordance with ASTM D3753 Table 1.

| <u>WETWELL LENGTH (FT.)</u> | <u>PIPE-STIFFNESS F/AY, [PSI (k Pa)]</u> |
|-----------------------------|--|
| 3 - 6.5 | 0.72 (4.96) |
| 7 - 12.5 | 1.26 (8.69) |
| 13 - 20.5 | 2.01 (13.86) |
| 21 - 25.5 | 3.02 (20.82) |
| 26 - 35 | 5.24 (36.13) |

The exterior surface shall be relatively smooth with no sharp projections, free of blisters larger than 0.5-inch in diameter, delamination or fiber show.

Each wetwell and valve vault shall be designed and built to meet all required ASTM D3753 designations for dimensional requirements, hardness, chemical resistance, and workmanship. Test records shall be provided to the Owner/Engineer of Record and to the County Inspector.

The Contractor shall set sections vertical and in true alignment. The finished wetwell and valve vault shall not be out of plumb by more than 3/8-inch per 10 feet of height.

Each wetwell and valve vault shall be marked on the inside and outside with the following information: Manufacturer's name or trademark, factory location, serial or model number and total length.

4.01 WATER SERVICE

All pump stations shall be equipped with a 3/4-inch lock shield and loose key water service (hose bib) adjacent to the valve vault. Each water service shall be equipped with a 5/8-inch water meter, a reduced-pressure principle backflow preventer (Watts Model 909 or Equal) and a 3/4-inch brass hose bib. The water meter and backflow preventer shall be located within two feet of the pump station easement (or property) line. All water meters shall be obtained from the Manatee County Water Meter Department.

5.01 PERMITS

The Contractor shall be responsible for obtaining and shall pay for any permits and/or inspections required.

6.01 SHOP DRAWINGS AND INSPECTIONS

When calling for inspection, the Contractor shall have these approved shop drawings available on-site for review by the inspectors. The Contractor shall also deliver to the Lift Station Section inspector, the pump manufacturer's technical manual with the model number, serial number, and certified pump curve, for each pump prior to acceptance by the County for maintenance.

7.01 EASEMENTS

An easement for ingress and egress to the lift station and an easement for the lift station must be granted and recorded before the lift station can be accepted by the County for operation and maintenance.

8.01 SITING

- A. The siting of all pump station facilities shall be subject to review and approval by Manatee County. All pump stations shall be located on a separate parcel of land or within a utility easement in common open space. The station shall be properly sited with due consideration of the neighborhood, surrounding site features, landscaping, aesthetics, safety and security. The station and associated landscaping shall not be sited on a right-of-way, private road, median, front yard of a residence, or within a visibility triangle. The pump station wetwell, valve vault, control panel, and telemetry antenna shall not be sited within 20 feet of overhead power lines.
- B. Each pump station site shall have a vehicular access drive paved with a concrete or asphalt surface course over a base course. The drive shall be designed to allow a service truck to park off of the right-of-way or roadway easement and to also allow the service truck to back up to the wetwell such that the wetwell is directly to the rear of the truck or adjacent to the side of the truck. The pump station control panel, telemetry antenna and hose bib shall not be located between the vehicular access driveway and the wetwell and/or valve vault.
- C. There shall be at least a 20-foot easement in all directions from the pump station site equipment. There shall be no obstructions within the easement such as buildings, walls, fences, etc., other than those that are part of the pump station and identified in these standards. A minimum setback of 5 ft shall be provided between pump station structures/equipment and the security fence. Pump station easement shall extend a minimum of 15 ft beyond all four sides of the security fence. If the pump station is adjacent to the street's right-of way, the pump station easement shall extend to the ROW line. The lift station site shall be made accessible with a minimum 30 ft wide corridor/easement.
- D. Surface stormwater flow shall be directed around the pump station site. The site shall be graded to provide sheet flow of site runoff away from the equipment and direct it to a suitable swale or drainage outfall. The construction drawings shall include a pump station site plan with a grading plan and landscaping plan.

9.01 FLOODING

Wastewater pumping station structures and electrical and mechanical equipment shall be fully protected from physical damage from flood water intrusion by the 100-year flood. Wastewater pumping stations shall remain fully operational and accessible during the 25-year flood. Regulations of state and federal agencies regarding obstructions of the pumping station site by flood waters shall be observed during the design of the development.

10.01 ENTRANCE HATCH ELEVATIONS

The wetwell and valve vault top and entrance hatches shall be set at least 4 inches above the 100-year flood plain elevation, or 8 inches above the 25-year flood plain elevation, or 6 inches above the surrounding grade, or 12 inches above the adjacent roadway crown elevation, whichever is highest. Where this is not practical, deviation from the above must be approved by the County on a case-by-case basis.

11.01 ACCESSIBILITY AND SECURITY

All County owned and maintained pumping stations shall be readily accessible by maintenance vehicles during all weather conditions and during all stages of development construction. A fully functional paved travelway shall be provided to the lift station driveway. The facility shall be located off the traffic way of streets and alleys. Security fencing and

access hatches with locks shall be provided.

All hatches, electrical panel and irrigation panel doors shall be provided with lockable hasps or staples. Security fences with lockable gates shall be provided for all lift stations that are owned and maintained by Manatee County.

Lift stations shall have a 6-foot high vinyl coated chain link security fence with privacy decorative slatting (color matched). See Section 02444 Fencing.

For private lift stations, the Engineer of Record shall evaluate the location of the proposed lift station and determine whether a security fence is necessary.

12.01 FORCE MAIN PRESSURE TRANSMITTER AND FLOW METER

Lift stations that re-pump sewage flows (directly or indirectly) from other lift stations shall be equipped with an ultrasonic flow meter and force main pressure transducer. The flow meter shall be mounted on the force main in a water tight vault down stream from the valve vault. The flow meter shall be GE Panametrics Model AT868 Aqua Tans (for DIP or plastic pipe), or Eastech Badger Vantage Model 4400 (for plastic pipe materials only), or an approved equal. The flow meter sensors mounted on the force main shall be water proof. The meters, gauges and all connections and wiring shall be rated fully submersible. The transmitter shall be mounted next to the electrical control panel in a weather proof enclosure. The force main pressure transmitter shall be Ashcroft model T2-7-M02-42-H1-100#. The pressure transmitter shall be factory assembled with an Ashcroft model 25-312SS-02T-CD diaphragm seal filled with glycerin. The force main pressure transmitter shall be threaded into a cast billet on the outside curve of one of the 90's inside the vault. The flow meter and the force main pressure transducer shall transmit 4-20 mA signals to the telemetry system via the Analog Monitor Module mounted inside the control panel. The signal cables shall be run through 1-inch PVC conduit from the vault to the control panel.

13.01 LANDSCAPING & IRRIGATION

A. Landscape trees and shrubs.

The pump station site shall have shrubs planted around the perimeter of the pump station security fence in a hedge-like placement. Shrubs shall have a minimum spacing of 3 feet between the centers of the shrub's base stem. For private pump stations that are located in nonresidential areas, shrubs are optional for the sides that are not adjacent to thoroughfare roads, nonthoroughfare roads, and residential areas. For pump stations that are located adjacent to thoroughfare roads and non-thoroughfare roads, a minimum of two small understory trees or palm trees shall be planted between the pump station security fence and the right of way line. For pump stations within residential areas or located adjacent to residential areas, a minimum of two additional understory trees or palm trees; for a total of at least four understory trees or palm trees shall be planted around the pump station (these landscaping requirements are not applicable to pump stations that only serve one single family residence.) A minimum setback of 5 feet shall be provided between the shrub's base stem and the security fence to provide an access way for service personnel. A minimum setback of 10 feet shall be provided between the trunk of understory trees/palm trees and the security fence.

Understory trees shall not have a mature height exceeding 30 feet. Small understory trees, palm trees and shrubs shall not have evasive roots. The minimum height of understory trees shall be six (6') feet at time of placement. The minimum height of palm trees shall be fifteen

(15') feet at time of placement. The minimum height of shrubs shall be two (2') feet at time of placement. Shrubs shall have three gallon root balls. Shrub growth habits shall be upright, globose, or columnar. Shrub growth habits shall not be spreading or broad spreading. The understory trees and palm trees shall be planted to accent the shrub placement. Tops of root balls of plants shall be set at or slightly above existing grade. All plant material to be Florida Grade #1 or better, as defined in "Grades and Standards for Nursery Plants," State of Florida Dept. of Agriculture. Plants shall be sound, healthy, vigorous, and free from plant diseases, insects, pests, or their eggs and shall have healthy normal root systems. Plants shall be nursery grown stock, freshly dug. No heeled in, cold storage, or collected stock shall be accepted. Ground covers shall have sturdy fibrous root systems. Staking and bracing shall be done on all trees using Arbor tape and the Duckbill anchor system, in accordance with sound nursery practices.

The shrubs, understory trees and palm trees shall be of the drought tolerant, low maintenance varieties. Plant selection shall be based on soil water retention as well as soil pH.

Examples of acceptable vegetation are as follows:

| PLANT NAME | SOIL CONDITIONS WHERE PLANT WILL GROW | | pH RANGE | |
|--|---|--|---|-----------------------------------|
| | Damp to poorly drained soils w/ low percolation | Well drained sands w/ high percolation | Plant tolerates acidic & alkaline soils | Plant tolerates acidic soils only |
| UNDERSTORY TREES (Mature height not exceeding 30 feet) | | | | |
| Little Gem Magnolia (Magnolia grandiflora) | X | | | X |
| Southern Wax Myrtle (Myrica cerifera) | X | X | X | |
| Peregrina (Jatropha intergerrima) | | X | X | |
| Bottle Brush Tree (Callistemon citrinus) | | X | | X |
| Crape Myrtle Tree (Lagerstroemia Indica) | | X | | X |
| Feijoa (Feijoa sellowiana) | | X | X | |
| PALMS | | | | |
| Cabbage Palms (Sabal palmetto) | X | X | X | |
| Pindo Palms (Butia capitata) | | X | X | |
| Dwarf Royal (aka Christmas) Palm (Veitchia merrillii) | | X | X | |
| SHRUBS & BUSHES | | | | |
| Cocoplum (Chrysobalanus icaco) | | X | X | |
| Pipestem (Agarista Populafollia) | X | X | X | |

| | | | | |
|---|--|---|---|--|
| Sweet Viburnum (Viburnum odoratissimum) | | X | X | |
| Yew podocarpus (Podocarpus macrophyllus) | | X | X | |

The following plant species shall not be planted at the lift station site:

Melaleuca quinquenervia (commonly known as Punk tree, Malaleuca); Schinus terebinthefolius (commonly known as Brazilian Pepper); Casuarina species (commonly known as Australian Pine); Rhodomyrtus tomentosa (commonly known as Downy Rose Myrtle); Mimosa pigra (commonly known as the Catclaw Mimosa); Dalbergia sissoo (commonly known as the Indian Rosewood); and Cupaniopsis anacardioides (commonly known as the Carrotwood).

B. Ground cover.

There shall be no vegetation within the lift station fencing. Site shall include a polypropylene weed barrier fabric that is covered with a minimum of 2-inches of washed shell, or rock within lift station fencing. Landscaping stones shall be inert and nonleaching. Crushed lime rock shall not be acceptable. Site shall include a polypropylene weed barrier fabric that is covered with 3 to 4-inches of shredded wood-type mulch that is located under the shrubs and up to the outside of the security fence. Polypropylene weed barrier fabric that is covered with 3 to 4-inches of shredded wood-type mulch shall be located under the trees for a minimum distance of 3 feet from the tree. Bahia, St. Augustine or Floritam sod or shredded wood-type mulch with a polypropylene weed barrier fabric shall be extended from the shrubs to the lift station easement line.

C. Irrigation.

An irrigation system shall be connected to a non-potable water source. A weather-tight time clock with built-in transformer, minimum of four zones (Rainbird ESP-4M, Toro CC-M-9, or equal) and a rain sensor (Mini-Clik, or equal) shall be furnished and installed. The irrigation controller shall be in a lockable control panel and attached with stainless steel two piece pipe clamps or stainless steel U-bolts to two vertical 3 inch diameter stainless steel, schedule 40 pipes or equal pipe support. The pipe clamp or U-bolt ends shall be covered with plastic caps to prevent injury to personnel. The 3 inch vertical pipe shall have plastic end caps or stainless steel end caps at the top and shall be anchored in concrete. The irrigation system control panel recommended location is outside of the fence and behind the shrubs. The Contractor shall furnish the County a padlock with a set of two keys for the irrigation control panel. The number of zones shall be based on the proposed site, planting configuration, watering distribution, irrigation system demand, and type of vegetation to be irrigated. The irrigation system shall be installed to irrigate the trees, shrubs and grassed areas; and designed to provide three-fourths (3/4") to one (1") inch of water per week and be in conformance with irrigation restrictions established by the Southwest Florida Water Management District (not restricted if using reclaimed water). The irrigation system shall adhere to the requirements of the Manatee County Land Development Code and to the "Standards and Specifications for Turf and Landscape Irrigation Systems", latest edition, as published by the Florida Irrigation Society, Inc. A permanent sprinkler system with distribution lines underground with mist and/or bubbler nozzles, as appropriate, above the ground are acceptable. A micro-irrigation system located within the planting beds of shrubs and trees is acceptable for that type of installation. In each accent, isolated or separate tree planting bed, a tree bubbler (Toro 514-20 or equal), shall be installed at each tree. In addition, a four (4') foot section of flexible PVC shall be provided for the tree bubbler at each tree. Drip line hoses shall have built-in emitters (Toro DL2000 or equal).

D. Radio signal interference.

Landscape buffer plantings are to be field adjusted in coordination with the siting of the lift station's radio antenna to eliminate signal interference. The antenna for the existing or proposed radio telemetry unit at the lift station requires direct line-of-sight signaling capability to the Utilities Department office that will receive the signal. There shall be an unobstructed horizontal angle of fifteen (15°) degrees from the antenna mast (7 1/2 degrees on both sides of the direct line-of-sight azimuth). No tree shall be planted within the designated unobstructed angle for a twenty (20') foot horizontal distance measured from the mast.

14.01 BACK-UP DIESEL PUMPS OR EMERGENCY GENERATOR SET

| | |
|-----------------------|-------------------|
| Back-up Diesel Pumps: | See Section 11215 |
| Emergency Generators: | See Section 16231 |

END OF SECTION

DIVISION 4 MASONRY

SECTION 04220 MASONRY

PART 1 GENERAL

1.01 SCOPE OF WORK

- A. Furnish all labor, materials, equipment and incidentals required to construct all masonry work as shown on the Drawings and specified herein.
- B. The work under this Section includes, but is not necessarily limited to the following:
 - 1. Concrete masonry units (CMU), including decorative masonry block.
 - 2. Reinforced CMU lintels.
 - 3. Masonry reinforcing, ties and anchors.
 - 4. Grouting required throughout the project.

1.02 SAMPLES

- A. Submit two samples each of concrete masonry units.
- B. Submit two samples of decorative, masonry block.
- C. Before commencing with the laying of any architectural masonry, construct on the site, where directed by the County, a sample 6 x 4 foot wall panel showing type and tooling of mortar and bond, for the County's approval. This sample wall shall remain in place for the duration of the masonry work. Remove sample panel at the completion of the work as directed by the County.

1.03 PROTECTION OF MATERIALS

- A. All perishable materials for the work of this Section shall be delivered, stored and handled so as to preclude damage of any nature. Manufactured materials, such as cement and lime, shall be delivered and stored in their original container, plainly marked with identification of material and maker. Materials in broken containers or in packages showing water marks or other evidence of damage, shall not be used and shall be removed from the site.

All masonry shall be shipped stacked with hap or straw protection or other suitable protective device, and shall be similarly stacked off the ground on the site. In addition, all masonry stored on the site shall be protected from the weather and staining with the use of tarpaulins or other covering approved by the County.

1.04 COLD WEATHER CONSTRUCTION

Masonry construction in cold weather shall conform to the applicable requirements of "Construction and Protection Recommendations for Cold Weather Masonry Construction" of the Technical Notes on Brick and Tile Construction by the Brick Institute of America.

PART 2 PRODUCTS

2.01 MATERIALS - MASONRY

A. Concrete Masonry Units:

1. Standard and light weight concrete masonry units (CMU) shall conform to ASTM C-90, Grade N, Type I, two cell hollow, load bearing units of 8" x 16" nominal face size and bed dimension as shown on the Drawings. Masonry prism strength f'_m shall be as shown on the drawings, but not less than 1250 psi.
2. CMU shall be free from substances that will cause staining for at least 18 hours and then air cured in covered storage for not less than 28 days before delivery. Units shall have a maximum linear drying shrinkage of 0.25 percent (ASTM C-426) and have a moisture content at time of delivery not exceeding 30 percent of total absorption.
3. CMU noted as fire-rated on the Drawings shall conform to Underwriters Laboratories, Inc., Standard for Concrete Masonry Units UL618, and shall have two (2) hour fire resistant rating.
4. All split rib CMU shall have 7-1/2 equally spaced 3/4-inch deep x 3/4-inch wide bevels. The projected face shall have a rough texture. Units shall be laid in horizontal stack bond.
5. Units shall be obtained from one manufacturer to insure even color and texture.
6. Provide special units required by the Drawings, including solid, corner, pilaster, lintels, and jamb units.
7. Decorative masonry block units shall be similar in quality to Number 1210, DeMaco Concrete Products, Sarasota, FL, or equal. Design pattern to be as shown on the Drawings.

- B. Acoustic concrete masonry units shall be Soundblox, Type R by the Proudfoot Company or equal. Units shall be fabricated on standard block machines using manufacturer's special molds; shall have a closed top and ends and slotted exposed face; shall have a noise reduction coefficient range (NRC) of 0.50 - 0.60 for Type R; and shall comply with ASTM-C90 for load bearing masonry units. Color of the Soundblox and mortar shall match interior color which will be submitted to the County. The Soundblox installation shall be laid in horizontal stackbond with flush joints.

2.02 REINFORCING, TIES, ANCHORS AND MISCELLANEOUS

- A. Reinforcing shall be welded wire units prefabricated in straight lengths of not less than 10 feet with matching corner and tee units fabricated from cold-drawn steel wire complying with ASTM-A82, with deformed continuous side rods and plain cross-rods, crimped for cavity wall construction, if required, and a unit width of 1-1/2 inches to 2 inches less than thickness of wall or partition. Reinforcement for decorative masonry block shall be 2 inches wide. Reinforcement shall be placed at every third course (24" o.c.).
- B. Single width reinforcement shall be truss type, fabricated with single pair of galvanized 9 gauge side rods and continuous 9 gauge cross-rods spaced not more than 16 inches on center.
- C. Galvanized dove-tailed anchor slots with anchors at 24 inches on center shall be furnished for anchorage to concrete framework or walls.
- D. Approved 16-gauge corrugated non-ferrous metal ties manufactured for use with the anchor slots provided shall be spaced at a maximum of 8 inches o.c. vertically and 30 inches o.c. horizontally.
- E. The Contractor shall provide and install miscellaneous anchors and attachment members,

required both for the anchorage of his own work and that of other trades requiring attachment to masonry, which are not specifically provided under separate sections.

- F. Control joints shall be factory extruded preformed rubber gaskets conforming to ASTM D-2000 2AA-205 and shall be as manufactured by Dur-O-Wal, Hohmann and Bernard, Inc., AA Wire Products or equal. Control joints shall be installed as shown on the Drawings.
- G. Weep holes shall be 1/4-inch O.D. by 4 inches long, clear plastic tubing that will not stain brickwork, by Hohmann and Barnard, Inc. or equal.
- H. Cleaning compound shall be mild, non-caustic detergent solution such as 801 Super Real Clean by Superior Manufacturing Co., or 600 Sureclean by Process Solvent Co., Inc., or equal.

2.03 MORTAR MATERIALS

- A. Portland cement shall conform to ASTM C150 Type II. Masonry cements to be used when specifically approved for colored mortar.
- B. Lime for masonry mortar shall be hydrated, conforming to ASTM C207, Type S.
- C. Sand shall be clean, durable particles, free from injurious amounts of organic matter. The sand shall conform to the limits of ASTM C144. Sand for grout shall conform to ASTM C144 or C33 as required.
- D. Water shall be free from injurious amounts of oils, acids, alkalis or organic matter, and shall be clean and fresh.
- E. Mortar proportions shall conform to ASTM C270, Type M, or as otherwise approved by the County. Ingredients shall be accurately measured by volume in boxes especially constructed for the purpose by the Contractor. Measurement by shovel will not be allowed.
- F. Grout for setting bearing plates, machinery, or any other equipment shall be mixed as recommended by the manufacturer to give the necessary consistency for placing and to give a minimum compressive strength (ASTM C-109) of 5000 psi at 7 days.
- G. All other grout shall be 1 part Portland cement and 1 part sand with a maximum aggregate size of 3/8 inch pea rock and a minimum comprehensive strength of 3000 psi in 28 days.
- H. Non-shrink non-metallic grout shall be 5 star grout as manufactured by the U.S. Grout Corp., or equal and be used in strict accordance with the manufacturer's instructions for the use intended.

2.04 FACE BRICK

Non-load bearing burned clay or shale. Size, color and texture to match existing and as approved by the County.

PART 3 EXECUTION

3.01 MORTAR

- A. Mortar shall be machine mixed in an approved type of mixer in which the quantity of water

can be accurately and uniformly controlled. The mixing time shall not be less than five minutes, approximately two minutes of which shall be for mixing the dry materials and not less than three minutes for continuing the mixing after the water has been added. Where hydrated lime is used for mortar requiring a lime content, the Contractor will have the options of using the dry-mix method or first converting the hydrated lime into a putty.

- B. All CMU shall be laid in a full bed or mortar, applied to shells only. Butter the vertical joint of unit already set in the wall and all contact faces of the unit to be set. Each unit shall be placed and shoved against the unit previously laid so as to produce a well-compacted vertical mortar joint for the full shell thickness. Units shall set with all cells in a vertical position. The moisture content of the units when laid shall not exceed 35 percent of the total absorption as determined by laboratory test. Decorative masonry units shall be laid in a full bed of mortar on all four sides.
- C. All masonry units shall be laid in stretcher (running) bond unless otherwise shown. Tool dense and neat.
- D. Sizes shall be specified and called for on the Drawings, and where "Soaps" and "Splits" are used, the space between these members and the backup material shall be slushed full of mortar.
- E. Joints of all masonry shall be tooled in accordance with the following:
 - 1. Wait until unit mortar is thumbprint hard before tooling joint. This may require as much as three hours in the shade and one hour in the sun in the summertime.
 - 2. The required personnel of the Contractor shall be kept on the job after hours, if necessary, to properly tool joints.
 - 3. Both vertical and horizontal joints shall be maintained uniform in spacing.
 - 4. Joints for CMU shall be 3/8 inch.
 - 5. Joints for structural block shall be 1/4 inch.
- F. Install all frames required to be set in masonry, set masonry tightly against frames, build in all frame anchors, and fill frames solid with mortar.
- G. Control joints shall be installed at the intersection of masonry walls with structural concrete and elsewhere as detailed on the Drawings. Joints shall be raked out to a depth of 3/4 inch for the full height of the wall suitable for caulking. The maximum length, horizontally, between vertical control joints shall be 40 ft., but joints shall be located only as directed or shown. Joints shall be equal in width to the standard mortar joint.
- H. All masonry slots, chases, or openings required for the proper installations of the work of other Section shall be constructed as indicated on the Drawings or in accordance with information furnished before the work is started at the point affected. No chase shall cut into any wall constructed of hollow units after it is built, except as directed and approved by the County.
- I. Surfaces shall be brushed as work progresses and maintained as clean as it is practicable. Unfinished work shall be raked back where possible, and toothed only where absolutely necessary. Before leaving fresh or unfinished work, walls shall be fully covered and protected against rain and wind and before continuing work previously laid shall be swept clean. To tops of walls or other unfinished work shall be protected against all damage by frost or the elements by means or waterproof paper, tarpaulins, boards or other means

approved by the County.

- J. The Contractor shall build-in all miscellaneous items to be set in masonry for which placement is not specifically provided under separate Divisions, including reglets, lintels, ties, electrical panel boxes, sleeves, vents, grilles, anchors, grounds, and exterior electric conduits and fixtures, and shall cooperate with other trades whose work is to be coordinated with the work under this Section.
- K. All anchorage, attachment, and bonding devices shall be set so as to prevent slippage and shall be completely covered with mortar or grout.
- L. All ties and reinforcing for masonry shall be furnished and installed by the Contractor.
- M. Loose steel lintels shall be as shown on drawings and installed under this Section.
- N. Loose lintels shall be set in full bed or mortar and supported by solid or mortar filled hollow concrete blocks as detailed on the Drawings.
- O. Bed and grout all steel, for equipment and machinery, and items coming in contact with masonry where grouting is required, including door bucks and frames set in masonry. The Contractor shall install all anchor bolts, base plates, and seats in masonry walls, and build-in all items required for the completion of the building as they apply to masonry.

3.03 REINFORCED MASONRY

- A. Provide vertical reinforcing in filled cores of masonry units of size, spacing and locations as indicated on the Drawings and specified herein. Unless otherwise shown on the Drawings, vertical reinforcing at all exterior infill walls shall be No. 4 bars as specified in the Contract Documents and shall be placed 8'-0" on center, and vertical reinforcing at all exterior free standing walls shall be No. 5 bars placed at each corner, each opening and not greater than 8'-0" centers along straight runs.
- B. All cores containing reinforcing shall be filled, full height, with 3/8" pump mix concrete $f'c = 2,500$ psi with a slump of not less than 6 inches nor more than 8 inches.

3.04 CLEANING

- A. All holes in exposed masonry shall be pointed, and defective joints shall be cut out and repointed with mortar of same color as that of the original and adjoining work.
- B. Exposed masonry shall be protected against staining by wall coverings, and excess mortar shall be wiped off the surface as the work progressed.
- C. All masonry shall be cleaned with approved detergent solution in accordance with manufacturer's printed directions. No acid or metal scrapers shall be used on masonry.
- D. Before applying any cleaning agent to the entire wall, it shall be applied to a sample wall area of approximately 20 square feet in a location approved by the County. No further cleaning work may proceed until the sample area has been approved by the County, after which time the same cleaning materials and method shall be used on the remaining wall area.

3.05 WALL FLASHING

- A. Fabric wall flashing shall be installed above and below all openings in exterior masonry, at intersection of floors with exterior walls, and elsewhere as shown or noted on the Drawings. It shall be furnished and installed as shown on the Drawings.

END OF SECTION

DIVISION 5 METALS

SECTION 05500 MISCELLANEOUS METAL

PART 1 GENERAL

1.01 SCOPE OF WORK

A. Furnish all labor, equipment and incidentals required and install covers, grates, frames and other miscellaneous metals as shown on the Drawings and specified herein. The miscellaneous metal items include but are not limited to the following:

1. All metal frames, ladders, stairs, stair rails, floor opening frames including gratings and supports.
2. Prefabricated access hatches and frames.
3. Anchors and anchor bolts except those specified to be furnished with all equipment.
4. Railings, posts and supports both interior and exterior.
5. Cast iron frames, covers, grates, drain leaders and drains.
6. Bridge crane track supports.
7. Stair nosings, steel plates, overhead steel door frames, angle frames, plates and channels.
8. Exterior H.V.A.C. hoods.
9. Pump guide rail system.

1.02 COORDINATION

- A. The work in this Section shall be completely coordinated with the work of other Sections. Verify at the site both the dimensions and work of other trades adjoining items of work in this Section before fabrication and installation of items herein specified.
- B. Furnish to the pertinent trades all items included under this Section that are to be built into the work of other Sections.

1.03 SHOP DRAWINGS AND SAMPLES

- A. Detail drawings, as provided for in the Contract Documents, showing sizes of members, method of assembly, anchorage, and connection to other members shall be submitted to the County for approval before fabrication.
- B. Samples shall be submitted at the request of the County for concurrent review with Shop Drawings.

1.04 FIELD MEASUREMENTS

- A. Field measurements shall be taken at the site to verify or supplement indicated dimensions and to insure proper fitting of all items.

1.05 REFERENCED SPECIFICATIONS

- A. Unless otherwise specified, materials shall conform to the following:

| | |
|------------------------------|----------|
| Structural Steel | ASTM A36 |
| Welded & Seamless Steel Pipe | ASTM A53 |

| | |
|---------------------------------------|---------------------------|
| Gray Iron Castings | ASTM A48, Class 30 |
| Galvanizing, general | ASTM A123 |
| Galvanizing, hardware | ASTM A153 |
| Galvanizing, assemblies | ASTM A386 |
| Aluminum (Extruded Shapes) | 6061-T6 (Alum. alloy) |
| Aluminum (Extruded Pipe) | 6061-T6 (Alum. alloy) |
| Aluminum Bar Structural | 6061-T6 (Alum. alloy) |
| Bolts and Nuts | ASTM, A307 |
| Stainless Steel Bolts, Fasteners | AISI, Type 316 |
| Stainless Steel Plate and Sheet, Wire | AISI, Type 316 |
| Welding Rods for Steel | AWS Spec. for Arc Welding |

PART 2 PRODUCTS

2.01 ANCHORS, BOLTS AND FASTENING DEVICES

- A. Anchors, bolts, etc., shall be furnished as necessary for installation of the work of this Section.
- B. Compound masonry anchors shall be of the type shown or required and shall be equal to Star Slug in compounded masonry anchors manufactured by Star Expansion Industries, equal by Phillips Drill Co., Rawlplug, or equal. Anchors shall be minimum "two unit" type.
- C. The bolts used to attach the various members to the anchors shall be the sizes shown or required. Stainless steel shall be attached to concrete or masonry by means of stainless steel machine bolts and iron or steel shall be attached with steel machine bolts unless otherwise specifically noted.
- D. For structural purposes, unless otherwise noted, expansion bolts shall be Wej-it "Ankr-Tite", Phillips Drill Co. "Wedge Anchors", or Hilti "Kwik-Bolt". When length of bolt is not called for on the Drawings, the length of bolt provided shall be sufficient to place the wedge portion of the bolt a minimum of 1-inch behind the reinforcing steel within the concrete. Material shall be as noted on the Drawings. If not listed, all materials shall be stainless steel.

2.02 ALUMINUM ITEMS

- A. Aluminum gratings shall be of serrated I-Bar Aluminum Alloy 6061-T6, fabricated to the depths and thicknesses shown on the Drawings and shall be Reliance Steel Products Company, I-Lok Type 7/8 R4 Aluminum Grating; IKG Industries, "Galok" Aluminum I-Bar Grating Type S194-I, or equal. All openings 2 inches and greater in diameter shall be banded with a bar of the same depth and thickness as the main bearing bars of the grating, or furnished with continuous cross bridges. Each cut bar shall be welded to the band if banding is utilized. The ends of all grating sections shall be likewise banded. Clamps and bolts used for attaching grating to supporting members shall be stainless steel. All grating shall be clamped unless noted otherwise. Clamps shall be as recommended by the manufacturer.
- B. Stair treads shall be as specified above for grating and shall have abrasive nonslip nosing.
- C. Aluminum nosing at concrete stairs shall be an extrusion of 4-inch minimum width with abrasive filled and shall be Wooster Products, Inc., Alumogrit Treads, Type 116; equal by Barry Pattern and Foundry Co.; Andco; or equal. Embedded anchors shall be furnished with a minimum of three anchors per tread.

- D. Aluminum ladders shall be fabricated to the dimensions and details and installed as shown on the Drawings. Treads to be of cast aluminum by Dixie Metals, Inc. of Fort Lauderdale, Florida or equal.
- E. Aluminum Handrails, Mechanically Fastened Type:
1. All aluminum mechanically fastened type pipe handrails and guardrails shall be clear anodized aluminum finish and installed as specified herein and indicated on the Drawings. Handrails shall be made of nominal 1-1/2 inches inside diameter pipe (Schedule 40) fabricated or seamless 6063-T6 alloy. The supplier of the handrail system shall supply all necessary fittings, rackets, transition, corner and connector pieces, toeboards, protective gaskets, etc., for a complete job at the locations, indicated on the Drawings. All mounting hardware including bolts, studs, nuts, etc., shall be stainless steel Type 316. Bends shall be smooth and accurate to the details shown. Railings shall be the "Rigid Rail System" as manufactured by Reynolds Aluminum of Reynolds Metal Company as Reynolds II pipe railing system or the "Connectorail System" as manufactured by Julius Blum & Co., Inc., Carlstadt, New Jersey. The handrail systems shall comply with all OSHA and D Section 1208.2 of the Standard Building Code.
 2. Spacing of posts where posts are required shall be as noted on shop drawings, but in all cases, shall be uniform and shall not exceed the requirements of OSHA and Section 1208.2 of the Standard Building Code. Shorter spacing may be used where required to maintain the maximum spacing. The fabricator of the aluminum handrail and guardrail system shall be responsible for the design and preparation of shop drawings and design calculations (signed and sealed by Florida Registered Engineer) to meet OSHA requirements and Section 1208.2 of Standard Building Code.
 3. All railings shall be erected in line and plumb. Field splicing and expansion compensation shall be accomplished using internal splice sleeves. Make provisions for removable railing sections as detailed and where shown on the Drawings.
 4. Where handrail or guardrail posts are set in concrete as per the manufacturer's requirements the posts shall be set into aluminum sheeves cast in the concrete and firmly cemented with 1651 epoxy resin by E-Bond Epoxies, Oakland Park, Florida, Moulded Reinforced Plastics, Inc., Fort Lauderdale, Florida or equal. Collars shall be placed on the posts and fastened in place, as shown and as detailed on approved shop drawings.
 5. Where handrail is supported from structural members, it shall be done by the use of approved sockets, flanges, brackets, or other approved means which will provide neat and substantial support for the pipe railing.
 6. All railing shall be properly protected by paper, or by an approved coating or by both against scratching, splashes or mortar, paint, or other defacements during transportation and erection and until adjacent work by other trades has been completed.
- F. Toeboards: Contractor shall furnish and install aluminum toeboards conforming to latest OSHA requirements on all railings and other locations where indicated on the Drawings.
1. Toeboards shall consist of an extruded 6063-T6 aluminum shape bolted by means of a pipe clamp to the railing posts without requiring any drilling or welding of the toeboard to the railing posts as manufactured by Reynolds Aluminum, Julies Blum & Company, Thompson Fabricating Company or equal. Toeboards shall have pitched top and tear drop bottom to prevent accumulation of dirt, or other material.

2. All fastening hardware shall be Type 316 stainless steel.
- G. Kickplates, if required, shall be fabricated and installed as shown on the Drawings.
- H. Aluminum safety gate shall be fabricated of extruded aluminum.
- I. Prefabricated checkerplate aluminum floor hatches shall be Type "JD", or "KD" as manufactured by Bilco Co., Babcock-Davis Associates, Inc.; Type "AM" Inland-Ryerson Construction Products Co., Milcor Division; or equal, sized as shown. Hatches with either dimension over 3 feet-6 inches shall be double leaf type. Hatches shall be designed for a live load of 300 pounds per square foot. Hatches shall be watertight.
- J. Ship ladders shall be of all aluminum construction as detailed. Treads shall have abrasive nosing as manufactured by Reliance Steel Products Co., IKG Industries, or equal.
- K. Checkplate aluminum cover plates shall be fabricated to the details shown and installed at the locations shown.
- L. Structural aluminum angle and channel door frames shall be provided as shown on the Drawings and shall be anodized. Frames shall be fabricated with not less than three anchors on each jamb.
- M. Miscellaneous aluminum shapes and plates shall be fabricated as shown. Angle frames for hatches, beams, grates, etc., shall be furnished complete with welded strap anchors attached. Furnish all miscellaneous aluminum shown, but not otherwise detailed. Structural shapes and extruded items shall conform to the detail dimensions on the Plans within the tolerances published by the American Aluminum Association.

2.03 STEEL ITEMS

- A. Sleeves shall be steel or cast iron pipe in walls and floors with end joints as shown on the Drawings. All pipe sleeves shall have center anchor around circumference as shown.
- B. Miscellaneous steel pipe for sleeves and lifting attachments and other uses as required shall be Schedule 40 pipe fabricated according to the details as shown on the Drawings.
- C. Miscellaneous steel shall be fabricated and installed in accordance with the Drawings and shall include: beams, angles, support brackets, closure angles in roof at edge of T-beams; base plates to support ends of T-beams; door frames; splice plates, anchor bolts; lintels and any other miscellaneous steel called for on the Drawings and not otherwise specified.

2.04 CAST IRON ITEMS

- A. Outside pipe clean-out frames and covers shall be heavy duty, R-6013-R-6099 series as manufactured by Neenah Foundry Co., or equal. All outside pipe clean-outs shall be 6-inch diameter.
- B. Frames and covers for valve vaults and manholes shall be of a good quality, strong, tough even grained cast iron except as otherwise specified below. Castings shall be as manufactured by the U. S. Foundry, Neenah Foundry, Mechanics Iron Foundry, or equal. Covers to have letters "WATER", "SEWER" or "DRAIN", as applicable, embossed on top.

PART 3 EXECUTION

3.01 FABRICATION

- A. All miscellaneous metal work shall be formed true to detail, with clean, straight, sharply defined profiles and smooth surfaces of uniform color and texture and free from defects impairing strength or durability.
- B. Connections and accessories shall be of sufficient strength to safely withstand stresses and strains to which they will be subjected. Steel accessories and connection to steel or cast iron shall be steel, unless otherwise specified. Threaded connections shall be made so that the threads are concealed by fitting.
- C. Welded joints shall be rigid and continuously welded or spot welded as specified or shown. The face of welds shall be dressed flush and smooth. Exposed joints shall be close fitting and jointed where least conspicuous.
- D. Welding of parts shall be in accordance with the Standard Code of Arc and Gas Welding in Building Construction of the AWS and shall only be done where shown, specified, or permitted by the County. All welding shall be done only by welders certified as to their ability to perform welding in accordance with the requirements of the AWS Code. Component parts of built-up members to be welded shall be adequately supported and clamped or held by other adequate means to hold the parts in proper relation for welding.
- E. Welding of aluminum work shall be on the unexposed side as much as possible in order to prevent pitting or discoloration.
- F. All aluminum finish exposed surfaces, except as specified below, shall have manufacturer's standard mill finish. Aluminum handrails shall be given an anodic oxide treatment in accordance with the Aluminum Association Specification AA-C22-A41. A coating of methacrylate lacquer shall be applied to all aluminum shipment from the factory.
- G. Castings shall be of good quality, strong, tough, even-grained, smooth, free from scale, lumps, blisters, sand holes, and defects of any kind which render them unfit for the service for which they are intended. Castings shall be thoroughly cleaned and will be subjected to a hammer inspection in the field by the County. All finished surfaces shown on the Drawings and/or specified shall be machined to a true plane surface and shall be true and seat at all points without rocking. Allowances shall be made in the patterns so that the thickness specified or shown shall not be reduced in obtaining finished surfaces. Castings will not be acceptable if the actual weight is less than 95 percent of the theoretical weight computed from the dimensions shown. The Contractor shall provide facilities for weighing castings in the presence of the County showing true weights, certified by the supplier.
- H. All steel finish work shall be thoroughly cleaned, in accordance with the Contract Documents, of all loose mill scale, rust, and foreign matter before shipment and shall be given one shop coat of primer compatible with finish coats specified in Painting Section after fabrication but before shipping. Paint shall be applied to dry surfaces and shall be thoroughly and evenly spread and well worked into joints and other open spaces. Abrasions in the field shall be touched up with primer immediately after erection. Final painting is specified in the Contract Documents.
- I. Galvanizing, where required, shall be the hot-dip zinc process after fabrication. Following all manufacturing operations, all items to be galvanized shall be thoroughly cleaned, pickled, fluxed, and completely immersed in a bath of molten zinc. The resulting coating shall be

adherent and shall be the normal coating to be obtained by immersing the items in a bath of molten zinc and allowing them to remain in the bath until their temperature becomes the same as the bath. Coating shall be not less than 2 oz. per sq. ft. of surface.

3.02 INSTALLATION

- A. Install all furnished items imbedded in concrete or other masonry. Items to be attached to concrete or masonry after such work is completed shall be installed in accordance with the details shown. Fastening to wood plugs in masonry will not be permitted. All dimensions shall be verified at the site before fabrication is started.
- B. All steel surfaces to come in contact with exposed concrete or masonry shall receive a protective coating of an approved heavy bitumastic troweling mastic applied in accordance with the manufacturer's instructions prior to installation or provide a 1/32-inch neoprene gasket between the steel surface and the concrete or masonry.
- C. Where aluminum is embedded in concrete, apply a heavy coat of approved bitumastic troweling mastic in accordance with the manufacturer's instructions prior to installation.
- D. Where aluminum contacts masonry or concrete, provide a 1/32-inch neoprene gasket between the aluminum and the concrete or masonry.
- E. Where aluminum contacts a dissimilar metal, apply a heavy brush coat of zinc-chromate primer and provide a 1/32-inch neoprene gasket between the aluminum and the dissimilar metal.

Where aluminum contacts wood, apply two coats of aluminum metal and masonry paint to the wood.

END OF SECTION

SECTION 05550 AIR RELEASE ENCLOSURE

PART 1 GENERAL

1.01 SCOPE OF WORK

The Contractor shall furnish all labor, materials, equipment and incidentals required to install the above ground air release enclosure as listed in the specifications and as shown on the Drawings.

1.02 RELATED WORK

The contractor shall be responsible for any related work necessary for the proper installation of enclosure. This shall include, but is not limited to, any required bypass pumping, any required earthwork and any required concrete work.

1.03 SUBMITTALS

- A. Submit to the County shop drawings and schedules of all enclosure systems and appurtenances required. Submit design data and specification data sheets listing all parameters used in the enclosure system design.
- B. Submit to the County the name of the enclosure supplier and a list of materials to be furnished.

1.04 REFERENCE STANDARDS

- A. American Water Works Association (AWWA).
- B. American Society for Testing and Materials (ASTM).
- C. Where reference is made to the above standard, the revision in effect at the time of bid opening shall apply.

1.05 QUALITY ASSURANCE

The enclosure manufacturer shall be a company specializing in the manufacture of such enclosures with at least five (5) years of successful field experience and being lab certified as meeting A.S.S.E 1060 requirements.

1.06 DELIVERY, STORAGE AND HANDLING

- A. Care shall be taken in shipping, handling and placing to avoid damaging. Any material damaged in shipment shall be replaced as directed by the County.
- B. Any material showing deterioration, or which has been exposed to any other adverse storage condition that may have caused damage, even though no such damage can be seen, shall be marked as rejected and removed at once from the work.

PART 2 PRODUCTS

2.01 GENERAL

All enclosures shall comply with the standard detail for shape and size and shall include a 22" square by 24" tall enclosure with a hasp for a padlock. The enclosure shall be securely attached to a concrete base with anchor brackets installed on the interior of the enclosure, through the flange base of the enclosure itself or through a stainless steel anchor hinge.

2.02 ALUMINUM ENCLOSURE

- A. The roof, walls and access panels shall be constructed of mill finish aluminum, ASTM B209, solid sheet construction, with a wall thickness of one eighth inch.
- B. All structural members shall be aluminum. No wood or "particle board" shall be allowed in assembly.
- C. Multi-sectional enclosures shall fit together with overlapping "tongue and groove" joints and be secured internally with mechanical fasteners.
- D. All assembly fasteners shall be stainless steel or aluminum.

2.03 STAINLESS STEEL ENCLOSURE

- A. The roof, walls and access panels shall be constructed stainless steel, type 316, solid sheet construction, with a wall thickness of one eighth inch.
- B. All structural members shall be stainless steel. No wood or "particle board" shall be allowed in assembly.
- C. Multi-sectional enclosures shall fit together with overlapping "tongue and groove" joints and be secured internally with mechanical fasteners.
- D. All assembly fasteners shall be stainless steel.

2.04 FIBERGLASS ENCLOSURE

- A. Enclosure shall be a one-piece molded fiberglass/resin enclosure with polyester coating; a base flange for mounting to the concrete slab and a full recessed door opening with a lip. Enclosure shall be by Allied Molded Products, or equivalent. Color shall be as directed by the County.
- B. Full length piano style hinge, door latch, padlock hasp and all bolts and other hardware shall be of stainless steel.

PART 3 EXECUTION

3.01 INSTALLATION

Enclosure shall be assembled and mounted plumb, level and square on the concrete pad according to the manufacturer's instructions and the contract drawings.

END OF SECTION

SECTION 05600 METAL BUILDINGS

PART 1 GENERAL

1.01 RELATED DOCUMENTS

Drawings and general provisions of the contract, including General Specification as may apply to work specified in this Section.

1.02 SCOPE OF WORK

- A. Structure and Roof
- B. Siding on East Side

1.03 COORDINATION

- A. The work in this Section shall be completely coordinated with the work of other Sections. Verify at the site both the dimensions and work of other trades adjoining items of work in this Section before fabrication and installation of items herein specified.
- B. Furnish to the pertinent trades all items included under this Section that are to be built into the work of other Sections.

1.04 SHOP DRAWINGS AND SAMPLES

- A. Detail drawings, as provided for in the Contract Documents, showing sizes of members, method of assembly, anchorage, and connection to other members shall be submitted to the County for approval before fabrication.
- B. Samples shall be submitted at the request of the County for concurrent review with Shop Drawings.

END OF SECTION

DIVISION 6 WOOD AND PLASTIC

SECTION 06100 ROUGH CARPENTRY

PART 1 GENERAL

1.01 SCOPE OF WORK

- A. Furnish all labor, materials, equipment, and incidentals necessary and install all items of carpentry work complete as shown on the Drawings and as specified herein including nailers, grounds and cants.
- B. The following list of work items is intended only as a guide to that required, the full scope being determined by the actual job conditions.
 - 1. Rough carpentry and framing, as indicated or required, including grounds, blocking, rough frames, nailing strips and strapping.
 - 2. Rough hardware, anchors and bolts, not specifically included elsewhere.
 - 3. Temporary closures.
 - 4. Installation of metal doors.
 - 5. Installation of metal wall frames and louvers.

1.02 JOB CONDITIONS

Deliver, handle and store lumber and plywood to prevent damage. Stack lumber off the ground in a manner to ensure ventilation and protection from the weather.

1.03 QUALITY ASSURANCE

Grade and Treatment Markings shall appear on lumber with seal and stamp of the inspection agency or bureau having jurisdiction.

PART 2 PRODUCTS

2.01 MATERIALS

- A. All lumber shall be of sound stock, delivered dry, and shall be fully protected at all times from injury and dampness. Split, broken, or otherwise damaged pieces will not be allowed in the work.
- B. Lumber for Blocking, Grounds and Nailers shall be S4S, either No. 2 Southern Pine, or standard grade Douglas fir, with moisture content of not more than 19%.
- C. Wood members that will contact masonry or concrete, or any wood framing or blocking member shown on the Drawings and labeled "P.T." shall be pressure treated with chromated copper arsenate or flourchrome arsenate phenol. Minimum net retention of solids preservation shall be 0.35 lbs. per cu. ft. All other permanent wood in place shall be pressure treated with any of the following: Celcure, Wolman Salts, Copperized Chromated Zinc Arsenate or Pentachlorophenol dissolved in a volatile mineral spirits solvent and bear an approved AWP1-LP-2 or LP-3 quality mark. Clear heart Redwood may be substituted for pressure treated lumber.
- D. All treatment shall be performed in accordance with the requirements of the Standard

Specifications of the American Wood Preservers Association for treating wood. Apply a heavy coat of the same preservation used in treating to all surfaces cut after treatment.

- E. Nails and spikes, where sizes are not indicated or specified, shall be of suitable size and number to securely fasten and hold members in place.
- F. Plywood for project sign shall be A-A EXT-APA grade and 1-inch thick. Posts shall be same as for nailers specified in subparagraph B above.

PART 3 EXECUTION

3.01 INSTALLATION

- A. All carpentry shall be accurately cut, fitted and installed as detailed on the Drawings.
- B. Anchors shall be installed, where indicated or required, to anchor carpentry or other items securely to masonry or concrete.
- C. Forms for structural concrete work shall be as shown on the Drawings. Provide all other miscellaneous wood form work as may be required for the completion of the Work.
- D. Temporary wood doors and cloth or transparent plastic covered framed shall be provided for exterior wall openings during winter constructions.
- E. Provide wood members in lengths as long as practicable.
- F. For bolted work, bore holes of same diameter as bolts and drive bolts into place with snug fit with washers between bolt head and wood surface. Make tight at time of installation bolts and lag screws and retighten just before being enclosed by other work or at completion of work. Length of bolts shall be length to suit the condition. Embed bolts in concrete and solid masonry where possible and use expansion shields in drilled holes where not possible.
- G. Use number and size of nails to achieve rigid connections and prevent splitting. Bore holes at least one drill size smaller than nails to prevent splitting if necessary.
- H. Anchor nailers to adjacent construction with bolts 6 inches from ends and at intervals not more than 48 inches o.c. between.
- I. Install project sign where directed by the County. Sign shall remain in position for the duration of construction.
- J. Install, maintain and remove all staging for all trades required to reach all work.
- K. At completion, remove all excess materials and all resultant debris from the operations of work of this section. Leave work in neat, clean condition satisfactory for receipt of other related items of work which are to be installed under other sections.

END OF SECTION

SECTION 06200 FINISH CARPENTRY

PART 1 GENERAL

1.01 SCOPE OR WORK

Furnish all labor, materials, equipment and incidentals required to install all finish carpentry work complete as shown on the Drawings and as specified herein including wood shelving, cabinets, countertops and installing finish hardware on wood and hollow metal doors.

1.02 QUALITY STANDARDS

Architectural woodwork quality standards and guide specifications of the Architectural Woodwork Institute (AWI) shall apply and by reference are made part of this Specification.

1.03 SUBMITTALS

Submit shop drawings drawn in related or dimensional position with sections shown either half size of 3-inch scale. Indicate rough blocking and other work to which finish work is attached.

1.04 DELIVERY AND STORAGE

Do not deliver materials to job site until building and/or storage area is sufficiently conditioned to prevent damage by moisture, dampness, excessive humidity, extreme dryness, extreme heat and cold. Store materials and/or stack in such a way as to provide ventilation; minimize warping or twisting and otherwise provide protection recommended by fabricator.

1.06 JOB ASSEMBLED WORK

The General Contractor, when installing items not shipped assembled, shall distribute best over-all advantage the defects allowed in the quality grade specified.

PART 2 PRODUCTS

2.01 COUNTERS AND BUILT-IN CABINETS

- A. Counters and cabinets shall be in accordance with AWI casework Custom Grade Standards, Section 400.
- B. Counters and cabinets shall receive plastic laminate on all exposed surface and laminate shall be premium grade as defined in AWI Standards 400-16 and 400-17.
- C. Plastic Laminate: Comply with the requirements of "Publication No. LDI" by the National Manufacturer's Association (NEMA) for the following:
 - 1. All exposed surfaces: NEMA General - Purpose Type, nominal 0-062" thickness.
 - 2. Surface Finish: Provide plastic laminate having a gloss reading of 20 or less in colors as shown on the color schedule on the Drawings.
- D. Exposed Edges: Fabricate with plastic laminate matching other exposed surfaces, unless otherwise shown.

- E. Cut openings in plastic laminate finished tops for equipment which is to be installed under other Sections of these Specifications. Verify size of openings with actual size of equipment to be used, prior to making openings. Form inside corners to a radius of not less than 1/8-in. After sawing, rout and file cutouts to ensure smooth, crack-free edges. Seal exposed edges after cutting with a waterproofing material recommended by the plastic laminate manufacturer.

PART 3 EXECUTION

3.01 WORKMANSHIP

- A. Accurately set and rigidly secure finish woodwork to required lines and levels in accordance with final shop drawings and applicable standards or AWI Manual..
- B. Hand sand finish surfaces to free them of machine or tool marks that would show through transparent finish.
- C. Install all members in as long lengths as practicable. Cope internal joints and returns and miter external corners.

3.02 INSTALLATION OF HOLLOW METAL AND WOOD DOORS, AND FINISH HARDWARE

- A. Doors and finish hardware shall be as installed under the work of this Section, except where specifically designated otherwise herein.
- B. As soon as the hardware is delivered to the job site, receive, verify and check each set, and report to the County any defect or shortage. Give notice to the hardware supplier for all such items which may be defective or missing.
- C. Finish hardware, after checking, shall be the responsibility of the Contractor until it is installed and the project is accepted in its entirety by the County.
- D. Hardware shall be attached and placed by skilled mechanics in accordance with approved hardware templates provided with the hardware, and shall be accurately fitted and adjusted. Lever handles shall be kept covered with heavy cloth, and other hardware shall be protected from damage until final acceptance of the entire project by the County.
- E. For fire-rated doors, provide clearances complying with NFPA and local Fire Marshall's limitations.
- F. Set each edge and joint of threshold in a seal strip of polysulphide sealant.
- G. Adjust and check each operating item of hardware and each door, to ensure proper operation and function of every unit. Lubricate moving parts with type lubrication recommended by manufacturer (graphite-type if no other recommended). Replace units which cannot be adjusted and lubricated to operate freely and smoothly as intended for the application made.
- H. Wherever hardware installation is made more than one month prior to acceptance, return to the work during the week prior to acceptance or occupancy, and make a final check and adjustment of all hardware items in such space or area. Clean and relubricate operating items as necessary to restore proper function and finish of hardware and doors. Adjust door

control devices to compensate for final operation of heating and ventilating equipment.

END OF SECTION

SECTION 06600 FIBERGLASS REINFORCED POLYMER (FRP) PRODUCTS AND FABRICATIONS

PART 1 GENERAL

1.01 SUMMARY:

- A. This section includes the following FRP Products & Fabrications:
 - 1. FRP Pultruded Gratings and Treads
 - 2. FRP Structural Shapes and Plate
 - 3. FRP Standard Railings
 - 4. Molded Gratings and Treads

1.02 SCOPE OF WORK:

- A. Furnish all labor, materials, equipment and incidentals governed by this section necessary to install the fiberglass reinforced polymer (FRP) products as specified in the contract documents.

1.03 QUALITY ASSURANCE:

- A. The material covered by these specifications shall be furnished by an ISO-9001:2008 certified manufacturer of proven ability who is regularly engaged in the manufacture, fabrication and installation of FRP systems.

1.04 DESIGN CRITERIA:

- A. Design live loads of FRP gratings and floor panels shall not be less than 100 PSF uniformly distributed unless specifically stated otherwise in drawings. Grating and floor panel deflection at the center of a simple span not to exceed 0.25".
- B. Structural members shall be sized to support all applied loads. Deflection in any direction shall not be more than L/180 of span for structural members unless specifically stated otherwise in drawings and/or supplementary conditions. Connections shall be designed to transfer the loads.
- C. Temperature exposure is limited to 100°F unless specifically stated otherwise in drawings and/or supplementary conditions.

1.05 SUBMITTALS:

- A. Shop drawings of all fabricated pultruded gratings and treads, structural shapes and plate, standard railings, molded gratings and treads and appurtenances shall be submitted to the County for approval. Fabrication shall not start until receipt of County's approval.
- B. Manufacturer's catalog data showing:
 - 1. Materials of construction
 - 2. Dimensions, spacings, and construction of grating, handrails and building panels.
- C. Detail shop drawings showing:
 - 1. Dimensions
 - 2. Sectional assembly
 - 3. Location and identification mark

4. Size and type of supporting frames required

PART 2 PRODUCTS

2.01 GENERAL:

- A. Materials used in the manufacture of the FRP products shall be raw materials in conformance with the specification and certified as meeting the manufacturer's approved list of raw materials.
- B. The visual quality of the pultruded shapes shall conform to ASTM D4385.
- C. With the exception of molded gratings and treads, all FRP products noted shall be manufactured using a pultruded process utilizing vinyl ester resin with flame retardant and ultraviolet (UV) inhibitor additives. A synthetic surface veil fabric shall encase the glass reinforcement. FRP shapes shall achieve a flame spread rating of 25 or less in accordance with ASTM test method E-84, the flammability characteristics of UL 94 V0 and the self-extinguishing requirements of ASTM D635. (Polyester resin is available without flame retardant and UV inhibitor additives.)
- D. All cut ends, holes and abrasions of FRP shapes shall be sealed with a compatible resin coating.
- E. Should additional ultraviolet protection be required, a one mil minimum UV coating can be applied.
- F. All exposed surfaces shall be smooth and true to form, consistent with ASTM D4385.

PULTRUDED GRATINGS AND TREADS:

- A. General
 1. Grating shall be DURADEK® or DURAGRID® as manufactured by Strongwell or approved equal.
- B. Design
 1. The panels shall sustain a deflection of no more than 0.25" under a uniform distributed load of 100 PSF for the span lengths shown on the plans. See Strongwell's Fiberglass Grating brochure for a list of available sizes.
 2. Stair treads shall be capable of withstanding a uniform load of 100 PSF or a concentrated load of 300 lbs. on an area of 4 sq. inches located in the center of the tread, whichever produces greater stress and deflect less than 0.25".
 3. The top surface of all panels, gratings, and treads shall have a non-skid grit affixed to the surface by an epoxy resin followed by a top coat of epoxy resin.
 4. Hold down clamps shall be type 316L stainless steel clips. Use 2 at each support with a minimum of 4 per panel.
 5. Color shall be high visibility yellow or grey.

6. All shapes and fabrications that are to be exposed to UV shall be coated with polyurethane coating of a minimum thickness of 1 mil.

C. Products

1. The FRP grating and stair treads shall be fabricated from bearing bars and cross rods manufactured by the pultrusion process. The glass fiber reinforcement for the bearing bars shall be a core of continuous glass strand rovings wrapped with continuous strand glass mat. A synthetic surface veil fabric shall encase the glass reinforcement.

D. Fabrication of Standard Railing System

1. The fiberglass standard railing system shall be fabricated into finished sections by fabricating and joining together the pultruded square tube using molded or pultruded components; epoxy bonded and connected as shown in the fabrication details. Railing sections shall be fabricated to the size shown on the approved fabrication drawings and shall be piece marked with a water proof tag.

E. For Side Mount

1. Post shall be constructed with a pultruded bottom plug. Length shall be sufficient to extend a minimum of 1" beyond the uppermost bolt hole to prevent crushing of post tubing. Bolt holes shall provide clearance of 1/16" for 1/2" diameter bolts/studs. On square tubes, holes shall be on longitudinal center line of post, 1" from bottom of post (minimum) and not less than 3" apart on center. Posts shall be fastened with stainless steel anchor bolts or studs, 1/2" diameter.
2. Post locations shall be no greater than 18", nor less than 9" from horizontal or vertical change in handrail direction. For square tubes, post centers shall be no greater than 72" apart on any straight run or rail, or 48" apart on any inclined rail section.

F. Other Attachment Methods

1. Base mount, embedded and removable are also types of mounting procedures for railing. Design and calculations must be signed and sealed by a licensed Structural Engineer in the State of Florida and submitted to the County for approval.

G. Installation of Handrail Sections

1. The fabricated railing sections shall be supplied complete with fittings by the FRP manufacturer. The components used to join fabricated sections together may be shipped loose, to be epoxied and riveted, if required, together, if required in the field by the contractor.
2. The fabricated handrail sections shall be installed as shown on the approved shop drawings. The handrail sections shall be accurately located, erected plumb and level. The sections shall be fastened to the structure as shown on the approved shop drawings.

H. Approved Fabricators

1. Strongwell or approved equal.

2.02 MOLDED GRATING AND TREADS:

A. General

1. Grating shall be DURAGRATE® as supplied by Strongwell or approved equal.

B. Design

1. The grating shall be one piece construction with the tops of the bearing bars and cross bars in the same plane.
2. The mesh pattern and thickness shall be :
 - a. 3/4" square mesh, 1-1/2" thick
3. The standard resin systems and colors are: vinyl ester (high visibility yellow or grey).

C. Products

1. The FRP molded grating and treads shall be manufactured by the open mold process.
2. Molded stair treads shall be 1-1/2" thick in a 1-1/2" x 6" rectangular mesh pattern. The resin system will be the same as the molded grating. The stair tread shall come complete with anti-slip nosing.
3. Hold down clamps shall be:
 - a. Type M clips for attaching grating to supports
 - b. Type J clips for attaching grating to supports for moderate loads
4. Grating with cover plate
 - a. Grating shall be the same as described above in this section.
5. The cover plate for molded grating shall be an integrally molded plate as manufactured by Strongwell or approved equal.
 - a. The integrally molded plate may use the same resin as the grating.
 - b. The integrally molded plate shall be bonded to the grating, and a non-skid grit shall be affixed to the top surface of the assembly.

PART 3 EXECUTION

3.01 INSTALLATION, GENERAL:

- A. Fastening to in-place construction: Provide anchorage devices and fasteners where necessary for securing miscellaneous FRP fabrications to in-place construction; include

threaded fasteners for concrete and masonry inserts, toggle bolts, through-bolts, lag bolts and other connectors.

- B. Cutting, fitting and placement: Perform cutting, drilling and fitting required for installation of miscellaneous FRP fabrications. Set FRP fabrication accurately in location, alignment and elevation; with edges and surfaces level, plumb, true and free of rack; measured from established lines and levels.
- C. Provide temporary bracing or anchors in form work for items that are to be built into concrete masonry or similar construction.

END OF SECTION

SECTION 06900 WEIRS, BAFFLES AND SUPPORTS

PART 1 GENERAL

1.01 SCOPE OF WORK

- A. Furnish all labor, materials, equipment and incidentals required to repair to original strength and condition, complete and ready for service, all weirs, baffles, supports and butt plates including stainless steel hardware and of the sizes, shapes and the quantities as shown on the Drawings and as specified herein.

1.02 SUBMITTALS

- A. Submit to the County for approval, complete shop drawings showing details of fabrication and installation of all materials and equipment furnished as specified in the Contract Documents.
- B. The County, at his discretion, may request the Contractor to submit one 6-inch x 6-inch x 1/4-inch sample of polyester laminate to be used in the weirs, baffles, and supports, and one 6-inch long actual weir with anchor bolt hole.

PART 2 PRODUCTS

2.01 MATERIALS

- A. The replacement weirs, baffles, and supports shall be polyester plastic resin that are reinforced with fiberglass, of an established and reputable manufacturer who has had experience in the manufacture and installation of the equipment specified, and shall be Leo-Lite 87 as manufactured by F.B. Leopold Company, Inc., Zelienople, Pennsylvania or equal product manufactured by MFG Water Treatment Products Company, Ashtabula, Ohio, or equal.
- B. Weir plates and scum baffle plates produced from fabricated plate stock with cut edges, notches, etc., will not be acceptable.
- C. Weir plates and scum plates shall be fiberglass reinforced polyester resin laminate equal to Type "MD" (matched die) molded "Leo-Lite" plastic as stated above.
- D. All weir plates, scum baffle plates, butt plates, washers, and scum baffle support brackets shall be fiberglass reinforced polyester plastic molded by the matched die method to produce uniform, smooth surfaces. All surfaces shall be smooth, resin rich, free of voids and porosity, without dry spots, crazes, or unreinforced areas and shall provide for increased resistance and weathering.
- E. Laminate shall contain a glass content of 30 plus or minus 2 percent using Type "E" glass with chrome or silane finish. Powdered reinforcements shall consist of 47.5 plus or minus 1 percent of resin mixture. "Leo-Lite (141-120-32)" resin mixture shall be of the "Low Profile" type. Final laminate thickness shall be within plus or minus 10 percent of the nominal specified thickness. Laminate shall contain ultra-violet inhibitors added to protect the laminate from deterioration from sunlight.
- F. Manufacturer shall maintain a continuous quality control program and shall, upon request, furnish the County with certified test reports consisting of physical tests of samples as listed below and otherwise as required to show quality of plastic being furnished.

- G. Hardness test shall be made with the resin-rich surface of the product. Flexural tests shall be made with the resin rich surface in compression. Test samples shall be full thickness of the item produced and shall not be machined on the surface.
- H. Procedure to be used in determining the properties listed in the following tables shall be in accordance with the following ASTM Standards: Ultimate Tensile Strength - ASTM Designation D638, Modulus of Elasticity and Flexural Strength - ASTM Designation D790, Impact - ASTM Designation D256, Water absorption - ASTM Designation D 570.
- I. Minimum physical properties at a temperature of 70 degrees F for the plastic shall be as follows:

| | |
|---|-------------|
| Tensile Strength | 14,000 psi |
| Flexural Strength | 25,000 psi |
| Flexural Modulus | 900,000 psi |
| Impact, Nutches, Izod foot pound per inch | 13.5 |
| Barcol Hardness | minimum 35 |
| Average coefficient of thermal expansion - inch per inch, per degree F | 0.000016 |
| Water absorption, % 24 hours | 0.2 |

- J. The weir plates, baffle plates and supports shall be plastic laminate that is 1/4-inch thick and molded to the sizes and shapes as shown on the Drawings. Oversize holes shall be provided on the plastic laminate for vertical and horizontal adjustment. Cut ends of non-standard lengths of weirs and baffles shall be resin sealed with Leo-Lite (141-120-7) seal mix or approved equal.
- K. Stainless steel anchor bolts, nuts and washers shall be in accordance with ASTM A276, type 316.
- L. Caulking compound shall be an acrylic polymer or a two part sealant equal or exceeding Federal Spec. TT-S227B.

PART 3 EXECUTION

3.01 INSPECTION AND REPAIRS

- A. The weirs and baffles shall be inspected and repaired or replaced in full accordance with the manufacturer's recommendations. All holes, cracks and damage shall be repaired to bring them to original strength and condition.
- B. Weirs and baffles shall be restored on the stainless steel hardware to the elevations as shown on the Drawings. Caulking compound shall be used between the contact surface or weirs and face of concrete to completely prevent flow of liquid up between these contact surfaces.

END OF SECTION

DIVISION 7 THERMAL AND MOISTURE PROTECTION

SECTION 07100 WATERPROOFING, DAMPPROOFING AND CAULKING

PART 1 GENERAL

1.01 SCOPE OF WORK

- A. Furnish all materials, labor, equipment, and incidentals required to perform all through wall flashing work, waterproofing, dampproofing, caulking, and related work necessary for the proper completion of the project as required by the Drawings and as specified herein.
- B. Dampproof the exterior surfaces of all exterior poured- in-place concrete walls or concrete masonry foundation walls from the top of the footings up to 6 inches below finished grade.

1.02 APPLICABLE SCHEDULE

- A. Deliver all materials in original manufacturer's packages with labels and seals intact. Handle and store in accordance with manufacturer's instructions.
- B. Inspect job conditions for defects which would prevent proper installation of caulking. Do not proceed until defects have been corrected.
- C. Caulk all exterior wall joints between metal wall panels and adjacent materials, between frames in openings and adjacent materials, between masonry and cast-in-place concrete, brick paver expansion and control joints and all other joints shown on the Drawings or required for the completion of the Work.
- D. Caulk all interior joints between frames and masonry, at tops of masonry walls, between masonry and structural concrete, expansion and control joints in ceramic tile and brick pavers, exterior window and door frames, louvers, and all other joints shown on the drawings or required for the completion of the Work.
- E. Joints noted as "caulk", "caulking", or "sealant" shall be caulked with the sealant specified herein.
- F. Furnish and place through wall flashing in exterior masonry walls as shown on the Drawings.
- G. Furnish and place vapor barrier under all building structure slabs contacting soil as specified herein.

1.03 SUBMITTALS

Submit two representative samples of any or all other proposed materials and installation method required for the work of this Section as requested by the County.

PART 2 PRODUCTS

2.01 DAMPPROOFING

- A. Dampproofing shall be Bitumastic Black Solution by the Koppers Company, Inc., Dehydrating 4 by W.R. Grace and Co., or equal.

2.02 CAULKING

- A. Caulking Compound: One component, synthetic rubber base sealant, soft curing, nonstaining, conforming to F.S. TT-S-00230 and Thiocol's Building Trade Performance Specifications for Type 1 Class B sealants. Colors shall match material receiving caulking, as directed by the County.
- B. Interior Silicone Sealant: F.S. TT-001543 for perimeter of plumbing fixtures against walls and floors and joints between laminated plastic counters and walls shall be transparent.
- C. Primer: As recommended by caulking compound manufacturer.
- D. Back-up Material: Closed cell foam polyethylene, or similar nonbituminous material as recommended by manufacturer of caulking compound and completely compatible with selected compound.

2.03 HYDRAULIC CEMENT

- A. Material for quick-set hydraulic cement shall be Waterplug as manufactured by Thoro System Products, or equal.

2.04 VAPOR BARRIER

- A. Vapor barrier shall be 10 mil thick polyethylene sheet with a vapor transmission rating of 0.20 perms. Laps between adjacent sheets shall be 10 inches minimum. Vapor barrier shall be carefully inspected by the County prior to concrete placement. Additional polyethylene sheet required for repair or replacement of damaged vapor barrier shall be furnished and installed by the Contractor as directed by the County at no additional cost to the County.

PART 3 EXECUTION

3.01 INSTALLATION

- A. Installation of Dampproofing
 1. Surface to be treated shall be free from oil and dirt and shall be in the proper condition as indicated by the manufacturer prior to the application of the dampproofing material. The concrete shall have been completely cured and the surface shall be dry and free from frost at the time of application.
 2. Surfaces to be dampproofed shall receive two (2) heavy coats 10 mils thick, the first coat being carefully applied so that "holidays" or untreated air-bubble depressions in the surface shall be completely filled and the second coat will guarantee a 100% coating of the surface.
 3. Particular care shall be given to the application of dampproofing at all construction joints which are encountered.
 4. The number of coats specified is in addition to primer coats as recommended by the manufacturer.
- B. Installation of Caulking
 1. Surface Preparation: Clean metal surfaces free of grease, oil, wax, lacquer, and other foreign residue by wiping with a clean cloth moistened with a suitable solvent. Scrape or brush masonry surfaces clean. Apply appropriate primer to contact surfaces.

2. Joint Preparation: Joints to be caulked having a depth in excess of 3/8-inch shall be packed with back-up material. Round back-up material shall be sized to require 20 percent to 5 percent compression upon insertion. In joints not of sufficient depth to allow packing, install polyethylene bond-breaking tape at back of joint. Avoid lengthwise stretching of back-up material. Cut all corners, avoid wrapping around corners.
3. Application: Apply compound with pressure flow gun with nozzle of proper size and shape to suit width of joint, promptly after mixing and with sufficient pressure to fill joint. Apply as a continuous operation horizontally in one direction and vertically from bottom to top, except joints having excessive widths where compound might sag, the joints shall be built up with excessive beads. Finish joints smooth and slightly covered.
4. Cleaning: Immediately clean adjacent material which may be soiled by caulking operation.

C. Installation of Quick-Set Hydraulic Cement

1. The surface shall be cleaned and free of dirt, loose mortar particles, paints, films, protective coatings, efflorescence, laitance, form treatments, curing compounds, and other materials.
2. Cut out crack at least 3/4 inches wide and deep, cutting back into wall slightly. Flush away all cuttings and dirt. Force water-plug into prepared crack with a round tool and smooth out. Form cove at junction.
3. To be applied under manufacturer's recommendations.

END OF SECTION

DIVISION 8 DOORS AND WINDOWS

SECTION 08100 METAL DOORS AND FRAMES

PART 1 GENERAL

1.01 SCOPE OF WORK

- A. Furnish all labor, materials, equipment, and incidentals required to deliver the following as shown on the Drawings and as specified herein:
1. Steel hollow-metal doors with louvered vent and dead-bolt lock.
 2. Pressed-metal frames.
 3. All fasteners and appurtenances required.

1.02 SUBMITTALS

- A. Submit to the County for review, as provided in the General Conditions and Section 01340, shop drawings of all metal doors, frames, panels and appurtenances.
- B. Shop drawings shall show elevations and details of doors and frames, location and installation requirements for hardware, thickness of materials, joints and connections and trim.
- C. Hardware templates shall be furnished to the door manufacturer by the Contractor for correct hardware alignment and reinforcing.

1.03 DELIVERY, STORAGE AND HANDLING

- A. Deliver material in manufacturer's original unopened and undamaged packages with labels legible and intact. Doors and panels shall be individually wrapped in corrugated cardboard with wood strips on vertical edges and banded with metal straps. Store materials in unopened packages in a manner to prevent damage from the environment and construction operations. Handle in accordance with manufacturer's instructions.

PART 2 PRODUCTS

2.01 MATERIALS FOR STEEL DOORS

- A. Hollow metal doors and panels (steel) shall be 1-3/4" full flush and as manufactured by Steelcraft Manufacturing Company, Republic Steel, Ceco Steel or equal. The face panels shall be formed of 16 gauge, cold-rolled leveled sheet steel conforming to ASTM A526 galvanized in conformance with ASTM A525, 1.25 oz. zinc per square foot. Doors shall be fabricated to receive all hardware specified. Hinge reinforcement shall be 8 gauge. Closer and other hardware reinforcement shall be 12 gauge. Provide "L" shape 12 gauge galvanized steel astragals on exterior double doors. Doors shall be reinforced, stiffened, sound deadened and insulated with impregnated kraft honeycomb core completely filling inside.
1. Door louvers shall be integrally framed, 1" deep, 45 degrees, "Z" blade, stationary type of aluminum with clear finish. The maximum size of the louvered vent shall be 16" wide and 12" high. An insect screen shall be attached on inside of vent.
 2. Wherever fire labeled classification is shown or scheduled for hollow metal work, provide fire-rated hollow metal doors and frames investigated and tested as a fire door assembly, complete with type of fire door hardware to be used. Identify each fire door and frame

- with UL labels, indicating applicable fire rating of both door and frame.
3. Construct fire labeled assemblies to comply with NFPA Standard No. 80, and as herein specified.

- B. Pressed Metal Frames (steel) for hollow metal doors and transoms shall be 14 gauge cold-rolled steel, formed with integral stops and rabbets, and shall be made by the same manufacturer as the doors. Frames shall be furnished as set-up assemblies with arc welded and smooth ground miters. The jambs shall be constructed to set on the finished slab. Provide tee shaped, masonry anchors at all jambs with one anchor at each course. The frames shall be mortised, reinforced, drilled, and tapped for hinges and strike plates and other hardware specified. All frames shall be provided with a steel spreader temporarily attached to the feet of both jambs to serve as a brace during shipping, handling and installations.
- C. All pressed metal frames shall be weatherstripped.
- D. Anchors and fastening devices shall be galvanized steel.
- E. All pressed metal frames in masonry openings shall be fully grouted with mortar.
- F. Pressed metal frames shall be primed and painted as noted in Section 09900.

2.02 FINISH FOR STEEL DOORS

- A. The doors, panels, frames, etc., shall receive one (1) field coat of primer and one (1) field coat of finish paint as specified in Painting Section 09900.

2.03 HARDWARE

- A. Door Closers: The door closers shall be steel and shall be rated for standard duty application.
- B. Locksets: The locksets shall be dead-bolt locks. Each lockset shall be furnished with two (2) keys and all locks shall be keyed alike.
- C. Hardware Supplier
 1. The door manufacturer shall furnish all requisite hardware. The hardware shall be enclosed in the original packaging along with the hardware manufacturer's installation instructions.
 2. The Contractor shall be responsible for properly storing, handling and installing the hardware once it reaches the job site.

PART 3 EXECUTION

3.01 INSTALLATION

- A. The Contractor shall install the doors, frames, thresholds and hardware in strict accordance with the instructions and recommendations of the manufacturers and the approved shop drawings. The installations shall also be in full compliance with the applicable portions of Steel Door Institute SDI-100.
- B. The frames shall be installed plumb and square and shall be securely attached to the structure before the spreader bars are removed.

- C. The doors shall be hung plumb and square within the frames and shall not bind at any point. The Contractor shall not cut or otherwise alter the door to fit the frame. Should the door and frame not properly mate, the Contractor shall consult with the door manufacturer for remediation instructions.
- D. The thresholds shall be installed in such a manner as to provide a smooth, trip-free pathway through the doorway for both ingress and egress.
- E. After the doors are property hung in the frames and the thresholds are installed, the Contractor shall attach the kickplates, door closers and locksets to the doors in a thoroughly workmanlike manner.
- F. After the door installations are completed, the Contractor shall take adequate precautions to protect the exposed surfaces from damage by both environmental conditions and construction activity.

3.02 TESTS

- A. After installation, the Contractor shall check the doors and attached appurtenances for proper operation.
- B. The doors shall swing smoothly and freely without binding, the door closers shall allow both an easy opening and a "slamless" closing, and the keys shall freely lock and unlock the locksets without any binding of the locking plunger..

3.03 GUARANTEES AND WARRANTIES

- A. The Contractor shall guarantee and/or warrant the door installations against defects in materials and workmanship in accordance with the requirements of Section 01740 of these Specifications.

END OF SECTION

SECTION 08200 FIBERGLASS REINFORCED PLASTIC DOORS AND FRAMES

PART 1 GENERAL

1.01 SCOPE OF WORK

- A. Furnish all labor, materials, equipment, tools and incidentals required to install, test and place in service the fiberglass reinforced plastic doors and frames as well as the associated anchors and hardware as hereinafter specified and/or shown on the Contract Drawings.

1.02 SUBMITTALS

- A. The requirements of Section 01340 shall be met - i.e., the Contractor shall submit to the County for review, complete shop drawings, working drawings and product data showing all dimensions and details of fabrication, installation and operation of the doors, frames, anchors and hardware.

1.03 DELIVERY, STORAGE AND HANDLING

- A. Deliver the doors, frames, anchors and hardware in the manufacturer's original packaging. The packaging shall be unopened, undamaged, and with the labels legible and intact.
- B. Store the doors, frames, anchors and hardware in the unopened original packaging until needed. Storage shall be in such a manner as to prevent damage from either environmental conditions and/or from construction activities.
- C. Handle the packaged products in accordance with the manufacturer's instructions.

1.04 MANUFACTURER

- A. In order to match the existing architecture and to minimize spare parts requirements, the doors and frames shall be as manufactured by CHEM-PRUF Door Company of Brownsville, Texas. CHEM-PRUF shall also furnish the anchors and hardware for the door installations.

PART 2 PRODUCTS

2.01 MATERIALS

- A. FIBERGLASS REINFORCED PLASTIC (FRP)
 - 1. All door panels, stiles and rails, frames, thresholds, and "header to jamb" joint clips shall be fabricated from FRP. The resins used to formulate the FRP shall be premium grade iso-polyesters, shall be both USDA and FDA approved, and shall be specially formulated to withstand the rigors of a water treatment facility environment. The FRP laminates used shall have a glass to resin ratio of 30% to 70% for superior strength and a minimum R-value of 11.
- B. Balsa Wood
 - 1. All door cores shall be fabricated from end-grain balsa wood. Alternatively, either a 4-6 pound density polyurethane foam or a phenolic coated Kraft Honeycomb may be used.

C. STAINLESS STEEL

1. All door anchors and, to the extent possible, all hardware items - screws, nuts, bolts, fasteners, clips, washers, kickplates, hinges, locksets, door closer, etc. - shall be fabricated from stainless steel.

2.02 FABRICATION

A. DOORS

1. The doors shall be 1-3/4-inches thick and shall be composed of an end-grain balsa wood core sandwiched between FRP panels and stiles and rails. The doors shall be of flush construction without seams or cracks. All mortises shall be molded in at the factory.
 - a. Door Cores
 - 1) The door cores shall be formed from end-grain balsa wood impregnated with lightweight resin. Alternatively, either a 4-6 pound density polyurethane or a phenolic coated Kraft Honeycomb may be used.
 - b. Door Panels
 - 1) The door panels shall have a nominal thickness of 1/8-inch and shall be molded in one continuous piece using at least two layers of 1.5-ounce per square foot fiberglass mat and a layer of 16-ounce per square yard unidirectional glass roving.
 - 2) The door panels shall be coated with a white gel, 15 mils minimum thickness, with a mirror-like finish of 88 or better per ASTM D-523. The gel coat shall be classified as self-extinguishing and shall be Neste Polyester, Inc., 7000 Series, or approved equal.
 - c. Stiles and Rails
 - 1) Stiles and rails shall be constructed from the outside to the inside starting with a 15-20 mil coat of white gel followed by a matrix of at least three layers of 1.5-ounce per square foot fiberglass mat.
 - 2) The stile and rail shall be molded in one continuous U-shaped piece to the exact dimensions of the door. Pultrusions will not be acceptable for stiles and rails under this Specification.
 - d. Reinforcement
 - 1) To accommodate the mounting of such items as hinges, locksets, door closers, kickplates, etc., reinforcing and/or compression members shall be provided.
 - 2) Sixteen gauge mild steel plates shall be used wherever practical. The plates shall be totally molded in and completely covered by the fiberglass matrix - no exposed surfaces will be allowed. In no case shall screws be used into the fiberglass matrix for holding any structured attachment.

B. FRAMES

1. The frames shall be similar to the door panels in construction except that the frames shall be solid fiberglass.
2. The stop and frame shall be molded all in one piece which shall be integrally white gelcoated to match the door panels. The stop shall cover the door by no less than 3/8-inch when the door is in the closed position.
3. Mortises shall be molded into the frames. Routing-in mortises or removing any material

from the head or jambs to provide mortises will not be acceptable under this Specification.

4. The frames shall have standard steel door institute dimensions - i.e., a 2-inch face and a 5-3/4-inch profile.
5. The jambs shall be flat on the backside (against the opening) and uniform in thickness so as to provide a solid, uniform flat surface against the wall opening. The use of wood blocks and/or spacers will not be acceptable under this Specification.
6. Reinforcement for mounting hinges, etc., shall be 16-gauge mild steel plates totally molded in and completely covered by the fiberglass matrix - no exposed surfaces will be allowed. In no case shall screws be used into the fiberglass matrix for holding any structured attachment.

2.03 **HARDWARE**

A. **HARDWARE SUPPLIER AND INSTALLER**

1. The door manufacturer shall furnish all requisite hardware. The hardware shall be enclosed in the original packaging along with the hardware manufacturer's installation instructions.
2. The Contractor shall be responsible for properly storing, handling, and installing the hardware once it reaches the job site.

B. In order to match the existing architecture and to minimize spare parts requirements, the following items of hardware shall be furnished as listed, NO SUBSTITUTIONS:

1. Hinges - 4-1/2" x 4-1/2", half surface, stainless steel, CHEM-PRUF HSSS US 32D NRP.
2. Kickplates - 10" x 34", stainless steel, Trimco 10 x 34 SS 32D.
3. Door Closers, stainless steel arm, 1600 Series, Norton SB 1604 SS Arm.
4. Locksets - Mortise Lockset, ML2200 Series, Corbin/Ruswin 2251 NSAxM26 32D.
5. Threshold - Fiberglass, with grit finish, CHEM-PRUF CP FRP W/Grit Fin.

PART 3 **EXECUTION**

3.01 **INSTALLATION**

- A. The Contractor shall install the doors, frames, thresholds and hardware in strict accordance with the instructions and recommendations of the manufacturers and the approved shop drawings. The installations shall also be in full compliance with the applicable portions of Steel Door Institute SDI-100.
- B. The frames shall be installed plumb and square and shall be securely attached to the structure before the spreader bars are removed.
- C. The doors shall be hung plumb and square within the frames and shall not bind at any point. The Contractor shall not cut or otherwise alter the door to fit the frame. Should the door and frame not properly mate, the Contractor shall consult with the door manufacturer for remediation instructions.
- D. The thresholds shall be installed in such a manner as to provide a smooth, trip-free pathway through the doorway for both ingress and egress.
- E. After the doors are properly hung in the frames and the thresholds are installed, the Contractor

shall attach the kickplates, door closers and locksets to the doors in a thoroughly workmanlike manner.

- F. After the door installations are completed, the Contractor shall take adequate precautions to protect the exposed surfaces from damage by both environmental conditions and construction activity.

3.02 TESTS

- A. After installation, the Contractor shall check the doors and attached appurtenances for proper operation.
- B. The doors shall swing smoothly and freely without binding, the door closers shall allow both an easy opening and a "slamless" closing, and the keys shall freely lock and unlock the locksets without any binding of the locking plunger.

3.03 GUARANTEES AND WARRANTIES

- A. The Contractor shall guarantee and/or warrant the door installations against defects in materials and workmanship in accordance with the requirements of Section 01740 of these Specifications.
- B. The door manufacturer shall unconditionally guarantee the doors for 10-years against failures due to corrosion from environmental conditions surrounding a water treatment facility.

END OF SECTION

SECTION 08331 OVERHEAD DOORS

PART 1 GENERAL

1.01 SCOPE OF WORK

- A. Furnish all labor, material, equipment, tools and incidentals required to install, test and place in service the overhead doors as hereinafter specified and/or shown on the Contract Drawings.

1.02 SUBMITTALS

- A. The requirements of Section 01340 shall be met, i.e., the Contractor shall submit to the County for review complete shop drawings, working drawings and product data including all dimensions and details of fabrication, installation and operation of the overhead doors.

1.03 DELIVERY, STORAGE AND HANDLING

- A. Deliver the overhead doors in the manufacturer's original packaging. The packaging shall be unopened, undamaged, and with the labels legible and intact. Handle the packaged products in accordance with the manufacturer's instructions.
- B. Store the overhead doors in the unopened original packaging until needed. Storage shall be in such a manner as to prevent product damage from either environmental conditions and/or from construction activities.

1.04 MANUFACTURER

- A. All the overhead doors shall be the product(s) of a single American manufacturer.

PART 2 PRODUCTS

2.01 TYPE

- A. The overhead doors shall be the roll-up coiling type, sized as shown on the Contract Drawings, with an overhead storage hood.

2.02 MOUNTING

- A. The overhead doors shall be suitable for face-of-wall mounting on the inside wall of the structures where shown on the Contract Drawings.

2.03 WINDLOAD DESIGN

- A. The overhead doors shall be designed in such a manner as to be able to safely withstand a continuous windload of 35 pounds per square feet.

2.04 MATERIALS

- A. The curtains shall be fabricated from interlocking flat profile slats (F-3) made from cold rolled galvanized steel. The thickness of slat material to be as required by width of opening and windloading conditions. The interlocking shall be continuous along both the top and bottom edges of the slats. Endlocks shall be attached to each end of alternate slats to prevent lateral movement. The slats shall be provided with slat lugs as windlocks. The rolling service doors

shall be Model S21PS as manufactured by Atlas Roll-Lite Door Corporation, or approved equal.

- B. The curtain shall be provided with a bottom bar for reinforcing and rigidity. The bottom bar shall be finished to match the slats and shall also be equipped with a bottom weather seal.
- C. The curtain shall be provided with guides on both sides to ensure smooth curtain operation and to restrain the curtain against the windloading of 35 pounds per square foot. The guides shall be equipped with windlock bars to meet the design windloading and shall also be fitted with weatherproof flexible seals along their full length. The guides shall be fabricated from either heavy gauge structural steel or galvanized steel, whichever material the manufacturer recommends for the particular installation. They shall be finished to match the slats.
- D. Plate brackets shall be provided to support the curtain and the counterbalance on sealed, self-aligning ball bearings. A stiffening rib shall be added to the brackets to add extra strength and to support the hood. The brackets shall be fabricated from either heavy gauge structural steel or galvanized steel, whichever material the manufacturer recommends for the particular installation. They shall be finished to match the slats.
- E. The counterbalance shall be composed of adjustable helical torsion springs housed in a tube or pipe barrel of appropriate material. The spring tension shall be readily adjustable by means of an easily accessible tension wheel. The counterbalance assembly shall be computer designed to effectively counterbalance the curtain for a minimum life span of 20,000 cycles with a deflection not to exceed .03-inch per foot of span width.
- F. A hood shall be provided to house the coiled curtain and the counterbalance and to shield them against dust, dirt and premature wear. The hood shall be fabricated from #24 U.S. gauge galvanized steel and shall be finished to match the slats. The hood shall be equipped with stiffening ribs at both the top and the bottom and with intermediate supports as required. The hood shall be furnished with an internal baffle weatherstrip extending its full length.

2.05 OPERATION

- A. The overhead doors shall be operated by the use of a manual chain hoist mechanism carefully matched to the door's counterbalance system to ensure precision operations and a long life. The hand chain pull is not to exceed 35 lbs. (156N).

2.06 LOCKING

- A. The manual chain hoist mechanisms shall be equipped with chain keeper locks capable of being padlocked. The Contractor shall furnish one (1) padlock with two (2) keys for each chain hoist mechanism. All locks shall be keyed alike.

2.07 FINISH FOR OVERHEAD DOORS

- A. The slats shall have a shop coat of baked primer paint. All ungalvanized metal surfaces shall have a shop coat of rust inhibiting metallic primer on exposed ferrous surfaces, except bearings.
- B. The curtain, hood, brackets, supports, etc., shall receive one (1) field coat of primer and one (1) field coat of finish paint as specified in Painting Section 09900.

PART 3 EXECUTION

3.01 INSTALLATION

- A. The overhead doors shall be installed in the locations shown on the Contract Drawings. The door installations shall be in strict accordance with the manufacturer's standards and written procedures and instructions.

3.02 ALIGNMENT

- A. All vertical surfaces and lines shall be plumb, and all horizontal surfaces and lines shall be level.

3.03 CLEANING AND LUBRICATING

- A. After installation, but before testing, the overhead doors shall be thoroughly cleaned to remove contaminants (greasy fingerprints, dirt, grime, oil stains, concrete splatters, etc.) to which they may have been subjected during installation.
- B. After installation, but before testing, all parts of the overhead door assemblies which require lubrication for proper operation shall be lubricated with the type and quantity of lubricant(s) recommended by the manufacturer in his installation and/or operating instructions.

3.04 TESTING

- A. The overhead doors shall be thoroughly tested through the full range of their operation from fully closed to fully open. The operation shall be smooth, quiet, free from squeaking and/or binding, and without excessive chain force.
- B. The curtains shall remain fully aligned throughout both the coiling and the uncoiling processes. Distortion of any form in the curtains will not be acceptable!
- C. The curtains shall be stoppable at any intermediate position during either the coiling or the uncoiling process and shall remain stationary in that intermediate position until actuated by movement of the hoist chain.
- D. The testing shall be witnessed by authorized representative(s) of both the County and the manufacturer (see Item 3.05 below). The County shall be notified, in writing, at least two (2) days before the testing.
- E. Any shortcomings and/or deficiencies in either the installation or operation of the overhead doors brought out during the testing shall be corrected/remedied to the mutual satisfaction of the representatives cited in Item 3.04.D above. Any such correction/remediation shall be solely at the Contractor's expense with no additional cost to the County.

3.05 MANUFACTURER'S REPRESENTATIVE

- A. The Contractor shall arrange for an authorized representative of the overhead doors' manufacturer to assist him on an "as needed" basis during the installation of the doors. However, the authorized representative must be present when the doors are tested.

3.06 GUARANTEES AND WARRANTIES

- A. The Contractor shall guarantee and/or warrant, in writing, the overhead doors against defects

in materials, construction, operation and workmanship as provided for in Section 01740 of these Specifications.

END OF SECTION

DIVISION 9 PAINTING

SECTION 09150 CEMENT PLASTER (STUCCO)

PART 1 GENERAL

1.01 SCOPE OF WORK

- A. Furnish all labor, materials, equipment and incidentals required to install cement plaster (stucco).

1.02 QUALITY ASSURANCE

- A. Portland Cement Plastering Standards - ASTM A42.2 and A42.3.

1.03 SUBMITTALS

- A. Submit to the County, as provided in Section 01340, a listing of brand names and types of materials proposed for use in the work of this Section.

1.04 PRODUCT DELIVERY, STORAGE AND HANDLING

- A. Deliver materials in sealed containers and bundles, fully identified with manufacturer's name, brand, type and grade; store on pallets in dry, well ventilated space, protected from the weather, under cover and handle in accordance with manufacturer's recommendations.

1.05 JOB CONDITIONS

- A. Examine the substrates of the areas to receive the stucco and the conditions under which the work is to be performed. Notify the County, in writing, of conditions detrimental to the proper completion of the work. Do not proceed with the installation until unsatisfactory conditions have been corrected in an acceptable manner.
- B. Environmental conditions: Maintain a minimum temperature of 50 degrees F in spaces being plastered. Maintain adequate continuous ventilation in plastered spaces until plaster is dry. Protect plaster from freezing and too rapid drying. Do not plaster on rusted metal materials.
- C. Protect other work from soiling, spattering, moisture deterioration and other harmful effects which may result from plastering operations.

PART 2 PRODUCTS

2.01 MATERIALS

- A. Stucco Accessories
 - 1. Stucco accessories shall be produced from weatherproof PVC as manufactured by VinylTech Accessories, Plastic Components, Inc., or equal.
 - 2. Corner beads shall be No. 1 Corner Bead.
 - 3. Soffit external corner beads shall be No. 540 Drip Screed.
 - 4. Casing beads shall be No. 10 Casing Bead.
 - 5. Control joints shall be No. 20M Joint.

B. Plaster Materials

1. Portland cement shall conform with ASTM C150, Type I or IA.
2. Lime shall be special finishing hydrated lime conforming to ASTM C206, Type S.
3. Sand shall be clean, sharp, washed, natural and free from soluble salts and organic matter. Sand shall comply with ASTM C35 and when dry, shall pass No. 4 sieve.
4. Fiber shall be pure manilla, glass or synthetic fiber, good quality 1/2" to 2" in length, free from grease, oil, dirt and other impurities. No asbestos will be allowed.
5. Water shall be clean, fresh, potable water.

PART 3 EXECUTION

3.01 THREE COAT PLASTERING

A. Portland cement plaster shall be three-coat work on CMU walls with a minimum thickness of 3/4". Exterior three-coat cement plaster (stucco) shall be made waterproof during and/or after application of one or more coats. Waterproofing materials shall be a product of Thoro System Products, Miami, Florida, or equal. Contractor shall be responsible for scheduling a review meeting with the supplier's technical representative and the County to determine the specific product and application techniques most appropriate for the masonry walls prior to the beginning of the stucco work.

B. Proportions and Mixing

1. All plaster shall be proportioned by weight. The materials shall be weighed by an approved weighing device. Measuring with a shovel will not be permitted.
2. All plaster shall be mechanically mixed. Hand mixing will not be permitted. Mixer to be cleaned after each batch is dumped. Retempering of partially set material is not permitted. Discard plaster which has begun to stiffen.
3. Scratch and brown coats shall be 100 lbs. Portland cement, 10 lbs. hydrated lime and not more than 300 lbs. sand. Add 2 lbs. fiber to scratch coat.
4. Finish coat shall be mixed in proportions of 100 lbs. Portland cement to 10 lbs. hydrated lime mixed with 200 lbs. sand.

C. Moisture Retention and Curing

1. Dampen previous plaster coats which have dried out prior to time for applications of next coat. Dampen with water as required for uniform suction.
2. Determine the most effective procedure for curing and the time lapse between application of coats based on climatic and job conditions. Plaster which is cracked or crazed due to improper timing and curing will not be accepted. Remove and replace defective plaster including plaster base materials, if damaged during removal of defective plaster.

3.03 CUTTING AND PATCHING

A. Cut, patch, point-up and repair plaster as necessary to accommodate other work and to restore cracks, dents and imperfections. Repair or replace work to eliminate blisters, excessive crazing and check cracking, dryouts, efflorescence, sweat-outs and similar defects, including areas of the work which do not comply with specified tolerances, and where bonding to the substrate has failed.

- B. Provide approved procedures for protection of plaster from deterioration and damage during the remainder of the construction period.

END OF SECTION

SECTION 09865 SURFACE PREPARATION AND SHOP PRIME PAINTING

PART 1 GENERAL

1.01 SCOPE OF WORK

Furnish all labor, materials, equipment and incidentals required for the surface preparation and application of shop primers on ferrous metals, excluding stainless steels, as specified herein.

1.02 SUBMITTALS

- A. Submit to the County for approval, as provided in the Contract Drawings for shop drawings, manufacturer's specifications and data on the proposed primers and detailed surface preparation, application procedures and dry mil thickness.
- B. Submit representative physical samples of the proposed primers, if required by the County.

PART 2 PRODUCTS

2.01 MATERIALS

- A. Submerged Services: Shop primer for ferrous metals which will be subject to splash action or which are specified to be considered submerged service shall be sprayed with one coat of Koppers 654 epoxy Primer or Koppers Inertol Primer 621-FDA, dry film thickness 3.5 to 4.5 mils by Koppers Co., Inc., or equal.
- B. Nonsubmerged Services: Shop primer for ferrous metals other than those covered by paragraph 2.01 A shall be sprayed with one coat of Koppers Pug Primer, dry film thickness 3.0 to 4.0 mils by Koppers Co., Inc. or equal.
- C. Nonprimed Surfaces: Gears, bearing surfaces, and other similar surfaces obviously not to be painted shall be given a heavy shop coat of grease or other suitable rust-resistant coating. This coating shall be maintained as necessary to prevent corrosion during all periods of storage and erection and shall be satisfactory to the County up to the time of the final acceptance.
- D. Compatibility of Coating Systems: Shop priming shall be done with primers that are guaranteed by the manufacturer to be compatible with their corresponding primers and finish coats specified in the Contract Documents for use in the field and which are recommended for use together.

PART 3 EXECUTION

3.01 APPLICATION

- A. Surface Preparation and Priming:
 - 1. Non submerged components scheduled for priming, as defined above, shall be sandblasted clean in accordance with SSPC-SP-6, Commercial Grade, immediately prior to priming. Submerged components scheduled for priming, as defined above, shall be sandblasted clean in accordance with SSPC-SP-10. Near White, immediately prior to priming.

2. Surfaces shall be dry and free of dust, oil, grease, dirt, rust, loose mill scale and other foreign material before priming.
3. Shop prime in accordance with approved paint manufacturer's recommendations.
4. Priming shall follow sandblasting before any evidence of corrosion has occurred and within 24 hours.

END OF SECTION

SECTION 09900 PAINTING

PART 1 GENERAL

1.01 SCOPE OF WORK

- A. The Contractor shall furnish all labor, tools, materials, equipment, scaffolding or other structures and incidentals necessary to complete this Contract in its entirety.
- B. The work includes painting and finishing of all new interior and exterior exposed items above and below grade and surfaces, such as structural steel, miscellaneous metals, ceilings, walls, floors, doors, frames, transoms, roof fans, construction signs, guardrails, posts, fittings, valves, tanks, equipment and all other work obviously required to be painted unless otherwise specified herein or on the Drawings. The omission of minor items in the Schedule of Work shall not relieve the Contractor of his obligation to include such items where they come within the general intent of the Specification as stated herein.
- C. The following items shall not be painted:
1. Any code-requiring labels, such as Underwriter's Laboratories and Factory Mutual, or any equipment identification, performance rating, name or nomenclature plates.
 2. Any moving parts of operating units, mechanical and electrical parts, such as valve and damper operators, linkages, sinkages, sensing devices, motor and fan shafts, unless otherwise indicated.
 3. Aluminum handrails (except where in contact with concrete) walkways, windows, louvers and grating unless otherwise specified herein.
 4. Signs and nameplates.
 5. Finish hardware.
 6. Chain link fence.
 7. Piping buried in the ground or embedded in concrete.
 8. Concealed surfaces of pipe or crawl space.
 9. Nonferrous metals, unless specifically noted otherwise.
 10. Electrical switchgear and motor control centers.
 11. Stainless steel angles, tubes, pipe, etc.
 12. Products with polished chrome, aluminum, nickel or stainless steel finish.
 13. Plastic switch plates and receptacle plates.
 14. Flexible couplings, lubricated bearing surfaces, insulation and metal and plastic pipe interior.
 15. Sprinkler heads.
 16. Lifting chain on cranes and hoists
 17. Electrical cable, festooned conductor system, cables, collector pole brackets, etc.
- D. All work shall be done in strict accordance with this Specification, the Design Drawings and the painting package, including manufacturer's printed instructions.
- E. The Contractor will obtain, at its own expense, all permits, licenses and inspections and shall comply with all laws, codes, ordinances, rules and regulations promulgated by authorities having jurisdiction which may bear on the Work. This compliance will include Federal Public Law 91-596 more commonly known as the "Occupational Safety and Health Act of 1970".

1.02 DEFINITIONS

- A. Field Painting is the painting of new or rebuilt items at the job site. Field painting shall be the responsibility of the Contractor.
- B. Shop Painting is the painting of new or rebuilt items in the shop prior to delivery to the jobsite.
- C. Abbreviations The abbreviations and definitions listed below, when used in this specification, shall have the following meanings:
 - 1. SSPC - Steel Structures Painting Council
 - 2. Exterior - Outside, exposed to weather
 - 3. Interior Dry - Inside, concealed or protected from weather
 - 4. Interior Wet - Inside, subject to immersion services
 - 5. ASTM - American Society of Test Materials
 - 6. NACE - National Association of Corrosion Engineers
 - 7. NSF - National Sanitation Foundation
 - 8. AWWA - American Water Works Association
- D. Dry Film Thickness shall be in Mils.

1.03 RESOLUTION OF CONFLICTS

- A. It shall be the responsibility of the Contractor to arrange a meeting prior to the start of painting, or flooring installation between the Contractor, the Paint Manufacturer, whose products are to be used, and the County. All aspects of surface preparation, application and coating systems as covered by this Specification will be reviewed at this meeting.
- B. Clarification shall be requested promptly from the County when instructions are lacking, conflicts occur in the Specifications, or the procedure seems improper or inappropriate for any reason.
- C. Copies of all manufacturer's instructions and recommendations shall be furnished to the County by the Painting Contractor.
- D. It shall be the responsibility of the Coating Manufacturer to have their factory representative meet in person with the Contractor and County a minimum of three times during the job as a consultant on surface preparation, mil thickness of coating and proper application of coating unless meeting is determined to be unnecessary by the County.

1.04 SUBMITTALS

- A. Contractor shall submit catalog data and cut sheets for the painting system being used if not the TNEMEC materials specified.
- B. Samples as detailed in 3.01 B shall be submitted regardless of system being used, showing each color to be used.
- C. Hazardous Material Disposal documentation shall be submitted if applicable.

PART 2 PRODUCTS

2.01 EQUIPMENT

- A. Effective oil and water separators shall be used in all compressed air lines serving spray painting and sandblasting operations to remove oil or moisture from the air before it is used. Separators shall be placed as far as practicable from the compressor.
- B. All equipment for application of the paint and the completion of the work shall be furnished by the Contractor in first-class condition and shall comply with recommendations of the paint manufacturer.
- C. Contractor will provide free of charge to the County a "Nordson-Mikrotest" or "Positest" dry film thickness gauge for ferrous metal and an OG232 "Tooke" gauge or equal for non-ferrous and cementitious surface, to be used to inspect coatings by the County and Contractor. The gauges may be used by the Contractor and returned each day to the County. County will return gauges to Contractor at completion of job.

2.02 MATERIALS

- A. All materials specified herein are manufactured by the TNEMEC Company, Inc., North Kansas City, Missouri. These products are specified to establish standards of quality and are approved for use on this Project.
- B. Equivalent materials of other manufacturers may be substituted on approval of the County. Requests for substitution shall include manufacturer's literature for each product giving the name, generic type, descriptive information and evidence of satisfactory past performance and an independent laboratory certification that their product meets the performance criteria of the specified materials.
- C. Abrasion - Fed. Test Method Std. No. 141, Method 6192, CS-17 Wheel, 1,000 grams load.
- D. Adhesion - Elcometer Adhesion Tester.
- E. Exterior Exposure - Exposed at 45 degrees facing the ocean (South Florida Marine Exposure)
- F. Hardness - ASTM D3363-74
- G. Humidity - ASTM D2247-68
- H. Salt Spray (Fog) - ASTM B117-73
- I. Standard practice for Operating the Severe Wastewater Analysis Testing Apparatus ASTM G210-13
- I. Substitutions which decrease the total film thickness, change the generic type of coating, or fail to meet the performance criteria of the specified materials shall not be approved. Prime and finish coats of all surfaces shall be furnished by the same manufacturer.
- J. All coatings to be shop applied must meet the requirements for volatile organic compounds (VOC) of not more than 3.5 lbs/gallon after thinning.
- K. Colors, where not specified, shall be as selected by the County or their Representative.
- L. All coatings in contact with potable water need to be NSF Certified in accordance with

ANSI/NSF Standard 61.

- M. All above ground potable water mains and appurtenances shall be painted safety blue.

PART 3 EXECUTION

3.01 INSPECTION OF SURFACES

- A. Before application of the prime coat and each succeeding coat, all surfaces to be coated shall be subject to inspection by the County. Any defects or deficiencies shall be corrected by the Contractor before application of any subsequent coating.
- B. Samples of surface preparation and of painting systems shall be furnished by the Contractor to be used as a standard throughout the job, unless omitted by the County.
- C. When any appreciable time has elapsed between coatings, previously coated areas shall be carefully inspected by the County, and where, in his opinion, surfaces are damaged or contaminated, they shall be cleaned and recoated at the Contractor's expense. Recoating times of manufacturer's printed instructions shall be adhered to.
- D. Coating thickness shall be determined by the use of a properly calibrated "Nordson-Mikrotest" "Positest" Coating Thickness Gauge (or equal) for ferrous metal or an OG232 "Tooke" Paint Inspection gauge (or equal) for non-ferrous and cementitious surfaces. Please note that use of the "Tooke" gauge is classified as a destructive test.

3.02 SURFACE PREPARATION

The surface shall be cleaned as specified for the paint system being used. All cleaning shall be as outlined in the Society for Protective Coatings (SSPC) Surface Preparation Specification, And the International Concrete Repair Institute (ICRI) unless otherwise noted. If surfaces are subject to contamination, other than mill scale or normal atmospheric rusting, the surfaces shall be pressure washed, and acid or caustic pH residues neutralized, in addition to the specified surface preparation.

3.03 STANDARDS FOR SURFACE PREPARATION

- A. Chemical and/or Solvent Cleaning: Remove all grease, oil, salt, acid, alkali, dirt, dust, wax, fat, foreign matter and contaminates, etc. by one of the following methods: steam cleaning, alkaline cleaning, or volatile solvent cleaning.
- B. Hand Tool Cleaning: Removal of loose rust, loose mill scale and loose paint to a clean sound substrate by hand chipping, scraping, sanding and wire brushing.
- C. Power Tool Cleaning: Removal of loose rust, loose mill scale and loose paint to a clean sound substrate by power tool chipping, descaling, sanding, wire brushing and grinding.
- D. Flame Cleaning: Dehydrating and removal of rust, loose mill scale and some light mill scale by use of flame, followed by wire brushing.
- E. White Metal Blast Cleaning: Complete removal of all mill scale, rust, rust scale, previous coating, etc., leaving the surface a uniform gray-white color.
- F. Commercial Grade Blast Cleaning: Complete removal of all dirt, rust scale, mill scale,

foreign matter and previous coating, etc., leaving only shadows and/or streaks caused by rust stain and mill scale oxides. At least 66% of each square inch of surface area is to be free of all visible residues, except slight discoloration.

- G. Brush-Off Blast Cleaning: Removal of rust scale, loose mill scale, loose rust and loose coatings, leaving tightly-bonded mill scale, rust and previous coatings. On concrete surfaces, brush-off blast cleaning shall remove all laitance, form oils and solid contaminates. Blasting should be performed sufficiently close to the surface so as to open up surface voids, bugholes, air pockets and other subsurface irregularities, but so as not to expose underlying aggregate.
- H. Pickling: Complete removal of rust and mill scale by acid pickling, duplex pickling or electrolytic pickling (may reduce the resistance of the surface to corrosion, if not to be primed immediately).
- I. Near-White Blast Cleaning: Removal of all rust scale, mill scale, previous coating, etc., leaving only light stains from rust, mill scale and small specks of previous coating. At least 95% of each square inch of surface area is to be free of all visible residues and the remainder shall be limited to slight discoloration.
- J. Power Tool Cleaning to Bare Metal: Complete removal of rust, rust scale, mill scale, foreign matter and previous coatings, etc., to a standard as specified on a Commercial Grade Blast Cleaning (SSPC-SP-6, NACE-3) by means of power tools that will provide the proper degree of cleaning and surface profile.
- K. Surface Preparation of Concrete (SSPC-SP13)
- L. Visual standards "Pictorial Surface Preparation Standards for Painting Steel Surfaces", and the National Association of Corrosion Engineer, "Blasting Cleaning Visual Standards" TM-01-70 and TM-01-75 shall be considered as standards for proper surface preparation.
- M. Oil, grease, soil, dust, etc., deposited on the surface preparation that has been completed shall be removed prior to painting according to Solvent Cleaning under this Specification.
- N. Weld flux, weld spatter and excessive rust scale shall be removed by Power Tool Cleaning as per these Specifications.
- O. All weld seams, sharp protrusions and edges shall be ground smooth prior to surface preparation or application of any coatings.
- P. All areas requiring field welding shall be masked off prior to shop coating, unless waived by the County.
- Q. All areas which require field touch-up after erection, such as welds, burnbacks, and mechanically damaged areas, shall be cleaned by thorough Power Tool as specified in these Specifications.
- R. Touch-up systems will be same as original specification except that approved manufacturer's organic zinc-rich shall be used in lieu of inorganic zinc where this system was originally used. Also strict adherence to manufacturer's complete touch-up recommendations shall be followed. Any questions relative to compatibility of products shall be brought to the County's attention; otherwise, Contractor assumes full responsibility.

3.03 PRETREATMENTS

When specified, the surface shall be pretreated in accordance with the specified pretreatment prior to application of the prime coat of paint.

3.04 STORAGE

Materials shall be delivered to the job site in the original packages with seals unbroken and with legible unmutilated labels attached. Packages shall not be opened until they are inspected by the County and required for use. All painting materials shall be stored in a clean, dry, well-ventilated place, protected from sparks, flame, direct rays of the sun or from excessive heat. Paint susceptible to damage from low temperatures shall be kept in a heated storage space when necessary. The Contractor shall be solely responsible for the protection of the materials stored by himself at the job site. Empty coating cans shall be required to be neatly stacked in an area designated by the County and removed from the job site on a schedule determined by the County. County may request a notarized statement from Contractor detailing all materials used on the Project.

3.05 PREPARATION OF MATERIALS

- A. Mechanical mixers, capable of thoroughly mixing the pigment and vehicle together, shall mix the paint prior to use where required by manufacturer's instructions; thorough hand mixing will be allowed for small amounts up to one gallon. Pressure pots shall be equipped with mechanical mixers to keep the pigment in suspension, when required by manufacturer's instructions. Otherwise, intermittent hand mixing shall be done to assure that no separation occurs. All mixing shall be done in accordance with SSPC Vol. 1, Chapter 4, "Practical Aspects, Use and Application of Paints" and/or with manufacturer's recommendations.
- B. Catalysts or thinners shall be as recommended by the manufacturer and shall be added or discarded strictly in accordance with the manufacturer's instruction.

3.06 APPLICATION

- A. Paint shall be applied only on thoroughly dry surfaces and during periods of favorable weather, unless otherwise allowed by the paint manufacturer. Except as provided below, painting shall not be permitted when the atmospheric temperature is below 50 deg F, or when freshly painted surfaces may be damaged by rain, fog, dust, or condensation, and/or when it can be anticipated that these conditions will prevail during the drying period.
- B. No coatings shall be applied unless surface temperature is a minimum of 5 Degrees above dew point; temperature must be maintained during curing.
- C. See coating schedule for actual coating systems to be used on this project.

3.07

DEW POINT CALCULATION CHART

DEW POINT CALCULATION CHART

Ambient Air Temperature - Fahrenheit

| Relative Humidity | 20 | 30 | 40 | 50 | 60 | 70 | 80 | 90 | 100 | 110 | 120 |
|-------------------|----|----|----|----|----|----|----|----|-----|-----|-----|
| 90% | 18 | 28 | 37 | 47 | 57 | 67 | 77 | 87 | 97 | 107 | 117 |
| 85% | 17 | 26 | 36 | 45 | 55 | 65 | 76 | 84 | 95 | 104 | 113 |
| 80% | 16 | 25 | 34 | 44 | 54 | 63 | 73 | 82 | 93 | 102 | 110 |
| 75% | 15 | 24 | 33 | 42 | 52 | 62 | 71 | 80 | 91 | 100 | 108 |
| 70% | 13 | 22 | 31 | 40 | 50 | 60 | 68 | 78 | 88 | 96 | 105 |
| 65% | 12 | 20 | 29 | 38 | 47 | 57 | 66 | 76 | 85 | 93 | 103 |
| 60% | 11 | 20 | 27 | 36 | 45 | 55 | 64 | 73 | 83 | 92 | 101 |
| 55% | 9 | 17 | 25 | 34 | 43 | 53 | 61 | 70 | 80 | 89 | 98 |
| 50% | 6 | 15 | 23 | 31 | 40 | 50 | 59 | 67 | 77 | 86 | 94 |
| 45% | 4 | 13 | 21 | 29 | 37 | 47 | 56 | 64 | 73 | 82 | 91 |
| 40% | 1 | 11 | 18 | 26 | 35 | 43 | 52 | 61 | 69 | 78 | 87 |
| 35% | -2 | 8 | 16 | 23 | 31 | 40 | 48 | 57 | 65 | 74 | 83 |

SURFACE TEMPERATURE AT WHICH CONDENSATION OCCURS

Dew Point

Temperature at which moisture will condense on surface. No coatings should be applied unless surface temperature is a minimum of 5deg above this point. Temperature must be maintained during curing.

Example

If air temperature is 70 deg F and relative humidity is 65%, the dew point is 57 deg F. No coating should be applied unless surface temperature is 62 deg F minimum.

- A. No coating shall be applied unless the relative humidity is below 85%.
- B. Suitable enclosures to permit painting during inclement weather may be used if provisions are made to control atmospheric conditions artificially inside the enclosure, within limits suitable for painting throughout the painting operations.
- C. Field painting in the immediate vicinity of, or on, energized electrical and rotating equipment, and equipment and/or pipes in service shall not be performed without the approval of the County.
- D. Extreme care shall be exercised in the painting of all operable equipment, such as valves, electric motors, etc., so that the proper functioning of the equipment will not be affected.
- E. The Contractor's scaffolding shall be erected, maintained and dismantled without damage to structures, machinery, equipment or pipe. Drop cloths shall be used where required to protect buildings and equipment. All surfaces required to be clear for visual observation shall be cleaned immediately after paint application.

- F. Painting shall not be performed on insulated pipe within three (3) feet of insulation operations or on insulation whose covering and surface coat have not had time to set and dry. Painting shall not be performed on uninsulated pipe within one (1) foot of any type of connection until the connection has been made, except as directed by the County.
- G. The prime coat shall be applied immediately following surface preparation and in no case later than the same working day. All paint shall be applied by brushing, paint mitt and roller, conventional spraying, or airless spraying, using equipment approved by the paint manufacturer.
- H. Each coat of paint shall be recoated as per manufacturer's instructions. Paint shall be considered recoatable when an additional coat can be applied without any detrimental film irregularities such as lifting or loss of adhesion.
- I. Surfaces that will be inaccessible after assembly shall receive either the full specified paint system or three shop coats of the specified primer before assembly.
- J. Finish colors shall be in accordance with the COLOR SCHEDULE and shall be factory mixed (i.e., there shall be no tinting by the Contractor, unless authorized by the County).
- K. All edges and weld seams in immersion service shall receive a "stripe coat" (applied by brush) of the 2nd coat prior to application of the full 2nd coat.
- L. All open seams in the roof area of tanks shall be filled after application of the topcoat with a flexible caulking such as Sika Flex 1A.

3.08 WORKMANSHIP

- A. The Contractor must show proof that all employees associated with this Project shall have been employed by the Contractor for a period not less than six (6) months.
- B. Painting shall be performed by experienced painters in accordance with the recommendations of the paint manufacturer. All paint shall be uniformly applied without sags, runs, spots, or other blemishes. Work which shows carelessness, lack of skill, or is defective in the opinion of the County, shall be corrected at the expense of the Contractor.
- C. The Contractor shall provide the names of at least three other projects of similar size and scope that they have successfully completed under their current company name.

3.09 APPLICATION OF PAINT

- A. By Brush and/or Rollers
 - 1. Top quality, properly styled brushes and rollers shall be used. Rollers with a baked phenol core shall be utilized.
 - 2. The brushing or rolling shall be done so that a smooth coat as nearly uniform in thickness as possible is obtained. Brush or roller strokes shall be made to smooth the film without leaving deep or detrimental marks.
 - 3. Surfaces not accessible to brushes or rollers may be painted by spray, by dauber or sheepskins, and paint mitt.
 - 4. It may require two coats to achieve the specified dry film thickness if application is by brush and roller.

B. Air, Airless or Hot Spray

1. The equipment used shall be suitable for the intended purpose, shall be capable of properly atomizing the paint to be applied and shall be equipped with suitable pressure regulators and gauges.
2. Paint shall be applied in a uniform layer, with a 50% overlap pattern. All runs and sags should be brushed out immediately or the paint shall be removed and the surface resprayed.
3. High build coatings should be applied by a cross-hatch method of spray application to ensure proper film thickness of the coating.
4. Areas inaccessible to spray shall be brushed; if also inaccessible to brush, daubs or sheepskins shall be used, as authorized by the manufacturer.
5. Special care shall be taken with thinners and paint temperatures so that paint of the correct formula reaches the receiving surface.
6. Nozzles, tips, etc., shall be of sizes and designs as recommended by the manufacturer of the paint being sprayed.
7. The first coat on concrete surfaces in immersion service should be sprayed and back rolled.

3.10 PROTECTION AND CLEANUP

- A. It shall be the responsibility of the Contractor to protect at all times, in areas where painting is being done, floors, materials of other crafts, equipment, vehicles, fixtures, and finished surfaces adjacent to paint work. Cover all electric plates, surface hardware, nameplates, gauge glasses, etc., before start of painting work.
- B. At the option of the County during the course of this project, the Contractor will contain all spent abrasives, old paint chips, paint overspray and debris by means suitable to the County, including, but not limited to, full shrouding of the area.
- C. If shrouding is required, the Contractor must provide a complete design of the intended shroud or cover. Care must be taken not to modify or damage the structure during the use of the shroud. If damage should occur, the Contractor is held responsible for all repairs.
- D. At completion of the work, remove all paint where spilled, splashed, spattered, sprayed or smeared on all surfaces, including glass, light fixtures, hardware, equipment, painted and unpainted surfaces.
- E. After completion of all painting, the Contractor shall remove from job site all painting equipment, surplus materials and debris resulting from this work.
- F. The Contractor is responsible for the removal and proper disposal of all hazardous materials from the job site in accordance with Local, State and Federal requirements as outlined by the Environmental Protection Agency.
- G. A notarized statement shall be presented to the County that all hazardous materials have been disposed of properly including, but not limited to: name of disposal company, disposal site, listing of hazardous materials, weights of all materials, cost per pound and EPA registration number.

3.11 TOUCH-UP MATERIALS

The Contractor shall provide at the end of the Project at least one (1) gallon of each generic topcoat in each color as specified by the County for future touch-up. Two gallons may be required for (2) component materials.

3.12 ON-SITE INSPECTION

During the course of this Project, the County will reserve the option of incorporating the services of a NACE Level III inspection service. The inspection service will be responsible for assuring the proper execution of this Specification by the successful Contractor.

3.13 STEEL - STRUCTURAL, TANKS, PIPES AND EQUIPMENT

A. EXTERIOR EXPOSURE (NON-IMMERSION)

1. System No. 1095-1: Epoxy/High Build Urethane

This system is highly resistant to abrasion, wet conditions, corrosive fumes and chemical contact. Provides 3-4 times the color and gloss retention of conventional paints. Second coat to be close to finish color but not the same color. This system should be used for above ground exterior steel surfaces that are neither submerged, nor buried.

Surface Preparation: SSPC-SP6 Commercial Blast Cleaning

| | |
|---|------------------|
| Shop Coat: 66HS-1211 Epoxoline Primer | 3.0 - 4.0 |
| 2nd Coat: 66HS-Color Hi-Build Epoxoline | 2.0 - 3.0 |
| 3rd Coat: 1095-Endura-Shield III | <u>2.0 - 3.0</u> |
| Dry Film Thickness | 7.0 - 10.0 |
| Minimum | 8.0 Mils |

2. System No. 1095-2: High Build Urethane for Marginally Cleaned Surfaces or Topcoating Existing System

This system can be used over factory finish paint or cover non-sandblasted steel and offer the high performance of a urethane coating. Specify Series 1074U Endura-Shield for gloss finish.

Surface Preparation: SSPC-SP6 Commercial Blast Cleaning or SSPC-SP3 Power Tool Cleaning

| | |
|--|------------------|
| Shop Coat: Manufacturer Standard Primer (or existing coating) | 3.0-5.0 |
| 2nd Coat: 135 Chembuild | 3.0 - 5.0 |
| 3rd Coat: 1095-Color Endura-Shield | <u>2.0 - 3.0</u> |
| Dry Film Thickness | 8.0 - 13.0 |
| Minimum | 9.5 Mils |

4. System 90-97: Zinc/Epoxy/Urethane

This system offers the added corrosion protection of a zinc rich primer. Series 90-97 Tneme-Zinc is an organic zinc-rich primer that can be used for field touch up of a

zinc primer or for touch up of galvanized surfaces that are damaged.

Surface Preparation: SSPC-SP6 Commercial Blast Cleaning

| | | |
|---|--------------------|-----------|
| Shop Coat: 90-97 Tneme-Zinc | 2.5 - 3.5 | |
| 2nd Coat: 66HS-Color Hi-Build Epoxoline | 2.0 - 3.0 | |
| 3rd Coat: 1095 Endurashield | <u>2.0 - 3.0</u> | |
| | Dry Film Thickness | 6.5 - 9.5 |
| | Minimum | 8.0 Mils |

B. INTERIOR EXPOSURE (NON-IMMERSION)

1. System No.66HS-1: High Build Epoxy

This system will provide chemical and corrosion resistance against abrasion, moisture, corrosion fumes, chemical contact and immersion in non-potable water. Primer coat must be touched-up before second coat is applied. Substitute Series 161HS for low temperature cure or quick recoats. Use this system for interior exposed, non submerged metals.

Surface Preparation: SSPC-SP6 Commercial Blast Cleaning

| | | |
|---|--------------------|------------|
| Shop Coat: 66HS-1211 Epoxoline Primer | 3.0 - 5.0 | |
| 2nd Coat: 66HS-Color Hi-Build Epoxoline | <u>4.0 - 6.0</u> | |
| | Dry Film Thickness | 7.0 - 11.0 |
| | Minimum | 9.0 Mils |

2. System No. 66HS-2: High Build Epoxy (Over OEM Finishes)

This system is to be used over standard manufacturer's primer to offer a high performance epoxy finish. Excellent for areas of rust not able to be completely cleaned.

Surface Preparation: Spot SSPC-SP6 Commercial Blast Cleaning or SSPC- SP11 Power Tool Cleaning to Bare Metal

| | | |
|---|--------------------|------------|
| Shop Coat: Manufacturer's Standard (or existing coating) | 1.0 - 2.0 | |
| 2nd Coat: 27WB | 2.5 - 4.0 | |
| 3rd Coat: 66HS-Color Hi-Build Epoxoline | <u>2.0 - 4.0</u> | |
| | Dry Film Thickness | 5.5 - 10.0 |
| | Minimum | 7.0 Mils |

C. IMMERSION

1. System No. 104-1: High Solids Epoxy (Non-Potable Water)

This system will provide chemical and corrosion resistance for protection against abrasion, moisture, corrosive fumes, chemical contact and immersion in *mild to moderate* Wastewater, such as clarifiers, chlorine contact basins, aeration basins, settling basins and other open top (aerobic) structures. Primer coat must be touched-up before second coat is applied. Scarify the surface before topcoating if the Series 66HS has been exterior-exposed for 60 days or longer. Substitute Series

161HS for low temperature cure or quick recoats.

Surface Preparation: SSPC-SP10 Near-White Blast Cleaning

| | |
|--|----------------|
| Shop Coat: 66HS-1211 Epoxoline Primer | 3.0 - 5.0 |
| 2nd Coat: 104-Color Hi-Build Epoxoline | 6.0-8.0 |
| 3rd Coat: 104-Color Hi-Build Epoxoline | <u>6.0-8.0</u> |
| Dry Film Thickness | 15.0 - 21.0 |
| Minimum | 11.0 Mils |

2. System No. 20HS-1: Epoxy-Polyamide (Potable Water)

This system meets American Water Works Association AWWA D 102 Inside Paint System Number 1. Series 20HS meets the new requirements of approval for potable water use as established by the National Sanitation Foundation Standard 61. Substitute Series FC20HS for low temperature cure or quick recoats.

Surface Preparation: SSPC-SP10 Near-White Blast Cleaning

| | |
|---|------------------|
| Shop Coat:20HS-WH02 Pota-Pox (Tank White) | 3.0 - 5.0 |
| 2nd Coat: 20HS-1255 Pota-Pox (Beige) | 4.0 - 6.0 |
| 3rd Coat: 20HS-WH02 Pota-Pox (Tank White) | <u>4.0 - 6.0</u> |
| Dry Film Thickness | 11.0 - 17.0 |
| Minimum | 12.0 Mils |

3.14 OVERHEAD METAL DECKING, JOIST

A. INTERIOR EXPOSURE

System No. 115-1: Uni-Bond

This system should be used on ceiling areas where a one-coat system is desired. Can be applied over steel, galvanized and aluminum decking, joist, shop primed beams, conduits and concrete.

Surface Preparation: Surfaces must be dry, clean and free of oil, grease and other contaminates. Allow concrete to cure 28 days.

Coating: 115-Color Uni-Bond Dry Film Thickness 2.5 - 4.0

B. EXTERIOR EXPOSURE

System No. 1029-1: Enduratone

This system can be applied over a wide variety of coatings and factory finishes. It can also be applied direct to galvanized aluminum decking, joists, & conduits

Surface Preparation: Pressure clean to remove all dirt, oil, grease, chemicals and foreign contaminates. Remove loose paint and all rust by hand and power tool cleaning (SSPC-SP 2 & 3)

| | | |
|-----------------------|------------------------|----------------|
| 1st Coat: | 1029-Color Endura-tone | 2.0-3.0 |
| 2 nd Coat: | 1029-Color Enduratone | <u>2.0-3.0</u> |
| | Dry Film Thickness | 4.0-6.0 |

3.16 GALVANIZED STEEL - PIPE AND MISCELLANEOUS FABRICATIONS

A. EXTERIOR / (NON-IMMERSION)

System No. 1095-3: Epoxy/High Build Urethane

Series 66HS has excellent adhesion to galvanized steel. This system is highly resistant to abrasion, wet conditions, corrosive fumes and chemical contact. Provides 3-4 times the color and gloss retention of conventional paints. First coat to be same color as or close to the finish color. Specify Series 1074U Endura-Shield for gloss finish.

Surface Preparation: SSPC-SP1 Solvent Cleaning, followed by Sweep Abrasive Blasting (SSPC-SP7)

| | | |
|---|--------------------|-----------|
| 1st Coat: 66HS-Color Hi-Build Epoxoline | 2.0 - 4.0 | |
| 2nd Coat: 1095-Color Endura-Shield | <u>2.0 - 4.0</u> | |
| | Dry Film Thickness | 4.0 - 8.0 |
| | Minimum | 5.0 Mils |

B. INTERIOR EXPOSURE (NON IMMERSION) AND ALUMINUM IN CONTACT WITH CONCRETE

System No. 66HS-3: Polyamide Epoxy

Surface Preparation: SSPC-SP1 Solvent Cleaning

| | | |
|---|--------------------|-----------|
| 1st Coat: 66HS-Color Hi-Build Epoxoline | 2.0 - 4.0 | |
| 2nd Coat: 66HS-Color Hi-Build Epoxoline | <u>2.0 - 4.0</u> | |
| | Dry Film Thickness | 4.0 - 8.0 |
| | Minimum | 5.0 Mils |

3.18 CONCRETE

A. EXTERIOR - ABOVE GRADE

1. System No. 1026-1: Acrylic Emulsion Low Sheen

If semi-gloss finish is desired, use Series 1029 Tneme-Cryl SG as the second coat.

Surface Preparation: Allow new concrete to cure for 28 days. Surface must be clean and dry.

| | | |
|---------------------------------|--------------------|-----------|
| 1st Coat: 1026-Color Tneme-Cryl | 2.0 - 3.0 | |
| 2nd Coat: 1026-Color Tneme-Cryl | <u>2.0 - 3.0</u> | |
| | Dry Film Thickness | 4.0 - 6.0 |
| | Minimum | 5.0 Mils |

2. System No. 156-1: Modified Acrylic Elastomer

If texture is needed, use 157 Enviro-Crete TX (medium texture) For application over previously applied coatings, use TNEMEC Series 151 Elasto-Grip at 1.0 - 2.5 mils DFT prior to the application of Series 156 Enviro-Crete.

Surface Preparation: Surface must be clean and dry.

| | | |
|----------------------------------|--------------------|------------|
| 1st Coat: 156-Color Enviro-Crete | 4.0 - 8.0 | |
| 2nd Coat: 156-Color Enviro-Crete | <u>4.0 - 8.0</u> | |
| | Dry Film Thickness | 8.0 - 16.0 |
| | Minimum | 10.0 Mils |

B. EXTERIOR - BELOW GRADE

1. System No. 46-31: Coal Tar-Epoxy

Surface Preparation: Surface shall be clean and dry.

One Coat: 46H-413 Hi-Build Tneme-Tar

| | |
|--------------------|-------------|
| Dry Film Thickness | 14.0 - 20.0 |
|--------------------|-------------|

C. EXTERIOR/INTERIOR EXPOSURE (NON-IMMERSION)

1. System No. 1026-2: Acrylic Emulsion, Low Sheen (Interior/Exterior)

This system will provide a decorative coating with good exterior durability, color retention, and a high vapor transmission rate. ***For Semi-Gloss finish, use 1029-Color Tneme-Cryl S/G.***

Surface Preparation: Surface shall be clean and dry. Allow concrete to cure for 28 days.

Block Filler (CMU only): 1254 Epoxoblock
1st Coat: 1026-Color Tneme-Cryl
2nd Coat: 1026-Color Tneme-Cryl

| | | |
|--------------------|------------------|-----------|
| | 125 SF/GL | |
| | 2.0 - 3.0 | |
| | <u>2.0 - 3.0</u> | |
| Dry Film Thickness | | 4.0 - 6.0 |
| Minimum | | 5.0 Mils |

*Does not include Block Filler

2. System No. 66HS-4: Epoxy-Polyamide (Interior)

Series 66HS provides excellent protection from abrasion, moisture, corrosive fumes and chemical contact.

Surface Preparation: Surfaces shall be clean and dry. Allow concrete to cure for 28 days. All surfaces must be clean and dry.

Block Filler (CMU only): 1254 Epoxoblock
1st Coat: 66HS-Color Hi-Build Epoxoline
2nd Coat: 66HS-Color Hi-Build Epoxoline

| | | |
|--------------------|------------------|-------------|
| | 125 SF/GL | |
| | 3.0 - 5.0 | |
| | <u>4.0 - 6.0</u> | |
| Dry Film Thickness | | 7.0 - 11.0* |
| Minimum | | 9.0 Mils |

*(Does not include Block Filler)

D. IMMERSION - POTABLE & NON-POTABLE WATER

1. System No. 104-2: High Solids Epoxy (Non-Potable Water). This system will provide chemical and corrosion resistance for protection against abrasion, moisture, corrosive fumes, chemical contact and immersion in *mild to moderate* Wastewater, such as clarifiers, chlorine contact basins, aeration basins, settling basins and other open top (aerobic) structures.

Surface Preparation: Allow new concrete to cure for 28 days. Sweep abrasive blast per SSPC-SP13 to remove all laitance, fines, curing compounds, form release oils, and other contaminants, and to establish a surface profile equal to ICRI CSP 5 or greater.

Apply Tnemec Series 218 to all surfaces at a minimum of 1/16" to re-surface concrete, fill voids and bugholes, mitigate concrete outgassing, and to create a monolithic, paintable surface.

| | | |
|--|--------------------|--------------|
| 1st Coat: 104-1255 H.S. Epoxy Primer | 6.0 - 8.0 | |
| 2nd Coat: 104 Color H.S. Epoxy | <u>6.0 - 8.0</u> | |
| 3 rd Coat: 104 Color H.S. Epoxy | <u>6.0-8.0</u> | |
| | Dry Film Thickness | 18.0 - 240.0 |
| | Minimum | 20.0 Mils |

2. System No. 20HS-2 Epoxy-Polyamide (Potable Water)

This system meets American Water Works Association AWWA D 102 Inside System No. 1. Series 20HS meets the requirements of approval for potable water use as established by the National Sanitation Foundation Standard 61.

Surface Preparation: Allow new concrete to cure for 28 days. Sweep abrasive blast per SSPC-SP13 to remove all laitance, fines, curing compounds, form release oils, and other contaminants, and to establish a surface profile equal to ICRI CSP 5 or greater.

Apply Tnemec Series 218 to all surfaces at a minimum of 1/16" to re-surface concrete, fill voids and bugholes, and to create a monolithic, paintable surface.

| | | |
|-------------------------------------|--------------------|-------------|
| 1st Coat: 20HS-15BL Pota-Pox | 4.0 - 6.0 | |
| 2nd Coat: 20HS-1255 Pota-Pox Finish | <u>4.0 - 6.0</u> | |
| 3 rd Coat: 20HS -15BL | <u>4.0-6.0</u> | |
| | Dry Film Thickness | 12.0 - 17.0 |
| | Minimum | 13.0 Mils |

E. INTERIOR EXPOSURE (NON-IMMERSION)

1. System No. 66HS-5: High Solids Epoxy

This system will produce a slick, tile-like finish that has excellent chemical and water resistance. Surface will be easy to clean.

Surface Preparation: Allow new concrete to cure for at least 28 days. Surface to be clean and dry.

| | |
|---------------------------------|-------------|
| 1st Coat: 66HS-Color H.S. Epoxy | 6.0 - 8.0 |
| 2nd Coat: 66HS-Color H.S. Epoxy | 6.0 - 8.0 |
| Dry Film Thickness | 12.0 - 16.0 |
| Minimum | 14.0 Mils |

2. System No. 113-1: Acrylic-Epoxy Semi-Gloss

This system will provide high performance and can be applied directly over existing coatings without lifting. Can be used when low odor is required during application. Specify Series 114 Tneme-Tufcoat for Gloss Finish.

Surface Preparation: Allow new concrete to cure for at least 28 days. Surface must be clean and dry.

| | | |
|---|--------------------|-----------|
| One or Two Coats: 113-Color Tneme-Tufcoat | Dry Film Thickness | 4.0 - 6.0 |
|---|--------------------|-----------|

3.19 CONCRETE FLOORS

A. EPOXY FLOOR COATINGS

1. System No. 290-1: Epoxy- Chemical Resistant Urethane

This system will provide a durable, long-wearing coating that bonds tightly to concrete and stands up under heavy foot traffic, frequent cleaning, spillage of water, oil, grease, or chemical, and UV Exposure.

Surface Preparation: Allow new concrete to cure for 28 days. Mechanically abrade or Sweep Abrasive Blast Cleaning

Moisture vapor transmission should not exceed three lbs per 1,000 sq ft in a 24 hour period. (Reference ASTM F 1869 "Standard Test Method for Measuring Moisture Vapor Emission Rate of Concrete Subfloor Using Anhydrous Calcium Chloride.") Relative humidity should not exceed 80%. (Reference ASTM F 2170 "Standard Test Method for Determining Relative Humidity in Concrete using in situ Probes.")

Note: For moisture content up to 10 lbs per 1,000 sq ft or relative humidity up to 90%, Series 208 may be substituted for Series 201 as the primer.

| | |
|---------------------------------|------------|
| 1st Coat: 201- Epoxoprime | 5.0-7.0 |
| 2nd Coat: 237-Color Tneme-Glaze | 8.0-10.0 |
| 3 rd Coat: 290 CRU | 2.0-3.0 |
| Dry Film Thickness | 15.0- 20.0 |
| Minimum | 17.0 Mils |

For a non-skid finish, broadcast 30-50 mesh clean, dry silica sand into the 2nd coat at a rate of 5 lbs per 150 square feet.

2. System No. 241/222: Decorative Quartz Flooring (Non-Slip)

This system provides a decorative, chemical, abrasion, impact resistant, non-slip, seamless flooring system with a moisture mitigating base coat that resists up to 20 lbs of moisture vapor pressure.

Surface Preparation: Allow new concrete to cure for 28 days. Mechanically abrade or Sweep abrasive Blast to provide a minimum surface profile equal to ICRI CSP3

| | |
|-----------------------------------|----------------------------------|
| 1st Coat: 241 Ultra-Tread MVT | 70 square feet per small kit |
| 2nd Coat: 222 Deco-Tread | (1 ct. @ 1/16" ea.) |
| 3rd Coat: 284 Tneme-Glaze (clear) | <u>8.0 - 12.0</u> |
| | Minimum Dry Film Thickness 1/8"+ |

3.20 POROUS MASONRY

A. EXTERIOR/INTERIOR EXPOSURE

1. System No. 156-2: Modified Epoxy - Sand Texture

Modified Waterborne Acrylate. This system offers long term protection against wind-driven rain, mold/mildew growth, chalking & fading, and bridges hairline cracks.

Surface Preparation: Surface shall be clean and dry.

| | |
|---------------------------------|------------------------------|
| 1st Coat: 157-Color Envirocrete | 6.0-9.0 |
| 2nd Coat: 157 Envirocrete | 6.0-9.0 |
| | Dry Film Thickness 12.0-18.0 |
| | Minimum DFT: 14.0 mils |

2. System No. 104-3: High Solids Epoxy (Interior Only)

This system will produce a film thickness of 16 mils. The surface will be tile-like for easy cleaning and will provide protection against chemical attack, corrosive fumes, high humidity and wash down. Backroll first coat to fill porosity.

Surface Preparation: Surface to be clean and dry.

| | |
|--------------------------------|--------------------------------|
| 1st Coat: 104-Color H.S. Epoxy | 8.0 - 10.0 |
| 2nd Coat: 104-Color H.S. Epoxy | <u>8.0 - 10.0</u> |
| | Dry Film Thickness 16.0 - 20.0 |
| | Minimum 18.0 Mils |

3. System No. 113-2: Acrylic-Epoxy Semi-Gloss (Interior Only)

Series 113 Tneme-Tufcoat has very low odor and can be used when painting in occupied areas.

Specify Series 114 Tneme-Tufcoat for a gloss finish.

Surface Preparation: Surface must be clean and dry.

| | |
|------------------------------------|------------------|
| 1st Coat: 1254 Epoxoblock WB | 125 SF/Gal |
| 2nd Coat: 113-Color Tneme-Tufcoat* | <u>4.0 - 6.0</u> |
| | **4.0 - 6.0 |

* ***Two coats may be required if applied by roller***

** ***Total Dry Film Thickness of Topcoats Only***

4. System No. 156-3: Modified Acrylic Elastomer

If texture is needed, use 157 Enviro-Crete TX For application over previously applied coatings, use TNEMEC 151 Elasto-Grip at 1.0 - 2.5 mils DFT in lieu of Series 1254.

Surface Preparation: Surfaces must be clean and dry.

| | |
|----------------------------------|------------------|
| 1st Coat: 1254 Epoxoblock WB | 125 SF/Gal |
| 2nd Coat: 156-Color Enviro-Crete | 4.0 - 8.0 |
| 3rd Coat: 156-Color Enviro-Crete | <u>4.0 - 8.0</u> |
| Dry Film Thickness | 8.0 - 16.0 |
| Minimum | 10.0 Mils |

3.21 GYPSUM WALLBOARD

A. INTERIOR EXPOSURE

1. System No. 113-3: Acrylic-Epoxy

Surface Preparation: Surface must be clean and dry.

| | |
|-----------------------------------|------------------|
| 1st Coat: 51PVA Sealer | 1.0 - 2.0 |
| 2nd Coat: 113 H.B. Tneme-Tufcoat* | <u>4.0 - 5.0</u> |
| Dry Film Thickness | 5.0 - 7.0 |
| Minimum | 6.0 Mils |

*Two coats may be required if application is by brush and roller.

2. System No. 66HS-5: Hi-Build Epoxoline

Surface Preparation: Surface must be clean and dry.

| | |
|--|------------------|
| 1st Coat: 51PVA Sealer | 1.0 - 2.0 |
| 2nd Coat: 66HS-Color Hi-Build Epoxoline* | <u>4.0 - 6.0</u> |
| Dry Film Thickness | 5.0 - 8.0 |
| Minimum | 5.0 Mils |

*Two coats may be required if applied by roller

3. System No. 1026--3: Acrylic Emulsion, Low Sheen (Interior/Exterior Exposure)

This system is designed for mild use areas like office walls, laboratory ceilings, stairwells, etc. For Semi-Gloss finish, use 1029-color Tneme-Cryl S/G.

Surface Preparation: Surface must be dry and clean.

| | |
|---------------------------------|------------------|
| 1st Coat: 1026-Color Tneme-Cryl | 2.0 - 3.0 |
| 2nd Coat: 1026-Color Tneme-Cryl | <u>2.0 - 3.0</u> |
| Dry Film Thickness | 4.0 - 6.0 |
| Minimum | 5.0 Mils |

3.22 WOOD

A. EXTERIOR/INTERIOR EXPOSURE

1. System No. 1029-2: Acrylic Emulsion Semi-Gloss

Specify Series 1028 Hi-Build Tneme-Gloss for High Gloss finish.

Surface Preparation: Surface shall be clean and dry.

| | |
|------------------------------|------------------|
| 1st Coat: 10-99W Undercoater | 2.0-3.0 |
| 2nd Coat: 1029 Enduratone | 1.5 - 3.5 |
| 3rd Coat: 1029 Enduratone | <u>1.5 - 3.5</u> |

| | |
|--------------------|------------|
| Dry Film Thickness | 5.0 - 10.5 |
| Minimum | 6.0 Mils |

3.23 PVC PIPE

A. EXTERIOR OR INTERIOR

System No. 1095-4: Acrylic Polyurethane

Surface Preparation: SSPC-SP1 followed by hand or power sanding to scarify / degloss surface.

Two Coats: 1095 Endurashield Dry Film Thickness 2.0-3.0 mils per coat.

3.24 INSULATED PIPE

A. INTERIOR EXPOSURE

System No. 1026-4: Acrylic Emulsion, Low Sheen

For semi-gloss finish, use 1029-Color Tneme-Cryl S/G.

Surface Preparation: Surface shall be clean and dry.

| | |
|---------------------------------|------------------|
| 1st Coat: 1026-Color Tneme-Cryl | 2.0 - 3.0 |
| 2nd Coat: 1026-Color Tneme-Cryl | <u>2.0 - 3.0</u> |

| | |
|--------------------|-----------|
| Dry Film Thickness | 4.0 - 6.0 |
| Minimum | 5.0 Mils |

3.25 HIGH HEAT COATING

A. EXTERIOR/INTERIOR EXPOSURE

1. System No. 1528-1: Inert Multipolymeric Matrix (1200 deg F Maximum)

Surface Preparation: SSPC-SP10 Near-White Blast Cleaning - 1.5 Mil Surface Profile

| | |
|--------------------------------------|----------------|
| 1st Coat: 1528-Color Endura-Heat DTM | 2.0-4.0 |
| 2nd Coat: 1528-Color Endura-Head DTM | <u>2.0-4.0</u> |

| | |
|--------------------|---------|
| Dry Film Thickness | 4.0-6.0 |
|--------------------|---------|

3.26 SURFACES EXPOSED TO H2S/H2SO4 (SEVERE EXPOSURE/IMMERSION)

A. CEMENTITIOUS SURFACES

System No. 434-1: Polyamine Epoxy Mortar system

Surface Preparation: Allow new concrete to cure for 28 days. Sweep abrasive blast per SSPC-SP13 to remove all laitance, fines, curing compounds, form release oils, and other contaminants, and to establish a surface profile equal to ICRI CSP 5 or greater.

Apply Tnemec Series 218 to all surfaces at a minimum of 1/16" to re-surface concrete, fill voids and bugholes, mitigate concrete outgassing, and to create a monolithic, paintable surface.

| | |
|----------------------------|------------------|
| 1st Coat: 434 Perma-Shield | 125 mils |
| 2nd Coat: 435 Perma-Glaze | <u>18.0-20.0</u> |
| Dry Film Thickness | 143-145 |
| Minimum | 144.0 |

B. FERROUS METAL SURFACES

System No. 142-1: Flake /Aluminum Oxide Filled Polyamine Epoxy

Surface Preparation: SSPC-SP-10 Near White Metal Blast Cleaning (1.5 Mil Profile)

| | |
|------------------------------|------------------|
| 1st Coat: Series 1 Omnithane | 2.5-3.5 |
| 2nd Coat: 142 Epoxoline | <u>14 - 18.0</u> |
| Dry Film Thickness | 16.0 - 23.5.0 |
| Minimum | 20.0 Mils |

3.27 EXTERIOR OF PRESTRESSED CONCRETE TANKS

A. System No. 156-4: New Tanks

Surface Preparation: Allow new concrete to cure for at least (3) days. Surface to be clean and dry.

| | |
|---------------------------------|------------------|
| 1st Coat: 156-Color Envirocrete | 4.0 - 6.0 |
| 2nd Coat: 156-Color Envirocrete | <u>4.0 - 6.0</u> |
| Dry Film Thickness | 8.0 - 12.0 |
| Minimum | 10.0 Mils |

B. System No. 156-5: Existing Tanks (Previously Painted)

Surface Preparation: Remove all dirt, oil, grease, chalk, and loose paint per high pressure water blast (min. 3500 psi).

| | |
|---|-----------|
| 1st Coat: 151 Elasto-Grip | 1.0 - 2.5 |
| Stripe Coat: Stripe all hairline cracks with a brushed coat of Series 156 Envirocrete | 3.0 - 5.0 |

Topcoat: 156-Envirocrete

4.0 - 6.0
Dry Film Thickness (Cracks) 8.0 - 13.5
Dry Film Thickness (Other) 5.0 - 8.5

3.28 SECONDARY CONTAINMENT AREAS

A. System No. 239SC-1: Modified Novolac Epoxy

This system offers superior chemical resistance to a wide range of aggressive chemicals, including Sulfuric Acid, Hydrofluosilicic Acid, Sodium Hydroxide, Sodium Hypochlorite, Polymer Emulsion, and hydrocarbons.

Surface Preparation: Allow new concrete to cure for 28 days. Sweep abrasive blast per SSPC-SP13 to remove all laitance, fines, curing compounds, form release oils, and other contaminants, and to establish a surface profile equal to ICRI CSP 5 or greater.

Moisture vapor transmission should not exceed three lbs per 1,000 sq ft in a 24 hour period. (Reference ASTM F 1869 "Standard Test Method for Measuring Moisture Vapor Emission Rate of Concrete Subfloor Using Anhydrous Calcium Chloride.") Relative humidity should not exceed 80%. (Reference ASTM F 2170 "Standard Test Method for Determining Relative Humidity in Concrete using in situ Probes.") Note: For moisture content up to 10 lbs per 1,000 sq ft or relative humidity up to 90%, Series 241 may be substituted for the primer. Refer to the Series 241 product data sheet for more information.

Apply Tnemec Series 218 to all vertical surfaces at a minimum of 1/16" to re-surface concrete, fill voids and bugholes, and to create a monolithic, paintable surface.

Apply Tnemec Series 215 or 218 as needed to fill voids in horizontal surfaces.

| | |
|--|------------|
| Primer: Tnemec Series 239SC RCK | 6.0-8.0 |
| Basecoat: Tnemec Series 239SC MCK | 60.0-80.0 |
| Fiberglass Mat: Tnemec Series 211-0215SC | NA |
| Saturant Coat: Tnemec Series 239SC RCK | 10.0-12.0 |
| Top Coat: Tnemec Series 282 | 8.0-10.0 |
| Dry Film Thickness | 84.0-110.0 |

Notes:

1. See Tnemec's *Fiberglass Mat Reinforced Mortar Application Guide for System details*
2. Series 282 is not color stable. For extended color and gloss retention, apply a finish coat of Tnemec Series 290 CRU @ 2.0-3.0 mils DFT

B. System No. 61-1: Cycloaliphatic Amine Epoxy

This system offers superior resistance to gasoline, diesel fuel, and other hydrocarbons. Use TNE MEC Series 215 between coats as a filler and surfacer wherever it is required.

Surface Preparation: Allow new concrete to cure for 28 days. Sweep abrasive blast per SSPC-SP13 to remove all laitance, fines, curing compounds, form release oils, and other contaminants, and to establish a surface profile equal to ICRI CSP 5 or greater.

Moisture vapor transmission should not exceed three lbs per 1,000 sq ft in a 24 hour period. (Reference ASTM F 1869 "Standard Test Method for Measuring Moisture Vapor Emission

Rate of Concrete Subfloor Using Anhydrous Calcium Chloride.") Relative humidity should not exceed 80%. (Reference ASTM F 2170 "Standard Test Method for Determining Relative Humidity in Concrete using in situ Probes.") Note: For moisture content up to 10 lbs per 1,000 sq ft or relative humidity up to 90%, Series 241 may be applied prior to the "Primer" coat. Refer to the Series 241 product data sheet for more information.

Apply Tnemec Series 218 to all *vertical* surfaces at a minimum of 1/16" to re-surface concrete, fill voids and bugholes, mitigate concrete outgassing, and to create a monolithic, paintable surface.

Apply Tnemec Series 215 or 218 as needed to fill voids in *horizontal* surfaces.

| | |
|-------------------------------------|-------------------|
| Primer: 61-5002 Tneme-Liner (Beige) | 8.0 - 12.0 |
| Topcoat: 61-5001 Tneme-Liner (Gray) | <u>8.0 - 12.0</u> |
| Dry Film Thickness | 16.0 - 24.0 |

3.29 CLEAR WATER REPELLENT FOR CONCRETE, MASONRY AND BRICK

A. Silane /Siloxane Sealer (Min. 42% Solids)

Surface Preparation: Allow new concrete to cure 28 days. All surfaces must be clean, dry, and free of oils, curing compounds, form release oils, and other contaminants that might interfere with the penetration of the sealer.

COATING: BRICK, CONCRETE
Tnemec Series 662Two Coats @ 75-200 SF/GAL

SPLIT FACED OR POROUS MASONRY
Tnemec Series 662..... Two Coats @ 35-100 SF/GAL

3.30

3.31 CANAL PIPE (AERIAL) CROSSINGS

A. System 701-1: NEW. Zinc/Epoxy/Fluoropolymer for New Pipe or Existing Pipe Requiring Removal of Existing Coatings

Surface Preparation: SSPC-SP6 Commercial Blast Cleaning

| | |
|---|------------------|
| Primer: 90-97 Tneme-Zinc | 2.5 - 3.5 |
| 2nd Coat: 66HS-Color Hi-Build Epoxoline | 2.0 - 3.0 |
| 3rd Coat: 701-Color Hydroflon | <u>2.0 - 3.0</u> |
| Dry Film Thickness | 6.5 - 9.5 |
| Minimum | 8.0 Mills |

B. System No. 701-2: EXISTING. High Build, Semi- Gloss Fluoropolymer for Marginally Cleaned Surfaces or Topcoating Over Existing Systems

Surface Preparation: High Pressure Water Blast (min. 3500 psi) or Solvent Clean (SSPC-SP1) and Spot Hand or Power Tool Clean (SSPC-SP 2 - 3) or Brush Blast (SSPC-SP7). Existing coatings must be clean, dry and tightly adhering prior to application of coatings.

| | |
|--------------------------------|-----------|
| Spot Coat: 135-Color Chembuild | 3.0 - 5.0 |
|--------------------------------|-----------|

Prime Coat: 135-Color Chembuild
2nd Coat: 701-Color Hydroflon

3.0-5.0
2.0 - 3.0

Minimum Dry Film Thickness (NIC Spot Coat)? 6.0

3.32 PROJECT DESIGNER SYSTEMS REFERENCE GUIDE

A. STEEL

EXTERIOR (NON-IMMERSION)

- A.1 System No. 1095-1-1: Epoxy/High Build Urethane
- A.2 System No. 1095-2: High Build Urethane
- A.4 System 90-97: Zinc/Epoxy/Urethane

INTERIOR EXPOSURE (NON-IMMERSION)

- B.1 System No. 66HS-1: High Solids Epoxy
- B.2 System No. 66HS-2: High Build Epoxy

IMMERSION

- C.1 System No. 104-1: High Solids Epoxy (Non-Potable)
- C.2 System No. 20HS-1: High Build Epoxy (Non-Potable)
- C.3

B. OVERHEAD METAL DECKING, JOIST (INTERIOR EXPOSURE)

System No. 115-1: Uni-Bond

C. OVERHEAD METAL DECKING, JOINT (EXTERIOR EXPOSURE)

System No. 1029-1 Enduratone

D. GALVANIZED STEEL-PIPE AND MISCELLANEOUS FABRICATORS

System No. 1095-3: Epoxy/High Build Urethane

E. GALVANIZED STEEL-INTERIOR EXPOSURE (NON-IMMERSION) AND ALUMINUM IN CONTACT WITH CONCRETE

System No. 66HS-3: Polyamide Epoxy

F.

G.

I. CONCRETE

EXTERIOR-ABOVE GRADE

- A.1 System No. 1026-1: Acrylic Emulsion Low Sheen
- A.2 System No. 156-1: Modified Acrylic Elastomer

EXTERIOR-BELOW GRADE

- B.1 System No. 46-61: Coal Tar Pitch Solution
- B.3

EXTERIOR/INTERIOR EXPOSURE (NON-IMMERSION)

- C.1 System No. 1026-2: Acrylic Emulsion Low Sheen
- C.2 System No. 66HS-4: Epoxy-Polyamide

IMMERSION (POTABLE & NON-POTABLE)

- D.1 System No. 104-2: High Solids Epoxy (Non-Potable)
- D2 System No. 20HS-2: Epoxy Polyamide (Potable)

INTERIOR EXPOSURE (NON-IMMERSION)

- E.1 System No. 66HS-5: High Solids Epoxy
- E.2 System No. 113-1: Acrylic Epoxy Semi-Gloss

J. CONCRETE FLOORS

- A.1 System No. 290-1: Epoxy-Polyamide
- A.5 System No. 241/222: Decorative / Functional Flooring (Non-Slip)

K. POROUS MASONRY - EXTERIOR/INTERIOR EXPOSURE

- A.1 System No. 156-2: Modified Epoxy-Sand Texture
- A.2 System No. 104-3: High Solids Epoxy (Interior Only)
- A.3 System No. 113-2: Acrylic Epoxy Semi-Gloss (Interior Only)
- A.4 System No. 156-3: Modified Acrylic Elastomer

L. GYPSUM WALLBOARD

- A.1 System No. 113-3: Acrylic Epoxy
- A.2 System No. 66HS-5: Hi-Build Epoxoline
- A.3 System No. 1026-3: Acrylic Emulsion, Low Sheen

M. WOOD EXTERIOR/INTERIOR EXPOSURE

- A.1 System No. 1029-2: Acrylic Emulsion Semi-Gloss
- A.2 System No. 6-5: Acrylic Latex

N. PVC PIPE EXTERIOR/INTERIOR EXPOSURE

- A.1 System No. 1095-5: Acrylic Polyurethane

O. INSULATED PIPE-INTERIOR EXPOSURE

- A.1 System No. 1026-4: Acrylic Emulsion, Low Sheen

P. HIGH HEAT SURFACES-FERROUS METAL

A.1 System No. 1528-1: Silicone Aluminum (1200deg F Maximum)

Q. SURFACES EXPOSED TO H₂S/H₂SO₄ (SEVERE EXPOSURE/IMMERSION)

A.1 System No. 434-1: Polyamine Epoxy Mortar Systems

A.2 System No. 142-1: Flake / Aluminum Oxide Filled Polyamine Epoxy

R. EXTERIOR OF PRESTRESSED CONCRETE TANKS

A. System 156-4 New Tanks

B. System 156-5: Existing Tanks (Previously Painted)

S. SECONDARY CONTAINMENT AREAS

A. System No. 239SC-1: Modified Novolac Epoxy

B. System No. 61-1: Cycloaliphatic Amine Epoxy

T. CLEAR WATER REPELLENT FOR CONCRETE, MASONRY AND BRICK

A. Silane /Siloxane Sealer (Min. 42% Solids)

V. CANAL PIPE (AERIAL) CROSSINGS

A. System No. 701-1: Zinc/Epoxy/Fluoropolymer

B. System No. 701-2: High Build/Fluoropolymer

C. Ductile Iron Pipe Above Grade: Series 66 High Build Epoxy

3.33 COATING SCHEDULE - TO BE DEVELOPED BY PROJECT AS NEEDED

END OF SECTION

SECTION 09901 ROOF COATING AND MEMBRANE SYSTEM - NOXYDE

PART 1 GENERAL

- A. The Contractor shall furnish all labor, materials, equipment and incidentals required to install and test the coating and membrane system complete and ready for service as listed in the specifications and as shown on the Drawings.

The coating and membrane system consists of special V.O.C. compliant, 100% U.V. resistive anti-corrosion coating(s) and surface preparation as shown in the attachments and as specified herein.

- B. The work includes installing a coating and membrane system of all new materials. This includes, but is not limited to:
1. Metal Standing Seam Roof: The entire metal standing seam roof including valleys, ridges, penetrations and the fascias and gutters.
 2. Built Up Roof:
 - a. The entire built-up roof area shall be recoated as noted herein.
 - b. All parapet walls from the metal coping to roof cove and all roof top mechanical equipment penetrations, exhausts, scupper, drain, etc., shall be properly flashed at the base to the roof surface in accordance with manufacturer's recommended details. Membrane shall extend approximately one foot onto the roof surface.
- C. All other work obviously required to be coated unless otherwise specified herein or on the Drawings. The omission of minor items in the Schedule of Work shall not relieve the Contractor of his obligation to include such items where they come within the general intent of the Specification as stated herein.

1.02 RELATED WORK

- A. Surface cleaning is the responsibility of the General Contractor.
- B. Contractor shall ensure that all debris is disposed of properly; provide appropriate barricades and protection to allow traffic and pedestrian traffic flow without obstruction to the work area; and ensure proper protection is provided so that no overspray will occur during the cleaning phase or the coating phase of this project.
- C. Contractor shall confer and coordinate with County as to loading and unloading, storage areas, dumpsters, etc., so as not to interfere with the office operation. Dumpsters for this work shall be provided by the Contractor and included in this bid.
- D. Power and water for surface preparation and coating and membrane application is available for use by the Contractor for this project. Contractor shall confer and coordinate this with the County. All power extensions and water hoses shall be the responsibility of the Contractor as shall the use of same. If the power or water sources are inadequate, then the Contractor shall provide alternate sources at his expense.
- E. Contractor shall provide and coordinate toilet facility location with the County.
- F. All required regulations of OSHA are to be adhered to and are made part of this specification. Protective gear is to be worn at all times according to the regulations of OSHA as defined by

the work method involved.

- G. The County's property protection is mandatory and is the responsibility of the Contractor. The Contractor shall provide for the safety of all persons in and or around the work site during all phases of the work. The Contractor shall coordinate ALL his activities with the County at all times.
- H. Surface preparation and coating and membrane application will be addressed in future sections of these specifications. Coating and membrane system(s) must be installed at temperatures above 45 degrees F. and rising. Coating and membrane system(s) need 24 hours for full cure. The Contractor shall insure that no foreign products, oil, gas, steam, etc., come in contact with coating and membrane system(s) for at least 24 hours. Coating and membrane system(s) should not be installed when rain is expected within four hours of application.
- I. Coating and membrane system(s) are non-toxic. Mixing and application by brush, roller or airless spray can be done in an enclosed environment without any need for fresh air. Normal spray masks should be used during application. No special precautions need to be used for hands and skin when in contact with coating and membrane system(s).
- J. Coating and membrane system(s) remain water soluble. Spray equipment, brushes, and rollers can be cleaned up with water. After 30 minutes, coating and membrane system(s) will dry and then paint thinners would be used for cleaning.

1.03 SUBMITTALS

- A. Submit to the County, shop drawings and schedules of the coating and membrane system and appurtenances required. Submit design data and specification data sheets listing all parameters used in the coating and membrane system design and thickness calculations based on applicable provisions of ASTM or other expected standards.
- B. Submit the following information and material for approval prior to commencing the work and delivering product to the project:
 - 1. Coating and membrane system(s) manufacturer's data sheets and samples of each finish and color;
 - 2. Complete progress schedule of surfaces to be coated and shall identify the proposed surface preparation, coating and membrane system(s), mobilization, cleanup and demobilization.
- C. Test reports.

1.06 GUARANTEE

- A. All surfacing shall be guaranteed by the Contractor for a period of ten years from the date of acceptance. During this period, all defects discovered in the surfacing, as determined by the County, shall be repaired or replaced in a satisfactory manner at no cost to the County.
- B. The Contractor shall provide Manufacturer's standard warranty for all materials and labor for a period of ten (10) years after the date of acceptance by the County. Mathys, ACT-Martco and the Contractor shall be responsible for all rusting, delamination, cracking, and peeling from the substrate under normal conditions and in accordance with the manufacturer's standard form of warranty for such projects. The Contractor shall be responsible for the first three years of this

warranty and Mathys/ACT-Martco shall be responsible for the last seven years of this warranty.

1.07 QUALITY ASSURANCE

- A. All surfacing products shall be from a single manufacturer.
- B. Inspections of the material may also be made by the County or other representatives of the County after delivery. The material shall be subject to rejection at any time on account of failure to meet any of the Specification requirements, even though sample may have been accepted as satisfactory at the place of manufacture. Materials rejected after delivery shall be marked for identification and shall be removed from the job at once.
- C. Use adequate number of skilled workmen who are thoroughly trained and experienced in the necessary crafts and who are completely familiar with the specified requirements and the methods needed for proper performance of the work of this Section.
- D. The Contractor shall employ specialty workers who have proven ability to perform the Work included herein. This will consist of a minimum of two years or two project experiences installing this product. This is a requirement for each and every employee.
- E. Use equipment adequate in size, capacity and number sufficient to accomplish the Work of this Section in a timely manner.
- F. In addition to complying with requirements of governmental agencies having jurisdiction; comply with the directions of the County.

1.08 DELIVERY, STORAGE AND HANDLING

- A. Coating, membrane components and primer shall be delivered in unopened containers. They shall be shipped at temperatures above freezing as they are water based.
- B. Polyester Reinforcement Mesh shall be delivered in rolls from 10 inches to 39 inches wide. Bridging mesh shall be delivered in rolls about 9 inches wide.
- C. Coating, membrane components and primer must be stored at temperatures above freezing and out of the weather. The containers must remain unopened until ready to be used.
- D. Care shall be taken in shipping, handling and placing to avoid damaging. Any material damaged in shipment shall be replaced as directed by the County.
- E. Any material showing deterioration, or which has been exposed to any other adverse storage condition that may have caused damage, even though no such damage can be seen, shall be marked as rejected and removed at once from the work.

PART 2 PRODUCTS

2.01 COATING SURFACE SYSTEM

- A. The coating surface system shall be equal to those manufactured by Martin Mathys, S.A., nationally distributed by ACT-Martco, Elmsford, New York, distributed in Florida by Marvin A. Flam, Palm Harbor, FL, (813) 934-4485 or equal. Products of other manufacturers comparable in quality and type to those specified shall be considered if the manufacturer provides, in writing, satisfactory proof on past performance of similar applications and with sufficient data

substantiated by certified tests to demonstrate its equality to the coatings named. The written acceptance by the County shall be obtained before any such alternate products are ordered by the Contractor.

2.02 METAL STANDING SEAM ROOF

- A. VOC compliant water based Anti-Corrosion Coating shall be NOXYDE as manufactured by Martin Mathys, S.A., and nationally distributed by ACT-Martco, Elmsford, New York.

NOXYDE is a one part, self priming, fluid applied, seamless, flexible, waterproof system, applied over clean, tight rust or clean old coatings (including lead paint). Existing metal shall be properly cleaned leaving a sound, contaminant free substrate prior to the application of the anti-corrosion coating. Coating is cold applied, fluid anti-corrosion system for steel and metal surfaces. Coating is one part product, packed in 20 kilo units. Coating system is a self priming system that cures to a fully seamless, flexible, 100% waterproof, 100% U.V. resistant system.

- B. Final coat shall be PEGACRYL as manufactured by Martin Mathys, S.A., and nationally distributed by ACT-Martco, Elmsford, New York. PEGACRYL is a one-part, water-based acrylic coating containing 26% resin emulsions and free of internal or external plasticized polyvinyl acetate.
- C. Reinforcing mesh shall be polyester open weave mesh M107, 6" wide mesh x 320 feet. Reinforcement is used for special conditions, to bridge large cracks, holes, etc., and can be used to seal joints, seams and other areas where water entry must be stopped.
- D. Elastic Sealant shall be ELASTOFILL as manufactured by Martin Mathys, S.A., nationally distributed by ACT-Martco, Elmsford, New York. The waterproof sealant is discharged from caulking tube. ELASTOFILL is a one-part, water-borne acrylic malleable paste which, after complete cure, forms a highly elastic, rubber-like, 100% waterproof joint sealant, showing a permanent elasticity, complete impermeability to water, a resistance to alkaline substances, resistance to aging and long term weathering as well as resisting temperatures up to 230 degrees F. without sagging.
- E. Physical Properties and MSDS sheets are available from manufacturer.

2.03 BUILT UP ROOF

- A. VOC compliant water based Seamless Roof System shall be DAKFILL as manufactured by Martin Mathys, S.A., nationally distributed by ACT-Martco, Elmsford, New York.

1. Coating is one part, water-borne acrylic, liquid-applied seamless rubber roofing system. It contains no tar, no asphalt or bitumastic materials. This fully adhered system can be applied over any sound, dry substrate and is unaffected by heat, frost, industrial pollution, UV rays, and long term weathering. DAKFILL can stand ponding water on flat roofs. Coating is a one part product, packaged in 25 kilo units which will provide 125 S.F. coverage for the two coat system over flat roofs and parapets dependent on surface texture and porosity. Existing substrate shall be properly cleaned leaving a sound, contaminant free substrate prior to the application of the seamless roofing system coating. Membrane system is a self priming system that cures to a fully seamless coating which is 100% waterproof, 100% U.V. resistant and flexible. Reinforcing mesh can be used in special situations to take care of highly damaged roofs and parapet walls or large cracks in the system.

- B. Reinforcing mesh shall be polyester open weave mesh 8" or 48" wide mesh x 320 feet. Reinforcement is used for special conditions, to bridge large cracks, holes, etc. and can be used to seal joints, seams and other areas where water entry must be stopped.
- C. Elastic Sealant shall be ELASTOFILL as manufactured by Martin Mathys, S.A., nationally distributed by ACT-Martco, Elmsford, New York. The waterproof sealant is discharged from caulking tube. ELASTOFILL is a one-part, water-borne acrylic malleable paste which, after complete cure, forms a highly elastic, rubber-like, 100% waterproof joint sealant, showing a permanent elasticity, complete impermeability to water, a resistance to alkaline substances, resistance to aging and long term weathering as well as resisting temperatures up to 230 degrees F. without sagging.
- D. Top coat shall be PRT COATING as manufactured by Martin Mathys, S.A., nationally distributed by ACT-Martco, Elmsford, New York. PRT COATING is a one part solvent acrylic finish coat, non-saponifiable, that can be applied directly to new concrete or used as a top coat for DAKFILL roof finishes.
- E. Physical Properties and MSDS sheets are available from manufacturer.

2.04 COLORS

- A. Color of each product for each application shall be selected by the COUNTY and provided to the CONTRACTOR prior to his placing order for product. The color selection shall be from standard colors by the manufacturer. The product shall be delivered to the Contractor already color mixed and properly identified. CONTRACTOR shall mix product thoroughly to insure uniform color throughout.

PART 3 EXECUTION

3.01 INSTALLATION

- A. Work for this project shall be carried out in accordance with all Local, State, Federal Laws and Regulations with the most restrictive laws or regulations being followed. CONTRACTOR shall comply with all ordinances regarding dust, debris and noise and shall be required to adhere to same. Permits, inspections, and appropriate certificates as required by the work under this contract shall be obtained by and paid for by the CONTRACTOR.
- B. Coating and membrane system must be installed by an applicator familiar with the coating or membrane system as well as under the guidance of the manufacturer. Inspections will be made by the manufacturer's authorized technical consultant throughout the Project and final inspections will be conducted by the regional or national technical consultants of the manufacturer with the CONTRACTOR. CONTRACTOR shall coordinate with the manufacturer's technical inspector for times and applications phase terminations so that inspections may occur without delaying the next phase of the application. A final inspection will ascertain that the Coating or Membrane System has been installed in accordance with the specifications for the project. No deviations will be allowed from the manufacturer's specifications, unless these changes are submitted and approved in advance by the County in conjunction with the manufacturer's technical consultant prior to the start of the project application.
- C. CONTRACTOR shall familiarize himself with all aspects of the job prior to providing his bid proposal for the project. He shall proceed with the work in an orderly and prompt manner upon authorization. He shall commence with the work as required minimizing noise and other

disturbances to the normal operation of the office facility. He shall remove all debris immediately from the area so that the wind does not carry the debris beyond the work area.

PART 3 APPLICATION

3.01 METAL STANDING SEAM ROOF

A. SURFACE PREPARATION

1. Pressure wash entire surface with 3000 psi at 180 degrees F. hot water and Dirt Killer DK Spinner Tip or Turbo-tip at point blank range. As soon as surface is dry, coating work can begin.
2. Hand scrape or wire brush any heavy rust areas, catching any hazardous particles.
3. Feather edge around the old coating to relieve the pressure of lift off.
4. Remove excess oil and grease (if any) with TSP or other detergents. As soon as surface is dry, coating work can begin.

B. APPLICATION

1. ELASTOFILL is applied over all fasteners and along panel joints and seams.
2. Six inch reinforcing mesh and NOXYDE at 13 mils wet is applied to all open joints, over copings, roof plane connections where there is movement and at transition and along edges as required to totally seal the roof, yet allow it to move.
3. NOXYDE (Color #1) diluted by 33% water is sprayed as a fog coat over the entire standing seam metal roof and fascia surface at a 2 dry mill thickness for adhesion.
4. NOXYDE (Color #2) is sprayed with airless spray at 13 mills wet over entire standing seam metal roof and fascia surface.
5. PEGACRYL (Final Color) is sprayed as the final coat with airless spray at 5 wet mils over the entire standing seam metal roof and fascia surface.
6. Final PEGACRYL coat can be sprayed over first coat after overnight drying. If more than two (2) days elapse between the first and second coats, light water wash is recommended to remove dirt and salt contamination of the first coat.

3.02 BUILT UP ROOF

A. PREPARATION

1. Remove all water damaged insulation and replace it in a proper manner to original roof height. All surfaces shall be sound, clean and dry before proceeding with the application.
2. Chip off any alligatored surfaces to leave a smooth work surface. Remove all loose and damaged paper. Seal up any cracks, holes and flashing areas to make them watertight. Use star cut repair on any blisters.
3. Sweep up all dirt AND DEBRIS in work area before pressure wash.
4. Verify that all roof drains, gutters and leaders are not clogged prior to hot water pressure wash. Pressure wash the area to be repaired with 180 degrees F. hot water minimum pressure of 1500 psi to eliminate any salts and bacteria and allow to dry thoroughly for at least 24 hours before proceeding with the work.
5. In areas of ponding water in the work area, scrub vigorously using one (1) part chlorine and three (3) parts water to kill embedded microorganisms in the work surface. TSP can be added to this mix to remove oil, grease, dirt and other latents. These areas shall be re-rinsed before application.

B. APPLICATION

1. PARAPET WALLS: Starting at the fascia of the metal coping, use the flashing mesh and DAKFILL to bridge these joints, seal them up, yet allow them to move and flex in the future. DAKFILL membrane can be extended with roller or brush, over the inside area of the parapet wall using flashing mesh and extended at least 12 inches onto roof deck. ELASTOFILL should be applied into the cracks as filler material before mesh and DAKFILL are applied.
2. REGLET FLASHING: Bridging mesh and DAKFILL is applied over the REGLET Flashing on the wall, making a flexible "bridge" over this area.
3. COVE AREA OF ROOF: Using the 18-inch wide mesh, coating the cove area of the roof shall be completed and cut in prior to starting the spray application of DAKFILL. Work area shall extend at least 12 inches onto roof deck.
4. DRAIN and SCUPPER: Shall be flashed with reinforcing mesh and DAKFILL. The work shall be cut in accordance with manufacturer's details. Drain shall be flashed into the throat of the drain and up onto at least 12 inches of the roof deck.
5. MECHANICAL EQUIPMENT, PENETRATIONS, ETC.: DAKFILL with flashing mesh shall be applied around all penetrations using scissors to cut scalloped legs into the mesh so it will free-form itself around the penetration and reinforce the membrane in the joint area. ELASTOFILL should be added to form a rubbery bumper right in the 90 degree angle of this work. DAKFILL and mesh can be applied directly and immediately over the ELASTOFILL. Work should extend at least 12 inches onto roof deck and over top of base. All rusted areas should be coated with one coat of NOXYDE at 13 wet mils.
6. Once the flashing and specialty work is completed, the first coat of DAKFILL is applied. Apply DAKFILL thru 48 inch mesh, using roller application onto deck surface. First coat is applied so that all holes in mesh are filled up. Let dry overnight.
7. Apply second coat of DAKFILL to obliterate mesh, and let dry 48 hours. This can be done with roller or airless spray (21-26 tip) and left to cure overnight.
8. Apply sealer coat of White PRT over entire flat surface at 3-4 wet mils thickness.

PART 4 WORKMANSHIP

- A. The Contractor shall be responsible for the cleanliness of his coating operations and shall use covers and masking tape to protect the new and existing material not intended to be coated whenever such covering is necessary, or if requested by the County. Any coatings identified for removal shall be carefully removed without damage to any finished coatings or surface. If damage does occur, the entire surface, adjacent to and including the damaged area, shall be re-coated without visible lapmarks and without additional cost to the County.
- B. Coating found defective shall be removed and re-coated as required by the County. Before final acceptance of the Work, damaged surfaces shall be cleaned and re-coated as directed by the County.
- C. CLEANUP: The buildings and other Work areas shall be kept free from accumulation of waste material and rubbish caused by the work. At the completion of the coating work, all tools, equipment, scaffolding, surplus materials, and all rubbish around the building(s) shall be removed and the work area left broom clean unless otherwise specified.

END OF SECTION

SECTION 09970 SURFACE PROTECTION SPRAY SYSTEM

PART 1 GENERAL

1.01 SCOPE OF WORK

- A. The Contractor shall furnish all labor, materials, equipment and incidentals required to install and test the coating system complete and ready for operation for the structures listed in the specifications and as shown on the Drawings.
- B. The work includes coating of all surfaces as shown and specified on the Drawings. This includes, but is not limited to stairs, walls, floors, concrete divider, concrete slabs, manholes wet wells, and all other work obviously required to be coated unless otherwise specified herein or on the Drawings. The omission of minor items in the Schedule of Work shall not relieve the Contractor of his obligation to include such items where they come within the general intent of the Specification as stated herein.

1.02 RELATED WORK

- A. Bypass pumping is the responsibility of the General Contractor.
- B. Concrete surface cleaning in each lift station is the responsibility of the General contractor.
- C. Removal and offsite disposal of rubble is the responsibility of the General Contractor.

1.03 SUBMITTALS

- A. Submit to the County shop drawings and schedules of all surfacing systems and appurtenances required. Submit design data and specification data sheets listing all parameters used in the surfacing system design and thickness calculations based on applicable provisions of ASTM.
- B. Submit to the County the name of the surfacing supplier, a list of materials to be furnished, and the qualification (per 1.05 A) of the application contractor.

1.04 REFERENCE STANDARDS

- A. American Society for Testing and Materials (ASTM)

ASTM D-638
ASTM D-790
- B. Where reference is made to one of the above standards, the revision in effect at the time of bid opening shall apply.

1.05 QUALIFICATIONS

- A. The Contractor performing the surfacing work shall be fully qualified, experienced a minimum of seven years and equipped to complete this work expeditiously and in a satisfactory manner. The Contractor shall submit the following information to the County for review and approval before any surfacing work is performed.

1. The number of years of experience in performing this type of specialized work must

be seven years minimum.

2. Name of the surfacing manufacturer and supplier for this work and previous work listed below. The Contractor shall be an approved installer as certified and licensed by the surfacing manufacturer and equipment supplier.
 3. A list of clients that the Contractor has performed this type of work.
 - a. The list shall contain names and telephone numbers of persons who can be called to verify previous satisfactory performance.
 - b. Installation dates and a description of the actual work performed.
 - c. The surfacing manufacturer shall provide an installation list of his product used for similar sewer rehabilitation projects. The list shall provide the same information as required in paragraphs 3.a and 3.b above.
- B. The County reserves the right to approve or disapprove the Contractor, based on the submitted qualifications.

1.06 GUARANTEE

All surfacing shall be guaranteed by the Contractor for a period of five years from the date of acceptance. During this period, all defects discovered in the surfacing, as determined by the County, shall be repaired or replaced in a satisfactory manner at no cost to the County, this shall include, but is not limited to, all work and costs associated with the shut down of any pump stations and all bypass operations needed for the proper repairs to be made.

1.07 QUALITY ASSURANCE

- A. All surfacing products shall be from a single manufacturer. The supplier shall be responsible for the provisions of all test requirements specified in ASTM Standards D-638 and D-790 as applicable.
- B. The Contractor shall employ specialty workers who have proven ability to perform the Work included herein. This will consist of a minimum of two years or two project experiences installing this product. This is a requirement for each and every employee.

1.08 DELIVERY, STORAGE AND HANDLING

- A. Care shall be taken in shipping, handling and placing to avoid damaging. Any material damaged in shipment shall be replaced as directed by the County.
- B. Any material showing deterioration, or which has been exposed to any other adverse storage condition that may have caused damage, even though no such damage can be seen, shall be marked as rejected and removed at once from the work.

PART 2 PRODUCTS

2.01 GENERAL

- A. The material sprayed onto the surface shall be a urethane resin system formulated for the application within a sanitary sewer environment. The urethane will exhibit suitable corrosion

resistance to corrosive gases and fluids found within domestic sanitary sewage. Unless dictated by varying effluent, the spray system shall be a urethane and exhibit the cured physical strengths specified herein.

- B. When cured, the surface coating shall form a continuous, tight-fitting, hard, impermeable surfacing data which is suitable for sewer system service and chemically resistant to any chemicals or vapors normally found in domestic sewage.
- C. The surface shall be an integral part of the structure being rehabilitated after being placed and cured. The surface shall cover the complete interior of the existing structure. The surface shall provide a continuous watertight seal or barrier.
 - 1. The surface shall effectively seal the interior surfaces of the structure and prevent any penetration or leakage of groundwater infiltration.
 - 2. Provide water resistance data on surface based on ASTM Standards.
 - 3. The surface shall be compatible with the thermal conditions of existing sewer lift stations and manholes. Surface temperature will range from 30 to 80 degrees F. Provide test data on thermal compatibility based on ASTM Standards.

2.02 MATERIALS

- A. Approved materials include
 - 1. Aquatapoxy A-6 and Raven 405 epoxy by Raven Lining Systems
 - 2. Green Monster
 - 3. Sauereisen 210 system (210T & 210GL - Manatee County Light Brown Formula)

- B. Polyurethane spray application shall comply with the following specifications:

The cured urethane system shall conform to the minimum physical standards, as listed below. The long-term data is for a 50-year design life of the process.

| <u>Cured Urethane</u> | <u>Standard</u> | <u>Long-Term Data</u> |
|-----------------------|-----------------|-----------------------|
| Tensile Stress | ASTM D-638 | 5,000 psi |
| Flexural Stress | ASTM D-790 | 10,000 psi |
| Flexural Modulus | ASTM D-790 | 550,000 psi |

- C. Epoxy spray application shall be 100% VOC free / 100% solids.

PART 3 EXECUTION

3.01 SURFACE PREPARATION

- A. The contractor shall clean each structure and shall dispose of any resulting material.
- B. All contaminants including: oils, grease, incompatible existing coatings, waxes, form release, curing compounds, efflorescence, sealers, salts, or other contaminants shall be removed.

- C. All concrete or mortar that is not sound or has been damaged by chemical exposure shall be removed to a sound concrete surface or replaced.
- D. Surface preparation method(s) should be based upon the conditions of the substrate, service environment and the requirements of the protective coating to be applied.
- E. Surfaces to receive protective coating shall be cleaned and abraded to produce a sound surface with adequate profile and porosity to provide a strong bond between the protective coating and the substrate. Generally, this can be achieved with a high pressure water cleaning using equipment capable of 5,000 psi at 4 gpm. Other methods such as abrasive blasting, shotblasting, grinding, scarifying or acid etching may also be used. Detergent water cleaning and hot water blasting may be necessary to remove oils, grease or other hydrocarbon residues from the concrete. Whichever method(s) are used, they shall be performed in a manner that provides a uniform, sound clean neutralized surface that is not excessively damaged.
- F. A concrete structure suitably prepared for coating shall have all loose, soft, discolored or otherwise deteriorated material removed from the manhole and the surface profile of the manhole shall be in accordance with ICRI Guidelines No. 03732. Expose aggregate and obtain a uniform surface texture resembling an ICRI - CPS (Concrete Surface Profile) #4-6. The County may use one or more of the following observations/tests to determine whether the manhole substrate has been properly cleaned and prepared:
 - a. Visual appearance of the manhole - The prepared substrate shall have the appearance of sound concrete, free from discolored, white, chalky and cracked areas.
 - b. Aural observations - When struck with a metal hammer or similar metal tool, the prepared substrate shall exhibit the characteristic sound of solid, competent concrete (or brick). Care should be taken not to fracture sound concrete.
 - c. Mechanical abrasion tests - The substrate should be competent enough such that it cannot be scraped off with the claw of a hammer or similar metal tool.
 - d. pH testing - The County may use wetted litmus paper applied to the surface of the substrate to ensure that the pH of the substrate is 7 or higher.
 - e. Phenolphthalein testing - The County may apply a few drops of phenolphthalein to the surface of the concrete, which if the concrete is competent should yield a purple color.
- G. The County is not obligated to use all of the above tests, but may do so at the County's sole discretion. Often visual, mechanical and/or aural observations and tests alone will be adequate, but the pH and/or phenolphthalein tests may be used if there is still some uncertainty.
- H. If after cleaning, a new or existing manhole does not meet these requirements, the County shall have authority to require additional cleaning effort and/or increased blasting pressure as required to adequately prepare the manhole. If necessary, the County may also require acid etching of the concrete surface to create the desired texture. For existing manholes, the County may also require mechanical removal of deteriorated concrete or other substrate materials.
- I. A mild chlorine solution may be used to neutralize the surface to diminish microbiological bacteria growth prior to final rinse and coating system if approved by the Manufacturer's Representative.
- J. The time between structure cleaning and preparation activities and application of the first coating layer shall be within the coating manufacturer's recommendation.

- K. All infiltration shall be stopped by using a material which is compatible with and is suitable for topcoating with the specified protective coating.
- L. The area between the manhole and the manhole ring and any other area that might exhibit movement or cracking due to expansion and contraction, shall be grouted with a flexible grout or gel before surface coating spray application.
- M. All surfaces should be inspected by the Inspector during and after preparation and before the repair material is applied.
- N. No separate payment shall be made for any preparatory work required prior to application of the surface coating.

3.02 INSTALLATION

- A. The Contractor shall notify the Project Manager at least 48 hours in advance, giving the date, start time and estimated completion time for the work being conducted.
- B. The Contractor shall provide bypass pumping of sewage flows (as required) where and when the rehabilitation work is being performed. No flows will be permitted in the structure until the spray coating has properly cured to the manufactures specifications.
- C. The installation of the surface coating shall be in complete accordance with the applicable provisions of ASTM and the manufacturer's specifications. A representative of the manufacturer shall be present during the actual installation.
 - 1. Prior to placing the surface coating, the manufacturer's representative must approve the surface preparation work and installation conditions including temperatures.
 - 2. All surfaces shall be sufficiently smooth and even, to ensure good flow handling characteristics when complete.
 - 3. All surfaces shall have the surface coating applied to the required thickness by spray application.
- D. Application procedures shall conform to the recommendations of the protective coating manufacturer, including material handling, mixing, environmental controls during application, safety, and spray equipment.
- E. The spray equipment shall be specifically designed to accurately ratio and apply the specified protective coating materials and shall be regularly maintained and in proper working order.
- F. The protective coating material must be spray applied by a Certified Applicator of the protective coating manufacturer.
- G. Polyurethane spray application shall be applied such that all surfaces shall be coated in accordance with the manufactures recommended thickness but not be less than 125 mils.
- H. Epoxy spray application shall be applied such that all surfaces shall be coated in accordance with the following:
 - 1. Specified surfaces shall be coated by spray application of a moisture tolerant,

solvent-free, 100% solids, epoxy protective coating as further described herein. Spray application shall be to a minimum wet film thickness in accordance with the following table or manufacturer's recommendation, whichever is greater:

| | |
|----------------------|---|
| Concrete, New/Smooth | 80-100 mils for immersion, 60-80 mils for atmospheric, splash and spill exposure |
| Concrete, Rough | 100-125+ mils |
| Masonry/Brick | 125-150+ mils |
| Steel | 16-80 mils for immersion, 16-40 mils for atmospheric, splash and spill exposure; also profile dependent |
| Fiberglass Systems | 40-60 mils tack coat, 9 oz/yd ² fabric, 40-60 mils top coat. Varies with circumstances |

2. Airless spray application equipment approved by the coating manufacturer shall be used to apply each coat of the protective coating. Air assisted spray application equipment may be acceptable, especially for thinner coats (<10 mils), only if the air source is filtered to completely remove all oil and water.
3. If necessary, subsequent topcoating or additional coats of the protective coating should occur as soon as the basecoat becomes tack free, ideally within 12 hours but no later than the recoat window for the specified products. Additional surface preparation procedures will be required if this recoat window is exceeded.

3.03 FIELD TESTING AND ACCEPTANCE

- A. Field acceptance of surface coatings shall be based on the County's evaluation of the proper surfacing of the structure and the appropriate installation and curing test data along with review of the structure inspections.
- B. The surface coatings shall provide a continuous monolithic surfacing with uniform thickness throughout the structure interior. If the thickness of the coating surface is not uniform or is less than specified, it shall be repaired or replaced at no additional cost to the County.
 1. The County will measure the surface cured thickness from a specimen retrieved by the Contractor. The Contractor shall retrieve the specimen by physically cutting through the surfacing (by drilling or coring). There will be up to three thickness measurement locations in each structure. A suitable non-destructive type of thickness measurement may also be used.
 2. All the surface coating thickness measurement locations shall be repaired by the Contractor in accordance with the manufacturer's recommendations. These repairs shall be included in the five year surface coating guarantee.
- C. All pipe connections shall be open, clear, and watertight.

- D. There shall be no cracks, voids, pinholes, uncured spots, dry spots, lifts, delaminations or other type defects.
- E. If any defective surface coating is discovered after it has been installed, it shall be repaired or replaced in a satisfactory manner within 72 hours and at no additional cost to the County. This requirement shall apply for the entire five year guarantee period.

END OF SECTION

DIVISION 10 SPECIALTIES

SECTION 10520 FIRE EXTINGUISHERS

PART 1 GENERAL

1.01 SCOPE OF WORK

- A. Furnish all labor, materials, equipment and incidentals required and install fire extinguishers and the requisite wall mounting brackets at the locations shown on the Contract Drawings.

PART 2 PRODUCTS

2.01 MATERIALS

- A. Fire extinguishers shall be 10 pound capacity, dry chemical type, rated for A, B and C Class fires. Extinguishers shall be red enamel painted steel cylinders with indicating gauge and shall be as manufactured by Larsen's Manufacturing Company, Fyr-Fyter Company, or County Fire Equipment Company.
- B. Brackets for wall mounting, as manufactured by extinguisher manufacturer, shall be furnished for all fire extinguishers.

PART 3 EXECUTION

3.01 INSTALLATION

- A. Fire extinguishers and brackets shall be wall mounted.
- B. Mount brackets 4 feet 6 inches above finish floor with expansion bolts or toggle bolts into concrete blocks.

END OF SECTION

DIVISION 11 EQUIPMENT

SECTION 11210 VERTICAL TURBINE PUMPS

PART 1 GENERAL

1.01 SCOPE OF WORK

- A. Furnish and factory test two (2) vertical turbine pumps of the sizes and capacities hereinafter specified.

1.02 MANUFACTURERS' QUALIFICATIONS

- A. The pumps shall be the products of manufacturers who have a minimum provable history of ten (10) years in the manufacturing and servicing of pumps of the type, size, and capacity hereinafter specified.

1.03 APPLICATION

- A. The pumps will be used to pump a liquid consisting of wastewater effluent having a specific gravity of 1.0. The pumped liquid will be at ambient temperature (nominally, 76°F).
- B. The pumps will be used in a variable speed pumping system application.

1.04 OPERATING CONDITIONS

- A. The pumps shall be able to operate under the following environmental conditions without modification or derating:
 - 1. Temperature: 0 to 40°C.
 - 2. Altitude: Up to 3,300' above sea level.
 - 3. Humidity: 0 to 95%, non-condensing.
 - 4. Location: Wastewater Treatment Facility.

1.05 PUMP TESTING

- A. Prior to shipment, the pumps shall be subjected to certified factory tests, both hydrostatic and vibrational, in accordance with the standards of the Hydraulic Institute.
- B. The County may, at his option, have an authorized representative(s) witness the factory pump tests. The manufacturer/supplier shall include in his price an amount sufficient to reimburse the County for all reasonable out-of-pocket expenses incurred by the County's representative(s) to witness the factory tests. If multiple visits are necessary, the County shall deduct the additional expenses incurred from the payments due the manufacturer/supplier.
- C. The County shall be notified of the factory testing at least ten (10) working days prior to the tests being conducted. Such notification shall include the date, time, and location of the tests. Additionally, the notification of testing shall include both a list of the testing procedures to be followed and a list of the test equipment to be used.
- D. All meters, gauges, and other test equipment used must be calibrated within thirty (30) days prior to the testing and certified copies of the calibration data shall be furnished to the County.

- E. After the factory testing is completed, the County may, at his option, seal any and all devices used in the testing and ship said device(s) to an independent testing laboratory for calibration check tests. The cost of such testing shall be borne by the manufacturer.
- F. Each pump shall be tested through a range of flows and head/capacity/brake horsepower/efficiency curves plotted. During each test, the pump shall be run at each head condition for a period of time sufficient to accurately determine discharge, head, power input, and efficiency. During the tests, the overall pump efficiency shall be determined at the "design point".

1.06 SUBMITTALS

- A. The pump manufacturers shall furnish the County with five (5) sets of pump documents for review and approval. If any manufacturer requires more than two (2) sets to be returned for his own use, then he should increase the number of submittal sets accordingly.
- B. The pump submittal documents shall include, but not necessarily be limited to, the following:
 - 1. Certified shop and installation drawings which show all important details of construction, including dimensions, weights, and anchor bolt locations and size.
 - 2. Descriptive literature, bulletins, and/or catalogs of the pump.
 - 3. Data on the characteristics and performance of each pump. Data shall include guaranteed performance curves based on actual factory testing of a similar pump(s). Curves shall clearly show compliance with the specified requirements for head, capacity, efficiency, etc. Curves shall be submitted on 82 x 11" sheets plotted to as large a scale as is practical.
 - 4. A complete bill of materials listing all parts, assemblies, subassemblies, bearing, gaskets, etc.
 - 5. A list of recommended spare parts to be supplied by the pump manufacturer. If not already included on his recommended spare parts list, the manufacturer shall also supply the following:
 - a. Two (2) stuffing box bushings.
 - b. Three (3) sets of packing.
 - c. Three (3) sets of gaskets.
 - d. Two (2) sets of bowl bearings.

1.07 SPARE PARTS

- A. The pump manufacturers shall furnish the spare parts as set forth in Item 1.06.B.5 above.
- B. The spare parts shall be furnished in containers which are clearly identified with indelible markings as to contents. Each container shall be packaged with its contents protected for prolonged storage.

1.08 WARRANTY

- A. Each manufacturer shall warrant that his respective pump is free from defects in all materials and workmanship for a period of two (2) years from date of final acceptance, or for the duration of the manufacturer's standard warranty, whichever period is longer.
- B. During the warranty period, any and all covered defects shall be corrected by the respective pump manufacturer solely at his own expense with no cost to the County.

PART 2 PRODUCTS

2.01 VERTICAL TURBINE PUMPS

A. GENERAL

1. The pumps shall be their respective manufacturer's standard model designed and constructed using the best industry practices and methods with a proven ability to operate satisfactorily under conditions similar to those specified.
2. The pumps shall be designed and built for 24-hour a day continuous service at any and all points within the specified operating range without any overheating, cavitation, excessive vibration, or strain.
3. The pumps shall be suitable for variable speed pumping applications.
4. All necessary foundation bolts, plates, nuts, and washers shall be fabricated from 316 stainless steel and shall be furnished by the pump manufacturer.
5. Each pump shall be furnished with a permanently attached stainless steel nameplate stamped with the manufacturer's name, the rated capacity, head, speed, and other pertinent data.
6. All rotating parts shall be dynamically balanced both mechanically and hydraulically so as to operate throughout the design range without excessive thrust, vibration, or noise. All exposed or readily accessible rotating parts shall be covered by guards or screens to prevent injury to personnel.

B. PUMP CONSTRUCTION

1. Capacity: The pump shall have maximum pumping GPM & TDH capacity as noted on the plans.
2. Fluid: The pump shall be used to pump a wastewater effluent liquid having a specific gravity of 1.0 at a nominal ambient temperature of 76°F.
3. Drive Motor: The pump shall be coupled to and driven by a vertical hollow shaft squirrel cage induction motor. The screw (threaded) type coupler shall be furnished by the motor manufacturer.
4. Discharge Head: The pump discharge head shall be as shown on the plans, shall be of fabricated steel construction, shall have a flat faced flanged discharge connection, shall incorporate a suitable pump support baseplate, shall be furnished with an integral fabricated steel mounting ring, and shall be fitted with a bleed-off type stuffing box having a bronze bearing, a bronze cage ring, a split brass packing gland, and not less than four (4) rings of teflon filament or the manufacturer's standard packing; specifically, graphited yarn packing will not be acceptable under this Specification.
5. Pump Column: The pump column shall have a diameter and length as shown on the plans, shall be flanged on both ends, shall be fabricated from Schedule 40 steel, and fitted with cast iron bearing retainers as required to maintain proper alignment of the line shaft.
6. Shafts: The head shaft, line shaft, and bowl shaft shall have a minimum diameter as shown on the plans, shall be fabricated from 416 stainless steel, and shall be fitted with bronze bearings as required. The line shaft shall be joined to the head shaft and the bowl shaft with 416 stainless steel screw (threaded) type couplings.
7. Bowls:
 - a. The pump bowls shall be constructed of Class 30 cast iron and shall be fitted with bronze bearings. The bowls shall be equipped with wear rings fabricated from a nickel-aluminum bronze alloy.
 - b. The pump impellers shall be the enclosed type, shall be of bronze construction, shall be attached to the shaft with steel taper lock fittings, and shall be

- hydraulically balanced to minimize drive motor thrust loading. Impeller diameter (min./max.) shall be as shown on the plans.
- c. The suction case shall be of the bell type, shall be fabricated from cast iron, shall be fitted with a bronze bearing, shall have a brass or bronze sand collar, shall terminate in a steel pipe plug, and shall be covered with a galvanized steel strainer.
8. Pump Coating: Except for the interior of the bowls which are to be Heresite lined, all portions of the pump column and the pump discharge head not exposed to view shall be coated both internally and externally with a modified epoxy, 6-8 mils dry thickness, or with the pump manufacturer's standard coating(s). The coating(s) shall be compatible with the intended pump service. Surface preparation shall be in accordance with the coating manufacturer's recommendations.
 9. Discharge Gauge
 - a. The pump manufacturer shall furnish a discharge gauge for mounting on the centerline of the pump discharge.
 - b. The gauge shall accurately measure the pump discharge pressure.
 - c. The gauge shall be weatherproof, shall be calibrated, shall have a minimum 3-inch dial face, shall have an adjustable dial for field setting and calibration, and shall be the manufacturer's choice and/or standard gauge.
 10. Fasteners: All pump and column fasteners and accessories shall be 316 stainless steel.
 11. Manufacturer: In order to assure system compatibility and interchangeability with existing pumps, the pump shall be a duplicate of existing pump, NO SUBSTITUTIONS!!

PART 3 EXECUTION

3.01 FACTORY TESTING

- A. Prior to shipment, each pump manufacturer shall perform certified factory tests on his respective pump in accordance with the requirements of Item 1.05 above.
- B. During the testing, the major pump parameters shall be recorded and the certified test results shall be forwarded to the County for review and approval prior to shipment of the pumps.

3.02 PUMP HANDLING

- A. After the pumps have been tested, all entrapped water shall be drained and proper care shall be taken to prevent the entrance of water during handling, packaging, and shipping.
- B. Finished iron or steel pump surfaces which are not painted shall be properly coated/protected to prevent rust and/or corrosion.
- C. Finished surfaces of all exposed pump openings shall be protected by strongly built wooden blanks securely bolted thereto.
- D. Factory assembled parts and components shall not be dismantled for shipment unless such dismantling is expressly approved, in writing, by the County.

3.03 SHIPPING

- A. The pumps shall each be so packaged for shipment that they are maximally protected from both physical and environmental damage.

- B. The pumps shall each be transported to the County's job site utilizing the respective manufacturer's customary method of shipment.

3.04 INSTALLATION

- A. The pumps shall be installed by the County's personnel in accordance with the recommendations and procedures set forth in the installation manuals furnished by each pump's respective manufacturer.
- B. An authorized factory trained representative(s) of each pump's respective manufacturer shall be available to assist the County's personnel on an "as needed" basis.

3.05 WARRANTY

- A. Each pump manufacturer shall furnish to the County a written warranty which complies with the requirements of Item 1.08 above.

END OF SECTION

SECTION 11215 DIESEL BACKUP PUMP

PART 1 GENERAL

1.01 SCOPE

- A. Provide and install complete and operable backup diesel powered pump systems for lift stations which contain all the devices and equipment specified herein and/or required for the service. Equipment shall be new, factory and field tested, installed, and ready for operation.
- B. The engine shall be a diesel, Tier III approved and shall be of sufficient horsepower to drive the pump under full load conditions. It shall be 4-cycle, fueled by a sub-base fuel tank and cooled with a closed looped radiator system. The pump is to be compressor assisted self priming. The pump, controls and associated cooling and exhaust systems specified in these specifications are to be housed in a suitable weather protected enclosure which is to be permanently installed outdoors.
- C. Where conflict between drawings, specifications or code occurs, the Contractor shall assume and provide the more stringent of the alternatives to the County.

1.02 RATINGS

- A. Pump is to be installed at:

_____, Florida

This pump is to have a primary capacity of ___ gpm at a TDH of ___ feet, with a maximum capacity of double the primary capacity. This site shall be diesel fueled with a sub-base fuel tank. This site is not in a flood zone and a flood certification is not required.

PLEASE NOTE: Pump is to be built with the following characteristics/conditions:

- 1. The pump should come on automatically when the wet well reaches a high level condition.
- 2. Primary level control shall be a level transmitter.
- 3. Secondary level control shall be with backup floats (“high level” & “off”).
- 4. Programmable controller that allows both scheduled & manual exercising.
- 5. Pump and controls to have contacts for the telemetry system.
- 6. Pump should have the capability to pass a 3” spherical solid.
- 7. Pump has compressor assisted automatic priming.
- 8. Pump to have a weather protected and sound attenuated enclosure.

1.03 MANUFACTURERS

- A. Subject to compliance with requirements stated and defined in these specifications, the following are approved manufacturers:

1. Godwin Pumps
2. Acme Dynamics Pumps
3. Global Pumps

1.05 SUPPLIER

- A. The complete package - engine, pump, fuel tank, controller and other auxiliary components specified in this section shall be provided from a single manufacturer/supplier. The supplier shall be the manufacturer's authorized distributor who shall maintain a service center capable of emergency maintenance and repairs with a maximum of four hours response time. The supplier shall have 24 hour/365 days per year service availability and factory trained service technicians authorized and capable to perform warranty service on all warrantable products.
- B. The supplier shall have satisfactorily provided and installed similar size / design pumping systems for at least 2 other municipalities.

1.06 SUBMITTALS

- A. Prior to and a requirement of contract award, the apparent low bidder shall provide references from at least 3 local municipalities or other businesses that have at least 2 similar type emergency backup pumps in service with response time requirements similar to this contract. The actual service responses will be verified for response time consistency and customer satisfaction.
- B. As a minimum for all equipment specified and provided, for each site, submit the following in pdf format to Manatee County. No equipment is to be ordered until the submittal is approved:
 1. Specification and application data sheets for the entire system supplied.
 2. Supporting calculations and/or documentation signed and sealed by a Professional Engineer licensed in the State of Florida in support of the proposed pump capacity, reinforced concrete pad design, concrete anchors, and 160 mph wind load calculations in support of the concrete pad design and concrete anchors.
 3. Shop drawings showing a dimensioned outline plan and elevation views of the system with certified overall and interconnection point dimensions. Indicate fabrication details, dimensions, weights, loads, required clearances, components, location and size of each field connection and method of field assembly.
 4. Manufacturer's installation instructions.
 5. Interconnection wiring and piping diagrams which show all external connections required. Show field wiring terminals with markings in a consistent point to point manner.
 6. Manufacturer's certification of prototype testing which show evidence of compliance with specified requirement.
 7. Manufacturer's applicable published warranty documents.
 8. Pump control diagram that clearly indicates how the speed of the pump will be controlled and responds to the levels in the wet well and the force main pressures. Current force main pressure ranges can be supplied to the awarded bidder.

9. Shop drawings of the enclosure indicating basic layout, materials, and color. A color swatch shall be submitted for review.
- C. Prior to the County's acceptance of the emergency backup pump system(s), the Contractor shall submit the following for each site(s):
1. Field test results showing compliance with the specifications.
 2. A single O&M manual shall be provided that covers all parts of the generator system and controls for all installations contained in this contract. It shall be tabbed for each different size or type of equipment. The cover page shall indicate the manufacturer, date and contract number as well as listing all pump station sites it applies to.
 3. Signed and sealed final RECORD DRAWING prepared from the site plan by a Professional Surveyor registered in the State of Florida showing all existing and new above ground facilities / improvements, new underground conduit locations, and/or property corners. A CAD file of the project survey can be requested from the County, if available.

The following information shall be provided on the record drawing site plans:

| | |
|---------------------------|--|
| Location in X, Y, & Z | Emergency Pump conc. slab, all new underground pipes and conduits |
| Location in Z (elevation) | top of fuel tank, bottom of ATS, bottom of Egen (if not on top of a fuel tank) |
| Call outs | Emergency Pump information, conduit size, fuel tank size in gallons |

1.07 WARRANTY

- A. A comprehensive, no deductible warranty shall be supplied for the complete system (the pump, controls and all accessories) supplied for each installation. The complete systems shall be warranted by the manufacturer against defects in materials and workmanship for a period of five (5) years or 1,500 hours of operation; whichever occurs first from the date of system startup. This warranty coverage shall include parts, labor, and travel expenses.
- B. The warranty of the coating of the enclosure and fuel tank shall be a non-deductible, unlimited warranty against rust and corrosion of any coated part of the enclosure for a period of ten (10) years.

PART 2 PRODUCTS - AT EACH SITE:

2.01 PUMP

- A. Each pump shall be:
 1. Used for raw waste water.
 2. Able to pass a 3" spherical solid.
 3. Be compressor-assisted self priming
 4. Initially start at primary rpm/capacity, with the ability to automatically ramp up to maximum capacity to keep up with flow if needed.

- B. The complete intake and discharge piping, fittings, and layout shall be sized and designed by the pump supplier to ensure the most efficient design and operation as possible. Site constraints shall be taken into account and coordinated with County personnel.

2.02 INSTRUMENTATION AND CONTROL

- A. Each pump is to be capable of being started and shutdown through an automatic level control or manually. Level sensing shall be by two installation contractor installed systems: transducer as the primary indicator, and float balls as the secondary indicator.
- B. The controller shall start the pump automatically when the wet well reaches a predetermined high level condition and shall be adjustable by County personnel, if needed. The controller shall be able to automatically ramp up the pump speed incrementally to the maximum pump capacity if the wet well level continues to rise.
- C. The controller shall be programmable to exercise the pump automatically, and have the program adjusted by County personnel if needed.
- D. An emergency stop button will also be installed to shut the system down. This button should be red, a minimum of two inches in diameter, labeled "STOP" and installed in a conspicuous location on the pump set. It shall be reusable and resettable.
- E. The control shall shut down and lock out upon: failing to start (overcrank), overspeed, low engine oil pressure, high engine coolant temperature, or operation of a remote manual stop station. A panel mounted switch shall reset the engine monitor and test all the lamps. Lamp indications on the control panel shall include as a minimum:
 - 1. Overcrank Shutdown - Red
 - 2. Overspeed Shutdown - Red
 - 3. High Coolant Temperature - Red
 - 4. Low Engine Oil Pressure - Red
 - 5. High Engine Coolant Temperature Prealarm - Yellow
 - 6. Low Engine Oil Pressure Prealarm - Yellow
 - 7. Low Fuel - Yellow
 - 8. Run - Green
- F. Each pump set is to be set up by the manufacturer to indicate to a remote location through the County's RTU system:
 - 1. When pump set is in operation.
 - 2. When pump set fails (fails to start).
 - 3. When low fuel level is reached in the fuel tank.
- G. The contractor shall install four wires from the pump control panel to the existing RTU control panel; wire type shall be 16 AWG, 16 strand flexing type MTW or TFFN 600 volt. The County's RTU system uses discrete- type signals with N/O type contacts. County shall make the actual connections to the RTU system.

The wire coloring scheme shall be:

- Brown - pump run
- Red - pump fail
- Yellow- low fuel
- Orange- common to alarms and connected to control panel power either 24 volt

DC or AC

- H. All electrical penetrations in any enclosure shall be properly sealed from the weather.

2.03 ENCLOSURE

- A. The pump set and all the equipment supplied in this contract, shall be operated in a stationary outdoor environment. At each site, it shall:

1. Require weather protected enclosures. These enclosures shall protect the unit and all equipment and devices from the elements of the weather to include rain and winds.
2. The enclosure shall meet all current federal, state, and local regulations. All submittals shall have a statement clearly indicating all regulations are being met.
3. All enclosures, boxes, trays, etc shall have weep holes for condensation or water intrusion drainage. Any oil containment / catchment areas shall have provision to completely drain off water. The enclosure shall provide adequate ventilation for cooling and operation under full load conditions.
4. The enclosure shall be constructed of aluminum with a 14 gauge minimum thickness. The enclosure shall have an electrostatically applied, baked on, powder coated enamel or polyester finish a minimum of 2.5 mil thick. Provisions shall be made to ensure minimum thickness is achieved at all corners and edges. The color of the powder coating shall be similar to "Buff" or Pantone Green 5545 C, as noted on the drawings, and must be approved by Manatee County prior to installation of the product.
5. The housing shall have hinged side access doors and a rear control door that are easy to remove. The side panels shall be easy to remove to allow access to all areas of the pump. All doors shall be secured by lockable handles as provided by the manufacturer or at a minimum with padlock hasps, so the County can install a standard padlocks.
6. All exterior assembly hardware, bolts and/or screws, handles, hinges, and hasps shall be 316 stainless steel. All exterior bolts and/or screws shall be tamper-proof. All tamper-proof screws shall utilize the 6 lobe pin TX or Torx® pin-head security fasteners. A neoprene washer shall be installed between the enclosure's exterior finish and all bolts/nuts/washers.
7. The housing shall be factory assembled to the pump set skid base. The skid base or fuel tank shall be firmly fastened to a concrete foundation pad which is to be provided and installed as part of this contract. The connections shall be adequate to avoid movement from both wind and vibration loading. The skid base / framing surface protection coating shall be per the fuel tank coating requirements. All metal surfaces coming in contact with concrete or grout shall be coated with coal tar epoxy equal to Koppers 300M or a 1/32-inch neoprene gasket between the metal surface(s) and the concrete or masonry may also be used. The neoprene gasket shall be installed along the entire perimeter, not just at the fastening hardware.
8. The pump shall be removable from the base for maintenance purposes.
9. The skid is to have adequate strength and rigidity to maintain alignment of mounted components without depending on the concrete foundation. Lifting attachments shall be arranged to facilitate lifting with slings without damaging any components or coatings.

10. The base shall incorporate a battery tray with battery hold down clamps within the rails. Provisions for stub up of electrical conduits shall be within the footprint of the set. Vibration isolation shall be integral between the pump set and base.
11. The enclosure shall be a low noise or sound attenuated enclosure. The noise level at any load operating condition, in any direction from the enclosure, shall not exceed 75 dBA at a distance of five (5) meters (16.5 ft) from the enclosure, unless noted otherwise on the plans

2.04 ENGINE

- A. The engine shall be a 4-cycle, direct injection diesel with forged steel crankshaft and connecting rods suitable for continuous operation. It shall be designed for stationary applications and shall be complete with all necessary auxiliaries needed for operation of the pump. The engine block shall be cast iron construction.
- B. The engine shall have an electronic governor which shall provide isochronous frequency regulation.
- C. The engine shall have an electric starter and battery(ies). See the Starting System section for further details.
- D. The engine shall have a mechanical, positive displacement, engine driven, lubrication oil pump. Provide full flow lubrication oil filters with replacement spin-on canister elements. Provide a dipstick for oil level indication and an easily accessible fill location.
- E. Supply a replaceable dry element air cleaner with restriction indicator.
- F. Provide an engine mounted thermostatically controlled water jacket heater. The heater(s) wattage size shall be determined by the manufacturer. The heater voltage shall be single phase, 120V, 60HZ.

2.04.1 STARTING SYSTEM - ENGINE

- A. The battery(ies) used for cranking the engine shall be the lead acid type, 12 or 24 volt, sized as recommended by the generator manufacturer. The battery(ies) shall have sufficient capacity to crank the engine for at least three cycles of 15 seconds on - 15 seconds off, for a total of 75 seconds. They shall be provided as new with the entire manufacturer's warranty.
- B. The battery(ies) shall be fastened securely in its(their) own tray within the foot print of the skid. The tray shall be acid resistant.
- C. Include all interconnecting conductors and connection accessories.
- D. A battery charger of appropriate rating which is voltage regulated, shall be provided for the engine. It shall be sized for the proper current, input AC voltage and output DC voltage. The charger shall be equipped with float, taper and equalize charge settings.
- E. A meter on the charger shall provide a visual output reading of the charger.
- F. On the engine, provide a factory mounted alternator with solid state voltage regulation and 35 Amp minimum continuous rating.

2.04.2 FUEL SUPPLY SYSTEM- DIESEL ENGINE

- A. Provide a double walled fuel tank, made of heavy gauge construction that is designed for full weather exposure. The tank shall be a sub-base type. There is to be visual tank to foundation clearance. The tank is to have the following features:
1. Tank shall be UL 142 listed.
 2. The capacity of the fuel tank shall be sufficient to run the generator continuously for 24 hours, but not to exceed a maximum of 540 gallons.
 3. Equipped with a mechanical fuel gage and low fuel level alarm that may be monitored from a remote location by a RTU which uses N/O type contacts.
 4. Two inch NPT fuel opening with spill protection and a lockable lid that is easily accessible.
 5. Emergency pressure relief vent opening on the inner and outer tanks.
 6. Inner tank leak alarm kit and low fuel alarm that may be monitored in some remote location by an RTU.
 7. Basin drain.
 8. Overfill protection / containment.
 9. Provide an integral fuel pump of sufficient capacity to sufficiently charge the fuel lines under any start or run condition.
- B. The overall fuel system is to comply with all applicable NFPA regulations as well as those required by the Florida Department of Environmental Regulation. This includes NFPA compliant labels for the fuel shut-off location and application of Diesel HAZMAT symbol stickers.
- C. Provide an anti-siphon valve in the fuel line at the output of the tank.
- D. A fuel filter shall be installed between the fuel tank and fuel inlet to the engine. It shall have a fuel water separator. The filter element shall be disposable and be easily removed and installed for maintenance purposes.
- E. Provide supply and return fuel lines of sufficient diameter for all load requirements, flexibility for maximum resistance to fatigue due to component operation and made of material which has maximum resistance to corrosion due to environment and fuel supply.
- F. The skid base for the fuel tank shall be firmly fastened to a concrete foundation which is to be provided and installed as part of this contract. The fuel tank & skid assembly shall be removable from the base. Lifting points shall be provided for the tank skid. All metal surfaces coming in contact with concrete or grout shall be coated with coal tar epoxy equal to Koppers 300M or provide a 1/32-inch neoprene gasket between the metal surface(s) and the concrete or masonry may also be used. The neoprene gasket shall be installed along the entire perimeter, not just at the fastening hardware.
- G. The exterior coating of the fuel tank and skid base shall be Sherwin Williams SherGlass FF glass flake reinforced amine epoxy (formulated for immersion service) or equal. Color shall be haze grey, two coats of 12-15 mils on top of a stripe coat over all welds, crevices, edges and sharp angles, per manufacturer's recommendations.
- H. The fuel tank shall be full and topped off by the contractor when it is accepted by the County.

2.04.3 COOLING SYSTEM- ENGINE

- A. The engine shall be cooled by a unit mounted closed loop radiator system rated for full load operation in 50° C ambient condition with the ambient temperature as measured at the air inlet to the radiator. Radiator shall be provided with a duct adapter flange. The cooling system shall use a 50/50 (Prestone, Xerex or equivalent coolant and water) mixture provided by the supplier.
- B. Provide drain cocks or plugs in the engine block and radiator for easy changing and flushing of the coolant. Provide coolant drain extensions where necessary for easy access to the drainage device.
- C. Protection from rotating parts (fan, fan belt) shall be provided.
- D. Install a self contained thermostat module to automatically regulate coolant flow to maintain optimum constant coolant temperature as recommended by the engine manufacturer.
- E. Provide a coolant heater which is thermostatically controlled in the jacket of the engine.

2.04.4 EXHAUST SYSTEM- ENGINE

- A. The muffler for the engine shall be the critical grade made from aluminized steel of thickness and design as recommended by the manufacturer. The muffler shall be housed within the generator enclosure.
- B. All exhaust piping shall be aluminized steel. Vertical discharge exhaust shall be equipped with a rain cap, appropriate condensation drains in the piping, and the outlet, and shall be designed so no external rain or moisture may enter the engine from the outside even if the rain cap fails.
- C. Rain Skirt - At the point where the exhaust pipe tubing penetrates the roof or side of the enclosure, a suitable "rain skirt" and collar shall be provided by the MANUFACTURER. It shall be designed to prevent the entrance of rain and allow for expansion and vibration of the exhaust piping without chafing or stress to the exhaust system. This detail must appear on the drawings submitted for approval. Care must be exercised so there is no recirculation of exhaust gases into the intake system.
- D. The connection of the engine to the exhaust system shall be a flexible section of corrugated stainless steel pipe. The connection of the exhaust pipe to the muffler shall be a stainless steel expansion joint with liners.
- E. The exhaust emissions shall fall within the guidelines of the EPA and other state and governmental agencies.

2.07 HOUSEKEEPING SLAB FOUNDATION

- A. The reinforced concrete slab(s) for the pump and fuel tank are to be suitable to fully support the complete load under all load conditions with a reasonable safety factor. The top of the slab shall be a minimum of two inches above the surrounding grade and extend a minimum of six inches past the footprint of the pump set.
- B. The Manatee County Building Department will require the contractor to submit a plan for each poured-in-place concrete slab being installed. The Building Department will accept a slab designed by the manufacturer for their respective generator, provided the back-up

information accompanies each plan. If the manufacturer does not provide a slab design, then the contractor shall submit a slab design that is signed and sealed by a Professional Engineer and meets the Florida Building Code.

PART 3 EXECUTION - AT EACH SITE:

3.01 INSTALLATION

- A. The contractor shall have all the devices described in this contract delivered to, and unloaded at the site. The contractor shall furnish and install the entire product to include all necessary site preparation, the concrete foundation(s), electrical wiring and conduits, all connections, and all associated devices so that the pump set is fully functional and operable as intended. The installation shall be per the manufacturer's instructions provided in item 1.06. The contractor shall complete the installation of the equipment he provides to the existing site equipment to the degree that it shall not be necessary for the County to make further modifications or connections in order to have a fully functional, overall system which is comprised of the existing system and that provided by the contractor under this bid. The County shall not be responsible for any costs associated with the complete installation of the product described in these specifications because all associated costs shall be included in the bid price.
- B. The County shall provide an existing site plan illustrating a proposed location for the pump set, fuel tank, piping. The Contractor and County personnel shall meet on each site and determine the exact location for the pump set, fuel tank, piping, electrical conduit, etc. to establish an approved site plan that shall be followed for installation. The Contractor shall install the pump set and other items as shown on the approved site plan.
- C. All wiring shall be installed in Schedule 80 PVC conduit sized according to the National Electrical Code for the number and size of conductors contained within. All trenches for underground installation of conduit shall be hand dug. Any electrical wiring that is installed between the lift station's wet well and the valve vault shall be installed in a carrier pipe that is strapped to the wet well or valve vault.
- D. Install the electrical components per Manatee County Standards (see typical wiring layouts in the latest Manatee County Public Works Utility Standards).

3.02 FIELD QUALITY CONTROL

- A. Upon completion of item 3.01, a factory authorized service representative of the product supplied, is to inspect all field assembled and installed components and make any necessary corrections to insure proper equipment operation. Any cost associated with this procedure shall be borne by the contractor.

3.03 TESTING

- A. All test instruments used to perform the testing are to have been calibrated within the past 12 months. The calibration shall be performed in accordance with the standards of the National Institute for Standards and Technology.
- B. Perform the following on-site tests:
 - 1. All necessary tests recommended by the manufacturer
 - 2. Noise level test: Measure and calculate the A-weighted (DbA) levels emanating from

the product assembly at five (5) meters for at least six equally spaced points around the enclosure while the machine is under load. Include such points as the exhaust discharge, and cooling air intake and discharge. The noise level test is to be taken as defined by ISO 3744.

- C. Compare all measured quantities with required values of testing. Correct all deficiencies identified by tests and repeat test and correction procedure until specified test requirements are met. All problems and shortcomings in the product provided, which are discovered during the testing process, shall be remedied and corrected at the expense of the supplier with no cost to the County.
- D. The County shall have the option of whether or not to witness all testing that is performed. Report all test results in writing to the County.

3.04 TRAINING AND DEMONSTRATION

- A. A factory representative of the product is to provide the County's maintenance personnel with a thorough period of instruction and hands-on session regarding the operation, trouble shooting and maintenance of all components of the product. Typical training period: one hour for each site.

3.05 DELIVERY

- A. The product described in these specifications shall be fully installed and fully operational, tested and demonstrated within the agreed upon number of days after the award of the bid has been made.

3.06 NOTICE OF DELIVERY, TESTING, TRAINING AND DEMONSTRATION

- A. At least seven business days of notice is to be given by the contractor to the County for delivery, installation, testing, training and demonstration of the product.

END OF SECTION

SECTION 11225 STATIC MIXERS

PART 1 GENERAL

1.01 SCOPE OF WORK

- A. Design, fabricate, and furnish, ready for installation by County's personnel, static mixing devices of the type, size, and capacity hereinafter specified and/or shown/described on the Contract Drawings.
- B. The mixing devices shall be furnished complete with all mounting hardware, auxiliary equipment, ancillary devices, installation instructions, and factory authorized supervisory personnel to allow County's personnel to satisfactorily complete the installation within the time constraints hereinafter specified. Any specialized tools, devices, or equipment required to install the mixing devices shall be furnished as a part hereof.

1.02 LOCATION

- A. The mixing devices shall be installed in, and supported from the walls of the blending chamber at the Manatee County Water Treatment Plant.

1.03 DESIGN CONSTRAINTS

- A. Time
 - 1. Since there is a maximum time frame of ten (10) hours during which the blending chamber can be taken out of service, and since some time must be allowed for unforeseen contingencies, the design of the mixing devices shall be such that they can be installed by the County's personnel under the supervision of the Manufacturer's authorized representative in one (1) continuous eight (8) hour period. Multiple periods of shutdown for mixing device installation will not be acceptable under these Specifications.
- B. Size
 - 1. The design of the mixing devices shall be such that all individual pieces or components, including the largest, must fit through a rectangular opening, measuring 29-inches by 90-inches.
 - 2. The mixing devices shall be designed to fit into a channel of the blending chamber. The channel dimensions are 132-inches in width by 125-inches in height by 102-inches in length.
- C. Material
 - 1. Because of the corrosive nature of the chemicals being added to the water, the mixing devices, the device fasteners and mounting hardware, and ancillary devices shall be fabricated from 316L stainless steel.

1.04 ANCILLARY DEVICES

- A. Sparger
 - 1. As part of the mixer installation, the Manufacturer shall design, fabricate, and furnish a

- sparger for adding chlorine to the water upstream of the mixers.
2. The sparger shall be fabricated from 4-inch diameter, Scheduled 40, 316L stainless steel pipe.

1.05 FLOW RANGE

- A. The mixing devices shall be designed to provide complete mixing of the chlorine between the flow range of 30 - 96 MGD.

1.06 MIXING EFFICIENCY

- A. The effectiveness of mixing shall be measured as follows:
 1. A minimum of six (6) blend chamber effluent samples designated field series) shall be collected over a one (1) hour period. The number of one (1) hour sampling periods during the twenty-four (24) hour acceptance test shall be determined by the County.
 2. Each sample shall be split and the split samples designated laboratory duplicates.
 3. All samples shall be analyzed for total phosphate, uncombined ammonia, and total combined chlorine.
 4. The mixing shall be considered effective if the standard deviation of the field series for each parameter is comparable to the mean standard deviation of the standard deviations calculated for the laboratory duplicate samples.

1.07 FACTORY REPRESENTATIVE

- A. An authorized factory representative of the Manufacturer of the mixing devices shall be on site during installation to supervise the County's personnel in the proper installation of the mixing devices and the sparger.
- B. After the mixing devices and the sparger are properly installed, the factory representative shall instruct the County's personnel in the proper care, adjustment, and disassembly of the devices.

1.08 SUBMITTALS

- A. The requirements of Section 01340 shall be met - i.e., the Manufacturer shall submit to the County for review and approval shop drawings, working drawings, and product data including all dimensions, details of fabrication, and materials used. All dimensions shall be based on field measurements made by the Manufacturer.
- B. The submittals shall include installation drawings which show all pertinent assembly details as well as certified calculations showing that the mixing devices meet the flow range and mixing accuracy as required by Items 1.05 and 1.06 above, respectively.

1.09 FACTORY TESTING

- A. After fabrication and prior to packaging and shipping, the mixers and the sparger shall be factory tested to ensure that they perform to the design specifications.
- B. Four (4) copies of the certified factory test results shall be shipped with the static mixers and the sparger.

1.10 SHIPPING AND HANDLING

- A. The Manufacturer shall so package the units for shipping that they are maximally protected from both physical and environmental damage.
- B. The Manufacturer shall ship the units to the Water Treatment Plant using his normal means of transportation.
- C. The County shall store the units according to the Manufacturer's recommendations until the units are needed for assembly/installation.

1.11 GUARANTEES AND WARRANTIES

- A. The Manufacturer shall guarantee and/or warrant, in writing, the mixing devices and the sparger against defects in materials, fabrication and workmanship as provided for in Section 01740 of these Specifications or for three (3) years from the date of final acceptance, whichever period is longer.

PART 2 PRODUCTS

2.01 TYPE

- A. The mixing devices shall be the static mixer type - i.e., they shall be rigidly mounted, shall contain no moving parts, and shall require no outside power source other than water flow to accomplish the required mixing action.
- B. The static mixers shall be a non-clogging design and shall be such that no surface edge or pinch-point shall be perpendicular to the direction of flow.

2.02 CONSTRUCTION

- A. The static mixing system shall consist of a series of identical individual mixers combined with a chlorine sparger installed upstream of the first mixer. The Manufacturer shall be responsible for determining the minimum number of mixers required to achieve the required degree of mixing.
- B. Each mixer shall be a multi-blade design utilizing geometrically offset tapering blades to achieve the required degree of mixing. The Manufacturer shall be responsible for determining both the number of blades required and the actual blade geometry.
- C. The mixers and the sparger shall be fabricated from the materials specified in Items 1.03.C and 1.04.B above, respectively.

2.03 MANUFACTURER

- A. The static mixers shall be the Type SMF as manufactured by the Koch Engineering Company of Fairfield, NJ, or approved equal product.

PART 3 EXECUTION

3.01 INSTALLATION

- A. The static mixers and the sparger shall be installed in the locations shown on the Contract Drawings. The installations shall be in strict accordance with the written instructions supplied by the Manufacturer.

3.02 LABOR AND SUPERVISION

- A. The installations shall be performed by the County's personnel under the supervision of the Manufacturer's authorized representative.

3.03 ALIGNMENT

- A. All vertical surfaces and lines shall be installed plumb.
- B. All horizontal surfaces and lines shall be installed level.

3.04 CLEAN UP

- A. After the mixing system has been installed and prior to filling the blending chamber, the work area shall be thoroughly cleaned and all foreign items (scrap, slag, etc.) removed by the County's personnel.

3.05 ACCEPTANCE TESTING

- A. After the clean-up has been accomplished, the Manufacturer's authorized representative shall inspect both the static mixer and the sparger for proper installation. Additionally, to the extent possible, he shall check the sparger for proper operation.
- B. After both a satisfactory inspection and satisfactory sparger operation have been obtained, the blending chamber shall be refilled and a fully operational twenty-four (24) hour acceptance test shall be performed as specified above in Item 1.06, Mixing Efficiency.

3.06 GUARANTEES AND WARRANTIES

- A. The manufacturer shall guarantee and/or warrant, in writing, the static mixing system as required by Item 1.11 above and Section 01740 of these Specifications.

END OF SECTION

DIVISION 13 SPECIAL CONSTRUCTION

SECTION 13350 LIFT STATION REHABILITATION

PART 1 GENERAL

The Contractor shall furnish all labor, materials, equipment and incidentals required to remove / replace and install the internal equipment for a complete automatic, underground lift station and adjacent above-ground valve assembly and/or meter vault. The principal items of equipment shall include two submersible motor-driven sewage pumps (supplied and installed by Manatee County), valves, internal piping, pressure gauge, and meters (if required). All materials shall be new, without defects and of the best quality. All materials furnished and all work done shall be in strict accordance with all local requirements and codes.

1.01 EQUIPMENT

- A. Meter Vault (if required): Precast concrete vault shall be constructed as shown on the drawings and in accordance with section 03410. The vault(s) shall have a three (3) inch PVC drain with a P-trap return to the wetwell. The vault shall be adequate size to allow a minimum 12" clearance between all flange fittings and any concrete surfaces.
- B. Entrance Hatches: The lift station wetwell and vault(s) shall be equipped with an aluminum access cover sized as below or as shown on the drawings. The wetwell access cover and vault access cover shall be constructed of aluminum with a minimum load rating of 300 lbs./sq. ft. and equipped with stainless steel hinges, hasp, and a device to lock the doors in an open position when the lid is raised (US Foundry, Halliday, or approved equal). Entrance hatches for duplex stations with 4" BPIU Base Ells shall be minimum 36" x 48" and with 6" BPIU Base Ells shall be minimum 42" x 60".
- C. Sewage Pumps and Electrical by the County, unless noted otherwise on the plans.
- D. Piping and Fittings

Lift Station wetwell shall be as called out on the plans. All flanged fittings in the wetwell and vault shall be connected using 316 stainless steel hardware (nuts, bolts and washers). All mechanical joint fittings shall use grip rings restraint systems with Corten or 316 S.S. bolts. Riser pipes shall be HDPE: DR11 with shop fused butt joints and flanges. Piping in the valve vault shall be PVC: C900, class 235, DR-18.

- E. Pump Hardware
 - 1. Lifting chains shall be 3/8" stainless steel type 316 attached to the pump lifting bail using stainless steel shackles. All pump mounting systems shall be of the front loading slide rail type BPIU, from Barney's Pump). All rails and mounting hardware shall be 316 stainless steel.
 - 2. A hanger shall be installed in each wetwell for supporting floatball and pump cables. The hanger shall be constructed of 1/4" x 2" type 316 stainless steel flat stock with individual hooks for each floatball and pump cable constructed of 1/4" type 316 stainless steel rod stock. All nuts, bolts, washer, fasteners, brackets, and other

- hardware installed in the wetwell and vault shall be type 316 stainless steel.
3. Pump base plate for HDPE piping installations shall be as detailed in the Manatee County Utility Standards, latest edition, or as shown on the plans.

F. Painting

All paint and other coatings shall be applied in accordance with the project manufacturer's specifications for the surfaces being coated. The exterior of the vaults and wetwell top below grade shall be coated with at least two (2) coats of a coal tar epoxy coating containing 78% volume of solids. The minimum thickness of each coat when dry shall be 8 mils. The interior surfaces of the vault shall be coated with two coats of Tnemec Series 69 Hi-Build epoxy coating or equal. The exterior surfaces of the vault and wetwell top exposed above grade shall be coated with at least two (2) coats of H & C Silicone acrylic concrete stain, Patio Green, Manufactured by FLR Paints, Inc. The interior and exterior of all ductile iron fittings and valves shall be per sections 02615 or 02640 of these specifications.

- G. Gate Valves: All gate valves shall be resilient seated non rising stem. All valves inside the vault shall be equipped with handwheel.

- H. Link Seals: All piping penetrations of the wetwell and vault shall be through a grouted-in PVC sleeve that is bonded to the liner, sealed to the pipe using Link Seal Model S seals or approved equal. All hardware shall be 316 stainless steel. Install with bolts facing the inside of the wet well.

2.01 ELECTRICAL

- A. Contractor or subcontractor shall be responsible for any permits, fees, inspections, materials, equipment and labor required for any electrical modifications as indicated on the contract documents.

3.01 PERMITS

The Contractor shall be responsible for and shall pay for any permits and/or inspections required.

4.01 SHOP DRAWINGS AND INSPECTIONS

Shop drawings shall be submitted for approval in accordance with these Specifications prior to construction. When calling for inspection, the contractor should have these approved drawings available for review by the inspectors prior to acceptance by the County for maintenance. All inspections shall be arranged by contacting the Project Manager.

5.01 LANDSCAPING

The Contractor shall grade and fill the construction area to its original lines and grades and sod all disturbed or damaged grassed areas. Unless noted otherwise on the plans, the County shall restore the landscaping and shrubs around the lift station.

6.01 LINER REPAIRS

The contractor shall repair all existing liners in accordance with the manufacturer's recommendations. All HDPE and PVC liner repairs shall be performed by a contractor certified by the liner manufacturer to install and repair the liner.

END OF SECTION

SECTION 13350A WET WELL CLEANING

PART 1 GENERAL

1.01 SCOPE

A. Description

The Contractor shall provide the necessary labor and equipment for the removal of waste generated from Sanitary Sewage Lift Station Wet Wells. Cleaning of the sewer wet wells will be conducted at the direction of the County.

B. Work Included

The successful bidder will provide services for the “total elimination” of the waste within the wet well. Cleaning shall include stopping the flow into the station, the physical removal of all floating material, grease/oil, organic compounds, bottom sediment, grit, and materials that have collected on the walls, floor, and all other extraneous materials within said wet wells, are cleaned from the lift station structure and all items within. Vacuum Trucks with the ability to remove the sludge, dirt, grease, etc. from the interior walls and bottom of the wet well.

1.02 EQUIPMENT

- A. All cleaning machines must be capable of efficient, reliable operation. A high-pressure water washing or wet abrasive sand blasting, use 3500-psi water pressure, minimum. Remove dirt, oil, loose concrete, any previously applied coatings (except liners) or other deleterious materials.

1.03 CLEANING

- A. Continue the cleaning procedures using pressure washing and/or mechanical methods until a uniform and sound profile is obtained. All contractors shall be expected to have and make available extension equipment on an as needed basis in order to properly clean deeper basins. Actual operation of equipment may need to be witnessed/verified by the inspector upon and prior to awarding a purchase order for this requirement.
- B. The Removal and Disposal of all material from the Wet Wells is the responsibility of the Contractor. The cost for this shall be included in the bid price. No dumping or stock piling of these materials will be allowed at any of the lift stations.
- C. The Contractor is fully responsible for compliance with all Federal, State, and local laws, including but not limited to the OSHA Confined Space Entry regulations.
- D. Existing liner, control floats and/or pressure transmitters located in each wet well must be protected from damage by the Contractor during his/her operations. Any damage done to the liner, floats and/or pressure transmitters must be immediately

repaired by the Contractor at his/her expense.

- E. Some of the wet wells are configured to allow for direct vertical access; some will require flexible suction lines and/or bends. The Contractor must remove and replace grating in the wet wells to allow for complete and total access to all areas of the wet wells for the removal of grease, grit, and other material. No additional compensation will be allowed for special piping, rigging, etc. required to complete the work.
- F. See plans for the approximate dimensions of each wet well.
- G. Each lift pump station is considered to be a locked, secure facility. Access will need to be arranged through the Wastewater Superintendent accordingly.
- H. The Contractor, at his/her sole risk, may store his/her equipment at the lift stations during the project. Insurance for said equipment will be the responsibility of the contractor/equipment owner.

PART 2 PRODUCTS (NOT USED)

PART 3 EXECUTION (NOT USED)

END OF SECTION

DIVISION 14 CONVEYING SYSTEMS

SECTION 14600 HOISTS AND CRANES

PART 1 GENERAL

1.10 SCOPE OF WORK

Furnish all labor, materials, equipment, electrical, painting, and all incidentals necessary to construct the underhung motorized crane bridge and hoist system complete and operational.

1.02 QUALIFICATIONS

Hoist and crane bridge shall be of approved standard design where possible and shall be adequate to maintain the supported load in proper position under all operating conditions.

1.03 SUBMITTALS

- A. Submit to the County for approval, as provided in the Contract Documents, shop drawings of all items to be furnished under this Section.
- B. Submit to the County, for approval, samples of all materials specified herein.

PART 2 PRODUCTS

2.01 GENERAL

- A. Hoist described herein shall be not less than 2-1/2 and not more than 3 ton capacity, dual speed with geared trolley and a minimum lifting distance of 25 feet.
- B. The hoist shall meet the requirements of ANSI B30.16 "Overhead Hoists".
- C. The hoist shall be a heavy duty hoist meeting H4 Service classification as defined in ANSI/ASME HST-1M "Performance Standard for Electric Chain Hoists". Two speed models shall be rated H4 heavy duty for fast speed and H3 standard duty for slow speed. Maximum lifting speeds shall be 17/6 FPM.
- D. The underhung motorized crane bridge and electric hoist shall be as manufactured by Lift Tech International, Inc., Harrington Hoists, Inc., Budgit, or equal. Any reference to a specific catalog number of a specific manufacturer is for the purpose of establishing a type and quality of product and shall not be considered as proprietary. Any item comparable in type, style, quality, design and performance will be considered for approval.

2.02 HOISTS

- A. **FRAME** - shall be of lightweight heat treated aluminum and precision machined for accurate gear and bearing alignment.
- B. **BEARINGS** - shall be high quality anti-friction type of either needle or ball design and used throughout the hoist.
- C. **BRAKES** - Hoist shall have two (2) types of brakes: One DC electrical motor brake spring

set electrically released and one self-adjusting Weston type mechanical load brake located in the gear case. Either brake shall have the capability of holding rated load in event of failure of either brake system.

- D. **OVERLOAD DEVICE** - shall be provided to prevent lifting excessive overloads. This load limiting (clutch) device shall be preset at factory to disengage the hoist motor from the gearing in event of excessive overload condition. Overload device is to be located between the motor and load brake, so that the load brake will hold the load in event of overload device failure.
- E. **MOTORS** - shall be of high starting torque type designed specifically for hoist service with permanently lubricated ball bearings, rated for the service required. The motor enclosure is to be totally enclosed non-ventilated TENV. Motor is to have automatic reset temperature actuated switch (TAS) in motor windings to provide motor running over current protection. Lifting motor shall be 460 volt, 3-phase, 60 Hz.
- F. **GEARING** - shall be a combination of helical and spur, precision cut and heat treated to ensure quiet, efficient operation. Gears shall be totally enclosed and run in a bath of oil to provide maximum lubrication and avoid environmental contamination.
- G. **LOAD CHAIN** - Link load chain shall be accurately formed closely calibrated pocket wheel chain of high strength low alloy steel, case hardened for long wear heavy duty service. Load chain shall be zinc plated.
- H. **LIMIT SWITCHES** - automatic upper and lower limit switches shall prevent raising or lowering the load beyond a preset upper or lower limit will be furnished. The upper limit switch shall be block operated.
- I. **SUSPENSION AND LOAD HOOKS** - shall be of high strength forged steel and be capable of full 360 degree rotation. Load hook shall have bearing supported rotation. Each hook shall have spring loaded hook latches to prevent accidental slippage from mounting or lift points.
- J. **CONTROLS** - shall be centralized electrical system, easily accessible in one compartment. Control circuit voltage to the pushbutton station shall not exceed 120 volts.
- K. **PUSHBUTTON STATION** - shall be of molded contour grip type and supported from hoist by strain relief cable to avoid damage from pull on control wires. Dependent on accessories, pushbutton station furnished will accommodate all motions. The enclosure is to be NEMA 4X watertight.
- L. **TROLLEY** - The wheels shall be steel with contour treads and shall operate on either flat or tapered beam flanges. Movement of hand geared trolley shall be accomplished by pulling on an endless hand chain. Trolley wheel gears and pinions shall have machine cut gear teeth. Spacer washers shall be provided for trolley adjustment to various sizes.

2.03 UNDERHUNG MOTORIZED CRANE BRIDGE

- A. **MOTOR** - Shall be a 460 volt, 3-phase, single speed, 1/3 H.P.(minimum) squirrel cage motor. It shall be C-face mounted to the reducer. Maximum bridge speed shall be 55 FPM.
- B. **END TRUCKS** - Shall be rigid steel welded, reinforced at the wheel axles and girder connection. The wheels shall be solid forged steel and rotate on two sealed

lifetime-lubricated ball bearings. The single flange wheels shall have compound tread for operation on American standard taper tread or flat flange beams. The spur reduction at the truck shall be a steel pinion meshing with the integral gear teeth on the driver wheels. Maximum wheel load to be determined in accordance with CMAA Specification No. 74.

- C. **CROSS SHAFT SUPPORT (IF RECOMMENDED BY MANUFACTURER)** - Shall have antifriction lifetime-lubricated bearings.
- D. **GEAR REDUCER** - Shall be right-angle, shaft mounted and include all hardware for mounting at either end of the bridge.
- E. **CONTROL PANEL** - Shall be 460 volt, 3-phase, 60 Hz. It shall include mainline contactor, 115 volt control circuit transformer with fused secondary terminal strip, bridge fusing and reversing contactor, in a NEMA 1 enclosure, and all brackets, hardware, etc. required for attachment to end truck. A fused disconnect switch with positive power disconnect and crane fusing shall be mounted near the crane control enclosure.
- F. **ELECTRIFICATION** - Electrical power supply, materials, accessories, etc. to the crane and hoist shall be as recommended by the manufacturer.

PART 3 EXECUTION

3.01 INSTALLATION

- A. Hoist and underhung motorized crane bridge shall be installed as per manufacturer's recommendations.
- B. Contractor shall be acquainted with product and recognized by manufacturer as qualified to install the product.
- C. Contractor shall adequately store material prior to installation in a weatherproof area.
- D. The manufacturer of the crane and hoist shall make a representative available for a day of conducting on-site instructions to County personnel on the operation and maintenance of the overhead crane system. This service shall be included in the lump sum bid price. No additional expense shall be made to the County.
- E. Contractor shall prepare, prime and paint the entire system per section 09900.

END OF SECTION

DIVISION 15 MECHANICAL

SECTION 15094 PIPE HANGERS AND SUPPORTS

PART 1 GENERAL

1.01 SCOPE OF WORK

Furnish all labor, materials, equipment and incidentals and install pipe hangers, supports, concrete inserts and anchor bolts including all metallic hanging and supporting devices for supporting exposed piping.

1.02 QUALIFICATIONS

- A. Hangers and supports shall be of approved standard design where possible and shall be adequate to maintain the supported load in proper position under all operating conditions. The minimum working factor of safety for pipe supports shall be five (5) times the ultimate tensile strength of the material.

Note: Lift Stations have their own pipe support hanger and support design and detail, shown in the Utility Standards if not shown on the plans.

- B. All pipe and appurtenances connected to equipment shall be supported in such a manner as to prevent any strain being imposed on the equipment. When manufacturers have indicated requirements that piping loads shall not be transmitted to their equipment, the Contractor shall submit a certification stating that such requirements have been complied with.

1.03 SUBMITTALS

- A. Submit to the County for approval, as provided in the Contract Documents, shop drawings of all items to be furnished under this Section.
- B. Submit to the County, for approval, samples of all materials specified herein.
- C. All pipe hangers, supports, hanger rods, clamps, concrete inserts and wall brackets, etc., whether specified or not, shall be submitted (together with load calculations) to the County for approval, if requested.

PART 2 PRODUCTS

2.01 GENERAL

- A. All pipe and tubing shall be supported as required to prevent significant stresses in the pipe or tubing material, valves, and fittings and to support and secure the pipe in the intended position and alignment. All supports shall be designed to adequately secure the pipe against excessive dislocation due to thermal expansion and contraction, internal flow forces, and all probable external forces such as equipment, pipe, and personnel contact. All pipe supports shall be approved prior to installation.
- B. All materials used in manufacturing hangers and supports shall be capable of meeting the respective ASTM Standard Specifications with regard to tests and physical and chemical properties, and be in accordance with MSS SP-58.

- C. Hangers and supports shall be spaced in accordance with ANSI B31.1.0 except that the maximum unsupported span shall not exceed 10 feet unless otherwise specified herein.
- D. Unless otherwise specified herein, pipe hangers and supports shall be as manufactured by Grinnell Co., Inc., Carpenter and Patterson, Inc., or equal. Any reference to a specific figure number of a specific manufacturer is for the purpose of establishing a type and quality of product and shall not be considered as proprietary. Any item comparable in type, style, quality, design and performance will be considered for approval.

2.02 PIPE HANGERS AND SUPPORTS FOR METAL PIPE

- A. Suspended single pipes shall be supported by hangers suspended by steel rods from galvanized concrete inserts, beam clamps, or ceiling mounting bolts.

The following sizes are minimum requirements and are subject to the County's approval:

- 1. Hanger rods shall be rolled steel machine threaded with load ratings conforming to ASTM Specifications and the strength of the rod shall be based on root diameter. Hanger rods shall have the following minimum diameters:

| <u>Pipe Size, Inches</u> | <u>Min. Rod Diameter, In.</u> |
|--------------------------|-------------------------------------|
| Less than 2-1/2 | 3/8 |
| 2-1/2 through 4 | 1/2 |
| 4 | 5/8 |
| 6 | 3/4 |
| 8-12 | 7/8 |
| 14-18 | 1 |
| 20-30 | 1-1/4 |
| Above 30 | See SPECIAL SUPPORTS Paragraph 2.04 |

- 2. Where applicable, structural attachments shall be beam clamps. Beam clamps, for rod sizes 1/2-inch through 3/4-inch shall be equal to Grinnell Fig. No. 229, and for rod sizes 7/8-inch through 1-1/4 inches shall be equal to Grinnel Fig. No. 228, or equal.
- 3. Concrete inserts for pipe hangers shall be continuous metal inserts designed to be used in ceilings, walls or floors, spot insets for individual pipe hangers, or ceiling mounting bolts for individual pipe hangers and shall be as manufactured by Unistrut Corp., Wayne, Michigan; Carpenter and Patterson, Inc., Laconia, New Hampshire; Richmond or equal and shall be as follows:
 - a. Continuous concrete inserts shall be used where applicable and/or as shown on the Drawings and shall be used for hanger rod sizes up to and including 3/4-inch diameter. Inserts to be used where supports are parallel to the main slab reinforcement shall be Series P3200 by Unistrut Corp., Fig. 1480 Type 2 by Carpenter and Patterson, Inc. or equal. Inserts to be used where supports are perpendicular to the main slab reinforcement shall be Series P3300 by Unistrut Corp., Fig. 1480 Type I by Carpenter and Patterson, Inc., or equal.
 - b. Spot concrete inserts shall be used where applicable and shall be used for hanger sizes up to and including 7/8-inch diameter. Inserts shall be Fig. 650 by Carpenter and Patterson, Inc. for hanger rod sizes 1/2-inch through and including 3/4-inch and Fig. 266 by Carpenter and Patterson, Inc., for 7/8-inch hanger rods.

- c. Ceiling mounting bolts shall be used where applicable and be for hanger rod sizes 1-inch through and including 1-1/4 inches shall be Fig. 104M as manufactured by Carpenter and Patterson, Inc. or equal.
 - d. All pipe hangers shall be capable of vertical adjustment under load and after erection. Turnbuckles, as required and where applied, shall be equal to Grinnell Fig. No. 230.
4. Wall or column supported pipes shall be supported by welded steel brackets equal to Grinnell Fig. 194, 195 and 199 as required, for pipe sizes up to and including 20-inch diameter. Additional wall bearing plates shall be provided where required.
- a. Where the pipe is located above the bracket, the pipe shall be supported by an anchor chair and U-bolt assembly supported by the bracket for pipes 4-inches and larger or by a U-bolt for pipes smaller than 4-inches. Anchor chairs shall be equal to Carpenter & Patterson Fig. 127. U-bolts shall be equal to Grinnell Fig. 120 and 137.
 - b. Where the pipe is located below the bracket, the pipes shall be supported by pipe hangers suspended by steel rods from the bracket. Hangers and steel rods shall be as specified above.
 - c. Wall or column supported pipes 2-inches and smaller may be supported by hangers equal to Carpenter and Patterson Figures 74, 179 or 237 as required.
5. Floor supported pipes 3-inches and larger in diameter shall be supported by either cast-in-place concrete supports or adjustable pipe saddle supports as directed by the County. In general, concrete supports shall be used when lateral displacement of the pipes is probable (unless lateral support is provided), and adjustable pipe saddle type supports shall be used where lateral displacement of the pipes is not probable.
- a. Each concrete support shall conform to the details shown on the Drawings. Concrete shall be poured after the pipe is in place with temporary supports. Top edges and vertical corners of each concrete support shall have 1-inch bevels. Each pipe shall be secured on each concrete support by a wrought iron or steel anchor strap anchored to the concrete with cast-in-place bolts or with expansion bolts. Where directed by the County, vertical reinforcement bars shall be grouted into drilled holes in the concrete floor to prevent overturning or lateral displacement of the concrete support. Unless otherwise approved by the County, maximum support height shall be five (5) feet.
 - b. Concrete piers used to support base elbows and tees shall be similar to that specified above.
Piers may be square or rectangular.
 - c. Each adjustable pipe saddle support shall be screwed or welded to the corresponding size 150 lb. companion flanges or slip-on welding flanges respectively. Supporting pipe shall be of Schedule 40 steel pipe construction. Each flange shall be secured to the concrete floor by a minimum of two (2) expansion bolts per flange. Adjustable saddle supports shall be equal to Grinnell Fig. No. 264. Where used under base fittings, a suitable flange shall be substituted for the saddle.
 - d. Floor supported pipes less than 3-inches shall be supported by fabricated steel supports.
6. Vertical piping shall be supported as follows:
- a. Where pipes change from horizontal to vertical, the pipes shall be supported on the horizontal runs within two feet of the change in direction by pipe supports as previously specified herein.
 - b. For vertical runs exceeding 15 feet, pipes shall be supported by approved

- pipe collars, clamps, brackets, or wall rests at all points required to insure a rigid installation.
- c. Where vertical piping passes through a steel floor sleeve, the pipe shall be supported by a friction type pipe clamp which is supported by the pipe sleeve. Pipe clamps shall be equal to Grinnell Fig. 262.
- 7. Anchor bolts shall be equal to Kwik-Bolt as manufactured by Hilti Fastening Systems, Tulsa, Oklahoma or Wej-it manufactured by Wej-it Expansion Products, Inc., Bloomfield, Colorado.
 - 8. All rods, hangers, inserts, brackets, and components shall be furnished with galvanized finish.

2.03 PIPE HANGERS AND SUPPORTS FOR PLASTIC PIPE

- A. Single plastic pipes shall be supported by pipe supports as previously specified herein.
- B. Multiple, suspended, horizontal plastic pipe runs, where possible, and rubber hose shall be supported by ladder type cable trays such as the Electray Ladder by Husky-Burndy, the Globetray by the Metal Products Division of United States Gypsum, or equal. Ladder shall be of mild steel construction. Rung spacing shall be approximately 18 inches for plastic pipe and 12 inches for rubber hose. Tray width shall be approximately 6-inch for single runs of rubber hose and 12 inches for double runs of rubber hose. Ladder type cable trays shall be furnished complete with all hanger rods, rod couplings, concrete inserts, hanger clips, etc. required for a complete support system. Individual plastic pipes shall be secured to the rungs of the cable tray by strap clamps or fasteners equal to Globe Model M-CAC, Husky-Burndy Model SCR or equal. Spacing between clamps shall not exceed 9 feet. The cable trays shall provide continuous support along the length of the pipe.
- C. Individual clamps, hangers, and supports in contact plastic pipe shall provide firm support, but not so firm as to prevent longitudinal movement due to thermal expansion and contraction.

2.04 SPECIAL SUPPORTS

- A. The pipes shall be supported by means of a supporting framework suitably anchored into the floor or curbing. The vertical piping shall be suitably secured to horizontal support members connected at each end to vertical support members and spaced as required to provide a rigid installation.
 - 1. The complete supporting system shall be as manufactured by the Unistrut Corporation, Globe-Strut as manufactured by the Metal Products Division of U.S. Gypsum, or equal.
 - 2. Vertical and horizontal supporting members shall be U-shaped channels similar to Unistrut Series P1000. Vertical piping shall be secured to the horizontal members by pipe clamps or pipe straps equal to Unistrut Series P1100M and Series P2558. All components shall be of mild steel.
 - 3. The assemblies shall be furnished complete with all nuts, bolts, and fittings required for a complete assembly.
 - 4. The design of each individual framing system shall be the responsibility of the Contractor. Shop drawings shall be submitted and shall show all details of the installation including dimensions and types of supports.
- B. Any required pipe supports for which the supports specified in the Section are not applicable, including pipe supports for above 30-inch pipe, shall be fabricated or constructed

from standard aluminum shapes in accordance with Specifications, concrete and anchor hardware similar to items previous specified herein and shall meet the minimum requirements listed below and be submitted to the approval of the County.

1. Pipe support systems shall meet all requirements of this Section and all related Sections of this Specification.
 2. Complete design details of the entire pipe support systems shall be provided by the Contractor, for approval by the County.
 3. The pipe support system shall not impose loads on the supporting structures, in excess of the loads for which the supporting structure is designed.
 4. Hanger rods for above 30-inch pipe shall be a minimum of 1-1/2 inch diameter and shall not exceed the manufacturer's standard maximum recommended safe load.
- C. Pipe supports in lift stations shall be as shown in the Utility Standards details.

PART 3 EXECUTION

3.01 INSTALLATION

- A. All pipes, horizontal and vertical, shall be rigidly supported from the building structure by approved supports. Supports shall be provided at changes in direction and elsewhere as shown in the Drawings or specified herein. No piping shall be supported from other piping or from metal stairs, ladders, and walkways, unless it is so indicated on the Drawings, or specifically directed or authorized by the County.
- B. All pipe supports shall be designed with liberal strength and stiffness to support the respective pipes under the maximum combination of peak loading conditions to include pipe weight, liquid weight, liquid movement, and pressure forces, thermal expansion and contraction, vibrations, and all probable externally applied forces. Prior to installation, all pipe supports shall be approved by the County.
- C. Pipe supports shall be provided to minimize lateral forces through valves, both sides of split type couplings, and sleeve type couplings and to minimize all pipe forces to pump housings. Pump housings shall not be utilized to support connecting pipes.
- D. Pipe supports shall be provided as follows:
1. Cast iron and ductile iron shall be supported at a maximum support spacing of 10 feet-0-inches with a minimum of one support per pipe section at the joints.
 2. Supports for multiple PVC pipes shall be continuous wherever possible. Individually supported PVC pipes shall be supported as recommended by the manufacturer except that support spacing shall not exceed five (5) feet.
 3. Support spacing for galvanized steel pipe and copper tubing shall not exceed five (5) feet.
 4. All vertical pipes shall be supported at each floor or at intervals of at least 15 feet by approved pipe collars, clamps, brackets, or wall rests and at all points necessary to insure rigid construction.
- E. Pipe supports shall not result in point loadings, but shall distribute pipe loads evenly along the pipe circumference.
- F. Effects of thermal expansion and contraction of the pipe shall be accounted for in pipe support selection and installation.

- G. Inserts for pipe hangers and supports shall be installed on forms before concrete is poured. Before setting these items, all drawings and figures shall be checked which have a direct bearing on the pipe locations. Responsibility for the proper location of pipe supports is included under this Section.
- H. Continuous metal inserts shall be embedded flush with the concrete surface.

3.02 PRIME COATING

- A. Prior to prime coating, all pipe hangers and supports shall be thoroughly clean, dry, and free from all mill-scale, rust, grease, dirt, paint, and other foreign substances to the satisfaction of the County.
- B. All submerged pipe supports shall be prime coated with TNEMEC 69-1211 Epoxy Primer or equal. All other pipe supports shall be prime coated with TNEMEC 66-1211, or equal.
- C. Finish coating shall be compatible with the prime coating used and shall be applied as specified in the Contract Documents.

END OF SECTION

SECTION 15400 PLUMBING

PART 1 GENERAL

1.01 SCOPE OF WORK

Furnish all labor, materials, equipment and incidentals necessary for complete installation of a plumbing system complete and ready for use.

1.02 GENERAL

- A. The general arrangement of the plumbing shall be as indicated on the Drawings. Detached drawings of proposed departures shall be submitted to the County for approval prior to the start of work. The Contractor shall carefully examine the Drawings and shall be responsible for the proper fittings of materials and equipment in each building. All work shall comply with local code requirements.
- B. Plumbing fixtures, devices and pipe shall be installed in such a manner to prohibit a cross connection or interconnection between a potable water supply and a polluted supply. The plumbing installation shall further prohibit the backflow of sewage, polluted water, or waste into the water supply system. Potable water hose bibs shall include vacuum breaker installation.
- C. Required materials not covered by the detailed Specifications shall meet the requirements of the local Plumbing Code, other applicable State and Local Ordinances and Codes, and shall conform to accepted plumbing practice.
- D. Drainage connections shall be trapped except as noted. The service line to each item of equipment shall be equipped with a cutoff valve and union for isolation of the item for repair and maintenance. Interference with the operation of other equipment or fixtures during repair or maintenance work is prohibited. The Contractor shall coordinate all work called for in the Contract Documents including, but not limited to furnishing the equipment with the services under this Section of the Specifications.
- E. The Drawings show a general concept of the plumbing system, but are not intended to show all of the offsets, fittings and accessories that may be required. The Contractor shall carefully investigate the structural and finish conditions affecting all his work and shall arrange such work accordingly, furnishing such fittings, traps, valves and accessories as may be required to meet such conditions, at no additional cost to the County.
- F. The work shall be carefully laid out in advance and no excessive cutting of construction will be permitted. Damage to buildings, piping, wiring, or equipment as a result of cutting for installation shall be repaired by mechanics skilled in the trade involved, at no additional cost to the County.
- G. Pipe openings shall be closed with caps or plugs during installation. Fixtures and equipment shall be tightly covered and protected against dirt, water and chemical or mechanical injury. Upon completion of all work, the fixtures, materials and equipment shall be thoroughly cleaned, adjusted and operated.

1.03 SUBMITTALS

- A. The Contractor shall submit to the County for review and approval in accordance with the Contract Documents: complete shop drawings, working drawings, and product data for all

materials and equipment furnished under this Section.

1.04 CODES, ORDINANCES AND PERMITS

- A. The Contractor shall comply with all of the laws, ordinances, and codes, rules and regulations of the local and state authorities having jurisdiction over any of the work specified herein. He shall apply and pay for all necessary permits.
- B. If any part of the Plans and Specifications conflict with the laws and codes, the Contractor shall call it to the County's attention prior to the commencement of work.

1.05 GUARANTEE

- A. The Contractor shall warrant all labor and materials free from defects for a period of one (1) year from the date of acceptance and shall, upon notification during this period, promptly repair or replace any defective items of material or equipment at no additional cost.

1.06 ACCESSIBILITY

- A. The Contractor shall inform himself fully regarding the peculiarities and limitations of the space available for the installation of all material in this Contract.
- B. The Contractor shall install the equipment, such as valves, traps, clean-outs, etc., so that it is readily accessible. He shall provide access panels where required. The foregoing shall also apply in general to any part of the system which may be necessary to be reached from time to time for maintenance and operations of the system.

PART 2 PRODUCTS

2.01 MATERIALS

- A. Unless otherwise specified, all materials shall conform to the South Florida Plumbing Code.
- B. The revision of the particular ASTM, SBC or AWWA standard in effect at the time of advertisement for bids shall be the minimum acceptable.
- C. Copper water pipe shall be Type L, hard drawn tubing and fittings shall be cast brass or wrought copper.
- D. A dielectric coupling shall be provided between ferrous and nonferrous materials.
- E. The Contractor shall furnish certified statements from the manufacturer that the material conforms to the requirements specified above.

2.02 SOIL, WASTE, DRAIN AND VENT PIPING

Underground soil, waste and drain pipe and fittings shall be coated hub-and-spigot cast iron or cast ductile iron pipe, with dual-tite or tyseal joints. Above-ground soil, waste, drain and vent piping shall be service weight, cast iron soil pipe with No-Hub fittings. Waste arms and condensate waste, from air conditioning equipment, may be DWV copper. Cast ductile iron and galvanized steel pipe rainwater drainage systems shall be provided where shown on the Drawings, and as provided under this Section.

2.03 CLEANOUT PLUGS AND TEST TEES

Cleanouts shall be the same sizes as the pipe except that cleanout plugs larger than four inches shall not be required. A cleanout installed in connection with cast iron hub-and-spigot pipe shall consist of a long-sweep 1/4 bend or one or two 1/8 bends extended to the place indicated on the drawings, or, if not indicated, to an easily accessible place. All cleanouts extended through all floors shall be provided with cast access boxes which shall be Josam Series #58730 with Nikaloy cover.

2.04 FLASHING

Vent pipes and roof drains shall be flashed and made watertight at the roof with not lighter than 4-pound sheet lead. Flashings shall be extended up the vent pipes a minimum of six inches to form counter-flashing or rain guards for pipe. Flashings in connection with cast iron pipe vents shall be turned down into the pipes or hubs. Flashing shields shall extend not less than eight inches from the vent pipes and roof drains in all directions.

2.05 TRAPS

Unless otherwise indicated, each fixture and piece of equipment requiring connections to the drainage system shall be equipped with a trap. Traps are specified to be supplied with the fixtures. Each trap shall be placed as near the fixture as possible, and no fixture shall be double-trapped. Traps installed on bell-and-spigot pipe shall be cast iron. Traps installed on threaded pipe shall be recess drainage pattern. All floor drains shall have deep seal traps and be provided with Josam #88250 trap seal primer valve, where a single is required. Where multiple primers are required, see Drawings for primers and detail or as approved, to preclude trap liquid seal evaporation.

2.06 SHOWER PAN

The floor of each individual shower shall be made watertight with a metal pan or other approved materials fabricated in place. The metal pan shall be constructed from either 6-pound sheet lead or 16-ounce copper. The sheet metal shall be cut to size and shape of the shower area, allowing six inches for turn-up.

The corners shall be folded, not cut, and the corner seam shall be soldered or burned. The upstands shall be recessed so that the pan will receive any seepage through materials above. The pans shall be coated with two coats of asphalt. Both sides of the pan including upstands shall be coated with asphalt paint. The pan shall be installed and the trap flange shall be countersunk to assure drainage. The trap shall be plugged and the pan filled with water as a test before installing the cement and tile.

2.07 DRAINS

Provide floor drains (FD) as manufactured by Josam, Zurn or Wade. All drains shall have nickel-bronze tops. All floor drains shall be as scheduled on the Drawings. Provide flashing clamp devices on all drains.

2.08 WATER PIPE, FITTINGS AND CONNECTIONS

- A. All water piping shall be Copper Type "L" except where otherwise noted on the Drawings. Copper pipe where code allows to be under slabs shall be continuous without joints, and encased in plastic pipe sleeves, its total length to include the turn to above slab.

- B. The piping shall be extended to all fixtures, outlets, and equipment from the gate valve. Plugged or capped fittings shall be provided for draining low points of the piping system. Outlets shall be capped or plugged and left ready for future connections.
1. Piping shall be installed as indicated on the Drawings. Pipe shall be cut accurately to measurements established at the building by the Contractor and shall be worked into place without springing or forcing. Care shall be taken not to weaken structural portions of the building. Aboveground piping shall be run parallel with the lines of the building unless otherwise shown or noted on the drawings. Branch pipes from service lines may be taken from top, bottom, or side of main using such crossover fittings as may be required by structural or installation conditions. Service pipes, valves, and fittings shall be kept a sufficient distance from other work and other services to permit not less than 1/2-inch between finished covering and other work and not less than 1/2-inch between finished covering on the different services. Changes in pipe sizes shall be made with reducing fittings. Use of long screws and bushing will not be permitted.
 2. All water piping shall be installed so as to allow complete drainage through hose bibs, or 1/2-inch globe valves.
 3. Allowance for expansion and contraction shall be made throughout the system. Horizontal runs over 50 feet long shall be anchored to the wall or to the supporting construction about midway on the run to force the expansion movement to divide equally, half at each end. Sufficient flexibility shall be provided on all branch runouts from mains to risers to provide for expansion and contraction of piping. Flexibility shall be provided by installing one or more turns in the line so that the piping will spring enough to allow for expansion without staining.
 4. Air chambers shall be provided on all hot and cold supplies near each faucet, control valve, or flush valve, except hose faucets. Chambers shall be self-draining when the system is drained. If not definitely shown on the Drawings, air chambers shall consist of an 18-inch length of pipe one diameter larger than the branch supply, capped. Provide a mechanical shock absorber equal to Zurn Z-200 at any quick-closing valve, and other places air chambers are not approved.
- C. Threaded pipe shall conform to the requirements of other applicable paragraphs and sections of these Specifications. Unions shall be provided where required for disconnection of exposed piping. Unions shall be accessible.

2.09 VALVES

- A. Valves shall be provided on all supplies to fixtures and equipment. Valves indicated in connection with runouts, risers, branches, and mains shall be in accordance with this Specification. No valve shall be installed on any line with its stem below the horizontal. All valves shall be gate valves unless otherwise specified or indicated. Valves three inches and smaller shall be all bronze construction. Larger valves shall have iron bodies with brass trim. All valves shall be designed for a minimum working pressure of 125 psig saturated steam. Valves for use with ferrous pipe shall have threaded ends through 2-inch size, and flanged ends for larger sizes. Valves shall be equal to the following figure numbers as manufactured by the William Powell Company:

| <u>TYPE</u> | <u>3" & SMALLER SCREWED ENDS</u> | <u>3" & 3-1/2" FLANGED</u> | <u>VALVES FOR COPPER PIPING SWEAT ENDS</u> |
|-------------|--|------------------------------------|--|
| Gate | 2700 | 1793 | Nibco #S112 |
| Gate (NRS) | 2707 | 1787 | Nibco #S113(NRS) |

Check 578 559 Nibco #S413

1. Nonrising stem valves shall be used only where space conditions prevent use of rising stem valves, or where installed underground in valve boxes.
2. Check valves subject to back pressure, pulsations or reversal of flow, shall have provisions for quick closing by means of springs, weight and lever, or as approved.
3. A complete list shall be submitted for written approval. All valves shall be products of the same manufacturer.
4. Valves shall be products of William Powell Co., Crane, or approved equal.

2.10 UNIONS

Unions on ferrous pipe three inches in diameter and smaller shall be 150 pounds malleable iron, zinc-coated. Unions on water piping 3-1/2 inches in diameter and larger shall be flanged pattern, 125-pound class, zinc-coated. Gaskets for flanged unions shall be of the best quality fiber, plastic, or leather. Unions shall not be concealed in walls, ceilings, or partitions.

2.11 HOSE BIBS

Hose bibs shall be brass, polished chromium plated, as manufactured by Chicago Faucet Company. Potable water bibs shall be No. 952, 3/4-inch or 1-inch with vacuum breaker as noted on the Drawings. Equal by N1BCO, Purtecor Sill Cocks Model 763VB with built-in backflow preventor.

2.12 RELIEF VALVE

Provide an approved temperature and pressure relief valve for the electric water heater. Relief valve shall be equipped with manual test lever. Pipe relief valve discharge to building exterior or as approved.

2.13 PIPE SLEEVES, HANGERS AND FIXTURE SUPPORT

- A. Pipe sleeves, hangers and fixture support shall be furnished and set, and the Contractor shall be responsible for their proper and permanent location.
1. Pipe sleeves shall be installed for pipes passing through footings, floors, walls and roof decks constructed with concrete and other cast-in-place materials. Clearance between sleeves and pipe covering and/or pipes shall be approximately 1/2-inch. Construction shall not be cut except where approved by the County. Where cutting of construction is permitted, the construction shall be repaired to match its original condition. Sleeves located in exterior walls, concrete roof slabs, and floors on and below grade shall be sealed to make the space between pipe and sleeve watertight. Sleeves shall not be installed in structural members except where indicated or where the Contractor has received prior approval of the County.
 - a. Pipe sleeves shall be installed for pipes that will pass through exterior walls and floors. Sleeves that pass through the floor shall extend 1 to 2 inches above the floor. The space between sleeve and pipe and/or pipe covering shall be sealed with plastic bituminous cement.
 - b. Where plumbing piping (6 inches and smaller) passes through finished floors and the pipe will be exposed, the sleeve shall be fabricated of 3/16-inch (minimum) 316 stainless steel, and the sleeve shall be cut off exactly 1-inch above finished floor unless otherwise noted on the Drawings.
 2. Pipe Hangers, Inserts and Supports:

- a. Unless otherwise noted or detailed on the Drawings, pipe hangers and supports shall be Ginnell, ITT or approved equal. Pipe hangers shall be Fig. 107, Fig. 115 or Fig. 138; wall hooks Fig. 168; and brackets Fig. 223. Concrete inserts shall be equal to Fig. 281 and shall be installed before the concrete is poured. Wherever possible, ceiling hangers shall be supported utilizing toggle bolts of an approved type or ceiling flanges Fig. 128 or 128R, or as detailed on the Drawings.
 - b. Horizontal Piping: Hangers and supports shall be installed as specified hereinafter, and at locations not more than three feet from the end of each runout. A hanger shall be installed not over one foot from each change in direction of piping. In lieu of separate hangers, the Contractor may submit for approval by the County a detailed drawing of trapeze hangers. Rings shall have a diameter large enough to include pipe insulation and protective saddle. Hangers for copper piping shall be copper plated.
 - 1) Cast iron soil pipe shall be supported at not more than five foot intervals and supports shall be located near each hub, or joint.
 - 2) Threaded pipe shall be supported at eight foot intervals.
 - 3) Underground piping shall be laid on a firm bed for its entire length, except where support is otherwise provided.
3. Fixtures and equipment shall be supported and fastened in a satisfactory manner. Where secured to solid masonry, fixtures and equipment shall be fastened with brass bolts or machine screws in lead or corrosion-resisting-metal, sleeve type anchorage units or with brass expansion bolts. Expansion bolts shall be 1/4-inch brass bolts with 20 threads to the inch and of sufficient length to extend at least three inches into solid masonry construction, and shall be fitted with loose tubing or sleeves or proper length to ring expansion sleeves into the solid concrete or brick wall. Where secured to cellular masonry construction, fixtures and equipment shall be fastened with 1/4-inch brass toggle bolts or through bolts. Exposed heads of bolts and nuts shall be hexagonal with rounded tops finished and chromium plated; exposed ends of bolts shall be concealed by chromium plated hexagonal nuts. Exposed nuts and heads of screws shall be provided with chromium plated brass washers.

2.14 IDENTIFICATION TAGS

Identification tags made of brass, indicating function of the valve, size, and working pressure shall be installed on all valves except valves installed on supplies to plumbing fixtures. Tags shall be two inches in diameter and marking stamped and wired to valve with 0.0808-inch diameter (No. 12 AWG) copper wire. The Contractor shall also provide charts and diagrams of approved size giving the number, location and function of each valve, and distinguishing all pipe lines. Upon completion of the work, the Contractor shall furnish record drawings to the County.

2.15 FLOOR, WALL AND CEILING PLATES

Exposed insulated and uninsulated pipes through floors, finished walls, or finished ceilings shall be fitted with chromium plated or enameled cast iron or steel plates. Plates shall be large enough to completely close the hole around the pipes and shall be square, octagonal, or round, with the least dimension not less than 1-1/2 inches larger than the diameter of the pipe. Plates shall be secured in an approved manner.

2.16 PIPE INSULATION

- A. The Contractor shall provide insulation for all water lines above floor, the domestic hot water

system, heat recovery system air conditioning condensate drain piping and the horizontal waste arm serving electric water cooler(s).

1. Hot water pipe insulation shall be Johns-Manville J-M Micro-Lok fiberglass pipe insulation, Certianteed Corp., or approved equal, finished with standard four ounce canvas jacket. Installation shall be in accordance with manufacturer's published recommendations.
2. Condensate and electric drinking fountain waste shall be insulated with Johns-Manville J-M Aerotube, Certainteed Corp., or approved equal.

2.17 STRAINERS

Strainers shall be 125-pound cast iron body Y-pattern with removable brass screen basket as manufactured by Sarco Company, or approved equal.

2.18 PRESSURE GAUGES

Pressure gauges shall be 4-1/2 inch dial size with bottom or rear connection, weatherproof, as manufactured by Marshalltown, equal to No. 23 or 44, and suitable for the specific service pressure, by Terice, Series 600 or 615; Ashcroft, or equal. Provide brass shut-off cocks on the stem to each pressure gauge.

2.19 PAINTING

Exterior surfaces of piping to be installed in or through concrete shall be given one coat of acid resisting paint having a bituminous base. Pipe hangers, supports, and other iron work concealed or in unfinished spaces shall be thoroughly cleaned and painted with one coat of black asphaltic varnish. Finish painting of exposed pipe, pipe covering, hangers, supports, and other work is specified in the Contract Documents.

2.20 TYPES OF FIXTURES AND FIXTURE TRIMMINGS

Provide the fixtures noted on the Drawings complete with all necessary trim.

PART 3 EXECUTION

3.01 INSTALLATION

- A. Drainage and Vent Pipes: Horizontal soil and waste pipes shall have a grade of 1/8-inch per foot except where 1/4-inch per foot is noted on the Drawings. All main vertical soil and waste stacks shall be extended full size to the roofline and above as vents, except where otherwise specifically indicated. Where practicable, two or more vent pipes shall be connected and extended as one pipe through the roof. Vent pipes in roof spaces shall be run as close as possible to the underside of the roof without forming traps in pipes, using fittings as required. Vertical vent pipes may be connected into one main vent riser above vented fixtures. All vent and branch vent pipes shall be so graded and connected as to drip back to the vertical stack by gravity. Cast iron no-hub pipes inside buildings shall be extended six inches above the floor. Roof vents shall be offset to maintain a distance of ten (10) feet minimum from air conditioning outside air intake, or any ventilating opening.
- B. Fittings: Changes in pipe size on soil, waste, and drain lines shall be made with reducing fittings or recessed reducers. All changes in direction shall be made by the appropriate use of 45 degree wyes, long or short sweep 1/4 bends, 1/6, 1/8 or 1/16 bends, or by a combination of

those of equivalent fittings. Single and double sanitary tees and 1/4 bends may be used in drainage lines only where the direction of flow is from horizontal to vertical.

- C. Union Connections: Slip joints will be permitted only in trap seals or on the inlet side of the traps.
- D. Joints:
 - 1. Joints in hub-and-spigot cast iron soil, waste and vent pipes, or between cast iron soil, waste, and vent pipes and threaded pipe or caulking ferrules, shall be firmly packed with tarred-twisted jute packing and caulked with lead at least one inch deep.
 - 2. Threaded pipe joints shall be made by use of an approved mechanical cutter and all joints shall be reamed. No more than three threads shall remain exposed after assembly.

3.02 TESTS

- A. Soil, waste, vent and water piping shall be tested by the Contractor and approved before acceptance. Underground soil and waste piping shall be tested before backfilling. Equipment required for test shall be furnished by the Contractor at no additional cost to the County.
- B. Drainage and venting system piping shall be tested with water or air before the fixtures are installed. After the plumbing fixtures have been set and their traps filled with water, the entire drainage and venting system shall be submitted to a final test with smoke or peppermint.
 - 1. Water test shall be applied to the drainage and venting system either in its entirety or in sections. If the entire system is tested, all openings in the pipes shall be tightly closed except the highest opening, and the system shall be filled with water to the point of overflow. If the system shall be tested in sections, each opening except the highest opening of the section under test shall be tightly plugged, and each section shall be filled with water and tested with at least a 10 foot head of water. In testing successive sections, at least the upper 10 feet of the next preceding section shall be tested so that each joint or pipe in the building except the uppermost 10 feet of the system has been submitted to a test of at least a 10 foot head of water. The water shall be kept in the system, or in the portion under test, for at least 15 minutes before the inspection starts; the system shall then be tight at all joints.
 - 2. If tests are made with air, a pressure of not less than five pounds per square inch shall be applied with a force pump and maintained at least 15 minutes without leakage. A mercury-column gauge shall be used in making the air test.
 - 3. When the smoke test is employed, the smoke shall be produced by a smoke machine, and a pressure equal to one inch water column shall be maintained for 15 minutes before inspection starts. When the peppermint test is preferred, two ounces of peppermint shall be introduced into each line or stack. Defects discovered shall be eliminated by resetting the fixtures and equipment with new gaskets.
- C. Water System: When the roughing-in is completed and before the fixtures are set, the entire hot and cold water piping system shall be tested at a hydrostatic pressure of not less than 100 pounds per square inch gauge, and proved tight at this pressure for not less than 30 minutes in order to permit inspection of all joints. Where a portion of the water piping system is to be concealed before completion, this portion shall be tested separately as described for the entire system.
- D. Defective Work: If inspection or test shows defects, such defective work or material shall be

replaced and inspection and tests repeated. Repairs to piping shall be made with new material; no caulking or peening of screwed joints or holes will be acceptable.

3.03 WATER FOR TESTING

- A. The Contractor shall provide steam and water necessary for testing the piping systems. The Contractor shall make all connections for testing and remove all debris resulting therefrom. The water shall be used in an efficient and economical manner.
- B. Provide all apparatus and all other supplies or materials which may be necessary for testing the systems and operating the apparatus during the period while tests of any kind are being made, or for carrying out the work of the Contract.

3.04 CLEANING

- A. At the completion of the work, the Contractor shall clean and polish, ready for use, all fixtures, equipment, apparatus and exposed trim.
- B. The Contractor shall protect this work during construction and all finished work damaged during construction shall be replaced at no additional cost to the County.

3.05 PROTECTION

- A. Materials, fixtures, and equipment shall be properly protected at all times and all pipe openings shall be temporarily closed so as to prevent obstruction and damage.

3.06 STERILIZATION

The entire potable water collection and distribution system shall be thoroughly sterilized with a solution of not less than 50 parts per million of available chlorine. The sterilizing solution shall be allowed to remain in the system for a period of three hours after which time all valves and faucets shall be opened and the system shall be flushed with clean water until the residual chlorine content is not greater than 0.92 parts per million, unless otherwise directed.

END OF SECTION

SECTION 15500 AIR CONDITIONING SYSTEM

PART 1 GENERAL

1.01 SCOPE

Furnish and install a complete air conditioning system for climate control. The system shall be a ____ (__) ton high efficient air conditioning unit manufactured by Carrier, York or approved equal, with a minimum SEER rating of 12. The system shall include all necessary components to insure a complete operable system. The major components shall include inside air handler/evaporator unit, outside condensing unit, duct system, condensate line, thermostat, electrical power and wiring.

1.02 CODES AND STANDARDS

All work performed under this specification shall conform to the requirements of the latest edition of the following codes and standards as modified by local ordinances:

NFPA Compliance: Comply with applicable provisions of ANSI/NFPA 70 National Electric Code. Also conform to Pamphlet 90A of NFPA.

Flame-Smoke Ratings: Provide air handling unit thermal insulation with flame-spread index of 25 or less, fuel-contributed index of 50 or less, and smoke-developed index of 50 or less.

AMCA Standards: Comply with Air Movement and Control Association (AMCA) standards as applicable for testing and rating fans, and testing louvers, dampers and shutters.

SMACNA Compliance: Comply with Sheet Metal and Air-Conditioning Contractors National Association (SMACNA) duct work construction standards.

American Society of Heating, Refrigerating and Air-Conditioning Engineers, Inc. (ASHRAE) Handbook.

ARI Certification: Provide central station packaged air handling units which comply with Air-Conditioning and Refrigeration Institute (ARI) Standard 430 and display ARI certification symbols.

UL Compliance: Provide electric components for air handling units which have been listed and labeled by Underwriters Laboratories.

Construction shall comply with ANSI B9.1 safety code.

Standard Building Code.

Standard Mechanical Code.

National Warm Air Heating and Air Conditioning Association - Manual 4.

1.03 PRODUCT DELIVERY, STORAGE AND HANDLING

- A. Deliver all components in factory-fabricated protective containers.
- B. Handle all components carefully to avoid damage to components, enclosures and finish. Do not install damaged components; replace and return damaged components to manufacturer.
- C. Store all components in clean dry place and protect from weather and construction traffic.

1.04 SUBMITTALS

- A. Thoroughly coordinated shop drawings shall be submitted for approval.

1. Submit shop drawings and complete performance data for all major pieces of equipment, showing dimensions arrangement, connection sizes, electrical wiring diagram, power requirements and clearances required for access of service. Shop drawings shall include factory certification that the equipment has the required capacity, or shall include copies of manufacturer=s published performance data.
 2. Equipment proposed will require complete shop drawings, which clearly show how the equipment fits the available space and in relation to adjacent equipment, with all connections shown such as piping and duct work.
 3. Provide submittal data for major component, air distribution devices, installation materials and duct work.
 4. Submit for approval complete power and control field wiring diagrams.
 5. Submit for approval a drawing indicating location and sizes of all wall penetrations and supports required for this work.
- B. All shop drawings submitted for approval shall be stamped by the Contractor before submission to indicate that the shop drawings are complete, checked and comply with all aspects of the requirements of all Contract Documents.
- C. Shop drawing approvals by the County will not relieve the Contractor from responsibility for his own errors, nor from his responsibility for full compliance with the Contract Documents.
- D. All data and drawings shall be submitted simultaneously in an indexed booklet.
- E. Warranty for the equipment under this Section.

1.05 OPERATING AND MAINTENANCE MANUALS

- A. When the installation is completed, submit to the County, one copy of the following, bound in a hard cover booklet:
1. General operating instructions, including copies of posted specific instructions and automatic control diagrams.
 2. Maintenance instructions, followed by tabulated manufacturer=s descriptive literature, shop drawings, performance curves and rating data, spare parts lists and manufacturer=s maintenance manuals.
 3. Names, addresses and telephone numbers of local service representatives of the manufacturer=s of the installed equipment.

PART 2 PRODUCTS

2.01 OUTSIDE CONDENSING UNIT

- A. Provide factory assembled self-contained, air cooled condensing unit, complete with compressor section, integral condenser, all necessary controls and interconnecting refrigerant piping. Furnish manufacturer=s five (5) year parts and labor warranty for motor compressor.
- B. All components shall be protected against corrosion and shall be mounted in a steel casing of a minimum of 14-gauge panels with steel angle framing and adequate access panels for inspection and maintenance.

- C. Provide all piping, valves, and fittings required to properly interconnect all system components.
- D. Tubing for coils shall be copper; fins shall be aluminum.

2.02 INSIDE AIR HANDLER/EVAPORATOR UNIT

- A. Casing walls shall be fabricated of continuous galvanized steel and coated with baked enamel finish not lighter than 18 gauge. Removable panels shall provide access to the interior of the unit.
- B. Fan and coil sections shall be internally insulated with 1-inch thick, 3 lb. density neoprene coated fiberglass. Insulation shall be secured to the casing with waterproof adhesive and permanent fasteners.
- C. Fan wheel shall be forward curved type, non-overloading, and keyed to the shaft. Fan wheel shall be dynamically and statically balanced at factory.
- D. V-belt driven fan shall be designed for 50 percent overload capacity.
- E. Bearings shall be designed for a minimum of 200,000 hours average life.
- F. Coil section shall encase cooling coils and drain pan. Coils shall be arranged for horizontal air flow. Coil headers, valves and all piping shall be completely enclosed within the insulated casing.
- G. Tubing for coils shall be copper. Fins shall be aluminum.
- H. Drain pan shall be galvanized steel, with a heavy coat of mastic.
- I. Filter Section: Filter section shall be designed to hold throwaway filters.

2.03 SHEET METAL DUCTWORK

- A. All round and rectangular sheet metal duct work shall be fabricated from galvanized sheet steel complying with ASTM A 527, Lock forming Quality; with G 90 zinc coating in accordance with ASTM 525. Zinc coating shall be of uniform thickness; free from blisters, slivers and pits; and capable of withstanding normal sheet metal forming operating without flaking or splitting.
- B. Joints, gauge, reinforcement and fabrication techniques shall conform to minimum standards listed in SMACNA ΔHVAC Duct Construction Standards@ using actual duct dimensions and system pressures.
- C. Ductwork shall be installed in strict accordance with manufacturer=s recommendations and in compliance with SMACNA ΔHVAC Duct Construction Standards@.
- D. Thermal Insulation:
 - 1. Insulation material shall be similar in all respects to that manufactured by Owens-Corning, Certainteed, Armstrong, or equal. Exterior wrap for sheet metal shall be type 703 FRK 25. Provide and install all thermal insulation for the HVAC system.

2. Except for materials which are subsequently exempted, all other materials used as part of the thermal insulation shall have a fire hazard rating not to exceed 25 for flame spread and 50 for fuel contributed and smoke developed.

E. Components:

1. Provide all adhesives, sealers, vapor barrier coatings, etc., compatible with the material to which they are applied. They shall not corrode, soften, or otherwise attack such material in either the wet or dry state and must be suitable for the service temperature.

F. Ceiling Diffusers:

Provide adjustable-blade high-performance louver with 6" frame depth, constructed of extruded aluminum.

G. Sound Adsorption and Isolation:

Neoprene vibration isolation supports shall be provided on the air conditioning unit and other equipment that may transmit noise or vibration to the building structure.

2.04 TEMPERATURE CONTROLS

Furnish and install a heavy duty corrosion resistant wall mounted thermostat with locking cover. Use Carrier thermostat control or equal.

PART 3 TESTING AND BALANCING

- A. The Contractor shall test and balance the air conditioning system.
- B. The term **air conditioning systems** shall be understood and intended to mean all air conditioning supply systems, and all associated equipment and accessories.

PART 4 EXECUTION

4.01 GENERAL

- A. Install the air conditioning system where indicated, in accordance with equipment manufacturer's written instructions, and with recognized industry practices, to ensure that units comply with requirements and serve intended purposes.
- B. Coordinate with other work, including plumbing, ceiling and truss construction, roof decking, electric, piping, and overhead crane system as necessary to interface installation of air handling units with other work.
- C. Install air handling unit on vibration mounts and comply with manufacturer's indicated installation method.
- D. Spare Parts:
 1. Provide one complete extra set of filters for the air handling unit. Install new filters at completion of air handling system work, and prior to testing, adjusting and balancing work.

2. Provide one spare set of belts for the air handling unit.

4.02 INSTALLATION

- A. All major components shall be rigidly and strongly supported with suitable braces, tees, or angles to keep them true to shape and prevent buckling.
- B. Pocket joints or bar slips, if used, must be riveted at the corners. Approved means must be provided to prevent pocket and slip joints pulling apart such as riveting on 12 inch centers, clip punching on 8 inch centers or button pressing on 4 inch centers. Sheet metal screws puncturing ducts will not be allowed in the construction of seams and joints.
- C. Sealing and Leak Testing: All seams, joints, gaps, holes, etc. in the ductwork shall be sealed with mastic and checked for airtightness before insulation is applied.
- D. Ductwork Cleaning: Contractor shall thoroughly clean all ductwork chambers, fans, etc., manually. After this is done, blow out the systems with a built-up velocity so as to properly clean the interior of all ductwork, leaving same free of all foreign matter. The cleaning work shall be done before any painting is done.

END OF SECTION

SECTION 15600 FUEL PIPING

PART 1 GENERAL

1.01 SCOPE OF WORK

- A. The work of this section includes all labor, materials and equipment required for the installation and testing of the diesel fuel piping system complete and ready for operation. The fuel piping will connect the new diesel engine with the above ground fuel storage tank.

1.02 REQUIREMENTS OF REGULATORY AGENCIES

- A. All work shall conform to the applicable requirements of the city, county, state and federal codes. Where the requirements of such agencies are more stringent than specified herein, abide by such requirements and consider this specification as supplementary to those requirements.
- B. All work shall conform to the applicable requirements of the US Environmental Protection Agency, the Florida Department of Environmental Protection, and other applicable regulatory agencies.
- C. All work shall conform to the applicable requirements of the following: National Fire Protection Association (NFPA), The Florida Fire Prevention Code; and The Florida Building Code.
- D. All components of the fuel distribution system shall be UL listed, unless otherwise specified, or approved by the County.
- E. The fuel piping shall be designed and fabricated according to best practices and methods available to date.

1.03 QUALIFICATIONS

- A. Installer shall have had supervisory experience with two similar fuel systems in the past three years and shall be a Pollutant Storage System Contractor certified by the Department of Business and Professional Regulation in accordance with Chapter 489, Florida Statutes. A copy of the license shall be submitted, prior to proceeding with construction.

1.04 SUBMITTALS

- A. Complete shop drawings shall be submitted, including certification of shop test to the County for review, according to General Conditions.
 - 1. The shop drawings shall include sufficient information to demonstrate compliance with the specified standards, including copies of applicable sections of the specified standards, manufacturer's catalog data and descriptive literature for all equipment including a fully dimensioned shop layout drawing (1/4" = 1' scale or larger) showing all piping, valves, equipment connections, and test procedures.
 - 2. The shop drawings for pipe, fittings, and each item listed in the Specifications shall include manufacturer's catalog data and descriptive literature, fully dimensioned

shop layout drawing (1/4" = 1' scale or larger) showing all piping, equipment connections, and installation clearance requirements.

3. Submit all manufacturer's recommended installation, test procedures, operating, and maintenance instructions for all equipment.
4. Submit manufacturer's warranty for all equipment.

1.05 PRODUCT HANDLING

- A. Deliver materials and equipment to project site in manufacturer's original, unopened containers with labels intact and legible. Labels shall indicate manufacturer's name and model number. Store equipment in dry protected area. All damaged items shall be replaced with new at no additional cost to County.
- B. Piping shall be supplied to the site with sealed end caps which shall remain in place until installation.

PART 2 PRODUCTS

2.01 PIPE AND FITTINGS

- A. The CONTRACTOR shall furnish and install fuel system piping and make all required fuel system connections between the diesel engine and the above ground fuel storage tank for a complete and properly operating generator set equipment fuel system. All parts of the fuel system shall meet the approval of, and be installed in complete compliance with all applicable NFPA guidelines and local, state and federal codes, laws and regulations.
- B. The fuel piping between the fuel storage tank and the engine shall be of a piping size as recommended by the pump supplier.
- C. All fuel piping shall be black iron pipe, Schedule 40 in conformance with ASTM A-795 and ANSI B31.3-1980 with 125 lb. butt-welded malleable iron fittings conforming to ANSI B16.3 and ANSI B31.3-1980.
- D. Flexible piping at tank and equipment connections shall be constructed of a seamless flexible plastic liner with corrosion resistant type 316 stainless steel wire braid reinforced cover, stainless steel collars, and ductile iron fittings.
- E. Provide piping transitions, sleeves, and supports as shown on the Drawings and as required for a rigidly supported and complete installation. Seal all wall penetrations watertight.
- F. All interior and exterior supports including hangers, brackets, fasteners, and miscellaneous metals shall be Type 316 stainless steel galvanized steel or aluminum.

2.02 JOINT COMPOUND

- A. Joint compound for steel pipe threaded connections shall be a non-hardening, non-solvent joint sealer compatible with fuel products.

PART 3 EXECUTION

3.01 INSTALLATION

A. Fuel Piping

1. All pipes shall be cut accurately to measurements established at the site and shall be worked into place without forcing or bending. All pipes shall be installed into place without traps or pockets and pitched 1-inch in 40-foot minimum to drain. All underground fuel piping shall be installed in containment piping.
2. Piping shall be installed to minimize the quantity of piping joints. Provide unions and/or flexible connections at all equipment connections.
3. Joints shall be fabricated in accordance with standard industry practices and manufacturer's instructions. All joints shall be liquid tight, screwed joints except where flanged connections to equipment or valves are required. Cut pipe square using pipe cutting tool and carefully ream pipe to remove all burrs. Cut a complete thread, using sharp dies properly set and centered, while applying oil graphite cutting lubricant.
4. All new above ground black iron pipe shall be painted safety yellow.

B. Flexible Fuel Piping

1. Provide flexible piping connectors at all generator connections and all storage tank connections and all equipment connections.
2. Flexible connections shall be a minimum of 12-inches long or as required for equipment removal or maintenance. Protect flexible connectors where physical damage may occur due to adjacent equipment, other piping, wiring, or where subject to possible damage from operating personnel.

3.02 TESTING

- A. Piping shall be tested in strict accordance with the manufacturer's testing requirements. Piping system shall be tested upon completion of the roughing-in before setting equipment. The entire system shall be pressure tested with fuel at 5 psig and proved tight at this pressure for a period of four (4) hours. The secondary containment pipe shall be leak tested at 2 psi for four (4) hours or at the manufacturer's suggested pressure and/or method. Defective work or material shall be replaced and retested. The system shall be test plugged or capped prior to testing to prevent test pressure from reaching any equipment or storage tank.
- B. Piping shall be precision tested by a state qualified tester, or as recommended by the applicable manufacturer.
- C. Contractor shall provide fuel for any required testing and retesting. If the fuel subsequently becomes contaminated, Contractor shall dispose of the fuel at no cost to the County and in accordance with all regulations. Upon completion of the testing and prior to final acceptance of the system, the Contractor shall make sure the fuel levels in the storage tanks are equal to when the work began.

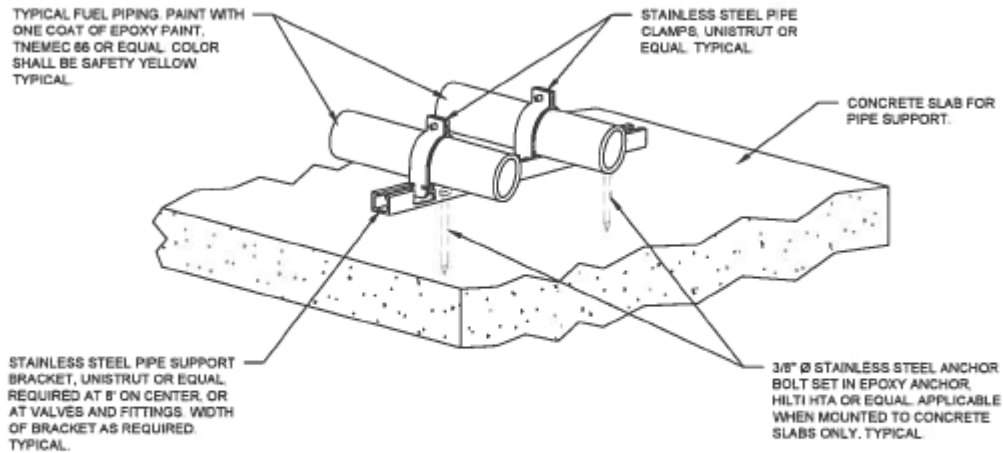

FUEL PIPING MOUNTING DETAIL

NTS

END OF SECTION

DIVISION 16 ELECTRICAL

SECTION 16050 ELECTRICAL - GENERAL PROVISIONS

PART 1 GENERAL

1.01 SCOPE OF WORK

- A. Furnish all labor, materials, devices, equipment, appurtenances, and incidentals required for a complete electrical system as hereinafter specified and/or shown on the Contract Drawings. This work may necessarily include interfacing with and/or completely installing devices and/or equipment furnished under other sections of these Specifications.
- B. It is the intent of these Specifications that the electrical system be suitable in every way for the service required. All materials and all work/labor which may be reasonably implied as being incidental to the requirements of this Section shall be furnished at no additional cost to the County.
- C. All power interruptions to existing equipment shall be at the County's convenience. Each interruption shall have prior approval. Request(s) for power interruption(s) shall be made at least forty-eight (48) hours in advance.
- D. The work shall include complete testing of all electrical components, including wiring.
- E. All workmanship shall be of the highest quality. Substandard work will be rejected and it shall be replaced entirely at the Contractor's expense with no cost to the County.

- F. It shall be the responsibility of each bidder or his authorized representative to physically visit the job site in order that he may be personally acquainted with the area(s), buildings and/or structures intended for use in the installation/construction under this Specification. The submittal of a proposal/bid by a bidder shall be considered evidence that he has complied with this requirement and accepts all responsibility for a complete knowledge of all factors governing his work. Therefore, failure to comply with this requirement of the Specifications will NOT be grounds for the successful bidder (Contractor) to request approval of change orders and/or additional monetary compensation.

1.02 TEMPORARY ELECTRICAL SERVICE

- A. The Contractor shall make the requisite arrangements for securing temporary electrical power for his use in accordance with Section 01510 of these Specifications.

1.03 CODES, INSPECTIONS AND FEES

- A. All materials and installations shall be in accordance with the National Electrical Code (latest edition) and the latest editions of all applicable national, state, county and local codes.
- B. To the extent that any item is routinely tested and rated by the Underwriter's Laboratories, Inc., that item shall bear the U.L. label. Additionally, all items shall be manufactured to the applicable NEMA standards.
- C. The Contractor shall make the necessary arrangements for obtaining all requisite permits and inspections and pay any applicable fees.

1.04 TESTS

- A. The Contractor shall test all items individually and as a system for proper operation.
- B. The Contractor shall, at his expense, make all the requisite repairs, adjustments and/or alterations to correct any shortcomings found as a result of the tests performed under Item 1.04.A above.
- C. A representative of the County shall be present during all testing. The County shall be notified at least two (2) days prior to any testing.

1.05 SLEEVES AND FORMS FOR OPENINGS

- A. Provide and place all sleeves for conduits penetrating floors, walls, partitions, etc. Locate all necessary slots for electrical work and form before concrete is poured.

1.06 CUTTING AND PATCHING

- A. All cutting and patching shall be done in a thoroughly workmanlike manner - i.e., care shall be taken when cutting not to damage or mar surrounding areas, and when patching to match the original finish as closely as possible while providing a watertight seal. Refer to Item 1.01.E above.

1.07 INTERPRETATION OF DRAWINGS

- A. The layouts and arrangements as shown on the Contract Drawings are indicative of the

physical arrangements desired; however, they are not intended to restrict the Contractor's freedom to accommodate the exact conditions as found in the field. Any deviations from the arrangements shown must be approved by the County prior to the final placement of the item(s) in question.

- B. The Contract Drawings are not intended to show exact locations of conduit runs.
- C. Circuit and conduit layouts shown are not intended to indicate the exact installation details. The Contractor shall furnish and install all requisite items, including all fittings, junction boxes, etc., to insure that the electrical system operates in conformance with the Specifications and the specific requirements of an individual piece of equipment.
- D. Where circuits are shown as "home-runs", all necessary fittings and boxes shall be provided for a complete conduit installation.
- E. All three-phase circuits shall be run in separate conduits unless otherwise shown on the Contract Drawings.
- F. Surface mounted items such as panelboards, junction boxes, conduit, etc., shall be supported by spacers to provide a clearance between the equipment and the mounting surface.
- G. The County shall make the final decision in determining the exact location(s) and mounting height(s) of any item(s) or piece(s) of equipment in question.
- H. All connections to equipment shall be made in accordance with the approved shop and manufacturer's drawings, regardless of the number of conductors shown on the Contract Bid Drawings.
- I. The Contractor shall coordinate the work of the different trades in order to prevent interferences between conduit(s), piping and other non-electrical equipment. In case any interference develops, an authorized representative of the County shall decide which equipment, conduit(s) or piping must be relocated, regardless of which was installed first. Any such interferences shall be remedied solely at the Contractor's expense without any additional cost to the County.

1.08 EQUIPMENT SIZING AND HANDLING

- A. The Contractor shall thoroughly check all entryways, doors, hallways, stairways, buildings and structures through which equipment must be transported to reach its final location.
- B. If necessary for safe passage of the equipment, the manufacturer shall be required to ship his material in sections sized to pass through the restricted areas. This requirement holds even if such equipment sizing differs from the manufacturer's standard shipping section.
- C. To the extent possible, the equipment shall be kept upright at all times. If equipment has to be tilted for ease of passage through restricted areas, the manufacturer shall provide specific handling instructions as well as any requisite bracing in order to assure both the functional integrity of the equipment and the validity of the equipment warranty.

1.09 SUBMITTALS

- A. As specified under Section 01340 of these Specifications, the Contractor shall submit shop

drawings and/or manufacturer's cut sheets for approval of all materials, equipment, devices, apparatus, and other items as required by the County.

1. Prior to submittal by the Contractor, all shop drawings shall be checked for accuracy and Contract requirements. Shop drawings shall bear the date checked and shall be accompanied by a statement that the shop drawings have been examined for conformity to the Specifications and Contract Drawings. This statement shall also list all discrepancies with the Specifications and Contract Drawings. Shop drawings not so checked and noted shall be returned unchecked by the County.
 2. The County's check shall be only for conformance with the design concept of the Project and compliance with the Specifications and Contract Drawings. The responsibility for, or the necessity of, furnishing materials and workmanship required by the Specifications and Contract Drawings which may not be indicated on the shop drawings is included under the work of this Section.
 3. No material shall be ordered, no equipment manufacturing shall be started, nor shall any shop work/fabrication commence until the County has approved the shop drawings. Any deviation from this requirement of the Specifications shall be entirely at the risk and expense of the Contractor without any additional cost to the County.
- B. Record Drawings: As the work progresses, the Contractor shall legibly record all field changes on a set of Contract Drawings. When the project is completed, the Contractor shall furnish the County with a complete set of reproducible "as-built" drawings.

1.10 MANUFACTURER'S SERVICES

- A. The Contractor shall arrange for an authorized manufacturer's representative who shall be an experienced field service engineer to be present for the inspection, installation, testing, calibration, adjusting and start-up of any item(s) or piece(s) of equipment as deemed necessary by the County.
- B. In addition to the duties of Item 1.11.A above, the manufacturer's representative shall also instruct the County's personnel in the proper operation and maintenance of the item(s) in question.

1.11 MATERIALS

- A. All materials used shall be new, unused and as hereinafter specified. Where not specifically called out, all materials shall be of the very best quality of their respective kinds. Unless specifically otherwise approved in writing by the County, only material manufactured in the United States shall be used!
- B. Where applicable, all materials and equipment shall conform with the requirements of Item 1.03.B above.
- C. Electrical equipment shall at all times during construction be adequately protected against both mechanical injury and damage by water. Electrical equipment shall be stored indoors in dry shelters. Any damaged equipment shall be replaced by the Contractor at his own expense.
- D. All items shall be manufactured from the materials specified - substitute materials will NOT be acceptable.

- E. Only the specified manufacturer's equipment shall be used unless an "or approved equal" is noted. The County shall be the sole determiner of what constitutes an "approved equal".

1.12 GUARANTEES AND WARRANTIES

- A. All items furnished under the Electrical Specifications shall be guaranteed and/or warranted, in writing, against defects in materials, construction and workmanship as specified under Section 01740 of these Specifications.

END OF SECTION

SECTION 16108 MISCELLANEOUS EQUIPMENT

PART 1 GENERAL

1.01 SCOPE OF WORK

- A. Furnish and install all miscellaneous equipment as hereinafter specified and/or shown on the Drawings.
- B. Installation shall be in the locations described herein and/or shown on the Drawings and/or where directed by the County's authorized personnel.

PART 2 PRODUCTS

2.01 MATERIALS

A. CIRCUIT BREAKERS

- 1. The circuit breakers shall be the molded case bolt-on type, shall have a single pole, shall be rated 20-amperes at 120/240 VAC, and shall have an interrupting rating of 10,000-amperes.
- 2. To match existing equipment, the circuit breakers shall be the Square "D" Catalog No. Q0B120 with "VISI-TRIP" indicator for use on a Square "D" NQOD panelboard, NO SUBSTITUTIONS!

B. SAFETY SWITCHES

- 1. The safety switches shall be the visible blade, non-fusible, heavy duty type, shall have a quick-make, quick-break, single throw operating mechanism, and shall have both a dual cover interlock and a color coded indicator handle.
- 2. The safety switches shall have three (3) poles, shall be rated 30-amperes at 600 VAC, shall have all current carrying parts made of copper, and shall be furnished in a NEMA 3R rainproof enclosure.
- 3. The safety switches shall have 1-inch bolt-on hubs, a solid neutral assembly, and a copper ground kit.
- 4. In addition to being UL listed under files E2875 and 154828, the safety switches shall comply with the following standards:
 - a. UL 98, Enclosed and Dead Front Switches.
 - b. NEMA KS1, Enclosed Switches.
 - c. Federal Spec WS-865c for Type "HD".
- 5. To match existing equipment, the safety switches shall be the Class 3110 Heavy Duty Safety Switch, Square "D" Catalog No. HU361RB, NO SUBSTITUTIONS!

C. FLOW METER

- 1. The flow meters shall be the Doppler type with separately mounted electronics and two (2) non-intrusive strap-on transducer assemblies.
- 2. The installed transducers shall be attached to the outer periphery of the pipe with stainless steel straps which shall be furnished as part of the flow meter package. Additionally, the transducers shall be furnished with a 30-foot long cable to interconnect with the meter electronics.
- 3. Flow meter electronics shall have the following:

- a. Accuracy to plus or minus 2% of the actual flow.
 - b. User-friendly keypad programming.
 - c. 90,000 point data logger.
 - d. Flow range of 0.05 to 32.0 feet per second.
 - e. Both 4-20 maDC and RS 232 outputs.
 - f. Supply voltage of 90-132 VAC, 60 Hertz, single phase.
 - g. Four (4) relays with 5 Amp SPDT contacts, fully programmable.
4. The electronics of the installed flow meter shall have a PVC or fiberglass weatherproof enclosure with a hinged cover (left vertical side) and clamps or clasps along the other three sides. The enclosure shall be approximately 24-inches square by 10-inches deep. The enclosure shall have an aluminum mounting backplate and shall be furnished with an interior-mounted duplex receptacle (see Item D.1 below). The flow meter enclosure shall be as manufactured by Hoffman, Rob Roy, or approved equal.

D. DUPLEX RECEPTACLES

- 1. Flow Meter Enclosure
 - a. The duplex receptacle shall be the ground fault circuit interrupter (GFCI) type, shall be rated 20-amperes at 125 VAC and shall be of the NEMA 5-20R configuration.
 - b. The duplex receptacle shall be made of brown nylon and shall be back and side wireable.
 - c. The duplex receptacle shall be Hubbel Catalog No. 5362, or approved equal.
 - d. The duplex receptacle shall be furnished with a surface mounted PVC or plastic device box.
 - e. The duplex receptacle shall be furnished with a brown nylon cover plate (both cover plate and duplex receptacle must be from the same manufacturer). The cover plate shall be Hubbel Catalog No. P8X, or approved equal.
- 2. New Meter Vault
 - a. The duplex receptacle shall be the ground fault circuit interrupter (GFCI) type, shall be rated 20-amperes at 125 VAC and shall be of the NEMA 5-20R configuration.
 - b. The duplex GFCI receptacle shall have a brown nylon face, shall have pre-stripped 4-inch back wire leads, and shall have captive mounting screws.
 - c. The duplex GFCI receptacle shall have a band on reset button to provide a visible indication of a ground fault trip.
 - d. The duplex GFCI receptacle shall be Hubbell Catalog No. GF5362, or approved equal.
 - e. The duplex GFCI receptacle shall be furnished with a surface mounted PVC or plastic device box.
 - f. The duplex GFCI receptacle shall be furnished with a zinc die cast weatherproof cover plate with dual flip lids (both cover plate and duplex GFCI receptacle must be from the same manufacturer). The cover plate shall be Hubbell Catalog No. CWP8H, or approved equal.

E. PAD SUPPORT STRUCTURE

- 1. A support structure, firmly embedded into the concrete pad outside the East wall of the new meter vault, shall be provided onto which the two (2) safety switches and the flow meter electronics enclosure shall be mounted.
- 2. The support structure shall be fabricated from stainless channels and shall have all stainless steel mounting hardware.

3. The height of the support structure shall be such as to maintain an even 6'-0" mounting height from the top surface of the concrete pad to the top surface of the individual devices mounted on the support structure.
4. The width of the support structure as well as the length and width of the steel reinforced concrete pad are predicated on the use of the devices specified elsewhere in this Section. If other than the specified items are used, the respective dimensions may have to be altered accordingly.
5. The stainless steel channel and stainless mounting hardware shall be as manufactured by Unistrut, Kindorf, or approved equal.

PART 3 EXECUTION

(NOT USED)

END OF SECTION

SECTION 16110 CONDUITS AND FITTINGS

PART 1 GENERAL

1.01 SCOPE OF WORK

Furnish and install the conduits, fittings, devices and appurtenances as hereinafter specified and/or as shown on the Contract Drawings.

1.02 SUBMITTALS

The requirements of Section 01340 and Section 16050 shall be met.

1.03 APPLICATIONS

- A. Except where otherwise shown on the Contract Drawings, or hereinafter specified, all wiring shall be run in rigid conduits.
- B. PVC Sch 80 or rigid aluminum conduits shall be used at all locations aboveground and within structures and buildings, except where otherwise shown on the Contract Drawings.
- C. PVC Sch 80 or rigid aluminum conduits shall be used at all locations for shielded instrumentation and shielded control wiring, except where otherwise shown on the Contract Drawings.
- D. Schedule 80 PVC conduits shall be used for all underground, under-slab and in-slab applications except where otherwise shown on the Contract Drawings.
- E. Schedule 80 PVC conduits shall be used in highly corrosive areas such as chlorine storage areas, digesters, fluoride storage and handling areas, etc.
- F. All conduits of a given type shall be the product of one manufacturer.
- G. Except where otherwise shown on the Contract Drawings, or hereinafter specified, all boxes shall be metal.
- H. Flush mounted switch, receptacle and control station boxes shall be pressed steel.
- I. Surface mounted switch, receptacle and control station boxes shall be cast or malleable iron.
- J. Devices designated as NEMA Type 4 shall be 316 stainless steel, gasketed.
- K. Devices designated as NEMA Type 4X shall be fiberglass, gasketed, except as otherwise shown on the Contract Documents.
- L. Combination expansion-deflection fittings shall be used where conduits cross structural expansion joints.

PART 2 PRODUCTS

2.01 MATERIALS

- A. Rigid Conduit

1. Rigid aluminum conduit shall be approved equal.
 2. Rigid PVC conduit shall be Carlon Plus 80 rigid PVC non-metallic conduit (extra heavy wall EPC-80) as manufactured by Carlon, or approved equal.
- B. Liquidtight, Flexible Conduit
1. Liquidtight, flexible metal conduits shall be Sealtite, Type UA, as manufactured by Anaconda, American Flexible Conduit Co., Inc., or approved equal.
 2. Liquidtight, flexible non-metallic conduits shall be Carflex Liquidtight Flexible Non-Metallic Conduit as manufactured by Carlon, or approved equal.
- C. Rigid Conduit Fittings
1. Rigid Aluminum Conduit Fittings:
 - a. Aluminum elbows, bends, sweeps, nipples, couplings, etc., approved equal.
 2. Rigid Non-Metallic Conduit Fittings: PVC elbows, bends, sweeps, nipples, couplings, device boxes, etc., shall be Plus 80 fittings as manufactured by Carlon, or approved equal.
- D. Flexible Conduit Fittings
1. Flexible Metal Conduit Fittings: Fittings used with flexible metal conduit shall be of the screw-in type as manufactured by Thomas and Betts Company, or approved equal.
 2. Flexible Non-Metallic Conduit Fittings: Fittings used with flexible non-metallic conduit shall be Carflex Liquidtight Non-metallic Fittings as manufactured by Carlon, or approved equal.
- E. Flexible Couplings: Flexible couplings shall be as manufactured by Crouse-Hinds, Appleton Electric Company, or approved equal.
- F. Wall Seals: Conduit wall seals shall be type "WSK" as manufactured by the O.Z. Electrical Manufacturing Company, or approved equal.
- G. Expansion Fittings: Combination expansion-deflection fittings shall be type "XD" as manufactured by Crouse-Hinds, or approved equal.
- H. Boxes
1. Device Boxes
 - a. Flush mounted wall device boxes shall be galvanized pressed steel as manufactured by the Raco Manufacturing Company, or approved equal.
 - b. Surfaced mounted wall device boxes shall be cast or malleable iron as manufactured by Crouse-Hinds, Appleton Electric Company, or approved equal.
 - c. Flush mounted in-floor device boxes shall be cast metal, shall be watertight, shall have adjustable cover frames, and shall be as manufactured by Russell & Stoll Company, Steel City Electric, or approved equal.
 2. Other Boxes
 - a. Terminal boxes, junction boxes, pull boxes, etc., except as otherwise specified and/or shown on the Contract Drawings, shall be PVC or 316 S.S.
 - b. The boxes shall have continuously welded seams and shall be ground smooth.
 - c. The box bodies shall be flanged, shall be not less than 14-gauge metal, and

- shall not have holes or knockouts.
- d. The box covers shall be not less than 12-gauge metal, shall be gasketed, and shall be fastened to the box bodies with stainless steel screws.
 - I. Conduit Mounting Devices: Hangers, rods, channel, backplates, clips, straps, beam clamps, etc., shall be 316 stainless steel as manufactured by Unistrut Corp., or approved equal.
 - J. Fixture Support System
 - 1. The fixture support system shall be the channel type and shall be furnished complete with all requisite mounting hardware and appurtenances.
 - 2. The channel, mounting hardware and related appurtenances shall be 316 stainless steel.
 - 3. The fixture support system shall be as manufactured by the Unistrut Corp., or approved equal.

PART 3 EXECUTION

3.01 INSTALLATION

- A. No conduit smaller than 3/4-inch electrical trade size shall be used nor shall either 1-1/4-inch conduit or 3-1/2-inch conduit be used. Minimum size underground, under slab or in-slab shall be 1-inch.
- B. No wires shall be pulled until the individual conduit runs are complete in all details. Additionally, each conduit shall be cleaned and reamed and certified clear of all burrs and obstructions before any wire is pulled.
- C. The ends of all conduits shall be tightly capped to exclude dust and moisture during construction.
- D. Conduits shall be supported at intervals of 8-feet or less, as required to obtain a rigid installation.
- EF. Exposed conduits shall be run parallel with and/or perpendicular to the surrounding surface(s). No diagonal runs will be allowed.
- F. Single conduits shall be supported by one-hole pipe clamps in combination with one-screw backplates to provide space between the conduits and the mounting surface.
- G. Multiple horizontal runs of conduits shall be supported by trapeze type hangers (channel) suspended by threaded rod, 3/8-inch minimum diameter.
- HI. Multiple vertical runs of conduits shall be supported by structurally mounted channel in combination with conduit clamps.
- I. Conduit support devices shall be attached to structural steel by welding or beam or channel clamps as indicated on the Contract Drawings.
- J. Conduit support devices shall be attached to concrete surfaces by "spot type" concrete inserts.
- K. Conduits terminating in pressed steel boxes shall have double locknuts and insulated bushings.

- L. Conduits terminating in gasketed enclosures shall be terminated with conduit hubs.
- M. Conduit wall seals, waterproof type, shall be used at all locations where conduits penetrate walls.
- N. Liquidtight, flexible conduit - metal or non-metallic as shown on the Contract Drawings - shall be used for all motor terminations and for all connections/terminations where vibration is anticipated.
- O. Flexible couplings shall be used in hazardous locations for all motor terminations and for all connections/terminations where vibration is anticipated.
- P. Conduit stubouts for future construction shall be capped at both ends with threaded PVC conduit caps.
- Q. The cement used for PVC conduit installations shall be as manufactured by Carlon, or approved equal.
- R. Rigid aluminum conduits entering manholes and/or below grade pull boxes shall be terminated with grounding type bushings which shall be connected to a 5/8-inch by 10-foot long driven ground rod with No. 6 AWG bare copper wire.
- S. Rigid aluminum conduit shall be used for all risers. The underground portion of the riser and a 12-inch section of the riser immediately above the ground or slab/floor level shall be painted with a bitumastic coating.
- T. The use of electrical metallic tubing shall be restricted to low voltage applications (600V or less) in non-process areas where specifically approved by the County on a "per installation" basis - e.g., above suspended ceilings in office areas.

3.02 GUARANTEES AND WARRANTIES

The Contractor shall guarantee and warrant all materials and labor provided under this Section in accordance with Section 01740 and Section 16050 of these Specifications.

END OF SECTION

SECTION 16120 WIRES AND CABLES

PART 1 GENERAL

1.01 SCOPE OF WORK

- A. Furnish and install all wires, cables and appurtenances as described hereinafter and/or as shown on the Contract Drawings.

1.02 SUBMITTALS

- A. The requirements of Section 01340 and Section 16050 shall be met.
- B. Samples of the actual wires and cables proposed for use shall be submitted for approval. There shall be a sample for each size and type of wire and cable proposed for use. The samples shall be of sufficient length to show the maximum rated voltage, insulation type and class, conductor size, the manufacturer's name, trademark or identifying logo, and the U.L. listing number.
- C. The wires and cables as approved for use shall be compared with the wires and cables actually installed. If any unapproved wires and cables are installed, they shall be removed and replaced solely at the Contractor's expense with no additional cost to the County.

1.03 APPLICATIONS

- A. The wire for lighting and receptacle circuits shall be type THHN/THWN, stranded.
- B. The wire for all power circuits and motor leads shall be type THHN/THWN, stranded.
- C. Single conductor wires for control, indication and metering shall be type THHN/THWN, No. 14 AWG, stranded.
- D. Multiconductor control cable shall be No. 14 AWG, stranded.
- E. The wire for process instrumentation shall be No. 16 AWG, stranded.

1.04 MINIMUM SIZES

- A. Except for control and signal leads, no conductor smaller than No. 12 AWG shall be used.

PART 2 PRODUCTS

2.01 MATERIALS

- A. Wire and cables shall be made of annealed, 98% conductivity, soft drawn copper conductors.
- B. All conductors shall be stranded except that the uninsulated copper grounding conductors shall be solid.

2.02 600 VOLT WIRE AND CABLE

- A. Type THHN/THWN insulation shall be used for all 600 Volt wires and cables. The insulation shall be a flame-retardant, heat-resistant thermoplastic, and shall have a nylon, or equivalent,

jacket.

- B. The 600 Volt wires and cables shall be as manufactured by Anixter, Rome Cable, Southwire, or approved equal.

2.03 INSTRUMENTATION AND CONTROL WIRING

- A. Process instrumentation wiring shall be No. 16 AWG stranded twisted pair, 600 Volt, cross-linked polyethylene insulated, aluminum tape shielded, PVC jacketed. Multiconductor cables with individually twisted pairs shall be installed where shown on the Contract Drawings.
- B. Multiconductor control cables shall be No. 14 AWG, stranded, 600 Volt, cross-linked polyethylene insulated, PVC jacketed.
- C. Instrumentation and control wiring shall be as manufactured by Belden, Alpha, or approved equal.

2.04 5KV CABLES

- A. All 5KV cables shall be manufactured and tested in accordance with ICEA Publication No. 5066-524 and AEIC No. 5, latest revisions.
- B. 5KV cables shall be single conductor, stranded, shielded, cross-linked polyethylene insulated, PVC jacketed, 133% insulation level, ungrounded.
- C. 5KV cables shall be as manufactured by Anixter, or approved equal.

2.05 5KV CABLE TERMINATIONS AND SPLICES

- A. Both ends of 5KV cables shall be terminated in accordance with IEEE Standard 48, Class 1.
- B. Terminations shall be of the preformed stress cone type, shall be approved by the cable manufacturer for use with his cable, and shall be as manufactured by Anixter, or approved equal.
- C. Unless otherwise shown or indicated on the Contract Drawing, no splices may be made in the 5KV cables without the prior written approval of the County.
- D. Where splicing is permitted, the splicing methods and materials shall be approved by the cable manufacturer for use with his cable and shall be as manufactured by Anixter, or approved equal.
- E. All 5KV cable terminations and splices shall be made by a qualified and certified high/medium voltage cable splicer whose qualifications shall be submitted to the County for approval before any work is begun.

PART 3 EXECUTION

3.01 INSTALLATION

- A. Wires and cables shall be sized as shown on the Contract Drawings and/or, where applicable, sized to match existing wiring.

- B. All conductors shall be carefully handled to avoid kinks or damage to the insulation.
- C. Lubricants or pulling compounds shall be used to facilitate wire pulling. Such lubricants/compounds shall be U.L. listed for use with the insulation specified.
- D. Use pulling means - fish-tape, cable, rope, basket weave wire/cable grips, etc. - which will not damage the wire/cable insulation or the raceway.
- E. Shielded instrumentation wire shall be installed from terminal to terminal with no splicing at any intermediate point.
- F. Shielded instrumentation wire shall be installed in rigid steel conduit and pull boxes that contain only instrumentation cables. Instrumentation cables shall be separated from control cables in manholes.
- G. Shielding on instrumentation cables shall be grounded at the transmitter end only.
- H. All new wires and cables shall be continuous and without splices between points of connection to equipment terminals. However, the County will permit a splice provided that the length between the connection points exceeds the greatest standard shipping length available from the submitted manufacturer and no other manufacturer acceptable to the County is able to furnish wires or cables of the required length.
- I. All 600 volt wire and cable connections shall be made using compression type connectors. Insulated connectors shall be used for all terminations. The connections shall be made so that both the conductivity and the insulation resistance shall be not less than that of the uncut conductor.
- J. All 5KV cable connections shall be made using approved terminators.
- K. 5KV cables exposed in manholes, vaults, pull boxes, switchgear and other areas where the cables are not protected by conduits shall be fireproofed using fireproof tape and/or glass tape in accordance with the manufacturer's recommendations and instructions. Fireproofing using asbestos tape shall not be used.
- L. All wires shall be numbered at both ends and at all intermediate junction points. Screw type terminations shall be made with forked tongue (spade), self-insulated, crimp terminals. All other wire terminations shall be made on appropriate terminal strips.

3.02 TESTS

- A. Upon the completion of the pulling-in of and prior to the terminating/connecting of the 600 Volt wiring, all wires shall be individually checked and tested for continuity and short circuits, and each wire/cable shall be meggered to check insulation resistance. The test voltage shall be not less than 500 Volts. Three (3) copies of these test results shall be submitted to the County.
- B. Similarly, the 5KV cables shall also be tested, except that a 15 minute test shall also be made using a DC voltage not less than 80% of that used for the factory tests. A plot of leakage current versus voltage shall be made and three (3) copies of the test results shall be submitted to the County.
- C. An authorized representative(s) of the County shall witness all testing. The County shall be notified at least two (2) days in advance of the testing.

- D. Any faulty conditions and/or shortcomings found during the testing shall be corrected at no cost to the County. However, a retest to demonstrate compliance shall be conducted before any hook-ups or terminations are made. Any such requisite retesting shall be witnessed by an authorized representative(s) of the County.

3.03 GUARANTEES AND WARRANTIES

- A. The Contractor shall guarantee and warrant all materials and labor provided under this Section in accordance with Section 01740 and Section 16050 of these Specifications.

END OF SECTION

SECTION 16150 MOTORS

PART 1 GENERAL

1.01 SCOPE OF WORK

- A. Furnish, install, connect and test all motors as hereinafter specified and/or shown on the Contract Drawings. This work may necessarily include furnishing/installing, connecting and testing motors required by and/or furnished under other sections of these Specifications.

1.02 SUBMITTALS

- A. The requirements of Section 01340 and Section 16050 shall be met.
- B. The Contractor shall submit to the County five (5) sets of the certified motor manufacturer(s) dimension drawings showing nameplate data and outline dimensions within three (3) weeks of receiving the order.
- C. The Contractor shall submit to the County five (5) sets of the standard motor manufacturer(s) test results (per 3.02 A) for the motors after they are constructed prior to the motors being shipped.

PART 2 PRODUCTS

2.01 RATING

- A. Motors shall be of the type and size to perform the required duty without exceeding their design ratings. Motors driving pumps shall not overload at any head or discharge condition of their respective pumps.
- B. Motors shall not be operated into their service factor range on a continuous basis as a means of supplying motors smaller than required by the specific applications.
- C. Unless otherwise specified and/or shown on the Contract Drawings, the following shall apply:
 - 1. Motors 200 HP and above shall be the medium voltage type for use at 4,160 Volts, 3-phase, 60 Hertz; motors smaller than 200 HP shall be the low voltage type. Where motors 100 HP and larger are used at 480 Volts, 3-phase, 60 Hertz, they shall be suitable for autotransformer type reduced voltage starting.
 - 2. Motors 1/2 HP through 100 HP shall be dual voltage for use at 230/460 Volts, 3-phase, 60 Hertz.
 - 3. Motors 125 HP through 199 HP shall be single voltage for use at 460 Volts, 3-phase, 60 Hertz.
 - 4. Motors smaller than 1/2 HP shall be dual voltage for use at 120/240 Volts, single phase, 60 Hertz.
- D. Use inverter duty motors with all adjustable speed drive systems. These motors shall be built with Class F or Class H insulation systems, designed to operate at 70 degrees C rise over ambient at full load, and be provided with insulated bearings. The drive system should always be located within 150 feet of the motor it is servicing.

2.02 POWER FACTOR CORRECTION CAPACITORS

- A. Motors 100 HP and larger shall be furnished with power factor correction capacitors. The capacitors shall be located in the motor controller. The motor manufacturer shall provide suitable capacitors to the motor controller manufacturer.
- B. Capacitors shall have both integral fuse protection and a discharge resistor. Capacitor current shall not exceed the motor no-load magnetizing current.
- C. Capacitor insulating media shall strictly conform to the requirements of the Environmental Protection Agency, particularly with regards to non-flammability and environmental safety.
- D. With power factor correction, motors shall have a minimum power factor of .95 at full load running conditions.

2.03 EFFICIENCY

- A. Medium voltage motors shall have a minimum efficiency of 95% at full load.
- B. Low voltage motors 15 HP and larger shall have a minimum efficiency of 93% at full load, 91% for TEFC motors.

2.04 SPACE HEATERS

- A. Motors 50 HP and larger shall have a 120 Volt, single phase space heater for moisture control. The space heaters shall be the motor manufacturer's standard wattage rating for the specific motor size and type.
- B. If a motor is on the job site longer than three (3) days prior to its final installation, the motor's space heater shall be energized and the space heater shall remain energized until such time as the motor is transported for immediate final installation.
- C. After final installation, the motor's space heater shall be energized and the space heater shall remain energized until final testing. After final testing, the motor's space heater shall be connected for normal operation.

2.05 CONSTRUCTION

- A. General
 - 1. All drip proof and weather protected Type I motors shall have epoxy encapsulated windings. Non-encapsulated motors used outdoors or in specified conditions shall be totally enclosed, TENV or TEFC as specified and/or shown on the Contract Drawings. Totally enclosed motors shall be designed for severe duty.
 - 2. Motor stators shall have copper windings. The individual steel stator laminations shall be made from quality at least as good as M22 silicon steel with a lamination thickness no greater than .019 inches. The stacking factor of the assembled stator core laminations shall be 90% or higher.
 - 3. Squirrel cage rotor laminations shall be made from steel with quality at least as good as M22 silicon steel with a lamination thickness no greater than .019 inches. The stacking factor of the assembled rotor core shall be 90% or higher.
 - 4. All applicable NEMA, ANSI, IEEE and U.L. standards will be strictly followed.
 - 5. Motors shall have factory stamped stainless steel nameplates.
 - 6. Motor frames 254T and larger shall have lifting lugs or "O" type bolts for ease in handling.

B. Medium Voltage Motors

1. Medium voltage motors shall be of the squirrel cage induction type, shall be NEMA Design B with normal starting torque, shall be rated 4,160 Volts, 3-phase, 60 Hertz, and shall have enclosures as specified and/or shown on the Contract Drawings.
2. The stator windings shall be epoxy encapsulated, Class B or better insulation, with a maximum stator winding temperature of 90EC by resistance above a 40EC ambient when operated continuously at 115% of rated horsepower, voltage and frequency. The insulation system shall comply with all applicable NEMA standards, including the conformance test of Bulletin MG-1, 20.48.
3. The stator windings shall be provided with six (6) resistance temperature detectors (RTD=s), two (2) per phase. The RTD=s shall be at least six inches long (where core stack length permits) and inserted approximately midway in the stator slot between the coil sides. The leads shall be brought to terminals in the low voltage terminal box and labeled according to their respective RTD. The motor manufacturer shall provide any necessary relays or hardware for the RTD=s to initiate an alarm or shut the motor down in the event the RTD=s have reached a predetermined set point temperature.
4. The motors shall be equipped with both space heaters and power factor correction capacitors per Item 2.04 and Item 2.02 above, respectively.
5. The motors shall have oil lubricated thrust bearings of the spherical roller or Kingsbury type as required by the application. Minimum bearing life, in conformance with AFBMA standards, shall be ten (10) years.
6. The bearings shall be provided with RTD's, the leads of which shall be brought to terminals in the low voltage terminal box. The motor manufacturer shall provide suitable relays to the motor controller manufacturer to mount in the motor controller.
7. Bearing housings shall be equipped with sight gauges, fillers and drain plugs.
8. The high voltage terminal box shall be of adequate size to accommodate the motor lead stress cones.
9. The low voltage terminal box shall contain a terminal strip for the leads of the space heaters, stator winding RTD's, and the bearing RTD's. All wiring shall be factory installed.
10. Lightning arrestors and surge capacitors shall be provided in the motor controller by the motor controller manufacturer specified in other sections of these Specifications.
11. Medium voltage motors shall be as manufactured by General Electric Company, U.S. Motor, Ideal Electric Company, or approved equal.

C. Low Voltage, 3-Phase Motors

1. Low voltage three phase motors shall be of the squirrel cage induction types, shall be NEMA Design B with normal starting torque unless otherwise specified, shall be designed for continuous duty, with a 1.15 service factor, shall have a KVA/HP as defined by NEMA of code G or less, shall be rated per Item 2.01.C.2 and C.3 above, and as specified and/or shown on the Contract Drawings, shall have normal or high thrust bearings, and a drip proof or totally enclosed housing.
2. Motors shall have a Class B nonhygroscopic insulation system. Class F insulation may be used, but shall be limited to a Class B temperature rise.
3. The output shafts shall be suitable for either belt drive or direct connection as required by the particular application.
4. Motor frames and end shields shall be made of heavy, rigid cast iron or fabricated steel construction.
5. Motor shafts shall be made from high-grade, cold-rolled steel machined to standard NEMA dimensions.

6. Motors shall have heavy-duty precision ball bearings with a minimum AFBMA bid life of five (5) years. Bearings of high thrust motors shall be locked for a momentary upthrust of 30% downthrust.
7. Vertical hollow shaft motors shall have non-reversing ratchets to prevent backspin.
8. Totally enclosed motors shall have epoxy coated motor windings.
9. Motor conduit boxes shall be gasketed. Internal motor leads shall enter the conduit boxes through grommets.
10. All interior and exterior motor surfaces shall have a final coating of a chemically resistant corrosion and fungus protective epoxy fortified enamel finish sprayed over two (2) coats of a red primer. Stator bore and rotor shall be epoxy coated.
11. All machined surfaces shall be coated with a rust inhibitor for easy disassembly.
12. All fittings, bolts, nuts and screws shall be plated to resist corrosion. Bolts and nuts shall be hex type.
13. Low voltage, 3-phase motors shall be as manufactured by General Electric Company, U.S. Motors, or approved equal.

D. Low Voltage, Single Phase Motors

1. Single phase motors shall be either the split-phase or the capacitor-start induction types rated for the continuous horsepower at the RPM specified and/or shown on the Contract Drawings.
2. Motors shall be rated 120/240 Volts, single phase, 60 Hertz, shall have a NEMA Class B insulation system, and shall have a dripproof or totally enclosed housing as required by the particular application.
3. Motors shall have a corrosion protective finish on all internal and external surfaces. All fittings shall have a corrosion resistant plating.
4. Mechanical characteristics shall be the same as those specified above for low voltage, 3-phase motors.
5. Low voltage, single phase motors shall be as manufactured by U.S. Motors, Baldor, or approved equal.

E. D. C. Motors

1. D. C. motors shall be of the size, type, rating, duty and construction as specified and/or shown on the Contract Drawings.
2. D. C. motors shall be as manufactured by U.S. Motors, Baldor, or approved equal.

PART 3 EXECUTION

3.01 INSTALLATION

- A. Unless otherwise specified and/or shown on the Contract Drawings, all motors shall be connected to the conduit system with a short section of flexible conduit, 18-inches minimum and 60-inches maximum.
- B. Flexible conduit used for motor connections of No. 6 AWG or smaller wire shall have an approved grounding conductor incorporated inside the flexible section.
- C. For motor connections of No. 4 AWG and larger wire, the Contractor shall install an appropriately sized grounding conductor in the conduit and terminate the grounding conductor at both the motor end and the motor controller end with approved grounding clamps or connectors.

3.02 TESTS

- A. Prior to shipment, all motors shall be given the manufacturer's standard tests. These tests shall include, but not necessarily be limited to, the following:
1. No-Load current.
 2. Air gap measurement.
 3. High potential test.
 4. Shaft alignment.
 5. Shaft and rotor balance.
 6. Bearing alignment and lubrication.
- B. After installation, but prior to putting the motors into service, the Contractor shall perform the following minimum checks:
1. Motor alignment.
 2. Motor clearances.
 3. Bearing alignment and lubrication.
 4. Correct rotation direction.
 5. Megger motor windings. If insulation resistance is found to be low, the Contractor shall notify the County immediately and shall not energize the motor.

3.03 GUARANTEES AND WARRANTIES

- A. The Contractor shall guarantee and warrant all materials and labor provided under this Section in accordance with Section 01740 and Section 16050 of these Specifications.

END OF SECTION

SECTION 16152 INVERTER DUTY MOTORS

PART 1 GENERAL

1.01 SCOPE OF WORK

- A. Furnish and factory test two (2) inverter duty motors of the sizes and types hereinafter specified.

1.02 MANUFACTURER'S QUALIFICATIONS

- A. The motors shall be the products of a single manufacturer who has a minimum provable history of three (3) years in the manufacturing and servicing of inverter duty motors of the sizes and types hereinafter specified.

1.03 APPLICATION

- A. The motors will each be used to power a variable torque load consisting of a centrifugal pump in wastewater effluent pumping service.

1.04 OPERATING CONDITIONS

- A. The motors shall be able to operate under the following environmental conditions without modification or derating:
 - 1. Temperature: 0 to 40°C.
 - 2. Altitude: Up to 3,300' above sea level.
 - 3. Humidity: 0 to 95%, non-condensing.

1.05 MOTOR TESTING

- A. Prior to shipment, the motors shall be subjected to the manufacturer's standard tests. The tests shall include, but not necessarily be limited to, the following:
 - 1. No-load current.
 - 2. Air gap measurement.
 - 3. High potential test.
 - 4. Shaft alignment.
 - 5. Shaft and rotor balance.
 - 6. Bearing alignment and lubrication.
- B. The manufacturer shall certify that the motors are an improved design meeting the requirements of NEMA MG 1, Part 31 for motor insulation systems - i.e., a peak voltage of 1600 V and a time rise of 0.1 microsecond; specifically, motors that do not meet both the peak voltage level and the time rise limitation will not be acceptable under this Specification.

1.06 APPROVED EQUAL

- A. The County shall be the sole determiner of what constitutes an "approved equal" product.

1.07 SUBMITTALS

- A. Within three (3) weeks of receiving the order and prior to start of fabrication of the motors, the motor manufacturer shall furnish the County with five (5) sets of motor drawings for review and approval. The results of the manufacturer's standard post-manufacturing test results (per 3.01 A) for the motors shall be submitted prior to shipment.
- B. The motor drawings shall include, but not necessarily be limited to, motor nameplate data, motor mounting base dimensions, motor dimensions and weight, and the location and size of both the motor leads terminal box and the low voltage leads terminal box. Information shall be sufficiently detailed to allow for locating conduit stub-ups.
- C. Failure to comply with Item 1.07A above shall be entirely at the manufacturer's risk. Any changes required as a result of the County's review will be solely at the manufacturer's expense with no cost to the County.

1.08 WARRANTY

- A. The manufacturer shall warrant that the motors shall be free from defects in all materials and workmanship for a period of two (2) years from date of final acceptance, or for the duration of the manufacturer's standard warranty, whichever period is longer.
- B. During the warranty period, any and all covered defects shall be corrected by the manufacturer solely at his own expense with no cost to the County.

PART 2 PRODUCTS

2.01 INVERTER DUTY MOTORS

A. GENERAL

1. The motors shall be of the type and size to perform the required duty without exceeding their design ratings. The motors shall not overload at any head or discharge condition of their respective pumps.
2. The motors shall be suitable for use on a 480 Volt, 3-phase, 60 Hz power system.
3. The motors shall have a 1.15 service factor. The motors shall not be operated into their service factor range on a continuous basis as a means of supplying motors smaller than that required by the specific applications.
4. The motors shall have a minimum efficiency of 93% at full load.
5. The motors shall each be equipped with a 120 Volt, single phase space heater for moisture control. The space heaters shall be the motor manufacturer's standard wattage rating for the size and type of motors actually furnished.
6. The motors shall have minimum power factors of 93% at full load and 95% when partially loaded. The motor manufacturer shall furnish the required power factor correction packages (capacitors, fuses, discharge resistors, etc.) to the County for installation in the motor controller enclosures. Capacitor currents shall not exceed the no-load magnetizing currents of the motors. The capacitor insulating media shall strictly conform to the requirements of the Environmental Protection Agency, particularly with regard to non-flammability and environmental safety.

B. CONSTRUCTION

1. The motors shall be NEMA B, vertical types specifically designed and fabricated for AC inverter usage (PWM type) and adjustable speed applications. Motors which must be used with one particular brand of inverter to achieve compliance will not be acceptable

under this Specification.

2. The motors will be coupled to centrifugal pumps which will be used to pump a liquid consisting of wastewater effluent having a specific gravity of 1.0 at a nominal ambient temperature of 76EF.
3. The motors shall be a normal torque, low slip design.
4. One motor shall be rated 150 HP at 1800 RPM and will drive a centrifugal pump with a maximum output of 2600 GPM against a TDH of 154'. The other motor shall be rated 300 HP at 1200 RPM and will drive a centrifugal pump with a maximum output of 4000 GPM against a TDH of 223'.
5. All applicable NEMA, ANSI, IEEE, and U.L. standards and procedures shall be strictly followed in the design and fabrication of the motors. The motors shall be U.L. listed.
6. The motors shall have insulation systems designed to meet the voltage spike limits as defined in NEMA MG 1, Part 31, 1993. Complete insulation of the slot, cell, and phase groups is required. The insulation systems shall be rated for Class F temperature rise or better. Insulation systems utilizing heavy film and two film wire with a Pulse Endurance Index of less than 50 will not be acceptable under this Specification.
7. The motor windings shall be epoxy encapsuled and shall utilize copper wires. Aluminum motor windings will not be acceptable under this Specification.
8. The motors shall be furnished with TEFC enclosures designed for severe/corrosion duty. Motor enclosures shall be fabricated of cast iron or rolled steel and shall be provided with a condensate drain hole. Aluminum motor enclosures will not be acceptable under this Specification.
9. The squirrel cage rotors shall be made from high grade steel laminations tightly fastened together and securely affixed to the motor shaft. Steel bar type construction with steel ends rings is also acceptable. Aluminum rotors of any type will not be acceptable under this Specification.
10. The stator cores shall be made from high grade steel and shall utilize reinforced end turn construction for high rigidity, minimum winding mechanical fatigue, and low resonant noise level. Aluminum stator will not be acceptable under this Specification.
11. The stator windings shall be provided with six (6) resistance temperature detectors (RTD's), two (2) per phase. The leads of the highest reading detector as determined by factory test shall be brought to terminals in the low voltage terminal box. The motor manufacturer shall provide suitable relays to the County for mounting in the motor controller enclosures.
12. The temperature rise of the motors shall not exceed Class F insulation limits, with an allowable winding hot spot temperature of 115EC when operated on inverter power across the motors' nameplate speed and torque envelope. Sine wave temperature rise shall be Class F or better.
13. The motors shall be equipped with both space heaters and power factor correction capacitors per Item 2.01.A.5 and Item 2.01.A.6 above, respectively.

14. The motors shall be fitted with oil lubricated high thrust bearings of the type (spherical roller, ball or Kingsbury) required by the specific application. The bearings shall be locked for a momentary upthrust of 30% downthrust. Minimum bearing life shall be five (5) years as determined in accordance with AFBMA standards.
15. The bearings shall be provided with RTD's, the leads of which shall be brought to terminals in the low voltage terminal box. The motor manufacturer shall provide suitable relays to the County for mounting in the motor controller enclosures.
16. Bearing housings shall be equipped with sight gauges, fillers, and drain plugs.
17. The motors shall be equipped with two (2) gasketed conduit boxes - a high voltage terminal box of adequate size to accommodate the motor leads and a low voltage terminal box with a terminal strip for the leads of the space heaters, the stator winding RTD's, and the bearing RTD's. The wiring, which shall be factory installed and tested, shall enter the terminal boxes through grommets.
18. The motor shafts shall be solid (150 HP) or hollow (300 HP) vertical types, shall be fabricated from stainless steel, shall have standard NEMA dimensions, shall have non-reversing ratchets to prevent backspin, and shall be suitable for direct coupling to the driven pumps. The motor manufacturer shall furnish to the County suitable couplings of the bolted type (150 HP) and the screw (threaded) type (300 HP) to couple the motors with their respective pumps.
19. The motors shall be furnished with permanently attached stainless steel nameplates containing the requisite NEC, NEMA data. In addition, the motor manufacturer shall expand his standard nameplate or add an additional permanently attached stainless steel data plate containing, as a minimum, the following adjustable speed performance information:
 - a. Application Type - Variable Torque.
 - b. Maximum approved continuous torque.
 - c. Approved speed (RPM) range.
 - d. Approved frequency (Hz) range.
 - e. Motor full load current (Amps) on inverter power.
20. All fittings, bolts, nuts, and screws shall be plated to resist corrosion. Bolts and nuts shall be Hex type.
21. The motor frames shall have lifting lugs or "O" type bolts for ease in handling.
22. All interior and exterior motor surfaces shall have a final coating of a chemically resistant corrosion and fungus protective epoxy fortified enamel finish sprayed over two (2) coats of a red primer. The stator core and the rotor shall be epoxy coated.
23. All machined surfaces shall be coated with a rust inhibitor for easy disassembly.
24. The motors shall be "Inverter Grade" products as manufactured by U.S. Electrical Motors, or approved equal.

PART 3 EXECUTION

3.01 FACTORY TESTING

- A. Prior to shipment, the motors shall be tested in accordance with Item 1.05.A above.
- B. After successfully completing the tests of Item 3.01.A above, the motors shall be tested and evaluated on inverter power over the approved speed range. Computer simulation of motor inverter operation is an acceptable alternative to actually connecting the motors to an inverter.
- C. During the testing, the major motor parameters shall be recorded and the test results shall be forwarded to the County for review and approval prior to shipment of the motors.

3.02 SHIPPING

- A. The motors shall be so packaged for shipment that they are maximally protected from both physical and environmental damage.
- B. The motors shall be transported to the County's job sites utilizing the manufacturer's customary method of shipment.

3.03 INSTALLATION

- A. The motors shall be installed by the County's personnel in accordance with the recommendations and procedures set forth in the installation manuals furnished by the manufacturer.
- B. An authorized factory trained representative(s) of the manufacturer shall be available to assist the County's personnel on an "as needed" basis.

3.04 WARRANTY

- A. The manufacturer shall furnish to the County a written warranty which complies with the requirements of Item 1.08 above.

END OF SECTION

SECTION 16160 PANELBOARDS

PART 1 GENERAL

1.01 SCOPE OF WORK

- A. Furnish all labor, materials, equipment, devices, and incidentals required and install all panelboards as hereinafter specified and/or as shown on the Contract Drawings.

1.02 SUBMITTALS

- A. The requirements of Section 01340 and Section 16050 shall be met.

PART 2 PRODUCTS

2.01 RATING

- A. All panelboards shall be rated for the intended voltage. Panelboard ratings shall be as shown on the Contract Drawings.
- B. Panelboards shall be U.L. listed.

2.03 CONSTRUCTION

A. Interiors

1. Interiors shall be completely factory assembled with main breakers, bus bars, branch circuit breakers, wire connectors, etc.
2. All wire connectors, except screw terminals, shall be of the anti-turn solderless type.
3. All wire connectors shall be suitable for use with copper wires of the size(s) indicated on the Contract Drawings.
4. Branch circuits shall be arranged using double row construction except where narrow column panels are called for on the Contract Drawings.
5. Branch circuits shall be numbered by the panelboard manufacturer.
6. Interiors shall be so designed that circuits may be changed without machining, drilling or tapping; without disturbing adjacent units; and without removing the main bus connectors.
7. Interiors shall be durably marked by the manufacturer with the voltage, current rating and number of phases for which the panelboards are designed. The markings, which shall be visible after installation without disturbing the interior parts or wiring, shall also include the manufacturer's name or trademark.
8. All current carrying parts, including cross connectors, shall be copper.

B. Bus Bars

1. The bus bars for the mains shall be sized as shown on the Contract Drawings.
2. Both a full-capacity neutral bus and a separate ground bus shall be provided. Neutral bus bars shall have a suitable lug for each outgoing feeder requiring a neutral connection.
3. Phase bus bars shall be full height without reduction.
4. Bus bar taps for panelboards with single pole branches shall be arranged for sequence phasing of the branch circuit devices.
5. Bus bars shall be braced to conform to industry standards for short circuit stresses in

panelboards.

C. Circuit Breakers

1. The panelboards shall be equipped with circuit breakers, main and branch, with trip settings as shown on the Contract Drawings.
2. The circuit breakers shall be of the molded case, bolt-on type with the number of poles as shown on the Contract Drawings.
3. Circuit breakers used in 120/240 Volt and 120/208 Volt panelboards shall have a minimum interrupting rating of 10,000 Amperes RMS symmetrical.
4. Three-pole circuit breakers used in 480 Volt panelboards shall have a minimum interrupting rating of 14,000 Amperes RMS symmetrical.

D. GFCI (Ground Fault Circuit Interrupter)

1. GFCI units shall be provided for all circuits where shown on the Contract Drawings.
2. The GFCI units shall be 1-pole, 120 Volt, molded case, bolt-on circuit breakers incorporating a solid state ground fault interrupter circuit which shall be insulated and isolated from the breaker mechanism.
3. The GFCI units shall be U.L. listed Class A, Group I devices (5 milliamp sensitivity, 25 millisecond trip time), and shall have an interrupting capacity of 10,000 Amperes RMS symmetrical.

E. Enclosures, Covers and Trim

1. The enclosures shall be of the NEMA Type (1, 3R, 4, 4X, 12), material (code gauge steel, stainless steel, fiberglass), and mounting configuration (flush, surface) as shown on the Contract Drawings.
2. Enclosures shall be of sufficient size to provide a minimum 4-inch gutter space on all sides. At least four (4) interior mounting studs shall be provided for each enclosure. Enclosures shall be furnished without conduit knockouts. Enclosures shall have hinged doors which cover all circuit breaker handles.
3. Stainless steel enclosures and covers shall have a natural metal finish. Enclosures and covers shall be joined together with a concealed piano type stainless steel hinge. Conduit openings in the enclosures shall be field drilled and, if applicable, tapped.
4. Fiberglass enclosures and covers shall be the manufacturer's standard color. Enclosures and covers shall be joined together with a concealed piano type stainless steel hinge. Conduit openings in the enclosures shall be field drilled and, if applicable, tapped.
5. Code gauge steel enclosures and covers shall be galvanized steel finished as per Item 2.03.E.7 below. Enclosures and covers shall be joined together with a concealed piano type hinge. Conduit openings in the enclosures shall be field punched.
6. Code gauge steel enclosures shall have panel trims of code gauge sheet steel. Trims for flush mounted enclosures shall overlap the enclosures by at least 3/4-inch all around. Surface mounted enclosures shall have trims the same height and width as the enclosures. Trims shall be fastened to the enclosures with quarter-turn clamps or screws.
7. All interior and exterior surfaces of the panelboards, enclosures and trims shall be properly cleaned, painted with a rust inhibitor (two coats), and over-coated with ANSI Z55.1, No. 61 light gray paint. The finish paint shall be of a type to which field applied paint will adhere.
8. The inside surface of each cover shall have a directory frame with a transparent cover and a directory card.

9. Covers shall have semi-flush type cylinder locks and catches, except that covers over 48-inches in height shall have vault handles and 3-point catches, complete with lock, arranged to fasten at top, bottom and center. Two (2) keys shall be furnished for each lock and all locks shall be keyed alike.

F. Manufacturer

1. 120/240 Volt and 120/208 Volt panelboards shall be type NQOD with QOB bolt-on circuit breakers as manufactured by the Square "D" Company, or approved equal.
2. 480 Volt panelboards shall be the I-Line type as manufactured by the Square "D" Company, or approved equal.

PART 3 EXECUTION

3.01 INSTALLATION

- A. Surface mounted panelboards shall be installed using spacers so that there is an air space between the enclosure and the mounting surface.
- B. Unless otherwise shown on the Contract Drawings, the tops of the enclosures shall be mounted at a height of 6-feet above the floor. The enclosures shall be properly aligned, true-and-square, and shall be adequately supported independently of the connecting conduits.
- C. All panelboard wiring shall be neatly formed, grouped, laced, and identified to provide a neat and orderly appearance.
- D. The Contractor shall type on the directory card the description/use of each active circuit. "Spare" shall be indicated in erasable pencil!

3.02 TESTS

- A. Each individual circuit breaker, including the main breaker and the GFCI breaker(s), shall be tested for proper operation under the appropriate overload/ground fault conditions.

3.03 GUARANTEES AND WARRANTIES

- A. The Contractor shall guarantee and warrant all materials and labor provided under this Section in accordance with Section 01740 and Section 16050 of these Specifications.

END OF SECTION

SECTION 16231 EMERGENCY GENERATOR SET

PART 1 GENERAL

1.01 SCOPE

- A. Provide and install complete and operable UL 2200 listed emergency/standby electric generating systems which contain all the devices and equipment specified herein and/or required for the service. Equipment shall be new, factory and field tested, installed, and ready for operation. Timely service and reliability after the installation is accepted are critical in the choice of equipment.
- B. The engine is to be of sufficient horsepower to drive the generator under full load conditions. It shall be 4-cycle, fueled with a diesel sub-base fuel tank and cooled with a closed looped radiator system. The generator is to be a low reactance brushless generator, with torque matched excitation and automatic voltage regulation. There is to be a set-mounted control panel with vibration insulators between it and the generator set. The generator, controls and associated cooling and exhaust systems are to be housed in a suitable weather protected enclosure which is to be permanently installed outdoors. The automatic transfer switch shall be installed in a separate NEMA 4X SS secure (double door) enclosure.
- C. Where conflict between drawings, specifications or code occurs, the Contractor shall assume and provide the more stringent of the alternatives to the County.
- D. Contractor shall secure all required building permits including the electrical, concrete and fire department reviews. Contractor to provide all required drawings and certifications required to secure these permits. If indicated below, contractor will also provide Flood Certification.

1.02 RATINGS

- A. Generator set at site number 1 is to be installed at:

_____, Florida

This generator set is to be of suitable power to drive a total of ___ submersible ___ volt, ___ horsepower induction motor pumps, the current main breaker for the station is: _____. This site shall be fueled by a diesel sub-base fuel tank. ATS manual by-pass switch is ___ / is not ___ required at this site. This site is ___ / is not ___ in a flood zone and flood certification is ___ / is not ___ required. The color of the generator set powder coating shall be similar to “Buff” / Pantone Green 5545 C. The color of the fuel tank and skid shall be “haze grey”.

PLEASE NOTE : The induction pump motors providing the loads at the above sites all have the following characteristics and the generator sets supplied with this contract are to be built and sized bearing these facts in mind:

- 1. NEMA LRA Code H
- 2. Started with full voltage starters-maximum allowable voltage dip at start is 20%-loading will be sequential, (i.e., after each pump is brought up to speed the next one

- will be started)
- 3. 240 or 480 VAC (as required in the above sites)
- 4. 3 Phase
- 5. 60 HZ.

ALSO: Each generator is to be built with the following characteristics/conditions:

- 1. Generator sized as a sequence load.
- 2. Standby Emergency Rating
- 3. Power Factor = .8
- 4. Site Altitude = 100 feet
- 5. Range of Site Ambient Temperatures = 20 - 120° F.

1.03 GENERATOR SET PERFORMANCE

- A. The voltage regulation of each set shall be $\pm .5\%$ of rated voltage for any constant load from the range of no load to full rated load.
- B. The frequency regulation of each set shall be accomplished through an isochronous electronic governor from the range of steady state no load to steady state full rated load.

1.04 SUPPLIER

- A. The complete package - engine, generator and other auxiliary components shall be provided from a single manufacturer/supplier. Other required items such as the enclosure, fuel tank, and automatic transfer switching equipment manufactured by others shall all be packaged together before delivery by the manufacturer / supplier. The supplier shall be the manufacturer's authorized distributor who shall maintain a service center capable of emergency maintenance and repairs with a consistent record of a maximum of four hours response time. The supplier shall have 24 hour/365 days per year service availability and factory trained service technicians authorized and capable to perform warranty service on all warrantable products.

1.05 SUBMITTALS

- A. Prior to and a requirement of contract award, the apparent low bidder shall provide references from at least 3 local municipalities or other businesses that have at least 5 similar type emergency generators in service with response time requirements similar to this contract. The actual service responses will be verified for response time consistency and customer satisfaction.
- B. As a minimum for all equipment specified and provided, for each site, submit the following in pdf format to Manatee County. No equipment is to be ordered until the submittal is approved:
 - 1. Specification and application data sheets for the entire system supplied.
 - 2. Supporting calculations and/or documentation signed and sealed by a Professional Engineer licensed in the State of Florida in support of the proposed pump capacity, reinforced concrete pad design, concrete anchors, and 160 mph wind load calculations in support of the concrete pad design and concrete anchors.
 - 3. Shop drawings showing a dimensioned outline plan and elevation views of the system with certified overall and interconnection point dimensions. Indicate

fabrication details, dimensions, weights, loads, required clearances, components, location and size of each field connection and method of field assembly.

4. Manufacturer's installation instructions.
 5. Interconnection wiring and piping diagrams which show all external connections required. Show field wiring terminals with markings in a consistent point to point manner.
 6. Manufacturer's certification of prototype testing which show evidence of compliance with specified requirement.
 7. Manufacturer's applicable published warranty documents.
 8. Shop drawings of the enclosure indicating basic layout, materials, and color. A color swatch shall be submitted for review.
- C. Prior to the County's acceptance of generator site(s), the Contractor shall submit the following for each generator site(s):
1. Generator field test results showing compliance with the specifications.
 2. Signed and sealed final record site plan prepared by a Professional Surveyor registered in the State of Florida showing all existing and new above ground facilities / improvements, new underground conduit and fuel line locations, and property corners. A CAD file of the project survey can be requested from the County, if available.

The following information shall be provided on the final record site plans:

| | |
|---------------------------|--|
| Location in X & Y | ATS, natural gas meter (if applicable) |
| Location in X, Y & Z | Egen slab, fuel tank slab (if separate from Egen slab), all new underground pipes and conduits |
| Location in Z (elevation) | top of fuel tank, bottom of ATS, bottom of Egen (if not on top of a fuel tank) |
| Call outs | Egen size in KW, conduit size, fuel tank size in gallons (if applicable) |

- C. A single O&M manual shall be provided that covers all parts of the generator system and controls for all installations contained in this contract. It shall be tabbed for each different size or type of equipment. The cover page shall indicate the manufacturer, date and contract number as well as listing all pump station sites it applies to.

1.06 WARRANTY

- A. A comprehensive, no deductible warranty shall be supplied for the complete electrical power system (the generator set, controls and associated switches, switchgear, automatic transfer switch and all accessories) supplied for each installation. The complete systems shall be warranted by the manufacturer against defects in materials and workmanship for a period of five years or 1500 hours of operation; whichever occurs first from the date of system startup. This warranty coverage shall include parts, labor, and travel expenses.
- B. The warranty of the coating of the enclosure and fuel tank shall be a non-deductible,

unlimited warranty against rust and corrosion of any coated part of the enclosure for a period of ten years.

PART 2 PRODUCTS - AT EACH SITE:

2.01 EMERGENCY GENERATOR

- A. Each generator shall be:
1. Used for 60 Hz Operation, 240 Volt or 460 Volt output voltage
 2. 4- Pole - 1800 RPM - Revolving Field Synchronous Machine
 3. Stator Winding to be .667 Pitch
 4. Air Cooled by Shaft Mounted Fans
 5. 12 Leads for Output Connections
 6. Class H Insulation System
 7. Temperature Rise by Resistance not to Exceed 125° C at Full Load
 8. The stator shall have vacuum impregnated windings with fungus resistant epoxy varnish.
- B. Utilize a permanent magnet generator for excitation power to an automatic voltage regulator. The permanent magnet generator shall sustain main field excitation power for optimum motor starting and to sustain short circuit current for selective operation and coordination of system over current devices.
- C. The automatic voltage regulator shall be a temperature compensated solid state design. It shall be equipped with 3-phase RMS sensing. The regulator shall control buildup of AC generator voltage to provide a linear rise and limit overshoot. The regulator shall include an under frequency rolloff torque-matching characteristic which shall reduce output voltage in proportion to frequency below a threshold of 58 hz. The torque matching characteristic shall include differential rate of frequency change compensation to use maximum available engine torque and provide optimal transient load response. Regulators which use a fixed voltage per hz. characteristic are not acceptable.
- D. Provide a generator main circuit breaker. This breaker is to be set mounted and wired, molded case thermal-magnetic rated for proper generator set operation. The breaker shall be UL listed. Field circuit breaker shall not be acceptable for the purpose of generator overcurrent protection. The generator circuit breaker shall incorporate:
1. Tripping characteristic: designed specifically for generator protection.
 2. Trip rating is to be matched to generator rating.
 3. Shunt Trip: Connected to trip breaker when generator set is shut down by other protective devices.
 4. Mounting Position: Adjacent to or integrated with control and monitoring panel.
- E. Provide a microprocessor-based unit that will continuously monitor current level in each phase of generator output. When signaled by the protector or other generator set protective device, a shunt-trip device in the generator disconnect switch shall open the switch to disconnect the generator from the load circuits. This microprocessor-based unit shall also:
1. Initiate a generator overload alarm when the generator has operated at an overload equal to 110% of full load for 60 seconds.
 2. Under single or three phase fault conditions, it shall regulate the generator to 300% or rated full load current for up to 10 seconds.

3. When the heating effect of overcurrent on the generator approaches the thermal damage point of the unit, the processor shall switch the excitation system off and open the generator disconnect switch to shut the generator down.
 4. Sense the clearing of a fault by other overcurrent devices and control the recovery of the rated voltage to avoid overshoot.
- F. Leads for water jacket heaters and space heaters shall be housed in their own separate conduit box.
- G. Provide alternator strip heater or thermostatically controlled space heater(s) per manufacturer's recommendation to keep moisture out of the windings.

2.02 INSTRUMENTATION AND CONTROL

- A. Each generator set is to be capable of being started and shutdown through an automatic transfer switch or manually.
- B. Manually, the control shall have automatic remote start capability from a panel mounted three position (Stop, Run, Remote) switch. When the control panel is selected to the "Run" position, the generator set starts and runs. When selected to the "Stop" position, a shutdown is initiated. The "Remote" position allows the set to be operated from a remote location.
- C. An emergency stop button will also be installed to shut the system down. This button should be red, a minimum of two inches in diameter, labeled "STOP" and installed in a conspicuous location on the generator set. It shall be reusable and resettable.
- D. The control shall shut down and lock out upon: failing to start (overcrank), overspeed, low engine oil pressure, high engine coolant temperature, or operation of a remote manual stop station. A panel mounted switch shall reset the engine monitor and test all the lamps. Lamp indications on the control panel shall include as a minimum:
1. Overcrank Shutdown - Red
 2. Overspeed Shutdown - Red
 3. High Coolant Temperature - Red
 4. Low Engine Oil Pressure - Red
 5. High Engine Coolant Temperature Prealarm - Yellow
 6. Low Engine Oil Pressure Prealarm - Yellow
 7. Low Fuel - Yellow
 8. Run - Green
- E. Each generator set is to be set up by the manufacturer to indicate to a remote location through the County's RTU system:
1. When generator set is in operation.
 2. When generator fails (no commercial or generator power).
 3. When low fuel level is reached in the fuel tank.

The contractor shall install four wires from the generator control panel to the existing RTU control panel; wire type shall be 16 AWG, 16 strand flexing type MTW or TFFN 600 volt. The County's RTU system uses discrete- type signals with N/O type contacts. County shall make the actual connections to the RTU system.

The wire coloring scheme shall be:

- Brown - generator run
- Red - generator fail
- Yellow- low fuel/low pressure (natural gas)
- Orange- common to alarms and connected to control panel power either 24 volt DC or AC

F. Regulation of NFPA 110 Level 2 shall apply for instrumentation, alarm and shutdown. The instrument panel shall include, but not necessarily be limited to:

1. Gages for engine: with $\pm 2\%$ full scale accuracy:
 - a. Oil Pressure
 - b. Engine Coolant Temperature
 - c. Voltmeter for the DC Battery
2. Gages for generator: with $\pm 2\%$ full scale accuracy:
 - a. AC Ammeter - dual range
 - b. AC Volt Meter - dual range
 - c. Frequency Meter - range of 45-65 Hz.
3. Elapsed Time Meter
4. 0-3000 RPM Tachometer - with $\pm 2\%$ full scale accuracy.
5. A seven position phase selector switch with "OFF" position to show meter display of current and voltage of each generator phase. This selector switch may be manual or push-button.
6. A power source with circuit protection - 12 or 24 VDC.
7. An AC interlock to prevent starter re-engagement with engine running.
8. DC circuit protection.
9. A minimum of two panel lamps to illuminate instrument panel.

G. Switches and Controls

1. Rheostat for adjusting output voltage of the generator to $\pm 5\%$ of nominal voltage.
2. Over voltage protection shutdown switch.
3. Emergency stop switch mounted on control panel.
4. Engine start switch - with Run, Off, Reset, Automatic positions.
5. Five minute engine cool down timer.
6. Cyclic cranking switch.

H. All electrical penetrations in any enclosure shall be properly sealed from the weather.

I. Primary power disconnect switch on the LS control panel shall be identified with an NFPA compliant Main Disconnect label.

2.03 ENCLOSURE

A. The generator set and all the equipment supplied in this contract, shall be operated in a stationary outdoor environment. At each site, it shall:

1. Require weather protected enclosures. These enclosures shall protect the unit and all equipment and devices from the elements of the weather to include rain and winds.
2. The enclosure shall meet all federal, state, and local regulations.
3. All enclosures, boxes, trays, etc shall have weep holes for condensation or water

intrusion drainage. Any oil containment / catchment areas shall have provision to completely drain off water. The enclosure shall provide adequate ventilation for cooling and operation under full load conditions.

4. The enclosure shall be constructed of aluminum with a minimum 4 gauge thickness. The enclosure shall have an electrostatically applied, baked on, powder coated enamel or polyester finish a minimum of 2.5 mil thick. The color of the powder coating shall be similar to "Buff" or Pantone Green 5545 C, as noted on the drawings, and must be approved by Manatee County prior to installation of the product.
5. The housing shall have hinged side access doors and a rear control door that are easy to remove. The side panels shall be easy to remove to allow access to all areas of the pump. All doors shall be secured by lockable handles as provided by the manufacturer or at a minimum with padlock hasps, so the County can install a standard padlocks.
6. All exterior assembly hardware, bolts and/or screws, handles, hinges, and hasps shall be 316 stainless steel. All exterior bolts and/or screws shall be tamper-proof. All tamper-proof screws shall utilize the 6 lobe pin TX or Torx® pin-head security fasteners. A neoprene washer shall be installed between all bolts/nuts/washers and the enclosure's exterior finish.
7. The housing shall be factory assembled to the generator set skid base. The skid base shall be firmly fastened to a concrete foundation pad which is to be provided and installed as part of this contract. The connections shall be adequate to avoid movement from both wind and vibration loading. The skid base / framing surface protection coating shall be per the fuel tank coating requirements. All metal surfaces coming in contact with concrete or grout shall be coated with coal tar epoxy equal to Koppers 300M or a 1/32-inch neoprene gasket between the metal surface(s) and the concrete or masonry may also be used. The neoprene gasket shall be installed along the entire perimeter, not just at the fastening hardware.
8. The engine and generator shall be removable from the base for maintenance purposes.
9. The skid is to have adequate strength and rigidity to maintain alignment of mounted components without depending on the concrete foundation. Lifting attachments shall be arranged to facilitate lifting with slings without damaging any components.
10. The base shall incorporate a battery tray with battery hold down clamps within the rails. Provisions for stub up of electrical conduits shall be within the footprint of the set. Vibration isolation shall be integral between the generator set and base.
11. The enclosure shall be a low noise or sound attenuated enclosure. The noise level at any load operating condition, in any direction from the enclosure, shall not exceed 75 dBA at a distance of five (5) meters from the enclosure unless noted otherwise on the plans

2.04 ENGINE

- A. The engine shall be a 4-cycle, direct injection diesel (or carbureted natural gas) with forged steel crankshaft and connecting rods suitable for continuous operation. It shall be designed for stationary applications and shall be complete with all necessary auxiliaries needed for operation of the AC generator. The engine block shall be cast iron construction.
- B. The engine shall have an electronic governor which shall provide isochronous frequency regulation.

- C. The engine shall have an electric starter and battery(ies). See the Starting System section for further details.
- D. The engine shall have a mechanical, positive displacement, engine driven, lubrication oil pump. Provide full flow lubrication oil filters with replacement spin-on canister elements. Provide a dipstick for oil level indication and an easily accessible fill location.
- E. Supply a replaceable dry element air cleaner with restriction indicator.
- F. Provide an engine mounted thermostatically controlled water jacket heater. The heater(s) wattage size shall be determined by the manufacturer. The heater voltage shall be single phase, 120V, 60HZ.

2.04.1 STARTING SYSTEM - ENGINE

- A. The battery(ies) used for cranking the engine shall be the lead acid type, 12 or 24 volt, sized as recommended by the generator manufacturer. The battery(ies) shall have sufficient capacity to crank the engine for at least three cycles of 15 seconds on - 15 seconds off, for a total of 75 seconds. They shall be provided as new with the entire manufacturer's warranty.
- B. The battery(ies) shall be fastened securely in its(their) own tray within the foot print of the skid. The tray shall be acid resistant.
- C. Include all interconnecting conductors and connection accessories.
- D. A battery charger of appropriate rating which is voltage regulated, shall be provided for the engine. It shall be sized for the proper current, input AC voltage and output DC voltage. The charger shall be equipped with float, taper and equalize charge settings.
- E. A meter on the charger shall provide a visual output reading of the charger.
- F. On the engine, provide a factory mounted alternator with solid state voltage regulation and 35 Amp minimum continuous rating.

2.04.2 FUEL SUPPLY SYSTEM- DIESEL ENGINE

- A. Provide a double walled fuel tank, made of heavy gauge construction that is designed for full weather exposure. The tank shall be a sub-base type. There is to be visual tank to foundation clearance. The tank is to have the following features:
 1. Tank shall be UL 142 listed.
 2. The capacity of the fuel tank shall be sufficient to run the generator continuously for 96 hours at 75% load up to a maximum of 540 gallons, unless otherwise stated on the plans.
 3. Equipped with a mechanical fuel gage and low fuel level alarm that may be monitored from a remote location by a RTU which uses N/O type contacts.
 4. Two inch NPT fuel opening with spill protection and a lockable lid that is easily accessible.
 5. Emergency pressure relief vent opening on the inner and outer tanks.
 6. Inner tank leak alarm kit and low fuel alarm that may be monitored at a remote location by an RTU.

7. Basin drain.
 8. Overfill protection / containment.
 9. Provide an integral fuel pump of sufficient capacity to sufficiently charge the fuel lines under any start or run condition.
- B. The overall fuel system is to comply with all applicable NFPA regulations as well as those required by the Florida Department of Environmental Regulation. This includes NFPA compliant labels for the fuel shut-off location and application of Diesel HAZMAT symbol stickers.
 - C. Provide an anti-siphon valve in the fuel line at the output of the tank.
 - D. A fuel filter shall be installed between the fuel tank and fuel inlet to the engine. It shall have a fuel water separator. The filter element shall be disposable and be easily removed and installed for maintenance purposes.
 - E. Provide supply and return fuel lines of sufficient diameter for all load requirements, flexibility for maximum resistance to fatigue due to component operation and made of material which has maximum resistance to corrosion due to environment and fuel supply.
 - F. The skid base for the fuel tank shall be firmly fastened to a concrete foundation which is to be provided and installed as part of this contract. The fuel tank & skid assembly shall be removable from the base. Lifting points shall be provided for the tank skid. All metal surfaces coming in contact with concrete or grout shall be coated with coal tar epoxy equal to Koppers 300M or provide a 1/32-inch neoprene gasket between the metal surface(s) and the concrete or masonry may also be used. The neoprene gasket shall be installed along the entire perimeter, not just at the fastening hardware.
 - G. The exterior coating of the fuel tank and skid base shall be Sherwin Williams SherGlass FF glass flake reinforced amine epoxy (formulated for immersion service) or equal. Color shall be haze grey, two coats of 12-15 mils on top of a stripe coat over all welds, crevices, edges and sharp angles, per manufacturer's recommendations.
 - H. The fuel tank shall be full and topped off by the contractor when it is accepted by the County.

2.04.3 COOLING SYSTEM- ENGINE

- A. The engine shall be cooled by a unit mounted closed loop radiator system rated for full load operation in 50° C ambient condition with the ambient temperature as measured at the air inlet to the radiator. Radiator shall be provided with a duct adapter flange. The cooling system shall use a 50/50 (Prestone, Xerex or equivalent coolant and water) mixture provided by the supplier.
- B. Provide drain cocks or plugs in the engine block and radiator for easy changing and flushing of the coolant. Provide coolant drain extensions where necessary for easy access to the drainage device.
- C. Protection from rotating parts (fan, fan belt) shall be provided.
- D. Install a self contained thermostat module to automatically regulate coolant flow to maintain optimum constant coolant temperature as recommended by the engine manufacturer.
- E. Provide a coolant heater which is thermostatically controlled in the jacket of the engine.

2.04.4 EXHAUST SYSTEM- ENGINE

- F. The muffler for the engine shall be the critical grade made from aluminized steel of thickness and design as recommended by the manufacturer. The muffler shall be housed within the generator enclosure.
- G. All exhaust piping shall be aluminized steel. Vertical discharge exhaust shall be equipped with a rain cap, appropriate condensation drains in the piping, and the outlet, and shall be designed so no external rain or moisture may enter the engine from the outside even if the rain cap fails.
- H. Rain Skirt - At the point where the exhaust pipe tubing penetrates the roof or side of the enclosure, a suitable "rain skirt" and collar shall be provided by the MANUFACTURER. It shall be designed to prevent the entrance of rain and allow for expansion and vibration of the exhaust piping without chafing or stress to the exhaust system. This detail must appear on the drawings submitted for approval. Care must be exercised so there is no recirculation of exhaust gases into the intake system.
- I. The connection of the engine to the exhaust system shall be a flexible section of corrugated stainless steel pipe. The connection of the exhaust pipe to the muffler shall be a stainless steel expansion joint with liners.
- J. The exhaust emissions shall fall within the guidelines of the EPA and other state and governmental agencies.

2.05 AUTOMATIC TRANSFER SWITCH

- A. Supply an automatic transfer switch at each site with built-in control logic monitors to sense any interruption in the utility supplied power. When the power fails, the automatic transfer switch starts the engine and transfers the load after the generator has reached proper voltage and frequency. When the utility power has been restored to the proper voltage and frequency, the automatic transfer switch will switch the load back to the utility source and after a time delay to sufficiently cool down the generator, shut down the engine. The utility power service size to each site shall be verified by the contractor and shall be factored in when determining the size of the automatic transfer switch.
- B. The automatic transfer switch shall be housed in a separate rack-mounted NEMA 4X SS secure (double door) enclosure. The enclosure shall be no more than 36" tall by 24" wide. The enclosure shall be equipped with a rain shield and shall be constructed of at least 14 gauge 304 stainless steel. Per MC Stds, the rack shall consist of 3" Sch 40 SS posts with SS supports & hardware. All ATS controls shall be secure inside the enclosure behind the front cover and not face mounted.
- C. The transfer switch shall meet or exceed the following standards for emergency standby power system automatic transfer switches:
 - 1. UL 1008
 - 1. NFPA 110
 - 2. NEC - articles 700 thru 702
 - 3. NEMA 1 CS-2-447
- D. The automatic transfer switch is to have the following features:

1. Unit may or may not have a bypass switch with rating equal to the automatic transfer switch. The bypass switch shall be a manual type switch. A manual type bypass switch, that is installed on a concrete pad, is not required, for existing lift station sites that have site constraints, if noted on the construction drawings to provide a non-bypass automatic transfer switch.
 2. Suitable for emergency and standby applications on all classes of load.
 3. Adjustable normal source voltage sensing for pickup and dropout. The voltage is to be monitored line to line for all three phases of the switch.
 4. The normal source voltage sensing is to be adjustable from a minimum of 70%-90% of nominal voltage for drop out and a minimum of 75%-100% for pickup.
 5. There shall be a single phase sensing of the emergency source. It shall have an adjustable pickup setting of a minimum of 70% to 100% of nominal voltage.
- E. There shall be time delays activated in the automatic transfer switch as follows:
1. Provide an adjustable time delay to override momentary normal source outages. If the utility provided power does not correct itself to a nominal range of values for voltage and frequency before the time on the relay expires, then all applicable transfer and engine starting signals will be activated. If the power goes back into specification, then no transfer will take place.
 - a. Upon losing commercial power:
 - 30 seconds for time delay start
 - 2 minutes to neutral transfer
 - 1 minute from neutral to emergency power
 - b. After commercial power is restored:
 - 10 minutes to neutral transfer
 - 1 minute from neutral to utility
 2. Provide an adjustable time delay for transferring the load to emergency power.
 3. Provide an adjustable time delay for retransferring back to the utility power from emergency power.
 4. Provide a non-adjustable (five minute minimum) unloaded running time for cool down of the generator after the power has switched back to the utility supply mode.
 5. Provide a time delay to absorb momentary voltage and frequency spikes or dips during initial genset loading.
- F. The automatic transfer switch shall be a 3-pole switch.
- G. The automatic transfer switch is to have a disconnect switch which will prevent transfer.
- H. The automatic transfer switch shall have in phase transfer control logic which will initiate an in phase transfer of motor loads between line sources. This logic shall help prevent nuisance tripping of distribution circuit breakers and damage to mechanical loads resulting from out of phase power transfer.
- I. The automatic transfer switch is to be designed to be completely front accessible.
- J. The automatic transfer switch is to have true double throw operation.
- K. The automatic transfer switch shall have a solid neutral connection with full rated terminal lugs for normal, emergency and load.
- L. The automatic transfer switch shall be equipped with a ground stud for the installation of

customer provided ground terminations.

- M. The automatic transfer switch shall have, as a minimum, the following equipment for the control panel.
1. Microprocessor based electrical controls with circuitry protected against EMI, voltage transients, ESD, shock vibration, and other hostile environments.
 2. Analog or digital kilowatt meter, frequency meter, AC voltmeter and ammeter.
 3. Reset switch.
 4. LCD display, touch key pad, and LED indicators for user access to system information and settings. Provide a green light for when normal source is in operation and red light when generator is operating.
 5. Generator set exerciser control.
 6. Test pushbutton to simulate a normal power source failure.
 7. Provision for optional interface with a P.C.
- N. The automatic transfer switch shall have a surge suppressor which provides protection from transient voltage surges produced by lightning and other sources. The surge suppressors are to be composed of an array of matched metal oxide varistors with sufficient capacity to protect the transfer switch. It is to be connected to the normal power source terminals and installed at the factory.

2.06 HOUSE KEEPING SLAB FOUNDATION

- A. The reinforced concrete slab(s) for the generator and fuel tank are to be suitable to fully support the complete load under all load conditions with a reasonable safety factor. The top of the slab shall be a minimum of two inches above the surrounding grade and extend a minimum of six inches past the footprint of the generator set.
- B. The Manatee County Building Department will require the contractor to submit a plan for each poured-in-place concrete slab being installed. The Building Department will accept a slab designed by the manufacturer for their respective generator, provided the back-up information accompanies each plan. If the manufacturer does not provide a slab design, then the contractor shall submit a slab design that is signed and sealed by a Professional Engineer and meets the Florida Building Code.

PART 3 EXECUTION - AT EACH SITE:

3.01 INSTALLATION

- A. The contractor shall furnish and install the entire product to include all necessary site preparation, concrete foundation(s), electrical connections, and all devices described in this contract so that it is fully functional and operable as intended, including breakers and other modifications to the existing control panel for heaters, battery chargers, etc. The installation of the devices shall be per the manufacturer's instructions provided in item 1.05. The contractor shall connect the existing system equipment at each site to the equipment he is providing and insure compatibility between the system he is providing and the existing system. The contractor shall complete the installation of the equipment he provides to the existing site equipment to the degree that it shall not be necessary for the County to make further modifications or connections in order to have a fully functional system.
- B. The contractor shall install the generator, automatic transfer switch, and conduit as shown on the approved site plan he has prepared for each site.

1. County to provide an existing site plan.
 2. Contractor and Lift Station Superintendent shall meet on each site and determine the exact location for the generator, fuel tank and transfer switch.
- C. All wiring shall be installed in Schedule 80 PVC conduit sized according to the National Electrical Code for the number and size of conductors contained within. All trenches for underground installation of conduit shall be hand dug. Any electrical wiring that is installed between the lift station's wet well and the valve vault shall be installed in a carrier pipe that is strapped to the wet well or valve vault.
- D. Install the electrical components per Manatee County Standards (see typical wiring layouts in the latest Manatee County Public Works Utility Standards details US 23 & US 24).

3.02 FIELD QUALITY CONTROL

- A. Upon completion of item 3.01, a factory authorized service representative of the product supplied is to inspect all field assembled and installed components and make any necessary corrections to insure proper equipment operation.

3.03 TESTING

- A. All test instruments used to perform the testing are to have been calibrated within the past 12 months. The calibration shall be performed in accordance with the standards of the National Institute for Standards and Technology.
- B. Perform the following on-site tests after items 3.01 and 3.02 have been completed:
1. All necessary tests recommended by the manufacturer
 2. All NFPA 110 tests that are in addition to:
 - System Integrity Test: Verify proper installation, connection, and integrity of each of the components of the diesel generator system before and during operation.
 - Noise level test: Measure and calculate the A-weighted (DbA) levels emanating from the product assembly at five (5) meters for at least six equally spaced points around the enclosure while the machine is under load. Include such points as the exhaust discharge, and cooling air intake and discharge. The noise level test is to be taken at the site after installation and shall adhere to the conditions described in section 2.03A - item 9. Also refer to the test method as defined by ISO 3744.
 - Load Bank test: Run a two hour minimum test with all applicable field load (See section 1.02 for the ratings of the pump loads at each respective site). The automatic transfer switch is to be engaged and fully tested for all phases of operation during this test. The load bank may be either resistive or inductive. For purposes of the load test, the NEMA LRKVA/HP Code of the pump motors is H.
- C. Compare all measured quantities with required values of testing. Correct all deficiencies identified by tests and repeat test and correction procedure until specified test requirements are met. All problems and shortcomings in the product provided shall be remedied and corrected with no cost to the County.
- D. The County shall have the option of whether or not to witness all testing that is performed. Report all test results in writing to the County.

3.04 TRAINING AND DEMONSTRATION

- A. A factory representative of the product is to provide the County's maintenance personnel with a thorough period of instruction and hands-on session regarding the operation, trouble shooting and maintenance of all components of the product. Typical training period: one hour for each site.

3.05 DELIVERY

- A. The product described in these specifications shall be fully installed and fully operational, tested and demonstrated within the agreed upon number of days after the award of the bid has been made.

3.06 NOTICE OF DELIVERY, TESTING, TRAINING AND DEMONSTRATION

- A. At least seven business days of notice is to be given by the contractor to the County for delivery, installation, testing, training and demonstration of the product.

END OF SECTION

SECTION 16231A PORTABLE EMERGENCY GENERATOR SET

PART 1 GENERAL

1.01 SCOPE

- A. Provide a road-ready, complete and operable, portable UL 2200 listed emergency/standby electric generating system which contains all the devices and equipment specified herein and/or required for the service complete in every detail and requiring no additional modifications to provide power to and operate the lift station pumps and all equipment as expected. Equipment shall be new, factory and field tested, installed, and ready for operation. Timely service and reliability after the installation is accepted are critical in the choice of equipment. The Contractor shall furnish & install a portable emergency generator, automatic transfer switch (ATS), junction box, reinforced concrete pad, and all labor, wiring, cables, connectors, and all incidentals necessary to complete the project. The generator, fuel tank, and trailer shall be supplied by a single manufacturer and designed to be sold and distributed by that manufacturer. Portable shall mean transportable by an attached trailer with hitch.
- C. The engine is to be of sufficient horsepower to drive the generator under full load conditions. It shall be 4-cycle, fueled with diesel via a sub-base fuel tank and cooled with a closed loop radiator system. The generator is to be a low reactance brushless generator, with torque matched excitation and automatic voltage regulation. There is to be a set-mounted control panel with vibration insulators between it and the generator set. The generator, controls and associated cooling and exhaust systems are to be housed in a suitable weather protected secure enclosure which is to be permanently installed on a trailer. The automatic transfer switch is to be housed in a NEMA 4X stainless steel secured double door enclosure located adjacent to the control panel with underground conduit from the ATS to a junction box containing the connectors. The junction box shall be located adjacent to the generator pad.
- C. Where conflict between drawings, specifications or code occurs, the Contractor shall assume and provide the more stringent of the alternatives to the County.
- D. Contractor shall secure all required building permits including the electrical, concrete and fire department reviews. Contractor to provide all required drawings and certifications required to secure these permits. If indicated below, contractor will also provide Flood Certification.

1.02 RATINGS

- A. The generator set at LS 11, RTU 064 is to be installed at:

8501 Gulf Dr.
Holmes Beach, Florida

This portable generator set is to be of suitable power to drive a total of 2 submersible 230 volt, 21.5 horsepower induction motor pumps, the current main breaker for the station is: SD-QBL32200. This generator set shall be diesel fueled. An ATS manual by-pass switch is not required at this site. This site is in a flood zone and a flood certification is not required. The color of the generator set coating shall be Pantone Green 5545 C.

- B. The generator set at LS 15-D, RTU 218 is to be installed at:

1001 Palma Sola Blvd.
Bradenton, Florida

This portable generator set is to be of suitable power to drive a total of 2 submersible 230 volt, 20 horsepower induction motor pumps, the current main breaker for the station is: SD-Q2L3125 . This generator set shall be diesel fueled. An ATS manual by-pass switch is not required at this site. This site is in a flood zone and a flood certification is not required. The color of the generator set coating shall be Pantone Green 5545 C.

PLEASE NOTE : The induction pump motors providing the loads at the above sites all have the following characteristics and the generator sets supplied with this contract are to be built and sized bearing these facts in mind:

1. NEMA LRA Code H
2. Started with full voltage starters-maximum allowable voltage dip at start is 20%-loading will be sequential, (i.e., after each pump is brought up to speed the next one will be started)
3. 240 or 480 VAC (as required in the above sites)
4. 3 Phase
5. 60 HZ.

ALSO: Each generator is to be built with the following characteristics/conditions:

1. Generator sized as a sequence load.
2. Standby Emergency Rating
3. Power Factor = .8
4. Site Altitude = 100 feet
5. Range of Site Ambient Temperatures = 20 - 120° F.

1.03 GENERATOR SET PERFORMANCE

- A. The voltage regulation of each set shall be $\pm 0.5\%$ of rated voltage for any constant load from the range of no load to full rated load.
- B. The frequency regulation of each set shall be accomplished through an isochronous electronic governor from the range of steady state no load to steady state full rated load.

1.04 SUPPLIER

- A. The complete package - engine, generator, automatic transfer switch, trailer and other auxiliary components shall be provided from a single manufacturer/supplier. The supplier shall be the manufacturer's authorized distributor who shall maintain a service center capable of emergency maintenance and repairs with a consistent record of a maximum of four hours response time. The supplier shall have 24 hour/365 days per year service availability and factory trained service technicians authorized and capable to perform warranty service on all warrantable products.

1.05 SUBMITTALS

- A. Prior to and a requirement of contract award, the apparent low bidder shall provide references from at least 2 local municipalities or other businesses that have similar type portable emergency generators in service with response time requirements similar to this contract. The actual service responses will be verified for response time consistency and customer satisfaction.

- B. As a minimum for all equipment specified and provided, for each site, submit the following in pdf format to Manatee County. No equipment is to be ordered until the submittal is approved:
 - 1. Specification and application data sheets for the entire system supplied.
 - 2. Supporting calculations and/or documentation signed and sealed by a Professional Engineer licensed in the State of Florida in support of the proposed tie-down system and chains, anchors, and wind load calculations.
 - 3. Shop drawings showing a dimensioned outline plan and elevation views of the system with certified overall and interconnection point dimensions. Indicate fabrication details, dimensions, weights, loads, required clearances, components, location and size of each field connection and method of field assembly.
 - 4. Manufacturer's installation instructions.
 - 5. Interconnection wiring and piping diagrams which show all external connections required. Show field wiring terminals with markings in a consistent point to point manner.
 - 6. Manufacturer's applicable published warranty documents.

- C. Prior to the County's acceptance of generator site(s), the Contractor shall submit the following for each generator site(s):
 - 1. Generator field test results showing compliance with the specifications.
 - 2. Signed and sealed final RECORD DRAWING site plans prepared by a Professional Surveyor registered in the State of Florida showing all existing and new above ground facilities / improvements, new underground conduit locations, and property corners. A CAD file of the project survey can be requested from the County, if available.

The following information shall be provided on the final record site plans:

| | |
|-----------------------|--|
| Location in X, Y, & Z | Egen slab, all new underground pipes and conduits |
| Call outs | Egen size in KW, conduit size, fuel tank size in gallons |

1.06 WARRANTY

- B. A comprehensive, no deductible warranty shall be supplied for the complete electrical power system (the generator set, controls and associated switches, switchgear, junction box, automatic transfer switch and all accessories), and trailer supplied for each installation. The complete systems shall be warranted by the manufacturer against defects in materials and workmanship for a period of five years or 1500 hours of operation; whichever occurs first from the date of system acceptance. This warranty coverage shall include parts, labor, and travel expenses.

- C. The warranty of the coating of the enclosure, fuel tank, ATS, junction box and trailer shall be a non-deductible, unlimited warranty against rust and corrosion of any coated part of the enclosure for a period of ten years.

PART 2 PRODUCTS - AT EACH SITE:

2.01 AC GENERATOR

- A. Each generator shall be:
1. Used for 60 Hz Operation, 240 Volt or 460 Volt output voltage, see Sec 1.02 for specific voltage for each site.
 2. 4- Pole - 1800 RPM - Revolving Field Synchronous Machine
 3. Stator Winding to be .667 Pitch
 4. Air Cooled by Shaft Mounted Fans
 5. 12 Leads for Output Connections
 6. Class H Insulation System
 7. Temperature Rise by Resistance not to Exceed 125° C at Full Load
 8. The stator shall have vacuum impregnated windings with fungus resistant epoxy varnish.
- B. Utilize a permanent magnet generator for excitation power to an automatic voltage regulator. The permanent magnet generator shall sustain main field excitation power for optimum motor starting and to sustain short circuit current for selective operation and coordination of system over current devices.
- C. The automatic voltage regulator shall be a temperature compensated solid state design. It shall be equipped with 3-phase RMS sensing. The regulator shall control buildup of AC generator voltage to provide a linear rise and limit overshoot. The regulator shall include an under frequency rolloff torque-matching characteristic which shall reduce output voltage in proportion to frequency below a threshold of 58 hz. The torque matching characteristic shall include differential rate of frequency change compensation to use maximum available engine torque and provide optimal transient load response. Regulators which use a fixed voltage per hz. characteristic are not acceptable.
- D. Provide a generator main circuit breaker. This breaker is to be set mounted and wired, molded case thermal-magnetic rated for proper generator set operation. The breaker shall be UL listed. Field circuit breaker shall not be acceptable for the purpose of generator overcurrent protection. The generator circuit breaker shall incorporate:
1. Tripping characteristic: designed specifically for generator protection.
 2. Trip rating is to be matched to generator rating.
 3. Shunt Trip: Connected to trip breaker when generator set is shut down by other protective devices.
 4. Mounting Position: Adjacent to or integrated with control and monitoring panel.
- E. Provide a microprocessor-based unit that will continuously monitor current level in each phase of generator output. When signaled by the protector or other generator set protective device, a shunt-trip device in the generator disconnect switch shall open the switch to disconnect the generator from the load circuits. This microprocessor-based unit shall also:
1. Initiate a generator overload alarm when the generator has operated at an overload equal to 110% of full load for 60 seconds.
 2. Under single or three phase fault conditions, it shall regulate the generator to 300% or rated full load current for up to 10 seconds.
 3. When the heating effect of overcurrent on the generator approaches the thermal

damage point of the unit, the processor shall switch the excitation system off and open the generator disconnect switch to shut the generator down.

4. Sense the clearing of a fault by other overcurrent devices and control the recovery of the rated voltage to avoid overshoot.

F. Leads for water jacket heaters and space heaters shall be housed in their own separate conduit box.

G. Provide alternator strip heater or thermostatically controlled space heater(s) per manufacturer's recommendation to keep moisture out of the windings.

2.02 INSTRUMENTATION AND CONTROL

A. Each trailer/generator assembly shall connect to a secure junction box located adjacent to the reinforced concrete pad with flexible control and power cable(s). Connections shall be by a plug in / quick release plug(s) with connections for power to feed generator battery charger and jacket water (will require a 120 volt outlet), power to the lift station pumps, and signal connections to RTU panel. The junction box shall be connected to the ATS and/or control panel via underground conduit and wiring.

B. Each generator set is to be capable of being started and shutdown through an automatic transfer switch or manually.

C. Manually, the control shall have automatic remote start capability from a panel mounted three position (Run, Off (Reset), Auto) switch. When the control panel is selected to the "Run" position, the generator set starts and runs. When selected to the "Off" position, a shutdown is initiated. The "Auto" position allows the set to be operated from a remote location.

D. An emergency stop button will also be installed to shut the system down. This button should be red, a minimum of two inches in diameter, labeled "STOP" and installed in a conspicuous location on the generator set. It shall be reusable and resettable.

E. The control shall shut down and lock out upon: failing to start (overcrank), overspeed, low engine oil pressure, high engine coolant temperature, or operation of a remote manual stop station. A panel mounted switch shall reset the engine monitor and test all the lamps. Lamp indications on the control panel shall include as a minimum:

1. Overcrank Shutdown - Red
2. Overspeed Shutdown - Red
3. High Coolant Temperature - Red
4. Low Engine Oil Pressure - Red
5. High Engine Coolant Temperature Prealarm - Yellow
6. Low Engine Oil Pressure Prealarm - Yellow
7. Low Fuel - Yellow
8. Run - Green

F. Each generator set is to be set up by the manufacturer to indicate to a remote location through the County's RTU system:

1. When generator set is in operation.
2. When generator fails (no commercial or generator power).
3. When low fuel level is reached in the fuel tank.

G. Regulation of NFPA 110 Level 2 shall apply for instrumentation, alarm and shutdown. The instrument panel shall include, but not necessarily be limited to:

1. Gages for engine: with $\pm 2\%$ full scale accuracy:
 - a. Oil Pressure
 - b. Engine Coolant Temperature
 - c. Voltmeter for the DC Battery
2. Gages for generator: with $\pm 2\%$ full scale accuracy:
 - a. AC Ammeter - dual range
 - b. AC Volt Meter - dual range
 - c. Frequency Meter - range of 45-65 Hz.
3. Elapsed Time Meter
4. 0-3000 RPM Tachometer - with $\pm 2\%$ full scale accuracy.
5. A seven position phase selector switch with "OFF" position to show meter display of current and voltage of each generator phase. This selector switch may be manual or push-button.
6. A power source with circuit protection - 12 or 24 VDC.
7. An AC interlock to prevent starter re-engagement with engine running.
8. DC circuit protection.
9. A minimum of two panel lamps to illuminate instrument panel.

H. Switches and Controls

1. Digital controls for adjusting output voltage of the generator to $\pm 5\%$ of nominal voltage.
2. Over voltage protection shutdown switch.
3. Emergency stop switch mounted on control panel.
4. Engine start switch - with Run, Off (Reset), Automatic positions.
5. Five minute engine cool down timer.
6. Cyclic cranking switch.

I. The County's RTU system uses discrete- type signals with N/O type contacts. County shall make the actual connections to the RTU system.

The contractor shall install four wires; wire type shall be 16 AWG, 16 stranded flexing type MTW or TFFN 600 volt; from the generator control panel out to the junction box in underground Sch. 80 PVC conduit. Contractor will provide the receiving connector at the junction box (Amphenol Socket: 97-3102A-20-7P-624) and the County will make the final connection inside the control panel. Contractor will provide a 25' flexible control cable (same wiring scheme as from control panel) from the portable generator to the junction box with an end connector (Amphenol Plug: 97-3107A-20-7S-624 and Cable Clamp: 97-3057-1012). This connector arrangement is an 8 pin #16 ga. wire hookup.

Contractor will furnish and install an appropriately sized power cable from the ATS panel out to the junction box in underground Sch. 80 PVC conduit. Contractor will provide the receiving connector at the junction box and provide a 25' flexible power cable from the portable generator to the junction box with an end connector. The receiving and end connector shall be as follows:

| | | |
|-------------------|--------------|-----------------|
| | Junction Box | Generator Cable |
| 230 volt, 100 amp | JRSB1044FR | JPS1044FR |

| | | |
|-------------------|-------------|-----------|
| 230 volt, 200 amp | JRSB2044 FR | JPS2044FR |
| 460 volt, 200 amp | JRSB2034HR | JPS2034HR |

All basic system controls, operating and annunciating indicators, generator meters, engine gage and associated transformers, disconnect switches, and circuit breakers are to be mounted in a stainless steel NEMA 1 enclosure control panel on the generator set base through vibration isolators.

Alarms and generator closure contacts shall be in the same cable from the generator to transfer switch.

- J. All electrical penetrations in any enclosure shall be properly sealed from the weather.
- K. Primary power disconnect switch on the LS control panel shall be identified with an NFPA compliant Main Disconnect label.

2.03 ENCLOSURE

- A. The generator set and all the equipment supplied in this contract, shall be operated in an outdoor environment. Each trailer mounted generator set shall:
 1. Require weather protected secure enclosures. These enclosures shall protect the unit and all equipment and devices from the elements of the weather to include rain and winds to 140 MPH. All enclosures, boxes, trays, etc shall have weep holes for condensation or water intrusion drainage. Any oil containment / catchment areas shall have provision to completely drain off water. The enclosure shall provide adequate ventilation for cooling and operation under full load conditions.
 2. The enclosure shall be constructed of at least 14 gauge aluminum. The enclosure shall have an electrostatically applied, baked on, powder coated enamel or polyester finish 2.5 mil. The color of the coating shall be "Buff" or Pantone Green 5545 C, as noted on the drawings, and must be approved by Manatee County prior to installation of the product.
 3. The housing shall have hinged side access doors and a rear control door that are easy to remove. All doors shall be provided with padlock hasps so that the County can install their standard padlocks.
 4. All exterior assembly hardware, bolts and/or screws, handles, hinges, and hasps shall be 316 stainless steel. All exterior bolts and/or screws shall be tamper-proof. All tamper-proof screws shall utilize the 6 lobe pin TX or Torx® pin-head security fasteners.
 5. The housing shall be factory assembled to the generator set skid base. The skid base shall be firmly fastened to a trailer by the factory which is to be provided as part of this contract.
 6. The skid is to have adequate strength and rigidity to maintain alignment of mounted components without depending on the trailer. Lifting attachments shall be arranged to facilitate lifting with slings without damaging any components.
 7. The base shall incorporate a battery tray with battery hold down clamps within the rails. Vibration isolation shall be integral between the generator set and base.
 8. The enclosure shall be a low noise or sound attenuated enclosure. The noise level at any load operating condition, in any direction from the enclosure, shall not exceed 75 dBA at a distance of five (5) meters or 16.4 feet from the enclosure unless noted otherwise on the plans

2.04 ENGINE

- A. The engine shall be a 4-cycle, direct injection diesel with forged steel crankshaft and connecting rods suitable for continuous operation. It shall be designed for stationary applications and shall be complete with all necessary auxiliaries needed for operation of the AC generator.
- B. The engine shall have an electronic governor which shall provide isochronous frequency regulation.
- C. The engine shall have an electric starter and battery(ies). See the Starting System section for further details.
- D. Provide full flow lubrication oil filters with replacement spin-on canister elements. Provide a dipstick for oil level indication and an easily accessible fill location.
- E. Supply a replaceable dry element air cleaner with restriction indicator.
- F. Provide an engine mounted thermostatically controlled water jacket heater. The heater(s) wattage size shall be determined by the manufacturer. The heater voltage shall be single phase, 120V, 60HZ.

2.04.1 STARTING SYSTEM - ENGINE

- A. The battery(ies) used for cranking the engine shall be the lead acid type, 12 or 24 volt, sized as recommended by the generator manufacturer. The battery(ies) shall have sufficient capacity to crank the engine for at least three cycles of 15 seconds on - 15 seconds off, for a total of 75 seconds. They shall be provided as new with the entire manufacturer's warranty.
- B. The battery(ies) shall be fastened securely in its(their) own tray within the foot print of the skid. The tray shall be acid resistant.
- C. Include all interconnecting conductors and connection accessories.
- D. A suitable automatic voltage-regulated battery float charger, with a maximum charge rate as recommended by the manufacturer, shall be provided to maintain the batteries at full capacity during standby conditions. An ammeter shall indicate the charge rate and the circuits shall be protected by either fuses or circuit breakers. The charger shall be designed so that it will not be damaged during the engine cranking. The charger shall operate on 120 V.A.C. and shall be permanently installed within the generator enclosure. The charger shall be wired directly to the batteries and equipped with a 25' power cord to allow charging of the batteries when not in use. Power cord shall be OSHA approved and stored within the enclosure.
- E. On the engine, provide a factory mounted alternator with solid state voltage regulation and 35 Amp minimum continuous rating.

2.04.2 FUEL SUPPLY SYSTEM- DIESEL ENGINE

- A. Provide a sub-base type, dual walled, fuel tank, made of heavy gauge construction that is designed for full weather exposure. The tank is to have the following features:

1. Tank shall comply with UN and/or FDOT standards.
 2. The capacity of the fuel tank shall be sufficient to run the generator continuously for 36 hours at 75% load up to a maximum of 200 gallons, unless otherwise stated on the plans.
 3. Equipped with a mechanical fuel gage and low fuel level alarm that may be monitored from a remote location by a RTU which uses N/O type contacts.
 4. Provide an integral fuel pump of sufficient capacity to sufficiently charge the fuel lines under any start or run condition.
 5. The exterior coating of the fuel tank and skid base shall match the generator enclosure coating in all respects.
- B. The overall fuel system is to comply with all applicable NFPA regulations as well as those required by the Florida Department of Environmental Regulation and the Florida Department of Transportation. This includes NFPA compliant labels for the fuel shut-off location and application of Diesel HAZMAT symbol stickers.
- C. Provide an anti-siphon valve in the fuel line at the output of the tank.
- D. A fuel filter shall be installed between the fuel tank and fuel inlet to the engine. It shall have a fuel water separator. The filter element shall be disposable and be easily removed and installed for maintenance purposes.
- E. Provide supply and return fuel lines of sufficient diameter for all load requirements, flexibility for maximum resistance to fatigue due to component operation and made of material which has maximum resistance to corrosion due to environment and fuel supply.
- F. The exterior coating of the fuel tank and skid base shall be Sherwin Williams SherGlass FF glass flake reinforced amine epoxy (formulated for immersion service) or equal. Color shall be haze grey, two coats of 12-15 mils on top of a stripe coat over all welds, crevices, edges and sharp angles, per manufacturer's recommendations.
- G. The fuel tank shall be full and topped off by the contractor when it is accepted by the County.

2.04.3 COOLING SYSTEM- ENGINE

- A. The engine shall be cooled by a unit mounted closed loop radiator system rated for full load operation in 50° C ambient condition with the ambient temperature as measured at the air inlet to the radiator. Radiator shall be provided with a duct adapter flange. The cooling system shall use a 50/50 (Prestone, Xerex or equivalent coolant and water) mixture provided by the supplier.
- B. Provide drain cocks or plugs in the engine block and radiator for easy changing and flushing of the coolant. Provide coolant drain extensions where necessary for easy access to the drainage device.

2.04.4 EXHAUST SYSTEM- ENGINE

- A. The muffler for the engine shall be the critical grade made from aluminized steel of thickness and design as recommended by the manufacturer. The muffler shall be housed within the generator enclosure.

- B. All exhaust piping shall be aluminized steel. Vertical discharge exhaust shall be equipped with a rain cap, appropriate condensation drains in the piping, and the outlet, and shall be designed so no external rain or moisture may enter the engine from the outside even if the rain cap fails.
- C. Rain Skirt - At the point where the exhaust pipe tubing penetrates the roof or side of the enclosure, a suitable "rain skirt" and collar shall be provided by the MANUFACTURER. It shall be designed to prevent the entrance of rain and allow for expansion and vibration of the exhaust piping without chafing or stress to the exhaust system. This detail must appear on the drawings submitted for approval. Care must be exercised so there is no recirculation of exhaust gases into the intake system.
- D. The connection of the engine to the exhaust system shall be a flexible section of corrugated stainless steel pipe. The connection of the exhaust pipe to the muffler shall be a stainless steel expansion joint with liners.
- E. The exhaust emissions shall fall within the guidelines of the EPA and other state and governmental agencies.

2.05 AUTOMATIC TRANSFER SWITCH

- A. Supply an automatic transfer switch with built-in control logic monitors to sense any interruption in the utility supplied power. When the power fails, the automatic transfer switch starts the engine and transfers the load after the generator has reached proper voltage and frequency. When the utility power has been restored to the proper voltage and frequency, the automatic transfer switch will switch the load back to the utility source and after a time delay to sufficiently cool down the generator, shut down the engine. The utility power service size to each site shall be verified by the contractor and shall be factored in when determining the size of the automatic transfer switch.
- B. The automatic transfer switch is to be housed in a NEMA 4X stainless steel secure double door enclosure located adjacent to the control panel with underground conduit from the ATS to a junction box containing the connectors. The junction box shall be located adjacent to the generator pad. The secured-enclosure shall be equipped with a rain shield and shall be constructed of at least 14 gauge 304 stainless steel.
- C. The transfer switch shall meet or exceed the following standards for emergency standby power system automatic transfer switches:
 - 1. UL 1008
 - 2. NFPA 110
 - 3. NEC - articles 700 thru 702
 - 4. NEMA 1 CS-2-447
- D. The automatic transfer switch is to have the following features:
 - 1. Suitable for emergency and standby applications on all classes of load.
 - 2. Adjustable normal source voltage sensing for pickup and dropout. The voltage is to be monitored line to line for all three phases of the switch.
 - 3. The normal source voltage sensing is to be adjustable from a minimum of 70%-90% of nominal voltage for drop out and a minimum of 75%-100% for pickup.
 - 4. There shall be a single phase sensing of the emergency source. It shall have an adjustable pickup setting of a minimum of 70% to 100% of nominal voltage.

- E. There shall be time delays activated in the automatic transfer switch as follows:
1. Provide an adjustable time delay to override momentary normal source outages. If the utility provided power does not correct itself to a nominal range of values for voltage and frequency before the time on the relay expires, then all applicable transfer and engine starting signals will be activated. If the power goes back into specification, then no transfer will take place.
 - c. Upon losing commercial power:
 - 30 seconds for time delay start
 - 2 minutes to neutral transfer
 - 1 minute from neutral to emergency power
 - d. After commercial power is restored:
 - 10 minutes to neutral transfer
 - 1 minute from neutral to utility
 2. Provide an adjustable time delay for transferring the load to emergency power.
 3. Provide an adjustable time delay for retransferring back to the utility power from emergency power.
 4. Provide a non-adjustable (five minute minimum) unloaded running time for cool down of the generator after the power has switched back to the utility supply mode.
 5. Provide a time delay to absorb momentary voltage and frequency spikes or dips during initial genset loading.
- F. The automatic transfer switch shall be a 3-pole switch.
- G. The automatic transfer switch is to have a disconnect switch which will prevent transfer.
- H. The automatic transfer switch shall have in phase transfer control logic which will initiate an in phase transfer of motor loads between line sources. This logic shall help prevent nuisance tripping of distribution circuit breakers and damage to mechanical loads resulting from out of phase power transfer.
- I. The automatic transfer switch is to be designed to be completely front accessible.
- J. The automatic transfer switch is to have true double throw operation.
- K. The automatic transfer switch shall have a solid neutral connection with full rated terminal lugs for normal, emergency and load.
- L. The automatic transfer switch shall be grounded both to the trailer and through the plug connection to the lift station control panel.
- M. The automatic transfer switch shall have, as a minimum, the following equipment for the control panel.
1. Microprocessor based electrical controls with circuitry protected against EMI, voltage transients, ESD, shock vibration, and other hostile environments.
 2. Digital Kilowatt meter, frequency meter, AC voltmeter and ammeter.
 3. Reset switch.
 4. LCD display, touch key pad, and LED indicators for user access to system information and settings. Provide a green light for when normal source is in operation and red light when generator is operating.
 5. Generator set exerciser control.

6. Test pushbutton to simulate a normal power source failure.
 7. Provision for optional interface with a P.C.
- N. The automatic transfer switch shall have a surge suppressor which provides protection from transient voltage surges produced by lightning and other sources. The surge suppressors are to be composed of an array of matched metal oxide varistors with sufficient capacity to protect the transfer switch. It is to be connected to the normal power source terminals and installed at the factory.

2.06 PORTABLE GENERATOR TRAILER

- A. Trailers shall be constructed of structural steel as designed and fabricated by the emergency generator's manufacturer. Standard features include:
1. 12 ga. fenders designed to cover the tire and protect the trailer and pump.
 2. Heavy duty bumper, to be constructed of steel fully welded material.
 3. 12 ga. deck.
 4. 2-5/16 inch ball coupler trailer hitch.
 5. Safety chains and grab hooks.
 6. Generator mounting studs.
 7. Retractable front stand.
 8. Four 3,000 lb zinc plated jacks at the corners of the chassis or two 7,000 lb zinc plated jacks at the rear of the chassis and one 10,000 lb tongue jack at the front of the trailer.
 9. Underside of the trailer shall include four permanently attached tie-down positions; the inside diameter of the semi-circular attachment positions shall be a minimum of 3 inches
 10. highway lights.
 11. license plate holder.
 12. slow-moving vehicle sign.
 13. leaf springs on axle(s).
- B. The dual-axles are to be torsion design and sized to accommodate 120% of the gross vehicle weight. For the purpose of sizing axles, one gallon of diesel fuel is assumed to weigh 7.5 lbs.
- C. All axles to have electric brakes. ICC regulations require in-cab controls for trailers, therefore any trailer to be used on federal highways require electric brake or air actuation. Standard braking to be electric. Brakes must be equipped with independent breakaway system.
- D. Tires to be pneumatic, high speed tires, 8-ply, 16" wheels sized to exceed axle carrying capacity.
- E. Tongue weight to be 10 to 15% of total trailer weight and is not to be considered when sizing tires and axles.
- F. Tongue mounted cable box will be integral to trailer construction.
- G. Tongue jack design is drop leg with a sand foot. Swivel jacks and dolly wheels are not acceptable.
- H. Lighting to meet all DOT/ICC regulations including conspicuity tape as required. A 7-pin RV-type connector shall be used for lighting and brakes.

- I. For reliability, lights to be sealed beam or LED flush mount, replaceable bulb and/or surface mount lights are not acceptable.
- J. The exterior coating of the trailer shall match the generator enclosure coating in all respects.

2.07 ACCESSORIES

- A. Each generator set shall be equipped with a 25' power cord. The power cord shall be capable of delivering either 240 volts or 480 volts depending on the power rating of the generator set for the specific lift station site. The cords shall be type G, stranded copper, sized in accordance with the National Electrical Code and equipped with the following connect
 - 1. 240 volt, 100 amp power cord, JPS1044FR
 - 2. 240 volt, 200 amp power cord, JPS2044FR
 - 3. 480 volt, 200 amp power cord, JPS2034HR
 - 4. The power cord shall be direct wired to a separate circuit breaker within the enclosure and equipped with strain reliefs.
 - 5. All connectors shall be wired for CLOCKWISE rotation with the HIGH LEG on the B phase.

2.08 SPARE PARTS

- A. The spare parts at each site shall include, but not necessarily be limited to the following:
 - 1. (6) Fuses of each type and size used.
 - 2. (6) Pilot lamps for each type used.
 - 3. (3) Green lens caps for pilot lamps.
 - 4. (3) Red lens caps for pilot lamps.
 - 5. (3) Amber lens caps for pilot lamps.
 - 6. (1) Oil, air and fuel filter.
 - 7. (1) Of each special tool or device, if any, required to maintain the generator set and included equipment.

2.09 TRAILER PARKING SLAB

- A. The reinforced concrete slab for the generator trailer is to be suitable to fully support the complete load under all load conditions with a reasonable safety factor. The top of the slab shall be a minimum of two inches above the surrounding grade. Trailer tie-downs anchor points and chains shall be provided and aligned with the tie-down points on the trailer itself. The tie-downs anchors and chains shall provide sufficient strength to prevent tipping in a 140 mph wind event and provide an anti-theft component, i.e. lockable.

Contractor shall submit supporting calculation and/or documentation for each portable generator site signed and sealed by a Professional Engineer licensed in the State of Florida in support of the reinforced concrete slab, calculated wind loads, proposed anchors, tie-down system(s) and chains. The reinforced concrete slab shall have some type of vehicle stop to help align the trailer's tie-down locations with the installed anchoring points to ensure the trailer is properly secured.

PART 3 EXECUTION - AT EACH SITE:

3.01 INSTALLATION

- A. The contractor shall furnish and install the entire product to include all necessary site preparation, concrete foundation(s), electrical connections, and all devices described in this contract so that it is fully functional and operable as intended, including breakers and other modifications to the existing control panel for heaters, battery chargers, etc. The installation of the devices shall be per the manufacturer's instructions provided in item 1.05. The contractor shall connect the existing system equipment at each site to the equipment he is providing and insure compatibility between the system he is providing and the existing system. The contractor shall complete the installation of the equipment he provides to the existing site equipment to the degree that it shall not be necessary for the County to make further modifications or connections in order to have a fully functional system.
- B. The contractor shall install the concrete slab, generator, fuel tank, automatic transfer switch, trailer, junction box, connectors, wiring, conduit, and all incidentals necessary to complete this project as shown on the approved site plan prepared for each site.
 - 1. County to provide an existing site plan.
 - 2. Contractor and Lift Station Superintendent shall meet on each site and determine the exact location for the ATS, reinforced concrete pad, and junction box.
- C. All underground wiring shall be installed in Sch. 80 PVC conduit sized according to the National Electrical Code for the number and size of conductors contained within. All trenches for underground installation of conduit shall be hand dug. Any electrical wiring that is installed between the lift station's wet well and the valve vault shall be installed in a carrier pipe that is strapped to the wet well or valve vault.
- D. Install the electrical components per Manatee County Standards (see typical wiring layouts in the Manatee County Public Works Utility Standards dated May 2011 details US 23 & US 24).

3.02 FIELD QUALITY CONTROL

- A. Upon completion of item 3.01, a factory authorized service representative of the product supplied is to inspect all field assembled and installed components and make any necessary corrections to insure proper equipment operation.

3.03 TESTING

- A. All test instruments used to perform the testing are to have been calibrated within the past 12 months. The calibration shall be performed in accordance with the standards of the National Institute for Standards and Technology.
- B. Perform the following on-site tests after items 3.01 and 3.02 have been completed:
 - 1. All necessary tests recommended by the manufacturer
 - 2. All NFPA 110 tests that are in addition to:
 - a. System Integrity Test: Verify proper installation, connection, and integrity of each of the components of the diesel generator system before and during operation.
 - b. Noise level test: Measure and calculate the A-weighted (DbA) levels emanating from the product assembly at five (5) meters for at least six equally spaced points

around the enclosure while the machine is under load. Include such points as the exhaust discharge, and cooling air intake and discharge. The noise level test is to be taken at the site after installation and shall adhere to the conditions described in section 2.03A - item 9. Also refer to the test method as defined by ISO 3744.

- c. Load Bank test: Run a two hour minimum test with all applicable field load (See section 1.02 for the ratings of the pump loads at each respective site). The automatic transfer switch is to be engaged and fully tested for all phases of operation during this test. The load bank may be either resistive or inductive. For purposes of the load test, the NEMA LRKVA/HP Code of the pump motors is H.
- C. Compare all measured quantities with required values of testing. Correct all deficiencies identified by tests and repeat test and correction procedure until specified test requirements are met. All problems and shortcomings in the product provided shall be remedied and corrected with no cost to the County.
- D. The County shall have the option of whether or not to witness all testing that is performed. Report all test results in writing to the County.

3.04 TRAINING AND DEMONSTRATION

- A. A factory representative of the product is to provide the County's maintenance personnel with a thorough period of instruction and hands-on session regarding the operation, trouble shooting and maintenance of all components of the product. Typical training period: one hour for each site.

3.05 DELIVERY

- A. The product described in these specifications shall be fully installed and fully operational, tested and demonstrated within the agreed upon number of days after the award of the bid has been made.

3.06 NOTICE OF DELIVERY, TESTING, TRAINING AND DEMONSTRATION

- A. At least seven business days of notice is to be given by the contractor to the County for delivery, installation, testing, training and demonstration of the product.

END OF SECTION

SECTION 16370 VARIABLE FREQUENCY DRIVES

PART 1 GENERAL

1.01 SCOPE OF WORK

- A. Furnish new variable frequency drives as specified hereinafter.

1.02 DRIVE APPLICATION

- A. The variable frequency drives will be used to control the speed of inverter duty rated NEMA B design squirrel cage induction motors driving centrifugal pumps in wastewater effluent pumping service. Motors will range from 25 HP to 300 HP.

1.03 DRIVE PARAMETERS

- A. The variable frequency drives shall be designed and sized for the loads intended, shall not exceed their full-rated capacity when the driven pumps are operating at maximum capacity, shall not overload under any operating condition of the pumps, and shall be provided with an integral bypass motor starter package.

1.04 SPARE PARTS

- A. As a minimum, each of the variable frequency drives shall be furnished with the following spare parts:
 - 1. One (1) circuit board of each type used.
 - 2. Three (3) spare bulbs of each type and size used.
 - 3. Three (3) lens caps of each color and size used.
 - 4. Three (3) sets of power fuses.
 - 5. Three (3) sets of control fuses.

1.05 MANUFACTURER'S QUALIFICATIONS

- A. The manufacturer shall have a factory authorized representative (s) and/or a certified repair shop(s) staffed with factory trained service personnel capable of providing installation and start-up assistance, routine and 24-hour emergency repair services (including parts), and training for the County's personnel in operating and maintenance procedures associated with the specific variable frequency drives furnished.
- B. The manufacturer shall offer both standard and extended period service contracts as part of his normal operating policy.
- C. ACCEPTABLE MANUFACTURERS: The VFD's shall be as manufactured by the Fuji Electric Corporation of America.

1.06 MANUFACTURER'S REPRESENTATIVE

- A. A factory trained authorized representative(s) of the manufacturer shall be available to perform the following functions:
 - 1. Provide installation assistance to the County's personnel on an "as needed" basis, one (1) scheduled day minimum.

2. Provide checkout and start-up services as well as conduct the final acceptance tests, two (2) scheduled days.
 3. Provide training for the County's personnel in the proper operation and maintenance techniques to be used with the specific VFD's furnished, two (2) scheduled days.
- B. The manufacturer shall include in his bid sufficient funds to cover all the costs (travel, meals, lodging) associated with providing the services listed in Item 1.06.A.1, 2 and 3 above.

1.07 SUBMITTALS

- A. Within three (3) weeks of receiving the order, the manufacturer shall furnish the County with certified dimension prints which clearly show the nameplate data and outline dimensions.
- B. Prior to start of manufacture of the variable frequency drives, the manufacturer shall submit sets of drawings which shall include, but not necessarily be limited to, enclosure drawings showing the location of both internally and externally mounted components, master wiring diagrams showing all interconnections to the discrete component level, elementary or control schematics including coordination with other external control devices operating in conjunction with the variable frequency drives, and outline drawings with sufficient details to allow for locating conduit stub-ups and field wiring.
- C. Failure to comply with Item 1.06.B above shall be entirely at the manufacturer's risk. Any changes required as a result of the County's review will be solely at the manufacturer's expense with no cost to the County.

1.08 WARRANTY

- A. The manufacturer shall warrant that the variable frequency drives shall be free from defects in all materials and workmanship for a period of two (2) years from date of final acceptance.
- B. During the Warranty period, any and all covered defects shall be corrected by the manufacturer solely at his own expense with no cost to the County.

PART 2 PRODUCTS

2.01 VARIABLE FREQUENCY DRIVES

A. GENERAL

1. The variable frequency drives shall be the adjustable frequency (AF), variable torque (VT), pulse width modulated (PWM) type designed to provide continuous speed adjustment of 3-phase NEMA B squirrel cage induction motors, inverter duty rated.
2. The adjustable frequency drives (VFD's) shall be designed to control 25 HP to 300 HP motors respectively, and shall be rated for the horsepower (HP), full-load current (Amps), and speed (RPM) of the motors actually supplied.
3. The VFD's shall be furnished in NEMA Type 1 floor-mounted enclosures of the motor control center style. The enclosures shall be forced air ventilated using door-mounted fans. Fan installation shall include cleanable, reusable air filters.

B. CONSTRUCTION

1. The VFD's shall be microprocessor based solid state devices consisting of three (3) basic sections:

- a. A rectifier section to change the constant frequency AC input voltage to a DC voltage. A full wave rectifier shall be used to prevent input line notching. Internal fast acting semiconductor fuses shall be installed to preclude the necessity for having external AC line fuses.
 - b. A DC bus/link section to interconnect the rectifier section and the inverter section. A DC line reactor and capacitors shall be used to smooth the DC bus/link operation, improve displacement power factor, lower harmonic distortion, and eliminate the need for an isolation transformer.
 - c. An inverter section to convert the DC voltage to a variable frequency AC voltage. Insulated gate bipolar transistors (IGBT's) shall be used as output switching devices to allow "trip-less" operation, reduce motor noise, provide smoother motor operation, assure reliable and safe shutdowns under fault conditions, and increase drive efficiency; specifically, SCR's, GTO's, and Darlington Transistors are not acceptable as switching devices under this Specification.
2. The VFD's shall be capable of operating from a 3-phase input voltage of 240v and 480 Volts $\pm 10\%$ over a frequency range of 48-63 Hertz while providing a constant volts per Hertz excitation to the motors.
 3. The VFD's shall have a one minute overload rating of 150%, minimum.
 4. The VFD's shall employ surface mount technology for reduced size, high reliability, ease of maintenance, and resistance to vibration.
 5. The VFD's shall incorporate full internal protection against short circuits, ground faults, over- and under voltage, over- and undercurrent, and temperature extremes.
 6. The VFD's shall contain an adjustable electronic motor overload (I^2t) circuit to eliminate the need for an external motor overload relay.
 7. The VFD's shall utilize advanced diagnostic techniques to simplify trouble shooting and correcting problems.
 8. The VFD's shall have a minimum drive efficiency of 97% at full speed and full load.
 9. The VFD's shall have a minimum fundamental power factor of 0.98 at all speeds and loads.
 10. The VFD's shall be able to operate under the following environmental conditions without modification or derating:
 - a. Temperature: 0 to 40EC.
 - b. Altitude: Up to 3,300' above sea level.
 - c. Humidity: 0 to 95%, non-condensing.
 11. The VFD's shall be UL listed and shall comply fully with the applicable standards and provisions of ANSI, NEMA, IEEE, IEC, and NEC, latest revisions.

C. STANDARD FEATURES

1. The VFD's shall, as a minimum, have the standard features and adjustments listed below:
 - a. The VFD's shall have the same customer interface regardless of horsepower rating, including keypad, digital display, and user connections. The keypad and the digital display shall be accessible without opening the main door of the drive enclosures.
 - b. The keypad shall be the seven (7) button touch type and shall be used for start-up, for setting all parameters, for stepping through the displays and menus, and for local control, including speed adjustments.
 - c. In addition to the keypad speeds adjustment provisions, the VFD's shall also be furnished with a manual speed adjustment potentiometer. The potentiometer shall be accessible without opening the main door of the drive enclosures.

- d. The digital display shall be the LCD alphanumeric type with 40-character, 2-line capability. The LCD display shall be backlit to provide easy viewing at any angle in any light condition. The display shall have adjustable contrast.
- e. The display shall utilize plain English - i.e., all set-up parameters, indications, faults, warnings, and other such information must be displayed in words for easy user understanding; specifically, alphanumeric code numbers requiring memorization, cross-reference tables, or manuals for interpretation will not be acceptable under this Specification.
- f. The VFD's shall incorporate pre-programmed application macros for ease of start-up. To reduce programming time, the macros shall provide one command operation to reprogram all parameters and user interfaces for a particular application.
- g. The VFD's shall provide a user selectable option of either displaying a fault or running at a preset speed if a reference input is lost.
- h. The VFD's shall be capable of a "flying start" into a rotating load and accelerating to set-point without safety tripping or damage to the drives or driven equipment.
- i. The user terminal strip shall be isolated from both the line and ground.
- j. The VFD's shall have the ability to automatically restart after an overcurrent, overvoltage, under voltage, or loss of input signal protective trip. The number of restart attempts, trial time, and time between reset attempts shall be programmable. If the time between reset attempts is greater than zero, the time remaining until reset occurs shall count down on the display to warn an operator that a restart will occur.
- k. The VFD's shall be equipped with an automatic extended power loss ride-through circuit which will utilize the inertia of the load to keep the drive powered. Minimum power loss ride-through shall be one-cycle, based on full load and no inertia. Removing power from the motor will not be an acceptable method of increasing power loss ride-through under this Specification.
- l. The VFD's shall be optimized for a 3 kHz carrier frequency to reduce motor noise.
- m. The VFD's shall incorporate the following three (3) separate current limit circuits to provide "trip free" operation:
 - 1) A slow current regulation limit circuit which shall be an adjustable percentage of the VFD's variable torque current rating, minimum setting of 125%. This adjustment shall be made via the keypad and shall be displayed in actual amperes, not as a percentage of full load.
 - 2) A rapid current regulation limit circuit which shall be an adjustable percentage of the VFD's variable torque current rating, minimum setting of 170%.
 - 3) A current switch-off limit circuit which shall be a fixed percentage of the VFD's variable torque current rating, minimum setting of 255% instantaneous.
- n. In addition to any software items listed above, the VFD's shall, as a minimum, contain the following built-in software features:
 - 1) Automatic slip-compensation for maintaining motor speed under varying load conditions.
 - 2) A motor under-load function to protect the pumps.
 - 3) Starting torque up to 180% of full load torque.
 - 4) User selectable manual or automatic IR compensation for torque increases over a selected frequency range.
 - 5) Five (5) adjustable/selectable critical frequency lock-out bands to avoid

- 6) load resonance points during ramp-up or ramp-down.
- 6) Two (2) acceleration and two (2) deceleration ramps, adjustable from 0.1 seconds to 1800 seconds.
- 7) Three (3) adjustable S-curve acceleration and deceleration patterns.
- 8) User selectable linear, squared, or automatic control of the Volts-per-Hertz shape to assure maximum energy efficiency.
- 9) Precise full range frequency resolution adjustable in 0.01 Hertz increments.
- 10) Integral kilowatt-hour and elapsed-time displays.
- 11) Integral PI and sequential control functions.
- 12) Hand-Off-Auto function for local control through the integral keypad and remote control via pushbuttons and/or potentiometers.
- o. The VFD's shall have seven (7) programmable preset speeds as well as unidirectional rotation and coast-to-a-stop features.
- p. The VFD's shall have two (2) programmable analog inputs capable of accepting either a current or a voltage signal. Inputs shall be filtered and shall have adjustable gain and offset.
- q. The VFD's shall have six (6) programmable digital inputs.
- r. The VFD's shall have two (2) programmable analog outputs proportional to the chosen reference (frequency, motor speed, etc.).
- s. The VFD's shall have three (3) programmable digital outputs. Outputs must be true Form C relays; specifically, open collector outputs will not be acceptable under this Specification.
- t. The VFD's shall be equipped with an RS-485 serial port capable of communicating with external PLC's, DCS's, DDC's, and touch-screen graphic operator panels.
- u. The VFD's digital display shall contain, as a minimum, the following information shown in complete English words; specifically, alphanumeric code numbers requiring memorization, cross-reference tables, or manuals for interpretation will not be acceptable under this Specification:

| | |
|-------------------------|-------------------------|
| Output Frequency | DC Bus Voltage |
| Output Voltage | Heat sink Temperature |
| Motor Speed | Analog Input Values |
| Motor Current | Keypad Reference Values |
| Calculated Motor Torque | Elapsed Time |
| Calculated Motor Power | Kilowatt-hours |

- v. The VFD's shall, as a minimum, incorporate the following protective circuits which, in the case of a protective trip, shall stop the drive and announce the fault condition in complete English words; specifically, alphanumeric code numbers requiring memorization, cross-reference tables, or manuals for interpretation will not be acceptable under this Specification:
 - 1) Overcurrent: Trip set at 315% instantaneous (225% RMS) of the VFD's variable torque current rating.
 - 2) Overvoltage: Trip set at 130% of the VFD's rated voltage.
 - 3) Under voltage: Trip set at 65% of the VFD's rated voltage.
 - 4) Over temperature: Trip set at +70EC or +85EC dependent upon drive furnished.
 - 5) Ground Fault: Both "running" and "at start".
 - 6) Adaptable Electrical Motor Overload (I²t): Motor protection shall be based on motor speed and load; specifically, circuits which are not speed dependent will not be acceptable under this Specification.

- w. The VFD's shall incorporate a parameter lock feature which will prevent unauthorized personnel from altering the drive parameters without entering a programmable password or combination number. The parameter lock shall also be settable to a digital input.

D. FACTORY INSTALLED OPTIONS

1. In addition to the Hand-Off-Auto switch and speed potentiometer mentioned hereinabove, the VFD's shall include the following factory installed options:
 - a. Circuit Breaker: The circuit breaker shall be the thermal magnetic, thru-the-door interlock type, pad lockable in the Off position.
 - b. 115 VAC Control Transformer and Terminal Board: A terminal board shall be provided for convenient connection of all field control wiring, including all drive inputs and outputs and 115 VAC start input. A control transformer, 150 VA minimum, shall also be included.
 - c. Manual Bypass with Service Switch: A manually operated bypass switch shall allow the motor to be connected directly across the line and operate at full synchronous speed. In bypass, power is to be removed from the drive, but the start signals and the safety interlocks are to remain active. Normal and bypass pilot lights and an external fault circuit with an indicating lamp which illuminates whenever any external safety device has shut down the motor shall be included. Pilot lights shall be the push-to-test type. The service switch shall allow power to be removed from the drive for servicing while the motor operates from line power. The service switch shall be internally mounted to prevent unauthorized personnel from disrupting operation.
 - d. Motor Overload Relay: A standard, manually resettable, bimetallic, motor overload relay with a Class 20 trip curve shall be installed to provide thermal motor protection in the bypass mode. A thru-the-door reset button for the motor overload relay shall also be included.
 - e. Numbered Wires: All internal drive wires shall be numbered at both ends to facilitate maintenance and trouble shooting.

PART 3 EXECUTION

3.01 FACTORY TESTING

- A. Prior to assembly in the VFD's, all printed circuit boards shall be thoroughly factory tested and given a minimum eight (8) hour burn-in.
- B. After assembly, the drives shall be given a minimum eight (8) hour load test using a driven motor. The load shall be continuously cycled from no-load to full rated load to induce maximum stress and thermal variations in the drive components.
- C. During the load test, the major drive parameters (input volts, output volts, output current, output speed, output frequency, percent load, etc.) shall be recorded and a copy of the test results shall be reviewed by the County prior to the shipment of the VFD's. Similarly, any failure(s) of the drives during the load test shall be recorded, analyzed, corrected, and reported to the County before shipment of the VFD's.

3.02 SHIPPING

- A. The VFD's shall be so packaged for shipment that they are maximally protected from both

physical and environmental damage.

- B. The VFD's shall be transported to the County's job sites utilizing the manufacturer's customary method of shipment.

3.03 INSTALLATION

- A. The VFD's shall be installed by the County's personnel in accordance with the recommendations and procedures set forth in the installation manual furnished by the manufacturer.
- B. An authorized factory trained representative(s) of the manufacturer shall be available to assist the County's personnel on an "as needed" basis.

3.04 CHECKOUT AND START-UP

- A. Prior to start-up, a factory trained representative(s) of the manufacturer shall be on hand to assure that the VFD's have been properly installed and that all field wiring is correctly terminated.
- B. After checkout, the manufacturer's representative(s) shall then conduct a certified factory start-up using procedures and forms established by the manufacturer of the VFD's.
- C. A copy of the certified start-up form(s) for each drive shall be provided to the County, and a copy shall be kept on file by the manufacturer.

3.05 FIELD TESTING

- A. After satisfactory completion of the checkout and start-up procedures, the manufacturer's representative(s) shall begin an eight (8) hour acceptance test using actual plant loads.
- B. Any and all short-comings discovered and/or failures occurring during the acceptance test shall be remedied by the manufacturer solely at his own expense with no cost to the County.
- C. Any time after four (4) hours of acceptance testing, the County may, at his option, curtail further testing and take acceptance of the VFD's.

3.06 TRAINING

- A. As set forth in Items 1.05.B and 1.06.A above, a factory trained authorized representative(s) of the manufacturer shall be available at such a time(s) and place(s) established by the owner to train the County's personnel in the proper operation and maintenance procedures required by the specific VFD's furnished.

3.07 WARRANTY

- A. The manufacturer shall furnish to the County a written warranty which complies with the requirements set forth in Item 1.08 above.

END OF SECTION

SECTION 16450 GROUNDING

PART 1 GENERAL

1.01 SCOPE OF WORK

- A. Furnish and install a complete grounding system in strict accordance with Article 250 of the National Electrical Code and/or as hereinafter specified and/or as shown on the Contract Drawings.

1.02 SUBMITTALS

- A. The requirements of Section 01340 and Section 16050 shall be met.
- B. Test results as indicated in 3.02 C shall be submitted.

PART 2 PRODUCTS

2.01 MATERIALS

- A. Ground Rods: The ground rods shall be solid copper or copper-clad steel having a diameter of 5/8-inch and a length of 10-feet. The ground rods shall be as manufactured by Copperweld, or approved equal.
- B. Grounding Conductors
 - 1. All grounding conductors shall be copper. Aluminum or copper-clad aluminum grounding conductors will not be allowed.
 - 2. The grounding conductors shall be sized in accordance with the latest edition of the National Electrical Code, Table 250-94 or Table 250-95, whichever is applicable to the particular grounding conductor.
- C. Ground Rod Clamps: The ground rod clamps shall be malleable iron or cast bronze fittings suitable for use with copper conductors. The ground rod clamps shall be as manufactured by Bridgeport Fittings, Inc.; ITT Blackburn, Inc.; or approved equal.
- D. Dissimilar Metals Junctions: Connections between different metals shall be sealed using NO-OXIDE paint, Grade A, or approved equal.

PART 3 EXECUTION

3.01 INSTALLATION

- A. Wherever possible, the Contractor shall connect to an existing plant, area or building grounding grid. Where no such grounding grid exists, the Contractor shall provide grounding as hereinafter specified and/or as shown on the Contract Drawings.
- B. Building grounding grid conductors shall be embedded in backfill material around the structures.
- C. All underground conductors shall be laid slack and, where exposed to mechanical injury, shall be protected by pipes or other substantial guards. If guards are iron pipe or other magnetic material, conductors shall be electrically connected to both ends of the guard.

- D. Grounding electrodes shall be driven as required. Where rock is encountered, grounding plates may be used in lieu of grounding rods.
- E. All equipment enclosures, motor and transformer frames, conduit systems, cable armor, exposed structural steel and similar items as required by Article 250 of the NEC shall be grounded.
- F. All steel building columns shall be bonded together and connected to the building ground grid.
- G. Exposed connections shall be made utilizing approved grounding clamps. Buried connections shall be Cadweld, or approved equal, welding process.
- H. The ground bus of service entrance equipment shall be connected to the plant, area or building ground grid, whichever is applicable.
- I. For reasons of mechanical strength, grounding conductors extending from the plant, area or building grounding grid or service entrance ground bus, whichever is applicable, to the ground buses of motor control centers and/or unit substations shall be No. 1/0 AWG bare copper.
- J. Lighting transformer neutrals shall be grounded to the nearest grounding electrode.
- K. Conduits stubbed-up below a motor control center shall be fitted with insulated grounding bushings and connected to the motor control center ground bus. Boxes mounted below motor control centers shall be bonded to the motor control center ground bus. The grounding wire shall be sized in accordance with Table 250-95 of the National Electrical Code, except that a minimum No. 12 AWG shall be used.
- L. Motors shall be grounded in accordance with Section 16150, Item 3.01.A of these Specifications.
- M. The Contractor shall exercise care to insure good ground continuity, in particular between conduits and equipment frames and enclosures. Where necessary, jumper wires shall be installed.

3.02 TESTS

- A. The Contractor shall test the ground resistance of the system. The Contractor shall provide all test equipment of which the County shall have approval.
- B. The dry season resistance of the system shall not exceed five (5) ohms. If a single driven rod does not produce this value, the Contractor shall drive additional rods and/or take other measures as directed by the County without any cost to the County.
- C. The Contractor shall furnish to the County three (3) copies of the test report certifying that the system is in compliance with the ohmic value requirement. The certified test report shall include, but not necessarily be limited to, the following:
 - 1. Description of the test.
 - 2. Type of test equipment used.
 - 3. Moisture content of the soil.
 - 4. Date and time of the test.
 - 5. Resistance measurement of each rod cluster.

6. Name of individual(s) performing the test.
7. Contractor's certification stamp or seal.

3.03 GUARANTEES AND WARRANTIES

- A. The Contractor shall guarantee and warrant all materials and labor provided under this Section in accordance with Section 01740 and Section 16050 of these Specifications.

END OF SECTION

SECTION 16921 480 VOLT MOTOR CONTROL CENTER

PART 1 GENERAL

1.01 SCOPE OF WORK

- A. Furnish, install, test, and place in service motor control center(s) as hereinafter specified and/or shown on the Contract Drawings.
- C. This work will necessarily require interfacing with existing bus ducts; with existing power, control, and instrumentation wiring; with an existing remote telemetry unit (RTU); and with an existing emergency generator. All wiring shall enter and/or exit through the top of the MCC.
- D. The existing MCCs and their associated systems must be maintained in a fully operational condition while the new MCC and its associated power, lighting, control, and instrumentation systems are being installed and tested.
- E. After the new MCC and its associated systems have been installed, tested, and certified ready for operation, the cut-over from the existing MCC and systems to the new MCC and systems shall be done in one continuous uninterrupted period not to exceed twenty-four (24) hours. However, this intended cut-over scenario may be altered at the actual cut-over if Water Treatment Plant operating conditions/requirements mandate that a different cut-over scenario be implemented.
- F. The existing MCC and systems may be removed only after the new MCC and systems are fully operational and have been accepted by the Water Treatment Plant.
- G. The Contractor shall remove from the premises and properly dispose of all items or pieces of equipment not specifically designated for retention by the Water Treatment Plant.

1.02 REGULATORY REQUIREMENTS

- A. MCC-1 shall conform to the latest revisions of the following:
 - Underwriters Laboratory (UL) 845.
 - NEMA ICS-3, Part 1.
 - National Electrical Code, 1996.
- B. The MCC shall be manufactured in an ISO 9001 certified facility.
- C. The MCC, all individual MCC sections, and all individual components shall be UL labeled where applicable.
- D. Since the MCC contains service entrance equipment, it shall be UL labeled ASuitable for Use as Service Equipment@.

1.03 MANUFACTURER'S QUALIFICATIONS

- A. The MCC shall be the product of a manufacturer who shall also be the manufacturer of the circuit breakers, motor starters, control and timing relays, and control components (push buttons, etc.).

- B. To match existing equipment and to preclude the unnecessary and expensive duplication of spare parts, the MCC shall be the Model 6, Class 8998 as manufactured by the Square 'D' Company, no substitutions!

1.04 MANUFACTURER'S REPRESENTATIVE

- A. The manufacturer of the MCC shall provide the services of an authorized factor representative(s) who is well versed in the operation and maintenance of the MCC.
- B. The authorized factory representative shall be available as follows:
 - 1. To assist the Contractor during construction on an as needed basis.
 - 2. To perform the final system check-out, conduct the final acceptance test, and place the MCC into initial service [one (1) day, minimum].
 - 3. To instruct the County's personnel in the proper operation and maintenance of the MCC [one (1) day, minimum].

1.05 PACKING, HANDLING, AND SHIPPING

- A. The MCC shall be divided into convenient shipping blocks not to exceed three (3) vertical sections per shipping block.
- B. Each shipping block shall be fitted with a removable lifting angle which will provide a convenient means for attachment to a crane or other suitable lifting equipment. In addition, each shipping block shall be fitted with back and front removable channel sills.
- C. Each shipping block shall be so packed as to prevent damage to the MCC by normal handling methods or by weather elements while in transit.
- D. The manufacturer of the MCC shall deliver it to the appointed receiving site utilizing his customary mode(s) of transportation.

1.06 STORAGE

- A. The MCC shall be stored on-site in a clean, dry, well-ventilated, indoor location which is free from temperature and humidity extremes. Ideally, the temperature range should be 32-degrees F to 104-degrees F and the humidity range should be 15% to 75%, non-condensing.

1.07 SUBMITTALS

- A. Prior to beginning manufacturing of the MCC, the following shall be submitted to the County for review and approval:
 - 1. Outline drawings showing major dimensions for the MCC.
 - 2. Front elevation showing compartment and component arrangements for the MCC.
 - 3. Complete master wiring diagrams and elementary or control schematics for the MCC showing the interconnections with existing external devices. Due to the complexity of the interconnections with the existing devices, it is imperative that the diagrams/schematics be carefully prepared. Standard preprinted sheets or drawings marked to indicate applicability to this project will not be acceptable under this Contract.

4. Complete single line diagrams for the MCC showing:
 - a. Incoming line section components.
 - b. Frame and trip rating for all circuit breakers.
 - c. Size and type for all motor starters.
 - d. Pertinent data for all special devices such as lighting transformer and panelboard.
 - e. Conduit and conductor sizes for motors and other external loads.
- B. Changes or alternations in the MCC necessitated by the failure to comply with the provisions of Item 1.07.A above will be entirely at the expense of the Contractor and/or manufacturer with no cost accruing to the County.

1.08 WARRANTY

- A. The MCC shall be warranted to be free from defects in materials and workmanship for a period of one (1) year from date of final acceptance.

PART 2 PRODUCTS

2.01 RATING

- A. The MCC shall be designed for use on a 480 Volt, 3-phase, 4-wire, 60 Hertz power system.
- B. The MCC shall have a power bus system braced for a minimum short circuit capacity of 42,000 Amperes RMS, symmetrical.

2.02 CONFIGURATION

- A. The MCC shall consist of individual vertical sections bolted together to form a rigid, free-standing structure.

2.03 MATERIAL

- A. The vertical sections shall be fabricated from heavy gauge structural steel, No. 14 gauge minimum thickness, which shall be in full compliance with UL 485.

2.04 CONSTRUCTION

A. STRUCTURES

1. The MCC structure shall be composed of individual vertical sections of the standard metal-enclosed, free-standing, dead-front type which shall be bolted together to form the MCC assembly.
2. The overall height of the MCC structure shall not exceed 90-inches, exclusive of the removable lifting angle and base channels.
3. The vertical sections shall be 20-inches deep by 20-inches wide, except that the width may be increased as required to allow installation of larger sized devices.
4. The vertical sections shall have 72-inches of vertical space for the installation of control devices. The sections shall also have a 12-inch wireway at the top and a 6-inch wireway at the bottom. The wireways in adjacent sections shall line up to provide wireways the full length of the MCC to accommodate power, control, and instrumentation interconnecting wiring between the various vertical sections.
5. Each 20-inch wide or wider vertical section shall come equipped with all the requisite

hardware and bus bars arranged as needed to install modular plug-in units. Each modular plug-in unit shall have its own separate compartment with a door and a disconnecting device. Plug-in units of a similar size and type shall be interchangeable. All unused space in the vertical section shall be covered by hinged blank doors and shall be equipped to accept the installation of future plug-in units. Each section shall include both top and bottom plates which shall be removable for ease in cutting conduit openings.

6. The compartments shall not only totally isolate the enclosed equipment, but shall also be isolated from each other. The compartments shall be equipped with interlocks to prevent the compartment door from being opened with the disconnecting device in the "Closed" position. An interlock bypass shall be provided for the use of qualified personnel. The disconnecting device shall be able to be locked in the "Off" position, three (3) padlocks minimum. The disconnecting device operating mechanism shall not be attached to the compartment door. Compartment openings to the vertical bus shall be covered by manual shutters.
7. Vertical sections which accept modular plug-in units shall be provided with a 4-inch wide full depth vertical wireway which connects with both the top and the bottom horizontal wireways. The vertical wireways shall be isolated from unit interiors by a full height barrier. The vertical wireways shall have a separate full length hinged door which does not require opening control unit doors for access to the wiring. Vertical sections which house a single, full section control unit shall not be required to have vertical wireways. However, these control units must open directly into the MCC horizontal wireways.
8. The assembled MCC structure shall be a one-deep configuration designed for against-the-wall mounting. All wiring, bus bar joints, and other mechanical parts which require adjustment, servicing, or maintenance must be accessible from either the front or the top of the structures. Rear access will not be acceptable under this Specification.
9. The assembled MCC structure shall meet the requirements for NEMA Type 12 construction. Wiring shall conform to NEMA Class 2, Type C requirements.
10. The MCC shall be painted with a UL recognized acrylic electrodeposition based enamel, ANSI 49 gray. The painting process shall consist of cleaning, rinsings, phosphating, non-chrome sealer rinsings, prepaint rinsings, painting, post-painting rinsings, a baking cure, and a cooling down period. All painted parts must be able to withstand at least 300-hours of salt spraying with less than an 1/8-inch loss of paint from a scribed line per ASTM b117.
11. The MCC shall be furnished as a completely factory assembled unit except where shipping and/or handling requirements make it necessary to subdivide the MCC into smaller more convenient units (see Items 1.05.A, B & C above).

B. BUS BARS

3. All bus bars and bus bar connectors shall be silver-plated or tin-plated copper. Aluminum bus bars and aluminum connectors will not be acceptable under this Specification.
4. The main horizontal bus bars shall run the full length of the MCC. Provisions shall be made to allow splicing additional sections onto either end of the MCC.
5. Bus bar ratings shall be based on a 65 degree C maximum temperature rise over a 40 degree C ambient temperature. The main horizontal bus of MCC-1 shall be rated 1600 Amperes. As is required by Item 2.01.B above, the power bus systems shall be braced for a minimum short circuit capacity of 42,000 Amperes RMS, symmetrical.
6. Each vertical section that includes plug-on units shall be equipped with a vertical

bus with a minimum rating of 300 A continuous. The vertical bus shall be connected directly to the main horizontal bus without the use of risers or intervening connectors. The vertical buses shall be insulated and isolated with a glass polymer or an equivalent continuous insulation. Taped buses will not be acceptable under this Specification.

7. The MCC shall be furnished with a 1/4-inch by 2-inch ground bus which runs the full length of the MCC. An appropriately sized mechanical lug shall be provided in the MCC for connecting a ground cable. The ground bus shall be furnished with six (6) drilled holes per vertical section to accept County-supplied ground lugs for any loads which require a ground conductor.
8. Each vertical section shall have a vertical ground bus which connects to the main horizontal ground bus. Vertical section construction shall be such that upon insertion of plug-on units, the vertical ground bus shall engage before the power stabs make contact and upon removal of the plug-on units, the power stabs shall disengage before the vertical ground bus is disconnected.

B. WIRING

1. Both intercompartment and intracompartment wiring shall utilize all copper conductors.
2. All terminations and connections shall be via compartment mounted, plug-in terminal blocks which allow compartments to be removed without having to disconnect wires from fixed terminal blocks.
3. Ground conductors shall be green, power conductors shall be black, control conductors shall be red, and conductors energized from sources other than the starter control power transformer shall be yellow.
4. Except for short jumpers, all conductors shall be numbered at both ends and at all intermediate junction points. This numbering scheme shall be reflected in the wiring diagrams.

C. SIGNAGE

1. As is required by Item 1.02.D above and by Article 230-66 of the NEC, the incoming line section of the MCC shall be marked "SUITABLE FOR USE AS SERVICE EQUIPMENT". Sign shall be laminated plastic, white letters on a black or dark gray background.
2. The MCC shall be furnished with a sign marked "DANGER-480 VOLTS". Sign shall be laminated plastic, red letters on a white background. Letters shall be 1-inch high, minimum.
3. All compartments which have voltage sourced from outside the cabinet which are not disconnected by the compartment's motor circuit protector shall be furnished with a sign marked "CAUTION - THIS UNIT CONTAINS A VOLTAGE FROM A SOURCE OUTSIDE OF THIS UNIT". Signs shall be black letters on a high visibility yellow background. Signs shall be 3-inches by 5-inches, minimum size.

2.05 COMPONENTS

A. COMBINATION MOTOR STARTERS

1. All starters shall be the 3-pole, magnetic, combination type suitable for 480 Volt, 60 Hz operation. Starter types (full voltage, non-reversing or reduced voltage) shall be as shown on the Drawings. Reduced voltage starters shall be solid state devices.
2. Starter NEMA sizes shall be determined from the motor horsepowers shown on the

- Drawings, but in no case shall any starter size be smaller than NEMA 1.
3. Starters shall be provided with a three-pole externally manual reset, overload relay.
 4. Unless otherwise indicated on the Drawings, all starters shall be provided with a control transformer. The transformer shall be sized to handle both the contactor load and all connected control circuit loads.
 5. The control transformer shall have two (2) primary protective fuses and one (1) secondary fuse. The secondary fuse shall be installed in the ungrounded conductor only!
 6. The control transformer rating shall be clearly visible from the front when the starter unit door is opened.
 7. In units where a control transformer is not provided, but where externally powered control circuits are present, the unit disconnect shall include an electrical interlock for disconnection of the externally powered circuits.
 8. Auxiliary control interlocks, field convertible to normally open or normally closed operation, shall be provided where required to assure proper circuit operation.
 9. Unless otherwise indicated on the Drawings, all starter cubicles shall be provided with the following door mounted devices:
 - a. 120 Volt, push-to-test pilot lights:
 - 1) Red "ON" light.
 - 2) Green "OFF" light.
 - b. Three-position selector switch:
 - 1) Hand-Off-Auto.
 - c. Indicating ammeter:
 - 1) Analog type.
 - d. Elapsed time meter:
 - 1) Digital type.
 - 2) Non-resettable.
 - 3) 0-99,999.9 hours.
 10. Where applicable, the door mounted devices shall be the heavy-duty, oiltight type.

B. CIRCUIT BREAKERS

1. Circuit breakers shall be the molded case, thermal-magnetic type with an interrupting capacity not less than the design short circuit rating of their respective motor control centers.
2. Incoming line circuit breakers and branch feeder circuit breakers shall have frame and trip ratings as indicated on the Drawings. Circuit breakers used as part of a combination starter shall be the manufacturer's standard for the respective starters furnished.
3. Circuit breaker operating handles shall protrude through, but shall not be attached to, the cubicle door.
4. The circuit breaker handle operating mechanisms shall allow complete ON/OFF control of the circuit breakers with a clear indication of the breaker's status.
5. The handle operators shall also have a separate and distinct TRIPPED position to clearly indicate a circuit breaker trip condition. It shall be possible to reset the tripped circuit breakers without opening the cubicle doors.
6. Provisions shall be made for locking the operating handles in the OFF position, three (3) padlocks minimum.

C. INCOMING LINE SECTION

1. The MCC shall be furnished with an incoming line section composed of the following:
 - a. Top mounted main circuit breaker.

- b. Metering.
- c. Instrument transformers.
- d. Surge protection.
- 2. The main circuit breaker shall comply with all the applicable provisions of Item 2.05.B above.
- 3. The metering for the incoming line section shall consist of the following:
 - a. Voltmeter:
 - 1) Analog, square switchboard type.
 - 2) 250-degree scale.
 - 3) 1% accuracy.
 - b. Voltmeter switch:
 - 1) 7-position for selecting three phases, three phases to ground, and off.
 - 2) Heavy duty, rotary type.
 - 3) Pistol grip handle.
 - c. Ammeter:
 - 1) Analog, square switchboard type.
 - 2) 250-degree scale.
 - 3) 1% accuracy.
 - d. Ammeter switch:
 - 1) 4-position for selecting three phases and off.
 - 2) Heavy duty, rotary type.
 - 3) Pistol grip handle.
 - e. Instrument transformers:
 - 1) Indoor, metering class per ANSI, NEMA, and IEC standards.
 - 2) 600 Volt rating.
 - 3) Butyl-rubber molded.
 - f. Surge protection:
 - 1) Lighting arrester:
 - (a) Three-phase, MOV type.
 - 2) Surge capacitor:
 - (a) Three-phase type.

D. DISTRIBUTION TRANSFORMER

- 1. MCC-1 shall be furnished with a distribution transformer as follows:
 - a. 10 KVA capacity.
 - b. 480 Volt primary, 120 Volt secondary, single phase, 60 Hertz.
 - c. 150-degree Centigrade temperature rise.
 - d. 30 Ampere primary circuit breaker.

E. DISTRIBUTION PANELBOARD

- 1. MCC-1 only shall be furnished with a distribution panelboard as follows:
 - a. Type: NQOD
 - a. Rating: 120/240 Volt, single phase, three-wire, 60 Hertz.
 - a. Branch breaker type: QOB bolt-on breakers, 1-pole or 2-pole.
 - a. Pole spaces: Twenty (20) total.
 - e. 100 Ampere primary circuit breaker.

F. RELAYS

- 1. Control and/or time delay relays shall be installed in the individual MCC cubicles

where necessary for proper operation of the respective circuits.

2. The relays shall be as follows:
 - a. Type:
 - 1) Heavy duty.
 - 2) Machine tool type.
 - b. Contacts:
 - 1) Convertible type.
 - 2) 10 Amp (minimum) at 120 Volts.
 - c. Timing Units:
 - 1) Pneumatic type.
 - 2) Adjustable, 0-30 minutes.

G. POWER FACTOR CORRECTION CAPACITORS

1. One power factor correction capacitor is to be installed for each pump motor. Use 30 KVAR, 480V capacitor for 125 HP motor and 35 KVAR, 480V capacitor for 150 HP motor. Install each capacitor on the load side of the motor magnetic starter.

H. IDENTIFICATION OF DEVICES

1. All devices in the MCC, whether internally mounted or through-the-door mounted, shall be identified individually.
2. The individual device identification shall be the same designation or number as that used on the respective wiring diagrams.
3. The identification of the internally mounted devices shall be by either stenciling thereon or by small nameplates attached thereto.
4. The identification of the through-the-door mounted devices shall be by either stenciling or by small nameplates adjacent to the devices on the inside surface of the door.

I. NAMEPLATES

1. Engraved nameplates shall be provided for the MCC and each unit compartment.
2. The nameplates shall be phenolic or a similar durable plastic material.
3. The nameplates shall have a black or dark gray background with white lettering.
4. Both the size of the nameplate and the size of the lettering on the nameplate shall be appropriate for the specific application.

2.06 SPARE PARTS

- A. The manufacturer of the MCC shall furnish a list of recommended spare parts for the County's review and approval.
- B. The spare parts shall include, but not necessarily be limited to, the following:
 1. One (1) box of power fuses of each size used.
 2. One (1) set of starter contacts for each NEMA size used.
 3. One (1) starter coil for each NEMA size used.
 4. One (1) box of pilot lamps.
 5. Six (6) red lens caps for pilot lamps.
 6. Six (6) green lens caps for pilot lamps.
 7. Six (6) amber lens caps for pilot lamps.
 8. One (1) of each special tool or device, if any, required to maintain the MCC and

included equipment.

- C. The manufacturer of the MCC shall furnish all items on the spare parts list as approved by the County.

2.07 FACTORY QUALITY CONTROL

- A. After fabrication, but before shipment, the MCC shall be subjected to a thorough factory quality control inspection.
- B. The quality control inspection shall include, but not necessarily be limited to, the following:
 - 1. Physical inspection of the structures.
 - 2. Physical inspection of both the interior and exterior finished coatings.
 - 3. Physical inspection of the individual components.
 - 4. Physical inspection of the bus installations.
 - 5. Physical inspection of the individual wiring conductors, including terminations.

2.08 FACTORY ELECTRICAL TESTING

- A. Prior to shipment, the MCC shall be subjected to a thorough factory electrical testing which shall include, but not necessarily be limited to, the following:
 - 1. AC dielectric test of the power circuit.
 - 2. Power circuit phasing.
 - 3. Control circuit continuity and operation.
 - 4. Polarity and operation of instrument transformers.
 - 5. Polarity and operation of meters and meter switches.
 - 6. Sensitivity and operation of the ground fault system.
 - 7. Operation of the individual devices.

2.09 SIGNS AND LABELS

- A. After the MCC has successfully completed both the factory quality control inspection and the factory electrical testing, it shall be affixed with the appropriate signs and labels.
- B. The signs and labels shall include, but not necessarily be limited to, the following:
 - 1. Warning/informational type signs and labels.
 - 2. Operational/instructional type signs and labels.
 - 3. U.L. label (s).
 - 4. Inspector's stamp(s).

PART 3 EXECUTION

3.01 INSTALLATION

- A. EXISTING FACILITIES OPERATION
 - 1. Unless otherwise directed by Water Treatment Plant personnel, the existing facilities (MCC's, bus duct, motors, lighting, etc.) must be kept fully operational during the installation of the new MCC and associated wiring and equipment (see Item 1.02.C above).

2. Temporary shut-down of any of the existing facilities shall only be with the prior approval of and at the convenience of the Water Treatment Plant personnel.

B. MCC-1

1. The MCC shall be installed on a new steel reinforced concrete pad in the location shown on the Drawings.
2. The bottom mounting members of the MCC shall be bolted to channel sills imbedded in the new concrete pad.
3. The imbedded sills shall run the full length of the two longest sides of the MCC. The sills shall be installed level in all directions.
4. The mounting bolts and associated hardware shall be stainless steel.
5. The MCC shall be maintained in a vertically upright position at all times during installation.
6. The MCC shall be lifted only using the top mounted, factory installed, lifting angles or as otherwise approved, in writing, by the manufacturer of the MCC.
7. The MCC shall be protected against both physical and environmental damage at all times. Any damage to the paint shall be carefully repaired using a touch-up paint furnished by the manufacturer of the MCC.
8. All wiring, whether incoming or outgoing, shall be connected to the MCC via through-the-top conduits with the exception of the main power supplies which shall utilize through-the-top bus duct connections.
9. Field installed interior wiring shall be neatly grouped by circuit and shall be bound by plastic tie-wraps. Care shall be taken to support the wire groupings in such a manner as to avoid any stressing of the termination points.

3.02 FIELD TESTS AND CHECKS

A. After assembly of the MCC, but prior to the termination of any field wiring, the following tests shall be made:

1. Megger terminals and buses with the main circuit breaker closed and all other circuit breakers open.
2. Megger terminals and buses with the main circuit breaker and all other circuit breakers closed.
3. The results of the tests in Items 3.02.A.1 and 3.02.A.2 above shall be forwarded to the County for review and approval. The minimum acceptable result for each test is 100 megohms.
4. The tests in Items 3.02.A.1 and 3.02.A.2 above shall be performed using a 1000 VDC megger after all devices sensitive to the megger voltage have been disconnected.

B. Before the MCC is energized, check for the following:

1. All current transformer secondary circuits have been completed and the shunts have been removed.
2. Correctly sized overloads have been installed for all motors.
3. All mechanical interlocks operate properly.

C. After the MCC has been energized, check for the following:

1. All individual components within the MCC function properly both mechanically and electrically.

2. There are no visible hot spots on the buses or at major termination points.
- D. After the requirements of Items 3.02.A, B, and C above have been successfully completed, the MCC shall be subjected to the following:
1. A fully operational 24-hour acceptance test.
 2. The acceptance test shall be conducted by an authorized factory representative(s) of the manufacturer of the MCC.
 3. The acceptance test shall be witnessed by Water Treatment Plant personnel as designated by the County.
 4. Anytime during the acceptance test after eight (8) consecutive hours of trouble-free operation, the County may, at his option, forego the remainder of the test and accept the MCC at that point. However, this County=s option shall in no way relieve the manufacturer=s authorized representative(s) from the obligation to be fully prepared to conduct a complete 24-hour acceptance test.
 5. All problems and shortcomings in the MCC and the associated equipment and devices which are discovered during the acceptance test shall be remedied/corrected by the Contractor entirely at his own expense with no cost to the County.

END OF SECTION

SPECIAL PROVISIONS

FOR

26th Street West at 30th Avenue West Intersection Improvements

COUNTY PROJECT No. 6092460

November 2020

PROJECT OWNER:

County of Manatee, Florida
c/o Manatee County Procurement Division
1112 Manatee Avenue West
Bradenton, Florida 34205
(941) 748-4501

PREPARED BY:

HDR Engineering, Inc. & Manatee County Public Works Department

SPECIAL PROVISIONS

| SECTION | PAGE |
|---|------|
| GENERAL | 1 |
| CONTRACT PLANS | 1 |
| STANDARD SPECIFICATIONS | 1 |
| PRIORITY | 1 |
| NO SEPARATE PAYMENT FOR SPECIAL PROVISIONS | 2 |
| E-BUILDER ENTERPRISE™ | 2 |
| MATERIALS | 2 |
| LABORATORY TESTING | 3 |
| MEASUREMENT AND PAYMENT | 3 |
| RESTORATION | 4 |
| COOPERATION WITH OTHERS | 4 |
| SITE INVESTIGATION | 4 |
| PROJECT SCHEDULE | 5 |
| PROJECT IDENTIFICATION SIGNS | 6 |
| SOIL EROSION AND SILTATION | 9 |
| SHOP DRAWINGS | 9 |
| SUBSOIL EXCAVATION | 10 |
| DEWATERING, SHEETING AND BRACING | 10 |
| EARTHWORK | 10 |
| TEMPORARY PAVEMENT | 10 |
| MAINTENANCE OF TRAFFIC | 11 |
| STORMWATER DRAINAGE PIPES AND STRUCTURES | 11 |
| MAINTENANCE OF STORM DRAINAGE SYSTEM | 11 |
| POST-CONSTRUCTION STORM PIPE TESTING | 12 |
| SIDEWALKS TO REMAIN OPEN | 12 |
| DUST CONTROL | 12 |
| UNDERGROUND UTILITY LOCATIONS | 12 |
| UTILITY COORDINATION | 13 |
| UTILITY CONFLICTS | 13 |
| DAILY CLEAN-UP REQUIREMENTS | 13 |
| MAINTENANCE AND RESTORATION OF JOB SITE | 14 |
| NOTICE AND SERVICE THEREOF | 14 |
| REQUIREMENTS FOR CONTROL OF THE WORK | 15 |
| USE OF PRIVATE PROPERTY | 15 |
| CONSTRUCTION PHOTOGRAPHY | 15 |
| CONTRACTOR TO EXECUTE NPDES “NOTICE OF INTENT” | 18 |
| WORKSITE TRAFFIC SUPERVISOR | 18 |
| CONTRACTOR’S SUPERVISION | 18 |
| LIST OF EMERGENCY CONTACT NUMBERS & UTILITY SERVICE MAINTENANCE | 19 |

PEDESTRIAN ACCESS 19
THERMOPLASTIC TRAFFIC STRIPES AND MARKINGS 19
RECORD DRAWINGS AND PROJECT CERTIFICATION 20
COMPLIANCE WITH THE SOUTHWEST FLORIDA WATER MANAGEMENT DISTRICT
(SWFWMD) STORMWATER MANAGEMENT AND DISCHARGE PERMIT
REQUIREMENTS AND/OR THE DEPARTMENT OF ENVIRONMENTAL PROTECTION
(DEP) DREDGE AND FILL PERMIT REQUIREMENTS 21
CRUSHED CONCRETE BASE 22
CLARIFICATION OF SPECIFIC LINE ITEMS..... 23
CONTRACT CONTINGENCY 25
SHOP DRAWING SUBMITTAL COVER SHEET 26

SPECIAL PROVISIONS

GENERAL

This Section amends, enhances or otherwise revises the Technical Specifications.

CONTRACT PLANS

The Contract Plans will include the following plan sets:

1. Roadway Plans
2. Signing & Pavement Marking Plans
3. Signalization Plans
4. Utility Relocation Plans

STANDARD SPECIFICATIONS

The standard Specifications to be used for this work shall be Division II and III of the Florida Department of Transportation (FDOT) *Standard Specifications for Road and Bridge Construction*, July 2020 Edition and all Supplemental Specifications thereto, hereinafter referred to as the *Standard Specifications*, for roadway construction, except as amended under this Contract, or as noted on the construction plans meeting the Manatee County Highway, Traffic & Stormwater Standards (dated 2015).

The Contractor's work shall follow the Manatee County Public Works Utility Standards and Specifications (dated February 2020) for all utility work, Bid Form pay items MC-1 through MC-13.

These specifications cover the usual construction requirements for work specified by the County Public Works Department; however, in the event it is determined that the specific work to be done is of such a nature that the method of construction, type and/or kind of material is not defined by the *Standard Specifications*, such work shall be performed in accordance with the Special Provisions.

The apparent silence of the Specifications as to any detail or the apparent omission from them of a detailed description concerning any work to be done and materials to be furnished shall be regarded as meaning that only the best general practice is to prevail and that only material and workmanship of the best quality is to be used. Interpretation of these specifications shall be made upon that basis.

PRIORITY

In any instance where there is an apparent conflict between these technical specifications, special provisions and the corresponding terms of the "Standard Specifications", these special provisions followed by these technical specifications shall be controlling.

NO SEPARATE PAYMENT FOR SPECIAL PROVISIONS

No separate payment will be made for the Contractor to execute Special Provisions. All expenses borne by the Contractor shall be included in the individual unit prices for the particular pay item.

E-BUILDER ENTERPRISE™

a. e-Builder Enterprise™: Project Management Tool

The successful bidder shall be required to use the Internet web-based project management tool, e-Builder Enterprise™ (e-Builder), and protocols included in that software during this project; and shall take any training courses required by the Owner, at no additional cost to the Owner. The use of this project management system does not replace or change any contractual responsibilities of the participants.

User registration, electronic and computer equipment, and Internet connections required for e-Builder are the responsibility of the successful Bidder and its subcontractors. The sharing of user accounts is prohibited. Individuals who are granted log-in access to the County e-Builder platform shall be responsible for the proper use of their passwords and access to data as agents of the successful Bidder. For documents requiring original signature such as Contracts, Change Orders, Application and Certification for Payment, and Field Directives, paper documents may be required in addition to submittal via e-Builder.

b. County Responsibilities

User licenses for e-Builder Enterprise™ will be provided and paid for by the Owner based on assigned roles for the project including Project Manager, Project Fiscal, Project Superintendent, and others as may be required.

MATERIALS

- a. **Delivery Tickets:** It will be necessary to submit a copy of all delivery tickets for materials used on the project, regardless of the basis of payment.
- b. **Job Mix Formula for Asphaltic Concrete:** Attention is directed to the requirement that job mix formulas for asphaltic concrete, of the type specified, be submitted at least 14 days before plant operations begin. The submitted formula should be derived, or approved, by the laboratory approved by the Owner and/or its agents. Costs for such job mix formulation will be paid by the Contractor directly to the assigned laboratory.
- c. **Job Mix Formula for Portland Cement Concrete:** Attention is directed to the requirement that job mix design formulas for all Portland Cement Concrete, of the type specified, be submitted at least 14 days prior to use on the project. The

submitted formulas shall be derived or approved by the Owner and/or its agents. All concrete mix designs shall meet FDOT Concrete Class mix guidelines, except as follows: when approved, in writing by the Engineer, an Alternate Class I Concrete mix design formula, for concrete curb and gutter to be placed by automated curb machines, may show, as a substitution for #57 aggregate, an amount of #89 aggregate not to exceed 33 percent, by weight, of the #57 aggregate.

LABORATORY TESTING

Testing for the Work shall be performed at no expense to the Contractor. However, any test that fails or is not performed, as a result of the Contractor's action will, in turn, be back-charged to the Contractor, including the cost of all re-testing due to defective materials or construction. The testing laboratory shall be approved by the County.

The samples and tests used for determining the quality and acceptability of the materials and workmanship, which have been or are to be incorporated in the Work, shall conform to the requirements of the State of Florida Department of Transportation Materials Sampling, Testing and Reporting Guide, latest edition.

Testing shall also be in accordance with the applicable portions of the *FDOT Standard Specifications* and these specifications.

MEASUREMENT AND PAYMENT

- a. All work completed under the terms of this contract shall be measured according to United States Standard Measures.
- b. All measurements shall be taken horizontally or vertically unless specifically provided otherwise.
- c. No payment will be made for construction over a greater area than authorized, nor for material moved from outside of stakes and data shown on the plans, except when such work is performed upon instructions of the Engineer.
- d. The Contractor shall accept compensation provided under the terms of this contract as full payment for furnishing all materials and for performing all work contemplated and embraced under this contract. Such compensation shall also be for any and all loss or damage arising out of the nature of the work or from the action of the elements, or from any unforeseen difficulties or obstructions encountered during the contract period until final acceptance by the Owner.
- e. Whenever any change, or combination of changes, on the plans results in an increase or decrease in the original contract quantities, and the work added or decreased/eliminated is of the same general character as that called for on the plans, the Contractor shall accept payment in full at the original contract unit prices

for the actual quantity of work performed, with no allowance for any loss of anticipated profits.

- f. It is the Contractor's responsibility to perform a detailed quantity take-off from the plans to determine actual quantities for ordering and delivery purposes. The Owner will not be responsible for quantities ordered in excess of those installed and constructed. The Contractor should be aware that some of the pay items may have contingency quantities. Payment shall be made only for final in-place quantities.

No payment shall be made for contingency quantities or additional work unless otherwise directed and approved in writing by the Engineer.

- g. Bid Schedule Completion - the blank spaces in the bid schedule shall be filled in correctly where each and every item for which a description is given, as the bidder must state the unit prices for which he proposes to do each part of the work contemplated, and the total price for all the parts included in any or all of the combinations of the work. In case of a discrepancy, the written words for "unit price", where stated, shall be considered as being the unit price. If the bid schedule does not use the written words for the unit price, then the numerically correct "total price", shall be considered as being the total price.

RESTORATION

Payment for restoration shall be covered under the applicable restoration Pay Items as specified in the proposal. If a specific restoration Pay Item is not listed in the proposal, the cost of such work shall be included in the applicable Pay Item unless otherwise provided under separate restoration section or pay quantity of these Specifications.

COOPERATION WITH OTHERS

The Contractor shall cooperate with the owners of any underground or overhead utility lines in their removal and rearrangement operations, in order that these operations may progress in a reasonable manner and that service rendered by these parties will not be interrupted. The Owner shall not be responsible for costs associated with delays, disruptions and remobilizations attributed to utility agency scheduling.

SITE INVESTIGATION

The Contractor acknowledges that he has satisfied himself as to the nature and location of the work; the general and local conditions, including but not restricted to those bearing upon transportation, disposal, handling and storage of materials; availability of labor, water, electric power, roads; and uncertainties of weather, water stages, tides or similar physical conditions at the site; the conformation and conditions of the ground; the character of equipment and facilities needed preliminary to and during prosecution of the work.

The Contractor further acknowledges that he has satisfied himself as to the character, quality and quantity of surface and subsurface materials or obstacles to be encountered, insofar as this information presented by the drawings and Specifications made a part of this contract.

The Contractor shall carefully review and adhere to conditions and recommendations made in the project geotechnical report.

Any failure by the Contractor to acquaint himself with the available information will not relieve him from responsibility for estimating properly the difficulty or cost of successfully performing the work.

The Owner assumes no responsibility for any conclusions or interpretations made by the Contractor on the basis of the information made available by the Owner. The Owner also assumes no responsibility for any understanding or representations made by its officers or agents during or prior to the execution of this Contract, unless (1) such understanding or interpretations are made in writing by the Engineer or are expressly stated in the Contract and (2) the Contract expressly provides that the responsibility therefore is assumed by the Owner.

PROJECT SCHEDULE

The Contractor shall submit a preliminary construction schedule with the bid. The preliminary schedule shall show major work items and any phases the Contractor proposes. The schedule will show duration of work items and phases.

The Contractor shall submit a detailed Critical Path Method (CPM) construction schedule within 15 days of the notification of award or its intent for the County to review. The submittal shall meet the following requirements:

- Schedule will be submitted on 11-inch by 17-inch paper.
- The time scale (horizontal) shall be in weeks. The activities shall be listed on the left hand side (vertical).
- Activities shall show most Work activities. The listing from top to bottom shall be in a logical sequence of how the Work will be accomplished. Space shall be provided between activities or within bars to allow for marking of actual progress.

A copy of the CPM schedule, clearly showing progress made, shall be submitted on a monthly basis during the progress of the work at the monthly meeting. Review or acceptance will neither impose on the County responsibility for the progress or scheduling of the Work, nor relieve the Contractor from full responsibility therefore.

The Contractor shall provide a revised CPM schedule if, at any time, the County considers the completion date to be in jeopardy because of “activities behind schedule”. An activity that cannot be completed by its original or latest completion date shall be deemed to be behind

schedule. The revised CPM schedule is designed to show how the Contractor intends to accomplish the Work to meet the contractual completion date. The form and method employed by the Contractor shall be the same as for the original CPM schedule. The cost to prepare and revise the schedule is considered incidental to the Work.

PROJECT IDENTIFICATION SIGNS

The Contractor shall be responsible for furnishing, installing and maintaining three (3) County project identification signs and removal of same upon completion of the construction. Project identification sign shall be constructed and maintained at the project site as directed by the Owner. The Contractor shall erect, maintain and relocate the sign as directed for the duration of the Project.

The Contractor shall mount the sign using 4-inch pressure treated lumber or as approved by the Engineer, and other supports as required, at a location mutually agreed by the Engineer and the Contractor.

The identification signs shall not be less than 32 square feet in area. The Contractor shall coordinate with the Owner for the sign verbiage before fabrication. The signs shall be painted with graphic content to include:

- Title of Project
- Name of Owner
- Names and Titles of authorities, as directed by Owner
- Prime Contractor
- Construction Cost

The signs shall be erected prior to commencement of work at a lighted location of high public visibility, adjacent to the main entrance at each end of the project, as approved by the Engineer and Owner.

The signs shall be a minimum of 8 feet wide and 4 feet high. The signs shall be constructed of high density $\frac{3}{4}$ -inch exterior plywood without waves or buckles, mounted and braced with pressure treated lumber as necessary and maintained in a presentable condition for the duration of the project. Hardware shall be galvanized. The surface of the sign shall be of exterior softwood plywood with medium density overlay.

Painting shall be constructed with materials to resist weathering and fading during the construction period. Experienced professionals shall perform painting. Graphic design and style shall be in accordance with the following:

- The signs will be placed in accordance with Manatee County Development Code, Ordinance 90-01, Section 724, Signs and Section 713, Visibility Triangles.

Payment for installing and maintaining the project identification signs shall be included as part of the lump sum quantity under Pay Item Number 1 (101-1) for Mobilization. The sign will remain the property of the Owner upon completion of the Project unless otherwise directed.



26TH ST. WEST AT 30TH AVE. WEST INTERSECTION IMPROVEMENTS

Board of County Commissioners

VANESSA BAUGH

CHAIR

JAMES SATCHER

REGGIE BELLAMY

KEVIN VAN OSTENBRIDGE

MISTY SERVIA

GEORGE KRUSE

CAROL WHITMORE

CONSTRUCTION COST

\$Enter Amount

PRIME CONTRACTOR

Enter Contractor Name

SOIL EROSION AND SILTATION

The Contractor shall plan and control the Work to minimize all soil erosion and the siltation of drains and canals resulting from such erosion.

At the pre-construction meeting, the Contractor shall present his proposed plan and schedule, which shall specifically indicate the proposed usage of temporary erosion control features. The plan shall include:

- **Synthetic Bales** designed, furnished and installed by the Contractor in accordance with the plans, and FDOT Specifications Section 104.
- **Floating turbidity barriers and staked turbidity barriers** furnished and installed by the Contractor as shown on the plans and/or required by conditions of the permits and as outlined in FDOT Specifications Section 104.

SHOP DRAWINGS

The Contractor shall submit to the Engineer of Record (EOR) for approval, all working drawings and shop drawings with descriptive specifications and engineering calculations necessary for the successful completion of the Work. The shop drawing shall be submitted in pdf format using the Submittals process in the e-Builder project management tool. Each shop drawing shall have a cover sheet and reference the submittal number, following the sample format provided in the contact documents.

The working and shop drawings shall be certified by a Florida licensed Professional Engineer and state that the design is sufficient for the successful completion of the Work. The working drawings and shop drawings shall include, but not be limited to:

- Traffic Control Plan
- Erosion Control Plan
- Shop Drawings as required by FDOT Standard Specifications

e-Builder will serve as the Submittal Activity Record (Logbook) for this project and can be accessed at all times by all members of the project that have an e-Builder account. The following minimum data is recorded by e-Builder for each submittal:

- County Project Number and Name
- Submittal Number
- Description of Submittal
- Submittal Documents in PDF format
- Date Contractor Transmits Submittal to the EOR
- Date EOR Transmits the Shop Drawing back to the Contractor with one of the following dispositions noted: Approved, Approved w/ Notes, Confirm and Resubmit, See Notes and Resubmit, or Rejected, Resubmit.
- Review comments and redlined shop drawings from the EOR

- Current status

The information recorded within e-Builder is a historical record of the activity devoted to an individual submittal as well as that for the project as a whole. It can serve as a verification of review time, to respond to inquiries of a particular submittal's status and as a record of manpower effort to aid in estimating and allocating future workload.

SUBSOIL EXCAVATION

The contractor shall detect and remove all unsuitable material, such as plastic/organic soil, rock, hard plane, debris and trash, within project limit, following FDOT Standard Plans Index 120-002. Payment for subsoil excavation shall be included in the subsoil excavation pay items.

DEWATERING, SHEETING AND BRACING

The contractor shall determine the need of dewatering, sheeting and bracing to facilitate the construction, conforming to current SWFWMD/FDEP rule and OSHA safety criteria. Payment for dewatering, sheeting and bracing shall be included in the applicable item for earthwork, unless separate pay items are specified.

APPROVAL OF DEWATERING PLAN:

At least 10 days prior to the commencement of any dewatering activity, the Contractor shall obtain the approval from SWFMWD, or FDEP (if water needs to be discharged offsite into the state surface water), and submit the permit with a detailed description of the proposed dewatering system to the Project Manager. The dewatering plan shall include design computations, layout, type, and spacing of dewatering devices, number and size of pumps and other equipment, with a description of the installation and operating procedures.

EARTHWORK

Quantities included on cross-section sheets, if any, represent estimated in-place quantities and do not include shrinkage and expansion factors. The quantities were calculated by the method with average end areas between the station-to-station limits. Payment for Earthwork shall be made based on average end area method calculations. Contractor shall provide supporting survey data (before and after cross-sections) and calculations for payment purposes

The ownership of dirt excavated from the easement area shall be determined by Manatee County engineer.

TEMPORARY PAVEMENT

Temporary pavement shall consist of a minimum of Optional Base Group 4 and one (1) inch of Type SP structural course (Traffic C) over a firm, unyielding, well-compacted subgrade. The Contractor shall immediately repair all potholes that develop within the

project limits and shall maintain a supply of cold mix on the project site to expedite these repairs.

The Temporary by-pass road shall provide adequate cover and protection of existing utilities. It is the Contractor's responsibility to coordinate with utility companies to repair any damages to the exiting utilities during the construction at no additional cost to the County.

Payment for the temporary pavement and maintenance of this pavement shall be included under Maintenance of Traffic.

MAINTENANCE OF TRAFFIC

The Contractor shall provide access to local businesses and residents at all times. No road closures will be allowed between the hours of 6AM to 7PM. Temporary by-pass lanes may be constructed at all tie-in locations during the MOT phasing. The payment for temporary by-pass lanes shall be included in Maintenance of Traffic. Business Entrance signs per FDOT Standard Plans Index 102-600 shall be placed at all business entrance points and maintained during all phases of construction. Payment for these items shall be included under the pay item for Maintenance of Traffic.

Temporary pavement marking shall be paid under Maintenance of Traffic. Temporary Striping and Marking during 30 day cure time of the asphalt shall be part of the pay item for Maintenance of Traffic, in accordance with FDOT Standard Specifications Section 102-1.

The Contractor shall prepare a Maintenance of Traffic plan and submit it to the Project Manager for review prior to implementation. It must comply with all FDOT safety criteria, FDOT Standard Plans Index 102-series, FHWA and MUTCD standards, and allow for traffic to operate in daytime or nighttime. The Maintenance of Traffic Plan will require the seal of a Florida licensed Professional Engineer with a current FDOT Advance Work Zone certification if any change is made to the FDOT Standard Plans Index 102-series. No road closures will be allowed without approval from the Project Manager.

STORMWATER DRAINAGE PIPES AND STRUCTURES

All proposed storm structure shall have a wall thickness no less than 6 inch. Metal storm pipe or metal mitered end section shall not be used in the road right of way or carry right of way runoff.

MAINTENANCE OF STORM DRAINAGE SYSTEM

The Contractor shall be responsible at all times to maintain the operation of existing stormwater facilities, or, when existing stormwater facilities are removed, to provide equivalent capacity alternate forms of stormwater removal adequate to prevent upstream flooding in excess of existing conditions. This responsibility shall include the installation of temporary connections, bypass pumping, or other temporary means necessary until

the new drainage system is fully operational. Payment for these items shall be included under the applicable pay item for new storm systems.

POST-CONSTRUCTION STORM PIPE TESTING

The Contractor shall inspect and televise all newly constructed storm pipes on the project. Video DVD and report shall be provided for those pipes whose diameters are equal or smaller than 48 in, with Laser profile data included for non-RCP pipes, following FDOT Specifications latest version. The purpose is to assure the pipes are properly constructed and do not leak at the joints. Payment for this item shall be included under the pay item for Mobilization.

SIDEWALKS TO REMAIN OPEN

Existing sidewalks and proposed sidewalks completed during construction shall remain open at all times unless approved otherwise by the Engineer. Temporary sidewalk shall be constructed as shown in the plans or as required to maintain pedestrian movement. Payment for these items shall be included under the lump sum pay item for Maintenance of Traffic.

If the Contractor, in the process of performing his contract operations, breaks any of the existing sidewalk that is to remain in place, replacement of this sidewalk will be at the Contractor's expense.

DUST CONTROL

The Contractor shall control dust resulting from construction operations at all times. The locations and frequencies of applications shall be as directed by the Engineer. Contractor shall provide dust control measures using water sources as needed and maintaining dust control throughout duration of the project. Payment for Dust Control shall be made under Maintenance of Traffic unless separate pay item for Dust Control is specified.

UNDERGROUND UTILITY LOCATIONS

The Contractor shall field verify existing underground utility locations by means of subsurface locating or other approved method. All existing utilities shall remain unless otherwise noted on the plans. The Contractor shall locate all existing utilities to remain at potential conflict locations prior to construction activities and before ordering any proposed structures. The Contractor shall contact and coordinate with "Sunshine State One Call 811" as well as the individual utilities prior to and during construction for utility locations, relocation and assistance while installing in potential conflict areas. All utility coordination and relocations shall be factored into the Contractor's construction schedule at no additional cost to the Owner.

The cost of all labor, materials and incidentals required for the performance of any survey and utility location work shall be included under the pay item for Mobilization. A Florida registered land surveyor shall perform all survey work.

UTILITY COORDINATION

The Contractor shall be responsible for coordination of the work with all affected utility owners. The Contractor must take into consideration the required utility adjustments and relocations in development of his schedule for completing the work including construction of temporary work to allow phased construction of the permanent facilities.

The Contractor shall coordinate and schedule utility relocations and/or adjustments with the utility owners along the project in order to avoid delays. The work includes remobilization if required after utility relocation is complete. The intent is to coordinate utility construction activities so the project construction continues and is not stopped or delayed at any time due to utility work being done. Once Notice to Proceed is issued, the Contractor shall contact the affected utilities to discuss the Contractor's anticipated means and methods so temporary and permanent relocation plans can be implemented as needed to meet OSHA safety requirements.

The Contractor shall hold a utility owners meeting every two weeks / or alternate time schedule agreed to by the Owner at 1022 26th Avenue East. The meeting shall review current and upcoming activities for the project. Written meeting minutes will be prepared by the Contractor and distributed to the meeting participants within 3 calendar days of the meeting.

UTILITY CONFLICTS

It shall be the Contractor's responsibility to avoid conflicts with other utilities. The Owner will not be responsible for additional costs incurred by the Contractor for incorrect installations, relocations and breaks due to service conflicts.

The contractor's equipment shall maintain a minimum clearance distance to the power line (10 feet for voltage up to 50kv, 15 feet for voltage over 50kv to 200kv, 20 feet for voltage over 200kv to 350kv, 25 feet for voltage over 350kv to 500kv, 35 feet for voltage over 500kv to 750kv, 45 feet for voltage over 750kv to 1,000kv.), following new OSHA Rule (29 CFR Part 1926) and FDOT Roadway Design Bulletin 11-03 DCE Memorandum 02-11.

DAILY CLEAN-UP REQUIREMENTS

The Contractor shall clean up the job site at the end of each workday. Clean up will include the elimination of rubble and waste material on public and private property. Driveways shall remain accessible by residents. Each Friday, the Contractor shall prepare the road surface and barricades in an acceptable manner for weekend traffic use.

MAINTENANCE AND RESTORATION OF JOB SITE

The Contractor shall conduct his operations in such a manner as will result in a minimum of inconvenience to occupants of adjacent homes and business establishments and shall provide temporary access as directed or as may be required by the Project Manager. All final restoration must be performed to an equal or better condition than that which existed prior to construction.

Good housekeeping on this project is extremely important and the Contractor will be responsible for keeping the construction site neat and clean, with debris being removed daily as the work progresses or as otherwise directed by the Project Manager. Good housekeeping at the job site shall include: Mowing as necessary to prevent grass and other vegetation within the work area from exceeding 18 inches in height or causing unsafe conditions; Removing all tools and temporary structures, dirt, rubbish, etc.; hauling all excess dirt, rock, etc., from excavations to a dump provided by the Contractor; and all clean up shall be accomplished to the satisfaction of the Project Manager. Dust will be controlled daily as may be required. Immediately after construction completion in an area or part thereof (including restoration), barricades, construction equipment and surplus and discarded materials shall be removed by the Contractor.

In the event that the timely housekeeping and restoration of the job site is not accomplished to the satisfaction of the Project Manager, the Project Manager shall make arrangements to affect the necessary housekeeping and restoration by others. The Contractor shall be charged for these costs through deductions in payment due the contractor. If such action becomes necessary on the part of and in the opinion of the Project Manager, the Owner shall not be responsible for the inadvertent removal from the work site of materials which the Contractor would not normally have disposed of had he affected the required clean up.

NOTICE AND SERVICE THEREOF

All notices, which shall include demands, instructions, requests, approvals, and claims shall be in writing. Any notice to or demand upon the Contractor shall be sufficiently given if delivered to the office of the Contractor specified in the bid (or to such other office as the Contractor may, from time to time, designate to the Owner in writing), or if deposited in the United States mail in a sealed, postage prepaid envelope, or delivered, with charges prepaid, sent via fax transmission, or to any telegraph company for transmission, in each case addressed to such office.

All notices required to be hand delivered to the Owner, unless otherwise specified in writing to the Contractor, shall be delivered to the Project Manager, and any notice to or demand upon the Owner shall be sufficiently given as delivered to the office of the Project Manager, or if deposited in the United States mail in a sealed, postage prepaid envelope, sent via fax transmission, or delivered with charges prepaid to any telegraph company for transmission, in each case addressed to said Project Manager or to such other

representative of the Owner or to such other address as the Owner may subsequently specify in writing to the Contractor for such purposes.

Any such notice or demand shall be deemed to have been given or made as of the time of actual delivery or (in the case of mailing) when the same should have been received in due course of post or in the case of a fax transmission or telegram at the time of actual receipt, as the case may be.

REQUIREMENTS FOR CONTROL OF THE WORK

Prior to the start of the Work described in this contract, a pre-construction conference may be held by the Project Manager to be attended by the Contractor and representatives of the various utilities and others as required, for the purpose of establishing a schedule of operations which will coordinate the work to be done under this contract with all related work to be done by others within the limits of the project.

All items of work in this contract shall be coordinated so that progress of each related item will be continuous from week to week. The progress of the work will be reviewed by the Project Manager at the end of each week, and if the progress of any item of work during that week is found to be unsatisfactory, the Contractor shall be required to adjust the rate of progress on that item or other items as directed by the Project Manager without additional compensation. The Contractor will continuously control the work until completed.

USE OF PRIVATE PROPERTY

All construction activities required to complete this project in accordance with the Contract Documents shall be confined to public right-of-way, easements of record or temporary construction easements, unless the Contractor makes specific arrangements with private property owners for his use of their property. Written authorization from the granting property owner shall be placed on file with the Project Manager prior to utilization of said private properties. The Owner assumes no responsibility for damage to private property in such instances. The Contractor is responsible for protection of private property abutting all work areas on this project. Adequate equipment storage and material storage shall also be accomplished outside the Owner's right-of-way. Pipe and other materials shall not be strung out along the right-of-way, but will be delivered in quantities adequate for one day's installation. The Owner will coordinate with the Contractor to identify possible storage sites.

CONSTRUCTION PHOTOGRAPHY

General

The Contractor shall employ a competent photographer to take construction record photographs and perform videotaping, including providing all labor, materials, equipment and incidentals necessary to obtain photographs and/or videotapes of all areas specified in the Contract specifications.

The word "Photograph" includes standard photographic methods involving negatives, prints and slides and it also includes digital photographic methods involving computer technology items such as diskettes and CD-ROMs.

Qualifications

A competent camera operator who is fully experienced and qualified with the specified equipment shall do all photography.

For the videotape recording, the audio portion should be done by a person qualified and knowledgeable in the specifics of the Contract, who shall speak with clarity and diction so as to be easily understood.

General

The Contractor shall employ a competent photographer to take construction record digital photos and perform video recording, including providing all labor, materials, equipment and incidentals necessary to obtain photos and/or video recordings of all areas within the project limits or as otherwise specified in the Contract specifications.

The word "Photo" includes standard photographic methods involving digital photography and production of hard copies for photos and saving photos as jpg files on diskettes and CD-ROMs.

Qualifications

A competent camera operator who is fully experienced and qualified with the specified equipment shall do all photography.

For the video recording, the audio portion should be done by a person qualified and knowledgeable in the specifics of the Contract, who shall speak with clarity and diction so as to be easily understood.

Project Photos for Construction Progress

Provide photos of the entire work area during construction for the purpose of records of completed work. Photos should be spaced at approximately 100-foot intervals. Three prints of each standard photograph shall be provided to the County. In addition to the CD_ROM media, one print of each digital photograph shall be provided to the County.

The Contractor shall pay all costs associated with the required photographs and prints. Any parties requiring additional photography or prints will pay the photographer directly.

Each print shall have clearly marked on the back the name of the project, the orientation of view, the date and time of exposure, name and address of photographer and the photographers numbered identification of exposure.

All project photographs shall be a single weight, color image. All finishes shall be smooth surface and glossy, and all prints shall be 8 inches by 10 inches.

All project photos shall be taken from locations to adequately illustrate conditions prior to construction, or conditions of construction and state of progress. The Contractor shall consult with the County Representative at each period of photography for instructions concerning views required.

The Contractor shall deliver photos in conformance with the above requirements to the County Representative. No construction shall begin until pre-construction photo are completed and submitted to the County Representative.

Record Photos

The Contractor shall require that photographer maintain digital copies of photos for a period of two years from date of Substantial Completion of the Project.

Photographer shall agree to furnish additional prints to the County Representative at commercial rates applicable at the time of purchase. Photographer shall also agree to participate as required in any litigation requiring the photographer as expert witness.

Video Recording for Pre-Construction

Video recording shall be used in lieu of photos for pre-construction. It shall be of sufficient quality to fully illustrate details of conditions and construction, including special features

Video recording shall be accomplished along all routes that are scheduled for construction.

The video recording shall, when viewed, depict an image with $\frac{1}{4}$ of the image being the roadway fronting of property and $\frac{3}{4}$ of the image being of the property. The video recording shall be done so as to show the roadway and property in an oblique view (30 degrees).

A complete view, in sufficient detail, of all driveways, with audio description of the exact location shall be provided.

The Engineering plans shall be used as a reference for stationing in the audio portion of the video recording for easy location identifications. If visible, house numbers shall be mentioned on the audio.

Two complete sets of video recording shall be delivered to the Owner for the permanent and exclusive use of the Owner prior to the start of any construction on the project.

All video recording shall contain the name of the project, the date and time of the video recording the name and address of the photographer and any other identifying information required.

Payment for this item shall be included under the pay item for Mobilization.

CONTRACTOR TO EXECUTE NPDES “NOTICE OF INTENT”

Prior to proceeding with construction, the Contractor shall prepare and submit a “Notice of Intent to Use Generic Permit for Stormwater Discharge from Construction Activities that Disturb One or More Acres of Land” to the Florida Department of Environmental Protection (FDEP). The Contractor shall monitor the site at all times and take appropriate action to prevent erosion including the use of BMPs. No pumping of ground or surface water shall be performed without approval from the Water Management District. Following completion of construction, Contractor shall prepare and submit a “Notice of Termination of Generic Permit Coverage” to FDEP. Payment for this item shall be included under the pay item for Mobilization.

WORKSITE TRAFFIC SUPERVISOR

- a. The Contractor shall have a Worksite Traffic Supervisor who will be responsible for initiating, installing and maintaining all traffic control devices as described in Section 102 of the FDOT Standard Specifications and in the Plans. The Worksite Traffic Supervisor shall have at least one year of experience directly related to work site traffic control in a supervisory or responsible capacity and shall be certified by the American Traffic Safety Services Association Worksite Traffic Supervisor Certification Program or an equal approved by FDOT. Approved alternate Worksite Traffic Supervisors may be used when necessary.
- b. The Worksite Traffic Supervisor shall be available on a 24-hour per day basis and shall review the project on a day-to-day basis as well as being involved in all changes to traffic control. The Worksite Traffic Supervisor shall have access to all equipment and materials needed to maintain traffic control and handle traffic related situations. The Worksite Traffic Supervisor shall ensure that routine deficiencies are corrected within a 24-hour period.
- c. The Worksite Traffic Supervisor shall be available on the site within 45 minutes after notification of an emergency situation, prepared to positively respond to repair the work zone traffic control or to provide alternate traffic arrangements.
- d. Failure of the Worksite Traffic Supervisor to comply with the provisions of the Sub-article may be grounds for decertification or removal from the project or both. Failure to maintain a designated Worksite Traffic Supervisor or failure to comply with these provisions will result in temporary suspension of all activities except traffic and erosion control and such other activities deemed to be necessary for project maintenance.
- e. Payment for Worksite Traffic Supervisor shall be included under the pay item for Maintenance of Traffic.

CONTRACTOR’S SUPERVISION

- a. Prosecution of Work: The Contractor shall give the work the constant attention necessary to assure the scheduled progress. He shall cooperate fully with the Project Manager and with other Contractors at work in the vicinity.

- b. Contractor's Superintendent: The Contractor shall at all times have on the work site as his agent, a competent superintendent capable of thoroughly interpreting the plans and specifications and thoroughly experienced in the type of work being performed, who shall receive the instructions from the Project Manager or his authorized representatives. The superintendent shall have full authority to execute the orders or directions of the Project Manager and to supply promptly any materials, tools, equipment, labor and incidentals that may be required. Such superintendence shall be furnished regardless of the amount of work sublet.
- c. The Contractor's superintendent shall speak and understand English, and at least one responsible person who speaks and understands English shall be on the project during all working hours, and wherever work is being done by the contractor.
- d. Supervision for Emergencies: The Contractor shall have a responsible person available at or reasonably near the work site on a 24-hour basis, 7 days a week, in order that he may be contacted for emergencies and in cases where immediate action must be taken to maintain traffic or to handle any other problem that may arise. The Contractor's responsible person for supervision for emergencies shall speak and understand English. The Contractor shall submit, by certified mail, phone numbers and names of personnel designated to be contacted in cases of emergencies along with a description of the project location to the Florida Highway Patrol and all other local law enforcement agencies.

LIST OF EMERGENCY CONTACT NUMBERS & UTILITY SERVICE MAINTENANCE

The Contractor shall obtain and maintain a list of emergency contact phone numbers for all utilities during the course of the project. The Contractor shall maintain utility service during the project except for interruptions authorized by the utility owner. If interruptions are required, the Contractor shall notify the Owner 48 hours in advance.

PEDESTRIAN ACCESS

The Contractor shall provide access and make provisions to maintain school zones during construction. The Contractor is to facilitate pedestrian traffic whether for school or public transportation.

THERMOPLASTIC TRAFFIC STRIPES AND MARKINGS

Do not place thermoplastic traffic stripes and markings on newly constructed final surface courses prior to 30 calendar days after placement of the final surface course. The Engineer may require longer cure periods. Provide temporary pavement markings during the interim period if the road is open to traffic. The price of temporary pavement marking shall be included in the Maintenance of Traffic.

RECORD DRAWINGS AND PROJECT CERTIFICATION

The County will furnish the Contractor copies of the bid plans to be used for the record drawings. A Florida Registered Surveyor shall perform a field survey and any differences between the plan elevations or dimensions shall be marked through and the as-built elevation or dimension legibly entered. All elevations and dimensions that are correct shall have a check mark placed beside it.

The Contractor shall keep a complete set of surveyed "As-built" records. These records shall show all items of Work and existing features of utilities revealed by excavation work. The records shall be kept in a professional manner, in a form that shall be approved by the County prior to the Work. These results shall be available at all times during construction for reference by the Engineer and shall be delivered to the Engineer upon completion of the Work. All completed "As-builts" must be certified by a Florida Licensed Surveyor or Engineer per Chapter 61 G 17-6, Florida Administrative Code, pursuant to Sec. 47207, Florida Statutes. All Record Drawings shall be in accordance with current Manatee County Standards.

The "Record Drawings" shall, at a minimum, include the following:

- A. Roadway centerline profile [100-foot maximum interval].
- B. Roadway cross sections [100-foot maximum interval].
- C. All underground piping with elevations and dimensions, changes to piping locations, horizontal and vertical locations of underground utilities and appurtenances referenced to permanent surface improvements. Actual installed pipe material, class, etc. Dimensions at these locations shall indicate distance from the centerline of construction.
- D. Elevations on all drainage control structures, verifying all plan dimensions.
- E. Stormwater ponds with cross sections [25-foot maximum interval] (sufficient to calculate volumes).
- F. Flow line elevations on all ditch breaks (vertical and horizontal).
- G. Field changes of dimensions and details.
- H. Details not on original contract drawings.
- I. Equipment and piping relocations.
- J. The locations of all headwalls, pipes and any other structures shall be located by station and offset.
- K. Benchmarks and elevation datum shall be indicated.
- L. Additional elevations or dimensions as required by the Engineer
- M. Additional elevations or dimensions as required by the County Representative

Following completion of construction and prior to final payment, the Contractor shall submit a Certification by the Contractor and Manufacturer including test data that the materials (filter fabric, filter media, etc.) installed meet plan specifications and regulatory requirements.

Upon completion of the work, four (4) sets of draft "Record Drawings" shall be submitted to the Owner for review. Such drawings shall accurately show all approved field changes to the original Construction Drawings, including actual locations, dimensions and elevations and shall be subject to a field review in the presence of the Engineer or his designated representative. The drawings are to be prepared by competent personnel, neatly drafted and certified, signed and sealed by a Florida Registered Surveyor.

The Contractor shall incorporate any comments from the Owner and/or Engineer and shall submit two write-only CD-ROMs, one set of 11-inch by 17-inch mylar record drawings and four sets of 11-inch by 17-inch certified prints with the Surveyor's certification.

All Digital Drawings shall be identical to those submitted as hard copy. The Digital Drawing files shall be AutoCAD format (Release 2010 or later) and shall include all external reference drawings, text fonts, shape files and all other files necessary to make use of the drawings.

In addition, \$150,000 or five percent (whichever is smaller) of the Contract price shall be retained until the County Representative has approved the "Record Drawings". The County Representative will review and approve the "Record Drawings" within 30 days unless additional information is required. No final payment shall be made until such time as the "Record Drawings" have been approved and accepted by SWFWMD for Maintenance and Operation Phase Transfer. Unless there is a separate pay item for Record Drawings, payment shall be included as part of the lump sum quantity for Mobilization.

COMPLIANCE WITH THE SOUTHWEST FLORIDA WATER MANAGEMENT DISTRICT (SWFWMD) STORMWATER MANAGEMENT AND DISCHARGE PERMIT REQUIREMENTS AND/OR THE DEPARTMENT OF ENVIRONMENTAL PROTECTION (DEP) DREDGE AND FILL PERMIT REQUIREMENTS

Southwest Florida Water Management District Stormwater Management and Discharge permits or exemptions, if any, and/or a Department of Environmental Protection Dredge and Fill permit, if any, required for this project have been obtained by the County. The Contractor shall comply with the stipulations of the Permits or Exemptions as stated herein.

The Contractor shall allow periodic inspection of the work by authorized representatives of the Department of Environmental Protection, the Southwest Florida Water Management District, as well as other duly authorized law enforcement officers of the State.

CRUSHED CONCRETE BASE

Crushed Concrete Base shall follow FDOT Standard Specifications 2020 (July), Section 911. The layer coefficient of 0.18 with Limerock Bearing Ratio (LBR) minimum 150 is allowed to calculate the base thickness.

Only FDOT certified piles are acceptable to this project. The producing process certified by FDOT without the actual pile certified is not considered solid enough for the acceptance of the material. The contract shall send the engineer the deliver tickets with FDOT certified pile number, pile location, project name and manufactory contact information shown.

Additional tests and pile inspections will be required for the quality control and the contractor will be responsible for the cost of the initial ten tests and any re-tests when needed. The material will be rejected by the County if the initial test fails. The rejected material shall be completely removed from the project site.

1) Regarding structural number on Crushed Concrete Base, Manatee County to approve SN 0.18 if following criteria is met and maintained:

- A) Limerock Bearing Ratio value of 150 or greater.
- B) Gradation conforms to FDOT Specifications 2020 (July), Section 911.
- C) Deleterious materials conform to FDOT Specifications 2020 (July), Section 911.
- D) Delivery ticket indicates FDOT approved source, actual lot allocated to a particular project.
- E) Piles or lots to be inspected by Manatee County representative prior to acceptance.

2) Regarding Limerock Bearing Ratio value:

- A) No Limerock Bearing Ratio value less than 150, with no under tolerance.

3) Regarding source approval:

- A) FDOT approved source, allocated lot sufficient to serve project's needs, delivery tickets stating FDOT approved source, project name, FDOT preapproved lot or pile number.

4) Regarding deleterious materials:

- A) Deleterious material content in addition to the FDOT Specifications 2020 (July), Section 911, should state that no construction debris such as

Styrofoam insulation, telephone wire, lumber, shingles, aluminum window or door frames etc., or household trash ie: bottles, cans, paper goods etc. is acceptable.

5) Material source inspection:

A) Prior to acceptance of base product, a representative of Manatee County will visit the Producer's location and obtain a sample of the proposed base for the specified project. In addition to sampling, the pile will be visually inspected for deleterious materials, substantial segregation, or any other undesirable characteristics. The pile shall have a traceable identification by pile number or lot number and an accurate quality assessment.

6) Import and placement of base product:

A) During import of base product, a county inspector or duly designated representative of the county will be onsite monitoring incoming loads, making visual assessments of the product and checking load tickets for verification of materials.

7) Import and placement of base product:

A) After spreading out, prior to compacting, samples of the base product will be obtained by Manatee County approved testing lab, every 500 LF staggering right, left, center of the roadway for Limerock Bearing Ratio, gradation and deleterious material testing.

8) Rejection of materials:

A) Material not meeting above requirements will subject to rejection and be removed from the project site. Any three (3) concurrent rejections will require immediate shut down of imported material and require review and remedies prior to restart.

9) Compaction of material:

A) In place material shall achieve 98% of AASHTO T-180 compaction.

CLARIFICATION OF SPECIFIC LINE ITEMS

Clarification of the County's expectations of work to be performed as it relates to specific line items and/or Item No. listed on the Bid Form is included in the FDOT Basis of Estimate Manual. Where such item number is not available, the description shows herein will prevail.

Line Item #1, [FDOT 101-1] – Mobilization, shall include full compensation for the required 100 percent (100%) Performance Bond, 100 Percent (100%) Payment Bond, all required insurance for the project and the Contractor's mobilization and demobilization costs as shown in the Bid Form. Mobilization includes, but is not limited to: preparation and movement of personnel, equipment, supplies and incidentals such as safety and sanitary supplies/facilities.

Payment for mobilization shall not exceed 10 percent (10%) of the total Contract cost unless the Contractor can prove to the County that the actual mobilization cost exceeds 10 percent (10%).

Partial payments for this Bid Item will be made in accordance with the following schedule:

| Percent of Original Contract Amount | Percent Allowable Payment of Mobilization/Demobilization Bid Item Price |
|-------------------------------------|---|
| 5 | 25 |
| 10 | 35 |
| 25 | 45 |
| 50 | 50 |
| 75 | 75 |
| 100 | 100 |

Payments for this line item will be subject to the standard retainage provided in the Contract. Payment for the retainage will be made after completion of the work and demobilization.

Line Item #2, [FDOT 102-1] – Maintenance of Traffic, shall include the cost of all maintenance of traffic operations unless a separate pay item is provided.

Line Item #12, [FDOT 285-704] – Optional Base (Base Group 04), is provided for temporary pavement as shown in the traffic control plans.

Line Item #23, [MC-202.2] – Manatee County Curb Inlet Type 202.2, shall follow Manatee County's Highway, Traffic & Stormwater Standards dated 2007.

Line Item #31, [FDOT 522-1] – Concrete sidewalk and driveways, 4" thick, shall follow Manatee County's Highway, Traffic & Stormwater Standards dated 2007.

Line Item #32, [FDOT 522-2] - Concrete sidewalk and driveways, 6" thick, shall follow Manatee County's Highway, Traffic & Stormwater Standards dated 2007. The payment shall include reinforcement and ramps.

Line Item #59, [FDOT 635-2-11] – Pull & Splice Box, F&I, 17”x30” cover size, shall follow Manatee County Traffic Standard sizing requirements.

Line Item #63, [FDOT 639-4-6] – Emergency Generator – Portable, Install Housing Only, shall include all costs incidental to the housing and foundation / pad.

Line Items #88 through 100, [MC-1 through MC-13], are defined by Manatee County Infrastructure Engineering Standard Specifications Section 01150 – Measurement and Payment. See Section 1.07 Unit Price Item for details.

CONTRACT CONTINGENCY

The discretionary work (Contingency) pay item shall cover the cost for various contingencies and contract amendments authorized by the Owner. Any amount of extra work and/or alterations to the proposed work charged to the allowance shall be fully documented and authorized by the Project Manager before the start of the work. No payment shall be made for work completed without written authorization from the Owner or Engineer.

Date: ___/___/____

Submittal No.

SHOP DRAWING SUBMITTAL COVER SHEET

(IFB) # [Insert IFB Number]

Project Name: [Insert Full Project Name]

Project File No.: [Insert Project Number]

Specification Title Number: [Insert Section No.] Specification No.: Part [Insert Part No.], [Insert Item No.]

Page(s): [Insert Page No.]

Submittal Description: [Insert Title, Description of Submittal and Use]

| SHOP DRAWING REVIEW | |
|--|--|
| RESPONSE NOT REQUIRED | RESPONSE REQUIRED |
| <input type="checkbox"/> NO EXCEPTIONS TAKEN <input type="checkbox"/> NOTE MARKINGS | <input type="checkbox"/> NOTE MARKINGS, CONFIRM <input type="checkbox"/> NOTE MARKINGS, RESUBMIT <input type="checkbox"/> REJECTED, RESUBMIT |
| <p>Engineer's review is for general conformance with the design concept and contract documents. Markings or comments shall not be construed as relieving the Contractor from compliance with the project drawings and specifications, nor departure therefrom. The Contractor remains responsible for details and accuracy, for confirming and correlating all quantities and dimensions, for selecting fabrication processes, for techniques of assembly, and for performing his work in a safe manner.</p> <p style="text-align: center;">MANATEE COUNTY PUBLIC WORKS DEPARTMENT</p> <p>By: _____ Date: _____</p> | |

Your Company Logo and/or information

[Contractor's Name]

[Contractor's Title]

[Company Name]

[Company Address]

[Office Number]

[Fax Number]

[email address]

[Approval Signature: _____]

[Approval Date: ___/___/____]

BID ATTACHMENT 3, PLAN SET / DRAWINGS

NOTE - This attachment is uploaded as a separate document on the Procurement page of the County website with the solicitation document and available for download.



Geotechnical Engineering Report

**26th Street West and 30th Avenue West
Manatee County, Florida**

March 6, 2020

Terracon Project No. HC165091

Prepared for:

HDR, Inc.
Sarasota, Florida

Prepared by:

Terracon Consultants, Inc.
Sarasota, Florida



March 6, 2020

HDR, Inc.
2601 Cattlemen Road, Suite 400
Sarasota, Florida 34232



Attn: Mr. Jason Starr, P.E.
P: (941) 342-2711
E: Jason.Starr@hdrinc.com

Re: Geotechnical Engineering Report
26th Street West and 30th Avenue West
26th Street West & 30th Avenue West
Manatee County, Florida
Terracon Project No. HC165091

Dear Mr. Starr:

We have completed the Geotechnical Engineering services for the above referenced project. This study was performed in general accordance with Terracon Proposal No. PHC165091 dated October 26, 2017. This report presents the findings of the subsurface exploration and provides geotechnical recommendations for the planned new signal poles and pavements.

We appreciate the opportunity to be of service to you on this project. If you have any questions concerning this report or if we may be of further service, please contact us.

Sincerely,
Terracon Consultants, Inc.

James M. Jackson, P.E.
Department Manager
FL License No. 77733

Douglas S. Dunkelberger, P.E.
Principal
FL License No. 33317

This item has been digitally signed and sealed by James M. Jackson, P.E. on the date adjacent to the seal.
Printed copies of this document are not considered signed and sealed and the signature must be verified on any electronic copies.

REPORT TOPICS

| | |
|--|----------|
| INTRODUCTION | 1 |
| SITE CONDITIONS | 1 |
| PROJECT DESCRIPTION | 2 |
| GEOTECHNICAL CHARACTERIZATION | 3 |
| GEOTECHNICAL OVERVIEW | 4 |
| GENERAL COMMENTS | 4 |

Note: This report was originally delivered in a web-based format. **Orange Bold** text in the report indicates a referenced section heading. The PDF version also includes hyperlinks which direct the reader to that section and clicking on the **GeoReport** logo will bring you back to this page. For more interactive features, please view your project online at client.terracon.com.

ATTACHMENTS

EXPLORATION AND TESTING PROCEDURES
SITE LOCATION AND EXPLORATION PLANS
EXPLORATION RESULTS
SUPPORTING INFORMATION

Note: Refer to each individual Attachment for a listing of contents.

Geotechnical Engineering Report
26th Street West and 30th Avenue West
26th Street West & 30th Avenue West
Manatee County, Florida
Terracon Project No. HC165091
March 6, 2020

INTRODUCTION

This report presents the results of our subsurface exploration and geotechnical engineering services performed for the proposed new signal pole foundations to be located at 26th Street West & 30th Avenue West in Manatee County, Florida. The purpose of these services is to provide information and geotechnical engineering recommendations relative to:

- Subsurface soil conditions
- Groundwater conditions
- Soil parameters for pole foundation design

The geotechnical engineering Scope of Services for this project included the advancement of two test borings to depths of approximately 30 feet below the existing ground surface (bgs) and five pavement cores with DCP testing to depths of about 2 ½ feet below the existing pavement surface.

Maps showing the site and boring locations are shown in the **Site Location** and **Exploration Plan** sections, respectively. The results of the laboratory testing performed on soil samples obtained from the site during the field exploration are included on the boring logs in the **Exploration Results** section.

SITE CONDITIONS

The following description of site conditions is derived from our site visit in association with the field exploration and our review of publicly available geologic and topographic maps.

| Item | Description |
|------------------------------|--|
| Parcel Information | The project is located at the intersection of 26 th Street West and 30 th Avenue West in Manatee County, Florida. See Site Location |
| Existing Improvements | 26 th Street West is a four-lane road with grass shoulders and concrete sidewalks. 30 th Avenue West is a two-lane road with grass shoulders and concrete sidewalks. |
| Current Ground Cover | The planned signal pole locations are covered with short grasses. |

Geotechnical Engineering Report

26th Street West and 30th Avenue West ■ Manatee County, Florida

March 6, 2020 ■ Terracon Project No. HC165091



| Item | Description |
|----------------------------------|---|
| Existing Topography | The USGS topographic map for Bradenton, Florida (1987) indicates the site is at an elevation of about +20 feet-NGVD and suggests that the site is built-up land (i.e. developed). |
| Prior Land Use | Review of aerial photographs (ref. Google Earth) indicate the site has been developed with 26 th Street West from sometime prior to 1994. 30 th Avenue West on the east side of 26 th Street West appears to have been constructed by 2002. |
| Surficial Soil Conditions | <p>Review of the Soil Survey for Manatee County, Florida issued April 1983 indicates the site is mapped with Soil Unit 20, EauGallie fine sand. The typical soil profile consists of fine sand to a depth of 42 inches and underlain by loamy fine sand to a depth of 65 inches. Under natural (pre-development) conditions, the Seasonal High Groundwater Level (SHGWL) is reported to be within 10 inches of the ground surface.</p> <p>Additionally, our experience near the vicinity of the proposed site indicates that subsurface conditions will likely consist of sands with varying amounts of silt and clay from the surface to a depth of about 15 feet followed by weathered limestone.</p> |

PROJECT DESCRIPTION

Our initial understanding of the project was provided in our proposal and was discussed during project planning. A period of collaboration has transpired since the project was initiated, and our final understanding of the project conditions is as follows:

| Item | Description |
|-----------------------------|--|
| Information Provided | The following information was provided by you via e-mail on January 16, 2019. |
| Project Description | The project includes two new mast arm signal poles. |
| Proposed Structures | The project includes two new mast arm signal poles supported on drilled shaft foundations (to be designed by others). |
| Maximum Loads | Structural loads for the new mast arm foundations were not provided. |
| Grading/Slopes | We expect existing site grades to be maintained. |
| Pavements | We understand approximately 190 linear feet (lf) on 26 th Street West and approximately 560 lf on 30 th Avenue West are to be milled and resurfaced. |

GEOTECHNICAL CHARACTERIZATION

We have developed a general characterization of the subsurface conditions based upon our review of the subsurface exploration, laboratory data, geologic setting and our understanding of the project. This characterization forms the basis of our geotechnical calculations and evaluation of site preparation and foundation options. Conditions encountered at each exploration point are indicated on the Report of Core Borings in the **Exploration Results** section.

As part of our analyses, we identified the following model layers within the subsurface profile. For a more detailed view of the model layer depths at each boring location, refer to the Report of Core Borings.

| Model Layer | Layer Name | General Description |
|-------------|------------|---|
| 1 | Sand | Poorly graded sand with silt and trace to some shell fragments (A-3, A-2-4, SP-SM), loose to medium dense |
| 2 | Clay | Gray clay with trace limestone gravel (A-7-5, CH) |
| 3 | Limestone | Limestone, hard ¹ |

1. Hard limestone corresponds to N-values > 50 blows per foot (ref. Florida Department of Transportation Soils and Foundations Handbook, 2020).

Difficult excavation/drilling should be anticipated throughout the limestone layer.

Groundwater

Groundwater was found at a depth of about 5 feet bgs while sampling (i.e. not stabilized). Groundwater level fluctuations occur due to seasonal variations in the amount of rainfall, runoff and other factors not evident at the time the borings were performed. Therefore, groundwater levels during construction or at other times in the life of the structure may be higher or lower than the levels indicated on the boring logs. The possibility of groundwater level fluctuations should be considered when developing the design and construction plans for the project.

Based on the results of the pavement cores (which are further described in the following section), the groundwater level measurements recorded during our field exploration indicate the groundwater level is presently about 4 feet below the bottom of the pavement base.

If more accurate groundwater data is desired, we recommend the installation of piezometers that could be monitored over a period of time.

Pavement Cores

The results of the pavement cores are summarized in the following table.

| Location | Asphalt Thickness (inches) | | Base ¹ Thickness (inches) | Base | Top 12" of Subgrade |
|----------|----------------------------|------------------------------|--|--------------------------------|--------------------------------|
| | Total | Layers | | Avg. Estimated LBR Value | Avg. Estimated LBR Value |
| PC-1 | 3 1/8 | 7/8 over 2 1/4 | 8 3/4 | 63 | 17 |
| PC-2 | 3 1/8 | 1 1/4 over 1 7/8 | 10 1/4 | 113 | 17 |
| PC-3 | 3 3/4 | 1 1/8 over 7/8 over 1 3/4 | 10 | 53 | 25 |
| PC-4 | 3 1/8 | 1 5/8 over 1 1/2 | 12 | 100 | 57 |
| PC-5 | 3 3/8 | 1 7/8 over 1 1/2 | 10 1/2 | 88 | 75 |

1. Base material consisted of limerock.

The DCP testing indicates that the base and subgrade soils are generally firm but generally do not meet, on an average basis, the typical minimum LBR values of 100 for base and 60 for subgrade as required by Manatee County.

GEOTECHNICAL OVERVIEW

The table on the [Report of Core Boring for Signal Pole](#) presents design parameters for the different soil strata encountered at the boring location. The soil parameters (unit weight, friction angles, and soil moduli) were based on empirical correlations (ref. Florida Department of Transportation Soils and Foundations Handbook, 2020) with average SPT blow counts (N-Values) for the different soil strata. The cohesion values for the clay soils were based on an empirical correlation (ref. Essentials of Soil Mechanics and Foundations, 7th Edition by David F. McCarthy) with SPT blow counts (N-values). Lateral earth pressure coefficients were based on the estimated friction angles. It is our understanding that the pole foundations will be drilled shafts designed by others.

The pole foundations should be designed based on frictional resistance (side shear) only using the soil parameters provided on the exhibit.

The [General Comments](#) section provides an understanding of the report limitations.

GENERAL COMMENTS

Our analysis and opinions are based upon our understanding of the project, the geotechnical conditions in the area, and the data obtained from our site exploration. Natural variations will occur between exploration point locations or due to the modifying effects of construction or weather.

Geotechnical Engineering Report

26th Street West and 30th Avenue West ■ Manatee County, Florida

March 6, 2020 ■ Terracon Project No. HC165091



The nature and extent of such variations may not become evident until during or after construction. Terracon should be retained as the Geotechnical Engineer, where noted in this report, to provide observation and testing services during pertinent construction phases. If variations appear, we can provide further evaluation and supplemental recommendations. If variations are noted in the absence of our observation and testing services on-site, we should be immediately notified so that we can provide evaluation and supplemental recommendations.

Our Scope of Services does not include either specifically or by implication any environmental or biological (e.g., mold, fungi, bacteria) assessment of the site or identification or prevention of pollutants, hazardous materials or conditions. If the owner is concerned about the potential for such contamination or pollution, other studies should be undertaken.

Our services and any correspondence or collaboration through this system are intended for the sole benefit and exclusive use of our client for specific application to the project discussed and are accomplished in accordance with generally accepted geotechnical engineering practices with no third-party beneficiaries intended. Any third-party access to services or correspondence is solely for information purposes to support the services provided by Terracon to our client. Reliance upon the services and any work product is limited to our client, and is not intended for third parties. Any use or reliance of the provided information by third parties is done solely at their own risk. No warranties, either express or implied, are intended or made.

Site characteristics as provided are for design purposes and not to estimate excavation cost. Any use of our report in that regard is done at the sole risk of the excavating cost estimator as there may be variations on the site that are not apparent in the data that could significantly impact excavation cost. Any parties charged with estimating excavation costs should seek their own site characterization for specific purposes to obtain the specific level of detail necessary for costing. Site safety, and cost estimating including, excavation support, and dewatering requirements/design are the responsibility of others. If changes in the nature, design, or location of the project are planned, our conclusions and recommendations shall not be considered valid unless we review the changes and either verify or modify our conclusions in writing.

ATTACHMENTS

EXPLORATION AND TESTING PROCEDURES

Field Exploration

| Number of Borings | Boring Depth (feet) | Location |
|-------------------|---------------------|-------------------------------|
| 2 | 30 | Planned signal pole locations |
| 5 | 2 ½ | Pavement core locations |

Boring Layout and Elevations: Unless otherwise noted, Terracon personnel provided the boring layout. Coordinates were obtained with a handheld GPS unit (estimated horizontal accuracy of about ±10 feet). If elevations and a more precise boring layout are desired, we recommend borings be surveyed following completion of fieldwork.

Subsurface Exploration Procedures: We advanced the borings with a track-mounted rotary drill rig using mud rotary procedures. Five samples were obtained in the upper 10 feet of each boring and at intervals of 5 feet thereafter. In the split-barrel sampling procedure, a standard 2-inch outer diameter split-barrel sampling spoon was driven into the ground by a 140-pound rope and cathead operated safety hammer falling a distance of 30 inches. The number of blows required to advance the sampling spoon the last 12 inches of a normal 18-inch penetration or the middle 12 inches of a 24-inch penetration is recorded as the Standard Penetration Test (SPT) resistance value. The SPT resistance values, also referred to as N-values, are indicated on the boring logs at the test depths. A split-barrel sampling spoon was used for sampling. We observed and recorded groundwater levels during drilling. All borings were backfilled with cement grout at their completion.

The shallower borings located within the existing roadway consisted of pavement cores with Dynamic Cone Penetration (DCP) testing on the base and subgrade soils. The borings were drilled using hand-turned bucket type augering equipment to a depth of about 2 ½ feet below the pavement surface.

The sampling depths, penetration distances, and other sampling information was recorded on the field boring logs. The samples were placed in appropriate containers and taken to our soil laboratory for testing and classification by a Geotechnical Engineer. Our exploration team prepared field boring logs as part of the drilling operations. These field logs included visual classifications of the materials encountered during drilling and our interpretation of the subsurface conditions between samples. Final boring logs were prepared from the field logs. The final boring logs represent the Geotechnical Engineer's interpretation of the field logs and include modifications based on observations and tests of the samples in our laboratory.

Geotechnical Engineering Report

26th Street West and 30th Avenue West ■ Manatee County, Florida

March 6, 2020 ■ Terracon Project No. HC165091



Laboratory Testing

The project engineer reviewed the field data and assigned laboratory tests to understand the engineering properties of the various soil strata, as necessary, for this project. Procedural standards noted below are for reference to methodology in general. In some cases, variations to methods were applied because of local practice or professional judgment. Standards noted below include reference to other, related standards. Such references are not necessarily applicable to describe the specific test performed.

- ASTM D2216 Standard Test Methods for Laboratory Determination of Water (Moisture) Content of Soil and Rock by Mass
- ASTM D1140 Standard Test Method for Amount of Material in Soils Finer than No. 200 (75- μ m) Sieve)
- ASTM D4318 Standard Test Methods for Liquid Limit, Plastic Limit, and Plasticity Index of Soils

Our laboratory testing program also includes examination of soil samples by an engineer. Based on observation and test data, the engineer classified the soil samples in accordance with the Unified Soil Classification System (ASTM D2487).

SITE LOCATION AND EXPLORATION PLANS

Contents:

Site Location Plan

Exploration Plan

SITE LOCATION

26th Street West and 30th Avenue West ■ Manatee County, Florida
March 6, 2020 ■ Terracon Project No. HC165091

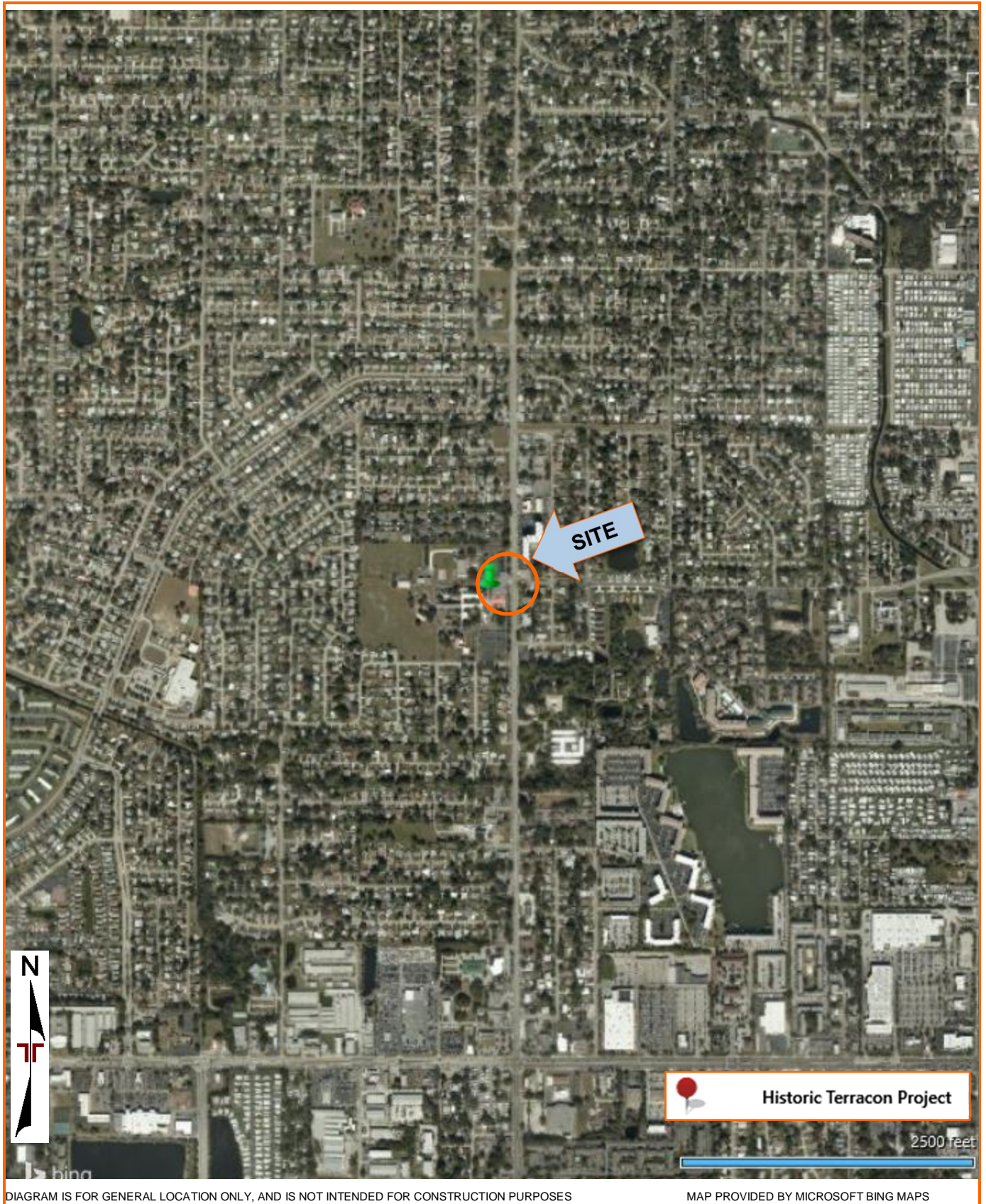

DIAGRAM IS FOR GENERAL LOCATION ONLY, AND IS NOT INTENDED FOR CONSTRUCTION PURPOSES

MAP PROVIDED BY MICROSOFT BING MAPS

EXPLORATION PLAN

26th Street West and 30th Avenue West ■ Manatee County, Florida
March 6, 2020 ■ Terracon Project No. HC165091



DIAGRAM IS FOR GENERAL LOCATION ONLY, AND IS NOT INTENDED FOR CONSTRUCTION PURPOSES

MAP PROVIDED BY MICROSOFT BING MAPS

EXPLORATION RESULTS

Contents:

Report of Core Borings
Coring Logs (PC-1 through PC-5)

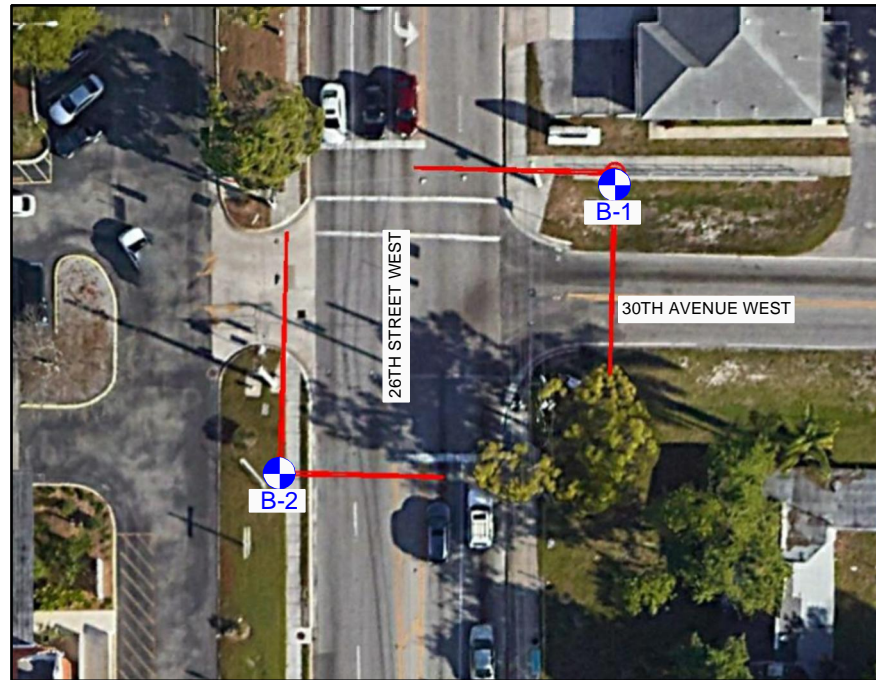

SOURCE: GOOGLE EARTH PRO



LEGEND



APPROXIMATE LOCATION OF STANDARD PENETRATION TEST BORING

BORING NO.
ELEVATION:

B-1
+22.2

B-2
+22.1

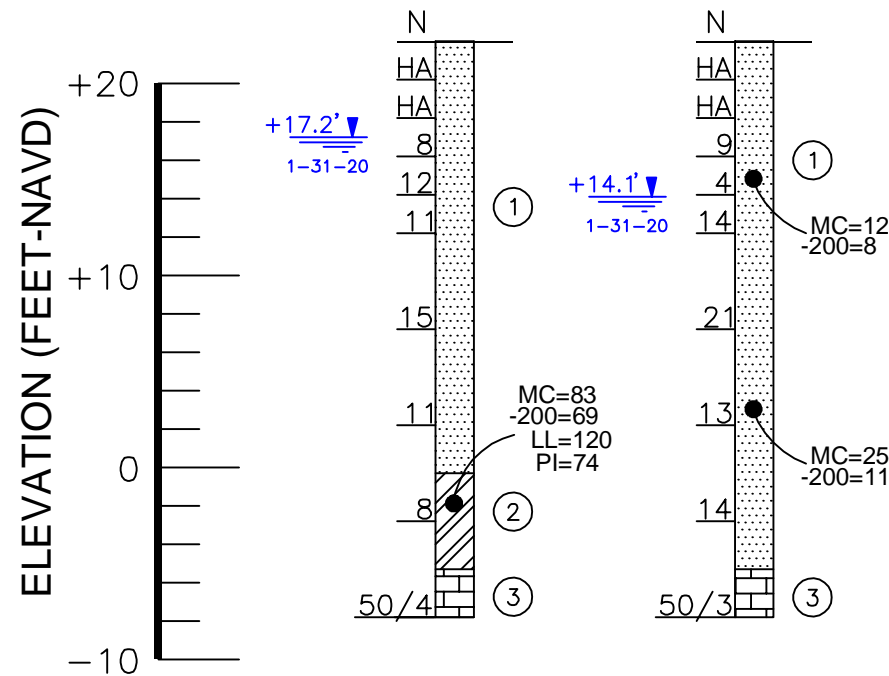

STANDARD PENETRATION TEST DATA

| | |
|--------------------|-------------|
| SPOON INSIDE DIA. | 1.375 inch |
| SPOON OUTSIDE DIA. | 2.00 inches |
| AVG. HAMMER DROP | 30 inches |
| HAMMER WEIGHT | 140 pounds |

GENERAL LEGEND

- ① Brown to gray fine SAND with silt and trace to some shell fragments (A-3, A-2-4, SP-SM)
- ② Gray CLAY with trace limestone gravel (A-7-5, CH)
- ③ Light brown LIMESTONE
- HA – Hand auger 4 feet in order to avoid possible conflict with underground utilities
- N – Standard penetration resistance in blows per foot unless otherwise noted
- SP – Unified Soil Classification System Group Symbol (ASTM D 2487)
- A-3 – AASHTO Soil Classification Group Symbol (AASHTO M145)
- +17.2' 1-31-20 – Elevation of groundwater (feet-NGVD) & date measured
- MC – Moisture Content (%)
- 200 – Amount Finer Than The U.S. Standard No. 200 Sieve (%)
- LL – Liquid Limit (%)
- PI – Plasticity Index (%)
- 50/4 – Indicates fifty SPT hammer blows were required to drive the sampler 4 inches

ENGINEERING CLASSIFICATION (SAFETY HAMMER)

GRANULAR MATERIALS

| Relative Density | SPT BLOW-COUNTS |
|------------------|-----------------|
| Very Loose | Less than 4 |
| Loose | 4 - 10 |
| Medium Dense | 10 - 30 |
| Dense | 30 - 50 |
| Very Dense | Greater than 50 |

SILTS AND CLAYS

| Consistency | SPT BLOW-COUNTS |
|-------------|-----------------|
| Very Soft | Less than 2 |
| Soft | 2 - 4 |
| Firm | 4 - 8 |
| Stiff | 8 - 15 |
| Very Stiff | 15 - 30 |
| Hard | Greater than 30 |

SUMMARY OF FOUNDATION DESIGN PARAMETERS FOR B-1

| Depth (feet) | Soil Type | Unit Weight (pcf) | | Angle of Internal Friction (degrees) | Effective Cohesion (psf) | Ultimate Shear Strength (psf) | Earth Pressure Coefficients | | Soil Modulus, k (pci) |
|--------------|-----------|-------------------|-----------|--------------------------------------|--------------------------|-------------------------------|-----------------------------|------|-----------------------|
| | | Moist | Submerged | | | | Ka | Kp | |
| 0 to 23 | SAND | 110 | 48 | 30 | 0 | 0 | 0.333 | 3.00 | 25 |
| 23 to 28 | CLAY | 115 | 53 | 0 | 1,000 | 0 | 1.00 | 1.00 | -- |
| 28 to 30 | LIMESTONE | 135 | 73 | 0 | 0 | 15,000 | 1.00 | 1.00 | -- |

SUMMARY OF FOUNDATION DESIGN PARAMETERS FOR B-2

| Depth (feet) | Soil Type | Unit Weight (pcf) | | Angle of Internal Friction (degrees) | Effective Cohesion (psf) | Ultimate Shear Strength (psf) | Earth Pressure Coefficients | | Soil Modulus, k (pci) |
|--------------|-----------|-------------------|-----------|--------------------------------------|--------------------------|-------------------------------|-----------------------------|------|-----------------------|
| | | Moist | Submerged | | | | Ka | Kp | |
| 0 to 28 | SAND | 110 | 48 | 30 | 0 | 0 | 0.333 | 3.00 | 25 |
| 28 to 30 | LIMESTONE | 135 | 73 | 0 | 0 | 1,000 | 1.00 | 1.00 | -- |

NOTES

- (1) Borings were drilled on January 31, 2020 using a BR 2400 drilling rig equipped with a safety hammer.
- (2) Strata boundaries are approximate and represent soil strata at each test hole location only. Soil transitions may be more gradual than implied.
- (3) Groundwater elevations shown on the subsurface profiles represent the groundwater levels on the dates shown. Groundwater level fluctuations should be anticipated throughout the year.
- (4) Elevations were provided by HDR.

JAMES M. JACKSON, P.E.
FL LICENSE NO. 77733

| | | | |
|---------------|-----|--------------|-----------|
| Project Mngr: | JMJ | Project No.: | HC165091 |
| Drawn By: | JMJ | Scale: | AS-SHOWN |
| Checked By: | JMJ | File No.: | 1 |
| Approved By: | DSD | Date: | 2-10-2020 |

Terracon
Consulting Engineers and Scientists

8260 VICO COURT, UNIT B SARASOTA, FL 34240
PH. (941) 379-0621 FAX. (941) 379-5061

REPORT OF CORE BORINGS
GEOTECHNICAL ENGINEERING REPORT
26TH STREET WEST & 30TH AVENUE WEST
MANATEE COUNTY, FLORIDA

EXHIBIT

CORING LOG NO. PC-1

PROJECT: 26th St and 30th Ave - Mast Arms

CLIENT: HDR Engineering, Inc.
Sarasota, FL

SITE: 26th Street West
Bradenton, FL

THIS BORING LOG IS NOT VALID IF SEPARATED FROM ORIGINAL REPORT. GEO SMART LOG-NO WELL. HC165091 26TH ST AND 30TH.GPJ TERRACON DATATEMPLATE.GDT 3/4/20

| GRAPHIC LOG | LOCATION See Exploration Plan Latitude: 27.4738° Longitude: -82.5878° | DEPTH (Ft.) | WATER LEVEL OBSERVATIONS | SAMPLE TYPE | FIELD TEST RESULTS | DCP Index (mm/blow) | Estimated LBR Value |
|---|--|-------------|--------------------------|-------------|--------------------|---------------------|---------------------|
| DEPTH | | | | | | | |
| 0.3 | ASPHALT , 3 1/8" Asphalt | | | ↓ | | | |
| 1.0 | LIMEROCK BASE , tan | | | ↓ | 32/6" | 5 | 63 |
| 2.3 | POORLY GRADED SAND WITH SILT AND GRAVEL (SP-SM, A-3) , brown | | | ↓ | 29/6" | 5 | 63 |
| | | | | ↓ | 13/6" | 12 | 23 |
| | | | | ↓ | 6/6" | 25 | 10 |
| <p>Coring Terminated at 2.26 Feet</p>  | | | | | | | |

Stratification lines are approximate. In-situ, the transition may be gradual.

Advancement Method:
Core through asphalt then hand auger and spud bar

See [Exploration and Testing Procedures](#) for a description of field and laboratory procedures used and additional data (If any).

Notes:

Field test results indicate the number of blows from the dual mass DCP required to advance the tip the noted distance in inches.

Abandonment Method:
Boring backfilled with Auger Cuttings
Surface capped with asphalt

See [Supporting Information](#) for explanation of symbols and abbreviations.

WATER LEVEL OBSERVATIONS

Not encountered



Boring Started: 02-24-2020

Boring Completed: 02-24

Drill Rig:

Driller: JD

Project No.: HC165091

CORING LOG NO. PC-2

PROJECT: 26th St and 30th Ave - Mast Arms

CLIENT: HDR Engineering, Inc.
Sarasota, FL

SITE: 26th Street West
Bradenton, FL

THIS BORING LOG IS NOT VALID IF SEPARATED FROM ORIGINAL REPORT. GEO SMART LOG-NO WELL. HC165091 26TH ST AND 30TH.GPJ TERRACON DATATEMPLATE.GDT 3/4/20

| GRAPHIC LOG | LOCATION See Exploration Plan Latitude: 27.4734° Longitude: -82.5876° | DEPTH (Ft.) | WATER LEVEL OBSERVATIONS | SAMPLE TYPE | FIELD TEST RESULTS | DCP Index (mm/blow) | Estimated LBR Value |
|--|--|-------------|--------------------------|-------------|--------------------|---------------------|---------------------|
| DEPTH | | | | | | | |
| 0.3 | ASPHALT , 3 1/8" Asphalt | | | ↓ | | | |
| 1.1 | LIMEROCK BASE , tan | | | ↓ | 50/4" | 2 | 125 |
| 2.3 | POORLY GRADED SAND WITH SILT AND GRAVEL (SP-SM, A-3) , brown | | | ↓ | 50/5.5" | 3 | 100 |
| 2.3 | | | | ↓ | 14/6" | 11 | 25 |
| 2.3 | | | | ↓ | 5/6" | 30 | 8 |
| Coring Terminated at 2.26 Feet | | | | | | | |
|  | | | | | | | |

Stratification lines are approximate. In-situ, the transition may be gradual.

Advancement Method:
Core through asphalt then hand auger and spud bar

See [Exploration and Testing Procedures](#) for a description of field and laboratory procedures used and additional data (If any).

Notes:

Field test results indicate the number of blows from the dual mass DCP required to advance the tip the noted distance in inches.

Abandonment Method:
Boring backfilled with Auger Cuttings
Surface capped with asphalt

See [Supporting Information](#) for explanation of symbols and abbreviations.

WATER LEVEL OBSERVATIONS

Not encountered



Boring Started: 02-24-2020

Boring Completed: 02-24

Drill Rig:

Driller: JD

Project No.: HC165091

CORING LOG NO. PC-3

PROJECT: 26th St and 30th Ave - Mast Arms

CLIENT: HDR Engineering, Inc.
Sarasota, FL

SITE: 26th Street West
Bradenton, FL

THIS BORING LOG IS NOT VALID IF SEPARATED FROM ORIGINAL REPORT. GEO SMART LOG-NO WELL. HC165091 26TH ST AND 30TH.GPJ TERRACON DATATEMPLATE.GDT 3/4/20

| GRAPHIC LOG | LOCATION See Exploration Plan Latitude: 27.4736° Longitude: -82.5873° | DEPTH (Ft.) | WATER LEVEL OBSERVATIONS | SAMPLE TYPE | FIELD TEST RESULTS | DCP Index (mm/blow) | Estimated LBR Value |
|-------------|--|-------------|--------------------------|-------------|--------------------|---------------------|---------------------|
| DEPTH | | | | | | | |
| 0.3 | ASPHALT , 3 3/4" Asphalt | | | ↓ | | | |
| 1.2 | LIMEROCK BASE , tan | | | ↓ | 42/6" | 4 | 75 |
| 2.3 | POORLY GRADED SAND WITH SILT AND GRAVEL (SP-SM, A-3) , brown | | | ↓ | 17/6" | 9 | 31 |
| 2.3 | | | | ↓ | 16/6" | 10 | 25 |
| 2.3 | | | | ↓ | 15/6" | 10 | 25 |

Coring Terminated at 2.31 Feet

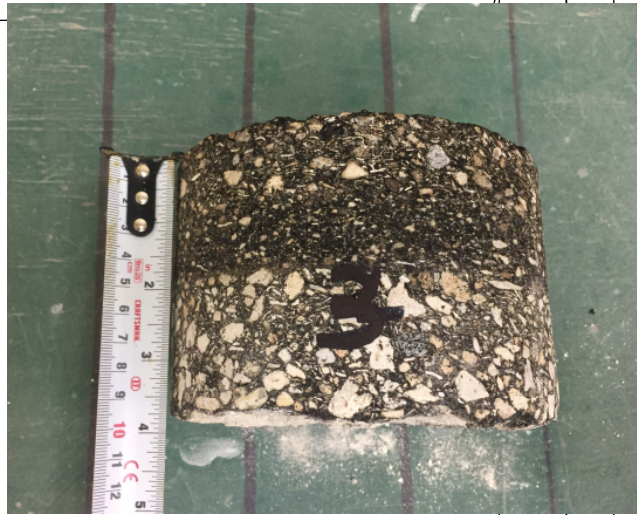

Stratification lines are approximate. In-situ, the transition may be gradual.

Advancement Method:
Core through asphalt then hand auger and spud bar

See [Exploration and Testing Procedures](#) for a description of field and laboratory procedures used and additional data (if any).

Notes:

Field test results indicate the number of blows from the dual mass DCP required to advance the tip the noted distance in inches.

Abandonment Method:
Boring backfilled with Auger Cuttings
Surface capped with asphalt

See [Supporting Information](#) for explanation of symbols and abbreviations.

WATER LEVEL OBSERVATIONS
Not encountered



Boring Started: 02-24-2020

Boring Completed: 02-24

Drill Rig:

Driller: JD

Project No.: HC165091

CORING LOG NO. PC-4

PROJECT: 26th St and 30th Ave - Mast Arms

CLIENT: HDR Engineering, Inc.
Sarasota, FL

SITE: 26th Street West
Bradenton, FL

THIS BORING LOG IS NOT VALID IF SEPARATED FROM ORIGINAL REPORT. GEO SMART LOG-NO WELL. HC165091 26TH ST AND 30TH.GPJ TERRACON DATATEMPLATE.GDT 3/4/20

| GRAPHIC LOG | LOCATION See Exploration Plan Latitude: 27.4736° Longitude: -82.5868° | DEPTH (Ft.) | WATER LEVEL OBSERVATIONS | SAMPLE TYPE | FIELD TEST RESULTS | DCP Index (mm/blow) | Estimated LBR Value |
|-------------|--|-------------|--------------------------|-------------|--------------------|---------------------|---------------------|
| DEPTH | | | | | | | |
| 0.3 | ASPHALT , 3 1/8" Asphalt | | | ↓ | | | |
| | LIMEROCK BASE , tan | | | ↓ | 50/3.5" | 2 | 125 |
| 1.3 | | | | ↓ | 35/6" | 4 | 75 |
| | POORLY GRADED SAND WITH SILT AND GRAVEL (SP-SM, A-3) , brown | | | ↓ | 40/6" | 4 | 75 |
| 2.3 | | | | ↓ | 18/6" | 8 | 38 |
| | Coring Terminated at 2.26 Feet | | | ↓ | | | |

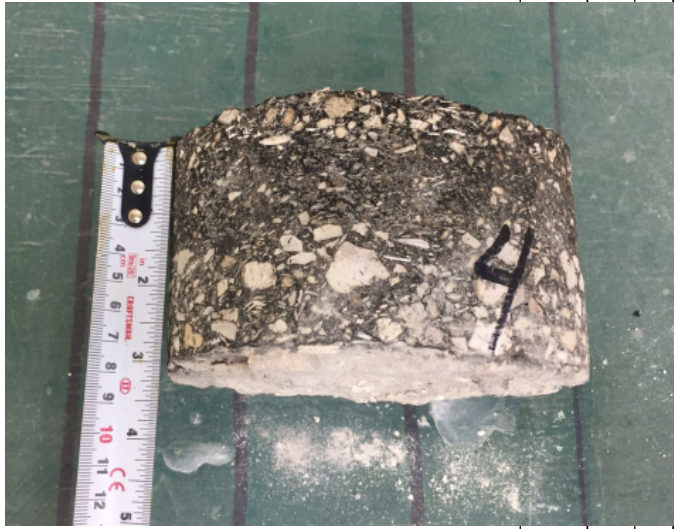

Stratification lines are approximate. In-situ, the transition may be gradual.

| | | | | | | | | |
|---|---|--|----------------------------|-------------------------|------------|-------------|-----------------------|--|
| <p>Advancement Method: Core through asphalt then hand auger and spud bar</p> <p>Abandonment Method: Boring backfilled with Auger Cuttings Surface capped with asphalt</p> | <p>See Exploration and Testing Procedures for a description of field and laboratory procedures used and additional data (If any).</p> <p>See Supporting Information for explanation of symbols and abbreviations.</p> | <p>Notes: Field test results indicate the number of blows from the dual mass DCP required to advance the tip the noted distance in inches.</p> | | | | | | |
| <p>WATER LEVEL OBSERVATIONS <i>Not encountered</i></p> | <p>8260 Vico Ct, Unit B Sarasota, FL</p> | <table style="width: 100%; border-collapse: collapse;"> <tr> <td style="width: 50%; border-bottom: 1px solid black;">Boring Started: 02-24-2020</td> <td style="width: 50%; border-bottom: 1px solid black;">Boring Completed: 02-24</td> </tr> <tr> <td style="border-bottom: 1px solid black;">Drill Rig:</td> <td style="border-bottom: 1px solid black;">Driller: JD</td> </tr> <tr> <td colspan="2" style="border-bottom: 1px solid black;">Project No.: HC165091</td> </tr> </table> | Boring Started: 02-24-2020 | Boring Completed: 02-24 | Drill Rig: | Driller: JD | Project No.: HC165091 | |
| Boring Started: 02-24-2020 | Boring Completed: 02-24 | | | | | | | |
| Drill Rig: | Driller: JD | | | | | | | |
| Project No.: HC165091 | | | | | | | | |

CORING LOG NO. PC-5

PROJECT: 26th St and 30th Ave - Mast Arms

CLIENT: HDR Engineering, Inc.
Sarasota, FL

SITE: 26th Street West
Bradenton, FL

THIS BORING LOG IS NOT VALID IF SEPARATED FROM ORIGINAL REPORT. GEO SMART LOG-NO WELL. HC165091 26TH ST AND 30TH.GPJ TERRACON DATATEMPLATE.GDT 3/4/20

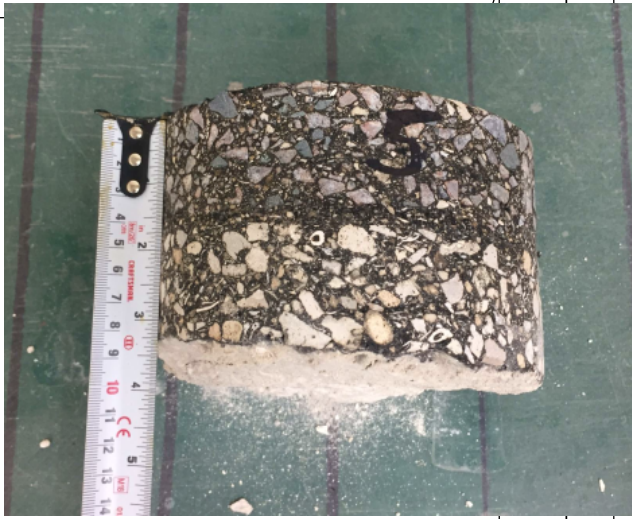
| GRAPHIC LOG | LOCATION See Exploration Plan Latitude: 27.4736° Longitude: -82.5861° | DEPTH (Ft.) | WATER LEVEL OBSERVATIONS | SAMPLE TYPE | FIELD TEST RESULTS | DCP Index (mm/blow) | Estimated LBR Value |
|--|--|-------------|--------------------------|-------------|--------------------|---------------------|---------------------|
| DEPTH | | | | | | | |
| 0.3 | ASPHALT , 3 3/8" Asphalt | | | ↓ | | | |
| 1.2 | LIMEROCK BASE , tan | | | ↓ | 46/6" | 3 | 100 |
| 2.3 | POORLY GRADED SAND WITH SILT AND GRAVEL (SP-SM, A-3) , brown | | | ↓ | 38/6" | 4 | 75 |
| 2.3 | | | | ↓ | 43/6" | 4 | 75 |
| 2.3 | | | | ↓ | 38/6" | 4 | 75 |
| | Coring Terminated at 2.28 Feet | | | | | | |
|  | | | | | | | |

Stratification lines are approximate. In-situ, the transition may be gradual.

Advancement Method:
Core through asphalt then hand auger and spud bar

See [Exploration and Testing Procedures](#) for a description of field and laboratory procedures used and additional data (If any).

Notes:

Field test results indicate the number of blows from the dual mass DCP required to advance the tip the noted distance in inches.

Abandonment Method:
Boring backfilled with Auger Cuttings
Surface capped with asphalt

See [Supporting Information](#) for explanation of symbols and abbreviations.

WATER LEVEL OBSERVATIONS
Not encountered



Boring Started: 02-24-2020

Boring Completed: 02-24

Drill Rig:

Driller: JD

Project No.: HC165091

SUPPORTING INFORMATION

Contents:









General Notes

Unified Soil Classification System

Note: All attachments are one page unless noted above.

GENERAL NOTES

DESCRIPTION OF SYMBOLS AND ABBREVIATIONS

| | | | | | | |
|-----------------|--|---|--------------------|--|--------------------|---|
| SAMPLING |  Auger Cuttings  Grab Sample  Shelby Tube |  Rock Core  No Recovery  Standard Penetration Test | WATER LEVEL |  Water Initially Encountered  Water Level After a Specified Period of Time  Water Level After a Specified Period of Time Water levels indicated on the soil boring logs are the levels measured in the borehole at the times indicated. Groundwater level variations will occur over time. In low permeability soils, accurate determination of groundwater levels is not possible with short term water level observations. | FIELD TESTS | (HP) Hand Penetrometer (T) Torvane (DCP) Dynamic Cone Penetrometer (PID) Photo-Ionization Detector (OVA) Organic Vapor Analyzer |
|-----------------|--|---|--------------------|--|--------------------|---|

DESCRIPTIVE SOIL CLASSIFICATION

Soil classification is based on the Unified Soil Classification System. Coarse Grained Soils have more than 50% of their dry weight retained on a #200 sieve; their principal descriptors are: boulders, cobbles, gravel or sand. Fine Grained Soils have less than 50% of their dry weight retained on a #200 sieve; they are principally described as clays if they are plastic, and silts if they are slightly plastic or non-plastic. Major constituents may be added as modifiers and minor constituents may be added according to the relative proportions based on grain size. In addition to gradation, coarse-grained soils are defined on the basis of their in-place relative density and fine-grained soils on the basis of their consistency.

LOCATION AND ELEVATION NOTES

Unless otherwise noted, Latitude and Longitude are approximately determined using a hand-held GPS device. The accuracy of such devices is variable. Surface elevation data annotated with +/- indicates that no actual topographical survey was conducted to confirm the surface elevation. Instead, the surface elevation was approximately determined from topographic maps of the area.

| STRENGTH TERMS | RELATIVE DENSITY OF COARSE-GRAINED SOILS <small>(More than 50% retained on No. 200 sieve.) Density determined by Standard Penetration Resistance</small> | | CONSISTENCY OF FINE-GRAINED SOILS <small>(50% or more passing the No. 200 sieve.) Consistency determined by laboratory shear strength testing, field visual-manual procedures or standard penetration resistance</small> | | |
|----------------|---|---|---|---|---|
| | Descriptive Term (Density) | Standard Penetration or N-Value Blows/Ft. | Descriptive Term (Consistency) | Unconfined Compressive Strength Qu, (psf) | Standard Penetration or N-Value Blows/Ft. |
| | Very Loose | 0 - 3 | Very Soft | less than 500 | 0 - 1 |
| | Loose | 4 - 9 | Soft | 500 to 1,000 | 2 - 4 |
| | Medium Dense | 10 - 29 | Medium Stiff | 1,000 to 2,000 | 4 - 8 |
| | Dense | 30 - 50 | Stiff | 2,000 to 4,000 | 8 - 15 |
| | Very Dense | > 50 | Very Stiff | 4,000 to 8,000 | 15 - 30 |
| | | Hard | > 8,000 | > 30 | |

RELATIVE PROPORTIONS OF SAND AND GRAVEL

| Descriptive Term(s) of other constituents | Percent of Dry Weight |
|---|-----------------------|
| Trace | < 15 |
| With | 15 - 29 |
| Modifier | > 30 |

GRAIN SIZE TERMINOLOGY

| Major Component of Sample | Particle Size |
|---------------------------|--------------------------------------|
| Boulders | Over 12 in. (300 mm) |
| Cobbles | 12 in. to 3 in. (300mm to 75mm) |
| Gravel | 3 in. to #4 sieve (75mm to 4.75 mm) |
| Sand | #4 to #200 sieve (4.75mm to 0.075mm) |
| Silt or Clay | Passing #200 sieve (0.075mm) |

RELATIVE PROPORTIONS OF FINES

| Descriptive Term(s) of other constituents | Percent of Dry Weight |
|---|-----------------------|
| Trace | < 5 |
| With | 5 - 12 |
| Modifier | > 12 |

PLASTICITY DESCRIPTION

| Term | Plasticity Index |
|-------------|------------------|
| Non-plastic | 0 |
| Low | 1 - 10 |
| Medium | 11 - 30 |
| High | > 30 |

| Criteria for Assigning Group Symbols and Group Names Using Laboratory Tests ^A | | | | Soil Classification | | | |
|--|---|--|--|---------------------|-----------------------------------|------------------------------------|------|
| | | | | Group Symbol | Group Name ^B | | |
| Coarse-Grained Soils: More than 50% retained on No. 200 sieve | Gravels: More than 50% of coarse fraction retained on No. 4 sieve | Clean Gravels: Less than 5% fines ^C | $Cu \geq 4$ and $1 \leq Cc \leq 3$ ^E | GW | Well-graded gravel ^F | | |
| | | | $Cu < 4$ and/or $[Cc < 1 \text{ or } Cc > 3.0]$ ^E | GP | Poorly graded gravel ^F | | |
| | | Gravels with Fines: More than 12% fines ^C | Fines classify as ML or MH | GM | Silty gravel ^{F, G, H} | | |
| | | | Fines classify as CL or CH | GC | Clayey gravel ^{F, G, H} | | |
| | Sands: 50% or more of coarse fraction passes No. 4 sieve | Clean Sands: Less than 5% fines ^D | $Cu \geq 6$ and $1 \leq Cc \leq 3$ ^E | SW | Well-graded sand ^I | | |
| | | | $Cu < 6$ and/or $[Cc < 1 \text{ or } Cc > 3.0]$ ^E | SP | Poorly graded sand ^I | | |
| | | Sands with Fines: More than 12% fines ^D | Fines classify as ML or MH | SM | Silty sand ^{G, H, I} | | |
| | | | Fines classify as CL or CH | SC | Clayey sand ^{G, H, I} | | |
| Fine-Grained Soils: 50% or more passes the No. 200 sieve | Silts and Clays: Liquid limit less than 50 | Inorganic: | $PI > 7$ and plots on or above "A" line | CL | Lean clay ^{K, L, M} | | |
| | | | $PI < 4$ or plots below "A" line ^J | ML | Silt ^{K, L, M} | | |
| | | Organic: | Liquid limit - oven dried | < 0.75 | OL | Organic clay ^{K, L, M, N} | |
| | | | Liquid limit - not dried | | | Organic silt ^{K, L, M, O} | |
| | Silts and Clays: Liquid limit 50 or more | Inorganic: | PI plots on or above "A" line | CH | Fat clay ^{K, L, M} | | |
| | | | PI plots below "A" line | MH | Elastic Silt ^{K, L, M} | | |
| | | Organic: | Liquid limit - oven dried | < 0.75 | OH | Organic clay ^{K, L, M, P} | |
| | | | Liquid limit - not dried | | | Organic silt ^{K, L, M, Q} | |
| | | Highly organic soils: | Primarily organic matter, dark in color, and organic odor | | | PT | Peat |

^A Based on the material passing the 3-inch (75-mm) sieve.

^B If field sample contained cobbles or boulders, or both, add "with cobbles or boulders, or both" to group name.

^C Gravels with 5 to 12% fines require dual symbols: GW-GM well-graded gravel with silt, GW-GC well-graded gravel with clay, GP-GM poorly graded gravel with silt, GP-GC poorly graded gravel with clay.

^D Sands with 5 to 12% fines require dual symbols: SW-SM well-graded sand with silt, SW-SC well-graded sand with clay, SP-SM poorly graded sand with silt, SP-SC poorly graded sand with clay.

$$Cu = D_{60}/D_{10} \quad Cc = \frac{(D_{30})^2}{D_{10} \times D_{60}}$$

^F If soil contains ³ 15% sand, add "with sand" to group name.

^G If fines classify as CL-ML, use dual symbol GC-GM, or SC-SM.

^H If fines are organic, add "with organic fines" to group name.

^I If soil contains ³ 15% gravel, add "with gravel" to group name.

^J If Atterberg limits plot in shaded area, soil is a CL-ML, silty clay.

^K If soil contains 15 to 29% plus No. 200, add "with sand" or "with gravel," whichever is predominant.

^L If soil contains ³ 30% plus No. 200 predominantly sand, add "sandy" to group name.

^M If soil contains ³ 30% plus No. 200, predominantly gravel, add "gravelly" to group name.

^N $PI \geq 4$ and plots on or above "A" line.

^O $PI < 4$ or plots below "A" line.

^P PI plots on or above "A" line.

^Q PI plots below "A" line.

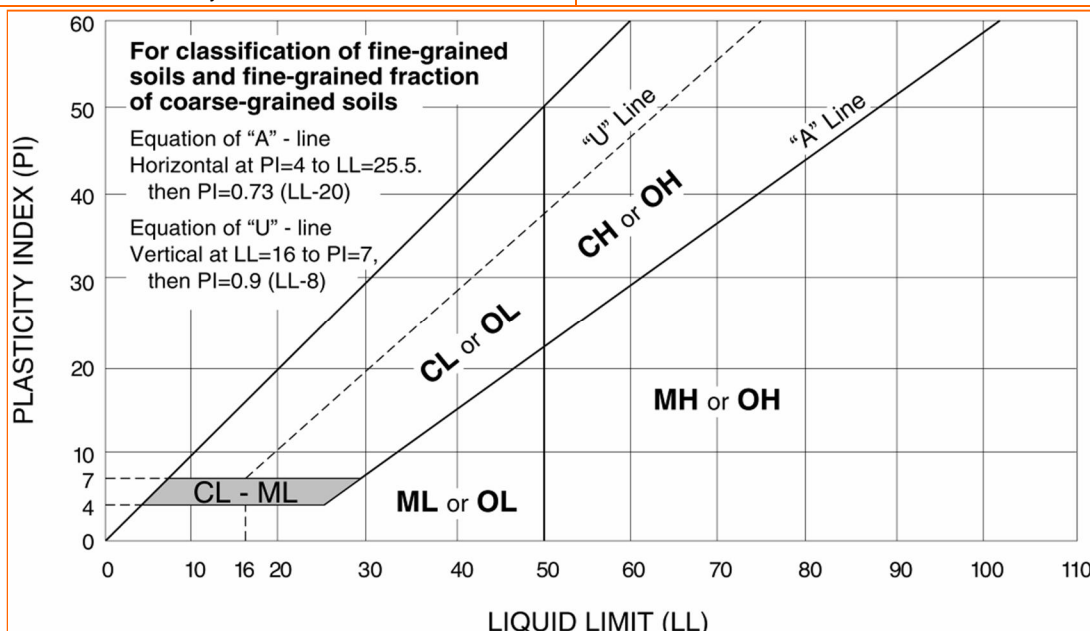

Lighting Design Memorandum

**26th St. W at 30th Ave. W
Signalized Intersection
Manatee County, FL**

Prepared for:

*Manatee County Traffic
2101 47th Terrace E,
Bradenton, Florida 34203*

Prepared by:

*HDR Engineering, Inc.
4830 West Kennedy Boulevard, Suite 400
Tampa, FL 33609
(813) 282-2300*

Lighting Engineer of Record: Michael J. Oates

PE No. 49282

September, 2020

1. Introduction

The purpose of this memorandum is to summarize the results of a lighting analysis performed for the proposed reconstruction of the 26th Street W at 30th Avenue W intersection in Manatee County, Florida. This reconstruction efforts will include widening the existing westbound approach to two lanes to enhance intersection capacity. Currently this intersection is signalized utilizing a span wire configuration and does not include lighting. The proposed design will include replacing the existing span wire with two dual-arm mast arms. Each mast arm will include an LED fixture attached on luminaire bracket arm to illuminate the intersection.

2. Lighting Parameters

Per Manatee County criteria, this intersection will be illuminated to 1.0 average horizontal foot candles. Uniformity ratios of 4:1 (Avg/Min) and 10:1 (Max/Min) will also be met to provide a uniform light level throughout the intersection. Veiling luminance and vertical illuminance criteria are not considered as part of this analysis. The calculation polygon was placed in accordance with criteria from chapter 231.3 of the 2020 FDOT Design Manual for signalized intersections. The photometric calculation points are spaced 5 feet x 5 feet apart, with the calculation zone boundaries defined as the back of stop bars and sidewalks. The lighting calculation was performed using AGI32 lighting Analysis software.

3. Luminaire Selection and Mounting

For this intersection lighting design, the fixture selected was the GE Evolve LED luminaire. The luminaires will be mounted on 8 foot arms attached to the mast arm uprights located on the northeast and southwest quadrants at a height of 40 feet. The luminaire bracket arms are placed to avoid conflicts with the existing overhead electric to meet the required OSHA clearance requirements. The selected luminaire which meets the design criteria is the ERLH_11E340-ELSHS, 98 Watt with a Type II photometric distribution and a house side shield. The results of the lighting analysis performed can be seen in **Appendix A**. The cut sheet for the proposed luminaire can be seen in **Appendix B**.

Appendix A

30" YEW

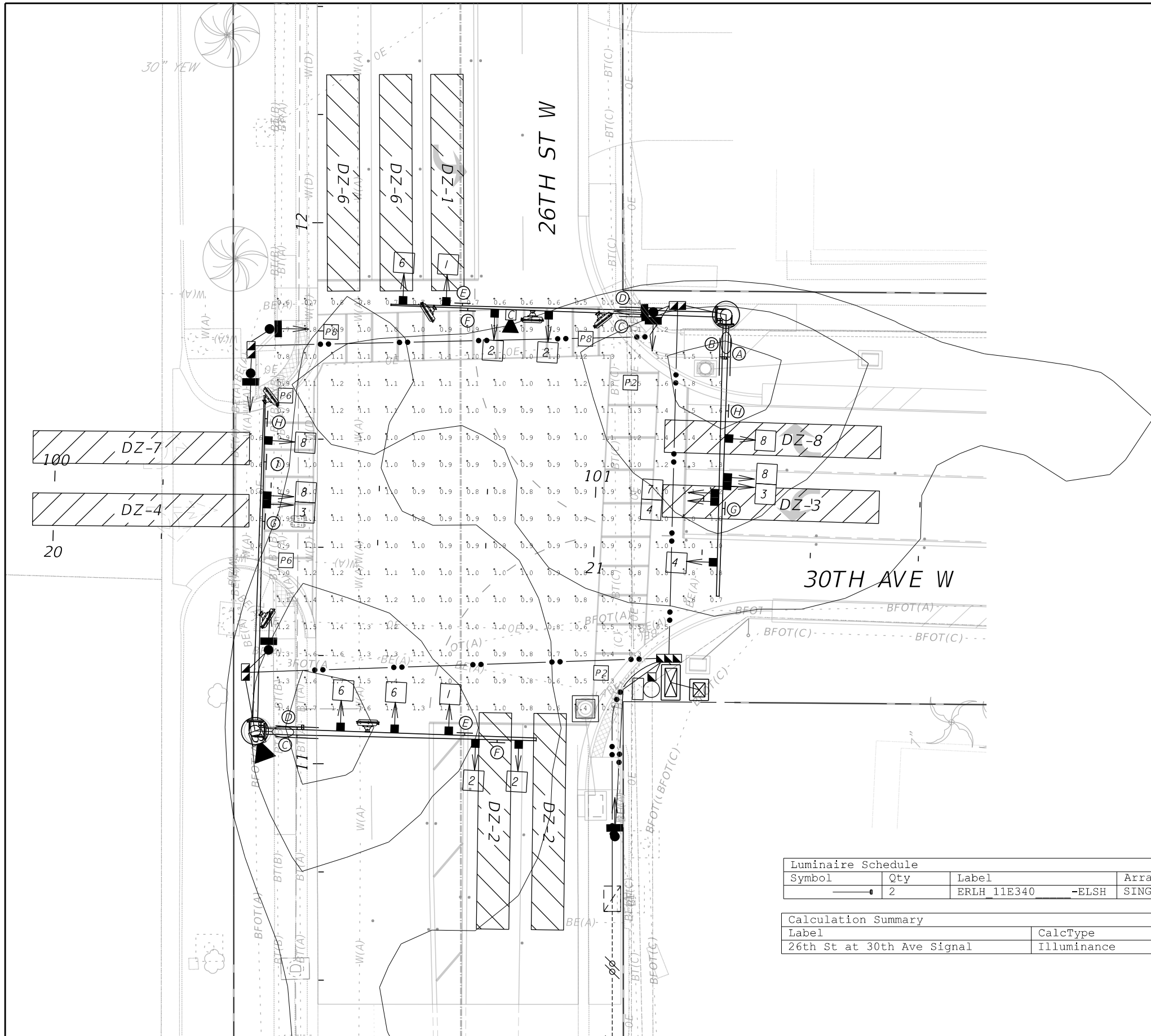
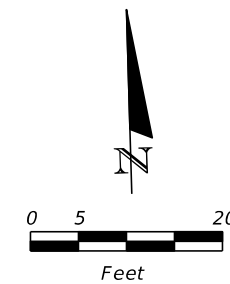

| Luminaire Schedule | | | | | | | |
|--------------------|-----|-------------|--------------|-------------------|-------|------------------|--|
| Symbol | Qty | Label | Arrangement | Total Lamp Lumens | LLF | Description | |
| | 2 | ERLH 11E340 | -ELSH SINGLE | N.A. | 1.000 | ERLH 11E340 with | |

| Calculation Summary | | | | | | | |
|----------------------------|-------------|-------|-----|-----|-----|---------|---------|
| Label | CalcType | Units | Avg | Max | Min | Avg/Min | Max/Min |
| 26th St at 30th Ave Signal | Illuminance | Fc | 1.0 | 1.9 | 0.3 | 3.3 | 6.3 |

| | | | | | | | | | | | | | |
|-----|-----------|--|------|----|-------------|----------|--|-------------|---------|--------------------------------|-----------------|------------------|--------------|
| No. | REVISIONS | | DATE | BY | SCALE | AS NOTED | HDR ENGINEERING, INC. 2601 CATTLEMEN ROAD, SUITE 400 SARASOTA, FLORIDA 34232 | DATE | 09/2020 | MANATEE COUNTY PUBLIC WORKS | DESIGN ENGINEER | MICHAEL J. OATES | SHEET NO. |
| | | | | | DESIGNED BY | MJO | | PROJECT NO. | 6092460 | | FL. LICENSE NO. | 49282 | |
| | | | | | DRAWN BY | SS | | | | | | | |
| | | | | | CHECKED BY | IR | | | | | | | |

THE OFFICIAL RECORD OF THIS SHEET IS THE ELECTRONIC FILE DIGITALLY SIGNED AND SEALED UNDER RULE 61G15-23.004, F.A.C.

Appendix B



Evolve[®]

LED Roadway Lighting

ERL1-ERLH-ERL2



GE current
a Daintree company

Evolve®

LED Roadway Lighting

ERL1-ERLH-ERL2



The **Evolve®** LED Roadway Luminaire is optimized for customers requiring a LED solution for local, collector and major roadways. GE's unique reflective optics are designed to optimize application efficiency and minimize glare. The modern design incorporates the heat sink directly into the unit for heat transfer to prolong LED life. This reliable unit has a 100,000 hour design life, significantly reducing maintenance needs and expense over the life of the fixture. This efficient solution lowers energy consumption compared to a traditional HID fixture for additional operating cost savings.

Features:

- Optimized roadway photometric distributions
- **Evolve®** light engine consisting of reflective technology designed to optimize application efficiency and minimize glare
- 70 CRI at 2700K, 3000K and 4000K typical.
- -40°C to 50°C UL Ambient Typical.
- ULOR = 0 (zero uplight)
- Designed & Assembled in USA

Applications:

- Local Roadways
- Collector Roadways
- Major Roadway/Streets



Compatible with **LightGrid** Outdoor Wireless Control System

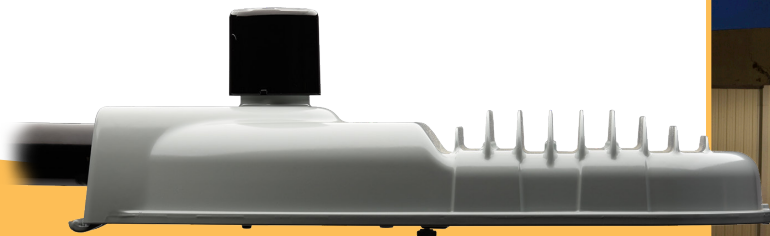

To learn more about **Evolve®** LED Roadway Lighting, go to: www.gecurrent.com

Evolve®

LED Roadway Lighting

ERL1-ERLH-ERL2



Project name _____

Date _____

Type _____

Typical Specifications: ERL1-ERLH-ERL2

LED & Optical

- **Output Range:** 1900 – 30000 lm
- **Photometric Options:** Type II Narrow, Type II Wide, Type III, Type IV
- **System Efficacy:** 100 - 145 LPW
- **CCT:** 2700K, 3000K, 4000K LEDs @ 70 CRI

Lumen Maintenance Tables

Projected Lxx per IES TM-21 at 25°C for reference:

| ERL1 LUMEN OUTPUT CODES | LXX(10K)@HOURS | | |
|----------------------------|----------------|-----------|-----------|
| | 25,000 HR | 50,000 HR | 60,000 HR |
| 02,03,04,05,06 | L96 | L95 | L94 |
| 07,08,09 | L95 | L91 | L89 |
| 10 | L89 | L80 | L76 |

| ERLH LUMEN OUTPUT CODES | LXX(10K)@HOURS | | |
|----------------------------|----------------|-----------|-----------|
| | 25,000 HR | 50,000 HR | 60,000 HR |
| 10, 11 | L97 | L96 | L96 |
| 13, 14 | L95 | L93 | L92 |
| 15, 16 | L94 | L91 | L91 |

| ERL2 LUMEN OUTPUT CODES | LXX(10K)@HOURS | | |
|----------------------------|----------------|-----------|-----------|
| | 25,000 HR | 50,000 HR | 60,000 HR |
| 16, 18, 19, 21, 23 | L96 | L94 | L95 |
| 25, 27, 28 | L95 | L93 | L92 |
| 30 | L94 | L91 | L90 |

Note: Projected Lxx based on LM80 (10,000 hour testing). Accepted industry tolerances apply to initial luminous flux and lumen maintenance measurements.

Electrical

- **Input Voltage:** 120-277 volt and 347-480 volt
- **Input Frequency:** 50/60Hz
- **Power Factor (PF)*:** >90%
- **Total Harmonic Distortion (THD)*:** <20%

*Power factor and THD tolerance exceptions: ERL1 "02" Lumen output: PF and THD within tolerances above only at 120 volt. ERL1 "03" Lumen output: @120 volt PF~0.89; @ 480 volt THD~26% ERL1 "04" Lumen output: @480 volt THD~22%

Ratings

- **Surge Protection:** per ANSI C136.2-2015: (Driver Internal):
 - 6kV/3kA "Basic: (120 Strikes)" - Standard on ERL1 (02-06)
 - 10kV/5kA "Enhanced: (40 Strikes)" - Standard on ERL1 (07 - 10), ERLH, ERL2
- **(Additional Separate Secondary SPD)**
 - 10kV/5kA "Enhanced: (40 Strikes)" - Option "R"
 - 20kV/10kA "Elevated" (40 Strikes) - Option "T"
- **Safety:** UL/cUL Listed. UL 1598 listed, suitable for wet locations (UL) (UL)
- **Environmental:** Compliant with the materials restrictions of RoHS
- **EMI:** Title 47 CFR Part 15 Class A
- **Vibration:** 3G per ANSI C136.31-2010
- LM-79 testing in accordance with IESNA Standards
- Std. Optical enclosure rated per ANSI C136.25-2009:
 - ERL1/ERLH/ERL2 = IP65, Optional: IP66



Please refer to the DLC QPL website for the latest and most complete information. www.designlights.org/QPL



International Dark Sky Association listed. 2700K or 3000K must be selected to meet IDA certification and approval.

Operating Temperature:

| PRODUCT ID | LUMEN OUTPUT | AMBIENT READING |
|------------|--------------|-----------------|
| ERL1 | 02-10 | -40°C to 50°C |
| ERLH | 10-11, 13 | -40°C to 50°C |
| ERLH | 14-16 | -40°C to 45°C |
| ERL2 | 16-28 | -40°C to 50°C |
| ERL2 | 30 | -40°C to 45°C |

Delayed start may be experienced < -35°C

Construction & Finish

- **Housing:**
 - Die Cast Enclosure
 - Casting-integral heat sink for maximum heat transfer
- **Lensing:** Impact resistant tempered glass, standard
- **Paint:** Corrosion resistant polyester powder painted, minimum 2.0 mil. thickness.
 - Standard Colors: Dark Bronze, Black, & Gray
 - RAL & custom colors available
 - Optional coastal finish available.
- **Weight:** 12.4lbs (5.6kg) – 24lbs (10.9kg)

Warranty

- **System Warranty:** 5 Year Standard, 10 Year Optional

Controls

- **Dimming:**
 - Standard: 0-10V; Optional: DALI (120-277V Only)
- **Sensors:**
 - Photo electric sensors (PE) available.
- LightGrid™ compatible

Mounting

- Slipfitter with +/- 5 degree of adjustment for leveling.
- Integral die cast mounting pipe stop.
- Adjustable for 1.25 in. or 2 in. mounting pipe.

Suggested HID Replacement Lumen Levels

- ~4,000–5,000 lumens to replace 100W HPS Cobra-head
- ~7,000–8,800 lumens to replace 150W HPS Cobra-head
- ~8,500–11,500 lumens to replace 200W HPS Cobra-head
- ~11,500–14,000 lumens to replace 250W HPS Cobra-head
- ~21,000–30,000 lumens to replace 400W HPS Cobra-head

Note: Actual replacement lumens may vary based upon mounting height, pole spacing, design criteria, etc.

| PREVIOUS | DESCRIPTION | CURRENT | DESCRIPTION |
|----------|--------------------------------|---------|-----------------------------|
| A1, B1 | Extra Narrow/Narrow Asymmetric | A3 | Type II Narrow |
| C1, E1 | Asymmetric Short/Medium | B3 | Type II Wide |
| D1, G1 | Asymmetric Forward/Extra Wide | C3 | Type III |
| F1 | Asymmetric Wide | D3 | Type IV |
| | | E3 | Type II Enhanced Back Light |

**The information above is designed to provide a guideline to select the correct luminaire for a roadway application. The best and most accurate way to ensure the proper design is do a lighting layout Utilizing AGI.

Evolve®

LED Roadway Lighting

ERL1-ERLH-ERL2



Project name _____
 Date _____
 Type _____

E R L H

| PROD. ID | VOLTAGE | LUMEN OUTPUT | DISTRIBUTION* | CCT | CONTROLS | COLOR | OPTIONS |
|------------------------|----------------------|--------------|---|--|--|---------------------------|--|
| E = Evolve | 0 = 120, 277V* | 10 | A3 = Type II Narrow | 27 = 2700K<> | A = ANSI C136.41 7-pin | GRAY = Gray | A = 4 Bolt Slipfitter † |
| R = Roadway | 1 = 120 | 11 | B3 = Type II Wide | 30 = 3000K<> | D = ANSI C136.41 7-pin with Shorting Cap | BLCK = Black | F = Fusing |
| L = Local | 2 = 208 | 13 | C3 = Type III | 40 = 4000K | E = ANSI C136.41 7-pin with non-Dimming PE Control.* | DKBZ = Dark Bronze | G = Internal Bubble Level |
| H = High Output | 3 = 240 | 14 | D3 = Type IV | <> Select 2700K or 3000K CCT for IDA approved units. | *PE Control Only available for 120-277V or 480V Discrete. Not available for 347-480V or 347V Discrete. | | I = IP66 Optical |
| | 4 = 277 | 15 | E3 = Type II Enhanced Back Light | See Table | NOTE: Dimming controls wired for 0-10V standard unless DALI option "U" requested. | | L = Tool-Less Entry |
| | 5 = 480 | 16 | | | | | R = Secondary 10kV/5kA SPD |
| | D = 347 | | | | | | T = Secondary 20kV/10kA SPD |
| | H = 347-480*# | See Table | *Nominal IES Type classing subject to typical variation, individual units may differ. | | | | U = DALI Programmable +^ |
| | | | | | | | V1 = Variable Output via Field Adjustable Module** |
| | | | | | | | X = Single Package # |
| | | | | | | | Y = Coastal Finish* |
| | | | | | | | XXX = Special Options |
| | | | | | | | † Contact manufacturer for Lead-Time. |
| | | | | | | | # "X" option provides single pack box per fixture. Std Packaging = 20 units per Magna pak container. |
| | | | | | | | * Recommended for installations within 750 ft. from the coast. Contact Factory for Lead-Time. |
| | | | | | | | + Compatible with LightGrid 2.0 nodes. |
| | | | | | | | ^ Not available in 347V, 480V or 347-480V. |
| | | | | | | | ** Not available with DALI (U) option. |

| LUMEN OUTPUT | DISTRIBUTION | TYPICAL INITIAL LUMENS | | | TYPICAL SYSTEM WATTAGE | | | BUG RATING | | | IES FILE NUMBER | | |
|--------------|--------------|------------------------|-------|-------|------------------------|----------|----------|------------|-------------|-------------|-----------------|-------|--|
| | | 4000K | 3000K | 2700K | 120-277V | 347-480V | 4000K | 3000K | 2700K | 4000K | 3000K | 2700K | |
| 10 | A3 | | | | 82 | B2-U0-G2 | B2-U0-G2 | B2-U0-G2 | ERLH_10A340 | ERLH_10A330 | ERLH_10A327 | | |
| | B3 | | | | | B2-U0-G2 | B2-U0-G2 | B2-U0-G2 | ERLH_10B340 | ERLH_10B330 | ERLH_10B327 | | |
| | C3 | 10000 | 9600 | 9300 | | B2-U0-G3 | B2-U0-G2 | B2-U0-G2 | ERLH_10C340 | ERLH_10C330 | ERLH_10C327 | | |
| | D3 | | | | | B1-U0-G3 | B1-U0-G2 | B1-U0-G2 | ERLH_10D340 | ERLH_10D330 | ERLH_10D327 | | |
| | E3 | | | | | B3-U0-G3 | B3-U0-G3 | B3-U0-G3 | ERLH_10E340 | ERLH_10E330 | ERLH_10E327 | | |
| 11 | A3 | | | | 98 | B3-U0-G3 | B2-U0-G2 | B2-U0-G2 | ERLH_11A340 | ERLH_11A330 | ERLH_11A327 | | |
| | B3 | | | | | B3-U0-G3 | B2-U0-G2 | B2-U0-G2 | ERLH_11B340 | ERLH_11B330 | ERLH_11B327 | | |
| | C3 | 11500 | 11000 | 10700 | | B2-U0-G3 | B2-U0-G3 | B2-U0-G3 | ERLH_11C340 | ERLH_11C330 | ERLH_11C327 | | |
| | D3 | | | | | B1-U0-G3 | B1-U0-G2 | B1-U0-G2 | ERLH_11D340 | ERLH_11D330 | ERLH_11D327 | | |
| | E3 | | | | | B3-U0-G3 | B3-U0-G3 | B3-U0-G3 | ERLH_11E340 | ERLH_11E330 | ERLH_11E327 | | |
| 13 | A3 | | | | 111 | B3-U0-G3 | B3-U0-G3 | B3-U0-G3 | ERLH_13A340 | ERLH_13A330 | ERLH_13A327 | | |
| | B3 | | | | | B2-U0-G3 | B2-U0-G3 | B2-U0-G3 | ERLH_13B340 | ERLH_13B330 | ERLH_13B327 | | |
| | C3 | 13000 | 12500 | 12100 | | B2-U0-G3 | B2-U0-G3 | B2-U0-G3 | ERLH_13C340 | ERLH_13C330 | ERLH_13C327 | | |
| | D3 | | | | | B2-U0-G3 | B2-U0-G3 | B1-U0-G3 | ERLH_13D340 | ERLH_13D330 | ERLH_13D327 | | |
| | E3 | | | | | B3-U0-G3 | B3-U0-G3 | B3-U0-G3 | ERLH_13E340 | ERLH_13E330 | ERLH_13E327 | | |
| 14 | A3 | | | | 122 | B3-U0-G3 | B3-U0-G3 | B3-U0-G3 | ERLH_14A340 | ERLH_14A330 | ERLH_14A327 | | |
| | B3 | | | | | B2-U0-G3 | B2-U0-G3 | B2-U0-G3 | ERLH_14B340 | ERLH_14B330 | ERLH_14B327 | | |
| | C3 | 14000 | 13400 | 13000 | | B2-U0-G3 | B2-U0-G3 | B2-U0-G3 | ERLH_14C340 | ERLH_14C330 | ERLH_14C327 | | |
| | D3 | | | | | B2-U0-G3 | B2-U0-G3 | B2-U0-G3 | ERLH_14D340 | ERLH_14D330 | ERLH_14D327 | | |
| | E3 | | | | | B3-U0-G3 | B3-U0-G3 | B3-U0-G3 | ERLH_14E340 | ERLH_14E330 | ERLH_14E327 | | |
| 15 | A3 | | | | 136 | B3-U0-G3 | B3-U0-G3 | B3-U0-G3 | ERLH_15A340 | ERLH_15A330 | ERLH_15A327 | | |
| | B3 | | | | | B2-U0-G3 | B2-U0-G3 | B2-U0-G3 | ERLH_15B340 | ERLH_15B330 | ERLH_15B327 | | |
| | C3 | 15000 | 14400 | 13900 | | B2-U0-G3 | B2-U0-G3 | B2-U0-G3 | ERLH_15C340 | ERLH_15C330 | ERLH_15C327 | | |
| | D3 | | | | | B2-U0-G3 | B2-U0-G3 | B2-U0-G3 | ERLH_15D340 | ERLH_15D330 | ERLH_15D327 | | |
| | E3 | | | | | B3-U0-G3 | B3-U0-G3 | B3-U0-G3 | ERLH_15E340 | ERLH_15E330 | ERLH_15E327 | | |
| 16 | A3 | | | | 149 | B3-U0-G3 | B3-U0-G3 | B3-U0-G3 | ERLH_16A340 | ERLH_16A330 | ERLH_16A327 | | |
| | B3 | | | | | B3-U0-G3 | B3-U0-G3 | B2-U0-G3 | ERLH_16B340 | ERLH_16B330 | ERLH_16B327 | | |
| | C3 | 16000 | 15300 | 14900 | | B2-U0-G3 | B2-U0-G3 | B2-U0-G3 | ERLH_16C340 | ERLH_16C330 | ERLH_16C327 | | |
| | D3 | | | | | B2-U0-G3 | B2-U0-G3 | B2-U0-G3 | ERLH_16D340 | ERLH_16D330 | ERLH_16D327 | | |
| | E3 | | | | | B3-U0-G3 | B3-U0-G3 | B3-U0-G3 | ERLH_16E340 | ERLH_16E330 | ERLH_16E327 | | |

Photometrics:

Evolve® LED Streetlight (ERLH)

ERLH

Type II Narrow
(13A340)

13,000 Lumens
4000K
ERLH_13A340__IES

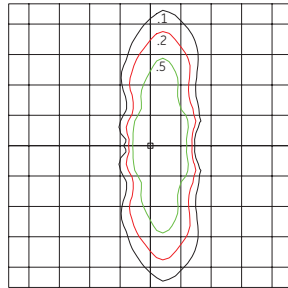

Grid Distance in Units of Mounting Height at 30'
Initial Footcandle Values at Grade

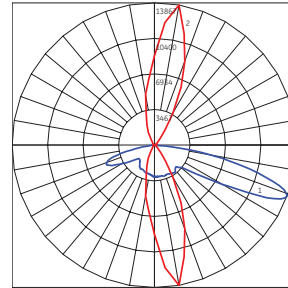

— Vertical plane through horizontal angle of Max. Cd at 80°
— Horizontal cone through vertical angle of Max. Cd at 69°

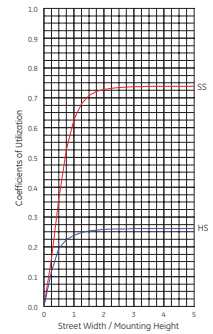

ERLH

Type II Wide
(13B340)

13,000 Lumens
4000K
ERLH_13B340__IES

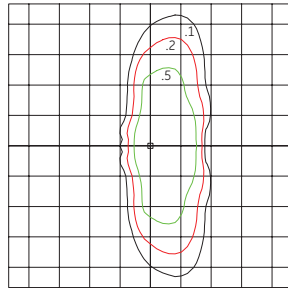

Grid Distance in Units of Mounting Height at 30'
Initial Footcandle Values at Grade

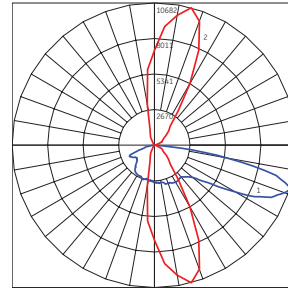

— Vertical plane through horizontal angle of Max. Cd at 75°
— Horizontal cone through vertical angle of Max. Cd at 72°

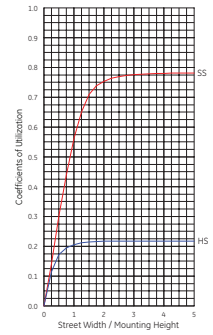

ERLH

Type III
(13C340)

13,000 Lumens
4000K
ERLH_13C340__IES

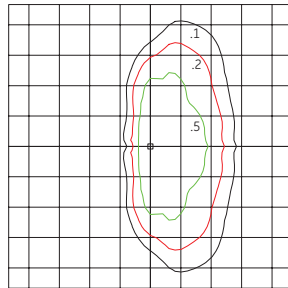

Grid Distance in Units of Mounting Height at 30'
Initial Footcandle Values at Grade

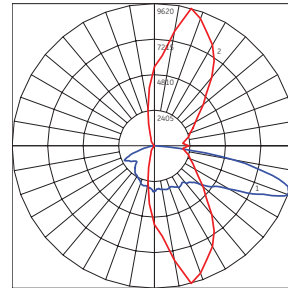

— Vertical plane through horizontal angle of Max. Cd at 75°
— Horizontal cone through vertical angle of Max. Cd at 71°

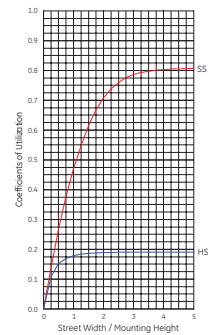

ERLH

Type IV
13D340

13,000 Lumens
4000K
ERLH_13D340__IES

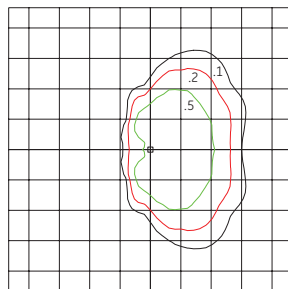

Grid Distance in Units of Mounting Height at 30'
Initial Footcandle Values at Grade

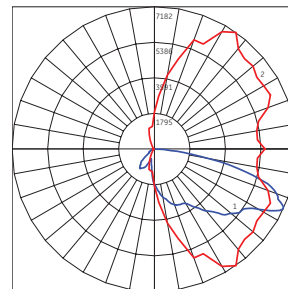

— Vertical plane through horizontal angle of Max. Cd at 55°
— Horizontal cone through vertical angle of Max. Cd at 65°

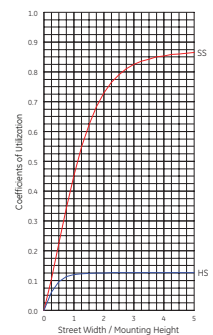

ERLH

Type II Enhanced Back Light
13E340

13,000 Lumens
4000K
ERLH_13E340__IES

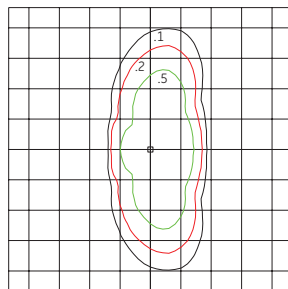

Grid Distance in Units of Mounting Height at 30'
Initial Footcandle Values at Grade

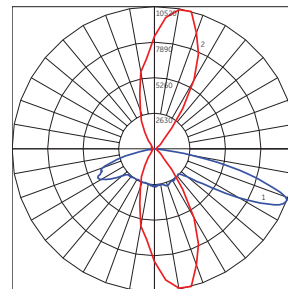

— Vertical plane through horizontal angle of Max. Cd at 75°
— Horizontal cone through vertical angle of Max. Cd at 69°

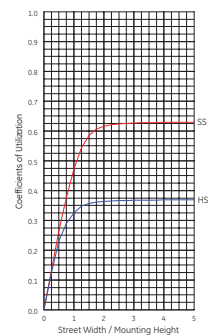

Evolve®

LED Roadway Lighting

ERL1-ERLH-ERL2

Product Dimensions:

Evolve® LED Streetlight (ERLH)

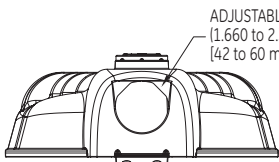
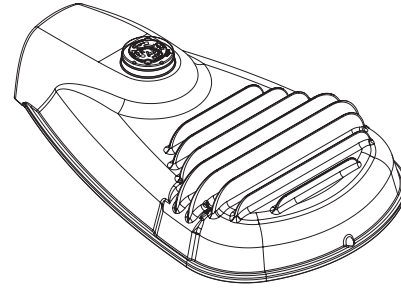
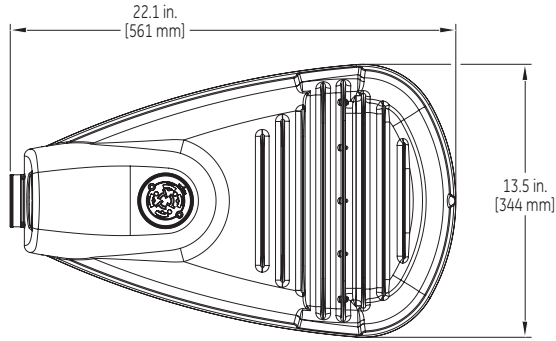

BACK VIEW

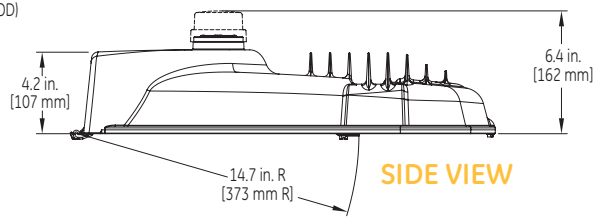

SIDE VIEW

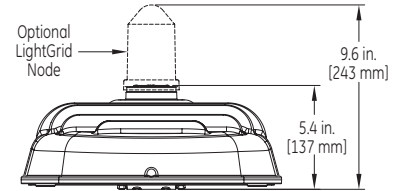

FRONT VIEW

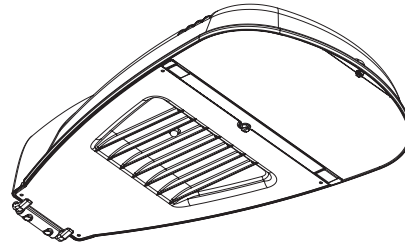
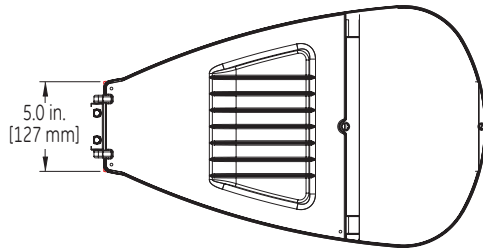

DATA

- Approximate net weight: 15.15 lbs (6.9 kgs) - 2 Bolt Slipfitter
- Approximate net weight: 15.85 lbs (7.2 kgs) - 4 Bolt Slipfitter
- Effective Projected Area (EPA): 0.5 sq ft max (0.046 sq m)



Southwest Florida
Water Management District

2379 Broad Street, Brooksville, Florida 34604-6899
(352) 796-7211 or 1-800-423-1476 (FL only)
SUNCOM 628-4150 TDD only 1-800-231-6103 (FL only)
On the Internet at: WaterMatters.org

An Equal
Opportunity
Employer

Bartow Service Office
170 Century Boulevard
Bartow, Florida 33830-7700
(863) 534-1448 or
1-800-492-7862 (FL only)

Sarasota Service Office
6750 Fruitville Road
Sarasota, Florida 34240-9711
(941) 377-3722 or
1-800-320-3503 (FL only)

Tampa Service Office
7601 Highway 301 North
Tampa, Florida 33637-6759
(813) 985-7481 or
1-800-836-0797 (FL only)

November 01, 2019

Manatee County Public Works Department
Attn: Sia Mollanazar, P.E.
1022 26th Avenue East
Bradenton, FL 34208

Subject: **Notice of Intended Agency Action - Approval
ERP Individual Construction Major Modification**

Project Name: 26th Street West at 30th Avenue West Intersection Improvements
App ID/Permit No: 790150 / 43008747.002
County: Manatee
Sec/Twp/Rge: S03/T35S/R17E

Dear Permittee(s):

The Southwest Florida Water Management District (District) has completed its review of the application for Environmental Resource Permit modification. Based upon a review of the information you have submitted, the District hereby gives notice of its intended approval of the application.

The File of Record associated with this application can be viewed at <http://www18.swfwmd.state.fl.us/erp/erp/search/ERPSearch.aspx> and is also available for inspection Monday through Friday, except for District holidays, from 8:00 a.m. through 5:00 p.m. at the District's Tampa Service Office, 7601 U.S. Highway 301 North, Tampa, Florida 33637.

If you have any questions or concerns regarding the application or any other information, please contact the Environmental Resource Permit Bureau in the Tampa Service Office.

Sincerely,

David Kramer, P.E.
Bureau Chief
Environmental Resource Permit Bureau
Regulation Division

cc: Jason Starr, HDR Engineering, Inc.



Southwest Florida Water Management District

2379 Broad Street, Brooksville, Florida 34604-6899
(352) 796-7211 or 1-800-423-1476 (FL only)
SUNCOM 628-4150 TDD only 1-800-231-6103 (FL only)
On the Internet at: WaterMatters.org

An Equal
Opportunity
Employer

Bartow Service Office
170 Century Boulevard
Bartow, Florida 33830-7700
(863) 534-1448 or
1-800-492-7862 (FL only)

Sarasota Service Office
6750 Fruitville Road
Sarasota, Florida 34240-9711
(941) 377-3722 or
1-800-320-3503 (FL only)

Tampa Service Office
7601 Highway 301 North
Tampa, Florida 33637-6759
(813) 985-7481 or
1-800-836-0797 (FL only)

November 01, 2019

Manatee County Public Works Department
Attn: Sia Mollanazar, P.E.
1022 26th Avenue East
Bradenton, FL 34208

Subject: **Notice of Agency Action - Approval**
ERP Individual Construction Major Modification

Project Name: 26th Street West at 30th Avenue West Intersection Improvements
App ID/Permit No: 790150 / 43008747.002
County: Manatee
Sec/Twp/Rge: S03/T35S/R17E

Dear Permittee(s):

The Southwest Florida Water Management District (District) is in receipt of your application for the Environmental Resource Permit modification. Based upon a review of the information you submitted, the application is approved.

Please refer to the attached Notice of Rights to determine any legal rights you may have concerning the District's agency action on the permit application described in this letter.

If approved construction plans are part of the permit, construction must be in accordance with these plans. These drawings are available for viewing or downloading through the District's Application and Permit Search Tools located at www.WaterMatters.org/permits.

The District's action in this matter only becomes closed to future legal challenges from members of the public if such persons have been properly notified of the District's action and no person objects to the District's action within the prescribed period of time following the notification. The District does not publish notices of agency action. If you wish to limit the time within which a person who does not receive actual written notice from the District may request an administrative hearing regarding this action, you are strongly encouraged to publish, at your own expense, a notice of agency action in the legal advertisement section of a newspaper of general circulation in the county or counties where the activity will occur. Publishing notice of agency action will close the window for filing a petition for hearing. Legal requirements and instructions for publishing notices of agency action, as well as a noticing form that can be used, are available from the District's website at www.WaterMatters.org/permits/noticing. If you publish notice of agency action, a copy of the affidavit of publication provided by the newspaper should be sent to the District's Tampa Service Office for retention in this permit's File of Record.

If you have any questions or concerns regarding your permit or any other information, please contact the Environmental Resource Permit Bureau in the Tampa Service Office.

Sincerely,

David Kramer, P.E.
Bureau Chief
Environmental Resource Permit Bureau
Regulation Division

Enclosures: Approved Permit w/Conditions Attached
 [As-Built Certification and Request for Conversion to Operation Phase](#)
 Notice of Authorization to Commence Construction
 Notice of Rights
cc: Jason Starr, HDR Engineering, Inc.

**SOUTHWEST FLORIDA WATER MANAGEMENT DISTRICT
ENVIRONMENTAL RESOURCE
INDIVIDUAL CONSTRUCTION MAJOR MODIFICATION
PERMIT NO. 43008747.002**

EXPIRATION DATE: November 01, 2024

PERMIT ISSUE DATE: November 01, 2019

This permit is issued under the provisions of Chapter 373, Florida Statutes, (F.S.), and the Rules contained in Chapter 62-330, Florida Administrative Code, (F.A.C.). The permit authorizes the Permittee to proceed with the construction of a surface water management system in accordance with the information outlined herein and shown by the application, approved drawings, plans, specifications, and other documents, attached hereto and kept on file at the Southwest Florida Water Management District (District). Unless otherwise stated by permit specific condition, permit issuance constitutes certification of compliance with state water quality standards under Section 401 of the Clean Water Act, 33 U.S.C. 1341. All construction, operation and maintenance of the surface water management system authorized by this permit shall occur in compliance with Florida Statutes and Administrative Code and the conditions of this permit.

PROJECT NAME: 26th Street West at 30th Avenue West Intersection Improvements

GRANTED TO: Manatee County Public Works Department
Attn: Sia Mollanazar, P.E.
1022 26th Avenue East
Bradenton, FL 34208

OTHER PERMITTEES: N/A

ABSTRACT: This permit authorizes the modification of a stormwater management system previously authorized under Permit No. 44008747.001. The project is located on 30th Avenue West between 26th Street West and 24th Street West in Manatee County. The proposed project modification includes the addition of a dedicated left turn lane from 30th Avenue West westbound to 26th St West southbound, narrowing and replacement of the existing 8 ft unpaved shoulders with 4 ft paved and 1 ft unpaved shoulders on both sides of 30th Avenue West and reconfiguration of the roadside ditches and swales. Water quality treatment and quantity attenuation will be provided in 4 detention with effluent filtration systems. Information regarding the stormwater management system, 100-year floodplain, wetlands and/or surface waters is stated below and on the permitted construction drawings for the project.

OP. & MAIN. ENTITY: Manatee County Public Works Department

OTHER OP. & MAIN. ENTITY: N/A

COUNTY: Manatee

SEC/TWP/RGE: S03/T35S/R17E

TOTAL ACRES OWNED

OR UNDER CONTROL: 1.05

PROJECT SIZE: 1.05 Acres

LAND USE: Road Projects

DATE APPLICATION FILED: September 06, 2019

AMENDED DATE: N/A

I. Water Quantity/Quality

| POND No. | Area Acres @ Top of Bank | Treatment Type |
|----------|--------------------------|---------------------|
| TS2 | 0.03 | EFFLUENT FILTRATION |
| TS3 | 0.04 | EFFLUENT FILTRATION |
| TS4 | 0.03 | EFFLUENT FILTRATION |
| TS5 | 0.08 | EFFLUENT FILTRATION |
| | Total: 0.18 | |

Water Quantity/Quality Comments:

The stormwater management system has been designed to limit the post-development 25-year/24-hour discharge rate to less than the rate under pre-development conditions. Water quality treatment is being provided by detention with effluent filtration in four roadside swales. Elevations referenced on the construction plans and in the drainage modeling are based on the 1988 North American Geodetic Vertical Datum (NAVD88).

A mixing zone is not required.
 A variance is not required.

II. 100-Year Floodplain

| Encroachment (Acre-Feet of fill) | Compensation (Acre-Feet of excavation) | Compensation Type | Encroachment Result* (feet) |
|----------------------------------|--|-------------------|-----------------------------|
| 0.00 | 0.00 | No Encroachment | N/A |

Floodplain Comments:

Currently designated by FEMA as Flood Zone X with minimum flood hazard. No floodplain encroachment is proposed or authorized.

*Depth of change in flood stage (level) over existing receiving water stage resulting from floodplain encroachment caused by a project that claims Minimal Impact type of compensation.

III. Environmental Considerations

No wetlands or other surface waters exist within the project area.

Specific Conditions

1. If the ownership of the project area covered by the subject permit is divided, with someone other than the Permittee becoming the owner of part of the project area, this permit may be terminated, unless the terms of the permit are modified by the District or the permit is transferred pursuant to Rule 40D-1.6105, F.A.C. In such situations, each land owner shall obtain a permit (which may be a modification of this permit) for the land owned by that person. This condition shall not apply to the division and sale of lots or units in residential subdivisions or condominiums.
2. The Permittee shall retain the design professional registered or licensed in Florida, to conduct on-site observations of construction and assist with the as-built certification requirements of this project. The Permittee shall inform the District in writing of the name, address and phone number of the design professional so employed. This information shall be submitted prior to construction.
3. All construction is prohibited within the permitted project area until the Permittee acquires legal ownership or legal control of the project area as delineated in the permitted construction drawings.
4. Prior to installation of the filter media, the Permittee's contractor shall submit a certified test of the media to the Permittee's Engineer-of-Record and the District. The test shall address the following parameters: uniformity coefficient, effective grain size, sieve analysis, percent silts, clays and organic matter, and permeability testing (constant head). If testing indicates the actual permeability rate is less than the value specified in the permitted design, a permit modification will be required to lengthen the effluent filtration system. The Permittee shall also notify the District Service Office that services this permit, at least 48 hours prior to commencement of construction of the effluent filtration system, so that District staff may observe this construction activity.
5. For dry bottom detention systems, the detention area(s) shall become dry within 36 hours after a rainfall event. If a detention area is regularly wet, this situation shall be deemed to be a violation of this permit.
6. This Permit Modification No. 43008747.002, replaces the previously issued Permit No. 44008747.001, and all of its conditions upon transfer of this permit to the operation phase.
7. If limestone bedrock is encountered during construction of the stormwater management system, the District must be notified and construction in the affected area shall cease.
8. The Permittee shall notify the District of any sinkhole development in the stormwater management system within 48 hours of discovery and must submit a detailed sinkhole evaluation and repair plan for approval by the District within 30 days of discovery.
9. The Permitted Plan Set for this project includes: the set received by the District on October 29, 2019.
10. The operation and maintenance entity shall provide for the inspection of the permitted project after conversion of the permit to the operation and maintenance phase. For systems utilizing effluent filtration or exfiltration or systems utilizing effluent filtration or exfiltration and retention or wet detention, the inspections shall be performed 24 months after operation is authorized and every 24 months thereafter.

The operation and maintenance entity must maintain a record of each inspection, including the date of inspection, the name and contact information of the inspector, whether the system was functioning as designed and permitted, and make such record available upon request of the District.

Within 30 days of any failure of a stormwater management system or deviation from the permit, an inspection report shall be submitted using Form 62-330.311(1), "Operation and Maintenance Inspection Certification" describing the remedial actions taken to resolve the failure or deviation.

11. District staff must be notified in advance of any proposed construction dewatering. If the dewatering activity is likely to result in offsite discharge or sediment transport into wetlands or surface waters, a written dewatering plan must either have been submitted and approved with the permit application or submitted to the District as a permit prior to the dewatering event as a permit modification. A water use permit may be required prior to any use

exceeding the thresholds in Chapter 40D-2, F.A.C.

12. Off-site discharges during construction and development shall be made only through the facilities authorized by this permit. Water discharged from the project shall be through structures having a mechanism suitable for regulating upstream stages. Stages may be subject to operating schedules satisfactory to the District.
13. The permittee shall complete construction of all aspects of the stormwater management system, including wetland compensation (grading, mulching, planting), water quality treatment features, and discharge control facilities prior to beneficial occupancy or use of the development being served by this system.
14. The following shall be properly abandoned and/or removed in accordance with the applicable regulations:
 - a. Any existing wells in the path of construction shall be properly plugged and abandoned by a licensed well contractor.
 - b. Any existing septic tanks on site shall be abandoned at the beginning of construction.
 - c. Any existing fuel storage tanks and fuel pumps shall be removed at the beginning of construction.
15. All stormwater management systems shall be operated to conserve water in order to maintain environmental quality and resource protection; to increase the efficiency of transport, application and use; to decrease waste; to minimize unnatural runoff from the property and to minimize dewatering of offsite property.
16. Each phase or independent portion of the permitted system must be completed in accordance with the permitted plans and permit conditions prior to the occupation of the site or operation of site infrastructure located within the area served by that portion or phase of the system. Each phase or independent portion of the system must be completed in accordance with the permitted plans and permit conditions prior to transfer of responsibility for operation and maintenance of that phase or portion of the system to a local government or other responsible entity.
17. This permit is valid only for the specific processes, operations and designs indicated on the approved drawings or exhibits submitted in support of the permit application. Any substantial deviation from the approved drawings, exhibits, specifications or permit conditions, including construction within the total land area but outside the approved project area(s), may constitute grounds for revocation or enforcement action by the District, unless a modification has been applied for and approved. Examples of substantial deviations include excavation of ponds, ditches or sump areas deeper than shown on the approved plans.
18. This permit does not authorize the Permittee to cause any adverse impact to or "take" of state listed species and other regulated species of fish and wildlife. Compliance with state laws regulating the take of fish and wildlife is the responsibility of the owner or applicant associated with this project. Please refer to Chapter 68A-27 of the Florida Administrative Code for definitions of "take" and a list of fish and wildlife species. If listed species are observed onsite, FWC staff are available to provide decision support information or assist in obtaining the appropriate FWC permits. Most marine endangered and threatened species are statutorily protected and a "take" permit cannot be issued. Requests for further information or review can be sent to FWCConservationPlanningServices@MyFWC.com.

GENERAL CONDITIONS

1. The general conditions attached hereto as Exhibit "A" are hereby incorporated into this permit by reference and the Permittee shall comply with them.

David Kramer, P.E.

Authorized Signature

EXHIBIT A

GENERAL CONDITIONS:

- 1 The following general conditions are binding on all individual permits issued under this chapter, except where the conditions are not applicable to the authorized activity, or where the conditions must be modified to accommodate, project-specific conditions.
 - a. All activities shall be implemented following the plans, specifications and performance criteria approved by this permit. Any deviations must be authorized in a permit modification in accordance with Rule 62-330.315, F.A.C., or the permit may be revoked and the permittee may be subject to enforcement action.
 - b. A complete copy of this permit shall be kept at the work site of the permitted activity during the construction phase, and shall be available for review at the work site upon request by the Agency staff. The permittee shall require the contractor to review the complete permit prior to beginning construction.
 - c. Activities shall be conducted in a manner that does not cause or contribute to violations of state water quality standards. Performance-based erosion and sediment control best management practices shall be installed immediately prior to, and be maintained during and after construction as needed, to prevent adverse impacts to the water resources and adjacent lands. Such practices shall be in accordance with the *State of Florida Erosion and Sediment Control Designer and Reviewer Manual (Florida Department of Environmental Protection and Florida Department of Transportation June 2007)*, and the *Florida Stormwater Erosion and Sedimentation Control Inspector's Manual (Florida Department of Environmental Protection, Nonpoint Source Management Section, Tallahassee, Florida, July 2008)*, which are both incorporated by reference in subparagraph 62-330.050(8)(b)5, F.A.C., unless a project-specific erosion and sediment control plan is approved or other water quality control measures are required as part of the permit.
 - d. At least 48 hours prior to beginning the authorized activities, the permittee shall submit to the Agency a fully executed Form 62-330.350(1), "Construction Commencement Notice,"[effective date], incorporated by reference herein (<http://www.flrules.org/Gateway/reference.asp?No=Ref-02505>), indicating the expected start and completion dates. A copy of this form may be obtained from the Agency, as described in subsection 62-330.010(5),F.A.C. However, for activities involving more than one acre of construction that also require a NPDES stormwater construction general permit, submittal of the Notice of Intent to Use Generic Permit for Stormwater Discharge from Large and Small Construction Activities, DEP Form 62-621.300(4)(b), shall also serve as notice of commencement of construction under this chapter and, in such a case, submittal of Form 62-330.350(1) is not required.
 - e. Unless the permit is transferred under Rule 62-330.340, F.A.C., or transferred to an operating entity under Rule 62-330.310, F.A.C., the permittee is liable to comply with the plans, terms and conditions of the permit for the life of the project or activity.
 - f. Within 30 days after completing construction of the entire project, or any independent portion of the project, the permittee shall provide the following to the Agency, as applicable:
 1. For an individual, private single-family residential dwelling unit, duplex, triplex, or quadruplex - "Construction Completion and Inspection Certification for Activities Associated with a Private Single-Family Dwelling Unit" [Form 62-330.310(3)]; or
 2. For all other activities - "As-Built Certification and Request for Conversion to Operation Phase" [Form 62-330.310(1)].
 3. If available, an Agency website that fulfills this certification requirement may be used in lieu of the form.
 - g. If the final operation and maintenance entity is a third party:

1. Prior to sales of any lot or unit served by the activity and within one year of permit issuance, or within 30 days of as- built certification, whichever comes first, the permittee shall submit, as applicable, a copy of the operation and maintenance documents (see sections 12.3 thru 12.3.4 of Volume I) as filed with the Department of State, Division of Corporations and a copy of any easement, plat, or deed restriction needed to operate or maintain the project, as recorded with the Clerk of the Court in the County in which the activity is located.
 2. Within 30 days of submittal of the as- built certification, the permittee shall submit "Request for Transfer of Environmental Resource Permit to the Perpetual Operation and Maintenance Entity" [Form 62-330.310 (2)] to transfer the permit to the operation and maintenance entity, along with the documentation requested in the form. If available, an Agency website that fulfills this transfer requirement may be used in lieu of the form.
- h. The permittee shall notify the Agency in writing of changes required by any other regulatory agency that require changes to the permitted activity, and any required modification of this permit must be obtained prior to implementing the changes.
- i. This permit does not:
1. Convey to the permittee any property rights or privileges, or any other rights or privileges other than those specified herein or in Chapter 62-330, F.A.C.;
 2. Convey to the permittee or create in the permittee any interest in real property;
 3. Relieve the permittee from the need to obtain and comply with any other required federal, state, and local authorization, law, rule, or ordinance; or
 4. Authorize any entrance upon or work on property that is not owned, held in easement, or controlled by the permittee.
- j. Prior to conducting any activities on state-owned submerged lands or other lands of the state, title to which is vested in the Board of Trustees of the Internal Improvement Trust Fund, the permittee must receive all necessary approvals and authorizations under Chapters 253 and 258, F.S. Written authorization that requires formal execution by the Board of Trustees of the Internal Improvement Trust Fund shall not be considered received until it has been fully executed.
- k. The permittee shall hold and save the Agency harmless from any and all damages, claims, or liabilities that may arise by reason of the construction, alteration, operation, maintenance, removal, abandonment or use of any project authorized by the permit.
- l. The permittee shall notify the Agency in writing:
1. Immediately if any previously submitted information is discovered to be inaccurate; and
 2. Within 30 days of any conveyance or division of ownership or control of the property or the system, other than conveyance via a long-term lease, and the new owner shall request transfer of the permit in accordance with Rule 62-330.340, F.A.C. This does not apply to the sale of lots or units in residential or commercial subdivisions or condominiums where the stormwater management system has been completed and converted to the operation phase.
- m. Upon reasonable notice to the permittee, Agency staff with proper identification shall have permission to enter, inspect, sample and test the project or activities to ensure conformity with the plans and specifications authorized in the permit.
- n. If any prehistoric or historic artifacts, such as pottery or ceramics, stone tools or metal implements, dugout canoes, or any other physical remains that could be associated with Native American cultures, or early colonial or American settlement are encountered at any time within the project site area, work involving

subsurface disturbance in the immediate vicinity of such discoveries shall cease. The permittee or other designee shall contact the Florida Department of State, Division of Historical Resources, Compliance and Review Section, at (850) 245-6333 or (800) 847-7278, as well as the appropriate permitting agency office. Such subsurface work shall not resume without verbal or written authorization from the Division of Historical Resources. If unmarked human remains are encountered, all work shall stop immediately and notification shall be provided in accordance with Section 872.05, F.S. (2012).

- o. Any delineation of the extent of a wetland or other surface water submitted as part of the permit application, including plans or other supporting documentation, shall not be considered binding unless a specific condition of this permit or a formal determination under Rule 62-330.201, F.A.C., provides otherwise.
 - p. The permittee shall provide routine maintenance of all components of the stormwater management system to remove trapped sediments and debris. Removed materials shall be disposed of in a landfill or other uplands in a manner that does not require a permit under Chapter 62-330, F.A.C., or cause violations of state water quality standards.
 - q. This permit is issued based on the applicant's submitted information that reasonably demonstrates that adverse water resource-related impacts will not be caused by the completed permit activity. If any adverse impacts result, the Agency will require the permittee to eliminate the cause, obtain any necessary permit modification, and take any necessary corrective actions to resolve the adverse impacts.
 - r. A Recorded Notice of Environmental Resource Permit may be recorded in the county public records in accordance with Rule 62-330.090(7), F.A.C. Such notice is not an encumbrance upon the property.
2. In addition to those general conditions in subsection (1) above, the Agency shall impose any additional project-specific special conditions necessary to assure the permitted activities will not be harmful to the water resources, as set forth in Rules 62-330.301 and 62-330.302, F.A.C., Volumes I and II, as applicable, and the rules incorporated by reference in this chapter.

SOUTHWEST FLORIDA
WATER MANAGEMENT DISTRICT

**NOTICE OF
AUTHORIZATION
TO COMMENCE CONSTRUCTION**

26th Street West at 30th Avenue West Intersection Improvements

PROJECT NAME

Road Projects

PROJECT TYPE

Manatee

COUNTY

S03/T35S/R17E

SEC(S)/TWP(S)/RGE(S)

Manatee County Public Works Department

PERMITTEE

APPLICATION ID/PERMIT NO: 790150 / 43008747.002

DATE ISSUED: November 01, 2019



David Kramer, P.E.

Issuing Authority

**THIS NOTICE SHOULD BE CONSPICUOUSLY
DISPLAYED AT THE SITE OF THE WORK**

Notice of Rights

ADMINISTRATIVE HEARING

1. You or any person whose substantial interests are or may be affected by the District's intended or proposed action may request an administrative hearing on that action by filing a written petition in accordance with Sections 120.569 and 120.57, Florida Statutes (F.S.), Uniform Rules of Procedure Chapter 28-106, Florida Administrative Code (F.A.C.) and District Rule 40D-1.1010, F.A.C. Unless otherwise provided by law, a petition for administrative hearing must be filed with (received by) the District within 21 days of receipt of written notice of agency action. "Written notice" means either actual written notice, or newspaper publication of notice, that the District has taken or intends to take agency action. "Receipt of written notice" is deemed to be the fifth day after the date on which actual notice is deposited in the United States mail, if notice is mailed to you, or the date that actual notice is issued, if sent to you by electronic mail or delivered to you, or the date that notice is published in a newspaper, for those persons to whom the District does not provide actual notice.
2. Pursuant to Subsection 373.427(2)(c), F.S., for notices of intended or proposed agency action on a consolidated application for an environmental resource permit and use of state-owned submerged lands concurrently reviewed by the District, a petition for administrative hearing must be filed with (received by) the District within 14 days of receipt of written notice.
3. Pursuant to Rule 62-532.430, F.A.C., for notices of intent to deny a well construction permit, a petition for administrative hearing must be filed with (received by) the District within 30 days of receipt of written notice of intent to deny.
4. Any person who receives written notice of an agency decision and who fails to file a written request for a hearing within 21 days of receipt or other period as required by law waives the right to request a hearing on such matters.
5. Mediation pursuant to Section 120.573, F.S., to settle an administrative dispute regarding District intended or proposed action is not available prior to the filing of a petition for hearing.
6. A request or petition for administrative hearing must comply with the requirements set forth in Chapter 28-106, F.A.C. A request or petition for a hearing must: (1) explain how the substantial interests of each person requesting the hearing will be affected by the District's intended action or proposed action, (2) state all material facts disputed by the person requesting the hearing or state that there are no material facts in dispute, and (3) otherwise comply with Rules 28-106.201 and 28-106.301, F.A.C. Chapter 28-106, F.A.C. can be viewed at www.flrules.org or at the District's website at www.WaterMatters.org/permits/rules.
7. A petition for administrative hearing is deemed filed upon receipt of the complete petition by the District Agency Clerk at the District's Tampa Service Office during normal business hours, which are 8:00 a.m. to 5:00 p.m., Monday through Friday, excluding District holidays. Filings with the District Agency Clerk may be made by mail, hand-delivery or facsimile transfer (fax). The District does not accept petitions for administrative hearing by electronic mail. Mailed filings must be addressed to, and hand-delivered filings must be delivered to, the Agency Clerk, Southwest Florida Water Management District, 7601 Highway 301 North, Tampa, FL 33637-6759. Faxed filings must be transmitted to the District Agency Clerk at (813) 367-9776. Any petition not received during normal business hours shall be filed as of 8:00 a.m. on the next business day. The District's acceptance of faxed petitions for filing is subject to certain conditions set forth in the District's Statement of Agency Organization and Operation, available for viewing at www.WaterMatters.org/about.

JUDICIAL REVIEW

1. Pursuant to Sections 120.60(3) and 120.68, F.S., a party who is adversely affected by District action may seek judicial review of the District's action. Judicial review shall be sought in the Fifth District Court of Appeal or in the appellate district where a party resides or as otherwise provided by law.
2. All proceedings shall be instituted by filing an original notice of appeal with the District Agency Clerk within 30 days after the rendition of the order being appealed, and a copy of the notice of appeal, accompanied by any filing fees prescribed by law, with the clerk of the court, in accordance with Rules 9.110 and 9.190 of the Florida Rules of Appellate Procedure (Fla. R. App. P.). Pursuant to Fla. R. App. P. 9.020(h), an order is rendered when a signed written order is filed with the clerk of the lower tribunal.



FLORIDA DEPARTMENT OF Environmental Protection

Southwest District Office
13051 North Telecom Parkway #101
Temple Terrace, Florida 33637-0926

Ron DeSantis
Governor

Jeanette Nuñez
Lt. Governor

Noah Valenstein
Secretary

Notification of Acceptance of Use of a General Permit

PERMITTEE:

Mr. Sia Mollanazar, P.E., Deputy Director
Manatee County
1022 26th Avenue East
Bradenton, Florida 34208
sia.mollanazar@mymanatee.org

Permit Number: 0133068-1395-DSGP/02

Issue Date: June 19, 2020

Expiration Date: June 18, 2025

County: Manatee

Project Name: 30th Avenue and 26th Street
Manatee Co Road Project

Water Supplier: Manatee County Utilities

PWS ID: 641-1132

Dear Mr. Mollanazar:

On June 15, 2020, the Florida Department of Environmental Protection received a “*Notice of Intent to Use the General Permit for Construction of Water Main Extensions for PWSs*” [DEP Form No. 62-555.900(7)], under the provisions of Rule 62-4.530 and Chapter 62-555, Florida Administrative Code (F.A.C.). The proposed project includes the construction of a new six-inch diameter water main and a new four-inch diameter water main, along 30th Avenue at the intersection of 25th Street.

Based upon the submitted Notice and accompanying documentation, this correspondence is being sent to advise that the Department does not object to the use of such general permit at this time. Please be advised that the permittee is required to abide by Rule 62-555.405, F.A.C., all applicable rules in Chapters 62-4, 62-550, 62-555, F.A.C., and the General Conditions for All General Drinking Water Permits (found in 62-4.540, F.A.C.).

The permittee shall comply with all sampling requirements specific to this project. These requirements are attached for review and implementation.

Pursuant to Rule 62-555.345, F.A.C., the permittee shall submit a certification of construction completion [DEP Form No. 62-555.900(9)] to the Department and obtain approval, or clearance, from the Department before placing any water main extension constructed under this general permit into operation for any purpose other than disinfection or testing for leaks.

Within 30 days after the sale or legal transfer of ownership of the permitted project that has not been cleared for service in total by the Department, both the permittee and the proposed permittee shall sign and submit an application for transfer of the permit using Form 62-555.900(8), F.A.C., with the appropriate fee. The permitted construction is not authorized past the 30-day period unless the permit has been transferred.

Permittee: Mr. Sia Mollanazar, P.E., Deputy Director
Manatee County
Project: 30th Avenue and 26th Street Manatee Co Road Project

DEP File No.: 0133068-1395-DSGP/02

Page 2

This permit will expire five years from the date of issuance. If the project has been started and not completed by that time, a new permit must be obtained before the expiration date in order to continue work on the project, per Rule 62-4.030, F.A.C.

STATE OF FLORIDA
DEPARTMENT OF ENVIRONMENTAL PROTECTION



for Pamala Vazquez
Program Administrator
Permitting & Waste Cleanup Program
Southwest District

Enclosures: Clearance Requirements/Utilities Separation Requirements

cc:

Heather L. Manganiello, P.E., HDR Engineering, Inc., heather.manganiello@hdrinc.com
Kenneth Labarr, Manatee County Public Works Dept., kenneth.labarr@mymanatee.org
Alexandria Moorehead, DEP SWD, alexandria.moorehead@floridadep.gov

A Civil Penalty May Be Incurred
if this project is placed into operation before obtaining a clearance from this office.

Requirements for clearance upon completion of projects are as follows:

1) Clearance Form

Submission of a fully completed Department of Environmental Protection (DEP) Form 62-555.900(9) *Certification of Construction Completion and Request for Clearance to Place Permitted PWS Components into Operation.*

2) Record Drawings, if deviations were made

Submission of the portion of record drawings showing deviations from the DEP construction permit, including preliminary design report or drawings and specifications, if there are any deviations from said permit (Note that it is necessary to submit a copy of only the portion of record drawings showing deviations and not a complete set of record drawings.).



3) Bacteriological Results

Copies of satisfactory bacteriological analysis (a.k.a. Main Clearance), taken within sixty (60) days of completion of construction, from locations within the distribution system or water main extension to be cleared, in accordance with Rules 62-555.315(6), 62-555.320(12)(d), 62-555.350(6), 62-555.340, and 62-555.330, F.A.C. and American Water Works Association (AWWA) Standard C 651-92, as follows:

- Connection to an existing system
- The end point of the proposed addition
- Any water lines branching off a main extension
- Every 1,200 feet on straight runs of pipe

Each location shall be sampled on two consecutive days, at least 6 hours apart, with sample points and chlorine residual readings clearly indicated on the report. A sketch or description of all bacteriological sampling locations must also be provided.

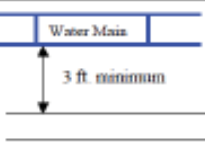
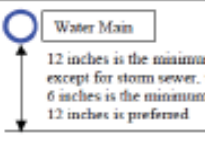
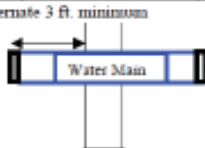
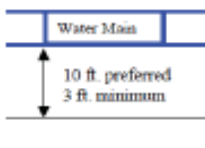
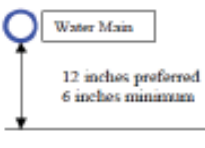
LOCATION OF PUBLIC WATER SYSTEM MAINS IN ACCORDANCE WITH RULE 62-555.314, F.A.C.

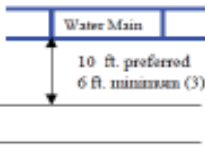
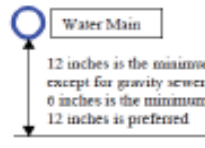
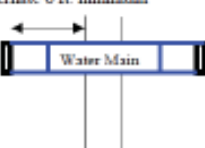
| Other Pipe | Horizontal Separation | Crossings (1) | Joint Spacing @ Crossings (Full Joint Centered) |
|---|---|--|---|
| Storm Sewer, Stormwater Force Main, Reclaimed Water (2) |  |  |  |
| Vacuum Sanitary Sewer |  |  |  |
| Gravity or Pressure Sanitary Sewer, Sanitary Sewer Force Main, Reclaimed Water (4) |  |  |  |
| On-Site Sewage Treatment & Disposal System | 10 ft. minimum | --- | --- |



- (1) Water main should cross above other pipe. When water main must be below other pipe, the minimum separation is 12 inches.
- (2) Reclaimed water regulated under Part III of Chapter 62-610, F.A.C.
- (3) 3 ft. for gravity sanitary sewer where the bottom of the water main is laid at least 6 inches above the top of the gravity sanitary sewer.
- (4) Reclaimed water not regulated under Part III of Chapter 62-610, F.A.C.

EXCEPTIONS TO MINIMUM SEPARATION REQUIREMENTS

Where it is not technically feasible or economically sensible to comply with the requirements of 62-555.314(1) or (2), F.A.C., the Department shall allow exceptions to these requirements if suppliers of water or construction permit applicants provide technical or economic justification for each exception and provide alternative construction features that afford a similar level of reliability and public health protection.

Acceptable alternative construction features include the following:

LOCATION OF PUBLIC WATER SYSTEM MAINS IN ACCORDANCE WITH 62-555.314(5)(a), F.A.C.

| Other Pipe | Horizontal Separation | Joint Spacing @ Crossings (Full Joint Centered) |
|--|---|--|
| Gravity or Pressure Sanitary Sewer, Sanitary Sewer Force Main, Reclaimed Water, Vacuum Sanitary Sewer, Storm Sewer, Stormwater Force Main |  |  |

Where an underground water main is being laid less than the required minimum horizontal distance from another pipeline and where an underground water main is crossing another pipeline and joints in the water main are being located less than the required minimum distance from joints in the other pipeline:

1. Use of pressure-rated pipe conforming to the American Water Works Association standards incorporated into Rule 62-555.330, F.A.C., for the other pipeline if it is a gravity- or vacuum-type pipeline;
2. Use of welded, fused, or otherwise restrained joints for either the water main or the other pipeline; or
3. Use of watertight casing pipe or concrete encasement at least four inches thick for either the water main or the other pipeline.

LOCATION OF PUBLIC WATER SYSTEM MAINS IN ACCORDANCE WITH 62-555.314(5)(b), F.A.C.

| Other Pipe | Horizontal Separation | Crossings |
|--|---|--|
| Gravity or Pressure Sanitary Sewer, Sanitary Sewer Force Main, Reclaimed Water, Vacuum Sanitary Sewer, Storm Sewer, Stormwater Force Main |  |  |

Where an underground water main is being laid less than three feet horizontally from another pipeline and where an underground water main is crossing another pipeline and is being laid less than the required minimum vertical distance from the other pipeline:

Use of pipe, or casing pipe, having high impact strength (i.e., having an impact strength at least equal to that of 0.25-inch-thick ductile iron pipe) or concrete encasement at least four inches thick for both the water main and for the other pipeline if it is new and is conveying wastewater or reclaimed water.

Disclaimer – This document is provided for your convenience only. Please refer to Rule 62-555.314, F.A.C., for additional construction requirements.

SECTION D, SAMPLE CONSTRUCTION AGREEMENT WITH GENERAL CONDITIONS OF THE CONSTRUCTION AGREEMENT AND AGREEMENT EXHIBITS

CONSTRUCTION AGREEMENT

for

STIPULATED SUM

between

MANATEE COUNTY (AS OWNER)

and

<CONTRACTOR NAME> (AS CONTRACTOR)

CONSTRUCTION AGREEMENT FOR STIPULATED SUM

[Project Name]

THIS AGREEMENT (“Agreement”) is made and entered into by and between Manatee County, a political subdivision of the State of Florida, referred to herein as “Owner”, and the firm of _____, incorporated in the State of _____ and registered and licensed to do business in the State of Florida (license # _____), referred to herein as “Contractor.”

WHEREAS, the Owner intends to construct [PROJECT DESCRIPTION], the aforementioned improvements being hereinafter referred to and defined as the “Project”; and

WHEREAS, in response to Owner’s Invitation for Bid No. _____ (the “IFB”), Contractor has submitted its Bid (the “Contractor’s Bid”) to provide the aforementioned construction services.

NOW THEREFORE, the Owner and the Contractor, in consideration of the mutual covenants hereinafter set forth, the sufficiency of which is hereby acknowledged, agree as follows:

1. Contract Documents

The Contract Documents consist of this Agreement and attached Exhibits, the attached General Conditions of the Construction Agreement, Supplementary Conditions (if any), Special Conditions (if any), Drawings (the titles of which are attached hereto as Exhibit A), Specifications (the titles of which are attached hereto as Exhibit B), Addenda issued prior to execution of this Agreement, the Invitation for Bid (including any Instructions to Bidders, Scope of Work, Bid Summary, Supplements, and Technical Specifications), any interpretations issued pursuant to the Invitation for Bid, the Contractor’s Bid, permits, notice of intent to award, Notice to Proceed, purchase order(s), any other documents listed in this Agreement, and Modifications [to include written Amendment(s), Change Order(s), Work Directive Change(s) and Field Directive(s)] issued after execution of this Agreement. These form the Agreement, and are as fully a part of the Agreement as if attached or repeated herein. This Agreement represents the entire and integrated agreement between the parties hereto and supersedes prior negotiations, representations or agreements, either written or oral. No other documents shall be considered Contract Documents.

2. Work

The Contractor shall fully execute the Work described in the Contract Documents, except to the extent specifically indicated in the Contract Documents to be the responsibility of others.

3. Date of Commencement and Substantial Completion.

- A. Date of Commencement. The date of commencement of the Work shall be the date fixed in a Notice to Proceed issued by the Owner.
- B. Contract Time. The Contract Time shall be measured from the date of commencement.
- C. Substantial Completion. The Contractor shall achieve Substantial Completion of the entire Work not later than _____ days from the date of commencement, or as follows:

| Portion of Work | Substantial Completion Date |
|------------------------|------------------------------------|
|------------------------|------------------------------------|

subject to adjustments of this Contract Time as provided in the Contract Documents.

Time is of the essence in the Contract Documents and all obligations thereunder. If the Contractor fails to achieve Substantial Completion of the Work within the Contract Time and as otherwise required by the Contract Documents (to include not only the entire Work but any portion of the Work as set forth above), the Owner shall be entitled to retain or recover from the Contractor, as liquidated damages and not as a penalty, the sum of \$_____ per calendar day, commencing upon the first day following expiration of the Contract Time and continuing until the actual date of Substantial Completion. Such liquidated damages are hereby agreed to be a reasonable estimate of damages the Owner will incur because of delayed completion of the Work. The Owner may deduct liquidated damages as described in this paragraph from any unpaid amounts then or thereafter due the Contractor under this Agreement. Any liquidated damages not so deducted from any unpaid amounts due the Contractor shall be payable to the Owner at the demand of the Owner, together with interest from the date of the demand at the maximum allowable rate.

4. Contract Sum

- A. Payment. The Owner shall pay the Contractor the Contract Sum in current funds for the Contractor's performance of the Contract. The Contract Sum shall be _____ Dollars and _____ Cents (\$_____), subject to additions and deductions as provided in the Contract Documents.
- B. Alternates. The Contract Sum is based upon the following alternates, if any, which are described in the Contract Documents and are hereby accepted by the Owner.

(State the numbers or other identification of accepted alternates. If decisions on other alternates are to be made by the Owner subsequent to the execution of this Agreement, attach a schedule of such other alternates showing the amount for each and the date when that amount expires.)

- C. Unit Prices. Unit prices, if any, are reflected in the Contractor's Bid.

5. Payments

A. Progress Payments

- (1) Based upon Applications for Payment submitted to the Architect/Engineer by the Contractor and Certificates for Payment issued by the Architect/Engineer, the Owner shall make progress payments on account of the Contract Sum to the Contractor as provided below and elsewhere in the Contract Documents.
- (2) The period covered by each Application for Payment shall be one calendar month ending on the last day of the month.
- (3) Payments shall be made by Owner in accordance with the requirements of Section 218.735, Florida Statutes.
- (4) Each Application for Payment shall be based on the most recent schedule of values submitted by the Contractor in accordance with the Contract Documents. The schedule of values shall allocate the entire Contract Sum among the various portions of the Work. The schedule of values shall be prepared in such form and supported by such data to substantiate its accuracy as the Architect/Engineer may require. This schedule, unless objected to by the Owner or Architect/Engineer, shall be used as a basis for reviewing the Contractor's Applications for Payment.
- (5) Applications for Payment shall indicate the percentage of completion of each portion of the Work as of the end of the period covered by the Application for Payment.
- (6) Subject to other provisions of the Contract Documents, the amount of each progress payment shall be computed as follows:
 - i. Take that portion of the Contract Sum properly allocable to completed Work as determined by multiplying the percentage completion of each portion of the Work by the share of the Contract Sum allocated to that portion of the Work in the schedule of values, less retainage of ten percent (10.00%). Pending final determination of cost to the Owner of changes in the Work, amounts not in dispute shall be included as provided in Section 3.3.B. of the General Conditions;
 - ii. Add that portion of the Contract Sum properly allocable to materials and equipment delivered and suitably stored at the site for subsequent incorporation in the completed construction (or, if approved in advance by the Owner, suitably stored off the site at a location agreed upon in writing), supported by paid receipts, less retainage of ten percent (10.00%);
 - iii. Subtract the aggregate of previous payments made by the Owner; and
 - iv. Subtract amounts, if any, for which the Architect/Engineer has withheld or nullified an Application for Payment, in whole or in part as provided in Section 3.3.C. of the General Conditions.

(7) The progress payment amount determined in accordance with Section 5.A(6) shall be further modified under the following circumstances:

- i. Add, upon Substantial Completion of the Work, a sum sufficient to increase the total payments to the full amount of the Contract Sum, less such amounts as the Architect/Engineer shall determine for incomplete Work, retainage applicable to such work and unsettled claims.
- ii. Add, if final completion of the Work is thereafter materially delayed through no fault of the Contractor, any additional amounts payable in accordance with Section 3.2.B. of the General Conditions.

(8) Reduction or limitation of retainage, if any, shall be as follows:

Notwithstanding the foregoing, upon completion of at least 50% of the Work, as determined by the Architect/Engineer and Owner, the Owner shall reduce to five percent (5%) the amount of retainage withheld from each subsequent progress payment.

(9) Except with the Owner's prior approval, the Contractor shall not make advance payments to suppliers for materials or equipment which have not been delivered and stored at the site.

B. Final Payment. Final Payment, constituting the entire unpaid balance of the Contract Sum, shall be made by the Owner to the Contractor when:

- (1) The Contractor has fully performed the Work except for the Contractor's responsibility to correct Work as provided in Section 2.4.C. of the General Conditions, and to satisfy other requirements, if any, which extend beyond final payment; and
- (2) A final Application for Payment has been approved by the Architect/Engineer.

6. Termination or Suspension.

- A. Termination. The Agreement may be terminated by the Owner or the Contractor as provided in Article XIV of the General Conditions.
- B. Suspension by Owner. The Work may be suspended by the Owner as provided in Article XIV of the General Conditions.

7. Other Provisions.

- A. Substantial Completion Defined. Substantial Completion shall be defined as provided in Article I of the General Conditions. In the event a temporary certificate of occupancy or completion is issued establishing Substantial Completion, the Contractor shall diligently pursue the issuance of a permanent certificate of occupancy or completion.

- B. Project Meetings. There shall be a project meeting, at the jobsite or other location acceptable to the parties, on a regularly scheduled basis. The meeting will be attended by a representative of the Contractor, Architect/Engineer and Owner. These representatives shall be authorized to make decisions that are not otherwise contrary to the requirements of this Agreement.
- C. Weather. Any rainfall, temperatures below 32 degrees Fahrenheit or winds greater than 25 m.p.h. which actually prevents Work on a given day, shall be considered lost time and an additional day added to the Contract Time, provided no work could be done on site, and provided written notice has been submitted to the Owner by the Contractor documenting same.
- D. Shop Drawings; Critical Submittals. In consideration of the impact of timely review of submittals and shop drawings on the overall progress of the Work, it is hereby agreed that the Owner shall cause his agents and design professionals to accomplish the review of any particular "critical" submittals and/or shop drawings and return same to the Contractor within fourteen (14) days.
- E. Applications for Payment. Applications for Payment shall be submitted once monthly at regular intervals and shall include detailed documentation of all costs incurred.
- F. Punch List. Within 30 days after obtainment of Substantial Completion, the Owner shall generate a "punch list" of all work items requiring remedial attention by the Contractor. Within 5 days thereafter the Architect/Engineer shall assign a fair value to the punch list items, which sum shall be deducted from the next scheduled progress payment to the Contractor. Upon satisfactory completion of the punch list items, as certified by the Architect/Engineer, the previously deducted sum shall be paid to the Contractor.
- G. Closeout documentation. Within 30 days after obtainment of Substantial Completion and before final payment, Contractor shall gather and deliver to Owner all warranty documentation, all manufacturer's product and warranty literature, all manuals (including parts and technical manuals), all schematics and handbooks, and all as-built drawings.
- H. Governing Provisions; Conflicts. In the event of a conflict between this Agreement and the Specifications or as between the General Conditions and the Specifications, the Specifications shall govern.
- I. E-Verify. The Contractor's employment of unauthorized aliens is a violation of Section 274(e) of the Federal Immigration and Employment Act. The Contractor shall utilize the U.S. Department of Homeland Security E-Verify system to verify the employment eligibility of all new employees hired during the term of this Agreement, and shall require the same verification procedure of all Subcontractors.

8. Insurance and Bonding

If and to the extent required by the Invitation for Bid documents, the Contractor shall furnish insurance coverage for (but not necessarily limited to) workers' compensation, commercial general liability, auto liability, excess liability, and builder's risk. The Contractor shall furnish to the Owner all appropriate policies and Certificate(s) of Insurance. The Contractor shall also post a Payment and Performance Bond for the Contract Sum, within ten (10) days following notification of intent to award, and otherwise in accordance with the Invitation for Bid documents.

9. Independent Contractor

The Contractor acknowledges that it is functioning as an independent contractor in performing under the terms of this Agreement, and it is not acting as an employee of the Owner.

10. Entire Agreement

This Agreement (inclusive of the Contract Documents incorporated herein by reference) represents the full agreement of the parties.

11. Amendments; Waivers; Assignment

- A. Amendments. This Agreement may be amended only pursuant to an instrument in writing that has been jointly executed by authorized representatives of the parties hereto.
- B. Waivers. Neither this Agreement nor any portion of it may be modified or waived orally. However, each party (through its governing body or properly authorized officer) shall have the right, but not the obligation, to waive, on a case-by-case basis, any right or condition herein reserved or intended for the benefit or protection of such party without being deemed or considered to have waived such right or condition for any other case, situation, or circumstance and without being deemed or considered to have waived any other right or condition. No such waiver shall be effective unless made in writing with an express and specific statement of the intent of such governing body or officer to provide such waiver.
- C. Assignment. The rights and obligations of either party to this Agreement may be assigned to a third party only pursuant to a written amendment hereto.

12. Validity

Each of the Owner and Contractor represents and warrants to the other its respective authority to enter into this Agreement.

13. Covenant To Defend

Neither the validity of this Agreement nor the validity of any portion hereof may be challenged by any party hereto, and each party hereto hereby waives any right to initiate any such challenge. Furthermore, if this Agreement or any portion hereof is challenged by a third party in any judicial, administrative, or appellate proceeding (each

party hereby covenanting with the other party not to initiate, encourage, foster, promote, cooperate with, or acquiesce to such challenge), the parties hereto collectively and individually agree, at their individual sole cost and expense, to defend in good faith its validity through a final judicial determination or other resolution, unless all parties mutually agree in writing not to defend such challenge or not to appeal any decision invalidating this Agreement or any portion thereof.

14. Disclaimer of Third-Party Beneficiaries; Successors and Assigns

This Agreement is solely for the benefit of the parties hereto, and no right, privilege, or cause of action shall by reason hereof accrue upon, to, or for the benefit of any third party. Nothing in this Agreement is intended or shall be construed to confer upon or give any person, corporation, partnership, trust, private entity, agency, or other governmental entity any right, privilege, remedy, or claim under or by reason of this Agreement or any provisions or conditions hereof. This Agreement shall be binding upon, and its benefits and advantages shall inure to, the successors and assigns of the parties hereto.

15. Construction

- A. Headings and Captions. The headings and captions of articles, sections, and paragraphs used in this Agreement are for convenience of reference only and are not intended to define or limit their contents, nor are they to affect the construction of or be taken into consideration in interpreting this Agreement.
- B. Legal References. All references to statutory sections or chapters shall be construed to include subsequent amendments to such provisions, and to refer to the successor provision of any such provision. References to “applicable law” and “general law” shall be construed to include provisions of local, state and federal law, whether established by legislative action, administrative rule or regulation, or judicial decision.

16. Severability

The provisions of this Agreement are declared by the parties hereto to be severable. In the event any term or provision of this Agreement shall be held invalid by a court of competent jurisdiction, such invalid term or provision should not affect the validity of any other term or provision hereof; and all such terms and provisions hereof shall be enforceable to the fullest extent permitted by law as if such invalid term or provision had never been part of this Agreement; provided, however, if any term or provision of this Agreement is held to be invalid due to the scope or extent thereof, then, to the extent permitted by law, such term or provision shall be automatically deemed modified in order that it may be enforced to the maximum scope and extent permitted by law.

17. Governing Law; Venue

This Agreement shall be governed by the laws of the State of Florida. Venue for any petition for writ of certiorari or other court action allowed by this Agreement shall be in the Circuit Court of the Twelfth Judicial Circuit in and for Manatee County, Florida.

18. Attorney's Fees and Costs

In any claim dispute procedure or litigation arising from this Agreement, each party hereto shall be solely responsible for paying its attorney's fees and costs.

19. Notices

All notices, comments, consents, objections, approvals, waivers, and elections under this Agreement shall be in writing and shall be given only by hand delivery for which a receipt is obtained, or certified mail, prepaid with confirmation of delivery requested, or by electronic mail with delivery confirmation. All such communications shall be addressed to the applicable addressees set forth below or as any party may otherwise designate in the manner prescribed herein.

To the Owner:

Manatee County,
Attn:
Address
City/State/Zip
Email:

To the Contractor:

Name.
Attn:
Address
City/State/Zip
Email:

Notices, comments, consents, objections, approvals, waivers, and elections shall be deemed given when received by the party for whom such communication is intended at such party's address herein specified, or such other physical address or email address as such party may have substituted by notice to the other.

20. Public Records Law

The Contractor shall comply with the Florida Public Records Act (Chapter 119, Florida Statutes), and shall:

- A. Keep and maintain public records required by the Owner to perform the services called for in this Agreement.
- B. Upon request from the Owner's custodian of public records, provide the Owner with a copy of the requested records or allow the records to be inspected or copied within a reasonable time at a cost that does not exceed the cost provided in Chapter 119, Florida Statutes or as otherwise provided by law.
- C. Ensure that public records that are exempt or confidential and exempt from public records disclosure requirements are not disclosed except as authorized by law for the duration of this Agreement and following completion of this Agreement if the Contractor does not transfer the records to the Owner.

D. Upon completion of this Agreement, transfer, at no cost, to the Owner all public records in possession of the Contractor or keep and maintain such public records. If the Contractor transfers all public records to the Owner upon completion of the Agreement, the Contractor shall destroy any duplicate public records that are exempt or confidential and exempt from public records disclosure requirements. If the Contractor keeps and maintains public records upon completion of the Agreement, the Contractor shall meet all applicable requirements for retaining public records. All records stored electronically must be provided to the Owner, upon request from the Owner's custodian of public records, in a format that is compatible with the information technology systems of the Owner.

IF THE CONTRACTOR HAS QUESTIONS REGARDING THE APPLICATION OF CHAPTER 119, FLORIDA STATUTES, TO THE CONTRACTOR'S DUTY TO PROVIDE PUBLIC RECORDS RELATING TO THIS AGREEMENT, CONTACT THE OWNER'S CUSTODIAN OF PUBLIC RECORDS AT 941-748-4501, EXT. 5845; DEBBIE.SCACCIAOCE@MYMANATEE.ORG; POST OFFICE BOX 1000, BRADENTON, FLORIDA 34206.

21. Exhibits. Exhibits to this Agreement are as follows:

Exhibit A—Title(s) of Drawings

Exhibit B—Title(s) of Specifications

Exhibit C—Affidavit of No Conflict

Exhibit D—Certificate(s) of Insurance

Exhibit E—Payment and Performance Bond

Exhibit F—Standard Forms

1. Application for Payment
2. Certificate of Substantial Completion
3. Final Reconciliation / Warranty / Affidavit
4. Change Order

WHEREFORE, the parties hereto have executed this Agreement as of the date last executed below.

NAME OF CONTRACTOR

By: _____

Printed Name: _____

Title: _____

Date: _____

MANATEE COUNTY, a political subdivision
of the State of Florida

By: _____

Printed Name:

Title:

Date: _____

SAMPLE

GENERAL CONDITIONS
of the
CONSTRUCTION AGREEMENT

SAMPLE

TABLE OF CONTENTS FOR GENERAL CONDITIONS

| | <u>Page</u> |
|--|-------------|
| Article I -- Definitions..... | GC-1 |
| 1.1 Definitions..... | GC-1 |
| A. Acceptance | GC-1 |
| B. Application for Payment..... | GC-1 |
| C. Architect/Engineer | GC-1 |
| D. Change Order | GC-1 |
| E. Construction Services..... | GC-1 |
| F. Construction Team | GC-1 |
| G. Contract Sum..... | GC-1 |
| H. Contract Time..... | GC-1 |
| I. Contractor's Personnel..... | GC-1 |
| J. Days | GC-1 |
| K. Defective..... | GC-2 |
| L. Field Directive..... | GC-2 |
| M. Final Completion Date..... | GC-2 |
| N. Float Time | GC-2 |
| O. Force Majeure | GC-2 |
| P. Notice to Proceed..... | GC-2 |
| Q. Owner | GC-2 |
| R. Owner's Project Representative..... | GC-2 |
| S. Payment and Performance Bond..... | GC-2 |
| T. Permitting Authority..... | GC-2 |
| U. Procurement Ordinance | GC-2 |
| V. Progress Report..... | GC-2 |
| W. Project | GC-2 |
| X. Project Costs | GC-3 |
| Y. Project Manager..... | GC-3 |
| Z. Project Plans and Specifications..... | GC-3 |
| AA Project Schedule | GC-3 |
| BB. Project Site..... | GC-3 |
| CC. Subcontractor | GC-3 |
| DD. Substantial Completion and Substantially Complete..... | GC-3 |
| EE. Substantial Completion Date | GC-3 |
| FF. Substitute..... | GC-3 |
| GG. Unit Price Work..... | GC-4 |
| HH. Work..... | GC-4 |
| II. Work Directive Change..... | GC-4 |
| Article II -- Relationship and Responsibilities | GC-4 |
| 2.1 Relationship between Contractor and Owner | GC-4 |
| A. Purpose..... | GC-4 |
| B. Construction Team | GC-4 |
| C. Owner's Reliance on Bid (or GMP)..... | GC-4 |

| | | |
|-----|--|--------------|
| 2.2 | General Contractor Responsibilities | GC-5 |
| | A. Personnel..... | GC-5 |
| | B. Cooperation with Architect/Engineer..... | GC-5 |
| | C. Timely Performance | GC-5 |
| | D. Duty to Defend Work..... | GC-5 |
| | E. Trade and Industry Terminology..... | GC-5 |
| 2.3 | Project Schedule..... | GC-6 |
| 2.4 | Construction Services | GC-7 |
| | A. Construction of Project | GC-7 |
| | B. Notice to Proceed | GC-7 |
| | C. Quality of Work | GC-7 |
| | D. Materials | GC-7 |
| | E. Accountability for Work..... | GC-7 |
| | F. Contract Sum..... | GC-8 |
| | G. Governing Specifications | GC-8 |
| | H. Adherence to Project Schedule | GC-8 |
| | I. Superintendent..... | GC-8 |
| | J. Work Hours | GC-8 |
| | K. Overtime-Related Costs..... | GC-8 |
| | L. Insurance, Overhead and Utilities | GC-9 |
| | M. Cleanliness..... | GC-9 |
| | N. Loading..... | GC-9 |
| | O. Safety and Protection | GC-9 |
| | P. Emergencies | GC-10 |
| | Q. Substitutes | GC-10 |
| | R. Surveys and Stakes | GC-10 |
| | S. Suitability of Project Site | GC-11 |
| | T. Project Specification Errors | GC-11 |
| | U. Remediation of Contamination | GC-11 |
| | V. Interfacing | GC-12 |
| | W. Job Site Facilities | GC-13 |
| | X. Weather Protection..... | GC-13 |
| | Y. Performance and Payment Bond | GC-13 |
| | Z. Construction Phase; Building Permit; Code Inspections | GC-13 |
| | (1) Building Permit | GC-13 |
| | (2) Code Inspections | GC-14 |
| | (3) Contractor's Personnel | GC-14 |
| | (4) Lines of Authority | GC-14 |
| | AA. Quality Control | GC-14 |
| | BB. Management of Subcontractors | GC-15 |
| | CC. Job Requirements | GC-15 |
| | DD. As-Built Drawings..... | GC-17 |
| | EE. Progress Reports..... | GC-17 |
| | FF. Contractor's Warranty..... | GC-17 |
| | GG. Apprentices..... | GC-18 |
| | HH. Schedule of Values | GC-18 |
| | II. Other Contracts..... | GC-18 |
| | Article III -- Compensation..... | GC-18 |
| 3.1 | Compensation | GC-18 |

| | |
|---|--------------|
| A. <i>Adjustments</i> | GC-18 |
| B. <i>Valuation</i> | GC-18 |
| C. <i>Unit Price Work</i> | GC-19 |
| 3.2 <i>Schedule of Compensation</i> | GC-19 |
| A. <i>Periodic Payments for Services</i> | GC-19 |
| B. <i>Payment for Materials and Equipment</i> | GC-19 |
| C. <i>Credit toward Contract Sum</i> | GC-19 |
| 3.3 <i>Invoice and Payment</i> | GC-20 |
| A. <i>Invoices</i> | GC-20 |
| B. <i>Additional Information; Processing of Invoices</i> | GC-20 |
| C. <i>Architect/Engineer's Approval</i> | GC-20 |
| D. <i>Warrants of Contractor with Respect to Payments</i> | GC-20 |
| E. <i>All Compensation Included</i> | GC-20 |
| Article IV -- Subcontractors | GC-21 |
| 4.1 <i>Subcontracts</i> | GC-21 |
| A. <i>Subcontracts Generally</i> | GC-21 |
| B. <i>No Damages for Delay</i> | GC-21 |
| C. <i>Subcontractual Relations</i> | GC-21 |
| D. <i>Insurance; Acts & Omissions</i> | GC-22 |
| 4.2 <i>Relationship and Responsibilities</i> | GC-22 |
| 4.3 <i>Payments to Subcontractors; Monthly Statements</i> | GC-22 |
| A. <i>Payment</i> | GC-22 |
| B. <i>Final Payment of Subcontractors</i> | GC-22 |
| 4.4 <i>Responsibility for Subcontractors</i> | GC-22 |
| 4.5 <i>Contingent Assignment of Subcontracts</i> | GC-23 |
| Article V -- Changes in Work | GC-23 |
| 5.1 <i>General</i> | GC-23 |
| 5.2 <i>Minor Changes in the Work</i> | GC-23 |
| 5.3 <i>Emergencies</i> | GC-24 |
| 5.4 <i>Concealed Conditions</i> | GC-24 |
| 5.5 <i>Hazardous Materials</i> | GC-24 |
| 5.6 <i>Change Orders; Adjustments to Contract Sum</i> | GC-25 |
| A. <i>Change Orders Generally</i> | GC-25 |
| 5.7 <i>Owner-Initiated Changes</i> | GC-25 |
| 5.8 <i>Unauthorized Work</i> | GC-25 |
| 5.9 <i>Defective Work</i> | GC-25 |
| 5.10 <i>Estimates for Changes</i> | GC-26 |
| 5.11 <i>Form of Proposed Changes</i> | GC-26 |
| 5.12 <i>Changes to Contract Time</i> | GC-26 |
| Article VI -- Role of Architect/Engineer | GC-26 |
| 6.1 <i>General</i> | GC-26 |
| A. <i>Retaining</i> | GC-26 |
| B. <i>Duties</i> | GC-26 |
| C. <i>Termination</i> | GC-26 |
| 6.2 <i>Administration</i> | GC-27 |

| | |
|---|--------------|
| A. <i>Site Visits</i> | GC-27 |
| B. <i>Reporting</i> | GC-27 |
| 6.3 Interpretation of Project Plans and Specifications | GC-27 |
| 6.4 Rejection of Non-Conforming Work | GC-27 |
| 6.5 Correction of Work | GC-27 |
| 6.6 Timely Performance of Architect/Engineer | GC-28 |
| Article VII -- Owner's Rights and Responsibilities | GC-28 |
| 7.1 Project Site; Title | GC-28 |
| 7.2 Project Plans and Specifications; Architect/Engineer | GC-28 |
| 7.3 Surveys; Soil Tests and Other Project Site Information | GC-28 |
| 7.4 Information; Communication; Coordination..... | GC-29 |
| 7.5 Governmental Body | GC-29 |
| 7.6 Pre-Completion Acceptance | GC-29 |
| 7.7 Ownership and Use of Drawings, Specifications and Other Instruments of Service..... | GC-29 |
| 7.8 Owner's Project Representative..... | GC-30 |
| A. <i>Responsibilities</i> | GC-30 |
| B. <i>Limitations</i> | GC-31 |
| Article VIII -- Resolution of Disagreements; Claims for Compensation | GC-31 |
| 8.1 Owner to Decide Disputes | GC-31 |
| 8.2 Finality | GC-31 |
| 8.3 No Damages for Delay..... | GC-31 |
| 8.4 Permitted Claims Procedure..... | GC-32 |
| 8.5 Contract Claims and Disputes..... | GC-32 |
| 8.6 Claims for Consequential Damages..... | GC-33 |
| Article IX -- Indemnity | GC-33 |
| 9.1 Indemnity | GC-33 |
| A. <i>Indemnification Generally</i> | GC-33 |
| B. <i>Indemnification; Enforcement Actions</i> | GC-33 |
| C. <i>Claims by Employees</i> | GC-33 |
| 9.2 Duty to Defend..... | GC-33 |
| Article X-- Accounting Records; Ownership of Documents | GC-33 |
| 10.1 Accounting Records..... | GC-34 |
| 10.2 Inspection and Audit | GC-34 |
| 10.3 Access | GC-34 |
| 10.4 Ownership of Documents..... | GC-34 |
| Article XI -- Public Contract Laws | GC-35 |
| 11.1 Equal Opportunity Employment | GC-35 |
| A. <i>Employment</i> | GC-35 |
| B. <i>Participation</i> | GC-35 |
| 11.2 Immigration Reform and Control Act of 1986 | GC-35 |
| 11.3 No Conflict of Interest | GC-35 |

| | |
|--|--------------|
| A. <i>No Interest in Business Activity</i> | GC-35 |
| B. <i>No Appearance of Conflict</i> | GC-36 |
| 11.4 Truth in Negotiations | GC-36 |
| 11.5 Public Entity Crimes | GC-36 |
| Article XII-- Force Majeure, Fire or Other Casualty | GC-36 |
| 12.1 Force Majeure | GC-36 |
| A. <i>Unavoidable Delays</i> | GC-36 |
| B. <i>Concurrent Contractor Delays</i> | GC-36 |
| C. <i>Notice; Mitigation</i> | GC-36 |
| 12.2 Casualty; Actions by Owner and Contractor | GC-37 |
| 12.3 Approval of Plans and Specifications | GC-37 |
| 12.4 Notice of Loss or Damage | GC-37 |
| Article XIII -- Representations, Warranties and Covenants | GC-38 |
| 13.1 Representations and Warranties of Contractor | GC-38 |
| 13.2 Representations of the Owner | GC-40 |
| Article XIV -- Termination and Suspension | GC-41 |
| 14.1 Termination for Cause by Owner..... | GC-41 |
| A. <i>Nonperformance</i> | GC-41 |
| B. <i>Insolvency</i> | GC-42 |
| C. <i>Illegality</i> | GC-42 |
| D. <i>Rights of Owner</i> | GC-42 |
| 14.2 Termination without Cause by Owner | GC-42 |
| A. <i>Release of Contractor</i> | GC-43 |
| B. <i>Waiver of Protest</i> | GC-43 |
| 14.3 Suspension without Cause | GC-43 |
| 14.4 Termination Based Upon Abandonment, Casualty or Force Majeure | GC-43 |
| 14.5 Vacation of Project Site; Delivery of Documents..... | GC-43 |
| 14.6 Termination by the Contractor..... | GC-44 |

GENERAL CONDITIONS
ARTICLE I
DEFINITIONS

1.1 Definitions. For purposes of the Contract Documents, the following terms shall have the following meanings.

A. Acceptance: The acceptance of the Project into the Owner's operating public infrastructure.

B. Application for Payment: The form approved and accepted by the Owner, which is to be used by Contractor in requesting progress payments or final payment and which is to include such supporting documentation as is required by the Contract Documents.

C. Architect/Engineer: _____, a _____ corporation or limited liability company, registered and licensed to do business in the State of Florida, OR _____, an employee of Owner.

D. Change Order: A written order signed by the Owner, the Architect/Engineer and the Contractor authorizing a change in the Project Plans and/or Specifications and, if necessary, a corresponding adjustment in the Contract Sum and/or Contract Time, pursuant to Article V.

E. Construction Services: The Construction Services to be provided by Contractor pursuant to Section 2.4, in accordance with the terms and provisions of the Contract Documents.

F. Construction Team: The working team established pursuant to Section 2.1.B.

G. Contract Sum: The total compensation to be paid to the Contractor for Construction Services rendered pursuant to the Contract Documents, as set forth in Contractor's Bid (or Guaranteed Maximum Price Addendum), unless adjusted in accordance with the terms of the Contract Documents

H. Contract Time: The time period during which all Construction Services are to be completed pursuant to the Contract Documents, to be set forth in the Project Schedule.

I. Contractor's Personnel: The Contractor's key personnel designated by Contractor.

J. Days: Calendar days except when specified differently. When time is referred to in the Contract Documents by days, it will be computed to exclude the first and include the last day of such period. If the last day of any such period falls on a Saturday or Sunday or legal holiday, such day will be omitted from the computation.

K. Defective: When modifying the term “Work”, referring to Work that is unsatisfactory, faulty or deficient, or does not conform to the Contract Documents, or that does not meet the requirements of any inspection, reference standard, test or approval referred to in the Contract Documents, or that has been damaged prior to Owner’s approval of final payment (unless responsibility for the protection thereof has been assumed by Owner).

L. Field Directive: A written order issued by Owner which orders minor changes in the Work not involving a change in Contract Time, to be paid from the Owner’s contingency funds.

M. Final Completion Date: The date upon which the Project is fully constructed and all Work required on the Project and Project Site is fully performed as verified in writing by the Owner.

N. Float Time: The time available in the Project Schedule during which an unexpected activity can be completed without delaying Substantial Completion of the Work.

O. Force Majeure: Those conditions constituting excuse from performance as described in and subject to the conditions described in Article XII.

P. Notice to Proceed: Written notice by Owner (after execution of Contract) to Contractor fixing the date on which the Contract Time will commence to run and on which Contractor shall start to perform the Work.

Q. Owner: Manatee County, a political subdivision of the State of Florida.

R. Owner’s Project Representative: The individual designated by Owner to perform those functions set forth in Section 7.8.

S. Payment and Performance Bond: The Payment and Performance Bond security posted pursuant to Section 2.4.Y to guarantee payment and performance by the Contractor of its obligations hereunder.

T. Permitting Authority: Any applicable governmental authority acting in its governmental and regulatory capacity which is required to issue or grant any permit, certificate, license or other approval which is required as a condition precedent to the commencement or approved of the Work, or any part thereof, including the building permit.

U. Procurement Ordinance: The Manatee County Procurement Code, Chapter 2-26 of the Manatee County Code of Laws, as amended from time to time.

V. Progress Report: A report to Owner that includes all information required pursuant to the Contract Documents and submitted in accordance with Section 2.4.EE, hereof.

W. Project: The total construction of which the Work performed under the Contract Documents may be the whole or a part and which may include construction by Owner and by separate contractors. For the purposes of the Contract Documents, the term Project shall

include all areas of proposed improvements and all areas which may reasonably be judged to have an impact on the Project.

X. Project Costs: The costs incurred by the Contractor to plan, construct and equip the Project and included within, and paid as a component of, the Contract Sum.

Y. Project Manager: Subject to the prior written consent of Owner, the individual designated to receive notices on behalf of the Contractor, or such other individual designated by the Contractor, from time to time, pursuant to written notice in accordance with the Contract Documents.

Z. Project Plans and Specifications: The one hundred percent (100%) construction drawings and specifications prepared by the Architect/Engineer, and any changes, supplements, amendments or additions thereto approved by the Owner, which shall also include any construction drawings and final specifications required for the repair or construction of the Project, as provided herein.

AA. Project Schedule: The schedule and sequence of events for the commencement, progression and completion of the Project, developed pursuant to Section 2.3., as such schedule may be amended as provided herein.

BB. Project Site: The site depicted in the Project Plans and Specifications, inclusive of all rights of way, temporary construction easements or licensed or leased sovereign lands.

CC. Subcontractor: Any individual (other than a direct employee of the Contractor) or organization retained by Contractor to plan, construct or equip the Project pursuant to Article IV.

DD. Substantial Completion and Substantially Complete: The stage in the progress of the Work when the Work or designated portion thereof is sufficiently complete in accordance with the Contract Documents so that the Owner can occupy or utilize the Work for its intended use; provided, however, that as a condition precedent to Substantial Completion, the Owner has received all certificates of occupancy or completion and other permits, approvals, licenses, and other documents from any governmental authority which are necessary for the beneficial occupancy of the Project or any designated portion thereof.

EE. Substantial Completion Date: The date on which the Project or designated portion thereof is deemed to be Substantially Complete, as evidenced by receipt of (i) the Architect/Engineer's certificate of Substantial Completion, (ii) written Acceptance of the Project by the Owner, and (iii) approvals of any other authority as may be necessary or otherwise required.

FF. Substitute: Materials or equipment offered by the Contractor as an alternative to that set forth in the Project Plans and Specifications, where (i) the Project Plans and Specifications do not authorize an "approved equal", or (ii) the Owner, in its reasonable discretion, determines that a pre-authorized "approved equal" will result in a substantial change to the Work because of cost, quality or other difference in comparison to the materials or equipment specified.

GG. Unit Price Work: Work to be paid for on the basis of unit prices.

HH. Work: The term “Work” means the construction and services required by the Contract Documents, whether completed or partially completed, and includes all labor, materials, equipment and services provided or to be provided by the Contractor to fulfill the Contractor’s obligations. The Work may constitute the whole or a part of the Project.

II. Work Directive Change: A written directive to Contractor, issued on or after the effective date of the Agreement pursuant to Section 5.8 and signed by Owner’s Project Representative, ordering an addition, deletion or revision in the Work, or responding to differing or unforeseen physical conditions under which the Work is to be performed or responding to emergencies.

ARTICLE II RELATIONSHIP AND RESPONSIBILITIES

2.1 Relationship between Contractor and Owner. The Contractor accepts the relationship of trust and confidence established with Owner pursuant to the Contract Documents. The Contractor shall furnish its best skill and judgment and cooperate with Owner and Owner’s Project Representative in furthering the interests of the Owner. The Contractor agrees to provide the professional services required to complete the Project consistent with the Owner’s direction and the terms of the Contract Documents. All services provided hereunder by Contractor, either directly or through Subcontractors, shall be provided in accordance with sound construction practices and applicable professional construction standards.

A. Purpose. The purpose of the Contract Documents is to provide for the provision of construction services for the Project on the Project Site by the Contractor, and construction of the Project by the Contractor in accordance with the Project Plans and Specifications. The further purpose of the Contract Documents is to define and delineate the responsibilities and obligations of the parties to the Contract Documents and to express the desire of all such parties to cooperate to accomplish the purposes and expectations of the Contract Documents.

B. Construction Team. The Contractor, Owner and Architect/Engineer shall be called the “Construction Team” and shall work together as a team commencing upon full execution of the Contract Documents through Substantial Completion. As provided in Section 2.2, the Contractor and Architect/Engineer shall work jointly through completion and shall be available thereafter should additional services be required. The Contractor shall provide leadership to the Construction Team on all matters relating to construction. The Contractor understands, acknowledges and agrees that the Architect/Engineer shall provide leadership to the Construction Team on all matters relating to design.

C. Owner’s Reliance on Bid (or Guaranteed Maximum Price Addendum). The Contractor acknowledges that the representations, statements, information and pricing contained in its Bid (or Guaranteed Maximum Price Addendum) have been relied upon by the Owner and have resulted in the award of this Project to the Contractor.

2.2 General Contractor Responsibilities. In addition to the other responsibilities set forth herein, the Contractor shall have the following responsibilities pursuant to the Contract Documents:

A. Personnel. The Contractor represents that it has secured, or shall secure, all personnel necessary to perform the Work, none of whom shall be employees of the Owner. Primary liaison between the Contractor and the Owner shall be through the Owner's Project Representative and Contractor's Project Manager. All of the services required herein shall be performed by the Contractor or under the Contractor's supervision, and all personnel engaged in the Work shall be fully qualified and shall be authorized or permitted under law to perform such services.

B. Cooperation with Architect/Engineer. The Contractor's services shall be provided in conjunction with the services of the Architect/Engineer. In the performance of professional services, the Contractor acknowledges that time is critical for Project delivery. The Contractor acknowledges that timely construction utilizing the services of an Architect/Engineer and a Contractor requires maximum cooperation between all parties.

C. Timely Performance. The Contractor shall perform all services as expeditiously as is consistent with professional skill and care and the orderly progress of the Work, in accordance with the Project Schedule. Verification of estimated Project Schedule goals will be made as requested by the Owner.

D. Duty to Defend Work. In the event of any dispute between the Owner and any Permitting Authority that relates to the quality, completeness or professional workmanship of the Contractor's services or Work, the Contractor shall, at its sole cost and expense, cooperate with the Owner to defend the quality and workmanship of the Contractor's services and Work.

E. Trade and Industry Terminology. It is the intent of the Contract Documents to describe a functionally complete Project (or part thereof) to be constructed in accordance with the Contract Documents. Any Work, materials or equipment that may reasonably be inferred from the Contract Documents as being required to produce the intended result will be supplied whether or not specifically called for. When words which have a well-known technical or trade meaning are used to describe Work, materials, or equipment, such words shall be interpreted in accordance with that meaning. Reference to standard specifications, manuals or codes of any technical society, organization or association, or to the laws or regulations of any governmental authority, whether such reference be specific or by implication, shall mean the latest standard specification, manual, code or laws or regulations in effect at the time of opening of Bids (or at the time of execution of the Guaranteed Maximum Price Addendum), except as may be otherwise specifically stated. However, no provision of any referenced standard specification, manual or code (whether or not specifically incorporated by reference in the Contract Documents) shall be effective to change the duties and responsibilities of Owner or Contractor, or any of their agents or employees from those set forth in the Contract Documents. Computed dimensions shall govern over scaled dimensions.

2.3 Project Schedule. The Contractor, within ten (10) days after being awarded the Agreement, shall prepare and submit for the Owner's and Architect/Engineer's information a Contractor's construction schedule for the Work. The schedule shall not exceed time limits current under the Contract Documents, shall be revised at appropriate intervals as required by the conditions of the Work and Project, shall be related to the entire Project to the

extent required by the Contract Documents, and shall provide for expeditious and practicable execution of Work.

- A. The Project Schedule shall show a breakdown of all tasks to be performed, and their relationship in achieving the completion of each phase of Work, subject to review of Owner and Architect/Engineer and approval or rejection by Owner. The Project Schedule shall show, at a minimum, the approximate dates on which each segment of the Work is expected to be started and finished, the proposed traffic flows during each month, the anticipated earnings by the Contractor for each month and the approximate number of crews and equipment to be used. The Project Schedule shall include all phases of procurement, approval of shop drawings, proposed Change Orders in progress, schedules for Change Orders, and performance testing requirements. The Project Schedule shall include a construction commencement date and Project Substantial Completion Date, which dates shall accommodate known or reasonably anticipated geographic, atmospheric and weather conditions.
- B. The Project Schedule shall serve as the framework for the subsequent development of all detailed schedules. The Project Schedule shall be used to verify Contractor performance and to allow the Owner's Project Representative to monitor the Contractor's efforts.
- C. The Project Schedule may be adjusted by the Contractor pursuant to Article V. The Owner shall have the right to reschedule Work provided such rescheduling is in accord with the remainder of terms of the Contract Documents.
- D. The Contractor shall prepare a submittal schedule, promptly after being awarded the Agreement and thereafter as necessary to maintain a current submittal schedule, and shall submit the schedule(s) for the Architect/Engineer's approval. The Architect/Engineer's approval shall not be unreasonably delayed or withheld. The submittal schedule shall (1) be coordinated with the Contractor's construction schedule, and (2) allow the Architect/Engineer reasonable time to review submittals. If the Contractor fails to submit a submittal schedule, the Contractor shall not be entitled to any increase in Contract Sum or extension of Contract Time based on the time required for review of submittals.
- E. The Contractor shall perform the Work in general accordance with the most recent schedules submitted to the Owner and Architect/Engineer.

2.4 Construction Services. The Contractor shall provide the following Construction Services:

- A. Construction of Project. The Contractor shall work from the receipt of a Notice to Proceed through the Substantial Completion of the Project in accordance with the terms of the Contract Documents to manage the construction of the Project. The Construction Services provided by the Contractor to construct the Project shall include without limitation (1) all services

necessary and commensurate with established construction standards, and (2) all services described in the Invitation for Bid (or Request for Proposal) and the Bid (or Guaranteed Maximum Price Addendum).

B. Notice to Proceed. A Notice to Proceed may be given at any time within thirty (30) days after the effective date of the Agreement. Contractor shall start to perform the Work on the date specified in the Notice to Proceed, but no Work shall be done at the site prior to the issuance of the Notice to Proceed.

C. Quality of Work. If at any time the labor used or to be used appears to the Owner as insufficient or improper for securing the quality of Work required or the required rate of progress, the Owner may order the Contractor to increase its efficiency or to improve the character of its Work, and the Contractor shall conform to such an order. Any such order shall not entitle Contractor to any additional compensation or any increase in Contract Time. The failure of the Owner to demand any increase of such efficiency or any improvement shall not release the Contractor from its obligation to secure the quality of Work or the rate of progress necessary to complete the Work within the limits imposed by the Contract Documents. The Owner may require the Contractor to remove such personnel as the Owner deems incompetent, careless, insubordinate or otherwise objectionable, or whose continued employment on the Project is deemed to be contrary to the Owner's interest. The Contractor shall provide good quality workmanship and shall promptly correct construction defects without additional compensation. Acceptance of the Work by the Owner shall not relieve the Contractor of the responsibility for subsequent correction of any construction defects.

D. Materials. All materials and equipment shall be of good quality and new, except as otherwise provided in the Contract Documents. If required by Architect/Engineer, Contractor shall furnish satisfactory evidence (including reports of required tests) as to the kind and quality of materials and equipment. All materials and equipment shall be applied, installed, connected, erected, used, cleaned and conditioned in accordance with the instruction of the applicable supplier except as otherwise provided in the Contract Documents.

E. Accountability for Work. The Contractor shall be solely accountable for its Work, including plans review and complete submittals. The Contractor shall be solely responsible for means, methods, techniques, sequences and procedures of construction. If a specific means, method, technique, sequence or procedure of construction is required by the Contract Documents, the Contractor may utilize an alternative means, method, technique, sequence or procedure acceptable to the Architect/Engineer if the Contractor submits sufficient information to allow the Architect/Engineer to determine that the alternative is equivalent to that required by the Contract Documents.

F. Contract Sum. The Contractor shall construct the Project so that the Project can be built for a cost not to exceed the Contract Sum.

G. Governing Specifications. In the absence of specified Owner design standards or guidelines, the Architect/Engineer shall use, and the Contractor shall comply with, the most recent version of the applicable FDOT or AASHTO design standards. In general, the Project shall be constructed by the Contractor in accordance with applicable industry standards. The Contractor shall be responsible for utilizing and maintaining current knowledge of any laws,

ordinances, codes, rules, regulations, standards, guidelines, special conditions, specifications or other mandates relevant to the Project or the services to be performed.

H. Adherence to Project Schedule. The development and equipping of the Project shall be undertaken and completed in accordance with the Project Schedule, and within the Contract Time described therein.

I. Superintendent. The Contractor shall employ a competent superintendent and necessary assistants who shall be in attendance at the Project Site during performance of the Work. The superintendent shall represent the Contractor, and communications given to the superintendent shall be as binding as if given to the Contractor.

(1) The Contractor, as soon as practicable after award of the Agreement, shall furnish in writing to the Owner through the Architect/Engineer the name and qualifications of the proposed superintendent. The Architect/Engineer may reply within 14 days to the Contractor in writing stating (1) whether the Owner or the Architect/Engineer has reasonable objection to the proposed superintendent or (2) that the Architect/Engineer requires additional time to review. Failure of the Architect/Engineer to reply within 14 days shall constitute notice of no reasonable objection.

(2) The Contractor shall not employ a proposed superintendent to whom the Owner or Architect/Engineer has made reasonable and timely objection. The Contractor shall not change the superintendent without the Owner's consent, which shall not be unreasonably withheld or delayed.

J. Work Hours. Contractor shall provide competent, suitable qualified personnel to survey and lay out the Work and perform construction as required by the Contract Documents. Contractor shall at all times maintain good discipline and order at the site. Except in connection with the safety or protection of persons or the Work or property at the site or adjacent thereto and except as otherwise indicated in the Contract Documents, all Work at the site shall be performed during regular working hours, and Contractor shall not permit overtime work or the performance of Work on a Saturday, Sunday or legal holiday without Owner's written consent given after prior notice to Architect/Engineer (at least seventy-two (72) hours in advance).

K. Overtime-Related Costs. Contractor shall pay for all additional Architect/Engineer charges, inspection costs and Owner staff time for any overtime work which may be authorized. Such additional charges shall be an obligation of Contractor and no extra payment shall be made by Owner because such overtime work. At Owner's option, such overtime costs may be deducted from Contractor's monthly payment request or Contractor's retainage prior to release of final payment. Contractor's obligation to pay all overtime-related costs shall not apply if Contractor is directed by Owner to work overtime solely for Owner's convenience.

L. Insurance, Overhead and Utilities. Unless otherwise specified, Contractor shall furnish and assume full responsibility for all bonds, insurance, materials, equipment, labor, transportation, construction equipment and machinery, tools, appliances, fuel, power, light, heat, telephone, water, sanitary facilities, temporary facilities and all other facilities and incidentals necessary for the furnishing, performance, testing, start-up and completion of the Work.

M. Cleanliness. The Contractor shall keep the premises and surrounding area free from accumulation of waste materials or rubbish caused by operations under the Contract. At completion of the Work, the Contractor shall remove waste materials, rubbish, the Contractor's tools, construction equipment, machinery and surplus materials from and about the Project Site. Contractor shall restore to original conditions all property not designated for alteration by the Contract Documents. If the Contractor fails to clean up as provided in the Contract Documents, the Owner may do so and Owner shall be entitled to reimbursement from Contractor.

N. Loading. Contractor shall not load nor permit any part of any structure to be loaded in any manner that will endanger the structure, nor shall Contractor subject any part of the Work or adjacent property to stresses or pressures that will endanger it.

O. Safety and Protection. Contractor shall comply with all applicable federal, state and local safety regulations. Contractor shall be responsible for initiating, maintaining and supervising all safety precautions and programs in connection with the Work. Contractor shall take all necessary precautions for the safety of and shall provide the necessary protection to prevent damage, injury or loss to:

- (1) All employees on the Work and other persons and organizations who may be affected thereby;
- (2) All the Work and materials and equipment to be incorporated therein, whether in storage on or off the Project Site; and
- (3) Other property at the Project Site or adjacent thereto, including trees, shrubs, lawns, walks, pavements, roadways, structures, utilities and underground facilities not designated for removal, relocation or replacement during construction.

Contractor shall comply with all applicable laws and regulations of any public body having jurisdiction for the safety of persons or property or to protect them from damage, injury or loss, and shall erect and maintain all necessary safeguards for such safety and protection. Contractor shall provide and maintain all passageways, guard fences, lights and other facilities for the protection required by public authority or local conditions. Contractor shall provide reasonable maintenance of traffic for the public and preservation of the Owner's business, taking into full consideration all local conditions. Contractor's duties and responsibilities for safety and protection with regard to the Work shall continue until such time as all the Work is completed.

P. Emergencies. In emergencies affecting the safety or protection of persons or the Work or property at the Project Site or adjacent thereto, Contractor, without special instruction or authorization from Architect/Engineer or Owner, shall act to prevent threatened damage, injury or loss. Contractor shall give Owner prompt written notice if Contractor believes that any significant changes in the Work or variations from the Contract Documents have been caused thereby. If Owner determines that a change in the Project is required because of the action taken in response to an emergency, a Work Directive Change or Change Order will be issued to document the consequences of the changes or variation.

Q. Substitutes. For Substitutes not included with the Bid (or Guaranteed Maximum Price Addendum), but submitted after the effective date of the Agreement (or

Guaranteed Maximum Price Addendum), Contractor shall make written application to Architect/Engineer for acceptance thereof, certifying that the proposed Substitute will perform adequately the functions and achieve the results called for by the general design, be similar and of equal substance to that specified and be suited to the same use as that specified. The application will also contain an itemized estimate of all costs and delays or schedule impacts that will result directly or indirectly from review, acceptance and provision of such Substitute, including costs of redesign and claims of other contractors affected by the resulting change, all of which will be considered by the Architect/Engineer in evaluating the proposed Substitute. Architect/Engineer may require Contractor to furnish at Contractor's expense, additional data about the proposed Substitute. In rendering a decision, Owner, Architect/Engineer and Contractor shall have access to any available Float Time in the Project Schedule. If Substitute materials or equipment not included as part of the Bid (or Guaranteed Maximum Price Addendum), but proposed after the effective date of the Agreement, are accepted and are less costly than the originally specified materials or equipment, then the net difference in cost shall be credited to the Owner and an appropriate Change Order executed to adjust the Contract Sum.

- (1) Architect/Engineer will be allowed a reasonable time within which to evaluate each proposed Substitute. Architect/Engineer will be the sole judge of acceptability and no Substitute will be ordered, installed or utilized without Architect/Engineer's prior written acceptance which will be evidenced by either a Change Order or an approved shop drawing. Owner may require Contractor to furnish at Contractor's expense a special performance guarantee or other surety with respect to any Substitute.
- (2) Contractor shall reimburse Owner for the charges of Architect/Engineer and Architect/Engineer's Consultants for evaluating each proposed Substitute submitted after the effective date of the Agreement and all costs resulting from any delays in the Work while the Substitute was undergoing review.

R. Surveys and Stakes. The Contractor shall furnish, as part of the Contract Sum, all labor, stakes, surveys, batter boards for structures, grade lines and other materials and supplies and shall set construction stakes and batter boards for establishing lines, position of structures, slopes and other controlling points necessary for the proper prosecution of the Work. Where rights-of-way, easements, property lines or any other conditions which make the lay-out of the Project or parts of the Project critical are involved, the Contractor shall employ a competent surveyor who is registered in the State of Florida for lay-out and staking. These stakes and marks shall constitute the field control by and in accord with which the Contractor shall govern and execute the Work. The Contractor shall be held responsible for the preservation of all stakes and marks and if for any reason any of the stakes or marks or batter boards become destroyed or disturbed, they shall be immediately and accurately replaced by the Contractor.

S. Suitability of Project Site. The Contractor has, by careful examination, satisfied itself as to the nature and location of the Work and all other matters which can in any way affect the Work, including, but not limited to details pertaining to borings, as shown on the drawings. Such boring information is not guaranteed to be more than a general indication of the materials likely to be found adjacent to holes bored at the Project Site, approximately at the locations indicated. The Contractor has examined boring data, where available, made its own interpretation of the subsurface conditions and other preliminary data, and has based its Bid (or Guaranteed Maximum Price Addendum) on its own opinion of the conditions likely to be

encountered. Except as specifically provided in Sections 2.4.U., 5.4 and 5.5, no extra compensation or extension of time will be considered for any Project Site conditions that existed at the time of bidding (or at the time of execution of the Guaranteed Maximum Price Addendum). No verbal agreement or conversation with any officer, agent or employee of the Owner, before or after the execution of the Agreement, shall affect or modify any of the terms or obligations herein contained.

T. Project Specification Errors. If the Contractor, during the Work, finds that the drawings, specifications or other Contract Documents cannot be followed, the Contractor shall immediately inform the Owner in writing, and the Owner shall promptly check the accuracy of the information. Any Work done after such discovery, until any necessary changes are authorized, will be done at the Contractor's sole risk of non-payment and delay.

U. Remediation of Contamination. Owner and Contractor recognize that remediation of subsurface conditions may be necessary due to potential hazardous materials contamination. Because the presence or extent of any contamination is not known, Contractor shall include no cost in the Contract Sum, and no time in the Project Schedule, for cost or delays that might result from any necessary remediation. The Project Schedule will provide a period of time between demolition activities and the start of the next activity to commence any remediation if needed. Contractor shall use all reasonable efforts in scheduling the Project to minimize the likelihood that remediation delays construction. Any hazardous materials remediation Work which Contractor agrees to perform shall be done pursuant to a Change Order or amendment consistent with the following:

- (1) The dates of Substantial Completion shall be equitably adjusted based on delays, if any, incurred in connection with remediation efforts.
- (2) Contractor, and any Subcontractors which have mobilized on the Project Site, shall be paid for demonstrated costs of overhead operations at the Project Site during any period of delay of more than seven (7) days, except to the extent that Work proceeds concurrently with remediation. The categories of costs to be reimbursed are limited to those reasonably incurred at the jobsite during the delay period (such as trailers or offices, telephones, faxes, and the like); equipment dedicated to the Project and located at the Project Site; salaries and associated costs of personnel dedicated to the Project to the extent that they do not perform work on other projects; and other jobsite costs that are reasonable and which are incurred during the delay period. Subcontractors and suppliers which have not mobilized are limited to the costs set forth in Section 2.4.U(3).
- (3) Contractor and any Subcontractor or supplier on the Project who is eligible for compensation shall be paid any demonstrated costs of escalation in materials or labor, and reasonable costs of off-site storage of materials identified to the Project, arising because of any delay of more than seven (7) days. Such Contractor, Subcontractors and suppliers are obligated to take all reasonable steps to mitigate escalation costs, such as through early purchase of materials.

- (4) Contractor, for itself and all Subcontractors and suppliers on the Project, hereby agrees that the extension of time for delays under Section 2.4.U(1), and payment of the costs identified in Sections 2.4.U(2) and/or Section 2.4.U(3), are the sole remedies for costs and delays described in this Section, and waives all claims and demands for extended home office overhead (including, but not limited to, "Eichleay" claims), lost profit or lost opportunities, and any special, indirect, or consequential damages arising as a result of delays described in this Section. The Contract Sum shall be adjusted to reflect payment of allowable costs.
- (5) If any delay described in this section causes the time or cost for the Project to exceed the Contract Time or the Contract Sum, then the Owner may terminate the Agreement pursuant to Section 14.2.
- (6) Contractor and any Subcontractor or supplier seeking additional costs under this Section 2.4.U. shall promptly submit estimates or any costs as requested by Owner, and detailed back-up for all costs when payment is sought or whenever reasonably requested by Owner. All costs are auditable, at Owner's discretion. Bid, estimate and pricing information reasonably related to any request for additional compensation will be provided promptly upon request.
- (7) Contractor shall include provisions in its subcontracts and purchase orders consistent with this Section.

V. Interfacing.

- (1) The Contractor shall take such measures as are necessary to ensure proper construction and delivery of the Project, including but not limited to providing that all procurement of long-lead items, the separate construction Subcontractors, and the general conditions items are performed without duplication or overlap to maintain completion of all Work on schedule. Particular attention shall be given to provide that each Subcontractor bid package clearly identifies the Work included in that particular separate subcontract, its scheduling for start and completion, and its relationship to other separate contractors.
- (2) Without assuming any design responsibilities of the Architect/Engineer, the Contractor shall include in the Progress Reports required under this Section 2.4 comments on overlap with any other separate subcontracts, omissions, lack of correlation between drawings, and any other deficiencies noted, in order that the Architect/Engineer may arrange for necessary corrections.

W. Job Site Facilities. The Contractor shall arrange for all job site facilities required and necessary to enable the Contractor and Architect/Engineer to perform their respective duties and to accommodate any representatives of the Owner which the Owner may choose to have present on the Project Site.

X. Weather Protection. The Contractor shall provide temporary enclosures of building areas to assure orderly progress of the Work during periods when extreme weather conditions are likely to be experienced. The Contractor shall also be responsible for providing weather protection for Work in progress and for materials stored on the Project Site. A contingency plan shall be prepared upon request of the Owner for weather conditions that may affect the construction.

Y. Payment and Performance Bond. Prior to the construction commencement date, the Contractor shall obtain, for the benefit of and directed to the Owner, a Payment and Performance Bond satisfying the requirements of Section 255.05, Florida Statutes, covering the faithful performance by the Contractor of its obligations under the Contract Documents, including but not limited to the construction of the Project on the Project Site and the payment of all obligations arising thereunder, including all payments to Subcontractors, laborers, and materialmen. The surety selected by the Contractor to provide the Payment and Performance Bond shall be approved by the Owner prior to the issuance of such Bond, which approval shall not be unreasonably withheld or delayed provided that the surety is rated A or better by Best's Key Guide, latest edition. For Changes in the Work that result in an increase in the Contract Sum, Owner reserves the right to require the Contractor to secure and deliver additive riders to the Payment and Performance Bond.

Z. Construction Phase; Building Permit; Code Inspections. Unless otherwise provided, Contractor shall obtain and pay for all construction permits and licenses. Owner shall assist Contractor, when necessary, in obtaining such permits and licenses. Contractor shall pay all governmental charges and inspection fees necessary for the prosecution of the Work.

(1) Building Permit. The Owner and Architect/Engineer shall provide such information to any Permitting Authority as is necessary to obtain approval from the Permitting Authority to commence construction prior to beginning construction. The Contractor shall pull any required building permit, and shall be responsible for delivering and posting the building permit at the Project Site prior to the commencement of construction. The cost of the building permit is included in the Contract Sum. The Owner and Architect/Engineer shall fully cooperate with the Contractor when and where necessary.

(2) Code Inspections. The Project requires detailed code compliance inspection during construction in disciplines determined by any Permitting Authority. These disciplines normally include, but are not necessarily limited to, structural, mechanical, electrical, plumbing, general building and fire. The Contractor shall notify the appropriate inspector(s) and the Architect/Engineer, no less than 24 hours in advance, when the Work is ready for inspection and before the Work is covered up. All inspections shall be made for conformance with the applicable ordinances and building codes. Costs for all re-inspections of Work found defective and subsequently repaired shall not be included as Project Costs and shall be borne by the Contractor or as provided in the contract between Contractor and Subcontractor.

- (3) Contractor's Personnel. The Contractor shall maintain sufficient off-site support staff and competent full-time staff at the Project Site authorized to act on behalf of the Contractor to coordinate, inspect, and provide general direction of the Work and progress of the Subcontractors. At all times during the performance of the Work, the Owner shall have the right to demand replacement of Contractor Personnel to whom the Owner has reasonable objection, without liability to the Contractor.
- (4) Lines of Authority. To provide general direction of the Work, the Contractor shall establish and maintain lines of authority for its personnel and shall provide this information to the Owner and all other affected parties, such as the code inspectors of any Permitting Authority, the Subcontractors, and the Architect/Engineer. The Owner and Architect/Engineer may attend meetings between the Contractor and his Subcontractors; however, such attendance is optional and shall not diminish either the authority or responsibility of the Contractor to administer the subcontracts.

AA. Quality Control. The Contractor shall develop and maintain a program, acceptable to the Owner and Architect/Engineer, to assure quality control of the construction. The Contractor shall be responsible for and supervise the Work of all Subcontractors, providing instructions to each when their Work does not conform to the requirements of the Project Plans and Specifications, and the Contractor shall continue to coordinate the Work of each Subcontractor to ensure that corrections are made in a timely manner so as to not affect the efficient progress of the Work. Should a disagreement occur between the Contractor and the Architect/Engineer over the acceptability of the Work, the Owner, at its sole discretion and in addition to any other remedies provided herein, shall have the right to determine the acceptability, provided that such determination is consistent with standards for construction projects of this type and generally accepted industry standards for workmanship in the State of Florida.

BB. Management of Subcontractors. All Subcontractors shall be compensated in accordance with Article IV. The Contractor shall solely control the Subcontractors. The Contractor shall negotiate all Change Orders and Field Orders with all affected Subcontractors and shall review the costs and advise the Owner and Architect/Engineer of their validity and reasonableness, acting in the Owner's best interest. When there is an imminent threat to health and safety, and Owner's Project Representative concurrence is impractical, the Contractor shall act immediately to remove the threats to health and safety and shall subsequently fully inform Owner of all such action taken. The Contractor shall also carefully review all shop drawings and then forward the same to the Architect/Engineer for review and actions. The Architect/Engineer will transmit them back to the Contractor, who will then issue the shop drawings to the affected Subcontractor for fabrication or revision. The Contractor shall maintain a suspense control system to promote expeditious handling. The Contractor shall request the Architect/Engineer to make interpretations of the drawings or specifications requested of him by the Subcontractors and shall maintain a business system to promote timely response. The Contractor shall inform the Architect/Engineer which shop drawings or requests for clarification have the greatest urgency, to enable the Architect/Engineer to prioritize requests coming from the Contractor. The Contractor shall advise the Owner and Architect/Engineer when timely response is not occurring on any of the above.

CC. Job Requirements.

- (1) The Contractor shall provide each of the following as a part of its services hereunder:
 - (a) Maintain a log of daily activities, including manpower records, equipment on site, weather, delays, major decisions, etc;
 - (b) Maintain a roster of companies on the Project with names and telephone numbers of key personnel;
 - (c) Establish and enforce job rules governing parking, clean-up, use of facilities, and worker discipline;
 - (d) Provide labor relations management and equal opportunity employment for a harmonious, productive Project;
 - (e) Provide and administer a safety program for the Project and monitor for subcontractor compliance without relieving them of responsibilities to perform Work in accordance with best acceptable practice;
 - (f) Provide a quality control program as provided under Section 2.4.C above;
 - (g) Provide miscellaneous office supplies that support the construction efforts which are consumed by its own forces;
 - (h) Provide for travel to and from its home office to the Project Site and to those other places within Manatee County as required by the Project;
 - (i) Verify that tests, equipment, and system start-ups and operating and maintenance instructions are conducted as required and in the presence of the required personnel and provide adequate records of same to the Architect/Engineer;
 - (j) Maintain at the job site orderly files for correspondence, reports of job conferences, shop drawings and sample submissions, reproductions of original Contract Documents including all addenda, change orders, field orders, additional drawings issued after execution of the Agreement, Owner/Architect/Engineer's clarifications and interpretations of the Contract Documents, Progress Reports, as-built drawings, and other project related documents;
 - (k) Keep a diary or log book, recording hours on the job site, weather conditions, data relative to questions of extras or deductions; list of visiting officials and representatives or manufacturers, fabricators,

suppliers and distributors; daily activities, decisions, observations in general and specific observations in more detail as in the case of observing test procedures, and provide copies of same to Owner/Architect/Engineer;

- (l) Record names, addresses and telephone numbers of all Contractors, Subcontractors and major suppliers of materials and equipment;
 - (m) Furnish Owner/Architect/Engineer periodic reports, as required, of progress of the Work and Contractor's compliance with the approved progress schedule and schedule of shop drawing submissions;
 - (n) Consult with Owner/Architect/Engineer in advance of scheduling major tests, inspections or start of important phases of the Work;
 - (o) Verify, during the course of the Work, that certificates, maintenance and operations manuals and other data required to be assembled and furnished are applicable to the items actually installed, and deliver same to Owner/Architect/Engineer for review prior to final Acceptance of the Work; and
 - (p) Cooperate with Owner in the administration of grants.
- (2) The Contractor shall provide personnel and equipment, or shall arrange for separate Subcontractors to provide each of the following as a Project Cost:
- (a) Services of independent testing laboratories, and provide the necessary testing of materials to ensure conformance to contract requirements; and
 - (b) Printing and distribution of all required bidding documents and shop drawings, including the sets required by Permitting Authority inspectors.

DD. As-Built Drawings. The Contractor shall continuously review as-built drawings and mark up progress prints to provide as much accuracy as possible. Prior to, and as a requirement for authorizing final payment to the Contractor due hereunder, the Contractor shall provide to the Owner an original set of marked-up, as-built Project Plans and Specifications and an electronic format of those records showing the location and dimensions of the Project as constructed, which documents shall be certified as being correct by the Contractor and the Architect/Engineer. Final as-built drawings shall be signed and sealed by a registered Florida surveyor.

EE. Progress Reports. The Contractor shall forward to the Owner, as soon as practicable after the first day of each month, a summary report of the progress of the various parts of the Work, to include those parts of the Work in fabrication and in the field, stating the existing status, estimated time of completion and cause of delay, if any. Together with the summary report, the Contractor shall submit any necessary revisions to the original schedule for the Owner's review

and approval. In addition, more detailed schedules may be required by the Owner for daily traffic control.

FF. Contractor's Warranty. The Contractor warrants to the Owner and Architect/Engineer that materials and equipment furnished under the Contract will be of good quality and new unless the Contract Documents require or permit otherwise. The Contractor further warrants that the Work will conform to the requirements of the Contract Documents and will be free from defects, except for those inherent in the quality of the Work the Contract Documents require or permit. Work, materials, or equipment not conforming to these requirements will be considered defective. The Contractor's warranty excludes remedy for damage or defect caused by abuse, alterations to the Work not executed by the Contractor, improper or insufficient maintenance, improper operation, or normal wear and tear and normal usage. If required by the Architect/Engineer, the Contractor shall furnish satisfactory evidence as to the kind and quality of materials and equipment.

- (1) Contractor shall use its best efforts and due diligence to ensure that during the warranty period, those entities or individuals who have provided direct warranties to the Owner as required by the Contract Documents perform all required warranty Work in a timely manner and at the sole cost and expense of such warranty providers. Any such cost or expense not paid by the warranty providers shall be paid by the Contractor, to include any costs and attorney's fees incurred in warranty-related litigation between Contractor and any Subcontractors.
- (2) The Contractor shall secure guarantees and warranties of Subcontractors, equipment suppliers and materialmen, and assemble and deliver same to the Owner in a manner that will facilitate their maximum enforcement and assure their meaningful implementation. The Contractor shall collect and deliver to the Owner any specific written guaranties or warranties given by others as required by subcontracts.
- (3) At the Owner's request, the Contractor shall conduct, jointly with the Owner and the Architect/Engineer, no more than two (2) warranty inspections within three (3) years after the Substantial Completion Date.

GG. Apprentices. If Contractor employs apprentices, their performance of Work shall be governed by and shall comply with the provisions of Chapter 446, Florida Statutes.

HH. Schedule of Values. Unit prices shall be established for this Agreement by the submission of a schedule of values within ten (10) days of receipt of the Notice to Proceed. The schedule shall include quantities and prices of items equaling the Contract Sum and will subdivide the Work into components in sufficient detail to serve as the basis for progress payments during construction. Such prices shall include an appropriate amount of overhead and profit applicable to each item of Work. Upon request of the County, the Contractor shall support the values with data which will substantiate their correctness.

II. Other Contracts. The Owner reserves the right to let other contracts in connection with this Work. The Contractor shall afford other contractors reasonable

opportunity for the introduction and storage of their materials and execution of their work, and promptly connect and coordinate the Work with theirs.

ARTICLE III COMPENSATION

3.1 Compensation. The Contract Sum constitutes the total compensation (subject to authorized adjustments) payable to Contractor for performing the Work. All duties, responsibilities and obligations assigned to or undertaken by Contractor shall be at Contractor's expense without change in the Contract Sum.

A. Adjustments. The Contract Sum may only be changed by Change Order or by a written amendment. Any claim for an increase or decrease in the Contract Sum shall be based on written notice delivered by the party making the claim to the other party. Notice of the amount of the claim with supporting data shall be delivered within fifteen (15) days from the beginning of such occurrence and shall be accompanied by claimant's written statement that the amount claimed covers all amounts to which the claimant is entitled as a result of the occurrence of said event. Failure to deliver a claim within the requisite 15-day period shall constitute a waiver of the right to pursue said claim.

B. Valuation. The value of any Work covered by a Change Order or of any claim for an increase or decrease in the Contract Sum shall be determined in one of the following ways (at Owner's discretion):

- (1) In the case of Unit Price Work, in accordance with Section 3.1.C, below; or
- (2) By mutual acceptance of a lump sum; or
- (3) On the basis of the cost of the Work, plus a negotiated Contractor's fee for overhead and profit. Contractor shall submit an itemized cost breakdown together with supporting data.

C. Unit Price Work. The unit price of an item of Unit Price Work shall be subject to re-evaluation and adjustment pursuant to a requested Change Order under the following conditions:

- (1) If the total cost of a particular item of Unit Price Work amounts to 5% or more of the Contract Sum and the variation in the quantity of the particular item of Unit Price Work performed by Contractor differs by more than 15% from the estimated quantity of such item indicated in the Agreement; and
- (2) If there is no corresponding adjustment with respect to any other item of Work; and
 - (i) If Contractor believes that it has incurred additional expense as a result thereof; or
 - (ii) If Owner believes that the quantity variation entitles it to an

adjustment in the unit price; or

- (iii) If the parties are unable to agree as to the effect of any such variations in the quantity of Unit Price Work performed.

3.2 Schedule of Compensation. All payments for services and material under the Contract Documents shall be made in accordance with the following provisions.

A. Periodic Payments for Services. The Contractor shall be entitled to receive payment for Construction Services rendered pursuant to Section 2.4 in periodic payments which shall reflect a fair apportionment of cost and schedule of values of services furnished prior to payment, subject to the provisions of this Section.

B. Payment for Materials and Equipment. In addition to the periodic payments authorized hereunder, payments may be made for material and equipment not incorporated in the Work but delivered and suitably stored at the Project Site, or another location, subject to prior approval and acceptance by the Owner on each occasion.

C. Credit toward Contract Sum. All payments for Construction Services made hereunder shall be credited toward the payment of the Contract Sum as Contractor's sole compensation for the construction of the Project.

3.3 Invoice and Payment. All payments for services and materials under the Contract Documents shall be invoiced and paid in accordance with the following provisions.

A. Invoices. The Contractor shall submit to the Owner periodic invoices for payment, in a form acceptable to the Owner, which shall include a sworn statement certifying that, to the best of the Contractor's knowledge, information and belief, the construction has progressed to the point indicated, the quality and the Work covered by the invoice is in accord with the Project Plans and Specifications, and the Contractor is entitled to payment in the amount requested, along with the cost reports required pursuant to Article II, showing in detail all monies paid out, Project Costs accumulated, or Project Cost incurred during the previous period. This data shall be attached to the invoice.

B. Additional Information; Processing of Invoices. Should an invoiced amount appear to exceed the Work effort believed to be completed, the Owner may, prior to processing of the invoice for payment, require the Contractor to submit satisfactory evidence to support the invoice. All Progress Reports and invoices shall be delivered to the attention of the Owner's Project Representative. Invoices not properly prepared (mathematical errors, billing not reflecting actual Work done, no signature, etc.) shall be returned to the Contractor for correction.

C. Architect/Engineer's Approval. Payment for Work completed shall be subject to the Architect/Engineer approving the payment requested by the Contractor and certifying the amount thereof that has been properly incurred and is then due and payable to the Contractor, and identifying with specificity any amount that has not been properly incurred and that should not be paid.

D. Warrants of Contractor with Respect to Payments. The Contractor warrants that (1) upon payment of any retainage, materials and equipment covered by a partial payment request will pass to Owner either by incorporation in construction or upon receipt of payment by the Contractor, whichever occurs first; (2) Work, materials and equipment covered by previous partial payment requests shall be free and clear of liens, claims, security interests, or encumbrances; and (3) no Work, materials or equipment covered by a partial payment request which has been acquired by the Contractor or any other person performing Work at the Project Site, or furnishing materials or equipment for the Project, shall be subject to an agreement under which an interest therein or an encumbrance thereon is retained by the seller or otherwise imposed by the Contractor or any other person.

E. All Compensation Included. Contractor's compensation includes full payment for services set forth in the Contract Documents, including but not limited to overhead, profit, salaries or other compensation of Contractor's officers, partners and/or employees, general operating expenses incurred by Contractor and relating to this Project, including the cost of management, supervision and data processing staff, job office equipment and supplies, and other similar items.

ARTICLE IV SUBCONTRACTORS

4.1 Subcontracts. At the Owner's request, the Contractor shall provide Owner's Project Representative with copies of all proposed and final subcontracts, including the general and supplementary conditions thereof.

A. Subcontracts Generally. All subcontracts shall: (1) require each Subcontractor to be bound to Contractor to the same extent Contractor is bound to Owner by the terms of the Contract Documents, as those terms may apply to the portion of the Work to be performed by the Subcontractor, (2) provide for the assignment of the subcontracts from Contractor to Owner at the election of Owner, upon termination of Contractor, (3) provide that Owner will be an additional indemnified party of the subcontract, (4) provide that Owner will be an additional insured on all insurance policies required to be provided by the Subcontractor, except workers' compensation, (5) assign all warranties directly to Owner, and (6) identify Owner as an intended third-party beneficiary of the subcontract.

(1) A Subcontractor is a person or entity who has a direct contract with Contractor to perform a portion of the Work at the site. The term "Subcontractor" is referred to throughout the Contract Documents as if singular in number and means a Subcontractor or an authorized representative of the Subcontractor. The term "Subcontractor" does not include a separate contractor or subcontractors of a separate contractor.

(2) A Sub-subcontractor is a person or entity who has a direct or indirect contract with a Subcontractor to perform a portion of the Work at the site. The term "Sub-subcontractor" is referred to throughout the Contract Documents as if singular in number and means a Sub-subcontractor or an authorized representative of the Sub-subcontractor.

B. No Damages for Delay. Except when otherwise expressly agreed to by Owner in writing, all subcontracts shall provide:

“LIMITATION OF REMEDIES – NO DAMAGES FOR DELAY. The Subcontractor's exclusive remedy for delays in the performance of the contract caused by events beyond its control, including delays claimed to be caused by the Owner or Architect/Engineer or attributable to the Owner or Architect/Engineer and including claims based on breach of contract or negligence, shall be an extension of its contract time and shall in no way involve any monetary claim.”

Each subcontract shall require that any claims by the Subcontractor for delay must be submitted to the Contractor within the time and in the manner in which the Contractor must submit such claims to the Owner, and that failure to comply with the conditions for giving notice and submitting claims shall result in the waiver of such claims.

C. Subcontractual Relations. The Contractor shall require each Subcontractor to assume all the obligations and responsibilities which the Contractor owes the Owner pursuant to the Contract Documents, by the parties to the extent of the Work to be performed by the Subcontractor. Said obligations shall be made in writing and shall preserve and protect the rights of the Owner and Architect/Engineer, with respect to the Work to be performed by the Subcontractor, so that the subcontracting thereof will not prejudice such rights. Where appropriate, the Contractor shall require each Subcontractor to enter into similar agreements with its sub-subcontractors.

D. Insurance; Acts and Omissions. Insurance requirements for Subcontractors shall be no more stringent than those requirements imposed on the Contractor by the Owner. The Contractor shall be responsible to the Owner for the acts and omissions of its employees, agents, Subcontractors, their agents and employees, and all other persons performing any of the Work or supplying materials under a contract to the Contractor.

4.2 Relationship and Responsibilities. Except as specifically set forth herein with respect to direct materials acquisitions by Owner, nothing contained in the Contract Documents or in any Contract Document does or shall create any contractual relation between the Owner or Architect/Engineer and any Subcontractor. Specifically, the Contractor is not acting as an agent of the Owner with respect to any Subcontractor. The utilization of any Subcontractor shall not relieve Contractor from any liability or responsibility to Owner, or obligate Owner to the payment of any compensation to the Subcontractor or additional compensation to the Contractor.

4.3 Payments to Subcontractors; Monthly Statements. The Contractor shall be responsible for paying all Subcontractors from the payments made by the Owner to Contractor pursuant to Article III, subject to the following provisions:

A. Payment. The Contractor shall, no later than ten (10) days after receipt of payment from the Owner, out of the amount paid to the Contractor on account of such Subcontractor's Work, pay to each Subcontractor the amount to which the Subcontractor is entitled in accordance with the terms of the Contractor's contract with such Subcontractor. The Contractor shall, by appropriate agreement with each Subcontractor, require each Subcontractor to make

payments to sub-Subcontractors in a similar manner. After receipt of payment from Owner, if the need should arise to withhold payments to Subcontractors for any reason, as solely determined by Contractor, the Contractor shall promptly restore such monies to the Owner, adjusting subsequent pay requests and Project bookkeeping as required.

B. Final Payment of Subcontractors. The final payment of retainage to Subcontractors shall not be made until the Project has been inspected by the Architect/Engineer or other person designated by the Owner for that purpose, and until both the Architect/Engineer and the Contractor have issued a written certificate that the Project has been constructed in accordance with the Project Plans and Specifications and approved Change Orders. Before issuance of final payment to any Subcontractor without any retainage, the Subcontractor shall submit satisfactory evidence that all payrolls, material bills, and other indebtedness connected with the Project have been paid or otherwise satisfied, warranty information is complete, as-built markups have been submitted, and instruction for the Owner's operating and maintenance personnel is complete. Final payment may be made to certain select Subcontractors whose Work is satisfactorily completed prior to the completion of the Project, but only upon approval of the Owner's Project Representative.

4.4 Responsibility for Subcontractors. As provided in Section 2.4.BB, Contractor shall be fully responsible to Owner for all acts and omissions of the Subcontractors, suppliers and other persons and organizations performing or furnishing any of the Work under a direct or indirect Contract with Contractor just as Contractor is responsible for Contractor's own acts and omissions.

4.5 Contingent Assignment of Subcontracts. Each subcontract agreement for a portion of the Work is assigned by the Contractor to the Owner, provided that:

- (1) assignment is effective only after termination of the Contract by the Owner for cause pursuant to Article XIV and only for those subcontract agreements that the Owner accepts by notifying the Subcontractor and Contractor in writing; and
- (2) assignment is subject to the prior rights of the surety, if any, obligated under bond relating to the Agreement.

When the Owner accepts the assignment of a subcontract agreement, the Owner assumes the Contractor's rights and obligations under the subcontract. Upon such assignment, if the Work has been suspended for more than thirty (30) days, the Subcontractor's compensation shall be equitably adjusted for increases in cost resulting from the suspension. Upon such assignment to the Owner, the Owner may further assign the subcontract to a successor contractor or other entity. If the Owner assigns the subcontract to a successor contractor or other entity, the Owner shall nevertheless remain legally responsible for all of the successor contractor's obligations under the subcontract.

ARTICLE V CHANGES IN WORK

5.1 General. Changes in the Work may be accomplished after execution of the Agreement, and without invalidating the Agreement, by Change Order, Work Directive Change

or order for a minor change in the Work, subject to the limitations stated in this Article V and elsewhere in the Contract Documents. A Change Order shall be based upon agreement among the Owner, Contractor and Architect/Engineer; a Work Directive Change requires agreement by the Owner and Architect/Engineer and may or may not be agreed to by the Contractor; an order for a minor change in the Work may be issued by the Architect/Engineer alone. Changes in the Work shall be performed under applicable provisions of the Contract Documents, and the Contractor shall proceed promptly, unless otherwise provided in the Change Order, Work Directive Change or order for a minor change in the Work.

5.2 Minor Changes in the Work. The Owner or Architect/Engineer shall have authority to order minor changes in the Work not involving adjustment in the Contract Sum or extension of the Contract Time and not inconsistent with the intent of the Contract Documents. Such change will be effected by written order signed by the Architect/Engineer and shall be binding on the Owner and Contractor. The Contractor shall abide by and perform such minor changes. Such changes shall be effected by a Field Directive or a Work Directive Change. Documentation of changes shall be determined by the Construction Team, and displayed monthly in the Progress Reports. Because such changes shall not affect the Contract Sum to be paid to the Contractor, they shall not require a Change Order pursuant to Section 5.6.

5.3 Emergencies. In any emergency affecting the safety of persons or property, the Contractor shall act at its discretion to prevent threatened damage, injury, or loss. Any increase in the Contract Sum or extension of time claimed by the Contractor because of emergency Work shall be determined as provided in Section 5.6. However, whenever practicable, the Contractor shall obtain verbal concurrence of the Owner's Project Representative and Architect/Engineer where the act will or may affect the Contract Sum or Contract Time.

5.4 Concealed Conditions. If the Contractor encounters conditions at the site that are (1) subsurface or otherwise concealed physical conditions that differ materially from those indicated in the Contract Documents or (2) unknown physical conditions of an unusual nature, that differ materially from those ordinarily found to exist and generally recognized as inherent in construction activities of the character provided for in the Contract Documents, the Contractor shall promptly provide notice to the Owner and the Architect/Engineer before conditions are disturbed and in no event later than ten (10) days after first observance of the conditions. The Architect/Engineer will promptly investigate such conditions and, if the Architect/Engineer determines that they differ materially and cause an increase or decrease in the Contractor's cost of, or time required for, performance of any part of the Work, will recommend an equitable adjustment in the Contract Sum or Contract Time, or both. If the Architect/Engineer determines that the conditions at the site are not materially different from those indicated in the Contract Documents and that no change in the terms of the Contract is justified, the Architect/Engineer shall promptly notify the Owner and Contractor in writing, stating the reasons. If the Contractor disputes the Architect/Engineer's determination or recommendation, the Contractor may proceed as provided in Article VIII. If the Owner disputes the Architect/Engineer's determination or recommendation, the Owner may appeal directly to the Purchasing Official and shall thereafter follow the process set forth in Section 8.5.

5.5 Hazardous Materials. In the event the Contractor encounters on the Project Site material reasonably believed to be hazardous, petroleum or petroleum related products, or other hazardous or toxic substances, except as provided in Section 2.4.U, the Contractor shall immediately stop Work in the area affected and report the condition to the Owner and the

Architect/Engineer in writing. The Work in the affected area shall not thereafter be resumed except by Change Order or written amendment, if in fact the material or substance has not been rendered harmless. The Work in the affected area shall be resumed when the Project Site has been rendered harmless, in accordance with the final determination by the Architect/Engineer or other appropriate professional employed by Owner. The Contractor shall not be required to perform without its consent any Work relating to hazardous materials, petroleum or petroleum related products, or other hazardous or toxic substances. In the event the Contractor encounters on the Project Site materials believed in good faith to be hazardous or contaminated material, and the presence of such hazardous or contaminated material was not known and planned for at the time the Contractor submitted its Bid (or Guaranteed Maximum Price proposal), and it is necessary for the Contractor to stop Work in the area affected and delays Work for more than a seven (7) day period, adjustments to the Contract Sum and/or Contract Time shall be made in accordance with this Article V.

5.6 Change Orders; Adjustments to Contract Sum.

A. Change Orders Generally. The increase or decrease in the Contract Sum resulting from a change authorized pursuant to the Contract Documents shall be determined:

- (1) By mutual acceptance of a lump sum amount properly itemized and supported by sufficient substantiating data, to permit evaluation by the Architect/Engineer and Owner; or
- (2) By unit prices stated in the Agreement or subsequently agreed upon; or
- (3) By any other method mutually agreeable to Owner and Contractor.

If Owner and Contractor are unable to agree upon increases or decreases in the Contract Sum and the Architect/Engineer certifies that the work needs to be commenced prior to any such agreement, the Contractor, provided it receives a written Change Order signed by or on behalf of the Owner, shall promptly proceed with the Work involved. The cost of such Work shall then be determined on the basis of the reasonable expenditures of those performing the Work attributed to the change. However, in the event a Change Order is issued under these conditions, the Owner, through the Architect/Engineer, will establish an estimated cost of the Work and the Contractor shall not perform any Work whose cost exceeds that estimated without prior written approval by the Owner. In such case, the Contractor shall keep and present in such form as the Owner may prescribe an itemized accounting, together with appropriate supporting data of the increase in overall costs of the Project. The amount of any decrease in the Contract Sum to be allowed by the Contractor to the Owner for any deletion or change which results in a net decrease in costs will be the amount of the actual net decrease.

5.7 Owner-Initiated Changes. Without invalidating the Agreement and without notice to any Surety, Owner may, at any time, order additions, deletions or revisions in the Work. These will be authorized by a written amendment, a Field Directive, a Change Order, or a Work Directive Change, as the case may be. Upon receipt of any such document, Contractor shall promptly proceed with the Work involved which will be performed under the applicable conditions of the

Contract Documents (except as otherwise specifically provided). A Work Directive Change may not change the Contract Sum or the Contract Time; but is evidence that the parties expect that the change directed or documented by a Work Directive Change will be incorporated in a subsequently issued Change Order following negotiations by the parties as to its effect, if any, on the Contract Sum or Contract Time.

5.8 Unauthorized Work. Contractor shall not be entitled to an increase in the Contract Sum or an extension of the Contract Time with respect to any Work performed that is not required by the Contract Documents.

5.9 Defective Work. Owner and Contractor shall execute appropriate Change Orders (or written amendments) covering changes in the Work which are ordered by Owner, or which may be required because of acceptance of defective Work, without adjustment to the Contract Sum.

5.10 Estimates for Changes. At any time Architect/Engineer may request a quotation from Contractor for a proposed change in the Work. Within twenty-one (21) calendar days after receipt, Contractor shall submit a written and detailed proposal for an increase or decrease in the Contract Sum or Contract Time for the proposed change. Architect/Engineer shall have twenty-one (21) calendar days after receipt of the detailed proposal to respond in writing. The proposal shall include an itemized estimate of all costs and time for performance that will result directly or indirectly from the proposed change. Unless otherwise directed, itemized estimates shall be in sufficient detail to reasonably permit an analysis by Architect/Engineer of all material, labor, equipment, subcontracts, overhead costs and fees, and shall cover all Work involved in the change, whether such Work was deleted, added, changed or impacted. Notwithstanding the request for quotation, Contractor shall carry on the Work and maintain the progress schedule. Delays in the submittal of the written and detailed proposal will be considered non-prejudicial.

5.11 Form of Proposed Changes. The form of all submittals, notices, Change Orders and other documents permitted or required to be used or transmitted under the Contract Documents shall be determined by the Owner. Standard Owner forms shall be utilized.

5.12 Changes to Contract Time. The Contract Time may only be changed pursuant to a Change Order or a written amendment to the Contract Documents. Any claim for an extension or shortening of the Contract Time shall be based on written notice delivered by the party making the claim to the other party. Notice of the extent of the claim with supporting data shall be delivered within fifteen (15) days from detection or beginning of such occurrence and shall be accompanied by the claimant's written statement that the adjustment claimed is the entire adjustment to which the claimant has reason to believe it is entitled to because of the occurrence of said event. The Contract time will be extended in an amount equal to time lost due to delays beyond the control of Contractor. Such delays shall include, but not be limited to, acts or neglect by Owner or others performing additional Work; or to fires, floods, epidemics, abnormal weather conditions or acts of God. Failure to deliver a written notice of claim within the requisite 15-day period shall constitute a waiver of the right to pursue said claim.

ARTICLE VI ROLE OF ARCHITECT/ENGINEER

6.1 General.

A. Retaining. The Owner shall retain an Architect/Engineer (whether an individual or an entity) lawfully licensed to practice in Florida. That person or entity is identified as the Architect/Engineer in the Agreement and is referred to throughout the Contract Documents as if singular in number.

B. Duties. Duties, responsibilities and limitations of authority of the Architect/Engineer as set forth in the Contract Documents shall not be restricted, modified or extended without written consent of the Owner and Architect/Engineer. Consent shall not be unreasonably withheld.

C. Termination. If the employment of the Architect/Engineer is terminated, the Owner shall employ a successor Architect/Engineer as to whom the Contractor has no reasonable objection and whose status under the Contract Documents shall be that of the Architect/Engineer.

6.2 Administration. The Architect/Engineer will provide administration of the Agreement as described in the Contract Documents and will be an Owner's representative during construction until the date the Architect/Engineer approves the final Application for Payment. The Architect/Engineer will have authority to act on behalf of the Owner only to the extent provided in the Contract Documents.

A. Site Visits. The Architect/Engineer will visit the site at intervals appropriate to the stage of construction, or as otherwise agreed with the Owner, to become generally familiar with the progress and quality of the portion of the Work complete, and to determine in general if the Work observed is being performed in a manner indicating that the Work, when fully completed, will be in accordance with the Contract Documents. Unless specifically instructed by Owner, the Architect/Engineer will not be required to make exhaustive or continuous on-site inspections to check the quality or quantity of the Work. The Architect/Engineer will not have control over, charge of, or responsibility for, the construction means, methods, techniques, sequences or procedures, or for the safety precautions and programs in connection with the Work, since these are solely the Contractor's rights and responsibilities under the Contract Documents.

B. Reporting. Based on the site visits, the Architect/Engineer will keep the Owner reasonably informed about the progress and quality of the portion of the Work completed, and report to the Owner (1) known deviations from the Contract Documents and from the most recent construction schedule submitted by the Contractor, and (2) defects and deficiencies observed in the Work. The Architect/Engineer will not be responsible for the Contractor's failure to perform the Work in accordance with the requirements of the Contract Documents. The Architect/Engineer will not have control over or charge of and will not be responsible for acts or omissions of the Contractor, Subcontractors, or their agents or employees, or any other persons or entities performing portions of the Work.

6.3 Interpretation of Project Plans and Specifications. The Architect/Engineer will be the interpreter of the requirements of the Project Plans and Specifications. Upon receipt of comments or objections by Contractor or Owner, the Architect/Engineer will make decisions on all claims, disputes, or other matters pertaining to the interpretation of the Project Plans and Specifications.

6.4 Rejection of Non-Conforming Work. Upon consultation with Owner, the Architect/Engineer shall have the authority to reject Work which does not conform to the Project Plans and Specifications.

6.5 Correction of Work. The Contractor shall promptly correct all Work rejected by the Architect/Engineer for being defective or as failing to conform to the Project Plans and Specifications, whether observed before or after the Substantial Completion Date and whether or not fabricated, installed, or completed. The Contractor shall bear all costs of correcting such rejected Work, including compensation for Architect/Engineer's additional services made necessary thereby.

6.6 Timely Performance of Architect/Engineer. The Contractor shall identify which requests for information or response from the Architect/Engineer have the greatest urgency and those items which require prioritizing in response by the Architect/Engineer. The Contractor shall also identify the preferred time period for response and shall request a response time which is reasonably and demonstrably related to the needs of the Project and Contractor. If Architect/Engineer claims that Contractor's expectations for a response are unreasonable, Owner shall require Architect/Engineer to communicate such claim to Contractor in writing together with the specific time necessary to respond and the date upon which such response will be made. If Contractor believes that Architect/Engineer is not providing timely services or responses, Contractor shall notify Owner of same in writing not less than two (2) weeks before Contractor believes performance or response time from Architect/Engineer is required without risk of delaying the Project.

ARTICLE VII OWNER'S RIGHTS AND RESPONSIBILITIES

7.1 Project Site; Title. The Owner shall provide the lands upon which the Work under the Contract Documents is to be done, except that the Contractor shall provide all necessary additional land required for the erection of temporary construction facilities and storage of his materials, together with right of access to same. The Owner hereby represents to the Contractor that it currently has and will maintain up through and including the Substantial Completion Date, good title to all of the real property constituting the Project Site. Owner agrees to resolve, at its expense, any disputes relating to the ownership and use of the Project Site which might arise during construction.

7.2 Project Plans and Specifications; Architect/Engineer. The parties hereto acknowledge and agree that Owner has previously entered into an agreement with Architect/Engineer. Pursuant to the terms of such agreement, the Architect/Engineer, as an agent and representative of Owner, is responsible for the preparation of Project Plans and Specifications which consist of drawings, specifications, and other documents setting forth in detail the requirements for the construction of the Project. All such Project Plans and Specifications shall be provided either by Owner or the Architect/Engineer, and Contractor shall be under no obligation to provide same and shall be entitled to rely upon the accuracy and completeness of the Project Plans and Specifications provided by the Architect/Engineer and all preliminary drawings prepared in connection therewith. The Contractor will be furnished a reproducible set of all drawings and specifications reasonably necessary for the performance of Contractor's services hereunder and

otherwise ready for printing. The Contractor shall be notified of any written modification in the agreement between Owner and Architect/Engineer.

7.3 Surveys; Soil Tests and Other Project Site Information. Owner shall be responsible for providing a legal description and certified land survey of the Project Site in a form and content and with such specificity as may be required by the Architect/Engineer and Contractor to perform their services. To the extent deemed necessary by Owner and Architect/Engineer, and solely at Owner's expense, Owner may engage the services of a geotechnical consultant to perform test borings and other underground soils testing as may be deemed necessary by the Architect/Engineer or the Contractor. Contractor shall not be obligated to provide such surveys or soil tests and shall be entitled to rely upon the accuracy and completeness of the information provided; subject, however, to the provisions of Section 2.4.S hereof. Owner shall provide Contractor, as soon as reasonably possible following the execution of the Contract Documents, all surveys or other survey information in its possession describing the physical characteristics of the Project Site, together with soils reports, subsurface investigations, utility locations, deed restrictions, easements, and legal descriptions then in its possession or control. Upon receipt of all surveys, soils tests, and other Project Site information, Contractor shall promptly advise Owner of any inadequacies in such information and of the need for any additional surveys, soils or subsoil tests. In performing this Work, Contractor shall use the standard of care of experienced contractors and will use its best efforts timely to identify all problems or omissions. Owner shall not be responsible for any delay or damages to the Contractor for any visible or disclosed site conditions or disclosed deficiencies in the Project Site which should have been identified by Contractor and corrected by Owner prior to the execution of the Contract Documents.

7.4 Information; Communication; Coordination. The Owner's Project Representative shall examine any documents or requests for information submitted by the Contractor and shall advise Contractor of Owner's decisions pertaining thereto within a reasonable period of time to avoid unreasonable delay in the progress of the Contractor's services. Contractor shall indicate if any such documents or requests warrant priority consideration. However, decisions pertaining to approval of the Project Schedule as it relates to the date of Substantial Completion, the Project Cost, Contractor's compensation, approving or changing the Contract Sum shall only be effective when approved by Owner in the form of a written Change Order or amendment to the Contract Documents. Owner reserves the right to designate a different Owner's Project Representative provided Contractor is notified in writing of any such change. Owner and Architect/Engineer may communicate with Subcontractors, materialmen, laborers, or suppliers engaged to perform services on the Project, but only for informational purposes. Neither the Owner nor the Architect/Engineer shall attempt to direct the Work of or otherwise interfere with any Subcontractor, materialman, laborer, or supplier, or otherwise interfere with the Work of the Contractor. Owner shall furnish the data required of Owner under the Contract Documents promptly.

7.5 Governmental Body. The Contractor recognizes that the Owner is a governmental body with certain procedural requirements to be satisfied. The Contractor has and will make reasonable allowance in its performance of services for such additional time as may be required for approvals and decisions by the Owner and any other necessary government agency.

7.6 Pre-Completion Acceptance. The Owner shall have the right to take possession of and use any completed portions of the Work, although the time for completing the entire Work

or such portions may not have expired, but such taking possession and use shall not be deemed an acceptance of any Work not completed in accordance with the Contract Documents.

7.7 Ownership and Use of Drawings, Specifications and Other Instruments of Service.

- (1) The Architect/Engineer and the Architect/Engineer's consultants shall be deemed the authors and owners of their respective instruments of service, including the Project Plans and Specifications, and will retain all common law, statutory and other reserved rights, including copyrights. The Contractor, Subcontractors, Sub-subcontractors, and material or equipment suppliers shall not own or claim a copyright in the instruments of service. Submittal or distribution to meet official regulatory requirements or for other purposes in connection with this Project is not to be construed as publication in derogation of the Architect/Engineer's or Architect/Engineer's consultants' reserved rights.
- (2) The Contractor, Subcontractors, Sub-subcontractors and material or equipment suppliers are authorized to use and reproduce the drawings and specifications provided to them solely and exclusively for execution of the Work. All copies made under this authorization shall bear the copyright notice, if any, shown on the Project Plans and Specifications or other instruments of service. The Contractor, Subcontractors, Sub-subcontractors, and material or equipment suppliers may not use the drawings or specifications on other projects or for additions to this Project outside the scope of the Work without the specific written consent of the Owner, Architect/Engineer and the Architect/Engineer's consultants.

7.8 Owner's Project Representative. Owner's Project Representative is Owner's Agent, who will act as directed by and under the supervision of the Owner, and who will confer with Owner/Architect/Engineer regarding his actions. The Owner's Project Representative's dealings in matters pertaining to the on-site Work shall, in general, be only with the Owner/Architect/Engineer and Contractor and dealings with Subcontractors shall only be through or with the full knowledge of Contractor.

A. Responsibilities. Except as otherwise instructed in writing by Owner, the Owner's Project Representative will:

- (1) Attend preconstruction conferences; arrange a schedule of progress meetings and other job conferences as required in consultation with Owner/Architect/Engineer and notify those expected to attend in advance; and attend meetings and maintain and circulate copies of minutes thereof;
- (2) Serve as Owner/Architect/Engineer's liaison with Contractor, working principally through Contractor's superintendent, to assist in understanding the intent of the Contract Documents. As requested by Owner/Architect/Engineer, assist in obtaining additional details or information when required at the job site for proper execution of the Work;

- (3) Report to Owner/Architect/Engineer whenever he believes that any Work is unsatisfactory, faulty or defective or does not conform to the Contract Documents;
- (4) Accompany visiting inspectors representing public or other agencies having jurisdiction over the project; record the outcome of these inspections and report to Owner/Architect/Engineer;
- (5) Review applications for payment with Contractor for compliance with the established procedure for their submission and forward them with recommendations to Owner/Architect/Engineer; and
- (6) Perform those duties as set forth elsewhere within the Contract Documents.

B. Limitations. Except upon written instructions of Owner, Owner's Project Representative shall not:

- (1) Authorize any deviation from the Contract Documents or approve any substitute materials or equipment;
- (2) Exceed limitations on Owner/Architect/Engineer's authority as set forth in the Contract Documents;
- (3) Undertake any of the responsibilities of Contractor, Subcontractors or Contractor's superintendent, or expedite the Work;
- (4) Advise on or issue directions relative to any aspect of the means, methods, techniques, sequences or procedures of construction unless such is specifically called for in the Contract Documents;
- (5) Advise on or issue directions as to safety precautions and programs in connection with the Work;
- (6) Authorize Owner to occupy the project in whole or in part; or
- (7) Participate in specialized field or laboratory tests.

ARTICLE VIII RESOLUTION OF DISAGREEMENTS; CLAIMS FOR COMPENSATION

8.1 Owner to Decide Disputes. The Owner shall reasonably decide all questions and disputes (with the exception of matters pertaining to the interpretation of the Project Plans and Specifications which shall be resolved by the Architect/Engineer pursuant to Section 6.3) that may arise in the execution and fulfillment of the services provided for under the Contract Documents, in accordance with the Procurement Ordinance.

8.2 Finality. The decision of the Owner upon all claims, questions, disputes and conflicts shall be final and conclusive, and shall be binding upon all parties to the Contract Documents, subject to judicial review as provided in Section 8.5 below.

8.3 No Damages for Delay. If at any time Contractor is delayed in the performance of Contractor's responsibilities under the Contract Documents as the result of a default or failure to perform in a timely manner by Owner or Owner's agents or employees, Contractor shall not be entitled to any damages except for compensation specifically authorized in Article III. Contractor's sole remedy will be a right to extend the time for performance. Nothing herein shall preclude Contractor from any available remedy against any responsible party other than Owner. Contractor shall be responsible for liquidated damages for delay if otherwise provided for in the Contract Documents.

8.4 Permitted Claims Procedure. Where authorized or permitted under the Contract Documents, all claims for additional compensation by Contractor, extensions of time affecting the Substantial Completion Date, for payment by the Owner of costs, damages or losses due to casualty, Force Majeure, Project Site conditions or otherwise, shall be governed by the following:

- (1) All claims must be submitted as a request for Change Order in the manner as provided in Article V.
- (2) The Contractor must submit a notice of claim to Owner's Project Representative and to the Architect/Engineer within fifteen (15) days of the beginning of such occurrence. Failure to submit a claim within the requisite 15-day period shall constitute a waiver of the right to pursue said claim.
- (3) Within twenty (20) days of submitting its notice of claim, the Contractor shall submit to the Owner's Project Representative its request for Change Order, which shall include a written statement of all details of the claim, including a description of the Work affected.
- (4) After receipt of a request for Change Order, the Owner's Project Representative, in consultation with the Architect/Engineer, shall deliver to the Contractor, within twenty (20) days after receipt of request, its written response to the claim.
- (5) In the event the Owner and Contractor are unable to agree on the terms of a Change Order, the Owner shall have the option to instruct the Contractor to proceed with the Work. In that event, the Owner shall pay for those parts of the Work, the scope and price of which are not in dispute. The balance of the disputed items in the order to proceed will be resolved after completion of the Work, based upon completed actual cost.
- (6) The rendering of a decision by Owner with respect to any such claim, dispute or other matter (except any which have been waived by the making or acceptance of final payment) will be a condition precedent to any exercise by Owner or Contractor of such right or remedies as either may otherwise have under the Contract Documents or by laws or regulations in respect of any such claim, dispute or other matter.

8.5 Contract Claims and Disputes. After completion of the process set forth in Section 8.4 above, any unresolved dispute under this Agreement shall be decided by the Purchasing Official in accordance with Section 2-26-63 of the Manatee County Code of Laws, subject to an administrative hearing process as provided in Section 2-26-64. The decision of the hearing officer in accordance with Section 2-26-64 of the Manatee County Code of Laws shall be the final and conclusive decision subject to exclusive judicial review in circuit court by a petition for certiorari.

8.6 Claims for Consequential Damages. The Contractor and Owner waive claims against each other for consequential damages arising out of or relating to this Agreement. This mutual waiver includes:

- (1) damages incurred by the Owner for rental expenses, for losses of use, income, profit, financing, business and reputation, and for loss of management or employee productivity or of the services of such persons, unless any of such damages or losses are covered by insurance placed by the Contractor; and
- (2) damages incurred by the Contractor for principal office expenses including the compensation of personnel stationed there, for losses of financing, business and reputation, and for loss of profit except anticipated profit arising directly from the Work.

This mutual waiver is applicable, without limitation, to all consequential damages due to either party's termination in accordance with Article XIV. Nothing contained in this Section 8.6 shall be deemed to preclude assessment of liquidated direct damages, when applicable, in accordance with the requirements of the Contract Documents.

ARTICLE IX INDEMNITY

9.1 Indemnity.

A. Indemnification Generally. To the fullest extent permitted by law, the Contractor shall indemnify and hold harmless the Owner, Architect/Engineer, Architect/Engineer's consultants, and agents and employees of any of them from and against claims, damages, losses and expenses, including but not limited to attorney's fees, arising out of or resulting from performance of the Work, provided that such claim, damage, loss or expense is attributable to bodily injury, sickness, disease or death, or to injury to or destruction of tangible property, but only to the extent caused by the negligent acts or omissions of the Contractor, a Subcontractor or anyone directly or indirectly employed by them or anyone for whose acts they may be liable, regardless of whether such claim, damage, loss or expense is caused in part by a party indemnified hereunder. Such obligation shall not be construed to negate, abridge, or reduce other rights or obligations of indemnity which would otherwise exist as to a party or person described in this Section 9.1.

B. Indemnification; Enforcement Actions. The Contractor's duty to indemnify and hold harmless the Owner in Section 9.1 above shall extend to fines, penalties and costs incurred by the Owner as related to any enforcement action taken by local, state, regional or federal regulatory entities. The Owner may deduct any of such fines, penalties and costs as described in this Section from any unpaid amounts then or thereafter due the Contractor under the Contract Documents. Any of such fines, penalties and costs not so deducted from any unpaid amounts due the Contractor shall be payable to the Owner at the demand of the Owner, together with interest from the date of the demand at the maximum allowable rate.

C. Claims by Employees. In claims against any person or entity indemnified under this Section 9.1 by an employee of the Contractor, a Subcontractor, anyone directly or indirectly employed by them or anyone for whose acts they may be liable, the indemnification obligation under Section 9.1.A. shall not be limited by a limitation on amount or type of damages, compensation or benefits payable by or for the Contractor or a Subcontractor under workers' compensation acts, disability benefit acts or other employee benefit acts.

9.2 Duty to Defend. The Contractor shall defend the Owner in any action, lawsuit, mediation or arbitration arising from the alleged negligence, recklessness or intentionally wrongful conduct of the Contractor and other persons employed or utilized by the Contractor in the performance of the Work. Notwithstanding any other provisions within this Article IX, so long as Contractor, through its own counsel, performs its obligation to defend the Owner pursuant to this Section, Contractor shall not be required to pay the Owner's costs associated with the Owner's participation in the defense.

ARTICLE X ACCOUNTING RECORDS; OWNERSHIP OF DOCUMENTS

10.1 Accounting Records. Records of expenses pertaining to all services performed shall be kept in accordance with generally accepted accounting principles and procedures.

10.2 Inspection and Audit. The Contractor's records shall be open to inspection and subject to examination, audit, and/or reproduction during normal working hours by the Owner's agent or authorized representative to the extent necessary to adequately permit evaluation and verification of any invoices, payments or claims submitted by the Contractor or any of its payees during the performance of the Work. These records shall include, but not be limited to, accounting records, written policies and procedures, Subcontractor files (including proposals of successful and unsuccessful bidders), original estimates, estimating worksheets, correspondence, Change Order files (including documentation covering negotiated settlements), and any other supporting evidence necessary to substantiate charges related to the Contract Documents. They shall also include, but not be limited to, those records necessary to evaluate and verify direct and indirect costs (including overhead allocations) as they may apply to costs associated with the Contract Documents. For such audits, inspections, examinations and evaluations, the Owner's agent or authorized representative shall have access to said records from the effective date of the

Contract Documents, for the duration of Work, and until three (3) years after the date of final payment by the Owner to the Contractor pursuant to the Contract Documents.

10.3 Access. The Owner's agent or authorized representative shall have access to the Contractor's facilities and all necessary records to conduct audits in compliance with this Article. The Owner's agent or authorized representative shall give the Contractor reasonable advance notice of intended inspections, examinations, and/or audits.

10.4 Ownership of Documents. Upon obtainment of Substantial Completion or termination of the Agreement, all records, documents, tracings, plans, specifications, maps, evaluations, reports, transcripts and other technical data, other than working papers, prepared or developed by the Contractor shall be delivered to and become the property of the Owner. The Contractor at its own expense may retain copies for its files and internal use.

ARTICLE XI PUBLIC CONTRACT LAWS

11.1 Equal Opportunity Employment.

A. Employment. The Contractor shall not discriminate against any employee or applicant for employment because of race, creed, sex, color, national origin, disability or age, and will take affirmative action to ensure that all employees and applicants are afforded equal employment opportunities without discrimination because of race, creed, sex, color, national origin, disability or age. Such action will be taken with reference to, but shall not be limited to, recruitment, employment, job assignment, promotion, upgrading, demotion, transfer, layoff or termination, rates of training or retraining, including apprenticeship and on-the-job training.

B. Participation. No person shall, on the grounds of race, creed, sex, color, national origin, disability or age, be excluded from participation in, be denied the proceeds of, or be subject to discrimination in the performance of the Agreement.

11.2 Immigration Reform and Control Act of 1986. Contractor acknowledges that it is responsible for complying with the provisions of the Immigration Reform and Control Act of 1986, located at 8 U.S.C. Section 1324, et seq., and regulations relating thereto. Failure to comply with the above statutory provisions shall be considered a material breach and shall be grounds for immediate termination of this Agreement.

11.3 No Conflict of Interest. The Contractor warrants that it has not employed or retained any company or person, other than a bona fide employee working solely for the Contractor to solicit or secure this Agreement, and that it has not paid or agreed to pay any person, company, corporation, individual, or firm other than a bona fide employee working solely for the Contractor, any fee, commission, percentage, gift or any other consideration, contingent upon or resulting from the award or making of this Agreement.

A. No Interest in Business Activity. By accepting award of this Agreement, the Contractor, which shall include its directors, officers and employees, represents that it presently has no interest in and shall acquire no interest in any business or activity which would conflict in any manner with the performance of services required hereunder, including without limitation as described in the Contractor's own professional ethical requirements. An interest in a business or activity which shall be deemed a conflict includes but is not limited to direct financial interest in any of the material and equipment manufacturers, suppliers, distributors, or contractors who will be eligible to supply material and equipment for the Project for which the Contractor is furnishing its services required hereunder.

B. No Appearance of Conflict. The Contractor shall not knowingly engage in any contractual or professional obligations that create an appearance of a conflict of interest with respect to the services provided pursuant to the Agreement. The Contractor has provided the Affidavit of No Conflict, incorporated into the Contract Documents as Exhibit "C", as a material inducement for Owner entering the Agreement. If, in the sole discretion of the County Administrator or designee, a conflict of interest is deemed to exist or arise during the term of this Agreement, the County Administrator or designee may cancel this Agreement, effective upon the date so stated in a written notice of cancellation, without penalty to the Owner.

11.4 Truth in Negotiations. By execution of the Contract Documents, the Contractor certifies to truth-in-negotiations and that wage rates and other factual unit costs supporting the compensation are accurate, complete and current at the time of contracting. Further, the original Contract Sum and any additions thereto shall be adjusted to exclude any significant sums where the Owner determines the Contract Sum was increased due to inaccurate, incomplete or non-current wage rates and other factual unit costs. Such adjustments must be made within one (1) year after final payment to the Contractor.

11.5 Public Entity Crimes. The Contractor is directed to the Florida Public Entity Crimes Act, Section 287.133, Florida Statutes, specifically section 2(a), and the Owner's requirement that the Contractor comply with it in all respects prior to and during the term of the Agreement.

ARTICLE XII FORCE MAJEURE, FIRE OR OTHER CASUALTY

12.1 Force Majeure.

A. Unavoidable Delays. Delays in any performance by any party contemplated or required hereunder due to fire, flood, sinkhole, earthquake or hurricane, acts of God, unavailability of materials, equipment or fuel, war, declaration of hostilities, revolt, civil strife, altercation or commotion, strike, labor dispute, or epidemic, archaeological excavation, lack of or failure of transportation facilities, or any law, order, proclamation, regulation, or ordinance of any government or any subdivision thereof, or for any other similar cause to those enumerated, beyond the reasonable control and which with due diligence could not have been reasonably anticipated, shall be deemed to be events of Force Majeure and any such delays shall be excused. In the event such party is delayed in the performance of any Work or obligation pursuant to the Contract Documents for any of the events of Force Majeure stated in this Section 12.1, the date for

performance required or contemplated by the Contract Documents shall be extended by the number of calendar days such party is actually delayed.

B. Concurrent Contractor Delays. If a delay is caused for any reason provided in Section 12.1.A. and during the same time period a delay is caused by Contractor, the date for performance shall be extended as provided in 12.1.A. but only to the extent the time is or was concurrent.

C. Notice; Mitigation. The party seeking excuse for nonperformance based on Force Majeure shall give written notice to the Owner, if with respect to the Contractor, or to the Contractor if with respect to the Owner, specifying its actual or anticipated duration. Each party seeking excuse from nonperformance based on Force Majeure shall use its best efforts to rectify any condition causing a delay and will cooperate with the other party, except that neither party shall be obligated to incur any unreasonable additional costs and expenses to overcome any loss of time that has resulted.

12.2 Casualty; Actions by Owner and Contractor. During the construction period, if the Project or any part thereof shall have been damaged or destroyed, in whole or in part, the Contractor shall promptly make proof of loss; and Owner and Contractor shall proceed promptly to collect, or cause to be collected, all valid claims which may have arisen against insurers or others based upon such damage or destruction. The Contractor shall diligently assess the damages or destruction and shall prepare an estimate of the cost, expenses, and other charges, including normal and ordinary compensation to the Contractor, necessary for reconstruction of the Project substantially in accordance with the Project Plans and Specifications. Within fifteen (15) days following satisfaction of the express conditions described in subsections (1), (2) and (3) below, the Contractor covenants and agrees diligently to commence reconstruction and to complete the reconstruction or repair of any loss or damage by fire or other casualty to the Project to substantially the same size, floor area, cubic content, and general appearance as prior to such loss or damage:

- (1) Receipt by the Owner or the trustee of the proceeds derived from collection of all valid claims against insurers or others based upon such damage or destruction, and receipt of other sums from any source such that the funds necessary to pay the Project Cost and any additions to the Project Cost necessitated for repair or reconstruction are available;
- (2) Written agreement executed by the Contractor and the Owner, by amendment to the Contract Documents or otherwise, authorizing and approving the repair or reconstruction and any additions to the Project Cost necessitated thereby, including any required adjustment to the Contract Sum; and
- (3) Final approval by the Owner of the Project Plans and Specifications for such repair or reconstruction and issuance of any required building permit.

12.3 Approval of Plans and Specifications. The Owner agrees to approve the plans and specifications for such reconstruction or repair if the reconstruction or repair contemplated by such plans and specifications is economically feasible, and will restore the Project, or the damaged portion thereof, to substantially the same condition as prior to such loss or damage, and such plans

and specifications conform to the applicable laws, ordinances, codes, and regulations. The Owner agrees that all proceeds of any applicable insurance or other proceeds received by the Owner or the Contractor as a result of such loss or damage shall be used for payment of the costs, expenses, and other charges of the reconstruction or repair of the Project.

12.4 Notice of Loss or Damage. The Contractor shall promptly give the Owner written notice of any significant damage or destruction to the Project, defined as loss or damage which it is contemplated by Contractor will increase the Contract Sum or extend the Substantial Completion Date, stating the date on which such damage or destruction occurred, the then expectations of Contractor as to the effect of such damage or destruction on the use of the Project, and the then proposed schedule, if any, for repair or reconstruction of the Project. Loss or damage which the Contractor determines will not affect the Contract Sum or Substantial Completion Date will be reported to Owner and Architect/Engineer immediately, and associated corrective actions will be undertaken without delay.

ARTICLE XIII REPRESENTATIONS, WARRANTIES AND COVENANTS

13.1 Representations and Warranties of Contractor. The Contractor represents and warrants to the Owner each of the following.

A. The Contractor is a construction company, organized under the laws of the State of _____, authorized to transact business in the State of Florida, with _____ as the primary qualifying agent. Contractor has all requisite power and authority to carry on its business as now conducted, to own or hold its properties, and to enter into and perform its obligations hereunder and under each instrument to which it is or will be a party, and is in good standing in the State of Florida.

B. Each Contract Document to which the Contractor is or will be a party constitutes, or when entered into will constitute, a legal, valid, and binding obligation of the Contractor enforceable against the Contractor in accordance with the terms thereof, except as such enforceability may be limited by applicable bankruptcy, insolvency, or similar laws from time to time in effect which affect creditors' rights generally and subject to usual equitable principles in the event that equitable remedies are involved.

C. There are no pending or, to the knowledge of the Contractor, threatened actions or proceedings before any court or administrative agency, within or without the State of Florida, against the Contractor or any partner, officer, or agent of the Contractor which question the validity of any document contemplated hereunder, or which are likely in any case, or in the aggregate, to materially adversely affect the consummation of the transactions contemplated hereunder, or materially adversely affect the financial condition of the Contractor.

D. The Contractor has filed or caused to be filed all federal, state, local, or foreign tax returns, if any, which were required to be filed by the Contractor, and has paid, or caused to be paid, all taxes shown to be due and payable on such returns or on any assessments levied against the Contractor.

E. Neither Contractor nor any agent or person employed or retained by Contractor has acted fraudulently or in bad faith or in violation of any statute or law in the procurement of this Agreement.

F. The Contractor shall timely fulfill or cause to be fulfilled all of the terms and conditions expressed herein which are within the control of the Contractor or which are the responsibility of the Contractor to fulfill. The Contractor shall be solely responsible for the means and methods of construction.

G. It is recognized that neither the Architect/Engineer, the Contractor, nor the Owner has control over the cost of labor, materials, or equipment, over a Subcontractor's methods of determining bid prices, or over competitive bidding, market, or negotiating conditions.

H. During the term of the Contract Documents, and the period of time that the obligations of the Contractor under the Contract Documents shall be in effect, the Contractor shall cause to occur and to continue to be in effect those instruments, documents, certificates, and events contemplated by the Contract Documents that are applicable to, and the responsibility of, the Contractor.

I. The Contractor shall assist and cooperate with the Owner and shall accomplish the construction of the Project in accordance with the Contract Documents and the Project Plans and Specifications, and will not knowingly violate any laws, ordinances, rules, regulations, or orders that are or will be applicable thereto.

J. Contractor warrants and guarantees to Owner that all Work will be in accordance with the Contract Documents and will not be defective, and that Owner, representatives of Owner, and governmental agencies with jurisdictional interests will have access to the Work at reasonable times for their observation, inspecting and testing. Contractor shall give Architect/Engineer timely notice of readiness of the Work for all required approvals and shall assume full responsibility, including costs, in obtaining required tests, inspections, and approval certifications and/or acceptance, unless otherwise stated by Owner.

K. If any Work (including Work of others) that is to be inspected, tested, or approved is covered without written concurrence of Architect/Engineer, it must, if requested by Architect/Engineer, be uncovered for observation. Such uncovering shall be at Contractor's expense unless Contractor has given Architect/Engineer timely notice of Contractor's intention to cover the same and Architect/Engineer has not acted with reasonable promptness in response to such notice. Neither observations by Architect/Engineer nor inspections, tests, or approvals by others shall relieve Contractor from Contractor's obligations to perform the Work in accordance with the Contract Documents.

L. If the Work is defective, or Contractor fails to supply sufficient skilled workers, or suitable materials or equipment, or fails to furnish or perform the Work in such a way that the completed Work will conform to the Contract Documents, Owner may order Contractor to stop the Work, or any portion thereof and terminate payments to the Contractor until the cause for such order has been eliminated. Contractor shall bear all direct, indirect and consequential costs for satisfactory reconstruction or removal and replacement with non-defective Work, including, but not limited to fees and charges of Architect/Engineers, attorneys and other professionals and any additional expenses experienced by Owner due to delays to other

Contractors performing additional Work and an appropriate deductive change order shall be issued. Contractor shall further bear the responsibility for maintaining the schedule and shall not be entitled to an extension of the Contract Time or the recovery of delay damages due to correcting or removing defective Work.

M. If Contractor fails within seven (7) days after written notice to correct defective Work, or fails to perform the Work in accordance with the Contract Documents, or fails to comply with any other provision of the Contract Documents, Owner may correct and remedy any such deficiency to the extent necessary to complete corrective and remedial action. Owner may temporarily exclude Contractor from all or part of the site, temporarily take possession of all or part of the Work, Contractor's tools, construction equipment and machinery at the site or for which Owner has paid Contractor but which are stored elsewhere, all for such duration as is reasonably necessary to correct the deficiency. All direct and indirect costs of Owner in exercising such rights and remedies will be charged against Contractor in an amount approved as to reasonableness by Architect/Engineer and a Change Order will be issued incorporating the necessary revisions.

N. If within three (3) years after the Substantial Completion Date or such longer period of time as may be prescribed by laws or regulations or by the terms of any applicable special guarantee required by the Contract Documents, any Work is found to be defective, Contractor shall promptly, without cost to Owner and in accordance with Owner's written instructions, either correct such defective Work or if it has been rejected by Owner, remove it from the site and replace it with non-defective Work. If Contractor does not promptly comply with the terms of such instruction, Owner may have the defective Work corrected/removed and all direct, indirect and consequential costs of such removal and replacement will be paid by Contractor. Failing payment by the Contractor and notwithstanding any other provisions of the Contract Documents to the contrary, Owner shall have the right to bring a direct action in the Circuit Court to recover such costs.

13.2 Representations of the Owner. To the extent permitted by law, the Owner represents to the Contractor that each of the following statements is presently true and accurate:

- A. The Owner is a validly existing political subdivision of the State of Florida.
- B. The Owner has all requisite corporate or governmental power and authority to carry on its business as now conducted and to perform its obligations under the Contract Documents and each Contract Document contemplated hereunder to which it is or will be a party.
- C. The Contract Documents and each Contract Document contemplated hereby to which the Owner is or will be a party has been duly authorized by all necessary action on the part of, and has been or will be duly executed and delivered by, the Owner, and neither the execution and delivery thereof nor compliance with the terms and provisions thereof or hereof: (a) requires the approval and consent of any other person or party, except such as have been duly obtained or as are specifically noted herein; (b) contravenes any existing law, judgment, governmental rule, regulation or order applicable to or binding on the Owner; or (c) contravenes or results in any breach of, default under, or result in the creation of any lien or encumbrance upon the Owner under any indenture, mortgage, deed of trust, bank loan, or credit agreement, the charter, ordinances, resolutions, or any other agreement or instrument to which the Owner is a

party, specifically including any covenants of any bonds, notes, or other forms of indebtedness of the Owner outstanding on the date of the Contract Documents.

D. The Contract Documents and each document contemplated hereby to which the Owner is or will be a party constitutes, or when entered into will constitute, a legal, valid, and binding obligation of the Owner enforceable against the Owner in accordance with the terms thereof, except as such enforceability may be limited by applicable bankruptcy, insolvency, or similar laws from time to time in effect which affect creditors' rights generally, and subject to usual equitable principles in the event that equitable remedies are involved.

E. There are no pending or, to the knowledge of the Owner, threatened actions or proceedings before any court or administrative agency against the Owner which question the validity of the Contract Documents or any document contemplated hereunder, or which are likely in any case or in the aggregate to materially adversely affect the consummation of the transactions contemplated hereunder or the financial or corporate condition of the Owner.

F. The Owner shall use due diligence to timely fulfill or cause to be fulfilled all of the conditions expressed in the Contract Documents which are within the control of the Owner or which are the responsibility of the Owner to fulfill.

G. During the pendency of the Work and while the obligations of the Owner under the Contract Documents shall be in effect, the Owner shall cause to occur and to continue to be in effect and take such action as may be necessary to enforce those instruments, documents, certificates and events contemplated by the Contract Documents that are applicable to and the responsibility of the Owner.

H. The Owner shall assist and cooperate with the Contractor in accomplishing the construction of the Project in accordance with the Contract Documents and the Project Plans and Specifications, and will not knowingly violate any laws, ordinances, rules, regulations, orders, contracts, or agreements that are or will be applicable thereto or, to the extent permitted by law, enact or adopt any resolution, rule, regulation, or order, or approve or enter into any contract or agreement, including issuing any bonds, notes, or other forms of indebtedness, that will result in the Contract Documents or any part thereof, or any other instrument contemplated by and material to the timely and effective performance of a party's obligations hereunder, to be in violation thereof.

ARTICLE XIV TERMINATION AND SUSPENSION

14.1 Termination for Cause by Owner. This Agreement may be terminated by Owner upon written notice to the Contractor should Contractor fail substantially to perform a material obligation in accordance with the terms of the Contract Documents through no fault of the Owner. In the event Owner terminates for cause and it is later determined by a court of competent jurisdiction that such termination for cause was not justified, then in such event such termination for cause shall automatically be converted to a termination without cause pursuant to Section 14.2.

A. Nonperformance. If the Contractor fails to timely perform any of its

obligations under the Contract Documents, including any obligation the Contractor assumes to perform Work with its own forces, or if it persistently or repeatedly refuses or fails, except in case for which extension of time is provided, to supply enough properly skilled workmen or proper materials, or fails, without being excused, to maintain an established schedule (failure to maintain schedule shall be defined as any activity that falls thirty (30) days or more behind schedule) which has been adopted by the Construction Team, or it fails to make prompt payment to Subcontractors for materials or labor, or disregards laws, rules, ordinances, regulations, or orders of any public authority having jurisdiction, or otherwise is guilty of substantial violations of the Agreement the Owner may, after seven (7) days written notice, during which period the Contractor fails to perform such obligation, make good such deficiencies and perform such actions. The Contract Sum shall be reduced by the cost to the Owner of making good such deficiencies, and the Contractor's compensation shall be reduced by an amount required to manage the making good of such deficiencies. Provided, however, nothing contained herein shall limit or preclude Owner from pursuing additional damages from Contractor because of its breach.

B. Insolvency. If the Contractor is adjudged bankrupt, or if it makes a general assignment for the benefit of its creditors, or if a receiver is appointed because its insolvency, then the Owner may, without prejudice to any other right or remedy, and after giving the Contractor and its surety, if any, fourteen (14) days written notice, and during which period the Contractor fails to cure the violation, terminate the Agreement. In such case, the Contractor shall not be entitled to receive any further payment. Owner shall be entitled to recover all costs and damages arising because of failure of Contractor to perform as provided in the Contract Documents, as well as reasonable termination expenses, and costs and damages incurred by the Owner may be deducted from any payments left owing the Contractor.

C. Illegality. Owner may terminate the Agreement if Contractor disregards laws or regulations of any public body having jurisdiction.

D. Rights of Owner. The Owner may, after giving Contractor (and the surety, if there is one) seven (7) days written notice, terminate the services of Contractor for cause; exclude Contractor from the Project Site and take possession of the Work and of all Contractor's tools, construction equipment and machinery at the Project Site and use the same to the full extent they could be used (without liability to Contractor for trespass or conversion); incorporate in the Work all materials and equipment stored at the Project Site or for which Owner has paid Contractor but which are stored elsewhere, and finish the Work as Owner may deem expedient. In such case, Contractor shall not be entitled to receive any further payment beyond an amount equal to the value of material and equipment not incorporated in the Work, but delivered and suitably stored, less the aggregate of payments previously made. If the direct and indirect costs of completing the Work exceed the unpaid balance of the Contract Sum, Contractor shall pay the difference to Owner. Such costs incurred by Owner shall be verified by Owner in writing; but in finishing the Work, Owner shall not be required to obtain the lowest quote for the Work performed. Contractor's obligations to pay the difference between such costs and such unpaid balance shall survive termination of the Agreement. In such event and notwithstanding any other provisions of the Contract Documents to the contrary, Owner shall be entitled to bring a direct action in the Circuit Court to recover such costs.

14.2 Termination without Cause by Owner. The Owner, through its County Administrator or designee, shall have the right to terminate the Agreement, in whole or in part, without cause upon sixty (60) calendar days' written notice to the Contractor. In the event of

such termination for convenience, the Owner shall compensate Contractor for payments due through the date of termination, and one subsequent payment to cover costs of Work performed through the date of termination, subject to the terms and conditions of Section 3.1. The Contractor shall not be entitled to any other further recovery against the Owner, including, but not limited to, anticipated fees or profit on Work not required to be performed, or consequential damages or costs resulting from such termination.

A. Release of Contractor. As a condition of Owner's termination rights provided for in this subsection, Contractor shall be released and discharged from all obligations arising by, through, or under the terms of the Contract Documents, and the Payment and Performance Bond shall be released. Owner shall assume and become responsible for the reasonable value of Work performed by Subcontractors prior to termination plus reasonable direct close-out costs, but in no event shall Subcontractors be entitled to unabsorbed overhead, anticipatory profits, or damages for early termination.

B. Waiver of Protest. Contractor hereby waives any right to protest the exercise by Owner of its rights under this Section that may apply under the Procurement Ordinance.

14.3 Suspension without Cause. Owner may, at any time and without cause, suspend the Work or any portion thereof for a period of not more than ninety (90) days by written notice to Contractor, which will fix the date on which Work will be resumed. Contractor shall be allowed an increase in the Contract Sum or an extension of the Contract Time, or both, directly attributable to any suspension if Contractor makes an approved claim therefor.

14.4 Termination Based Upon Abandonment, Casualty or Force Majeure. If, after the construction commencement date (i) Contractor abandons the Project (which for purposes of this paragraph shall mean the cessation of all construction and other activities relating to the Project, excluding those which are necessary to wind down or otherwise terminate all outstanding obligations with respect to the Project, and no recommencement of same within one hundred twenty (120) days following the date of cessation), or (ii) the Project is stopped for a period of thirty (30) consecutive days due to an instance of Force Majeure or the result of a casualty resulting in a loss that cannot be corrected or restored within one hundred twenty (120) days (excluding the time required to assess the damage and complete the steps contemplated under Section 12.2), the Owner shall have the right to terminate the Agreement and pay the Contractor its compensation earned or accrued to date.

14.5 Vacation of Project Site; Delivery of Documents. Upon termination by Owner pursuant to Section 14.2 or 14.4, Contractor shall withdraw its employees and its equipment, if any, from the Project Site on the effective date of the termination as specified in the notice of termination (which effective date shall not be less than two (2) working days after the date of delivery of the notice), regardless of any claim the Contractor may or may not have against the Owner. Upon termination, the Contractor shall deliver to the Owner all original papers, records, documents, drawings, models and other material set forth and described in the Contract Documents.

14.6 Termination by the Contractor. If, through no act or fault of Contractor, the

Work is suspended for a period of more than ninety (90) consecutive days by Owner or under an order of court or other public authority, or Owner fails to act on any Application for Payment or fails to pay Contractor any sum finally determined to be due; then Contractor may, upon fourteen (14) days written notice to Owner terminate the Agreement and recover from Owner payment for all Work executed, any expense sustained plus reasonable termination expenses. In lieu of terminating the Agreement, if Owner has failed to act on any Application for Payment or Owner has failed to make any payment as aforesaid, Contractor may upon fourteen (14) days written notice to Owner stop the Work until payment of all amounts then due.

SAMPLE

Exhibit A
Title(s) of Drawings

SAMPLE

Exhibit B
Title(s) of Specifications

SAMPLE

Exhibit C
Affidavit of No Conflict

SAMPLE

Exhibit D
Contractor's Certificate(s) of Insurance

SAMPLE

Exhibit E
Contractor's Payment and Performance Bond

SAMPLE

Exhibit F
Standard Forms

SAMPLE

APPLICATION FOR PAYMENT

Request No.: _____ Project No.: _____
 Purchase Order No.: _____
 County Bid No.: _____
 Consultant: _____

Project: _____
 From: _____ To: _____

CONTRACT PAYMENT SUMMARY

| | | | | | |
|--|---------------|-----------------|-----------|----|---|
| Original Contract Amount: | | | | \$ | - |
| Change Order(s): | | | | \$ | - |
| Change order summary: | | | | | |
| Number | Date Approved | Additive | Deductive | | |
| | | | | | |
| | | | | | |
| | | | | | |
| | | | | | |
| | | | | | |
| SUBTOTALS: | | \$ | - | \$ | - |
| Net change order subtotal (Additive less Deductive): | | | | \$ | - |
| Current Contract Amount (CCA): (Original Amount + Change Order(s)) | | | | \$ | - |
| | | Previous Status | Total WIP | | |
| Value of the Work in Place (WIP) | \$ | - | \$ | - | |
| Value of Stored Materials | \$ | - | \$ | - | |
| Total Earned (\$ and % of CCA) | \$ | - | \$ | - | |
| Retainage (\$ and % of CCA) | \$ | - | \$ | - | |
| Net Earned (Total earned minus retainage) | | | | \$ | - |
| TOTAL PREVIOUS PAYMENTS | | | | \$ | - |
| AMOUNT DUE THIS PAYMENT (Net Earned minus Previous Payments) | | | | \$ | - |

CONTRACTOR'S AFFIDAVIT OF NOTICE

CERTIFICATE: The undersigned CONTRACTOR certifies that all items and amounts shown on this Application for Payment are on account of work performed, materials supplied and/or materials stored on site and paid for by Contractor in accordance with the Contract Documents with due consideration for previous Payment(s), if any, received by the Contractor from the County, and that the Amount Due this Payment shown is now due.

NOTARY:

CONTRACTOR:

State of Florida, County of _____

 Name of person authorized to sign Affidavit of Notice

Sworn to (or affirmed) and subscribed before me this _____ day of _____ by

 TITLE

 (Name of person giving notice)

Contractor name, address and telephone no.:

 (Signature of Notary Public - State of Florida)

Print, Type or Stamp Commissioned Name of Notary Public:

Personally Known _____ or Produced Identification _____

Type of Identification Produced: _____

VERIFICATION, RECOMMENDATION, CONCURRENCES AND APPROVALS

(Signatures)

(Date)

Quantities verified by: _____

Consultant/Engineer: _____

Project Management: _____

Department Head: _____

Payment approved by the Board of County Commissioners: _____

Attested to by the Clerk of Circuit Court: _____

**FINAL RECONCILIATION, WARRANTY PERIOD DECLARATION
AND CONTRACTOR'S AFFIDAVIT**

| | |
|----------------|-----------------|
| Project Title: | Date Submitted: |
|----------------|-----------------|

| | |
|--|--------------------|
| Contractor Data: Name: Address: City/State/Zip: | Project No: |
| | Warranty (months): |

This Final Reconciliation is for the work performed for Manatee County by the above named contractor, hereinafter called CONTRACTOR, pursuant to the contract dated _____ as amended, and acts as an addendum thereto.

It is agreed that all quantities and prices in the attached Final Pay Estimate No. _____ are correct and that the amount of \$ _____ including retainage is due to the CONTRACTOR, that no claims are outstanding as between the parties, and that the above stated sum represents the entirety of monies owed the CONTRACTOR.

It is further agreed that the warranty period for CONTRACTOR'S work pursuant to the Contract is from _____ to _____

As (title) _____ for CONTRACTOR, I have authority to bind said CONTRACTOR, and as such make this final reconciliation, declaration and affidavit for the purpose of inducing Manatee County to make final payment to CONTRACTOR for work done at/upon _____ under said contract:

CONTRACTOR has paid all social security and withholding taxes accrued in connection with the construction project.

CONTRACTOR has paid all workers' compensation and other insurance premiums incurred in connection with this construction project.

CONTRACTOR has paid for all required permits in connection with this construction project.

All laborers, material, men, suppliers, subcontractors and service professionals who worked for and/or supplied materials, equipment and/or services to the CONTRACTOR under this construction contract have been paid in full.

(Affiant Signature)

NOTARY:
State of Florida, County of _____, Sworn to (or affirmed) and subscribed before me this _____ day of _____, _____, by _____ (person giving notice).

Signature of Notary Public - State of Florida: _____
Print, Type or Stamp Commissioned Name of Notary Public:

Personally Known or Produced Identification
Type of Identification Produced _____

CONTRACT CHANGE ORDER

(for Total Contract Adjusted Amount Greater than \$1,000,000)

PROJECT: _____

Change Order No.: _____

**Contract Amount
(Present Value)** _____

Project Number: _____

| NO. OF ITEM | DESCRIPTION OF ITEM AND CHANGE | DECREASE | INCREASE |
|-------------|--------------------------------|----------|----------|
| | | | |

BY EXECUTION OF THIS CHANGE ORDER THE CONTRACTOR AGREES THAT ALL CLAIMS FOR ADDITIONAL CONTRACT TIME AND FEES FOR THE ITEMS IN THIS CHANGE ORDER HAVE BEEN SATISFIED.

TOTAL DECREASE: _____

TOTAL INCREASE: _____

Contractor: _____
Address: _____
City / State: _____

THE NET CHANGE OF
 ADJUSTS THE CURRENT CONTRACT AMOUNT FROM
 _____ TO

Contractor Signature: _____ **Date:** _____

____ CALENDAR DAYS ARE ADDED TO THE SCHEDULE
 WHICH CHANGES THE FINAL COMPLETION DATE TO
 _____ MONTH _____ DAY, _____ YEAR

RECOMMENDATION, CONCURRENCES AND APPROVALS

SIGNATURES

DATE

Consultant / Engineer: _____

Project Manager: _____

Division Manager: _____

Project Management Division Manager

Manatee County Purchasing: _____

Purchasing Official

Authority to execute this contract per Manatee County Code, Chapter 2-26,
 and per the delegation by the County Administrator effective 1/26/2009

JUSTIFICATION FOR CHANGE

Change Order No :

Project Number:

1. NECESSITY FOR CHANGE:



2. Is change an alternate bid? (If yes, explain)

3. Does change substantially alter the physical size of the project? (If yes, explain)

4 Effect of this change on other "Prime" contractors?

5 Has the Surety and insurance company been notified, if applicable? CONTRACTOR RESPONSIBILITY