



**INVITATION FOR BID
(IFB) #10-2869-DS
Washington Gardens- Waterline Improvements
Project File: 404.6076770**

Manatee County, a political subdivision of the State of Florida, (hereinafter the "County") will receive sealed bids from individuals, corporations, partnerships, and other legal entities organized under the laws of the State of Florida or authorized to conduct business in the State of Florida.

NON-MANDATORY INFORMATION CONFERENCE

In order to insure that all prospective bidders have sufficient information and understanding of the County's needs, an Information Conference will be held **August 13, 2010 @ 3:00 PM at the Manatee County Public Works Department, Project Management Division, (Conference Room A) located at 1022 26th Avenue East, Bradenton, FL 34208.** Attendance is not mandatory, but is highly encouraged.

NOTE: Article B. 05, page 00200-2; Inspection of Site - All potential contractors shall visit the site to familiarize themselves with the full scope of the construction site.

DEADLINE FOR CLARIFICATION REQUESTS: Sept 9th, 2010 at 2:00 PM
(Reference Bid Article A.06)

TIME AND DATE DUE: September 24, 2010 at 3:00 PM
Manatee County Purchasing, 1112 Manatee Avenue West, Suite 803, Bradenton, FL 34205.

Important Note: Lobbying is prohibited (reference Bid Article A.08)

FOR INFORMATION CONTACT:
Donna M. Stevens (941) 708-7528
donna.stevens@mymanatee.org
AUTHORIZED FOR RELEASE: 

TABLE OF CONTENTS

00010 Information to Bidders.....	00010-1-10
00020 Basis of Award.....	00020-1 - 2
00030 Terms and Conditions.....	00030-1 - 8
00100 Bid Summary	00100-1 - 4
00150 Manatee County Local Preference.....	00150-1 - 4
00300 Bid Form	00300-1 - 7
00430 Contractor's Questionnaire	00430-1 - 4
00491 Certification Forms.....	00491-1 - 5
00500 Form of Agreement.....	00500-1 - 5
00700 General Conditions.....	00700-1- 18
Plan Set	20 pages
Contract Documents.....	173 pages

SECTION 00010
INFORMATION TO BIDDERS

A.01 OPENING LOCATION

These bids will be **publicly opened** at **Manatee County Purchasing, 1112 Manatee Avenue West, Suite 803, Bradenton, Florida 34205** in the presence of County officials at the time and date stated, or soon thereafter. All bidders or their representatives are invited to be present.

Any bids received after the stated time and date will not be considered. It shall be the sole responsibility of the bidder to have their bid delivered to the Manatee County Purchasing Division for receipt on or before the stated time and date. If a bid is sent by U.S. Mail, the bidder shall be responsible for its timely delivery to the Purchasing Division. Bids delayed by mail shall not be considered, shall not be opened at the public opening, and arrangements shall be made for their return at the respondent's request and expense.

A.02 SEALED & MARKED

One original and two copies of your **signed bid** shall be submitted in one sealed package, clearly marked on the outside "**Sealed Bid #10-2869-DS, Washington Gardens- Waterline Improvements** with your company name.

Address package to: Manatee County Purchasing Division
1112 Manatee Avenue West, Suite 803
Bradenton, Florida 34205

A.03 SECURING OF DOCUMENTS

Complete individual copies of the bidding documents for the project and/or products can be obtained, free of charge, at the Manatee County Public Works Department located at: 1022 26th Avenue East, Bradenton, FL 34208, phone **941-708-7450, extension 7420 or 7334** between the hours of 8:00 AM to 4:00 PM, Monday through Friday, exception of holidays. Complete set of the bidding document must be used in preparing bids. The County assumes no responsibility for errors and misinterpretations resulting from the use of incomplete sets of bidding document.

A.04 BID DOCUMENTS

Bids on <http://www.mymanatee.org> , Bid documents and the Notices of Source Selection related to those Bids are available for download in a portable document format (.PDF) file on the Manatee County web page on the Purchasing tab under "Bids." You may view and print these files using Adobe Acrobat software. You may download a free copy of this software (Adobe) from the Owner's web page if you do not have it. **Manatee County collaborates with the Manatee Chamber of Commerce** on distributing solicitations using the RFP Tool web page on the Chambers website: <http://www.ManateeChamber.com> to post Bid documents in a portable document

A.04 BID DOCUMENTS (Continued)

format (.PDF) file. This step is in addition to the posting on Manatee County Government web pages.

Manatee County may also use an internet service provider to distribute Bids. A link to that service, <http://www.DemandStar.com>, is provided on this website under the Tab "DemandStar". Participation in the DemandStar system is not a requirement for doing business with Manatee County.

Note: The County posts the Notice of Source Selection seven calendar days prior to the effective date of the award.

IT IS THE RESPONSIBILITY OF EACH VENDOR, PRIOR TO SUBMITTING THEIR BID, TO CONTACT THE MANATEE COUNTY PURCHASING OFFICE (see contact information on page one of this document) TO DETERMINE IF ADDENDA WERE ISSUED AND TO MAKE SUCH ADDENDA A PART OF THEIR BID .

A.05 MODIFICATION OF BID SPECIFICATIONS

If a bidder wishes to recommend changes to the bid specifications, the bidder shall furnish in writing, data and information necessary to aid the Owner in evaluating the request to modify the specifications. The Owner is not obligated to make any changes to the bid specifications. Unless an addendum is issued, the bid specifications shall remain unaltered. **Bidders must fully comply with the bid specifications, terms, and conditions.**

A.06 DEADLINE FOR CLARIFICATION REQUESTS

Sept. 9th, 2010 at 2:00 PM shall be the deadline to submit all inquiries, suggestions, or requests concerning interpretation, clarification or additional information pertaining to the Invitation for Bids to the Manatee County Purchasing Office.

This deadline has been established to maintain fair treatment for all potential bidders, while maintaining the expedited nature of the Economic Stimulus that the contracting of this work may achieve.

A.07 CLARIFICATION & ADDENDA

Each bidder shall examine all Invitation For Bid documents and shall judge all matters relating to the adequacy and accuracy of such documents. Any inquiries, suggestions or requests concerning interpretation, clarification or additional information pertaining to the Invitation for Bids shall be made through the Manatee County Purchasing Office. The County shall not be responsible for oral interpretations given by any County employee, representative, or others. The issuance of a written addendum is the only official method whereby interpretation, clarification or additional information can be given.

A.07 CLARIFICATION & ADDENDA (Continued)

If any addenda are issued to this Invitation for Bid, the County will Broadcast the addenda on the Demand Star distribution system to "Planholders" on this web service, and post the documents on the Purchasing Division's web page at <http://www.myanatee.org> which can be accessed by clicking on the "Purchasing" button and then clicking on the "Bids" button. It shall be the responsibility of each bidder, prior to submitting their bid, to contact Manatee County Purchasing (see contact on page 1) to determine if addenda were issued and to make such addenda a part of their bid.

A.08 LOBBYING

After the issuance of any Invitation For Bid, prospective bidders, or any agent, representative or person acting at the request of such bidder shall not contact, communicate with or discuss any matter relating in any way to the Invitation For Bid with any officer, agent or employee of Manatee County other than the Purchasing Official or as directed in the Invitation For Bid. This prohibition begins with the issuance of any Invitation For Bid, and ends upon execution of the final contract or when the invitation has been canceled. Violators of this prohibition shall be subject to sanctions as provided in the Manatee County Purchasing Code.

The County reserves the right to amend or to add to the names listed as persons to contact. All amendments or additions to the names listed as persons to contact shall be issued by the Purchasing Division, in writing.

A.09 UNBALANCED BIDDING PROHIBITED

Manatee County recognizes that large and/or complex projects will often result in a variety of methods, sources and prices; however, where in the opinion of the County such variation does not appear to be justified, given bid specifications and industry and market conditions, the bid will be presumed to be unbalanced. Examples of unbalanced bids will include:

1. Bids showing omissions, alterations of form, additions not specified or required conditional or unauthorized alternate bids.
2. Bids quoting prices that substantially deviate, either higher or lower, from those included in the bids of competitive bidders for the same line item unit costs.
3. Bids where the unit costs offered are in excess of or below reasonable cost analysis values.

In the event the County determines that a bid is presumed unbalanced, it will request the opportunity to, and reserves the right to, review all source quotes, bids, price lists, letters of intent, etc., which the bidder obtained and upon which the bidder relied upon to develop the bid. The County reserves the right to reject as non-responsive any

A.09 UNBALANCED BIDDING PROHIBITED (Continued)

presumptive unbalanced bids where the bidder is unable to demonstrate the validity and/or necessity of the unbalanced unit costs.

A.10 FRONT END LOADING OF BID PRICING PROHIBITED

Prices offered for performance and/or acquisition activities to occur early in the project schedule, such as: mobilization, clearing and grubbing; or maintenance of traffic, that are substantially higher than pricing of competitive bidders within the same portion of the project schedule, will be presumed to be front end loaded. Front end loaded bids could reasonably appear to be an attempt to obtain unjustified early payments creating a risk of insufficient incentive for the Contractor to complete the work or otherwise creating an appearance of an under-capitalized bidder.

In the event the County determines that a bid is presumed to be front end loaded, it will request the opportunity to, and reserves the right to, review all source quotes, bids, price lists, letters of intent, etc., which the bidder obtained and upon which the bidder relied upon to develop the pricing or acquisition timing for these bid items. The County reserves the right to reject as non-responsive any presumptive front end loaded bids where the bidder is unable to demonstrate the validity and/or necessity of the front end loaded costs.

A.11 WITHDRAWAL OF OFFERS

Vendors may withdraw offers as follows: a) Mistakes discovered before the opening of a solicitation may be withdrawn by written notice from the bidder submitting the offer. This request must be received in the office designated for receipt of offers in the solicitation document prior to the time set for delivery and opening of the offers. A copy of the request shall be retained and the unopened offer returned to that vendor. b) After the responses to a solicitation are opened or a selection has been determined, but before a contract is signed, a vendor alleging a material mistake of fact may be permitted to withdraw their offer if: (1) the mistake is clearly evident on the solicitation document; or (2) the bidder submits evidence which clearly and convincingly demonstrates that a mistake was made. Request to withdraw an offer must be in writing and approved by the Purchasing Official.

A.12 IRREVOCABLE OFFER

Any bid may be withdrawn up until the date and time set for opening of the bid. Any bid not so withdrawn shall, upon opening, constitute an irrevocable offer for a period of 90 days to sell to Manatee County the goods or services set forth in the attached specifications until one or more of the bids have been duly accepted by the County.

A.13 BID EXPENSES

All expenses for making bids to the County are to be borne by the bidder.

A.14 RESERVED RIGHTS

The County reserves the right to accept or reject any and/or all bids, to waive irregularities and technicalities, and to request resubmission. Also, the County reserves the right to accept all or any part of the bid and to increase or decrease quantities to meet additional or reduced requirements of the County. Any sole response received by the first submission date may or may not be rejected by the County depending on available competition and current needs of the County. For all items combined, the bid of the lowest responsive, responsible bidder will be accepted, unless all bids are rejected. The lowest responsible bidder shall mean **that bidder who makes the lowest bid to sell goods and/or services of a quality which** conforms closest to or most exceeds the quality of goods and/or services set forth in the attached specifications or otherwise required by the County, and who is fit and capable to perform the bid as made.

To be responsive, a bidder shall submit a bid which conforms in all material respects to the requirements set forth in the Invitation For Bid. To be a responsible bidder, the bidder shall have the capability in all respects to perform fully the contract requirements, and the tenacity, perseverance, experience, integrity, reliability, capacity, facilities, equipment, and credit which will assure good faith performance. Also, the County reserves the right to make such investigation as it deems necessary to determine the ability of any bidder to furnish the service requested. Information the County deems necessary to make this determination shall be provided by the bidder. Such information may include, but shall not be limited to: current financial statements, verification of availability of equipment and personnel, and past performance records.

A.15 APPLICABLE LAWS

Bidder must be authorized to transact business in the State of Florida. All applicable laws and regulations of the State of Florida and ordinances and regulations of Manatee County will apply to any resulting agreement. Any involvement with any Manatee County procurement shall be in accordance with Manatee County Purchasing Code of Laws as amended. Any actual or prospective bidder who is aggrieved in connection with the solicitation or award of a contract may protest to the Board of County Commissioners of Manatee County as required in Section 2-26/61 of the Purchasing Code.

A protest with respect to this Invitation For Bid shall be submitted in writing prior to the scheduled opening date of this bid, unless the aggrieved person did not know and could not have been reasonably expected to have knowledge of the facts giving rise to such protest prior to the scheduled opening date of this bid. The protest shall be submitted within seven calendar days after such aggrieved person knows or could have reasonably been expected to know of the facts giving rise thereto.

A.16 COLLUSION

By offering a submission to this Invitation For Bid, the bidder certifies that he has not divulged, discussed or compared their bid with other bidder, and has not colluded with any other bidder or parties to this bid whatsoever. Also, bidder certifies, and in the case

A.16 COLLUSION (Continued)

of a joint bid each party thereto certifies as to their own organization, that in connection with this bid:

- a. any prices and/or cost data submitted have been arrived at independently, without consultation, communication, or agreement, for the purpose of restricting competition, as to any matter relating to such prices and/or cost data, with any other bidder or with any competitor;
- b. any prices and/or cost data quoted for this bid have not been knowingly disclosed by the bidder and will not knowingly be disclosed by the bidder, prior to the scheduled opening, directly or indirectly to any other bidder or to any competitor;
- c. no attempt has been made or will be made by the bidder to induce any other person or firm to submit or not to submit a bid for the purpose of restricting competition;
- d. the only person or persons interested in this bid, principal or principals is/are named therein and that no person other than therein mentioned has any interest in this bid or in the contract to be entered into; and
- e. no person or agency has been employed or retained to solicit or secure this contract upon an agreement or understanding or a commission, percentage, brokerage, or contingent fee excepting bona fide employees or established commercial agencies maintained by bidder for purpose of doing business.

A.17 CODE OF ETHICS

With respect to this bid, if any bidder violates or is a party to a violation of the Code of Ethics of Manatee County per Manatee County Purchasing Code of Laws, Article 3, Ethics in Public Contracting, and/or the State of Florida per Florida Statutes, Chapter 112, Part III, Code of Ethics for Public Officers and Employees, such bidder may be disqualified from performing the work described in this bid or from furnishing the goods or services for which the bid is submitted and shall be further disqualified from submitting any future bids for work or for goods or services for Manatee County. The Owner anticipates that all statements made and materials submitted in a bid will be truthful. If a bidder is determined to be untruthful in its bid or any related presentation, such bidder may be disqualified from further consideration regarding this Invitation For Bid.

A.18 BID FORMS

Bids must be submitted on attached County forms, although additional pages may be attached.- **Bidders must fully complete all pages of the Bid Forms for both Bid A and Bid B. Bid Forms must be executed by an authorized signatory who has the legal authority to make the offer and bind the company. Bidders must fully comply with all bid specifications, terms and conditions.** Failure to comply shall result in contract default, whereupon, the defaulting vendor shall be required to pay for any and all re-procurement costs, damages, and attorney fees as incurred by the County.

A.19 LEGAL NAME

Bids shall clearly indicate the legal name, address and telephone number of the bidder. Bids shall be signed above the typed or printed name and title of the signer. **The signer must have the authority to bind the bidder to the submitted bid.**

A.20 DRUG FREE WORK PLACE

The Manatee County Board of County Commissioners adopted a policy regarding bidders maintaining a Drug Free Work Place, prohibiting the award of bids to any person or entity that has not submitted written certification to the County that it has complied with those requirements. A Drug Free Work Place Certification Form is attached to this bid for this purpose.

A.21 PUBLIC CONTRACTING AND ENVIRONMENTAL CRIMES

A person or affiliate who has been placed on the State's convicted vendor list following a conviction for a public entity crime, as that term is defined in Florida Statute § 287.133, may not submit a bid, proposal, or reply on a contract to provide any goods or services to a public entity; may not submit a bid, proposal, or reply on a contract with a public entity for the construction or repair of a public building or public work; may not submit bids, proposals or replies on leases of real property to a public entity; may not be awarded or perform work as a contractor, supplier, subcontractor, or consultant under a contract with any public entity; and may not transact business with any public entity in excess of the threshold amount provided in Florida Statute § 287.017 for CATEGORY TWO for a period of 36 months following the date of being placed on the convicted list.

In addition, the Manatee County Code prohibits the award of any contract to any person or entity who/which has, within the past 5 years, been convicted of, or admitted to in court or sworn to under oath, a public entity crime or of any environmental law that, in the reasonable opinion of the purchasing official, establishes reasonable grounds to believe the person or business entity will not conduct business in a responsible matter. To insure compliance with the foregoing, the Code requires all persons or entities desiring to contract with the County to execute and file with the purchasing official an affidavit, executed under the pain and penalties of perjury, confirming that person, entity and any person(s) affiliated with the entity, does not have such a record and is therefore eligible to seek and be awarded business with the County. In the case of a business entity other than a partnership or a corporation, such affidavit shall be executed by an authorized agent of the entity. In the case of a partnership, such affidavit shall be executed by the general partner(s). A Public Contracting and Environmental Crimes Certification is attached for this purpose.

A.22 DISCOUNTS

Any and all discounts must be incorporated in the prices contained in the bid and not shown separately. The prices as shown on the bid form shall be the price used in determining award.

A.23 TAXES

Manatee County is exempt from Federal Excise and State Sales Taxes. (F.E.T. Exempt Cert. No. 59-78-0089K; FL Sales Tax Exempt Cert. No. 85-8012622206C-6); therefore, the vendor is prohibited from delineating a separate line item in his bid for any sales or service taxes. Nothing herein shall affect the vendor's normal tax liability.

A.24 DESCRIPTIVE INFORMATION

Unless otherwise specifically provided in the specifications, all equipment, materials and articles incorporated in the work covered by this contract shall be new and of the most suitable grade for the purpose intended. Unless otherwise specifically provided in the specifications, reference to any equipment, material, article or patented process, by trade name, brand name, make or catalog number, shall be regarded as establishing a standard of quality and shall not be construed as limiting competition.

A.25 AMERICANS WITH DISABILITIES ACT

The Board of County Commissioners of Manatee County, Florida, does not discriminate upon the basis of any individual's disability status. This non-discrimination policy involves every aspect of the County's functions including one's access to, participation, employment, or treatment in its programs or activities. Anyone requiring reasonable accommodation for an **Information Conference** or **Bid Opening** should contact the person named on the first page of this bid document at least twenty-four (24) hours in advance of either activity.

A.26 EQUAL EMPLOYMENT OPPORTUNITY CLAUSE

Manatee County, in accordance with the provisions of Title VI of the Civil Rights Act of 1964 and the Regulations of the Department of Commerce (15 CFR, Part 8) issued pursuant to such Act, hereby notifies all vendors that it will affirmatively ensure that in any contract entered into pursuant to this advertisement, minority business enterprises will be afforded full opportunity to submit bids in response to this advertisement and will not be discriminated against on the grounds of race, color or national origin in consideration for an award.

A.27 MBE/WBE

The State of Florida, **Office of Supplier Diversity** provides the certification process and the database for identifying certified MBE/WBE firms. This service may be directly accessed at: <http://www.osd.dms.state.fl.us/iframe.htm>

If you have any questions regarding this State service, please contact their office at (850) 487-0915.

A.28 MATHEMATICAL ERRORS

In the event of multiplication/extension error(s), the unit price shall prevail. In the event of addition error(s) the extension totals will prevail. All bids shall be reviewed mathematically and corrected, if necessary, using these standards, prior to additional evaluation.

A.29 DISCLOSURE

Upon receipt, all inquires and responses to inquires related to this Invitation for Bid become "Public Records" and are subject to public disclosure consistent with Chapter 119, Florida Statutes.

Bids become "Public Records" ten (10) days after the bid opening or if an award decision is made earlier than this time as provided by Florida Statue 119.071. No announcement or review of the bid documents shall be conducted at the public opening of the bids.

Based on the above, Manatee County will receive bids at the date and time stated, and will make public at the opening the names of the business entities of all that submitted an offer and any amount presented as a total offer without any verification of the mathematics or the completeness of the offer. Upon the expiration of the statutory term for exemption the actual documents may be inspected or copied. When County staff have completed a mathematic validation and inspected the completeness of the offers, tabulation shall be posted on www.mymanatee.org.

NOTE: ANY OR ALL STATEMENTS CONTAINED IN THE FOLLOWING SECTIONS: BASIS OF AWARD, TERMS AND CONDITIONS OF THE CONTRACT, OR SPECIFICATIONS, WHICH VARY FROM THE INFORMATION TO BIDDERS, SHALL HAVE PRECEDENCE.

END OF SECTION A

SECTION 00020
BASIS OF AWARD

B.01 BASIS OF AWARD

Award shall be to the most responsive, responsible bidder meeting specifications and having the lowest Total Bid Price for **Bid "A"**, or the lowest Total Bid Price for **Bid "B"**, for the requirements listed on the Bid Form for the Work as set forth in this Invitation For Bid. Bid Prices shall include costs for furnishing all labor, equipment and/or materials for the completion of the Work in accordance with and in the manner set forth and described in the Contract Documents to the County's satisfaction within the prescribed time.

Two schedules for Completion of the Work shall be considered. Each bid for completion by the specified stated time shall be offered as a separate "Total Bid Price". The County has the sole authority to select the bid based on the Completion Time which is in the best interest of the County. Only one award shall be made.

In evaluating bids, the County shall consider the qualifications of the bidders; and if required, may also consider the qualifications of the subcontractors, suppliers, and other persons and organizations proposed. County may also consider the operating costs, maintenance requirements, performance data and guarantees of major items of materials and equipment proposed for incorporation in the Work.

Whenever two or more bids are equal with respect to price, quality and service, the bid received from a local business shall be given preference in award. Whenever two or more bids which are equal with respect to price, quality and service are received, and both bids and neither of these bids are received from a local business, the award shall be determined by a chance drawing conducted by the Purchasing Office and open to the public.

Local business is defined as a business duly licensed and authorized to engage in the sale of goods and/or services to be procured, which has a place of business in Manatee County with full time employees at that location.

B.02 SUBCONTRACTORS

Subcontractors shall be bound by the terms and conditions of this contract insofar as it applies to their Work, but this shall not relieve the prime contractor from the full responsibility of the County for the proper completion of all Work to be executed under this contract.

The employment of unauthorized aliens by any vendor is considered a violation of Section 274 (e) of the Immigration and Employment Act. If the vendor knowingly employs unauthorized aliens, such violation shall be cause for unilateral cancellation of this agreement.

B.03 QUALIFICATIONS OF BIDDERS

Each bidder must secure all licenses required (in accordance with Chapter 489 Florida Statutes) for the Work which is the subject of this bid; and, upon request, shall submit a true copy of all applicable licenses. The minimum license requirements for this project are a **Certified General Contractors license or an Underground Utility Contractors license.**

To demonstrate qualifications to perform the Work, each bidder must be prepared to submit within five days of County's request; written evidence such as financial data, previous experience, present commitments and other such data as may be requested. Bidder must be able to provide evidence of Bidder's qualification to do business in the state of Florida. Each bidder shall submit as a portion of their bid, a completed Contractor's Questionnaire included as Section 00430.

A complete list of all subcontractors proposed for any portion of the Work may be requested of any Bidder deemed necessary by the County. Subcontracts shall be awarded only to those subcontractors considered satisfactory by the County.

B.04 PREPARATION OF CONTRACT

A written notice confirming award or recommendation thereof will be forwarded to the Successful Bidder accompanied by the required number of unsigned counterparts of the Agreement. Within 10 days thereafter, Successful Bidder shall sign and deliver the required number of counterparts of the Agreement with any other required documents to County. (Note: Contract must be approved in accordance with the Manatee County Code of Laws, Chapter 2-26, Manatee County Purchasing Ordinance and the Standard and Procedures approved by the County Administrator).

B.05 INSPECTION OF SITE

Prior to submitting a Bid Form, each bidder shall examine the site and all conditions thereon fully familiarizing themselves with the full scope of the project. Prior to a Bid Form, each bidder shall examine the site and all conditions thereon fully familiarizing themselves with the full scope of the project. Failure to become familiar with site conditions will in no way relieve the successful bidder from the necessity of furnishing any materials or performing any work that is required to complete the project in accordance with the plans and specifications.

END OF SECTION B

SECTION 00030
GENERAL TERMS AND CONDITIONS OF THE CONTRACT

C.01 CONTRACT FORMS

The agreement resulting from the acceptance of a bid shall be in the form of the agreement stated in this bid.

C.02 ASSIGNMENT OF CONTRACT

Contractor shall not assign, transfer, convey, sublet or otherwise dispose of this Contract or of his right, title, or interest therein, or his power to execute such Contract, or to assign any monies due or to become due there under to any other person, firm or corporation unless first obtaining the written consent of the County. The giving of such consent to a particular subcontractor assignment shall not dispense with the necessity of such consent to any further or other assignment.

C.03 COMPLETION OF WORK

The Work will be completed and ready for final inspection within the specified calendar days from the date the Contract Time commences to run. Two bids shall be considered based on **Bid "A" 225 calendar days** and **Bid "B" based on 275 calendar days**. The County has the sole authority to select the bid based on the Completion Time which is in the best interest of the County. Only one award shall be made.

C.04 LIQUIDATED DAMAGES

If the Contractor refuses or fails to prosecute the Work, or any separable part thereof, with such diligence as will hinder its completion within the time specified, the County may seek damages. The actual damages for delay will be impossible to determine and in lieu thereof, the Contractor shall pay to the County the sum of **\$1,148.00** as fixed, agreed, and liquidated damages for each calendar day of the delay until the Work is finally accepted by the County and the Contractor and his Surety shall be liable for the amount thereof.

C.05 PAYMENT

Contractor may apply for partial payment on monthly estimates, based on the amount of Work done or completed in compliance with the provisions of the Contract. Contractor shall submit an application, on a standard pay application form provided or approved by the County, of an approximate estimate of the proportionate value of the Work done, items and locations of the Work performed up to and including the last day of the period then ending. The County will then review said estimate and make any necessary revisions so that the estimate can receive approval for payment. If the Contractor and the County do not agree on the approximate estimate of the proportionate value of the Work done for any pay period, the determination of the County will be binding. The amount of said estimate after deducting any required retainage and all previous payments shall be due and payable to the Contractor within 20 days after the pay estimate has been approved by the County. It is the Contractor's responsibility for the care of the materials.

C.05 PAYMENT (Continued)

Any damage to or loss of said materials is the full responsibility of the Contractor. Any Periodical Pay Estimate signed by the Contractor shall be final as to the Contractor for any or all work covered by the Periodical Pay Estimate.

Any requests for payment of materials stored on site must be accompanied with a paid receipt. The Contractor warrants and guarantees that title to all work, materials and equipment covered by any application for payment, whether incorporated in the project or not, will pass to the County at the time of payment free and clear of all liens, claims, security interests and encumbrances (hereafter referred to as "Liens").

The Contractor agrees to furnish an affidavit stating that all laborers, material men, and subcontractors have been paid on the project for Work covered by the application for payment and that a partial or complete release of lien, as may be necessary, be properly executed by the material men, laborers, subcontractors on the project for Work covered by the application for payment, sufficient to secure the County from any claim whatsoever arising out of the aforesaid Work.

When the Contractor has completed the Work in compliance with the terms of the Contract Documents, he shall notify the County in writing that the project is ready for final inspection. The County will then advise the Contractor as to the arrangements for final inspection and what Work, if any, is required to prepare the project or a portion thereof for final inspection. When the County determines the project or portion thereof is ready for final inspection, the County shall perform same. Upon completion of final inspection, the County will notify Contractor of all particulars in which this inspection reveals that the Work is incomplete or defective. Contractor shall immediately take such measures as are necessary to complete such Work or remedy such deficiencies. When all such errors have been corrected, a final re-inspection will be made. The process will be repeated until, in the opinion of the County, the project has been completed in compliance with the terms of the Contract Documents.

When final acceptance has been made by the County, the County will make final payment of the Contract amount, plus all approved additions, less approved deductions and previous payments made. The Contract will be considered complete when all work has been finished, the final inspection made, approved as-builts received, and the project finally accepted in writing by the County. The Contractor's responsibility shall then terminate except as otherwise stated.

C.06 RETAINAGE

A **retainage** of 2.5% of the total contract amount shall be withheld from payments after 75% completion of the Work. Upon substantial completion, this retainage shall be reduced to 1% of the total contract amount plus such amount as the County may reasonably deem necessary to repair, replace, complete or correct any damaged, defective, incorrect or incomplete work. Upon final acceptance, the remaining retainage shall be included in the final payment.

C.07 WARRANTY AND GUARANTEE PROVISIONS

All work, materials, and equipment furnished as defined herein shall be guaranteed and warranted by the contractor for a minimum period of three (3) years, unless otherwise specified, from final acceptance by the County to be free from defects due either to faulty materials or equipment or faulty workmanship.

All materials, equipment, and workmanship furnished and installed by the contractor is warranted and guaranteed by the contractor to be such as to meet the required standards and to accomplish the purposes and functions required standards and to accomplish the purposes and functions of the project as defined, detailed, and specified herein.

The County shall, following discovery thereof, promptly give written notice to the contractor of faulty materials, equipment, or workmanship within the period of the guarantee and the contractor shall promptly replace any part of the faulty equipment, material, or workmanship at his own cost. These warranty and guarantee provisions create no limitations on the County as to any claims or actions for breach of guaranty or breach of warranty that the County might have against parties other than the contractor, and do not constitute exclusive remedies of the County against the contractor.

C.08 ROYALTIES AND PATENTS

The contractor shall pay all royalties and license fees for equipment or processes in conjunction with the equipment and/or services being furnished. Contractor shall defend all suits or claims for infringement of any patent, trademark or copyright, and shall save the County harmless from loss on account thereof, including costs and attorney's fees.

C.09 AUTHORIZED PRODUCT REPRESENTATION

The contractor, by virtue of submitting the name and specifications of a manufacturer's product, will be required to furnish the named manufacturer's product. Failure to perform accordingly may, in the County's sole discretion, be deemed a breach of contract, and shall constitute grounds for the County's immediate termination of the contract.

C.10 REGULATIONS

It shall be the responsibility of the bidder to assure compliance with any OSHA, EPA and/or other federal or state of Florida rules, regulations or other requirements, as each may apply.

C.11 CANCELLATION

Any failure of the contractor to furnish or perform the Work (including, but not limited to, commencement of the Work, failure to supply sufficient skilled workers or suitable materials or equipment) in accordance with the contract, the County may order the stop of the Work, or any portion thereof, until the cause for such order has been eliminated. If the contractor persistently fails to perform the Work in accordance with the contract, the County reserves the right to terminate the contract and select the next qualified bidder or re-advertise this procurement in part or in whole. The County reserves the right to cancel all or any undelivered or unexecuted portion of this contract with or without cause.

C.12 INDEMNIFICATION

The contractor covenants and agrees to indemnify and save harmless the County, its agents and employees, from and against all claims, suits, actions, damages, causes of action, or judgments arising out of the terms of the resulting agreement for any personal injury, loss of life, or damage to the property sustained as a result of the performance or non-performance of services or delivery of goods; from and against any orders, judgments, or decrees, which may be entered against the County, its agents or employees; and from and against all costs, attorney's fees, expenses and other liabilities incurred in the defense of any such claim, suit or action, and the investigation thereof. Nothing in the award, resulting agreement, contract or Purchase Order shall be deemed to affect the rights, privileges and immunities of the County as set forth in Florida Statute Section 768.28.

C.13 MANUALS, SCHEMATICS, HANDBOOKS (IF APPLICABLE)

All manuals, schematics and handbooks shall be provided which are applicable to the equipment delivered. An operators manual, parts manual and technician manual must also be provided. Parts lists (manuals) must include OEM part numbers for items not manufactured by the bidder. Vendor shall furnish two (2) copies of each.

C.14 INSURANCE

The contractor will not commence work under a contract until all insurance under this section and such insurance coverage as might be required by the County has been obtained. The contractor shall obtain, and submit to purchasing within 10 calendar days of request, at his expense, the following minimum amounts of insurance (inclusive of any amounts provided by an umbrella or excess policy):

- a. Workers' Compensation/Employers' Liability
Part One - There shall be no maximum limit (other than as limited by the applicable statute) for liability imposed by Florida Workers' Compensation Act or any other coverage required by the contract documents which are customarily insured under Part One of the standard Workers' Compensation Policy.

C.14 INSURANCE (Continued)

Part Two - The minimum amount of coverage required by the contract documents which are customarily insured under Part Two of the standard Workers' Compensation Policy shall be:

<u>\$100,000</u>	(Each Accident)
<u>\$500,000</u>	(Disease-Policy Limit)
<u>\$100,000</u>	(Disease-Each Employee)

b. Commercial General Liability

The limits are to be applicable only to work performed under this contract and shall be those that would be provided with the attachment of the Amendment of Limits of Insurance (Designated Project or Premises) endorsement (ISO Form CG 25 03) a Commercial General Liability Policy with the following minimum limits.

General Aggregate:

Products/Completed Operations Aggregate	<u>\$1,000,000</u>
Personal and Advertising Injury	<u>\$300,000</u>
Each Occurrence	<u>\$300,000</u>
Fire Damage (Any One Fire)	<u>\$Nil</u>
Medical Expense (Any One Person)	<u>\$Nil</u>

c. Business Auto Policy

Each Occurrence Bodily Injury and Property Damage Liability Combined	<u>\$300,000</u>
Annual Aggregate (if applicable):	<u>\$1,000,000</u>

d. Owners Protective Liability Coverage

The minimum OPC Policy limits per occurrence and, if subject to an aggregate, annual aggregate to be provided by the contractor shall be the same as the amounts shown above as the minimum per occurrence and general policy aggregate limits respectively required for the Commercial General Liability coverage. The limits afforded by the OPC Policy and any excess policies shall apply only to the County and the County's officials, officers, agents and employees and only to claims arising out of or in connection with the work under this contract.

e. Property Insurance

If this contract includes construction of or additions to above ground buildings or structures, contractor shall provide "**Builder's Risk**" insurance with the minimum amount of insurance to be 100% of the value of such addition(s), building(s), or structure(s).

C.14 INSURANCE (Continued)f. Installation Floater

If this contract does not include construction of or additions to above ground building or structures, **but does involve** the installation of machinery or equipment, contractor shall provide an "**Installation Floater**" with the minimum amount of insurance to be 100% of the value of such addition(s), building(s), or structure(s).

g. Certificates of Insurance and Copies of Policies

Certificates of Insurance in triplicate evidencing the insurance coverage specified in the six above paragraphs a., b., c., d., e., and f., shall be filed with the Purchasing Official before operations are begun. The required certificates of insurance shall name the types of policy, policy number, date of expiration, amount of coverage, companies affording coverage, and also shall refer specifically to the bid number, project title and location of project. Insurance shall remain in force at least one year after completion and acceptance of the project by the County, in the amounts and types as stated herein, with coverage for all products and services completed under this contract.

ADDITIONAL INSURED: The contractor shall name Manatee County as additional insured in each of the applicable policies.

If the initial insurance expires prior to the completion of operations and/or services by the contractor, renewal certificates of insurance and required copies of policies shall be furnished by the contractor and delivered to the Purchasing Official thirty (30) days prior to the date of their expiration.

Nothing herein shall in any manner create any liability of the County in connection with any claim against the contractor for labor, services, or materials, or of subcontractors; and nothing herein shall limit the liability of the contractor or contractor's sureties to the County or to any workers, suppliers, material men or employees in relation to this contract.

C.15 BID BOND/CERTIFIED CHECK

By offering a submission to this Invitation For Bid, the bidder agrees should the bidder's bid be accepted, **to execute the form of contract and present the same to Manatee County for approval within 10 days after being notified of the awarding of the contract**. The bidder further agrees that failure to execute and deliver said form of contract **within 10 days** will result in damages to Manatee County and as guarantee of payment of same a bid bond/certified check shall be enclosed within the submitted sealed bid in the amount of five (5%) percent of the total amount of the bid.

C.15 BID BOND/CERTIFIED CHECK (Continued)

The bidder further agrees that in case the bidder fails to enter into a contract, as prescribed by Manatee County, the bid bond/certified check accompanying the bid shall be forfeited to Manatee County as agreed liquidated damages. If the County enters into a contract with a bidder, or if the County rejects any and/or all bids, accompanying bond will be promptly returned.

C.16 PERFORMANCE AND PAYMENT BONDS

The successful bidder shall furnish surety bonds as security for faithful performance of the contract awarded as a result of this bid, and for the payment of all persons performing labor and/or furnishing material in connection therewith. Surety of such bonds shall be in an amount equal to the bid award (100% each) and from a duly authorized and nationally recognized surety company, authorized to do business in Florida, satisfactory to this County. The attorney-in-fact who signs the bonds must file with the bonds a certificate and effective dated copy of power-of-attorney. (Reference Florida Statute 255.05)

Furnishing the performance and payment bonds shall be requisite to execution of a contract with the County. Said performance and payment bonds will remain in force for the duration of the contract with the premiums paid by the contractor. Failure of successful bidder to execute such contract and to supply the required bonds shall be just cause for annulment of the award.

The County may then contract with another acceptable bidder or re-advertise this Invitation For Bid. If another bidder is accepted, and notice given within 90 days after the opening of bids, this acceptance shall bind the bidder as though they were originally the successful bidder.

Failure of the County at any time, to require performance by the contractor of any provisions set out in the contract will in no way affect the right of the County, thereafter, to enforce the provisions. Bonds to remain in effect for one year after final payment becomes due.

C.17 NO DAMAGES FOR DELAY

No claim for damages or any claim other than for an extension of time shall be made or asserted against the County by reason of any delays. The Contractor shall not be entitled to an increase in the Total Contract Price or payment or compensation of any kind from the County or direct, indirect, consequential impact or other costs, expenses for damages, including but not limited to costs of acceleration or inefficiency arising because of delay, disruption, interference or hindrance from any

C.17 NO DAMAGES FOR DELAY (Continued)

cause whatsoever; provided, however, that this provision shall not preclude recovery or damages by the Contractor for hindrance or delays due solely to fraud, bad faith, or active interference on part of the County or its agents. Otherwise, the Contractor shall only be entitled to extensions of the Contract Time as the sole and exclusive remedy for such resulting delay, in accordance with and to the extent specifically provided above.

C.18 NO INTEREST

Any monies not paid by the County when claimed to be due to the Contractor under this Contract shall not be subject to interest including prejudgment interest. Any monies not paid by the County when claimed to be due to the Contractor for damages awarded in the case of construction delays shall not be subject to prejudgment interest.

C.19 CONSTRUCTION OF CONTRACT

This Contract and the rights and responsibilities hereunder shall not be construed more strongly against either party, regardless of the extent to which such party may have participated in the preparation hereof.

C.21 BE GREEN

All Vendors/Bidders/Quoters/Proposers (*as applicable*) are encouraged to use as many **environmentally preferable** "green" products, materials, supplies, etc. as possible in order to promote a safe and healthy environment. **Environmentally preferable are products or services that have a reduced adverse effect on the environment.** Provide detail of your organization's initiative and its ability to meet the goal of environmental sustainability.

END OF SECTION C

SECTION 00100
BID SUMMARY

D.01 THE WORK

The work included in this contract consists of the construction of various sizes of waterlines and water services by directional drilling and other methods to replace existing waterlines, including all appurtenances, traffic control, pavement repair, valves, hydrants, permits, and coordination with county staff and residents, as required by the plans and specifications. The project consists of installing approx. 5300' of 4", 6" and 8" water main, see bid form for actual qtys. Replacement of waterlines on private properties by a licensed plumber is included and access to properties shall be arranged by the contractor. Where access to a property is denied by the property owner, such work may be deleted from the Contract by the County. The Contractor shall not have cause for any claim for additional payment against the County or the property owner due to any such deletions of work.

The Contractor shall furnish all shop drawings, working drawings, labor, materials, equipment, tools, services and incidentals necessary to complete all work required by these Specifications and as shown on the Contract Drawings.

The Contractor shall perform the work complete, in place and ready for continuous service and shall include any repairs, replacements, and/or restoration required as a result of damages caused prior to acceptance by the County.

The Contractor shall furnish and install all materials, equipment and labor which is reasonable and properly inferable and necessary for the proper completion of the work, whether specifically indicated in the Contract Documents or not.

D.02 SUBCONTRACTORS, SUPPLIERS AND OTHERS

The identity of subcontractors, suppliers, and other persons and organizations (including those who are to furnish the principal items of material and equipment) may be requested by the County for each bid item from any of the Bidders; and the Bidder shall respond within five days after the date of such request. Such list shall be accompanied by an experience statement with pertinent information regarding similar projects and other evidence of qualification for each such subcontractor, supplier, persons or organization if requested by County. If County, after due investigation, has reasonable objection to any proposed subcontractor, supplier, other person or organization, County may, before the Notice of Award is given, request the apparent successful Bidder to submit an acceptable substitute without an increase in Contract Price or Contract Time.

If apparent successful Bidder declines to make any such substitution, County may award the contract to the next lowest qualified Bidder that proposes to use acceptable subcontractors, suppliers, and other persons who County does not make written objection to Contractor shall not be required to employ any subcontractor, supplier, other person or organization who Contractor has reasonable objection to.

D.02 SUBCONTRACTORS, SUPPLIERS AND OTHERS (Continued)

Subcontractors shall be bound by the terms and conditions of this contract insofar as it applies to their Work, but this shall not relieve the prime contractor from the full responsibility to the County for the proper completion of all Work to be executed under this contract.

D.03 BIDS

Bids are to be submitted in triplicate, one original and two copies, upon the County supplied forms. All blank spaces must be filled in as noted with amounts extended and totaled and no changes shall be made in the wording of the forms or in the items mentioned therein. In the event a change is made in your submittal, the Bidder shall write its initials by the change. Any bid may be rejected which contains any omissions, alterations, irregularities of any kind, or which shall in any manner fail to conform to bid requirements.

A bid made by an individual, either in his/her own or proper person or under a trade or firm name, shall be executed under the individual's signature. If made by a partnership, the bid shall be executed by two or more of the general partners. If made by a corporation, the bid shall be executed by its President or other legally authorized corporate officer or agent.

D.04 EXAMINATION OF CONTRACT DOCUMENTS AND SITE

It is the responsibility of each Bidder before submitting a Bid, to (a) examine the Bid Documents thoroughly; (b) visit the site to become familiar with local conditions that may affect cost, progress, performance, or furnishing of the Work; (c) consider federal, state, and local codes, laws, and regulations that may affect costs, progress, performance, or furnishing of the Work; (d) study and carefully correlate Bidder's observations with the Bid Documents; and (e) notify County of all conflicts, errors, or discrepancies in the Bid Document.

The accuracy of the existing utility locations shown on the plans is approximate and without express or implied warranty. Each Bidder may, at Bidder's own expense, make or obtain any additional examinations, investigations, explorations, tests and studies, and obtain any additional information and data which pertain to the physical conditions at or contiguous to the site or otherwise which may affect cost, progress, performance or furnishing of the Work and which Bidder deems necessary to determine his Bid for performing and furnishing the Work in accordance with the time, price and other terms and conditions of the Contract Documents.

D.04 EXAMINATION OF CONTRACT DOCUMENTS AND SITE (Continued)

County will provide each Bidder access to the site to conduct such explorations and tests. Bidder shall fill all holes, clean up and restore the site to its former condition upon completion of such explorations. The lands upon which the Work is to be performed, rights-of-way and easements for access thereto, and other lands designated for use by Contractor in performing the Work are identified in the Contract Documents. All additional lands and access thereto required for temporary construction facilities or storage of materials and equipment are to be provided by Contractor. Easements for permanent structures or permanent changes in existing structures are to be obtained and paid for by County unless otherwise provided in the Contract Documents.

D.05 MATERIALS AND WORKMANSHIP

All materials and apparatus required for this Work, except as specifically specified otherwise, shall be new, of first class quality, and shall be furnished, delivered, connected and finished in every detail. Construction shall be prescribed by good industry practice and in accordance with manufacturer's recommendations for the type being installed.

Use skilled workman trained and experienced in the necessary trades and who are completely familiar with the specified requirements and the methods needed for proper performance of the Work of this section.

D.06 REGULATIONS AND MATERIAL DISPOSAL

It shall be the responsibility of the contractor to assure compliance with any OSHA, EPA, federal, state, and/or local rules, regulations or other requirements as each may apply.

D.07 PROJECT CLOSE-OUT

Clean construction site and remove any and all excess materials. Correct any damages to property that may have occurred as a result of installation and/or delivery. Repair and patch all surfaces cut for installation. The Contractor shall remedy any deficiencies promptly should the County determine any work is incomplete or defective.

When the County determines the Work is acceptable in accordance with this Invitation for Bid, the Contractor shall provide the close out submittals, including but not necessarily limited to the following:

- 1 set Certificate of warranties
- 1 set Manufacturer's product literature (as applicable)
- 1 set Project Record Drawings
- 1 set Subcontractor Information

D.08 DISCRETIONARY WORK

This Bid Item entails minor increases (that may be directed by staff) to existing bid item quantities or minor modification items not bid which were unforeseen and necessary during the construction to provide a safe, complete project in accordance with Bid Documents. (This will not affect the requirement for change orders involving major modifications to the project.) Payment for all Work under this item shall be made only at the County's discretion in order to satisfactorily complete the project. In general, this item is for unanticipated conflicts and/or design changes required during construction which are necessary to complete the project without changing the initial scope of Work and without costly delays.

D.09 PROGRESS REQUIREMENTS

Bidders shall take notice of progress requirements detailed in the Contract Documents, Section 01010, Summary of Work, Article 1.03; Work Sequence, Page 15/173.

END OF SECTION D

SECTION 00150

MANATEE COUNTY LOCAL PREFERENCE LAW AND VENDOR REGISTRATION**E.01 Vendor Registration**

All vendors are encouraged to register with Manatee County using the on-line "Vendor Registration" web page on www.mymanatee.org.

Enclosed are a copy of the current Manatee County law that details the County's Local Preference and the County's definition of a Local Business.

If you assert that your firm meets the stated definition of a Local Business, we ask that in addition to registering on the County's Web page, you fill out the attached "**Affidavit As To Local Business Form**" that is included in this section, have the completed document notarized, and mail the original to the following address: Manatee County Administration Center, 1112 Manatee Avenue West, Suite 803, Bradenton, FL 34205.

Your cooperation in registering your business with Manatee County will enhance our opportunities to identify sources for goods and services, plus identify Local Businesses. This information is used for soliciting quotations up to \$250,000.00 and for competitive solicitations of larger purchases.

You will note that Manatee County collaborates with the Manatee Chamber of Commerce, posting bids on www.manateechamber.com as well as using the same vendor categories for registration.

Our staff can assist you with your registration as needed. Our office hours are 8:00 A.M. to 5:00 P.M., Monday through Friday on regular business days. Please call (941) 749-3014 if you wish to have a purchasing staff member assist you.

Quick steps to registration: **www.mymanatee.org**

A link to "Purchasing" is listed under "Quick Links" on page one of the County Web Site.

On the left hand side of the Purchasing Web page, click on "Vendor Registration".

This will bring up the Vendor Registration form for on-line input. Please note that the definition of a "Local Business" changed on June 17, 2009. The Web page will be updated to include the current Law which has been provided in this section of the bid.

Thank you for reviewing this information and considering registering your business with Manatee County. Registration is not mandatory; however, by taking the time to register, you are helping the County to provide timely notifications of quotation, bid and proposal opportunities to your business.

E.02 Section 2-26-6. Local preference, tie bids, local business defined.

(a) Whenever a responsible local business bidder and a responsible non-local business bidder are found, upon the opening of bids, to have both submitted the lowest responsive bid, the bid of the local bidder shall be awarded the contract. Should more than one responsible local business bidder match the responsible non-local business bidder's lowest responsive bid, or should no responsible local business bidder match the lowest responsive bid but two or more responsible non-local business bidders submit lowest responsive bids for equal amounts, then the award of the contract shall be determined by a chance drawing, coin toss, or similar tie-breaking method conducted by the purchasing office and open to the public. Any bidders seeking to be recognized as local businesses for purposes of this local business preference provision may be required by the terms of the bid announcement to certify they meet the definition of local business set forth in this section, and to register as a local business with the County in the manner prescribed by the County to facilitate the County's ability to track the award of contracts to local businesses and to allow the County to provide future notifications to its local businesses concerning other bidding opportunities.

(b) Nothing herein shall be deemed to prohibit the inclusion of requirements with respect to operating and maintaining a local place of business in any invitation for bids when the bidder's location materially affects the provisions of the services or supplies that are required by the invitation.

(c) Local business is defined as a business legally authorized to engage in the sale of the goods and/or services to be procured, and which certifies within its bid that for at least six (6) months prior to the announcement of the solicitation of bids it has maintained a physical place of business in Manatee, Desoto, Hardee, Hillsborough, Pinellas or Sarasota County with at least one full-time employees at that location.

(d) Each solicitation for bids made by the County shall contain terms expressly describing the local business preference policies of the County, and shall provide that by electing to submit a bid pursuant to a request for bids, all bidders are deemed to understand and agree to those policies.

(e) For all contracts for architecture, professional engineering, or other professional services governed by Florida Statute § 287.055, the Consultants' Competitive Negotiation Act, the County shall include the local business status of a firm among the factors considered when selecting which firms are "most highly qualified." In determining which firm is the "most qualified" for purposes of negotiating a satisfactory contract, preference shall be given to a local business where all other relevant factors are equal.

(f) Local preference shall not apply to the following categories of contracts:

1. Goods or services provided under a cooperative purchasing agreement or similar "piggyback" contract;
2. Contracts for professional services subject to Florida Statute § 287.055, the Consultants' Competitive Negotiation Act, except as provided for in subsection (e) above;

E.02 Section 2-26-6. Local preference, tie bids, **local business defined.** (Continued)

3. Purchases or contracts which are funded, in whole or in part, by a governmental or other funding entity, where the terms and conditions of receipt of the funds prohibit the preference;
4. Purchases or contracts made pursuant to a non-competitive award process, unless otherwise provided by this section;
5. Any bid announcement which specifically provides that the general local preference policies set forth in this section are suspended due to the unique nature of the goods or services sought, the existence of an emergency as found by either the County commission or County administrator, or where such suspension is, in the opinion of the County attorney, required by law.

(g) To qualify for local preference under this section, **a local business must certify to the County that it:**

1. Has not within the five years prior to the bid announcement admitted guilt or been found guilty by any court or state or federal regulatory enforcement agency of violation of any criminal law, or a law or administrative regulation regarding fraud;
2. Is not currently subject to an unresolved citation or notice of violation of any Manatee County Code provision, except citations or notices which are the subject of a current legal appeal, as of the date of the bid announcement;
3. Is not delinquent in the payment of any fines, liens, assessments, fees or taxes to any governmental unit or taxing authority within Manatee County, except any such sums which are the subject of a current legal appeal.

Ref: Ordinance 09-21 and 09-23 **PASSED AND DULY ADOPTED** in open session, with a quorum present and voting, on the 17th day of June, 2009.

END OF SECTION E

**MANATEE COUNTY GOVERNMENT
AFFIDAVIT AS TO LOCAL BUSINESS
(Complete and Initial Items B-F)**

A. Authorized Representative

I, [name] _____, am the [title] _____

and the duly authorized representative of: [name of business] _____, and that I possess direct personal knowledge to make informed responses to these certifications and the legal authority to make this Affidavit on behalf of myself and the business for which I am acting; and by electing to submit a bid pursuant to this Invitation for Bids, shall be deemed to understand and agree to the local business preference policies of Manatee County; and that I have the direct knowledge to state that this firm complies with all of the following conditions to be considered to be a Local Business as required by the Manatee County Code of Law, Section 2-26-6.

B. Place of Business: I certify that the above business is legally authorized to engage in the sale of goods and/or services and has a physical place of business in Manatee, DeSoto, Hardee, Hillsborough, Pinellas or Sarasota County with at least one (1) fulltime employee at that location. The physical address of the location which meets the above criteria is: _____

[Initial] _____

C. Business History: I certify that business operations began at the above physical address with at least one fulltime employee on [date] _____ [Initial] _____

D. Criminal Violations: I certify that within the past five years of the date of this Bid announcement, this business has not admitted guilt nor been found guilty by any court or local, state or federal regulatory enforcement agency of violation of any criminal law or administrative regulation regarding fraud. [Initial] _____

E. Citations or Code Violations: I certify that this business is not currently subject to any unresolved citation or notice of violation of any Manatee County Code provision, with the exception of citations or notices which are the subject of a legal current appeal within the date of this bid announcement. [Initial] _____

F. Fees and Taxes: I certify that within this business is not delinquent in the payment of fines, liens, assessments, fees or taxes to any governmental unit or taxing authority within Manatee County, with the exception of those which are the subject of a legal current appeal. [Initial] _____

Each of the above certifications is required to meet the qualification of "Local Business" under Manatee County Code of Law, 2-26-6.

Signature of Affiant _____

STATE OF FLORIDA

COUNTY OF _____

Sworn to (or affirmed) and subscribed before me this ____ day of ____, 20__, by (name of person making statement).

(Notary Seal) Signature of Notary: _____

Name of Notary (Typed or Printed) _____

Personally Known ____ OR Produced Identification ____ Type of Identification Produced _____

Submit executed copy to Manatee County Purchasing, Suite 803, 1112 Manatee Avenue W., Bradenton, FL 34205.

**BID FORM
SECTION 00300
(SUBMIT IN TRIPLICATE)**

For: Washington Gardens- Waterline Improvements

TOTAL BID PRICE "A": \$ _____
Based on a Completion Time of <u>225</u> calendar days
TOTAL BID PRICE "B": \$ _____
Based on a Completion Time of <u>275</u> calendar days

Two schedules for Completion of the Work shall be considered. Each bid for completion by the specified stated time shall be offered as a separate "Total Bid Price". The County has the sole authority to select the bid based on the Completion Time which is the best interest of the County. Only one award shall be made.

We, the undersigned, hereby declare that we have carefully reviewed the bid documents, and with full knowledge and understanding of the aforementioned herewith submit this bid, meeting each and every specification, term, and condition contained in the Invitation for Bids.

We understand that the bid technical specifications, terms, and conditions in their entirety shall be made a part of any agreement or contract between Manatee County and the successful bidder. Failure to comply shall result in contract default, whereupon, the defaulting contractor shall be required to pay for any and all re-procurement costs, damages, and attorney fees as incurred by the County.

Communications concerning this Bid shall be addressed as follows:

Person's Name: _____

Address: _____ Phone: _____

Date: _____ FL Contractor License# _____

Bidder is a WBE/MBE Vendor? _____ Certification _____

COMPANY'S NAME: _____

AUTHORIZED SIGNATURE(S): _____

Name and Title of Above Signer(s) _____

CO. MAILING ADDRESS: _____

STATE OF INCORPORATION _____ (if applicable)

TELEPHONE: (____) _____ FAX: (____) _____

Email address: _____

I, _____ on _____ visited the project site to
(name) (date)

familiarize myself with the full scope of work required for the bid.

Acknowledge Addendum No. _____ Dated: _____ Acknowledge Addendum No. _____ Dated: _____
 Acknowledge Addendum No. _____ Dated: _____ Acknowledge Addendum No. _____ Dated: _____
 Acknowledge Addendum No. _____ Dated: _____ Acknowledge Addendum No. _____ Dated: _____

BID FORM
(Submit in Triplicate)
Section 00300

BID "A"

IFB# 10-2869-DS

PROJECT NAME: Washington Gardens- Waterline Improvements
PROJECT NUMBER: 404-6076770
SECTION/TWNSHP/RANGE: Sec. 12 Twp 34S Rge 17E
PROJECT DESCRIPTION: Install Approx. 5300' of 4", 6", & 8" Water Main

BID "A" Based on Completion time of 225 Calendar Days

WATER LINES					
ITEM #	DESCRIPTION	U/M	QTY	BID PRICE PER UNIT	TOTAL BID PRICE
1	8" HDPE (C-906) (Directional Drill)	LF	1,288	\$	\$
2	6" DIP (CL-350) (Direct Bury)	LF	61	\$	\$
3	6" HDPE (C-906) (Directional Drill)	LF	3,028	\$	\$
4	4" DIP (CL-350) (Direct Bury)	LF	10	\$	\$
5	4" HDPE (C-906) (Directional Drill)	LF	345	\$	\$
6	2" HDPE (DR-9) (Directional Drill)	LF	305	\$	\$
7	10" Gate Valve, MJ	EA	1	\$	\$
8	8" Gate Valve, MJ	EA	5	\$	\$
9	6" Gate Valve, MJ	EA	19	\$	\$
10	4" Gate Valve, MJ	EA	2	\$	\$
11	2" Gate Valve	EA	1	\$	\$
12	Pipe Adapter (HDPE to MJ)	EA	54	\$	\$
13	Fire Hydrant Assembly	EA	9	\$	\$
14	Ductile Iron Fittings	LB	2,576	\$	\$

BIDDER (FIRM NAME): _____

AUTHORIZED SIGNATURE: _____

BID "A"

BID FORM
(Submit in Triplicate)
Section 00300

BID "A"

IFB# 10-2869-DS

PROJECT NAME: Washington Gardens- Waterline Improvements
PROJECT NUMBER: 404-6076770
SECTION/TWNSHP/RANGE: Sec. 12 Twp 34S Rge 17E
PROJECT DESCRIPTION: Install Approx. 5300' of 4", 6", & 8" Water Main

BID "A" Based on Completion time of 225 Calendar Days

WATER LINES					
ITEM #	DESCRIPTION	U/M	QTY	BID PRICE PER UNIT	TOTAL BID PRICE
15	Water Service (Short) (Single)	EA	6	\$	\$
16	Water Service (Long) (Single)	EA	5	\$	\$
17	Water Service (Short) (Double)	EA	25	\$	\$
18	Water Service (Long) (Double)	EA	18	\$	\$
19	Private Water Service Relocation, Complete	EA	73	\$	\$
20	BF Preventer, Expansion Tank, Vac, Breakers	EA	12	\$	\$
21	Connect to Existing Water Lines	EA	4	\$	\$
22	8" Pipe Joint Restraints	EA	12	\$	\$
23	6" Pipe Joint Restraints	EA	35	\$	\$
24	4" Pipe Joint Restraints	EA	8	\$	\$
25	Grout Fill & Abandon Pipe	CF	500	\$	\$
26	Erosion Control	LS	1	\$	\$
27	Traffic Control	LS	1	\$	\$
28	Sodding	SY	1,020	\$	\$

BIDDER (FIRM NAME): _____

AUTHORIZED SIGNATURE: _____

BID "A"

BID FORM
 (Submit in Triplicate)
 Section 00300

BID "A"

IFB# 10-2869-DS

PROJECT NAME: Washington Gardens- Waterline Improvements
PROJECT NUMBER: 404-6076770
SECTION/TWNSHP/RANGE: Sec. 12 Twp 34S Rge 17E
PROJECT DESCRIPTION: Install Approx. 5300' of 4", 6", & 8" Water Main

BID "A" Based on Completion time of 225 Calendar Days

WATER LINES					
ITEM #	DESCRIPTION	U/M	QTY	BID PRICE PER UNIT	TOTAL BID PRICE
29	Driveway Restoration	SY	200	\$	\$
30	Sidewalk Restoration	SY	200	\$	\$
31	Miami Curb Replacement	LF	126	\$	\$
32	Asphalt Road Restoration (Base & Resurface)	SY	145	\$	\$
33	Asphalt Road Restoration (Mill & Resurface)	SY	743	\$	\$
34	Blow-Off Assembly, 2"	EA	4	\$	\$
35	4" HDPE DR 11 C906 Water Service	LF	240	\$	\$
36	3' School Master Meter Complete (Remove/Replace)	LS	1	\$	\$
37	Air Release Valve Assembly	EA	1	\$	\$
38	Mobilization (Max 10% of Total Bid)	LS	1	\$	\$
39	Miscellaneous Work & Clean Up	LS	1	\$	\$
40	DISCRETIONARY WORK	LS	1		\$55,000.00
TOTAL BID PRICE "A" Based On Completion Time of 225 Calendar Days					\$

BIDDER (FIRM NAME): _____

AUTHORIZED SIGNATURE: _____

BID "A"

BID FORM
(Submit in Triplicate)
Section 00300

BID "B"

IFB# 10-2869-DS

PROJECT NAME: Washington Gardens- Waterline Improvements
PROJECT NUMBER: 404-6076770
SECTION/TWNSHP/RANGE: Sec. 12 Twp 34S Rge 17E
PROJECT DESCRIPTION: Install Approx. 5300' of 4", 6", & 8" Water Main

BID "B" Based on Completion time of 275 Calendar Days

WATER LINES					
ITEM #	DESCRIPTION	U/M	QTY	BID PRICE PER UNIT	TOTAL BID PRICE
1	8" HDPE (C-906) (Directional Drill)	LF	1,288	\$	\$
2	6" DIP (CL-350) (Direct Bury)	LF	61	\$	\$
3	6" HDPE (C-906) (Directional Drill)	LF	3,028	\$	\$
4	4" DIP (CL-350) (Direct Bury)	LF	10	\$	\$
5	4" HDPE (C-906) (Directional Drill)	LF	345	\$	\$
6	2" HDPE (DR-9) (Directional Drill)	LF	305	\$	\$
7	10" Gate Valve, MJ	EA	1	\$	\$
8	8" Gate Valve, MJ	EA	5	\$	\$
9	6" Gate Valve, MJ	EA	19	\$	\$
10	4" Gate Valve, MJ	EA	2	\$	\$
11	2" Gate Valve	EA	1	\$	\$
12	Pipe Adapter (HDPE to MJ)	EA	54	\$	\$
13	Fire Hydrant Assembly	EA	9	\$	\$
14	Ductile Iron Fittings	LB	2,576	\$	\$

BIDDER (FIRM NAME): _____

AUTHORIZED SIGNATURE: _____

BID "B"

**BID FORM
(Submit in Triplicate)
Section 00300**

BID "B"

IFB# 10-2869-DS

PROJECT NAME: Washington Gardens- Waterline Improvements
PROJECT NUMBER: 404-6076770
SECTION/TWNSHP/RANGE: Sec. 12 Twp 34S Rge 17E
PROJECT DESCRIPTION: Install Approx. 5300' of 4", 6", & 8" Water Main

BID "B" Based on Completion time of 275 Calendar Days

WATER LINES					
ITEM #	DESCRIPTION	U/M	QTY	BID PRICE PER UNIT	TOTAL BID PRICE
15	Water Service (Short) (Single)	EA	6	\$	\$
16	Water Service (Long) (Single)	EA	5	\$	\$
17	Water Service (Short) (Double)	EA	25	\$	\$
18	Water Service (Long) (Double)	EA	18	\$	\$
19	Private Water Service Relocation, Complete	EA	73	\$	\$
20	BF Preventer, Expansion Tank, Vac, Breakers	EA	12	\$	\$
21	Connect to Existing Water Lines	EA	4	\$	\$
22	8" Pipe Joint Restraints	EA	12	\$	\$
23	6" Pipe Joint Restraints	EA	35	\$	\$
24	4" Pipe Joint Restraints	EA	8	\$	\$
25	Grout Fill & Abandon Pipe	CF	500	\$	\$
26	Erosion Control	LS	1	\$	\$
27	Traffic Control	LS	1	\$	\$
28	Sodding	SY	1,020	\$	\$

BIDDER (FIRM NAME): _____

AUTHORIZED SIGNATURE: _____

BID "B"

**BID FORM
(Submit in Triplicate)
Section 00300**

BID "B"

IFB# 10-2869-DS

PROJECT NAME: Washington Gardens- Waterline Improvements
PROJECT NUMBER: 404-6076770
SECTION/TWNSHP/RANGE: Sec. 12 Twp 34S Rge 17E
PROJECT DESCRIPTION: Install Approx. 5300' of 4", 6", & 8" Water Main

BID "B" Based on Completion time of 275 Calendar Days

WATER LINES					
ITEM #	DESCRIPTION	U/M	QTY	BID PRICE PER UNIT	TOTAL BID PRICE
29	Driveway Restoration	SY	200	\$	\$
30	Sidewalk Restoration	SY	200	\$	\$
31	Miami Curb Replacement	LF	126	\$	\$
32	Asphalt Road Restoration (Base & Resurface)	SY	145	\$	\$
33	Asphalt Road Restoration (Mill & Resurface)	SY	743	\$	\$
34	Blow-Off Assembly, 2"	EA	4	\$	\$
35	4" HDPE DR 11 C906 Water Service	LF	240	\$	\$
36	3' School Master Meter Complete (Remove/Replace)	LS	1	\$	\$
37	Air Release Valve Assembly	EA	1	\$	\$
38	Mobilization (Max 10% of Total Bid)	LS	1	\$	\$
39	Miscellaneous Work & Clean Up	LS	1	\$	\$
40	DISCRETIONARY WORK	LS	1		\$55,000.00
TOTAL BID PRICE "B"					
Based On Completion Time of <u>275</u> Calendar Days					\$

BIDDER (FIRM NAME): _____

AUTHORIZED SIGNATURE: _____

BID "B"

**SWORN STATEMENT
THE FLORIDA TRENCH SAFETY ACT**

THIS FORM MUST BE SIGNED IN THE PRESENCE OF A NOTARY PUBLIC OR BY AN OFFICER AUTHORIZED TO ADMINISTER OATHS.

1. This Sworn Statement is submitted with IFB No. #10-2869-DS
2. This Sworn Statement is submitted by _____
whose business address is _____
and, if applicable, its Federal Employer Identification Number (FEIN) is _____. If
the entity has no FEIN, include the Social Security Number of the individual signing this
sworn statement _____.
3. Name of individual signing this Sworn Statement is: _____,
Whose relationship to the above entity is: _____.
4. The Trench Safety Standards that will be in effect during the construction of this project shall include, but are not limited to: Laws of Florida, Chapters 90-96, TRENCH SAFETY ACT, and OSHA RULES AND REGULATIONS 29 CFR 1926.650 Subpart P, effective October 1, 1990.
5. The undersigned assures that the entity will comply with the applicable Trench Safety Standards and agrees to indemnify and hold harmless the County and Engineer, and any of their agents or employees from any claims arising from the failure to comply with said standard.
6. The undersigned has appropriated the following costs for compliance with the applicable standards:

Trench Safety Measure (Description)	Units of Measure (LF, SY)	Unit Quantity	Unit Cost	Extended Cost
a. _____	_____	_____	\$ _____	_____
b. _____	_____	_____	\$ _____	_____
c. _____	_____	_____	\$ _____	_____
d. _____	_____	_____	\$ _____	_____

7. The undersigned intends to comply with these standards by instituting the following procedures:

_____.

THE UNDERSIGNED, in submitting this Bid, represents that they have reviewed and considered all available geotechnical information and made such other investigations and tests as they may deem necessary to adequately design the trench safety system(s) to be utilized on this project.

(AUTHORIZED SIGNATURE / TITLE)

SWORN to and subscribed before me this ___ day of _____, 20__.
(impress official seal)

Notary Public, State of Florida
My commission expires: _____

SECTION 00430
CONTRACTOR'S QUESTIONNAIRE
 (Submit in Triplicate)

The Bidder warrants the truth and accuracy of all statements and answers herein contained. (Include additional sheets if necessary.)

THIS QUESTIONNAIRE MUST BE COMPLETED AND SUBMITTED WITH YOUR BID/QUOTE.

1. LICENSE #: _____
 COMPANY'S NAME: _____

CO. PHYSICAL ADDRESS _____

CITY _____

_____ (STATE of INCORPORATION, IF APPLICABLE)

_____ (ZIP CODE)

(____) _____ TELEPHONE NUMBER: (____) _____ FAX

EMAIL ADDRESS: _____

2. Bidding as an individual ___ a partnership: ___ a corporation; ___ a joint venture ___

3. If a partnership: list names and addresses of partners; if a corporation: list names of officers, directors, shareholders, and state of incorporation; if joint venture: list names and address of ventures' and the same if any venture are a corporation for each such corporation, partnership, or joint venture:

4. Your organization has been in business (under this firm's name) as a

 for how many years? _____

Years holding a Certified General Contractor's license? _____

(or)

Years holding an Underground Utility Contractor's license? _____

Has license ever been suspended, revoked, removed or under investigation? _____

5. Describe and give the date and County of the last three government projects you've completed which are similar in cost, type, size, and nature as the one proposed (for a public entity), include contact name and phone number. Provide the Budget, Actual Cost, Size and Summary of Work for each project. "Attach additional pages as necessary".

6. Have you ever been assessed liquidated damages under a contract during the past five (5) years? If so, state when, where (contact name, address, and phone number) and why.

7. Have you ever failed to complete work awarded to you? If so, state when, where (Contact name, address, phone number) and why?

8. Have you ever been debarred or prohibited from bidding on a governmental entity's construction project? If yes, name the entity and describe the circumstances:

9. Name three individuals, governmental entities, or corporations for which you have performed similar work and to which you refer. Include contact name and phone number:

- 1. _____
- 2. _____
- 3. _____

10. What specific steps have you taken to examine the physical conditions at or contiguous to the site, including but not limited to, the location of existing underground facilities?

Have you visited the site? _____

Provide date of site visit: _____

11. What specific physical conditions, including, but not limited to, the location of existing underground facilities have you found which will, in any manner, affect cost, progress, performance, or finishing of the work?

12. Will you subcontract any part of this Work? If so, describe which major portion(s):

13. If any, list (with contract amount) WBE/MBE to be utilized:

14. What equipment do you own to accomplish this Work?

15. What equipment will you purchase/rent for the Work? (Specify which)

16. List the following in connection with the Surety which is providing the Bond(s):

Surety's Name: _____

Surety's Address: _____

Surety's Address: _____

Name, address and phone number of Surety's resident agent for service of process in Florida:

Phone: (_____) _____

SECTION 00491
Drug Free Work Place Certification
SWORN STATEMENT PURSUANT TO RESOLUTION R-93-22
DRUG FREE WORK PLACES

THIS FORM MUST BE SIGNED AND SWORN TO IN THE PRESENCE OF A NOTARY PUBLIC OR OTHER OFFICIAL AUTHORIZED TO ADMINISTER OATHS.

This sworn statement is submitted to the Manatee County Board of County Commissioners'

by _____
[Print individual's name and title]

_____ for _____
(print name of entity submitting sworn statement)

Whose business address is:

and (if applicable) its Federal Employer Identification Number (FEIN) is _____
(If the entity has no FEIN, include the Social Security Number of the individual signing this sworn statement: _____).

I understand that no person or entity shall be awarded or receive a County contract for public improvements, procurement of goods or services (including professional services) or a County lease, franchise, concession or management agreement, or shall receive a grant of County monies unless such person or entity has submitted a written certification to the County that it will provide a drug free work place by:

(1) providing a written statement to each employee notifying such employee that the unlawful manufacture, distribution, dispensation, possession or use of a controlled substance as defined by 893.02(4), Florida Statutes, as the same may be amended from time to time, in the person's or entity's work place is prohibited specifying the actions that will be taken against employees for violation of such prohibition. Such written statement shall inform employees about:

- (i) the dangers of drug abuse in the work place;
- (ii) the person's or entity's policy of maintaining a drug free environment at all its work places, including but not limited to all locations where employees perform any task relating to any portion of such contract, business transaction or grant;
- (iii) any available drug counseling, rehabilitation, and employee assistance programs; and
- (iv) the penalties that may be imposed upon employees for drug abuse violations.

2) Requiring the employee to sign a copy of such written statement to acknowledge his or her receipt of same and advice as to the specifics of such policy. Such person or entity shall retain the statements signed by its employees. Such person or entity shall also post in a prominent place at all of its work places a written statement of its policy containing the foregoing elements (i) through (iv).

(3) Notifying the employee in the statement required by subsection (1) that as a condition of employment the employee will:

- (i) abide by the terms of the statement; and
- (ii) notify the employer of any criminal drug statute conviction for a violation occurring in the work place no later than five (5) days after such a conviction.

(4) Notifying the County within ten (10) days after receiving notice under subsection (3) from an employee or otherwise receiving actual notice of such conviction.

(5) Imposing appropriate personnel action against such employee up to and including termination; or requiring such employee to satisfactorily participate in a drug abuse assistance or rehabilitation program approved for such purposes by a federal, state, or local health, law enforcement, or other appropriate agency.

(6) Making a good faith effort to continue to maintain a drug free work place through implementation of sections (1) through (5) stated above.

I UNDERSTAND THAT THE SUBMISSION OF THIS FORM TO THE CONTRACTING OFFICER FOR MANATEE COUNTY IS VALID THROUGH DECEMBER 31 OF THE CALENDAR YEAR IN WHICH IT IS FILED. I ALSO UNDERSTAND THAT ANY CONTRACT OR BUSINESS TRANSACTION SHALL PROVIDE FOR SUSPENSION OF PAYMENTS, OR TERMINATION, OR BOTH, IF THE CONTRACTING OFFICER OR THE COUNTY ADMINISTRATOR DETERMINES THAT:

- (1) Such person or entity has made false certification.
- (2) Such person or entity violates such certification by failing to carry out the requirements of sections (1), (2), (3), (4), (5), or (6) or Resolution R-01-36 Section 4, E (1) (a) or
- (3) Such a number of employees of such person or entity have been convicted of violations occurring in the work place as to indicate that such person or entity has failed to make a good faith effort to provide a drug free work place as required by Resolution R-01-36 Section 4, E (1) (a).

(Signature)

STATE OF FLORIDA
COUNTY OF _____

Sworn to and subscribed before me this _____ day of _____, 20____

by _____.

Personally known _____ OR produced identification _____

_____ My commission expires _____

Notary Public Signature

[Print, type or stamp Commissioned name of Notary Public]

PUBLIC CONTRACTING AND ENVIRONMENTAL CRIMES CERTIFICATION
SWORN STATEMENT PURSUANT TO ARTICLE 5,
MANATEE COUNTY PURCHASING CODE

THIS FORM MUST BE SIGNED AND SWORN TO IN THE PRESENCE OF A NOTARY PUBLIC OR OTHER OFFICIAL AUTHORIZED TO ADMINISTER OATHS.

This sworn statement is submitted to the Manatee County Board of County Commissioners by

_____ [print individual's name and title]

_____ for _____ [print name of entity submitting sworn statement]

Whose business is: _____

and (if applicable) _____

its Federal Employer Identification Number (FEIN) is _____.

If the entity has no FEIN, include the Social Security Number of the individual signing this sworn statement: _____

I understand that no person or entity shall be awarded or receive a County contract for public improvements, procurement of goods or services (including professional services) or a County lease, franchise, concession or management agreement, or shall receive a grant of County monies unless such person or entity has submitted a written certification to the County that it has not:

(1) been convicted of bribery or attempting to bribe a public officer or employee of Manatee County, the State of Florida, or any other public entity, including, but not limited to the Government of the United States, any state, or any local government authority in the United States, in that officer's or employee's official capacity; or

(2) been convicted of an agreement or collusion among bidders or prospective bidders in restraint of freedom of competition, by agreement to bid a fixed price, or otherwise; or

(3) been convicted of a violation of an environmental law that, in the sole opinion of the County's Purchasing Official, reflects negatively upon the ability of the person or entity to conduct business in a responsible manner; or

(4) made an admission of guilt of such conduct described in items (1), (2) or (3) above, which is a matter of record, but has not been prosecuted for such conduct, or has made an admission of guilt of such conduct, which is a matter of record, pursuant to formal prosecution. An admission of guilt shall be construed to include a plea of nolo contendere; or

(5) where an officer, official, agent or employee of a business entity has been convicted of or has admitted guilt to any of the crimes set forth above on behalf of such and entity and pursuant to the direction or authorization of an official thereof (including the person committing the offense, if he is an official of the business entity), the business shall be chargeable with the conduct herein above set forth. A business entity shall be chargeable with the conduct of an affiliated entity, whether wholly owned, partially owned, or one which has common Countyship or a common Board of Directors. For purposes of this Form, business entities are affiliated if, directly or indirectly, one business entity controls or has the power to control another business entity, or if an individual or group of individuals controls or has the power to control both entities. Indicia of control shall include, without limitation, interlocking management or Countyship, identity of interests among family members, shared organization of a business entity following the ineligibility of a business entity under this Article, or using substantially the same management, Countyship or principles as the ineligible entity.

Any person or entity, who claims that this Article is inapplicable to him/hers/it because a conviction or judgment has been reversed by a court of competent jurisdiction, shall prove the same with documentation satisfactory to the County's Purchasing Official. Upon presentation of such satisfactory proof, the person or entity shall be allowed to contract with the County.

I UNDERSTAND THAT THE SUBMISSION OF THIS FORM TO THE CONTRACTING OFFICER FOR MANATEE COUNTY IS VALID THROUGH DECEMBER 31 OF THE CALENDAR YEAR IN WHICH IT IS FILED. I ALSO UNDERSTAND THAT ANY CONTRACT OR BUSINESS TRANSACTION SHALL PROVIDE FOR SUSPENSION OF PAYMENTS, OR TERMINATION, OR BOTH, IF THE CONTRACTING OFFICER OR THE COUNTY ADMINISTRATOR DETERMINES THAT **SUCH PERSON OR ENTITY HAS MADE FALSE CERTIFICATION.**

[Signature]

STATE OF FLORIDA
COUNTY OF _____

Sworn to and subscribed before me this _____ day of _____, 20____

by _____.

Personally known _____ OR produced _____
[Type of identification]

My commission expires _____

Notary Public Signature

[Print, type or stamp Commissioned name of Notary Public]

Signatory Requirement - In the case of a business entity other than a partnership or a corporation, this affidavit shall be executed by an authorized agent of the entity. In the case of a partnership, this affidavit shall be executed by the general partner(s). In the case of a corporation, this affidavit shall be executed by the corporate president.

Where the terms ENGINEER and/or OWNER are used in the Contract Documents, it shall mean the OWNER'S project management team.

Article 3. CONTRACTOR'S REPRESENTATIONS

In order to induce OWNER to enter into this Agreement, CONTRACTOR makes the following representations:

- 3.1 CONTRACTOR has familiarized itself with the nature and extent of the Bid Documents, Work, site, locality and all local conditions and laws and regulations that in any manner may affect cost, progress, performance or furnishing of the Work.
- 3.2 CONTRACTOR has studied carefully all drawings of the physical conditions upon which CONTRACTOR is entitled to rely.
- 3.3 CONTRACTOR has obtained and carefully studied (or assumes responsibility for obtaining and carefully studying) all such examinations, investigations, explorations, tests, reports and studies which pertain to the physical conditions at or contiguous to the site or which otherwise may affect the cost, progress, performance or furnishing of the Work as CONTRACTOR considers necessary for the performance or furnishing of the Work at the Contract Price, within the Contract Time and in accordance with the other terms and conditions of the Bid Documents; and no additional examinations, investigations, explorations, tests, reports, studies or similar information or data are or will be required by CONTRACTOR for such purposes.
- 3.4 CONTRACTOR has reviewed and checked all information and data shown or indicated on the Bid Documents with respect to existing underground facilities at or contiguous to the site and assumes responsibility for the accurate location of said underground facilities. Any additional examinations, investigations, explorations, tests, reports, studies or similar information or data in respect of said underground facilities conducted by the CONTRACTOR will be done at the CONTRACTOR'S expense.

- 3.5 CONTRACTOR has correlated the results of all such observations, examinations, investigations, explorations, tests, reports and studies with the terms and conditions of the Bid.
- 3.6 CONTRACTOR has given OWNER written notice of all conflicts, errors or discrepancies that have been discovered in the Bid Documents and the written resolution thereof by OWNER is acceptable to CONTRACTOR.
- 3.7 CONTRACTOR shall schedule and perform the Work subject to OWNER'S approval and shall hold OWNER harmless from all liabilities incurred due to CONTRACTOR'S failure to coordinate with the OWNER.

Article 4. CONTRACT DOCUMENTS

The Contract Documents which comprise the entire Agreement between OWNER and CONTRACTOR concerning the Work consist of the following:

- 4.1 This Agreement and Bid Document **IFB#10-2869-DS.**
- 4.2 Performance and/or other Bonds and Insurance Certificate(s)
- 4.3 Drawings (not attached)
- 4.4 Addenda numbers X to X , inclusive.
- 4.5 CONTRACTOR'S Bid Form and any other information submitted by Contractor prior to Notice of Award.

- 4.6 The following which may be delivered or issued after the effective date of the Agreement and are not attached hereto: all written Change Orders and other documents amending, modifying, or supplementing the Contract Documents.
- 4.7 The documents listed in paragraphs above are attached to this Agreement (except as noted otherwise above). There are no Contract Documents other than those listed above in this Article 4.

Article 5.

MISCELLANEOUS

- 5.1 Terms used in this Agreement are defined in Article 1 of the General Conditions.
- 5.2 No assignment by a party hereto of any rights under or interest in the Contract Documents will be binding on another party hereto without the written consent of the party sought to be bound; and specifically but without limitation, monies that may become due and monies that are due may not be assigned without such consent (except to the extent that the effect of this restriction may be limited by law); and unless specifically stated to the contrary in any written consent to an assignment, no assignment will release or discharge the assignee from any duty or responsibility under the Contract Documents.
- 5.3 OWNER and CONTRACTOR each binds itself, its partners, successors, assigns and legal representatives to the other party hereto, its partners, successors, assigns and legal representatives in respect of all covenants, agreements and obligations contained in the Contract Documents.

The OWNER will pay, and the CONTRACTOR will accept in full consideration for the performance of the Work (**IFB No. #10-2869-DS, Washington Gardens- Waterline Improvements**) subject to additions and deductions as provided therein, the sum of
XX

Dollars and XXXXXXXXXXXXXXXXXX Cents (\$ XXXXXXXXXXXXXXXXXX) for Bid " X " based on Completion Time of xxx calendar days and the sum of **\$1,148.00** as liquidated damages for each calendar day of delay.

CONTRACTOR

BY: _____
Signature

Name and Title of Signer (printed)

Date: _____

MANATEE COUNTY GOVERNMENT

BY: _____ For the County
Signature

R. C, "Rob" Cuthbert, C.P.M.; CPPO, Purchasing Official
Name and Title of Signer

Date: _____

SECTION 00700
GENERAL CONDITIONS

ARTICLE I - DEFINITIONS

Whenever used in the Bid Documents, the following terms have the meaning indicated which are applicable to both the singular and plural thereof:

Addendum - Written or graphic instruments issued prior to the opening of bids which clarify or change the bidding documents or the contract documents.

Agreement - The written Agreement between Owner and Contractor covering the Work to be performed; other contract documents are attached to the Agreement and made a part thereof as provided therein.

Written Amendment - A written amendment of the contract documents, signed by Owner and Contractor on or after the effective date of the Agreement and normally dealing with the non-engineering or non-technical rather than strictly work related aspects of the contract documents.

Application for Payment - The form accepted by Project Representative which is to be used by Contractor in requesting progress or final payments and which is to include such supporting documentation as is required by the contract documents.

Award - Acceptance of the bid from the person, firm, or corporation which in the Owner's sole and absolute judgment will under all circumstances best serve the public interest. Award shall be made in accordance with Manatee County Code of Laws.

Bid - The offer of the bidder submitted on the prescribed form setting forth the prices for the Work to be performed.

Bidder - One who submits a bid directly to the Owner, as distinct from a sub-bidder, who submits a bid to a Bidder.

Bidding Documents - Consists of the Invitation For Bid, which includes but is not limited to: the bid form, drawings, technical specifications, terms and conditions, and the proposed contract documents (including all Addenda issued prior to receipt of bids); and becomes a part of the Agreement.

Bonds - Performance and payment bonds and other instruments of security.

Change Order - A document recommended by Project Representative which is signed by Contractor and Owner and authorizes an addition, deletion, or revision in the Work or an adjustment in the contract price or the contract time, issued on or after the effective date of the Agreement.

Compensable Delay - Any delay beyond the control and without the fault or negligence of the Contractor resulting from Owner-caused changes in the Work, differing site conditions, suspensions of the Work, or termination for convenience by Owner.

Contract Documents - The Agreement, Addenda (which pertain to the contract documents), Contractor's bid (including documentation accompanying the bid and any post-bid documentation submitted prior to the Notice of Award), the bonds, the specifications and the drawings, together with all amendments, modifications and supplements issued on or after the effective date of the Agreement.

Contract Price - The monies payable by Owner to Contractor under the contract documents as stated in the Agreement.

Contract Time - The number of days or the date stated in the Notice to Proceed for the completion of the Work.

Contractor - The person, firm or corporation with whom Owner has entered into an Agreement.

Days - All references to days are to be considered calendar days except as specified differently.

Defective - An adjective which when modifying the work refers to work that is unsatisfactory, faulty or deficient, or does not conform to the contract documents, or does not meet the requirements of any inspection, reference standard, test or approval referred to in the contract documents, or has been damaged prior to Project Representative's recommendation of final payment (unless responsibility for the protection thereof has been assumed by Owner).

Discretionary – Payment for all work that shall be made only at the Owner's discretion in order to satisfactorily complete the project in accordance with the Plans and Specifications.

Drawings - The drawings which show the character and scope of the Work to be performed and which have been prepared or approved by Engineer and are referred to in the bidding and contract documents.

Effective Date of the Agreement - The date indicated in the Agreement on which it becomes effective (date of execution).

Excusable Delay - Any delay beyond the control and without the negligence of the Contractor, the Owner, or any other contractor caused by events or circumstances such as, but not limited to, acts of God or of the public enemy, fires, floods, freight embargoes, acts of government other than Owner or epidemics. Labor disputes and above average rainfall shall give rise only to excusable delays.

Float or Slack Time - The time available in the progress schedule during which an unexpected activity can be completed without delaying substantial completion of the Work.

Inexcusable Delay - Any delay caused by events or circumstances within the control of the Contractor, such as inadequate crewing, slow submittals, etc., which might have been avoided by the exercise of care, prudence, foresight, or diligence on the part of the Contractor.

Non-prejudicial Delay - Any delay impacting a portion of the Work within the available total float or slack time and not necessarily preventing completion of the Work within the contract time.

Notice of Award - The written notice to the successful bidder stating Award has been approved by the Board of County Commissioners; or by the Purchasing Official in accordance with Manatee County Purchasing Code of Law, Chapter 2-26, Manatee County Purchasing Ordinance.

Notice of Intent to Award - The written notice to the apparent low bidder stating Award has been recommended with final Award to be authorized by the Board of County Commissioners.

Notice to Proceed - Written notice by Owner (after execution of contract) to Contractor fixing the date on which the contract time will commence to run and on which Contractor shall start to perform (ten (10) days from date of such notice) Contractor's obligations under the contract documents.

Owner - Manatee County, Florida, Board of County Commissioners.

Preconstruction Conference - Prior to starting the Work, a meeting scheduled by Owner with Contractor to review the Work schedules, to establish procedures for handling shop drawings and other submissions, for processing periodical pay estimates, and such other matters as may be pertinent to the project.

Prejudicial Delay - Any excusable or compensable delay impacting the Work and exceeding the total float available in the progress schedule, thus preventing completion of the Work within the contract time unless the Work is accelerated.

Pre-operation Testing - All field inspections, installation checks, water tests, performance tests and necessary corrections required of Contractor to demonstrate that individual components of the work have been properly constructed and do operate in accordance with the contract documents for their intended purposes.

Project - The total construction of which the Work to be provided under the contract documents may be the whole or a part as indicated elsewhere in the contract documents.

Project Representative - The authorized representative of Owner who is assigned to the project or any part thereof.

Shop Drawings - All drawings, diagrams, illustrations, schedules and other data which are specifically prepared by or for Contractor to illustrate some portion of the Work and all illustrations, brochures, standard schedules, performance charts, instructions, diagrams and other information prepared by a supplier and submitted by Contractor to illustrate material or equipment for some portion of the Work.

Specifications - Those portions of the contract documents consisting of written technical descriptions of materials, equipment, construction systems, standards and workmanship as applied to the Work and certain administrative details applicable thereto.

Subcontractor - An individual or corporation having a direct contact with Contractor or with any other subcontractor for the performance of a part of the Work at the site. Such person or firm has contractual relations with the Contractor, not with the Owner.

Substantial Completion - The Work (or a specified part thereof) has progressed to the point when, in the opinion of the Engineer as evidenced by Engineer's definitive certificate of Substantial Completion, it is sufficiently complete in accordance with contract documents so that the work can be utilized for the purposes for which it is intended; or if there be no such certificate issued, when final payment is due.

Successful Bidder - The lowest qualified, responsible and responsive bidder to whom an award is made.

Supplier - A manufacturer, fabricator, supplier, distributor, materialman or vendor.

Underground Facilities - All pipelines, conduits, ducts, cables, wires, manholes, vaults, tanks, tunnels or other such facilities or attachments and any encasement containing such facilities which have been installed underground to furnish any of the following services or materials: electricity, gases, steam, liquid petroleum products, telephone or other communications, cable television, sewage and drainage removal, traffic or other control systems or water.

Unit Price Work - Work to be paid for on the basis of unit prices.

Work - The entire completed construction or the various separately identifiable parts thereof required to be furnished under the contract documents. Work is the result of performing services, furnishing labor and furnishing and incorporating materials and equipment into the construction, all as required by the contract documents.

Work Directive Change - A written directive to contractor, issued on or after the effective date of the Agreement and signed by Owner and recommended by Project Representative ordering an addition, deletion or revision in the Work, or responding to differing or unforeseen physical conditions under which the Work is to be performed or to emergencies. A work directive change may not change the contract price or the contract time; but is evidence that the parties expect that the change directed or documented by a work directive change will be incorporated in a subsequently issued change order following negotiations by the parties as to its effect, if any, on the contract price or contract time.

ARTICLE 2 - PRELIMINARY MATTERS

Computation of Time: When time is referred to in the contract documents by days, it will be computed to exclude the first and include the last day of such period. If the last day of any such period falls on a Saturday or Sunday or legal holiday, such day will be omitted from the computation.

- 2.1 The Contractor must submit a proposed schedule of the Work at the preconstruction conference. The purpose of this schedule is to enable the Owner to govern the Work, to protect the functions of the local government and its citizens and to aid in providing appropriate surveillance. The Owner shall have the right to reschedule work provided such rescheduling is in accord with the remainder of terms of the contract. The schedule shall show, as a minimum, the approximate dates on which each segment of the work is expected to be started and finished, the proposed traffic flows during each month, the anticipated earnings by the Contractor for each month and the approximate number of crews and equipment to be used. The Owner, after necessary rescheduling and obtaining additional information for specific purposes, shall review and approve the schedule. The Contractor shall also forward to the Owner, as soon as practicable after the first day of each month, a summary report of the progress of the various parts of the work under the contract, in fabrication and in the field, stating the existing status, estimated time of completion and cause of delay, if any. Together with the summary report, the Contractor shall submit any necessary revisions to the original schedule for the Owner's review and approval. In addition, more detailed schedules may be required by the Owner for daily traffic control.
- 2.2 A Notice to Proceed may be given at any time within thirty (30) days after the effective date of the Agreement. The contract time will commence at the time specified in such notice. Contractor shall start to perform the Work on the date specified in the notice to proceed, but no work shall be done at the site prior to the date on which the contract time commences to run.
- 2.3 If at any time the materials and appliances to be used appear to the Owner as insufficient or improper for securing the quality of work required or the required rate of progress, the Owner may order the Contractor to increase his efficiency or to improve the character of his work and the Contractor shall conform to such an order. The failure of the Owner to demand any increase of such efficiency of any improvement shall not release the Owner from his obligation to secure the quality of work or the rate of progress necessary to complete the Work within the limits imposed by the contract. The Owner may require the Contractor to remove from the Work such employees as the Owner deems incompetent, careless, insubordinate or otherwise objectionable, or whose continued employment on the Work is deemed to be contrary to the Owner's interest.
- 2.4 The Owner reserves the right to let other Contracts in connection with this Work. The Contractor shall afford other Contractors reasonable opportunity for the introduction and storage of their materials and execution of their Work, and promptly connect and coordinate the Work with theirs.

ARTICLE 3 - CONTRACT DOCUMENTS: INTENT, AMENDING, RE-USE

- 3.1 The contract documents comprise the entire Agreement between Owner and Contractor concerning the work. The contract documents are complementary; what is called for by one is as binding as if called for by all. The contract documents will be construed in accordance with the laws and ordinances of the State of Florida and Manatee County.

Should a conflict exist within the contract documents, the precedence in ascending order of authority are as follows: 1) Standard Printed Contract Documents, 2) Special Conditions, 3) General Conditions and 4) Drawings. Note: Computed dimensions shall govern over scaled dimensions.

- 3.2 It is the intent of the contract documents to describe a functionally complete project (or part thereof) to be constructed in accordance with the contract documents. Any work, materials or equipment that may reasonably be inferred from the contract documents as being required to produce the intended result will be supplied whether or not specifically called for. When words which have a well-known technical or trade meaning are used to describe work, materials, or equipment, such words shall be interpreted in accordance with that meaning. Reference to standard specifications, manuals or codes of any technical society, organization or association, or to the laws or regulations of any governmental authority, whether such reference be specific or by implication, shall mean the latest standard specification, manual, code or laws or regulations in effect at the time of opening of bids, except as may be otherwise specifically stated. However, no provision of any referenced standard specification, manual or code (whether or not specifically incorporated by reference in the contract documents) shall be effective to change the duties and responsibilities of Owner, Contractor or Engineer, or any of their agents or employees from those set forth in the Contract Documents.

- 3.3 The contract documents may be amended to provide for additions, deletions and revisions in the Work or to modify the terms and conditions thereof in one or more of the following ways:

- 3.3.1 A Formal Written Amendment
- 3.3.2 A Change Order
- 3.3.3 Administrative Contract Adjustment (ACA)

- 3.4 In addition, the requirements of the contract documents may be supplemented and minor variations and deviations in the Work may be authorized in one or more of the following ways:

- 3.4.1 Discretionary Work – Field Directive
- 3.4.2 Engineer's approval of a Shop Drawing or sample.

ARTICLE 4 - CONTRACTOR'S RESPONSIBILITIES

- 4.1 Contractor shall keep on the Work at all times during its progress a competent resident superintendent; who shall be the Contractor's representative at the site and shall have authority to act on behalf of Contractor. All communications given to the superintendent shall be as binding as if given to Contractor.
- 4.2 Contractor shall provide competent, suitable qualified personnel to survey and lay out the Work and perform construction as required by the contract documents. Contractor shall at all times maintain good discipline and order at the site. Except in connection with the safety or protection of persons or the Work or property at the site or adjacent thereto and except as otherwise indicated in the contract documents, all Work at the site shall be performed during regular working hours and Contractor will not permit overtime work or the performance of work on Saturday, Sunday or legal holiday without Owner's written consent given after prior notice to Engineer (at least 72 hours in advance).
- 4.2.1 Contractor shall pay for all additional engineering charges to the Owner for any overtime work which may be authorized. Such additional engineering charges shall be a subsidiary obligation of Contractor and no extra payment shall be made by Owner on account of such overtime work. At Owner's option, overtime costs may be deducted from Contractor's monthly payment request or Contractor's retainage prior to release of final payment.
- 4.3 Unless otherwise specified, Contractor shall furnish and assume full responsibility for all bonds, insurance, materials, equipment, labor, transportation, construction equipment and machinery, tools, appliances, fuel, power, light, heat, telephone, water, sanitary facilities, temporary facilities and all other facilities and incidentals necessary for the furnishing, performance, testing, start-up and completion of the Work.
- 4.4 All materials and equipment shall be of good quality and new, except as otherwise provided in the contract documents. If required by Engineer, Contractor shall furnish satisfactory evidence (including reports of required tests) as to the kind and quality of materials and equipment. All materials and equipment shall be applied, installed, connected, erected, used, cleaned and conditioned in accordance with the instruction of the applicable supplier except as otherwise provided in the contract documents.
- 4.5 Contractor shall be fully responsible to Owner for all acts and omissions of the subcontractors, suppliers and other persons and organizations performing or furnishing any of the Work under a direct or indirect contract with Contractor just as Contractor is responsible for Contractor's own acts and omissions. Nothing in the Contract Documents shall create any contractual relationship between Owner or Engineer and any such subcontractor, supplier or other person or organization, nor shall it create any obligation on the part of Owner to pay or to see to the payment of any monies due any such subcontractor, supplier or other person or organization.

- 4.6 Permits: Unless otherwise provided, Contractor shall obtain and pay for all construction permits and licenses. Owner shall assist Contractor, when necessary, in obtaining such permits and licenses. Contractor shall pay all governmental charges and inspection fees necessary for the prosecution of the Work.
- 4.7 During the progress of the Work, Contractor shall keep the premises free from accumulation of waste materials rubbish and other debris resulting from the Work. At the completion of the Work, Contractor shall remove all waste materials, rubbish and debris from and about the premises as well as all tools, appliances, construction equipment and machinery and surplus materials and shall leave the site clean and ready for occupancy by Owner. Contractor shall restore to original conditions all property not designated for alteration by the Contract Documents.
- 4.8 Contractor shall not load nor permit any part of any structure to be loaded in any manner that will endanger the structure, nor shall Contractor subject any part of the Work or adjacent property to stresses or pressures that will endanger it.
- 4.9 Safety and Protection: Contractor shall comply with the Florida Department of Commerce Safety Regulations and any local safety regulations. Contractor shall be responsible for initiating, maintaining and supervising all safety precautions and programs in connection with the Work. Contractor shall take all necessary precautions for the safety of and shall provide the necessary protection to prevent damage, injury or loss to:
- 4.9.1 all employees on the work and other persons and organizations who may be affected thereby;
 - 4.9.2 all the work and materials and equipment to be incorporated therein, whether in storage on or off the site; and
 - 4.9.3 other property at the site or adjacent thereto, including trees, shrubs, lawns, walks, pavements, roadways, structures, utilities and underground facilities not designated for removal, relocation or replacement in the course of construction.

Contractor shall comply with all applicable laws and regulations of any public body having jurisdiction for the safety of persons or property or to protect them from damage, injury or loss; and shall erect and maintain all necessary safeguards for such safety and protection. Contractor shall provide and maintain all passageways, guard fences, lights and other facilities for the protection required by public authority or local conditions. Contractor shall provide reasonable maintenance of traffic way for the public and preservation of the Owner's business, taking into full consideration all local conditions. Contractor's duties and responsibilities for the safety and protection of the work shall continue until such time as all the work is completed.

- 4.10 Emergencies: In emergencies affecting the safety or protection of persons or the work or property at the site or adjacent thereto, Contractor, without special instruction or authorization from Engineer or Owner, is obligated to act to prevent threatened damage, injury or loss. Contractor shall give Owner prompt written notice if Contractor believes that any significant changes in the work or variations from the contract documents have been caused thereby. If Owner determines that a change in the contract documents is required because of the action taken in response to an emergency, a Work Directive Change or Change Order will be issued to document the consequences of the changes or variation.
- 4.11 For substitutes not included with the bid, but submitted after the effective date of the Agreement, Contractor shall make written application to Engineer for acceptance thereof, certifying that the proposed substitute will perform adequately the functions and achieve the results called for by the general design, be similar and of equal substance to that specified and be suited to the same use as that specified. The application will also contain an itemized estimate of all costs and delays or schedule impacts that will result directly or indirectly from review, acceptance and provisions of such substitute, including costs of redesign and claims of other contractors affected by the resulting change, all of which will be considered by the Engineer in evaluating the proposed substitute. Engineer may require Contractor to furnish at Contractor's expense, additional data about the proposed substitute. In rendering a decision, Owner/Engineer and Contractor shall have access to any available float time in the construction schedule. In the event that substitute materials or equipment not included as part of the bid, but proposed after the effective date of the agreement, are accepted and are less costly than the originally specified materials or equipment, then the net difference in cost shall be credited to the Owner and an appropriate change order executed.
- 4.11.1 If a specific means, method, technique, sequence of procedure of construction is indicated in or required by the contract documents, Contractor may furnish or utilize a substitute means, method, sequence, technique or procedure of construction acceptable to Engineer if Contractor submits sufficient information to allow Engineer to determine that the substitute proposed is equivalent to that indicated or required by the contract documents.
- 4.11.2 Engineer will be allowed a reasonable time within which to evaluate each proposed substitute. Engineer will be the sole judge of acceptability and no substitute will be ordered, installed or utilized without Engineer's prior written acceptance which will be evidenced by either a change order or an approved shop drawing. Owner may require Contractor to furnish at Contractor's expense a special performance guarantee or other surety with respect to any substitute.
- 4.11.3 Contractor shall reimburse Owner for the charges of Engineer and Engineer's Consultants for evaluating each proposed substitute submitted after the effective date of the Agreement and all costs resulting from any delays in the work while the substitute was undergoing review.

- 4.12 The Contractor shall furnish, free of charge, all labor, stakes, surveys, batter boards for structures, grade lines and other materials and supplies and shall set construction stakes and batter boards for establishing lines, position of structures, slopes and other controlling points necessary for the proper prosecution of the construction work. Where rights-of-way, easements, property lines or any other conditions which make the lay-out of the project or parts of the project critical are involved, the Contractor will employ a competent surveyor who is registered in the State of Florida for lay-out and staking. These stakes and marks shall constitute the field control by and in accord with which the Contractor shall govern and execute the work. The Contractor will be held responsible for the preservation of all stakes, marks and if for any reason any of the stakes or marks or batter boards become destroyed or disturbed, they will be immediately and accurately replaced by the Contractor.
- 4.13 The Contractor has, by careful examination, satisfied himself as to the nature and location of the work and all other matters which can in any way affect the work under this contract, including, but not limited to details pertaining to boring, as shown on the drawings, are not guaranteed to be more than a general indication of the materials likely to be found adjacent to holes bored at the site of the work, approximately at the locations indicated. The Contractor shall examine boring data, where available, and make his own interpretation of the subsoil investigations and other preliminary data, and shall base his bid on his own opinion of the conditions likely to be encountered. In no event shall an extension of time be considered for any conditions that existed at the time of bidding, nor shall the Contractor receive extra compensation for completion of the project as intended by the drawings and in keeping with the contract documents. No verbal agreement or conversation with any officer, agent or employee of the Owner, before or after the execution of this contract, shall affect or modify any of the terms or obligations herein contained.
- 4.14 If the Contractor, in the course of the work, finds that the drawings and/or Contract Documents cannot be followed, he shall immediately inform the Owner in writing, and the Owner shall promptly check the accuracy of the information. Any work done after such discovery, until any necessary changes are authorized, will be done at the Contractor's risk.

ARTICLE 5 - OWNER'S RESPONSIBILITIES

- 5.1 Owner shall furnish the data required of Owner under the contract documents promptly and shall make payments to the Contractor within a reasonable time (no more than 45 days) after the Work has been accepted by the Owner. The form of all submittals, notices, change orders and other documents permitted or required to be used or transmitted under the contract documents shall be determined by the Owner/Engineer. Standard County forms shall be utilized.
- 5.2 The Owner shall provide the lands upon which the Work under this contract is to be done, except that the Contractor shall provide all necessary additional land required for the erection of temporary construction facilities and storage of his materials, together with right of access to same.

- 5.3 The Owner shall have the right to take possession of and use any completed portions of the work, although the time for completing the entire work or such portions may not have expired, but such taking possession and use shall not be deemed an acceptance of any work not completed in accordance with the Contract Documents.

ARTICLE 6 - CHANGES IN THE WORK

- 6.1 Without invalidating the Agreement and without notice to any surety, Owner may, at any time, order additions, deletions or revisions in the Work. These will be authorized by a written amendment, a change order, or a work directive change. Upon receipt of any such document, Contractor shall promptly proceed with the Work involved which will be performed under the applicable conditions of the contract documents (except as otherwise specifically provided).
- 6.2 Contractor shall not be entitled to an increase in the contract price or an extension of the contract time with respect to any Work performed that is not required by the contract documents as amended, modified and supplemented.
- 6.3 Owner and Contractor shall execute appropriate change orders (or written amendments) covering changes in the Work which are ordered by Owner, or which may be required because of acceptance of defective Work.
- 6.4 At any time Engineer may request a quotation from Contractor for a proposed change in the Work and within twenty-one (21) calendar days after receipt, Contractor shall submit a written and detailed proposal for an increase or decrease in the contract price or contract time for the proposed change. Engineer shall have 21 calendar days after receipt of the detailed proposal to respond in writing. The proposal shall include an itemized estimate of all costs and time for performance that will result directly or indirectly from the proposed change. Unless otherwise directed, itemized estimates shall be in sufficient detail to reasonably permit an analysis by Engineer of all material, labor, equipment, subcontracts, overhead costs and fees, and shall cover all Work involved in the change, whether such Work was deleted, added, changed or impacted. Notwithstanding the request for quotation, Contractor shall carry on the Work and maintain the progress schedule. Delays in the submittal of the written and detailed proposal will be considered non-prejudicial.

ARTICLE 7 - CHANGE OF CONTRACT PRICE

- 7.1 The contract price constitutes the total compensation (subject to authorized adjustments) payable to Contractor for performing the Work. All duties, responsibilities and obligations assigned to or undertaken by Contractor shall be at his expense without change in the contract price.
- 7.2 The contract price may only be changed by change order or by a written amendment. Any claim for an increase or decrease in the contract price shall be based on written notice delivered by the party making the claim to the other party. Notice of the amount of the claim with supporting data shall be delivered within ten (10) days from the beginning of such occurrence and shall be accompanied by claimant's written statement that the amount claimed covers all known amounts (direct, indirect and consequential) to which the claimant is entitled as a result of the occurrence of said event.

- 7.3 The value of any Work covered by a change order or of any claim for an increase or decrease in the contract price shall be determined in one of the following ways (at Owner's discretion):
- 7.3.1 Where the Work involved is covered by unit prices contained in the contract documents, cost will be determined by application of such unit prices to the quantities of the items involved.
 - 7.3.2 By mutual acceptance of lump sum.
 - 7.3.3 On the basis of the cost of the Work, plus a 20% Contractor's fee for overhead and profit. (Contractor shall submit an itemized cost breakdown together with supporting data.)
- 7.4 Either Owner or Contractor may make a claim for an adjustment in the contract price. The unit price of an item of unit price Work shall be subject to re-evaluation and adjustment under the following conditions:
- 7.4.1 If the total cost of a particular item of unit price Work amounts to 5% or more of the contract price and the variation in the quantity of the particular item of unit price Work performed by Contractor differs by more than 15% from the estimated quantity of such item indicated in the Agreement; and
 - 7.4.2 If there is no corresponding adjustment with respect to any other item of Work; and
 - 7.4.3 If a Contractor believes that it has incurred additional expense as a result thereof; or
 - 7.4.4 If Owner believes that the quantity variation entitles it to an adjustment in the unit price; or
 - 7.4.5 If the parties are unable to agree as to the effect of any such variations in the quantity of unit price Work performed.

ARTICLE 8 - CHANGE OF CONTRACT TIME

- 8.1 Contract time may only be changed by a change order or a written amendment. Any claim for an extension or shortening of the contract time shall be based on written notice delivered by the party making the claim to the other party. Notice of the extent of the claim with supporting data shall be delivered within fifteen (15) days from detection or beginning of such occurrence and shall be accompanied by the claimant's written statement that the adjustment claimed is the entire adjustment to which the claimant has reason to believe it is entitled as a result of the occurrence of said event.

- 8.2 The contract time will be extended in an amount equal to time lost due to delays beyond the control of Contractor. Such delays shall include, but not be limited to, acts or neglect by Owner or others performing additional work; or to fires, floods, epidemics, abnormal weather conditions or acts of God.
- 8.3 All time limits stated in the contract documents are of the essence.

ARTICLE 9 - WARRANTY, TEST/INSPECTION, CORRECTION

- 9.1 Contractor warrants (for a minimum period of three years or as otherwise stated herein) and guarantees to Owner that all work will be in accordance with the contract documents and will not be defective; that Owner, representatives of Owner, governmental agencies with jurisdictional interests will have access to the work at reasonable time for their observation, inspecting and testing (Contractor shall give Engineer timely notice of readiness of the work for all required approvals and shall assume full responsibility, including costs, in obtaining required tests, inspections, and approval certifications and/or acceptance, unless otherwise stated by Owner).
- 9.2 If any work (including work of others) that is to be inspected, tested, or approved is covered without written concurrence of Engineer, it must, if requested by Engineer, be uncovered for observation. Such uncovering shall be at Contractor's expense unless Contractor has given Engineer timely notice of Contractor's intention to cover the same and Engineer has not acted with reasonable promptness in response to such notice. Neither observations by Engineer nor inspections, tests, or approvals by others shall relieve Contractor from Contractor's obligations to perform the work in accordance with the contract documents.
- 9.3 If the work is defective, or Contractor fails to supply sufficient skilled workers, or suitable materials or equipment, or fails to furnish or perform the work in such a way that the completed work will conform to the contract documents, Owner may order Contractor to stop the work, or any portion thereof and terminate payments to the Contractor until the cause for such order has been eliminated. Contractor shall bear all direct, indirect and consequential costs for satisfactory reconstruction or removal and replacement with non-defective work, including, but not limited to fees and charges of engineers, architects, attorneys and other professionals and any additional expenses experienced by Owner due to delays to other Contractors performing additional work and an appropriate deductive change order shall be issued. Contractor shall further bear the responsibility for maintaining schedule and shall not be entitled to an extension of the contract time and the recovery of delay damages due to correcting or removing defective work.
- 9.3.1 If Contractor fails within seven (7) days after written notice to correct defective work, or fails to perform the work in accordance with the contract documents, or fails to comply with any other provision of the contract documents, Owner may correct and remedy any such deficiency. To the extent necessary to complete corrective and remedial action, Owner may exclude Contractor from all or part of the site, take possession of all or part of the work, Contractor's tools, construction equipment and machinery at the site or for which Owner has paid

Contractor but which are stored elsewhere. All direct, indirect and costs of Owner in exercising such rights and remedies will be charged against Contractor in an amount approved as to reasonableness by Engineer and a change order will be issued incorporating the necessary revisions.

- 9.3.2 If within three years after the date of completion or such longer period of time as may be prescribed by laws or regulations or by the terms of any applicable special guarantee required by the contract documents, any work is found to be defective, Contractor shall promptly, without cost to Owner and in accordance with Owner's written instructions, either correct such defective work or if it has been rejected by Owner, remove it from the site and replace it with non-defective work. If Contractor does not promptly comply with the terms of such instruction, Owner may have the defective work corrected/removed and all direct, indirect and consequential costs of such removal and replacement will be paid by Contractor.

ARTICLE 10 - SUSPENSION/TERMINATION OF WORK

- 10.1 Owner may, at any time and without cause, suspend the work or any portion thereof for a period of not more than ninety (90) days by written notice to Contractor, which will fix the date on which work will be resumed. Contractor shall be allowed an increase in the contract price or an extension of the contract time, or both, directly attributable to any suspension if Contractor makes an approved claim therefore.
- 10.2 Owner may terminate the contract if Contractor commences a voluntary case under any chapter of the Bankruptcy Code or any similar action by filing a petition under any other federal or state law relating to the bankruptcy or insolvency; if a petition is filed against the Contractor under any chapter of the Bankruptcy Code or similar relief under any other federal or state law; if Contractor persistently fails to perform the work in accordance with the contract documents; if Contractor disregards laws or regulations of any public body having jurisdiction or the Engineer; or otherwise violates in any substantial way any provisions of the contract.
- 10.2.1 Owner may, after giving Contractor (and the surety, if there is one) seven (7) days written notice and to the extent permitted by laws and regulations, terminate the services of Contractor; exclude Contractor from the site and take possession of the work and of all Contractor's tools, construction equipment and machinery at the site and use the same to the full extent they could be used (without liability to Contractor for trespass or conversion); incorporate in the work all materials and equipment stored at the site or for which Owner has paid Contractor but which are stored elsewhere, and finish the work as Owner may deem expedient. In such case, Contractor shall not be entitled to receive any further payment beyond an amount equal to the value of material and equipment not incorporated in the work, but delivered and suitably stored, less the aggregate of payments previously made. If the direct and indirect costs of completing the work exceed the unpaid balance of the contract price, Contractor shall pay the difference to Owner. Such costs incurred by Owner shall be verified by Owner and incorporated in

a change order; but in finishing the work, Owner shall not be required to obtain the lowest figure for the work performed. Contractor's obligations to pay the difference between such costs and such unpaid balance shall survive termination of the Agreement.

- 10.3 If, through no act or fault of Contractor, the work is suspended for a period of more than ninety (90) days by Owner or under an order of court or other public authority, or Engineer fails to act on any application or fails to pay Contractor any sum finally determined to be due; then Contractor may, upon seven (7) days written notice to Owner terminate the Agreement and recover from Owner payment for all work executed, any expense sustained plus reasonable termination expenses. In lieu of terminating the Agreement, if Engineer has failed to act on any application of payment or Owner has failed to make any payment as aforesaid, Contractor may upon seven (7) days written notice to Owner stop the work until payment of all amounts then due.

ARTICLE 11 - CONTRACT CLAIMS

- 11.1 The rendering of a decision by Engineer with respect to any such claim, dispute or other matter (except any which have been waived by the making or acceptance of final payment) will be a condition precedent to any exercise by Owner or Contractor of such right or remedies as either may otherwise have under the contract documents or by laws or regulations in respect of any such claim, dispute or other matter. No action, either at law or at equity, shall be brought in connection with any such claim, dispute or other matter later than thirty (30) days after the date on which Owner/Engineer has rendered such written decision in respect thereof. Failure to bring an action within said thirty (30) day period shall result in Engineer's decision being final and binding on the Contractor. In no event may any such action be brought after the time at which instituting such proceedings would be otherwise barred by the applicable statute of limitations.
- 11.2 Before bringing any action in court pertaining to any claim, dispute or other matter in question(s) arising out of or relating to the contract documents or the breach thereof, or Engineer's final decision, except for claims which have been waived by the making and acceptance of final payment, the Contractor shall first submit written notice(s) of contract claims to the Purchasing Official for a decision; within the earlier of sixty (60) days after the last date on which the contractor provided any goods or services required by the contract or after the date on which the contractor knew or should have known such a claim existed. The Manatee County Code of Law section 2-26-63 Contract Claims details the requirements and process for such a claim.

ARTICLE 12 - RESIDENT PROJECT REPRESENTATIVE - DUTIES, RESPONSIBILITIES

- 12.1 Resident Project Representative is Engineer/Owner's Agent, who will act as directed by and under the supervision of the Engineer, and who will confer with Owner/Engineer regarding his actions. Resident Project Representative's dealing in matters pertaining to the on-site work shall, in general, be only with the

Owner/Engineer and Contractor and dealings with subcontractors shall only be through or with the full knowledge of Contractor.

12.2 Resident Project Representative will:

- 12.2.1 Review the progress schedule, schedule of shop drawing submissions and schedule of values prepared by Contractor and consult with Owner/Engineer concerning their acceptability.
- 12.2.2 Attend preconstruction conferences. Arrange a schedule of progress meetings and other job conferences as required in consultation with Owner/Engineer and notify those expected to attend in advance. Attend meetings and maintain and circulate copies of minutes thereof.
- 12.2.3 Serve as Owner/Engineer's liaison with Contractor, working principally through Contractor's superintendent and assist him in understanding the intent of the contract documents. As requested by Owner/Engineer, assist in obtaining additional details or information when required at the job site for proper execution of the Work.
- 12.2.4 Receive and record date of receipt of shop drawings and samples, receive samples which are furnished at the site by Contractor and notify Owner/Engineer of their availability for examination.
- 12.2.5 Advise Owner/Engineer and Contractor or his superintendent immediately of the commencement of any work requiring a shop drawing or sample submission if the submission has not been approved by the Owner/Engineer.
- 12.2.6 Conduct on-site observations of the work in progress to assist Owner/Engineer in determining if the work is proceeding in accordance with the contract documents and that completed work will conform to the contract documents.
- 12.2.7 Report to Owner/Engineer whenever he believes that any work is unsatisfactory, faulty or defective or does not conform to the contract documents, or does not meet the requirements of any inspections, tests or approvals required or if work has been damaged prior to final payment; and advise Owner/Engineer when he believes work should be corrected or rejected or should be uncovered of observation or requires special testing, inspection or approval.
- 12.2.8 Verify that tests, equipment and system start-ups and operating and maintenance instructions are conducted as required by the contract documents and in the presence of the required personnel, and that Contractor maintains adequate records thereof; observe, record and report to Engineer appropriate details relative to the test procedures and start-ups.

- 12.2.9 Accompany visiting inspectors representing public or other agencies having jurisdiction over the project; record the outcome of these inspections and report to Owner/Engineer.
- 12.2.10 Transmit to Contractor, Owner/Engineer's clarifications and interpretations of the contract documents.
- 12.2.11 Consider and evaluate Contractor's suggestions or modifications in drawings or Contract Documents and report them with recommendations to Owner/Engineer.
- 12.2.12 Maintain at the job site orderly files for correspondence, reports of job conferences, shop drawings and sample submissions, reproductions of original contract documents including all addenda, change orders, field orders, additional drawings issued subsequent to the execution of the contract, Owner/Engineer's clarifications and interpretations of the contract documents, progress reports and other project related documents.
- 12.2.13 Keep a diary or log book, recording hours on the job site, weather conditions, data relative to questions of extras or deductions; list of visiting officials and representatives or manufacturers, fabricators, suppliers and distributors; daily activities, decisions, observations in general and specific observations in more detail as in the case of observing test procedures. Send copies to Owner/Engineer.
- 12.2.14 Record names, addresses and telephone numbers of all Contractors, subcontractors and major suppliers of materials and equipment.
- 12.2.15 Furnish Owner/Engineer periodic reports as required of progress of the work and Contractor's compliance with the approved progress schedule and schedule of shop drawing submissions.
- 12.2.16 Consult with Owner/Engineer in advance of scheduling major tests, inspections or start of important phases of the work.
- 12.2.17 Report immediately the occurrence of any accident.
- 12.2.18 Review applications for payment with Contractor for compliance with the established procedure for their submission and forward them with recommendations to Owner/Engineer, noting particularly their relation to the schedule of values, work completed and materials and equipment delivered at the site but not incorporated in the work.
- 12.2.19 During the course of the work, verify that certificates, maintenance and operations manuals and other data required to be assembled and furnished by Contractor are applicable to the items actually installed, and deliver this material to Owner/Engineer for his review prior to final acceptance of the work.

- 12.2.20 Before Owner/Engineer issues a Certificate of Substantial Completion, submit to Contractor a list of observed items requiring completion or correction.
 - 12.2.21 Conduct final inspection in the company of Owner/Engineer and Contractor and prepare a final list of items to be completed or corrected.
 - 12.2.22 Verify that all items on final list have been completed or corrected and make recommendations to Owner/Engineer concerning acceptance.
- 12.3 Except upon written instructions of Owner/Engineer, Resident Project Representative.
- 12.3.1 Shall not authorize any deviation from the contract documents or approve any substitute materials or equipment;
 - 12.3.2 Shall not exceed limitations on Owner/Engineer's authority as set forth in the contract documents;
 - 12.3.3 Shall not undertake any of the responsibilities of Contractor, Subcontractors or Contractor's Superintendent, or expedite the work;
 - 12.3.4 Shall not advise on or issue directions relative to any aspect of the means, methods, techniques, sequences or procedures of construction unless such is specifically called for in the contract documents;
 - 12.3.5 Shall not advise on or issue directions as to safety precautions and programs in connection with the work;
 - 12.3.6 Shall not authorize Owner to occupy the project in whole or in part; and
 - 12.3.7 Shall not participate in specialized field or laboratory tests.

ARTICLE 13 – APPRENTICES

- 13.1 If Successful Contractor employees Apprentices, he shall be governed And comply with the provisions of Florida State Statute 446.011.

NOTE: The form of all submittals, notices, change orders and other documents permitted or required to be used or transmitted under the Contract shall be determined by the County.

END OF SECTION

CONTRACT DOCUMENTS

FOR

Washington Gardens
Waterline Improvements

PROJECT # 404.6076770

June 2010

PROJECT OWNER:

County of Manatee, Florida
c/o Manatee County Purchasing Division
1112 Manatee Avenue West
Bradenton, Florida 34205
(941) 748-4501

PREPARED BY:

Engineering Division
Manatee County Public Works Department
1022 26th Avenue East
Bradenton, Florida 34208
(941) 708-7450

INFRASTRUCTURE ENGINEERING STANDARD SPECIFICATIONS

DIVISION 1	GENERAL REQUIREMENTS	4
SECTION 01005	GENERAL REQUIREMENTS	4
SECTION 01010	SUMMARY OF WORK	15
SECTION 01015	CONTROL OF WORK	17
SECTION 01030	SPECIAL PROJECT PROCEDURES	21
SECTION 01045	CUTTING AND PATCHING	25
SECTION 01050	FIELD ENGINEERING AND SURVEYING	27
SECTION 01090	REFERENCE STANDARDS	29
SECTION 01150	MEASUREMENT AND PAYMENT	32
SECTION 01152	REQUESTS FOR PAYMENT	41
SECTION 01153	CHANGE ORDER PROCEDURES	42
SECTION 01200	PROJECT MEETINGS	45
SECTION 01310	CONSTRUCTION SCHEDULE & PROJECT RESTRAINTS	47
SECTION 01340	SHOP DRAWINGS, PROJECT DATA AND SAMPLES	52
SECTION 01370	SCHEDULE OF VALUES	57
SECTION 01380	CONSTRUCTION PHOTOGRAPHS	58
SECTION 01410	TESTING AND TESTING LABORATORY SERVICES	60
SECTION 01510	TEMPORARY AND PERMANENT UTILITIES	62
SECTION 01570	TRAFFIC REGULATION	64
SECTION 01580	PROJECT IDENTIFICATION AND SIGNS	66
SECTION 01600	MATERIAL AND EQUIPMENT	69
SECTION 01620	STORAGE AND PROTECTION	71
SECTION 01700	CONTRACT CLOSEOUT	73
SECTION 01710	CLEANING	76
SECTION 01720	PROJECT RECORD DOCUMENTS	78
SECTION 01730	OPERATING AND MAINTENANCE DATA	81
SECTION 01740	WARRANTIES AND BONDS	84
DIVISION 2	SITE WORK	86
SECTION 02064	MODIFICATIONS TO EXISTING STRUCTURES, PIPING AND EQUIPMENT	86
SECTION 02100	SITE PREPARATION	90
SECTION 02220	EXCAVATION, BACKFILL, FILL AND GRADING FOR STRUCTURES	92
SECTION 02221	TRENCHING, BEDDING AND BACKFILL FOR PIPE	96
SECTION 02223	EXCAVATION BELOW GRADE AND CRUSHED STONE OR SHELL REFILL	100
SECTION 02260	FINISH GRADING	101
SECTION 02276	TEMPORARY EROSION AND SEDIMENTATION CONTROL	103
SECTION 02485	SEEDING AND SODDING	105
SECTION 02513	ASPHALT CONCRETE PAVING	108
SECTION 02575	PAVEMENT REPAIR AND RESTORATION	117
SECTION 02590	WATER SERVICES ON PRIVATE PROPERTY	120
SECTION 02615	DUCTILE IRON PIPE AND FITTINGS	124
SECTION 02616	DISINFECTING POTABLE WATER PIPE LINES	126
SECTION 02617	INSTALLATION AND TESTING OF PRESSURE PIPE	127

SECTION 02618	PIPELINE CLEANING	130
SECTION 02619	HORIZONTAL DIRECTIONAL DRILLING	133
SECTION 02620	POLYETHYLENE (PE) PRESSURE PIPE	141
SECTION 02622	POLYVINYL CHLORIDE (PVC) PIPE AND FITTINGS (AWWA SPECIFICATIONS C-900 & C-905)	143
SECTION 02640	VALVES AND APPURTENANCES	146
SECTION 02999	MISCELLANEOUS WORK AND CLEANUP	162
DIVISION 3	CONCRETE	164
SECTION 03200	CONCRETE REINFORCEMENT	164
SECTION 03300	CAST-IN-PLACE CONCRETE	167
SECTION 05550	AIR RELEASE ENCLOSURE	172

DIVISION 1 GENERAL REQUIREMENTS

SECTION 01005 GENERAL REQUIREMENTS

PART 1 GENERAL

1.01 SCOPE AND INTENT

A. Description

The work to be done consists of the furnishing of all labor, materials and equipment, and the performance of all work included in this Contract.

B. Work Included

The Contractor shall furnish all labor, superintendence, materials, plant, power, light, heat, fuel, water, tools, appliances, equipment, supplies, shop drawings, working drawings and other means of construction necessary or proper for performing and completing the work. He shall obtain and pay for all required permits necessary for the work, other than those permits such as the DEP permit and railroad permit which may have already been obtained. He shall perform and complete the work in the manner best calculated to promote rapid construction consistent with safety of life and property and to the satisfaction of the Engineer, and in strict accordance with the Contract Documents. The Contractor shall clean up the work and maintain it during and after construction, until accepted, and shall do all work and pay all costs incidental thereto. He shall repair or restore all structures and property that may be damaged or disturbed during performance of the work.

The cost of incidental work described in these General Requirements, for which there are no specific Contract Items, shall be considered as part of the general cost of doing the work and shall be included in the prices for the various Contract Items. No additional payment will be made therefor.

The Contractor shall provide and maintain such modern plant, tools, and equipment as may be necessary, in the opinion of the Engineer, to perform in a satisfactory and acceptable manner all the work required by this Contract. Only equipment of established reputation and proven efficiency shall be used. The Contractor shall be solely responsible for the adequacy of his workmanship, materials and equipment, prior approval of the Engineer notwithstanding.

C. Public Utility Installations and Structures

Public utility installations and structures shall be understood to include all poles, tracks, pipes, wires, conduits, house service connections, vaults, manholes and all other appurtenances and facilities pertaining thereto whether owned or controlled by the Owner, other governmental bodies or privately owned by individuals, firms or corporations, used to serve the public with transportation, traffic control, gas, electricity, telephone, sewage, drainage, water or other public or private property which may be affected by the work shall be deemed included hereunder.

The Contractor shall protect all public utility installations and structures from damage during the work. Access across any buried public utility installation or structure shall be made only in such locations and by means approved by the Engineer. The Contractor shall so arrange his operations as to avoid any damage to these facilities. All required protective devices and construction shall be provided by the Contractor at his expense. All existing public utilities damaged by the Contractor which are shown on the Plans or have been located in the field by the utility shall be repaired by the Contractor, at his expense, as approved by the Engineer. No separate payment shall be made for such protection or repairs to public utility installations or structures.

Public utility installations or structures owned or controlled by the Owner or other governmental body, which are required by this contract to be removed, relocated, replaced or rebuilt by the Contractor not identified in any separate bid item shall be considered as a part of the general cost of doing the work and shall be included in the prices bid for the various contract items. No separate payment shall be made therefor.

Where public utility installations or structures owned or controlled by the Owner or other governmental body are encountered during the course of the work, and are not indicated on the Plans or in the Specifications, and when, in the opinion of the Engineer, removal, relocation, replacement or rebuilding is necessary to complete the work under this Contract, such work shall be accomplished by the utility having jurisdiction, or such work may be ordered, in writing by the Engineer, for the contractor to accomplish. If such work is accomplished by the utility having jurisdiction, it will be carried out expeditiously and the Contractor shall give full cooperation to permit the utility to complete the removal, relocation, replacement or rebuilding as required. If such work is accomplished by the Contractor, it will be in accordance with the General and Supplemental General Conditions.

The Contractor shall give written notice to Owner and other governmental utility departments and other owners of public utilities of the location of his proposed construction operations, at least forty-eight hours in advance of breaking ground in any area or on any unit of the work. This can be accomplished by making the appropriate contact with the "Sunshine State One-Call of Florida, Inc. Call Center ("Call Sunshine") and per all requirements provided for in the Florida Underground Facilities Damage Prevention and Safety Act (Florida Statutes, Title XXXIII, Chapter 556).

The maintenance, repair, removal, relocation or rebuilding of public utility installations and structures, when accomplished by the Contractor as herein provided, shall be done by methods approved by the Engineer.

1.02 PLANS AND SPECIFICATIONS

A. Plans

When obtaining data and information from the Plans, figures shall be used in preference to scaled dimensions, and large scale drawings in preference to small scale drawings.

B. Copies Furnished to Contractor

The Contractor shall furnish each of the subcontractors, manufacturers, and material men such copies of the Contract Documents as may be required for their work. Additional copies of the Plans and Specifications, when requested, may be furnished to the Contractor at cost of reproduction.

C. Supplementary Drawings

When, in the opinion of the Engineer, it becomes necessary to explain more fully the work to be done or to illustrate the work further or to show any changes which may be required, drawings known as Supplementary Drawings, with specifications pertaining thereto, will be prepared by the Engineer and five paper prints thereof will be given to the Contractor.

D. Contractor to Check Plans and Data

The Contractor shall verify all dimensions, quantities and details shown on the Plans, Supplementary Drawings, Schedules, Specifications or other data received from the Engineer, and shall notify him of all errors, omissions, conflicts, and discrepancies found therein. Failure to discover or correct errors, conflicts or discrepancies shall not relieve the Contractor of full responsibility for unsatisfactory work, faulty construction or improper operation resulting therefrom nor from rectifying such conditions at his own expense. He will not be allowed to take advantage of any errors or omissions, as full instructions will be furnished by the Engineer, should such errors or omissions be discovered. All schedules are given for the convenience of the Engineer and the Contractor and are not guaranteed to be complete. The Contractor shall assume all responsibility for the making of estimates of the size, kind, and quality of materials and equipment included in work to be done under the Contract.

E. Specifications

The Technical Specifications consist of three parts: General, Products and Execution. The General Section contains General Requirements which govern the work. Products and Execution modify and supplement these by detailed requirements for the work and shall always govern whenever there appears to be a conflict.

F. Intent

All work called for in the Specifications applicable to this Contract, but not shown on the Plans in their present form, or vice versa, shall be of like effect as if shown or mentioned in both. Work not specified in either the Plans or in the Specifications, but involved in carrying out their intent or in the complete and proper execution of the work, is required and shall be performed by the Contractor as though it were specifically delineated or described.

The apparent silence of the Specifications as to any detail, or the apparent omission from them of a detailed description concerning any work to be done and materials to be furnished, shall be regarded as meaning that only the best general practice is to prevail and that only material and workmanship of the best quality is to be used, and interpretation of these Specifications shall be made upon that basis.

The inclusion of the Related Requirements (or work specified elsewhere) in the General part of the specifications is only for the convenience of the Contractor, and shall not be interpreted as a complete list of related Specification Sections.

1.03 MATERIALS AND EQUIPMENT

A. Manufacturer

The names of proposed manufacturers, material men, suppliers and dealers who are to furnish materials, fixtures, equipment, appliances or other fittings shall be submitted to the Engineer for approval. Such approval must be obtained before shop drawings will be checked. No manufacturer will be approved for any materials to be furnished under this Contract unless he shall be of good reputation and have a plant of ample capacity. He shall, upon the request of the Engineer, be required to submit evidence that he has manufactured a similar product to the one specified and that it has been previously used for a like purpose for a sufficient length of time to demonstrate its satisfactory performance.

All transactions with the manufacturers or subcontractors shall be through the Contractor, unless the Contractor shall request, in writing to the Engineer, that the manufacturer or subcontractor deal directly with the Engineer. Any such transactions shall not in any way release the Contractor from his full responsibility under this Contract.

Any two or more pieces or material or equipment of the same kind, type or classification, and being used for identical types of services, shall be made by the same manufacturer.

B. Delivery

The Contractor shall deliver materials in ample quantities to insure the most speedy and uninterrupted progress of the work so as to complete the work within the allotted time. The Contractor shall also coordinate deliveries in order to avoid delay in, or impediment of, the progress of the work of any related Contractor.

C. Tools and Accessories

The Contractor shall, unless otherwise stated in the Contract Documents, furnish with each type, kind or size of equipment, one complete set of suitably marked high grade special tools and appliances which may be needed to adjust, operate, maintain or repair the equipment. Such tools and appliances shall be furnished in approved painted steel cases, properly labeled and equipped with good grade cylinder locks and duplicate keys.

Spare parts shall be furnished as specified.

Each piece of equipment shall be provided with a substantial nameplate, securely fastened in place and clearly inscribed with the manufacturer's name, year of manufacture, serial number, weight and principal rating data.

D. Installation of Equipment.

The Contractor shall have on hand sufficient proper equipment and machinery of ample capacity to facilitate the work and to handle all emergencies normally encountered in work of this character.

Equipment shall be erected in a neat and workmanlike manner on the foundations at the locations and elevations shown on the Plans, unless directed otherwise by the Engineer during installation. All equipment shall be correctly aligned, leveled and adjusted for satisfactory operation and shall be installed so that proper and necessary connections can be made readily between the various units.

The Contractor shall furnish, install and protect all necessary anchor and attachment bolts and all other appurtenances needed for the installation of the devices included in the

equipment specified. Anchor bolts shall be as approved by the Engineer and made of ample size and strength for the purpose intended. Substantial templates and working drawings for installation shall be furnished.

The Contractor shall, at his own expense, furnish all materials and labor for, and shall properly bed in non-shrink grout, each piece of equipment on its supporting base that rests on masonry foundations.

Grout shall completely fill the space between the equipment base and the foundation. All metal surfaces coming in contact with concrete or grout shall receive a coat of coal tar epoxy equal to Koppers 300M.

E. Service of Manufacturer's Engineer

The Contract prices for equipment shall include the cost of furnishing (as required by equipment specifications sections) a competent and experienced engineer or superintendent who shall represent the manufacturer and shall assist the Contractor, when required, to install, adjust, test and place in operation the equipment in conformity with the Contract Documents. After the equipment is placed in permanent operation by the Owner, such engineer or superintendent shall make all adjustments and tests required by the Engineer to prove that such equipment is in proper and satisfactory operating condition, and shall instruct such personnel as may be designated by the Owner in the proper operation and maintenance of such equipment.

1.04 INSPECTION AND TESTING

A. General

Inspection and testing of materials will be performed by the Owner unless otherwise specified.

For tests specified to be made by the Contractor, the testing personnel shall make the necessary inspections and tests and the reports thereof shall be in such form as will facilitate checking to determine compliance with the Contract Documents. Three (3) copies of the reports shall be submitted and authoritative certification thereof must be furnished to the Engineer as a prerequisite for the acceptance of any material or equipment.

If, in the making of any test of any material or equipment, it is ascertained by the Engineer that the material or equipment does not comply with the Contract, the Contractor will be notified thereof and he will be directed to refrain from delivering said material or equipment, or to remove it promptly from the site or from the work and replace it with acceptable material, without cost to the Owner.

Tests of electrical and mechanical equipment and appliances shall be conducted in accordance with recognized test codes of the ANSI, ASME, or the IEEE, except as may otherwise be stated herein.

The Contractor shall be fully responsible for the proper operation of equipment during tests and instruction periods and shall neither have nor make any claim for damage which may occur to equipment prior to the time when the Owner formally takes over the operation thereof.

B. Costs

All inspection and testing of materials furnished under this Contract will be performed by the Owner or duly authorized inspection engineers or inspections bureaus without cost to the Contractor, unless otherwise expressly specified.

The cost of shop and field tests of equipment and of certain other tests specifically called for in the Contract Documents shall be borne by the Contractor and such costs shall be deemed to be included in the Contract price.

Materials and equipment submitted by the Contractor as the equivalent to those specifically named in the Contract may be tested by the Owner for compliance. The Contractor shall reimburse the Owner for the expenditures incurred in making such tests on materials and equipment which are rejected for non-compliance.

C. Inspections of Materials

The Contractor shall give notice in writing to the Engineer, at least two weeks in advance of his intention to commence the manufacture or preparation of materials especially manufactured or prepared for use in or as part of the permanent construction. Such notice shall contain a request for inspection, the date of commencement and the expected date of completion of the manufacture or preparation of materials. Upon receipt of such notice, the Engineer will arrange to have a representative present at such times during the manufacture as may be necessary to inspect the materials or he will notify the Contractor that the inspection will be made at a point other than the point of manufacture, or he will notify the Contractor that inspection will be waived. The Contractor must comply with these provisions before shipping any material. Such inspection shall not release the Contractor from the responsibility for furnishing materials meeting the requirements of the Contract Documents.

D. Certificate of Manufacture

When inspection is waived or when the Engineer so requires, the Contractor shall furnish to him authoritative evidence in the form of Certificates of Manufacture that the materials to be used in the work have been manufactured and tested in conformity with the Contract Documents. These certificates shall be notarized and shall include copies of the results of physical tests and chemical analyses, where necessary, that have been made directly on the product or on similar products of the manufacturer.

E. Shop Tests of Operating Equipment

Each piece of equipment for which pressure, duty, capacity, rating, efficiency, performance, function or special requirements are specified shall be tested in the shop of the maker in a manner which shall conclusively prove that its characteristics comply fully with the requirements of the Contract Documents. No such equipment shall be shipped to the work until the Engineer notifies the Contractor, in writing, that the results of such tests are acceptable.

Five copies of the manufacturer's actual test data and interpreted results thereof, accompanied by a certificate of authenticity sworn to by a responsible official of the manufacturing company, shall be forwarded to the Engineer for approval.

The cost of shop tests and of furnishing manufacturer's preliminary and shop test data of operating equipment shall be borne by the Contractor.

F. Preliminary Field Tests

As soon as conditions permit, the Contractor shall furnish all labor, materials, and instruments and shall make preliminary field tests of equipment. If the preliminary field tests disclose any equipment furnished under this Contract which does not comply with the requirements of the Contract Documents, the Contractor shall, prior to the acceptance tests, make all changes, adjustments and replacements required. The furnishing Contractor shall assist in the preliminary field tests as applicable.

G. Final Field Tests

Upon completion of the work and prior to final payment, all equipment and piping installed under this Contract shall be subjected to acceptance tests as specified or required to prove compliance with the Contract Documents.

The Contractor shall furnish labor, fuel, energy, water and all other materials, equipment and instruments necessary for all acceptance tests, at no additional cost to the Owner. The Supplier shall assist in the final field tests as applicable.

H. Failure of Tests

Any defects in the materials and equipment or their failure to meet the tests, guarantees or requirements of the Contract Documents shall be promptly corrected by the Contractor. The decision of the Engineer as to whether or not the Contractor has fulfilled his obligations under the Contract shall be final and conclusive. If the Contractor fails to make these corrections or if the improved materials and equipment, when tested, shall again fail to meet the guarantees of specified requirements, the Owner, notwithstanding its partial payment for work, and materials and equipment, may reject the materials and equipment and may order the Contractor to remove them from the site at his own expense.

In case the Owner rejects any materials and equipment, then the Contractor shall replace the rejected materials and equipment within a reasonable time. If he fails to do so, the Owner may, after the expiration of a period of thirty (30) calendar days after giving him notice in writing, proceed to replace such rejected materials and equipment, and the cost thereof shall be deducted from any compensation due or which may become due the Contractor under his Contract.

I. Final Inspection

During such final inspections, the work shall be clean and free from water. In no case will the final pay application be prepared until the Contractor has complied with all requirements set forth and the Engineer has made his final inspection of the entire work and is satisfied that the entire work is properly and satisfactorily constructed in accordance with the requirements of the Contract Document.

1.05 TEMPORARY STRUCTURES

A. Temporary Fences

If, during the course of the work, it is necessary to remove or disturb any fence or part thereof, the Contractor shall, at his own expense, if so ordered by the Engineer, provide a suitable temporary fence which shall be maintained until the permanent fence is replaced. The Engineer shall be solely responsible for the determination of the necessity for providing a temporary fence and the type of temporary fence to be used.

1.06 TEMPORARY SERVICES

A. First Aid

The Contractor shall keep upon the site, at each location where work is in progress, a completely equipped first aid kit and shall provide ready access thereto at all times when people are employed on the work.

1.07 LINES AND GRADES

A. Grade

All work under this Contract shall be constructed in accordance with the lines and grades shown on the Plans, or as given by the Owner/Engineer. The full responsibility for keeping alignment and grade shall rest upon the Contractor.

B. Safeguarding Marks

The Contractor shall safeguard all points, stakes, grade marks, monuments and bench marks made or established on the work, bear the cost of reestablishing them if disturbed, and bear the entire expense of rectifying work improperly installed due to not maintaining or protecting or removing without authorization such established points, stakes and marks.

The Contractor shall safeguard all existing and known property corners, monuments and marks adjacent to but not related to the work and, if required, shall bear the cost of reestablishing them if disturbed or destroyed.

C. Datum Plane

All elevations indicated or specified refer to the Mean Sea Level Datum of the NGVD 1929 Datum and/or NAVD 1988.

1.08 ADJACENT STRUCTURES AND LANDSCAPING

A. Responsibility

The Contractor shall also be entirely responsible and liable for all damage or injury as a result of his operations to all other adjacent public and private property, structures of any kind and appurtenances thereto met with during the progress of the work. The cost of protection, replacement in their original locations and conditions or payment of damages for injuries to such adjacent public and private property and structures affected by the work, whether or not shown on the Plans, and the removal, relocation and reconstruction of such items called for on the Plans or specified shall be included in the various Contract Items and no separate payments will be made therefore. Where such public and private property, structures of any kind and appurtenances thereto are not shown on the Plans and when, in the opinion of the Engineer, additional work is deemed necessary to avoid

interference with the work, payment therefore will be made as provided for in the General Conditions.

Contractor is expressly advised that the protection of buildings, structures, tunnels, tanks, pipelines, etc. and related work adjacent and in the vicinity of his operations, wherever they may be, is solely his responsibility. Conditional inspection of buildings or structures in the immediate vicinity of the project which may reasonably be expected to be affected by the Work shall be performed by and be the responsibility of the Contractor.

Contractor shall, before starting operations, make an examination of the interior and exterior of the adjacent structures, buildings, facilities, etc., and record by notes, measurements, photographs, etc., conditions which might be aggravated by open excavation and construction. Repairs or replacement of all conditions disturbed by the construction shall be made to the satisfaction of the Owner and to the satisfaction of the Engineer. This does not preclude conforming to the requirements of the insurance underwriters. Copies of surveys, photographs, reports, etc., shall be given to the Engineer.

Prior to the beginning of any excavations, the Contractor shall advise the Engineer of all buildings or structures on which he intends to perform work or which performance of the project work will affect.

B. Protection of Trees

1. All trees and shrubs shall be adequately protected by the Contractor with boxes and otherwise and in accordance with ordinances governing the protection of trees. No excavated materials shall be placed so as to injure such trees or shrubs. Trees or shrubs destroyed by negligence of the Contractor or his employees shall be replaced by him with new stock of similar size and age, at the proper season and at the sole expense of the Contractor.
2. Beneath trees or other surface structures, where possible, pipelines may be built in short tunnels, backfilled with excavated materials, except as otherwise specified, or the trees or structures carefully supported and protected from damage.
3. The Owner may order the Contractor, for the convenience of the Owner, to remove trees along the line or trench excavation. If so ordered, the Owner will obtain any permits required for removal of trees. Such tree removal ordered shall be paid for under the appropriate Contract Items.

C. Lawn Areas

Lawn areas shall be left in as good condition as before the starting of the work. Where sod is to be removed, it shall be carefully removed, and later replaced, or the area where sod has been removed shall be restored with new sod in the manner described in the Workmanship and Materials Paragraph in Section 02485, Seeding & Sodding.

D. Restoration of Fences

Any fence, or part thereof, that is damaged or removed during the course of the work shall be replaced or repaired by the Contractor and shall be left in as good a condition as before the starting of the work. The manner in which the fence is repaired or replaced and the materials used in such work shall be subject to the approval of the Engineer. The cost of all labor, materials, equipment, and work for the replacement or repair of any fence shall be deemed included in the appropriate Contract Item or items, or if no specific Item is

provided therefore, as part of the overhead cost of the work, and no additional payment will be made therefore.

1.09 PROTECTION OF WORK AND PUBLIC

A. Barriers and Lights

During the prosecution of the work, the Contractor shall put up and maintain at all times such barriers and lights as will effectually prevent accidents. The Contractor shall provide suitable barricades, red lights, "danger" or "caution" or "street closed" signs and watchmen at all places where the work causes obstructions to the normal traffic or constitutes in any way a hazard to the public, in accordance with state and local requirements.

B. Smoke Prevention

A strict compliance with ordinances regulating the production and emission of smoke will be required. No open fires will be permitted.

C. Noise

The Contractor shall eliminate noise to as great an extent as practicable at all times. Air compressing plants shall be equipped with silencers and the exhaust of all engines or other power equipment shall be provided with mufflers. In the vicinity of hospitals and schools, special care shall be used to avoid noise or other nuisances. The Contractor shall strictly observe all local regulations and ordinances covering noise control.

Except in the event of an emergency, no work shall be done between the hours of 7:00 P.M. and 7:00 A.M., or on weekends. If the proper and efficient prosecution of the work requires operations during the night or weekends, the written permission of the Owner shall be obtained before starting such items of the work.

D. Access to Public Services

Neither the materials excavated nor the materials or plant used in the construction of the work shall be so placed as to prevent free access to all fire hydrants, valves or manholes.

E. Dust prevention

The Contractor shall prevent dust nuisance from his operations or from traffic by keeping the roads and/or construction areas sprinkled with water at all times.

1.10 CUTTING AND PATCHING

The Contractor shall do all cutting, fitting or patching of his portion of the work that may be required to make the several parts thereof join and coordinate in a manner satisfactory to the Engineer and in accordance with the Plans and Specifications. The work must be done by competent workmen skilled in the trade required by the restoration.

1.11 CLEANING

A. During Construction

During construction of the work, the Contractor shall, at all times, keep the site of the work and adjacent premises as free from material, debris and rubbish as is practicable and shall remove the same from any portion of the site if, in the opinion of the Engineer, such material, debris, or rubbish constitutes a nuisance or is objectionable. The Contractor shall remove from the site all of his surplus materials and temporary structures when no further need therefore develops.

B. Final Cleaning

At the conclusion of the work, all equipment, tools, temporary structures and materials belonging to the Contractor shall be promptly taken away, and he shall remove and promptly dispose of all water, dirt, rubbish or any other foreign substances.

The Contractor shall thoroughly clean all equipment and materials installed by him and shall deliver such materials and equipment undamaged in a bright, clean, polished and new operating condition.

1.12 MISCELLANEOUS

A. Protection Against Siltation and Bank Erosion

1. The Contractor shall arrange his operations to minimize siltation and bank erosion on construction sites and on existing or proposed water courses and drainage ditches.
2. The Contractor, at his own expense, shall remove any siltation deposits and correct any erosion problems as directed by the Engineer which results from his construction operations.

B. Protection of Wetland Areas

The Contractor shall properly dispose of all surplus material, including soil, in accordance with Local, State and Federal regulations. Under no circumstances shall surplus material be disposed of in wetland areas as defined by the Florida Department of Environmental Protection or Southwest Florida Water Management District.

C. Existing Facilities

The work shall be so conducted to maintain existing facilities in operation insofar as is possible. Requirements and schedules of operations for maintaining existing facilities in service during construction shall be as described in the Special Provisions.

D. Use of Chemicals

All chemicals used during project construction or furnished for project operation, whether herbicide, pesticide, disinfectant, polymer, reactant, or of other classification, must show approval of either EPA or USDA. Use of all such chemicals and disposal of residues shall be in strict conformance with instructions.

PART 2 PRODUCTS (NOT USED)

PART 3 EXECUTION (NOT USED)

END OF SECTION

SECTION 01010 SUMMARY OF WORK

PART 1 GENERAL

1.01 WORK COVERED BY CONTRACT DOCUMENTS/REQUIREMENTS INCLUDED

- A. The work included in this contract consists of the construction of various sizes of waterlines and water services by directional drilling and other methods to replace existing waterlines, including all appurtenances, traffic control, pavement repair, valves, hydrants, permits, and coordination with county staff and residents, as required by the plans and specifications. Replacement of waterlines on private properties by a licensed plumber is included and access to properties shall be arranged by the contractor. Where access to a property is denied by the property owner, such work may be deleted from the Contract by the County. The Contractor shall not have cause for any claim for additional payment against the County or the property owner due to any such deletions of work.
- B. The Contractor shall furnish all shop drawings, working drawings, labor, materials, equipment, tools, services and incidentals necessary to complete all work required by these Specifications and as shown on the Contract Drawings.
- C. The Contractor shall perform the work complete, in place and ready for continuous service and shall include any repairs, replacements, and/or restoration required as a result of damages caused prior to acceptance by the Owner.
- D. The Contractor shall furnish and install all materials, equipment and labor which is reasonably and properly inferable and necessary for the proper completion of the work, whether specifically indicated in the Contract Documents or not.

1.02 CONTRACTS

Construct all the Work under a single contract.

1.03 WORK SEQUENCE

- A. All work done under this Contract shall be done with a minimum of inconvenience to the users of the system or facility. The Contractor shall coordinate his work with private property owners such that existing utility services are maintained to all users to the maximum extent possible.
- B. The Contractor shall, if necessary and feasible, construct the work in stages to accommodate the Owner's use of the premises during the construction period; coordinate the construction schedule and operations with the Owner's Representative.
- C. The Contractor shall, where feasible, construct the Work in stages to provide for public convenience and not close off public use of any facility until completion of construction to provide alternative usage.

1.04 CONSTRUCTION AREAS

- A. The Contractor shall: Limit his use of the construction areas for work and for storage, to allow for:

1. Work by other Contractors.
2. Owner's Use.
3. Public Use.

- B. Coordinate use of work site under direction of Engineer or Owner's Representative.
- C. Assume full responsibility for the protection and safekeeping of products under this Contract, stored on the site.
- D. Move any stored products under the Contractor's control, which interfere with operations of the Owner or separate contractor.
- E. Obtain and pay for the use of additional storage of work areas needed for Contractor operations.

1.05 OWNER OCCUPANCY

- A. It is assumed that portions of the Work will be completed prior to completion of the entire Work. Upon completion of construction of each individual facility, including testing, if the Owner, at its sole discretion, desires to accept the individual facility, the Contractor will be issued a dated certificate of completion and acceptance for each individual facility. The Owner will assume ownership and begin operation of the individual facility on that date and the three-year warranty period shall commence on that date. The Owner has the option of not accepting the entire work as a whole until it is completed, tested and approved by the Engineer and Owner.

1.06 PARTIAL OWNER OCCUPANCY

The Contractor shall schedule his operations for completion of portions of the Work, as designated, for the Owner's occupancy prior to substantial completion of the entire work.

PART 2 PRODUCTS (NOT USED)

PART 3 EXECUTION (NOT USED)

END OF SECTION

SECTION 01015 CONTROL OF WORK

PART 1 GENERAL

1.01 WORK PROGRESS

The Contractor shall furnish personnel and equipment which will be efficient, appropriate and adequately sized to secure a satisfactory quality of work and a rate of progress which will insure the completion of the work within the time stipulated in the Contract. If at any time such personnel appears to the Engineer to be inefficient, inappropriate, or insufficient for securing the quality of work required for producing the rate of progress aforesaid, he may order the Contractor to increase the efficiency, change the character, or increase the personnel and equipment and the Contractor shall conform to such order. Failure of the Engineer to give such order shall in no way relieve the Contractor of his obligations to secure the quality of the work and rate of progress required.

1.02 PRIVATE LAND

The Contractor shall not enter or occupy private land outside of easements, except by permission of the affected property owner.

1.03 WORK LOCATIONS

Work shall be located substantially as indicated on the drawings, but the Engineer reserves the right to make such modifications in locations as may be found desirable to avoid interference with existing structures or for other reasons.

1.04 OPEN EXCAVATIONS

- A. All open excavations shall be adequately safeguarded by providing temporary barricades, caution signs, lights and other means to prevent accidents to persons and damage to property. The Contractor shall, at his own expense, provide suitable and safe bridges and other crossings for accommodating travel by pedestrians and workmen. Bridges provided for access to private property during construction shall be removed when no longer required. If the excavation becomes a hazard, or if it excessively restricts traffic at any point, the Engineer may require special construction procedures such as limiting the length of open trench, prohibiting stacking excavated material in the street and requiring that the trench shall not remain open overnight.
- B. The Contractor shall take precautions to prevent injury to the public due to open trenches. All trenches, excavated material, equipment, or other obstacles which could be dangerous to the public shall be barricaded and well lighted at all times when construction is not in progress.

1.05 DISTRIBUTION SYSTEMS AND SERVICES

- A. The Contractor shall avoid interruptions to water, telephone, cable TV, sewer, gas, or other related utility services. He shall notify the Engineer and the appropriate agency well in advance of any requirement for dewatering, isolating, or relocating a section of a utility, so that necessary arrangements may be made.
- B. If it appears that utility service will be interrupted for an extended period, the Engineer may

order the Contractor to provide temporary service lines at the Contractor's expense. Inconvenience of the users shall be kept to the minimum, consistent with existing conditions. The safety and integrity of the systems are of prime importance in scheduling work.

1.06 PROTECTION AND RELOCATION OF EXISTING STRUCTURES AND UTILITIES

- A. The Contractor shall assume full responsibility for the protection of all buildings, structures and utilities, public or private, including poles, signs, services to building utilities, gas pipes, water pipes, hydrants, sewers, drains and electric and telephone cables and other similar facilities, whether or not they are shown on the Drawings. The Contractor shall carefully support and protect all such structures and utilities from injury of any kind. Any damage resulting from the Contractor's operation shall be repaired by the Contractor at his expense.
- B. The Contractor shall bear full responsibility for obtaining locations of all underground structures and utilities (including existing water services, drain lines and sewers). Services to buildings shall be maintained and all costs or charges resulting from damage thereto shall be paid by the Contractor.
- C. Protection and temporary removal and replacement of existing utilities and structures as described in this Section shall be a part of the work under the Contract and all costs in connection therewith shall be included in the unit prices established in the Bid.
- D. If, in the opinion of the Engineer, permanent relocation of a utility owned by the Owner is required, he may direct the Contractor, in writing, to perform the work. Work so ordered will be paid for at the Contract unit prices, if applicable, or as extra work as classified in the General Conditions. If relocation of a privately owned utility is required, the Owner will notify the utility to perform the work as expeditiously as possible. The Contractor shall fully cooperate with the Owner and utility and shall have no claim for delay due to such relocation. The Contractor shall notify public utility companies in writing at least 48 hours (excluding Saturdays, Sundays and legal holidays) before excavating near their utilities.

1.07 TEST PITS

Test pits for the purpose of locating underground pipeline or structures in advance of the construction shall be excavated and backfilled by the Contractor immediately after the utility location and the surface shall be restored in a manner equal or better than the original condition. No separate payment will be made.

1.08 CARE AND PROTECTION OF PROPERTY

- A. The Contractor shall be responsible for the preservation of all public and private property and shall use every precaution necessary to prevent damage thereto. If any direct or indirect damage is done to public or private property by or on account of any act, omission, neglect, or misconduct in the execution of the work on the part of the Contractor, such property shall be restored by the Contractor, at his expense, to a condition equal or better to that existing before the damage was done, or he shall make good the damage in another manner acceptable to the Engineer.
- B. All sidewalks which are disturbed by the Contractor's operations shall be restored to their original or better condition by the use of similar or comparable materials. All curbing shall be restored in a condition equal to the original construction and in accordance with the

best modern practice.

- C. Along the location of this work, all fences, walks, bushes, trees, shrubbery and other physical features shall be protected and restored in a thoroughly workmanlike manner unless otherwise shown on the drawings. Fences and other features removed by the Contractor shall be replaced in the location indicated by the Engineer as soon as conditions permit. All grass areas beyond the limits of construction which have been damaged by the Contractor shall be regraded and sodded to equal or exceed original conditions.
- D. Trees close to the work which drawings do not specify to be removed, shall be boxed or otherwise protected against injury. The Contractor shall trim all branches that are liable to damage because of his operations, but in no case shall any tree be cut or removed without prior notification to the Engineer. All injuries to bark, trunk, limbs and roots of trees shall be repaired by dressing, cutting and painting according to approved methods, using only approved tools and materials.
- E. The protection, removal and replacement of existing physical features along the line of work shall be a part of the work under the Contract and all costs in connection therewith shall be included in the unit and/or lump sum prices established under the items in the Bid.

1.09 MAINTENANCE OF TRAFFIC

- A. Open pits, trenches, unpaved streets, debris, or other obstructions due to construction that will prevent the normal flow of traffic during an extended construction stoppage, for any reason, shall be minimized. In the event an extended construction stoppage is found to be necessary, Contractor shall, at his own expense, provide normal traffic flow during extended construction stoppage. Extended stoppage will be defined by the Engineer.
- B. All excavated material shall be placed so that vehicular and pedestrian traffic may be maintained at all times. If the Contractor's operations cause traffic hazards, he shall repair the road surface, provide temporary roadways, erect wheel guards or fences, or take other safety measures which are satisfactory to the Engineer and Owner.
- C. Any changes to the traffic pattern require a Traffic Control Plan as detailed in section 01570 of this specification..

1.10 WATER FOR CONSTRUCTION PURPOSES

- A. In locations where public water supply is available, the Contractor may purchase water for all construction purposes.
- B. The Contractor shall be responsible for paying for all water tap fees incurred for the purpose of obtaining a potable water service or temporary use meter.

1.11 MAINTENANCE OF FLOW

The Contractor shall at his own cost, provide for the flow of sewers, drains and water courses interrupted during the progress of the work and shall immediately cart away and remove all offensive matter. The entire procedure of maintaining existing flow shall be fully discussed with the Engineer and Owner well in advance of the interruption of any flow.

1.12 CLEANUP

During the course of the work, the Contractor shall keep the site of his operations in as clean and neat a condition as is possible. He shall dispose of all residue resulting from the construction work and at the conclusion of the work, he shall remove and haul away any surplus excavation, broken pavement, lumber, equipment, temporary structures and any other refuse remaining from the construction operations and shall leave the entire site of the work in a neat and orderly condition.

1.13 COOPERATION WITHIN THIS CONTRACT

- A. All firms or person authorized to perform any work under this Contract shall cooperate with the General Contractor and his subcontractors or trades and shall assist in incorporating the work of other trades where necessary or required.
- B. Cutting and patching, drilling and fitting shall be carried out where required by the trade or subcontractor having jurisdiction, unless otherwise indicated herein or directed by the Engineer.

1.14 PROTECTION OF CONSTRUCTION AND EQUIPMENT

- A. All newly constructed work shall be carefully protected from injury in any way. No wheeling or walking or placing of heavy loads on it shall be allowed and all portions injured shall be reconstructed by the Contractor at his own expense.
- B. All structures shall be protected in a manner approved by the Engineer. Should any of the floors or other parts of the structures become heaved, cracked, or otherwise damaged, all such damaged portions of the work shall be completely repaired and made good by the Contractor, at his own expense and to the satisfaction of the Engineer. If, in the final inspection of the work, any defects, faults, or omissions are found, the Contractor shall cause the same to be repaired or removed and replaced by proper materials and workmanship without extra compensation for the materials and labor required. Further, the Contractor shall be fully responsible for the satisfactory maintenance and repair of the construction and other work undertaken herein, for at least the warranty period described in the Contract.
- C. Further, the Contractor shall take all necessary precautions to prevent damage to any structure due to water pressure during and after construction and until such structure is accepted and taken over by the Owner.

1.15 CONSTRUCTION WITHIN RIGHT-OF-WAY

Where pipe lines are installed within FDOT right-of-way, all excavation backfill and compaction for the purpose of reconstructing roadways and/or adjacent slopes contiguous thereto shall be in accordance with FDOT or Manatee County Standards and Specifications, whichever is applicable. Contractor shall satisfy the authorized representative of the FDOT with respect to proper safety procedures, construction methods, required permitting, etc., within the FDOT right-of-way.

PART 2 PRODUCTS (NOT USED)

PART 3 EXECUTION (NOT USED)

END OF SECTION

SECTION 01030 SPECIAL PROJECT PROCEDURES

PART 1 GENERAL

1.01 PERMITS

Upon notice of award, the Contractor shall immediately apply for all applicable permits not previously obtained by the Owner to do the work from the appropriate governmental agency or agencies. No work shall commence until all applicable permits have been obtained and copies delivered to the Engineer. The costs for obtaining all permits shall be borne by the Contractor.

1.02 CONNECTIONS TO EXISTING SYSTEM

The Contractor shall perform all work necessary to locate, excavate and prepare for connections to the terminus of the existing systems all as shown on the Drawings or where directed by the Owner/Engineer. The cost for this work and for the actual connection to the existing systems shall be included in the price bid for the project and shall not result in any additional cost to the Owner. The termination point for each contract shall be as shown on the Contract Drawings.

1.03 RELOCATIONS

The Contractor shall be responsible for the coordination of the relocation of structures, including but not limited to light poles, power poles, signs, sign poles, fences, piping, conduits and drains that interfere with the positioning of the work as set out on the Drawings. No relocation of the items under this Contract shall be done without approval from the Engineer.

1.04 EXISTING UNDERGROUND PIPING, STRUCTURES AND UTILITIES

- A. The attention of the Contractor is drawn to the fact that during excavation, the possibility exists of the Contractor encountering various water, sewer, gas, telephone, electrical, or other utility lines not shown on the Drawings. The Contractor shall exercise extreme care before and during excavation to locate and flag these lines as to avoid damage to the existing lines. Cost for relocation of all existing lines shall be included in the price bid for the project. Should damage occur to an existing line, the Contractor shall bear the cost of all repairs.
- B. It is the responsibility of the Contractor to ensure that all utility or other poles, the stability of which may be endangered by the close proximity of excavation, are temporarily stayed in position while work proceeds in the vicinity of the pole and that the utility or other companies concerned be given reasonable advance notice of any such excavation by the Contractor.
- C. The existing utility locations are shown without express or implied representation, assurance, or guarantee that they are complete or correct or that they represent a true picture of underground piping to be encountered. The Contractor shall be responsible for notifying the various utility companies to locate their respective utilities in advance of construction in conformance with all requirements provided for in the Florida Underground Facilities Damage Prevention and Safety Act (Florida Statutes, Title XXXIII, Chapter 556).

- A. The Contractor shall do all groundwater pumping necessary to prevent flotation of any part of the work during construction operations with his own equipment.
- B. The Contractor shall pump out water and wastewater which may seep or leak into the excavations for the duration of the Contract and with his own equipment. He shall dispose of this water in an appropriate manner.

1.10 ADDITIONAL PROVISIONS

- A. Before commencing work on any of the existing pipelines, structures or equipment, the Contractor shall notify the Engineer, in writing, at least 10 calendar days in advance of the date he proposes to commence such work.
- B. The Contractor shall provide, at his own expense, all necessary temporary facilities for access to and for protection of, all existing facilities. The Owner's personnel must have ready access at all times to the existing facilities. The Contractor is responsible for all damage to existing structures, equipment and facilities caused by his construction operations and must repair all such damage when and as ordered by the Engineer.

1.11 CONSTRUCTION CONDITIONS

The Contractor shall strictly adhere to the specific requirements of the governmental unit(s) and/or agency (ies) having jurisdiction over the work. Wherever there is a difference in the requirements of a jurisdictional body and these Specifications, the more stringent shall apply.

1.12 PUBLIC NUISANCE

- A. The Contractor shall not create a public nuisance including but not limited to encroachment on adjacent lands, flooding of adjacent lands, excessive noise or dust.
- B. Sound levels must meet Manatee County Ordinance #87-34, (which amends Ordinance 81-3, The Manatee County Noise Control Ordinance). Sound levels in excess of such ordinance are sufficient cause to have the work halted until equipment can be quieted to these levels. Work stoppage by the Engineer or County for excessive noise shall not relieve the Contractor of the other portions of this specification including, but not limited to contract time and contract price.
- C. No extra charge may be made for time lost due to work stoppage resulting from the creation of a public nuisance.

1.13 WARRANTIES

- A. All material supplied under these Specifications shall be warranted by the Contractor and the manufacturers for a period of three (3) years. Warranty period shall commence on the date of Owner acceptance.
- B. The material shall be warranted to be free from defects in workmanship, design and materials. If any part of the system should fail during the warranty period, it shall be replaced at no expense to the Owner.

- C. The manufacturer's warranty period shall run concurrently with the Contractor's warranty or guarantee period. No exception to this provision shall be allowed. The Contractor shall be responsible for obtaining warranties from each of the respective suppliers or manufacturers for all the material specified under these contract specifications,
- D. In the event that the manufacturer is unwilling to provide a three-year warranty commencing at the time of Owner acceptance, the Contractor shall obtain from the manufacturer a four (4) year warranty starting at the time of equipment delivery to the job site. This four-year warranty shall not relieve the Contractor of the three-year warranty starting at the time of Owner acceptance of the equipment.

1.14 FUEL STORAGE & FILLING

- A. If the contractor is storing fuel on site, or doing his own fuel filling of portable equipment (other than hand-held equipment), he is responsible for any required response, clean-up or reporting required, at no additional cost to the county.
- B. The Contractor shall prepare and submit a fuel storage / spill abatement plan prior to start of construction if required.

PART 2 PRODUCTS (NOT USED)

PART 3 EXECUTION (NOT USED)

END OF SECTION

SECTION 01045 CUTTING AND PATCHING

PART 1 GENERAL

1.01 REQUIREMENTS INCLUDED

- A. The Contractor shall be responsible for all cutting, fitting and patching, including excavation and backfill, required to complete the work or to:
 - 1. Make its several parts fit together properly.
 - 2. Uncover portions of the work to provide for installation of ill-timed work.
 - 3. Remove and replace defective work.
 - 4. Remove and replace work not conforming to requirements of Contract Documents.
 - 5. Provide penetrations of non-structural surfaces for installation of piping and electrical conduit.

PART 2 PRODUCTS

2.01 MATERIALS

Comply with specifications and standards for each specific product involved.

PART 3 EXECUTION

3.01 INSPECTION

- A. Inspect existing conditions of project, including elements subject to damage or to movement during cutting and patching.
- B. After uncovering work, inspect conditions affecting installation of products, or performance of work.
- C. Report unsatisfactory or questionable conditions to Engineer. Do not proceed with work until Engineer has provided further instructions.

3.02 PREPARATION

- A. Provide adequate temporary support as necessary to assure structural value to integrity of affected portion of work.
- B. Provide devices and methods to protect other portions of project from damage.
- C. Provide protection from elements for that portion of the project which may be exposed by cutting and patching work and maintain excavations free from water.

3.03 PERFORMANCE

- A. Execute cutting and demolition by methods which will prevent damage to other work and will provide proper surfaces to receive installation of repairs.

- B. Execute excavating and backfilling by methods which will prevent settlement or damage to other work.
- C. Fit and adjust products to provide a finished installation to comply with specified products, functions, tolerances and finishes.
- D. Restore work which has been cut or removed; install new products to provide completed work in accordance with the requirements of the Contract Documents.
- E. Replace surfaces airtight to pipes, sleeves, ducts, conduit and other penetrations through surfaces.
- F. Refinish entire surfaces as necessary to provide an even finish to match adjacent finishes.

END OF SECTION

SECTION 01050 FIELD ENGINEERING AND SURVEYING

PART 1 GENERAL

1.01 REQUIREMENTS INCLUDED

- A. The Contractor shall provide and pay for field surveying service required for the project.
- B. The Contractor shall furnish and set all necessary stakes to establish the lines and grades as shown on the Contract Drawings and layout each portion of the Work of the Contract.
 - 1. All survey work required in execution of Project.
 - 2. All costs of construction layout shall be included in the unit and lump sum prices contained in the respective divisions of the Contract Bid Form.
 - 3. Civil, structural or other professional engineering services specified or required to execute Contractor's construction methods.

1.02 QUALIFICATION OF SURVEYOR AND ENGINEER

All construction staking shall be conducted by or under the supervision of a Florida Registered Professional Surveyor and Mapper approved by the Owner. The Contractor shall be responsible for the layout of all such lines and grades, which will be subject to verification by the Engineer.

1.03 SURVEY REFERENCE POINTS

- A. Existing basic horizontal and vertical control points for the Project are designated on the Contract Drawings.
- B. Locate and protect all survey monumentation, property corners and project control points prior to starting work and preserve all permanent reference points during construction. All costs associated with the replacement of all survey monumentation, property corners and project control points shall be borne by the Contractor.

Make no changes or relocations without prior written notice to Engineer.

Report to Engineer when any reference point is lost or destroyed, or requires relocation because of necessary changes in grades or locations.

Require surveyor to replace project control points which may be lost or destroyed.

Establish replacements based on original survey control.

1.04 PROJECT SURVEY REQUIREMENTS

The Contractor shall establish temporary bench marks as needed, referenced to data established by survey control points.

1.05 RECORDS

Maintain a complete, accurate log of all control and survey work as it progresses.

The Contractor shall employ a Professional Engineer or Surveyor registered in the State of Florida to verify survey data and properly prepare record drawings per Section 01720.

1.06

SUBMITTALS

- A. Submit name and address of Professional Surveyor and Mapper to Engineer for Owner's approval.
- B. Submit certificate signed by the Professional Surveyor and Mapper certifying that elevations and locations of improvements are in conformance, or nonconformance, with Contract Documents.

PART 2 PRODUCTS (NOT USED)

PART 3 EXECUTION (NOT USED)

END OF SECTION

SECTION 01090 REFERENCE STANDARDS

PART 1 GENERAL

1.01 REQUIREMENTS

Abbreviations and acronyms used in Contract Documents to identify reference standards.

- A. Application: When a standard is specified by reference, comply with requirements and recommendations stated in that standard, except when requirements are modified by the Contract Documents, or applicable codes established stricter standards.
- B. Publication Date: The most recent publication in effect on the date of issue of Contract Documents, except when a specific publication date is specified.

1.03 ABBREVIATIONS, NAMES AND ADDRESSES OR ORGANIZATIONS

Obtain copies of reference standards direct from publication source, when needed for proper performance of work, or when required for submittal by Contract Documents.

AA	Aluminum Association 818 Connecticut Avenue, N.W. Washington, DC 20006
AASHTO	American Association of State Highway and Transportation Officials 444 North Capital Street, N.W. Washington, DC 20001
ACI	American Concrete Institute Box 19150 Reford Station Detroit, MI 48219
AI	Asphalt Institute Asphalt Institute Building College Park, MD 20740
AISC	American Institute of Steel Construction 1221 Avenue of the Americas New York, NY 10020
AISI	American Iron and Steel Institute 1000 16th Street NW Washington, DC 20036
ANSI	American National Standards Institute 1430 Broadway New York, NY 10018
ASHRAE	American Society of Heating, Refrigerating and Air Conditioning Engineers 179I Tullie Circle, N.E. Atlanta, GA 30329

ASME	American Society of Mechanical Engineers 345 East 47th Street New York, NY 10017
ASTM	American Society for Testing and Materials 1916 Race Street Philadelphia, PA 19103
AWWA	American Water Works Association 6666 West Quincy Avenue Denver, CO 80235
AWS	American Welding Society 2501 N.W. 7th Street Miami, FL 33125
CRSI	Concrete Reinforcing Steel Institute 180 North LaSalle Street, Suite 2110 Chicago, IL 60601
FDEP	Florida Department of Environmental Protection 3900 Commonwealth Blvd. Tallahassee, Florida 32399
FDOT	Florida Department of Transportation Standards Specifications for Road and Bridge Construction Maps & Publication Sales - Mail Station 12 605 Suwannee St. Tallahassee, FL 32399-0450
FS	Federal Specification General Services Administration Specifications and Consumer Information Distribution Section (WFSIS) Washington Navy Yard, Bldg. 197 Washington, DC 20407
MCPW UTIL STD	Manatee County Utility Engineering 4410-B 66th St. W. Bradenton, FL 34210
MLSFA	Metal Lath/Steel Framing Association 221 North LaSalle Street Chicago, IL 60601
MMA	Monorail Manufacturer's Association 1326 Freeport Road Pittsburgh, PA 15238
NAAMM	National Association of Architectural Metal Manufacturers 221 North LaSalle Street Chicago, IL 60601

NEMA National Electrical Manufacturer's Assoc.
2101 L Street N.W.
Washington, DC 20037

OHSA Occupational Safety and Health Assoc.
5807 Breckenridge Pkwy., Suite A
Tampa, FL 33610-4249

PCA Portland Cement Association
5420 Old Orchard Road
Skokie, IL 20076

PCI Prestressed Concrete Institute
20 North Wacker Drive
Chicago, IL 60606

SDI Steel Door Institute
712 Lakewood Center North
Cleveland, OH 44107

SMACNA Sheet Metal and Air Conditioning Contractor's National Association
8224 Old Court House Road
Vienna, VA 22180

SSPC Steel Structures Painting Council
402 24th Street, Suite 600
Pittsburgh, PA 15213

SWFWMD Southwest Florida Water Management District
2379 Broad Street
Brooksville, FL 34604-6899

UL Underwriter's Laboratories, Inc.
333 Pfingston Road
Northbrook, IL 60062

PART 2 PRODUCTS (NOT USED)

PART 3 EXECUTION (NOT USED)

END OF SECTION

SECTION 01150 MEASUREMENT AND PAYMENT

PART 1 GENERAL

1.01 SCOPE

- A. The scope of this section of the Contract Documents is to further define the items included in each Bid Item in the Bid Form section of the Contract Documents. Payment will be made based on the specified items included in the description in this section for each bid item.
- B. All contract prices included in the Bid Form section will be full compensation for all shop drawings, working drawings, labor, materials, tools, equipment and incidentals necessary to complete the construction as shown on the Drawings and/or as specified in the Contract Documents to be performed under this Contract. Actual quantities of each item bid on a unit price basis will be determined upon completion of the construction in the manner set up for each item in this section of the Specifications. Payment for all items listed in the Bid Form will constitute full compensation for all work shown and/or specified to be performed under this Contract.

1.02 ESTIMATED QUANTITIES

The quantities shown are approximate and are given only as a basis of calculation upon which the award of the Contract is to be made. The Owner/Engineer does not assume any responsibility for the final quantities, nor shall the Contractor claim misunderstanding because of such estimate of quantities. Final payment will be made only for satisfactorily completed quantity of each item.

1.03 WORK OUTSIDE AUTHORIZED LIMITS

No payment will be made for work constructed outside the authorized limits of work.

1.04 MEASUREMENT STANDARDS

Unless otherwise specified for the particular items involved, all measurements of distance shall be taken horizontally or vertically.

1.05 AREA MEASUREMENTS

In the measurement of items to be paid for on the basis of area of finished work, the lengths and/or widths to be used in the calculations shall be the final dimensions measured along the surface of the completed work within the neat lines shown or designated.

1.06 LUMP SUM ITEMS

Where payment for items is shown to be paid for on a lump sum basis, no separate payment will be made for any item of work required to complete the lump sum items. Lump sum contracts shall be complete, tested and fully operable prior to request for final payment. Contractor may be required to provide a break-down of the lump sum totals.

1.07 UNIT PRICE ITEM

Separate payment will be made for the items of work described herein and listed on the Bid

Form. Any related work not specifically listed, but required for satisfactory completion of the work shall be considered to be included in the scope of the appropriate listed work items.

No separate payment will be made for the following items and the cost of such work shall be included in the applicable pay items of work. Final payments shall not be requested by the Contractor or made by the Owner until as-built (record) drawings have been submitted and approved by the Engineer.

1. Shop Drawings, Working Drawings.
2. Clearing, grubbing and grading except as hereinafter specified.
3. Trench excavation, including necessary pavement removal and rock removal, except as otherwise specified.
4. Dewatering and disposal of surplus water.
5. Structural fill, backfill, and grading.
6. Replacement of unpaved roadways, and shrubbery plots.
7. Cleanup and miscellaneous work.
8. Foundation and borrow materials, except as hereinafter specified.
9. Testing and placing system in operation.
10. Any material and equipment required to be installed and utilized for the tests.
11. Pipe, structures, pavement replacement, asphalt and shell driveways and/or appurtenances included within the limits of lump sum work, unless otherwise shown.
12. Maintaining the existing quality of service during construction.
13. Maintaining or detouring of traffic.
14. Appurtenant work as required for a complete and operable system.
15. Seeding and hydromulching.
16. As-built Record Drawings.

(THE BID ITEM SECTION IS TO BE COMPLETED FOR EACH ITEM TO BE BID. EXAMPLES AS FOLLOWS)

BID ITEM 1, 3, 5, 6 - HDPE C-906 WATER LINE - DIRECTIONAL BORED

Payment for all work included in this Bid Item shall be made at the applicable Contract unit price bid per linear foot for furnishing and installing the listed diameter and class of HDPE water main (AWWA C-906, DR 11 or 9, Class 160 or 200) pipe and fittings as shown on the Contract Drawings or where directed by the Project Representative. Measurement and Payment shall be made for the actual length of the listed diameter pipe installed and acceptably furnished and will represent full compensation for all directional drilling, labor, materials, all non- DI fittings unless specifically included in other bid items, 10 gage copper clad steel wire, detectable tape, excavation, including rock, dewatering, bedding, backfill, compaction, testing and disinfection and equipment required to complete these Bid Items. No additional compensation will be made for excavation below the bottom of the pipe, for rock removal or bedding and backfill materials, or for repair of any settlement.

BID ITEM 2, 4 - DUCTILE IRON WATER LINE

Payment for all work included in this Bid Item shall be made at the applicable Contract unit price bid per linear foot for furnishing and installing the listed diameter and class of ductile iron water main (AWWA C-151, CL-350) pipe as shown on the Contract Drawings or where directed by the Project Representative. Measurement and Payment shall be made for the actual length of the listed diameter pipe installed and will represent full compensation for all

labor, materials, excavation, including rock, 10 gage copper clad steel wire, detectable tape, dewatering, thrust blocking, bedding, backfill, compaction, testing and disinfection and equipment required to complete these Bid Items. No additional compensation will be made for excavation below the bottom of the pipe, for rock removal or bedding and backfill materials, or for repair of any trench settlement.

BID ITEMS 7 TO 11 - GATE VALVES

Payment for all work included in this Bid Item shall be made at the applicable Contract unit price bid per each valve for furnishing and installing the listed diameter valve including but not limited to valve, box, cover, tracer wire & box, identification disc, and concrete pad as shown on the Contract Drawings and listed on the Bid Form. Payment shall represent full compensation for all labor, material, excavation, including rock as necessary, bedding, backfill, compaction, testing and disinfection and equipment required to complete these items.

BID ITEM 12 - PIPE ADAPTERS

Payment for all work included in this Bid Item shall be made at the applicable Contract unit price bid per each pipe adapter for furnishing and installing each adapter, including but not limited to, nuts, bolts, hardware, stainless steel insert, gland, gasket, and all other related items as shown on the Contract Drawings. Payment shall represent full compensation for all labor, material, excavation, including rock as necessary, bedding, backfill, compaction, testing and disinfection and equipment required to complete these Bid Items.

BID ITEM 13 - FIRE HYDRANT ASSEMBLY

Payment for all work included in this Bid Item shall be made at the applicable Contract unit price bid per each complete hydrant assembly, including but not limited to hydrant lead, 6" diameter ductile iron pipe between the main and hydrant up to 10ft for each hydrant, restraints, tee, gate valve, box, cover, tracer wire & box, concrete pads, restraining rods and/or thrust blocks, bolts, gaskets, and fittings as shown on the Contract Drawings. Payment shall represent full compensation for all labor, material, equipment, excavation, including rock, bedding, backfill, compaction, testing and disinfection required to complete this Bid Item.

BID ITEM 14 - DUCTILE IRON FITTINGS, WATER

Payment for all work included in these Bid Items will be made at the applicable Contract unit price bid per pound for furnishing and installing ductile iron fittings (cement-lined) as shown on the Contract Drawings or where directed by the Project Representative. This pay item includes but is not limited to tees, wyes, crosses, bends, sleeves, plugs, caps, and reducers. Measurement shall be by the pound. Payment shall represent full compensation for all labor, material, equipment, excavation, including rock, bedding, backfill, compaction, testing, bolts, gaskets, nuts, washers, and disinfection required to complete these items.

BID ITEMS 15 TO 18 - WATER SERVICES

This Bid Item includes the construction of potable water services including service line,
100%SpecWashGard.docx 34 / 173

meter box and appurtenances of the specified type acceptably furnished and installed as shown on the Drawings or where directed by the Project Representative. The work includes removal of the existing meter box and appurtenances, connection of the new water service to the existing water service line, and installation of new service line as required on private property from the existing box to the meter box installed by the Contractor. The Project Representative may require a plumber licensed in Manatee County to install the portions of the work on private property. Measurement will be according to the type of services, long or short, single or double. Payment for all work under this Bid Item shall be made at the applicable Contract unit price bid according to the type of services. The work shall include, but is not limited to; service piping, excavation, directional drilling, restoration, compaction, casing pipe, meter box, tapping saddles, corporation stops, curb stops, curb or pavement location disks, 10 gauge copper clad steel tracer wire, complete meter assembly & yoke, all necessary fittings, all service connections, disinfection, coordination with service customers, and all other related and necessary materials, work and equipment associated with this item.

BID ITEM 19 - PRIVATE WATER SERVICE RELOCATION, COMPLETE

Measurement and Payment for this item shall be at the applicable Contract unit price bid per service line connection. The Contractor shall coordinate with each private property owner all aspects of routing the water service line from the rear of the private property to the front roadway right-of-way and connecting to the water service meter. The Contractor shall be responsible for meeting with each individual private property owner to coordinate the routing of the water service line on private property prior to the commencement of any work. The Contractor shall document the agreed upon route on a sketch signed and dated by all parties.

The connection point to the existing water service line shall be assumed to be adjacent to the foundation at the entry point into the residence. This Bid Item includes abandoning in place the existing water service line in accordance with the Florida Building Code - Building and Plumbing.

Manatee County Building Permits, in the amount of \$75 each, will be required for all private properties, up to 11 permits may be required, with up to 10 adjacent properties included on each permit. This item includes all permits, material, labor, equipment, excavation, restoration, certification and inspection fees, temporary measures, and taxes necessary to connect the water service line to the water service meter (at the roadway right-of-way) in a manner conforming to all pertinent sections of the Florida Building Code - Building and Plumbing and the Manatee County Building Department. The contractor shall disconnect the existing water service meters located at the rear of the private property and relocate them to the new meter box (provided by the contractor) and connect the water service meter to the service connection from the new water main. This activity shall be coordinated with the private property owner to ensure minimum interruption of potable water service.

BID ITEM 20 - BACKFLOW PREVENTER WITH EXPANSION TANKS AND VACUUM BREAKERS

It is expected that some service line connections shall require installation of a backflow preventer assembly, per Manatee County Utility Standards UW-12 and UW-13, at the water service meter, a thermal expansion tank for each residence hot water heater, and vacuum breakers at each outside hose bibb. All work performed on private property must be performed by an appropriately licensed plumbing contractor per the Florida Building Code -

Building and Plumbing and the Manatee County Building Department. After the backflow assembly is installed, tested and inspected the contractor shall be responsible to register it using the Manatee County Utility Department on-line registration system.

This Bid Item includes the construction of all backflow preventers of the specified type, expansion tanks, and vacuum breakers, acceptably furnished and installed at the locations required by the Florida Plumbing Code or where directed by the Project Representative. Measurement will be based on each complete backflow preventer installed as shown on the drawings. Payment for all work under this Bid Item shall be made at the applicable Contract unit price bid according to the number of backflow preventers. The work shall include, but is not limited to, backflow preventer, expansion tank, vacuum breakers, ball valves, concrete slabs, test cocks and sleeves, all necessary fittings, all service connections, disinfection and all other related and necessary materials, work and equipment associated with this item.

BID ITEM 21 - CONNECTION TO EXISTING WATER LINES

Payment for all work included in this Bid Item will be made at the applicable Contract unit price bid per each connection to existing water main as specified, acceptably furnished and installed as shown on the Contract Drawings or where directed by the Project Representative. Measurement will be based on each complete connection made and accepted. The work for this item includes but is not limited to removal of existing fittings and pipe as required, furnish and install all fittings, bolts, gaskets, thrust blocking, pipe restraints, excavation, backfill, couplings, plugs, caps, adapters, and materials except where specifically included in other pay items. Payment shall represent full compensation for all labor, materials, equipment, testing and disinfection necessary to complete this Bid Item, ready for approval and acceptance by the Engineer/Owner.

BID ITEM 22, 23, 24 - PIPE JOINT RESTRAINTS

Payment for all work included in this Bid Item will be made at the applicable Contract unit price bid for furnishing and installing pipe joint restraints as shown on the Contract Drawings. Payment shall represent full compensation for all labor, materials, necessary equipment, and incidentals necessary to complete the work.

BID ITEM 25 - GROUT FILL AND ABANDON PIPE

Payment for all work included in this Bid Item will be made at the applicable Contract unit price bid per cubic foot of grout for grouting the existing potable waterlines to be abandoned with cement as shown on the Contract Drawings. Payment shall represent full compensation for all labor, materials, necessary equipment, and incidentals necessary to complete the work, ready for approval and acceptance by the Engineer/Owner.

BID ITEM 26 - EROSION CONTROL

Payment for all work included in this Bid Item will be made at the applicable Contract lump sum price bid for furnishing and installing erosion control facilities as required by county and state regulations and as shown on the Contract Drawings. Payment shall represent full compensation for all labor, materials, necessary equipment, and incidentals necessary to complete the work.

BID ITEM 27 - TRAFFIC CONTROL

Payment for all work included in this Bid Item will be made at the applicable Contract lump sum price bid for preparing and implementing traffic control plans required by the County, including supply of all traffic control devices, signs, flagmen, barricades, detours, temporary signal re-timing, temporary striping, and other measures, Traffic plans shall be subject to approval by the County, and FDOT if applicable. Payment shall represent full compensation for all labor, materials and equipment and for all incidentals necessary for completion of this Bid Item.

BID ITEM 28 - SODDING

Payment for all work included in this Bid Item will be made at the applicable Contract unit price bid per square yard for furnishing and installing sod in accordance with the Specifications, as shown on the Contract Drawings or where directed by the Project Representative. Payment shall represent full compensation for all labor, materials, equipment, and incidentals necessary to complete the work, ready for approval and acceptance by the Engineer/Owner.

BID ITEM 29 DRIVEWAY RESTORATION

This Bid Item includes the removal and replacement of all existing driveway (asphalt or concrete) acceptably furnished and installed to match or exceed existing pavement thickness and to the limits shown on the drawings or where directed by the Project Representative. All concrete driveway removal shall be from existing joint to existing joint. Measurement will be according to the square yards of driveway replaced to the limits shown on the drawings or as authorized by the Project Representative. Payment for all work under this Bid Item shall be made at the applicable Contract unit price bid per square yard for removal and replacement of the existing driveway. The work shall include, but is not limited to, base preparation, forming, placing the driveway, compaction, finishing as specified, and all other related and necessary materials, work and equipment required associated with this item.

No additional payment will be made for driveway replacement where the Contractor is installing service lines by boring beneath. Damage to the driveway as a result of construction activities which are outside of areas where service main is open cut through the driveway or areas where the service main is further than two feet from the edge of the driveway, shall be the responsibility of the Contractor and shall not be included in the measurement and payment for this item.

BID ITEM 30 - SIDEWALK RESTORATION

Payment for all work included in this Bid Item will be made at the applicable Contract unit price bid per square yard for removal and replacement of existing concrete or asphalt sidewalk as shown on the Drawings or where directed by the Project Representative. Measurement will be per actual number of square yards of sidewalk installed and must match or exceed existing thickness. Payment shall represent full compensation for removal and replacement of existing sidewalk, including but not limited to all labor, material and equipment for compacting subgrade, forming, furnishing, placing the concrete or asphalt, and finishing as specified and all incidentals necessary for completion of this Bid Item, ready for

approval and acceptance by the Engineer/Owner.

BID ITEM 31 - MIAMI CURB REPLACEMENT

Payment for all work included in this Bid Item will be made at the applicable Contract unit price bid per linear foot for removal and replacement of existing Miami curb as shown on the Drawings or where directed by the Project Representative. Measurement will be per actual number of linear feet of Miami curb installed. Payment shall represent full compensation for removal and replacement of existing Miami curb, all labor, material and equipment for compacting subgrade, forming, furnishing, placing the concrete, and finishing as specified and all incidentals necessary for completion of this Bid Item, ready for approval and acceptance by the Engineer/Owner.

BID ITEM 32 - ASPHALT ROAD RESTORATION (BASE & RESURFACE)

Payment for all work included under this Bid Item will be made at the Contract unit price bid per square yard of base, friction course and finish course asphalt for furnishing, installing and testing the road restoration pavement section in accordance with the Specifications. Measurement will be based on the actual number of square yards of road restoration installed, tested, complete and approved. The measurement will be as shown on the Contract Plans or where directed by the Project Representative, but not greater than the width of the existing roadway prior to construction. Payment will include complete restoration of the roadway section in accordance with the applicable details on the Contract Drawings, to match existing pavement thickness, but not less than 1 inch of FDOT Type S-1 asphaltic concrete, the necessary base, and subbase or compacted suitable excavation material all in accordance with these Specifications. No payment for restoration of a private driveway within or outside the right-of-way shall be made under this Bid Item. Payment shall include all items and incidentals necessary to complete the road restoration in accordance with the requirements of Manatee County ready for approval and acceptance by the Engineer/Owner.

BID ITEM 33 - ASPHALT ROAD RESTORATION (MILL & OVERLAY)

Payment for all work included under this Bid Item will be made at the Contract unit price bid per square yard of asphalt overlay for milling, furnishing, installing and testing the road restoration pavement section in accordance with these Specifications. The entire area to be overlaid shall be milled. Measurement will be based on the actual number of square yards of road restoration installed, tested, complete and approved. The measurement will be as shown on the Contract Plans or where directed by the Project Representative, but not greater than the width of the existing roadway prior to construction. Payment will include complete restoration of the roadway section in accordance with the applicable details on the Contract Drawings, but not less than 1.5 inches of FDOT Type S- III asphaltic concrete, in accordance with these Specifications. Payment shall include all items and incidentals necessary to complete the road restoration in accordance with the requirements of Manatee County ready for approval and acceptance by the Engineer/Owner.

BID ITEM 34 - BLOWOFF ASSEMBLY

Payment for all work included in this Bid Item shall be made at the applicable Contract unit price bid per each blowoff for furnishing and installing the listed diameter blowoff assembly as shown on the Contract Drawings. Payment shall represent full compensation for all labor,

material, equipment, excavation, including but not limited to rock as necessary, bedding, backfill, compaction, testing and disinfection, blowoff assembly, gate valve, box, cover, fittings, copper tracer wire, and concrete pads required to complete this Bid Item.

BID ITEM 35 - 4" HDPE DR 11 C-906 WATER SERVICE TO SCHOOL

Payment for all work included in this Bid Item shall be made at the applicable Contract unit price bid per linear foot for furnishing and installing the listed diameter and class of HDPE water main (AWWA C-906, DR 11, Class 160) pipe and fittings as shown on the Contract Drawings or where directed by the Project Representative. Measurement and Payment shall be made for the actual length of the listed diameter pipe installed and acceptably furnished and will represent full compensation for all labor, materials, all non- DI fittings unless specifically included in other bid items, 10 gage copper clad steel wire, detectable tape, excavation, including rock, dewatering, connections to existing piping, bedding, backfill, compaction, directional drilling, testing and disinfection and equipment required to complete these Bid Items. No additional compensation will be made for excavation below the bottom of the pipe, for rock removal or bedding and backfill materials, or for repair of any settlement.

BID ITEM 36 - 3" SCHOOL MASTER METER COMPLETE (REMOVE/REPLACE)

Payment for all work included in this Bid Item shall be made at the applicable Contract lump sum bid for the Tillman School master meter removal and replacement, including but not limited to master meter assembly and appurtenances as shown on Detail UW 16, ductile iron pipe, restraints, valves, boxes, covers, backflow preventer, tracer wire & box, painting, concrete pads, restraining rods and/or thrust blocks, bolts, gaskets, and fittings as shown on the Contract Drawings. The work includes all excavation, removal and disposal of the existing master meter, vault, piping, and all appurtenances, disconnecting existing master meter and piping, connections to proposed master meter and piping, weekend work and/or temporary bypass to provide continuous water supply to school, and coordination and scheduling of work with the school staff. Payment shall represent full compensation for all labor, material, equipment, excavation, including rock, bedding, backfill, bollards, thrust blocking, compaction, testing, disposal and disinfection required to complete this Bid Item. Water meter and strainer will be supplied by the County. Contractor is responsible for master meter security during the Contract.

BID ITEM 37 - AIR RELEASE VALVE ASSEMBLY

Payment for all work included in this Bid Item shall be made at the applicable Contract unit price bid per each valve for furnishing and installing the listed diameter ARV Assembly as shown on the Contract Drawings. Payment shall represent full compensation for all labor, material, equipment, excavation, including but not limited to rock as necessary, bedding, backfill, compaction, testing and disinfection, ARV, gate valve, box, cover, fittings, copper tracer wire, vent pipe, cabinet, and concrete pads required to complete this Bid Item.

BID ITEM 38 - MOBILIZATION

Measurement and payment for this Bid Item shall include full compensation for the required 100 percent (100%) Performance Bond, 100 Percent (100%) Payment Bond, all required insurance for the project and the Contractor's mobilization and demobilization costs as shown in the Bid Form. Payment for mobilization shall not exceed 10 percent (10%) of the total Contract cost unless the Contractor can prove to the Owner that his actual mobilization cost

exceeds 10 percent (10%).

BID ITEM 39 - MISCELLANEOUS WORK AND CLEANUP

Payment for all work included under this Bid Item shall be made at the Contract lump sum price bid listed in the Bid Form and shall represent full compensation for all labor, materials and equipment required to perform all the work as shown on the Contract Drawings and specified herein and any other miscellaneous work not specifically included for payment under other Bid Items obviously necessary to complete the Contract. Partial payments will be based on the breakdown of the Bid Item in accordance with the Schedule of Values submitted by the Contractor and approved by the Engineer. Payment shall also include full compensation for project photographs, as-built record drawings, project signs, rubbish and spoil removal, repair, replacement or relocation of all signs, walls, private irrigation systems and related items and any and all other items required to complete the project in accordance with Contract Documents.

BID ITEM 40 - DISCRETIONARY WORK

Payment for all work under this Bid Item and listed in the Bid Form shall be made only at the Owner's discretion in order to satisfactorily complete the project in accordance with the Plans and Specifications.

PART 2 PRODUCTS (NOT USED)

PART 3 EXECUTION (NOT USED)

END OF SECTION

SECTION 01152 REQUESTS FOR PAYMENT

PART 1 GENERAL

1.01 REQUIREMENTS INCLUDED

Submit Applications for Payment to the Project Manager or as directed at the preconstruction meeting, in accordance with the schedule established by Conditions of the Contract and Agreement between Owner and Contractor.

1.02 FORMAT AND DATA REQUIRED

- A. Submit payment requests in the form provided by the Owner with itemized data typed in accordance with the Bid Form.
- B. Provide construction photographs in accordance with Contract Documents.

1.03 SUBSTANTIATING DATA FOR PROGRESS PAYMENTS

- A. When the Owner or the Engineer requires substantiating data, Contractor shall submit suitable information with a cover letter.
- B. Submit one copy of data and cover letter for each copy of application.

1.04 PREPARATION OF APPLICATION FOR FINAL PAYMENT

Fill in application form as specified for progress payments.

1.05 SUBMITTAL PROCEDURE

- A. Submit applications for payment at the times stipulated in the Agreement.
- B. Number: Three (3) copies of each application; all signed and certified by the Contractor.

PART 2 PRODUCTS (NOT USED)

PART 3 EXECUTION (NOT USED)

END OF SECTION

SECTION 01153 CHANGE ORDER PROCEDURES

PART 1 GENERAL

1.01 DEFINITION

- A. Change Order: Major change in contract scope or time that must be approved and executed by the Board before it becomes effective.
- B. Administrative Change Adjustment: Minor change order under 10% of project cost or 20% time, does not have to be Board approved.
- C. Field Directive Change: Change to contract quantity that does not require a change of scope or time extension.

1.02 REQUIREMENTS INCLUDED

- A. The Contractor shall promptly implement change order procedures:
 - 1. Provide full written data required to evaluate changes.
 - 2. Maintain detailed records of work done on a time-and-material/force account basis.
 - 3. Provide full documentation to Engineer on request.
- B. The Contractor shall designate a member of the Contractor's organization who:
 - 1. Is authorized to accept changes to the Work.
 - 2. Is responsible for informing others in the Contractor's employ of the authorized changes into the Work.

1.03 PRELIMINARY PROCEDURES

- A. Project Manager may initiate changes by submitting a Request to Contractor. Request will include:
 - 1. Detailed description of the change, products, costs and location of the change in the Project.
 - 2. Supplementary or revised Drawings and Specifications.
 - 3. The projected time extension for making the change.
 - 4. A specified period of time during which the requested price will be considered valid.
 - 5. Such request is for information only and is not an instruction to execute the changes, nor to stop work in progress.
- B. Contractor may initiate changes by submitting a written notice to the Project Manager, containing:
 - 1. Description of the proposed changes.
 - 2. Statement of the reason for making the changes.
 - 3. Statement of the effect on the Contract Sum and the Contract Time.
 - 4. Statement of the effect on the work of separate contractors.
 - 5. Documentation supporting any change in Contract Sum or Contract Time, as appropriate.

1.04 FIELD DIRECTIVE CHANGE

- A. In lieu of a Change Order, the Project Manager may issue a Field Directive change for the Contractor to proceed with additional work within the original intent of the Project.
- B. Field Directive change will describe changes in the work, with attachments of backup information to define details of the change.
- C. Contractor must sign and date the Field Directive change to indicate agreement with the terms therein.

1.05 DOCUMENTATION OF PROPOSALS AND CLAIMS

- A. Support each quotation for a lump sum proposal and for each unit price which has not previously been established, with sufficient substantiating data to allow the Engineer/Owner to evaluate the quotation.
- B. On request, provide additional data to support time and cost computations:
 - 1. Labor required.
 - 2. Equipment required.
 - 3. Products required.
 - a. Recommended source of purchase and unit cost.
 - b. Quantities required.
 - 4. Taxes, insurance and bonds.
 - 5. Credit for work deleted from Contract, similarly documented.
 - 6. Overhead and profit.
 - 7. Justification for any change in Contract Time.
- C. Support each claim for additional costs and for work done on a time-and-material/force account basis, with documentation as required for a lump-sum proposal.
 - 1. Name of the Owner's authorized agent who ordered the work and date of the order.
 - 2. Date and time work was performed and by whom.
 - 3. Time record, summary of hours work and hourly rates paid.
 - 4. Receipts and invoices for:
 - a. Equipment used, listing dates and time of use.
 - b. Products used, listing of quantities.
 - c. Subcontracts.

1.06 PREPARATION OF CHANGE ORDERS

- A. Project Manager will prepare each Change Order.
- B. Change Order will describe changes in the Work, both additions and deletions, with attachments as necessary to define details of the change.
- C. Change Order will provide an accounting of the adjustment in the Contract Sum and in the Contract Time.

1.07 LUMP SUM/FIXED PRICE CHANGE ORDER

- A. Project Manager initiates the form, including a description of the changes involved and attachments based upon documents and proposals submitted by the Contractor, or requests from the Owner, or both.
- B. Once the form has been completed, all copies should be sent to Contractor for approval. After approval by Contractor, all copies should be sent to Owner for approval. The Owner will distribute executed copies after approval by the Board of County Commissioners.

1.08 UNIT PRICE CHANGE ORDER

- A. Contents of Change Orders will be based on, either:
 - 1. Owner's definition of the scope of the required changes.
 - 2. Contractor's Proposal for a change, as approved by the Owner.
 - 3. Survey of completed work.
- B. The amounts of the unit prices to be:
 - 1. Those stated in the Agreement.
 - 2. Those mutually agreed upon between Owner and Contractor.

1.09 TIME AND MATERIAL/FORCE ACCOUNT CHANGE ORDER/CONSTRUCTION CHANGE AUTHORIZATION

- A. At completion of the change, Contractor shall submit itemized accounting and supporting data as provided in the Article "Documentation of Proposals and Claims" of this Section.
- B. Engineer will determine the allowable cost of such work, as provided in General Conditions and Supplementary Conditions.
- C. Engineer will sign and date the Change Order to establish the change in Contract Sum and in Contract Time.
- D. Owner and Contractor will sign and date the Change Order to indicate their agreement therewith.

1.10 CORRELATION WITH CONTRACTOR'S SUBMITTALS

- A. Periodically revise Schedule of Values and Application for Payment forms to record each change as a separate item of work, and to record the adjusted Contract Sum.
- B. Periodically revise the Construction Schedule to reflect each change in Contract Time. Revise sub schedules to show changes for other items of work affected by the changes.
- C. Upon completion of work under a Change Order, enter pertinent changes in Record Documents.

PART 2 PRODUCTS (NOT USED)

PART 3 EXECUTION (NOT USED)

END OF SECTION

SECTION 01200 PROJECT MEETINGS

PART 1 GENERAL

1.01 REQUIREMENTS INCLUDED

- A. The Owner or Engineer shall schedule the pre-construction meeting, periodic progress meetings and special meetings, if required, throughout progress of work.
- B. Representatives of contractors, subcontractors and suppliers attending meetings shall be qualified and authorized to act on behalf of the entity each represents.
- C. The Contractor shall attend meetings to ascertain that work is expedited consistent with Contract Documents and construction schedules.

1.02 PRE-CONSTRUCTION MEETING

- A. Attendance:
 - 1. Owner's Engineer.
 - 2. Owner's Project Manager
 - 3. Contractor.
 - 4. Resident Project Representative.
 - 5. Related Labor Contractor's Superintendent.
 - 6. Major Subcontractors.
 - 7. Major Suppliers.
 - 8. Others as appropriate.
- B. Suggested Agenda:
 - 1. Distribution and discussion of:
 - a. List of major subcontractors.
 - b. Projected Construction Schedules.
 - c. Coordination of Utilities
 - 2. Critical work sequencing.
 - 3. Project Coordination.
 - a. Designation of responsible personnel.
 - b. Emergency contact persons with phone numbers.
 - 4. Procedures and processing of:
 - a. Field decisions.
 - b. Submittals.
 - c. Change Orders.
 - d. Applications for Payment.
 - 5. Procedures for maintaining Record Documents.
 - 6. Use of premises:
 - a. Office, work and storage areas.
 - b. Owner's REQUIREMENTS.
 - 7. Temporary utilities.
 - 8. Housekeeping procedures.
 - 9. Liquidated damages.
 - 10. Equal Opportunity Requirements.
 - 11. Laboratory testing.

12. Project / Job meetings: Progress meeting, other special topics as needed.

PART 2 PRODUCTS (NOT USED)

PART 3 EXECUTION (NOT USED)

END OF SECTION

SECTION 01310 CONSTRUCTION SCHEDULE & PROJECT RESTRAINTS

PART 1 GENERAL

1.01 GENERAL

- A. Construction under this contract must be coordinated with the Owner and accomplished in a logical order to maintain utilization and flow through existing facilities and public properties and rights-of-way and to allow construction to be completed within the time allowed by Contract Documents and in the manner set forth in the Contract.

1.02 CONSTRUCTION SCHEDULING GENERAL PROVISIONS

- A. No work shall be done between 7:00 p.m. and 7:00 a.m. nor on weekends or legal holidays without written permission of the Owner. However, emergency work may be done without prior permission.
- B. Night work may be established by the Contractor as regular procedure with the written permission of the Owner. Such permission, however, may be revoked at any time by the Owner if the Contractor fails to maintain adequate equipment and supervision for the proper execution and control of the work at night.
- C. Due to potential health hazards and requirements of the State of Florida and the U.S. Environmental Protection Agency, existing facilities must be maintained in operation.
- D. The Contractor shall be fully responsible for providing all temporary piping, plumbing, electrical hook-ups, lighting, temporary structure, or other materials, equipment and systems required to maintain the existing facility's operations. All details of temporary piping and temporary construction are not necessarily shown on the Drawings or covered in the Specifications. However, this does not relieve the Contractor of the responsibility to insure that construction will not interrupt proper facility operations.
- E. The Contractor shall designate an authorized representative of his firm who shall be responsible for development and maintenance of the schedule and of progress and payment reports. This representative of the Contractor shall have direct project control and complete authority to act on behalf of the Contractor in fulfilling the commitments of the Contractor's schedule.

1.03 PROGRESS OF THE WORK

The work shall be executed with such progress as may be required to prevent any delay to the general completion of the work. The work shall be executed at such times and in or on such parts of the project and with such forces, materials and equipment to assure completion of the work in the time established by the Contract and in the manner set forth in the Contract.

PART 2 PRODUCTS

2.01 GENERAL REQUIREMENTS

- A. The Contractor shall submit a critical path schedule as described herein.

- B. The planning, scheduling, management and execution of the work is the sole responsibility of the Contractor. The progress schedule requirement is established to allow Engineer to review Contractor's planning, scheduling, management and execution of the work; to assist Engineer in evaluating work progress and make progress payments and to allow other contractors to cooperate and coordinate their activities with those of the Contractor.

2.02 FORM OF SCHEDULES

- A. Prepare schedules using the latest version of Microsoft Project, or other Owner approved software, in the form of a horizontal bar chart diagram. The diagram shall be time-scaled and sequenced by work areas. Horizontal time scale shall identify the first work day of each week.
- B. Activities shall be at least as detailed as the Schedule of Values. Activity durations shall be in whole working days. In addition, man-days shall be shown for each activity or tabulated in an accompanying report.
- C. Diagrams shall be neat and legible and submitted on sheets at least 8-1/2 inches by 11 inches suitable for reproduction. Scale and spacing shall allow space for notations and future revisions.

2.03 CONTENT OF SCHEDULES

- A. Each monthly schedule shall be based on data as of the last day of the current pay period.
- B. Description for each activity shall be brief, but convey the scope of work described.
- C. Activities shall identify all items of work that must be accomplished to achieve substantial completion, such as items pertaining to Contractor's installation and testing activities; items pertaining to the approval of regulatory agencies; contractor's time required for submittals, fabrication and deliveries; the time required by Engineer to review all submittals as set forth in the Contract Documents; items of work required of Owner to support pre-operational, startup and final testing; time required for the relocation of utilities. Activities shall also identify interface milestones with the work of other contractors performing work under separate contracts with Owner.
- D. Schedules shall show the complete sequence of construction by activities. Dates for beginning and completion of each activity shall be indicated as well as projected percentage of completion for each activity as of the first day of each month.
- E. Submittal schedule for shop drawing review, product data, and samples shall show the date of Contractor submittal and the date approved submittals will be required by the Engineer, consistent with the time frames established in the Specifications.
- F. For Contract change orders granting time extensions, the impact on the Contract date(s) shall equal the calendar-day total time extension specified for the applicable work in the Contract change orders.
- G. For actual delays, add activities prior to each delayed activity on the appropriate critical path(s). Data on the added activities of this type shall portray all steps leading to the delay and shall further include the following: separate activity identification, activity description indicating cause of the delay, activity duration consistent with whichever set of dates

below applies, the actual start and finish dates of the delay or, if the delay is not finished, the actual start date and estimated completion date.

- H. For potential delays, add an activity prior to each potentially delayed activity on the appropriate critical path(s). Data for added activities of this type shall include alternatives available to mitigate the delay including acceleration alternatives and further show the following: separate activity identification, activity description indicating cause of the potential delay and activity duration equal to zero work days.

2.04 SUPPORTING NARRATIVE

- A. Status and scheduling reports identified below shall contain a narrative to document the project status, to explain the basis of Contractor's determination of durations, describe the Contract conditions and restraints incorporated into the schedule and provide an analysis pertaining to potential problems and practical steps to mitigate them.
- B. The narrative shall specifically include:
 - 1. Actual completion dates for activities completed during the monthly report period and actual start dates for activities commenced during the monthly report period.
 - 2. Anticipated start dates for activities scheduled to commence during the following monthly report period.
 - 3. Changes in the duration of any activity and minor logic changes.
 - 4. The progress along the critical path in terms of days ahead or behind the Contract date.
 - 5. If the Monthly Status Report indicates an avoidable delay to the Contract completion date or interim completion dates as specified in the Agreement, Contractor shall identify the problem, cause and the activities affected and provide an explanation of the proposed corrective action to meet the milestone dates involved or to mitigate further delays.
 - 6. If the delay is thought to be unavoidable, the Contractor shall identify the problem, cause, duration, specific activities affected and restraints of each activity.
 - 7. The narrative shall also discuss all change order activities whether included or not in the revised/current schedule of legal status. Newly introduced change order work activities and the CPM path(s) that they affect, must be specifically identified. All change order work activities added to the schedule shall conform with the sequencing and Contract Time requirements of the applicable Change Order.
 - 8. Original Contract date(s) shall not be changed except by Contract change order. A revision need not be submitted when the foregoing situations arise unless required by Engineer. Review of a report containing added activities will not be construed to be concurrence with the duration or restraints for such added activities; instead the corresponding data as ultimately incorporated into the applicable Contract change order shall govern.
 - 9. Should Engineer require additional data, this information shall be supplied by Contractor within 10 calendar days.

2.05 SUBMITTALS

- A. Contractor shall submit estimated and preliminary progress schedules (as identified in the Terms and Conditions of the Contract and the General Conditions), monthly status reports, a start-up schedule and an as-built schedule report all as specified herein.

- B. All schedules, including estimated and preliminary schedules, shall be in conformance with the Contract Documents.
- C. The finalized progress schedule discussed in the Contract Documents shall be the first monthly status report and as such shall be in conformance with all applicable specifications contained herein.
- D. Monthly Status Report submittals shall include three copies of a time-scaled (days after notice to proceed) diagram showing all contract activities and supporting narrative. The initial detailed schedule shall use the notice to proceed as the start date. The finalized schedule, if concurred with by Owner, shall be the work plan to be used by the contractor for planning, scheduling, managing and executing the work.
- E. The schedule diagram shall be formatted as above. The diagram shall include (1) all detailed activities included in the preliminary and estimated schedule submittals, (2) calendar days prior to substantial completion, (3) summary activities for the remaining days. The critical path activities shall be identified, including critical paths for interim dates, if possible.
- F. The Contractor shall submit monthly progress schedules with each month's application for payment.
- G. Contractor shall submit three monthly status reports which will be retained by the Owner and Engineer.

2.06 MONTHLY STATUS REPORTS

- A. Contractor shall submit three copies of detailed schedule status reports on a monthly basis with the Application for Payment. The first such status report shall be submitted with the first Application for Payment and include data as of the last day of the pay period. The Monthly Report shall include a "marked-up" copy of the latest detailed schedule of legal status and a supporting narrative including updated information as described above. The Monthly Report will be reviewed by Engineer and Contractor at a monthly schedule meeting and Contractor will address Engineer's comments on the subsequent monthly report. Monthly status reports shall be the basis for evaluating Contractor's progress.
- B. The "marked-up" diagram shall show, for the latest detailed schedule of legal status, percentages of completion for all activities, actual start and finish dates and remaining durations, as appropriate. Activities not previously included in the latest detailed schedule of legal status shall be added, except that contractual dates will not be changed except by change order. Review of a marked-up diagram by Engineer will not be construed to constitute concurrence with the time frames, duration, or sequencing for such added activities; instead the corresponding data as ultimately incorporated into an appropriate change order shall govern.

2.07 STARTUP SCHEDULE

- A. At least 60 calendar days prior to the date of substantial completion, Contractor shall submit a time-scaled (days after notice to proceed) diagram detailing the work to take place in the period between 60 days prior to substantial completion, together with a supporting narrative. Engineer shall have 10 calendar days after receipt of the submittal to respond. Upon receipt of Engineer's comments, Contractor shall make the necessary

revisions and submit the revised schedule within 10 calendar days. The resubmittal, if concurred with by Owner, shall be the Work Plan to be used by Contractor for planning, managing, scheduling and executing the remaining work leading to substantial completion.

- B. The time-scaled diagram shall use the latest schedule of legal status for those activities completed ahead of the last 60 calendar days prior to substantial completion and detailed activities for the remaining 60-day period within the time frames outlined in the latest schedule of legal status.
- C. Contractor will be required to continue the requirement for monthly reports, as outlined above. In preparing this report, Contractor must assure that the schedule is consistent with the progress noted in the startup schedule.

2.08 REVISIONS

- A. All revised Schedule Submittals shall be made in the same form and detail as the initial submittal and shall be accompanied by an explanation of the reasons for such revisions, all of which shall be subject to review by Engineer and concurrence by Owner. The revision shall incorporate all previously made changes to reflect current as-built conditions. Minor changes to the approved submittal may be approved at monthly meetings; a minor change is not considered a revision in the context of this paragraph.
- B. A revised schedule submittal shall be submitted for review when required by Engineer.

PART 3 EXECUTION (NOT USED)

END OF SECTION

SECTION 01340 SHOP DRAWINGS, PROJECT DATA AND SAMPLES

PART 1 GENERAL

1.01 REQUIREMENTS INCLUDED

- A. The Contractor shall submit to the Engineer for review and approval: working drawings, shop drawings, test reports and data on materials and equipment (hereinafter in this section called data), and material samples (hereinafter in this section called samples) as are required for the proper control of work, including, but not limited to those working drawings, shop drawings, data and samples for materials and equipment specified elsewhere in the Specifications and in the Contract Drawings.
- B. Within thirty (30) calendar days after the effective date of the Agreement, the Contractor shall submit to the Engineer, a complete list of preliminary data on items for which Shop Drawings are to be submitted. Included in this list shall be the names of all proposed manufacturers furnishing specified items and the date on which each Shop Drawing shall be submitted. Review of this list by the Engineer shall in no way relieve the Contractor from submitting complete Shop Drawings and providing materials, equipment, etc., fully in accordance with the Specifications. This procedure is required in order to expedite final review of Shop Drawings.
- C. The Contractor is to maintain an accurate updated submittal log and will bring this log to each scheduled progress meeting with the Owner and the Engineer. This log should include the following items:
 - 1. Submittal description and number assigned.
 - 2. Date to Engineer.
 - 3. Date returned to Contractor (from Engineer).
 - 4. Status of Submittal (No exceptions taken, returned for confirmation or resubmittal, rejected).
 - 5. Date of Resubmittal and Return (as applicable).
 - 6. Date material released (for fabrication).
 - 7. Projected date of fabrication.
 - 8. Projected date of delivery to site.
 - 9. Projected date and required lead time so that product installation does not delay contact.
 - 10. Status of O&M manuals submitted.

1.03 CONTRACTOR'S RESPONSIBILITY

- A. It is the duty of the Contractor to check all drawings, data and samples prepared by or for him before submitting them to the Engineer for review. Each and every copy of the Drawings and data shall bear Contractor's stamp showing that they have been so checked. Shop drawings submitted to the Engineer without the Contractor's stamp will be returned to the Contractor for conformance with this requirement. Shop drawings shall indicate any deviations in the submittal from requirements of the contract Documents.
- B. Determine and verify:
 - 1. Field measurements.
 - 2. Field construction criteria.

3. Catalog numbers and similar data.
 4. Conformance with Specifications and indicate all variances from the Specifications.
- C. The Contractor shall furnish the Engineer a schedule of Shop Drawing submittals fixing the respective dates for the submission of shop and working drawings, the beginning of manufacture, testing and installation of materials, supplies and equipment. This schedule shall indicate those that are critical to the progress schedule.
- D. The Contractor shall not begin any of the work covered by a drawing, data, or a sample returned for correction until a revision or correction thereof has been reviewed and returned to him, by the Engineer, with No Exceptions Taken or Approved As Noted.
- E. The Contractor shall submit to the Engineer all drawings and schedules sufficiently in advance of construction requirements to provide no less than twenty-one (21) calendar days for checking and appropriate action from the time the Engineer receives them.
- F. The Contractor shall submit five (5) copies of descriptive or product data submittals to complement shop drawings for the Engineer plus the additional copies if the Contractor requires more than 1 being returned. The Engineer shall retain four (4) sets.
- G. The Contractor shall be responsible for and bear all cost of damages which may result from the ordering of any material or from proceeding with any part of work prior to the completion of the review by Engineer of the necessary Shop Drawings.

1.04 ENGINEER'S REVIEW OF SHOP DRAWINGS AND WORKING DRAWINGS

- A. The Engineer's review of drawings, data and samples submitted by the Contractor shall cover only general conformity to the Specifications, external connections and dimensions which affect the installation.
- B. The review of drawings and schedules shall be general and shall not be construed:
1. As permitting any departure from the Contract requirements.
 2. As relieving the Contractor of responsibility for any errors, including details, dimensions and materials.
 3. As approving departures from details furnished by the Engineer, except as otherwise provided herein.
- C. If the drawings or schedules as submitted describe variations and show a departure from the Contract requirements which the Engineer finds to be in the interest of the Owner and to be so minor as not to involve a change in Contract Price or time for performance, the Engineer may return the reviewed drawings without noting any exception.
- D. When reviewed by the Engineer, each of the Shop and Working Drawings shall be identified as having received such review being so stamped and dated. Shop Drawings stamped "REJECTED" and with required corrections shown shall be returned to the Contractor for correction and resubmittal.
- E. Resubmittals will be handled in the same manner as first submittals. On resubmittals, the Contractor shall direct specific attention, in writing or on resubmitted Shop Drawings, to revisions other than the corrections requested by the Engineer on previous submissions. The Contractor shall make any corrections required by the Engineer.

- F. If the Contractor considers any correction indicated on the drawings to constitute a change to the Contract Drawings or Specifications, the Contractor shall give written notice thereof to the Engineer.
- G. The Engineer shall review a submittal/resubmittal a maximum of three (3) times after which cost of review shall be borne by the Contractor. The cost of engineering shall be equal to the Engineer's actual payroll cost.
- H. When the Shop and Working Drawings have been completed to the satisfaction of the Engineer, the Contractor shall carry out the construction in accordance therewith and shall make no further changes therein except upon written instructions from the Engineer.
- I. No partial submittals shall be reviewed. Incomplete submittals shall be returned to the Contractor and shall be considered not approved until resubmitted.

1.05 SHOP DRAWINGS

- A. When used in the Contract Documents, the term "Shop Drawings" shall be considered to mean Contractor's plans for material and equipment which become an integral part of the Project. These drawings shall be complete and detailed. Shop Drawings shall consist of fabrication, drawings, setting drawings, schedule drawings, manufacturer's scale drawings and wiring and control diagrams. Cuts, catalogs, pamphlets, descriptive literature and performance and test data, shall be considered only as supportive to required Shop Drawings as defined above.
- B. Drawings and schedules shall be checked and coordinated with the work of all trades involved, before they are submitted for review by the Engineer and shall bear the Contractor's stamp of approval and original signature as evidence of such checking and coordination. Drawings or schedules submitted without this stamp of approval and original signature shall be returned to the Contractor for resubmission.
- C. Each Shop Drawing shall have a blank area 3-1/2 inches by 3-1/2 inches, located adjacent to the title block. The title block shall display the following:
 - 1. Number and title of the drawing.
 - 2. Date of Drawing or revision.
 - 3. Name of project building or facility.
 - 4. Name of contractor and subcontractor submitting drawing.
 - 5. Clear identification of contents and location of the work.
 - 6. Specification title and number.
- D. If drawings show variations from Contract requirements because of standard shop practice or for other reasons, the Contractor shall describe such variations in his letter of transmittal. If acceptable, proper adjustment in the contract shall be implemented where appropriate. If the Contractor fails to describe such variations, he shall not be relieved of the responsibility of executing the work in accordance with the Contract, even though such drawings have been reviewed.
- E. Data on materials and equipment shall include, without limitation, materials and equipment lists, catalog sheets, cuts, performance curves, diagrams, materials of construction and similar descriptive material. Materials and equipment lists shall give, for each item thereon, the name and location of the supplier or manufacturer, trade name, catalog reference, size, finish and all other pertinent data.

- F. For all mechanical and electrical equipment furnished, the Contractor shall provide a list including the equipment name and address and telephone number of the manufacturer's representative and service company so that service and/or spare parts can be readily obtained.
- G. All manufacturers or equipment suppliers who proposed to furnish equipment or products shall submit an installation list to the Engineer along with the required shop drawings. The installation list shall include at least five installations where identical equipment has been installed and have been in operation for a period of at least one (1) year.
- H. Only the Engineer will utilize the color "red" in marking shop drawing submittals.

1.06 WORKING DRAWINGS

- A. When used in the Contract Documents, the term "working drawings" shall be considered to mean the Contractor's fabrication and erection drawings for structures such as roof trusses, steelwork, precast concrete elements, bulkheads, support of open cut excavation, support of utilities, groundwater control systems, forming and false work; underpinning; and for such other work as may be required for construction of the project.
- B. Copies of working drawings as noted above, shall be submitted to the Engineer where required by the Contract Documents or requested by the Engineer and shall be submitted at least thirty (30) days (unless otherwise specified by the Engineer) in advance of their being required for work.
- C. Working drawings shall be signed by a registered Professional Engineer, currently licensed to practice in the State of Florida and shall convey, or be accompanied by, calculation or other sufficient information to completely explain the structure, machine, or system described and its intended manner of use. Prior to commencing such work, working drawings must have been reviewed without specific exceptions by the Engineer, which review will be for general conformance and will not relieve the Contractor in any way from his responsibility with regard to the fulfillment of the terms of the Contract. All risks of error are assumed by the Contractor; the Owner and Engineer shall not have responsibility therefor.

1.07 SAMPLES

- A. The Contractor shall furnish, for the review of the Engineer, samples required by the Contract Documents or requested by the Engineer. Samples shall be delivered to the Engineer as specified or directed. The Contractor shall prepay all shipping charges on samples. Materials or equipment for which samples are required shall not be used in work until reviewed by the Engineer.
- B. Samples shall be of sufficient size and quantity to clearly illustrate:
 - 1. Functional characteristics of the product, with integrally related parts and attachment devices.
 - 2. Full range of color, texture and pattern.
 - 3. A minimum of two samples of each item shall be submitted.
- C. Each sample shall have a label indicating:

1. Name of product.
2. Name of Contractor and Subcontractor.
3. Material or equipment represented.
4. Place of origin.
5. Name of Producer and Brand (if any).
6. Location in project.
(Samples of finished materials shall have additional markings that will identify them under the finished schedules.)
7. Reference specification paragraph.

- D. The Contractor shall prepare a transmittal letter in triplicate for each shipment of samples containing the information required above. He shall enclose a copy of this letter with the shipment and send a copy of this letter to the Engineer. Review of a sample shall be only for the characteristics or use named in such and shall not be construed to change or modify any Contract requirements.
- E. Reviewed samples not destroyed in testing shall be sent to the Engineer or stored at the site of the work. Reviewed samples of the hardware in good condition will be marked for identification and may be used in the work. Materials and equipment incorporated in work shall match the reviewed samples. If requested at the time of submission, samples which failed testing or were rejected shall be returned to the Contractor at his expense.

PART 2 PRODUCTS (NOT USED)

PART 3 EXECUTION (NOT USED)

END OF SECTION

SECTION 01370 SCHEDULE OF VALUES

PART 1 GENERAL

1.01 REQUIREMENTS INCLUDED

- A. The Contractor shall submit to the Engineer a Schedule of Values allocated to the various portions of the work, within 10 days after date of Notice to Proceed.
- B. Upon request of the Engineer, the Contractor shall support the values with data which will substantiate their correctness.
- C. The Schedule of Values shall be used only as the basis for the Contractor's Applications for Payment.

1.02 FORM AND CONTENT OF SCHEDULE OF VALUES

- A. Schedule of Values will be considered for approval by Engineer upon Contractor's request. Identify schedule with:
 - 1. Title of Project and location.
 - 2. Project number.
 - 3. Name and address of Contractor.
 - 4. Contract designation.
 - 5. Date of submission.
- B. Schedule of Values shall list the installed value of the component parts of the work in sufficient detail to serve as a basis for computing values for progress payments during construction.
- C. Follow the table of contents for the Contract Document as the format for listing component items for structures:
 - 1. Identify each line item with the number and title of the respective major section of the specification.
 - 2. For each line item, list sub values of major products or operations under item.
- D. Follow the bid sheets included in this Contract Documents as the format for listing component items for pipe lines.
- E. The sum of all values listed in the schedule shall equal the total Contract sum.

PART 2 PRODUCTS (NOT USED)

PART 3 EXECUTION (NOT USED)

END OF SECTION

SECTION 01380 CONSTRUCTION PHOTOGRAPHS

PART 1 GENERAL

1.01 REQUIREMENTS INCLUDED

- A. The Contractor shall employ a competent photographer to take construction record photographs or perform video, recording including furnishing all labor, materials, equipment and incidentals necessary to obtain photographs and/or video recordings of all construction areas.
- B. Preconstruction record information shall consist of video recordings on digital video disks (DVD).
- C. Construction progress information shall consist of photographs and digital photographs on a recordable compact disc (CD-R).

1.02 QUALIFICATIONS

- A. All photography shall be done by a competent camera operator who is fully experienced and qualified with the specified equipment.
- B. For the video recording, the audio portion should be done by a person qualified and knowledgeable in the specifics of the Contract, who shall speak with clarity and diction so as to be easily understood.

1.03 PROJECT PHOTOGRAPHS

- A. Provide two prints of each photograph with each pay application.
- B. Provide one recordable compact disc with digital photographs with each pay application.
- C. Negatives:
 - 1. All negatives shall remain the property of photographer.
 - 2. The Contractor shall require that photographer maintain negatives or protected digital files for a period of two years from date of substantial completion of the project.
 - 3. Photographer shall agree to furnish additional prints to Owner and Engineer at commercial rates applicable at time of purchase. Photographer shall also agree to participate as required in any litigation requiring the photographer as an expert witness.
- D. The Contractor shall pay all costs associated with the required photography and prints. Any parties requiring additional photography or prints shall pay the photographer directly.
- E. All project photographs shall be a single weight, color image. All finishes shall be smooth surface and glossy and all prints shall be 8 inches x 10 inches.
- F. Each print shall have clearly marked on the back, the name of the project, the orientation of view, the date and time of exposure, name and address of the photographer and the photographers numbered identification of exposure.

- G. All project photographs shall be taken from locations to adequately illustrate conditions prior to construction, or conditions of construction and state of progress. The Contractor shall consult with the Engineer at each period of photography for instructions concerning views required.

1.04 VIDEO RECORDINGS

- A. Video, recording shall be done along all routes that are scheduled for construction. Video, recording shall include full, recording of both sides of all streets and the entire width of easements plus 10 feet on each side on which construction is to be performed. All video recording shall be in full color.
- B. A complete view, in sufficient detail with audio description of the exact location shall be provided.
- C. The engineering plans shall be used as a reference for stationing in the audio portion of the recordings for easy location identification.
- D. Two complete sets of video recordings shall be delivered to the Engineer on digital video disks (DVD) for the permanent and exclusive use of the Engineer prior to the start of any construction on the project.
- E. All video recordings shall contain the name of the project, the date and time of the video, recording, the name and address of the photographer and any other identifying information required.
- F. Construction shall not start until preconstruction video recordings are completed, submitted and accepted by the Engineer. In addition, no progress payments shall be made until the preconstruction video recordings are accepted by the Engineer.

PART 2 PRODUCTS (NOT USED)

PART 3 EXECUTION (NOT USED)

END OF SECTION

SECTION 01410 TESTING AND TESTING LABORATORY SERVICES

PART 1 GENERAL

1.01 REQUIREMENTS INCLUDED

- A. Owner shall employ and pay for the services of an independent testing laboratory to perform testing specifically indicated on the Contract Documents or called out in the Specifications. Owner may elect to have materials and equipment tested for conformity with the Contract Documents at any time.
 - 1. Contractor shall cooperate fully with the laboratory to facilitate the execution of its required services.
 - 2. Employment of the laboratory shall in no way relieve the Contractor's obligations to perform the work of the Contract.

1.02 LIMITATIONS OF AUTHORITY OF TESTING LABORATORY

- A. Laboratory is not authorized to:
 - 1. Release, revoke, alter or enlarge on requirements of Contract Documents.
 - 2. Approve or accept any portion of the Work.
 - 3. Perform any duties of the Contractor.

1.03 CONTRACTOR'S RESPONSIBILITIES

- A. Cooperate with laboratory personnel; provide access to Work and/or to Manufacturer's operations.
- B. Secure and deliver to the laboratory adequate quantities of representational samples of materials proposed to be used and which require testing.
- C. Provide to the laboratory the preliminary design mix proposed to be used for concrete, and other material mixes which require control by the testing laboratory.
- D. Materials and equipment used in the performance of work under this Contract are subject to inspection and testing at the point of manufacture or fabrication. Standard specifications for quality and workmanship are indicated in the Contract Documents. The Engineer may require the Contractor to provide statements or certificates from the manufacturers and fabricators that the materials and equipment provided by them are manufactured or fabricated in full accordance with the standard specifications for quality and workmanship indicated in the Contract Documents. All costs of this testing and providing statements and certificates shall be a subsidiary obligation of the Contractor and no extra charge to the Owner shall be allowed on account of such testing and certification.
- E. Furnish incidental labor and facilities:
 - 1. To provide access to work to be tested.
 - 2. To obtain and handle samples at the project site or at the source of the product to be tested.
 - 3. To facilitate inspections and tests.
 - 4. For storage and curing of test samples.

- F. Notify laboratory sufficiently in advance of operations to allow for laboratory assignment of personnel and scheduling of tests.
 - 1. When tests or inspections cannot be performed due to insufficient notice, Contractor shall reimburse Owner for laboratory personnel and travel expenses incurred due to Contractor's negligence.
- G. Employ and pay for the services of the same or a separate, equally qualified independent testing laboratory to perform additional inspections, sampling and testing required for the Contractor's convenience and as approved by the Engineer.
- H. If the test results indicate the material or equipment complies with the Contract Documents, the Owner shall pay for the cost of the testing laboratory. If the tests and any subsequent retests indicate the materials and equipment fail to meet the requirements of the Contract Documents, the contractor shall pay for the laboratory costs directly to the testing firm or the total of such costs shall be deducted from any payments due the Contractor.

PART 2 PRODUCTS (NOT USED)

PART 3 EXECUTION (NOT USED)

END OF SECTION

SECTION 01510 TEMPORARY AND PERMANENT UTILITIES

PART 1 GENERAL

1.01 REQUIREMENTS INCLUDED

The Contractor shall be responsible for furnishing all requisite temporary utilities, i.e., power, water, sanitation, etc. The Contractor shall obtain and pay for all permits required as well as pay for all temporary usages. The Contractor shall remove all temporary facilities upon completion of work.

1.02 REQUIREMENTS OF REGULATORY AGENCIES

- A. Comply with National Electric Code.
- B. Comply with Federal, State and Local codes and regulations and with utility company requirements.
- C. Comply with County Health Department regulations.

PART 2 PRODUCTS

2.01 MATERIALS, GENERAL

Materials for temporary utilities may be "used". Materials for electrical utilities shall be adequate in capacity for the required usage, shall not create unsafe conditions and shall not violate requirements of applicable codes and standards.

2.02 TEMPORARY ELECTRICITY AND LIGHTING

Arrange with the applicable utility company for temporary power supply. Provide service required for temporary power and lighting and pay all costs for permits, service and for power used.

2.03 TEMPORARY WATER

- A. The Contractor shall arrange with Manatee County Utilities Customer Service office to provide water for construction purposes, i.e., meter, pay all costs for installation, maintenance and removal, and service charges for water used.
- B. The Contractor shall protect piping and fitting against freezing.

2.04 TEMPORARY SANITARY FACILITIES

- A. The Contractor shall provide sanitary facilities in compliance with all laws and regulations.
- B. The Contractor shall service, clean and maintain facilities and enclosures.

PART 3 EXECUTION

3.01 GENERAL

- A. The Contractor shall maintain and operate systems to assure continuous service.
- B. The Contractor shall modify and extend systems as work progress requires.

3.02

REMOVAL

- A. The Contractor shall completely remove temporary materials and equipment when their use is no longer required.
- B. The Contractor shall clean and repair damage caused by temporary installations or use of temporary facilities.

END OF SECTION

SECTION 01570 TRAFFIC REGULATION

PART 1 GENERAL

1.01 REQUIREMENTS INCLUDED

- A. The Contractor shall be responsible for providing safe and expeditious movement of traffic through construction zones. A construction zone is defined as the immediate areas of actual construction and all abutting areas which are used by the Contractor and which interfere with the driving or walking public.
- B. The Contractor shall remove temporary equipment and facilities when no longer required, restore grounds to original or to specified conditions.

1.02 TRAFFIC CONTROL

- A. The necessary traffic control shall include, but not be limited to, such items as proper construction warning signs, signals, lighting devices, markings, barricades, channelization and hand signaling devices. The Contractor shall be responsible for installation and maintenance of all devices and detour routes and signage for the duration of the construction period. The Contractor shall utilize the appropriate traffic plan from the FDOT Maintenance of Traffic Standards, Series 600 of the FDOT Roadway & Traffic Design Standards, Latest Edition.
- B. Should there be the necessity to close any portion of a roadway carrying vehicles or pedestrians the Contractor shall submit a Traffic Control Plan (TCP) at least 5 days before a partial or full day closure, and at least 8 days before a multi-day closure. TCP shall be submitted, along with a copy of their accreditation, by a certified IMSA or ATSA Traffic Control Specialist.
 - 1. At no time will more than one (1) lane of a roadway be closed to vehicles and pedestrians without an approved road closure from the County Transportation Department. With any such closings, adequate provision shall be made for the safe expeditious movement of each.
 - 2. All traffic control signs must be in place and inspected at least 1 day in advance of the closure. Multi-day closures notification signs shall be in place at least 3 days in advance of the closure. All signs must be covered when no in effect, and checked twice a day by the Worksite Traffic Supervisor when they are in effect.
- C. The Contractor shall be responsible for removal, relocation, or replacement of any traffic control device in the construction area which exists as part of the normal preconstruction traffic control scheme. Any such actions shall be performed by the Contractor under the supervision and in accordance with the instructions of the applicable highway department unless otherwise specified.
- D. The Engineer will consult with the Owner immediately on any vehicular or pedestrian safety or efficiency problem incurred as a result of construction of the project.
- E. The Contractor shall provide ready access to businesses and homes in the project area during construction. The Contractor shall be responsible for coordinating this work with affected homeowners.

- F. When conditions require the temporary installation of signs, pavement markings and traffic barriers for the protection of workers and traffic, the entire array of such devices shall be depicted on working drawings for each separate stage of work. These drawings shall be submitted to the Engineer for review and approval prior to commencement of work on the site.
- G. Precast concrete traffic barriers shall be placed adjacent to trenches and other excavations deeper than six inches below the adjacent pavement surface.

PART 2 PRODUCTS (NOT USED)

PART 3 EXECUTION (NOT USED)

END OF SECTION

SECTION 01580 PROJECT IDENTIFICATION AND SIGNS

PART 1 GENERAL

1.01 REQUIREMENTS INCLUDED

- A. Furnish, install and maintain County project identification signs.
- B. Remove signs on completion of construction.
- C. Allow no other signs to be displayed except for traffic control and safety.

1.02 PROJECT IDENTIFICATION SIGN (COUNTY)

- A. One painted sign, of not less than 32 square feet (3 square meters) area, with painted graphic content to include:
 - 1. Title of Project.
 - 2. Name of Owner.
 - 3. Names and titles of authorities as directed by Owner.
 - 4. Prime Contractor.
- B. Graphic design, style of lettering and colors: As approved by the Engineer and subject to approval of the Owner.
- C. Erect on the site at a lighted location of high public visibility, adjacent to main entrance to site, as approved by the Engineer and the Owner

1.03 INFORMATIONAL SIGNS

- A. Painted signs with painted lettering, or standard products.
 - 1. Size of signs and lettering: as required by regulatory agencies, or as appropriate to usage.
 - 2. Colors: as required by regulatory agencies, otherwise of uniform colors throughout project.
- B. Erect at appropriate locations to provide required information.

1.04 QUALITY ASSURANCE

- A. Sign Painter: Professional experience in type of work required.
- B. Finishes, Painting: Adequate to resist weathering and fading for scheduled construction period.

1.05 PUBLIC NOTIFICATION

- A. Door Hangers: Manatee County Project Management shall generate and the General Contractor shall distribute door hangers to all residents who will be impacted by project construction.

- D. Paint: Exterior quality, as specified in the Contract Documents.

PART 3 EXECUTION

3.01 PROJECT IDENTIFICATION SIGN

- A. Paint exposed surface or supports, framing and surface material; one coat of primer and one coat of exterior paint.
- B. Paint graphics in styles, size and colors selected.

3.02 MAINTENANCE

The Contractor shall maintain signs and supports in a neat, clean condition; repair damages to structures, framing or sign.

3.03 REMOVAL

The Contractor shall remove signs, framing, supports and foundations at completion of project.

END OF SECTION

SECTION 01600 MATERIAL AND EQUIPMENT

PART 1 GENERAL

1.01 REQUIREMENTS INCLUDED

- A. Material and equipment incorporated into the work:
1. Conform to applicable specifications and standards.
 2. Comply with size, make, type and quality specified, or as specifically approved in writing by the Engineer.
 3. Manufactured and Fabricated Products:
 - a. Design, fabricate and assemble in accordance with the best engineering and shop practices.
 - b. Manufacture like parts of duplicate units to standard sizes and gages, to be interchangeable.
 - c. Two or more items of the same kind shall be identical and manufactured by the same manufacturer.
 - d. Products shall be suitable for service conditions.
 - e. Equipment capacities, sizes and dimensions shown or specified shall be adhered to unless variations are specifically approved in writing.
 4. Do not use material or equipment for any purpose other than that for which it is specified.
 5. All material and equipment incorporated into the project shall be new.

1.02 MANUFACTURER'S INSTRUCTIONS

- A. When Contract Documents require that installation of work shall comply with manufacturer's printed instructions, obtain and distribute copies of such instructions to parties involved in the installation, including two copies to Engineer. Maintain one set of complete instructions at the job site during installation and until completion.
- B. Handle, install, connect, clean, condition and adjust products in strict accordance with such instructions and in conformity with specified requirements. Should job conditions or specified requirements conflict with manufacturer's instructions, consult with Engineer prior to proceeding. Do not proceed with work without clear instructions.

1.03 TRANSPORTATION AND HANDLING

- A. Arrange deliveries of products in accordance with construction schedules, coordinate to avoid conflict with work and conditions at the site.
1. Deliver products in undamaged condition, in manufacturer's original containers or packaging, with identifying labels intact and legible.
 2. Immediately on delivery, inspect shipments to assure compliance with requirements of Contract Documents and approved submittals and that products are properly protected and undamaged.
- B. Provide equipment and personnel to handle products by methods to prevent soiling or damage to products or packaging.

1.04 SUBSTITUTIONS AND PRODUCT OPTIONS

Contractor's Options:

1. For products specified only by reference standard, select any product meeting that standard.
2. For products specified by naming one or more products or manufacturers and "or equal", Contractor must submit a request for substitutions of any product or manufacturer not specifically named in a timely manner so as not to adversely affect the construction schedule.

PART 2 PRODUCTS (NOT USED)

PART 3 EXECUTION (NOT USED)

END OF SECTION

SECTION 01620 STORAGE AND PROTECTION

PART 1 GENERAL

1.01 REQUIREMENTS INCLUDED

Provide secure storage and protection for products to be incorporated into the work and maintenance and protection for products after installation and until completion of Work.

1.02 STORAGE

- A. Store products immediately on delivery and protect until installed in the Work, in accord with manufacturer's instructions, with seals and labels intact and legible.
- B. Exterior Storage
 - 1. Provide substantial platform, blocking or skids to support fabricated products above ground to prevent soiling or staining.
 - a. Cover products, subject to discoloration or deterioration from exposure to the elements, with impervious sheet coverings. Provide adequate ventilation to avoid condensation.
 - b. Prevent mixing of refuse or chemically injurious materials or liquids.
- A. Arrange storage in manner to provide easy access for inspection.

1.03 MAINTENANCE OF STORAGE

- A. Maintain periodic system of inspection of stored products on scheduled basis to assure that:
 - 1. State of storage facilities is adequate to provide required conditions.
 - 2. Required environmental conditions are maintained on continuing basis.
 - 3. Surfaces of products exposed to elements are not adversely affected. Any weathering of products, coatings and finishes is not acceptable under requirements of these Contract Documents.
- B. Mechanical and electrical equipment which requires servicing during long term storage shall have complete manufacturer's instructions for servicing accompanying each item, with notice of enclosed instructions shown on exterior of package.
 - 1. Equipment shall not be shipped until approved by the Engineer. The intent of this requirement is to reduce on-site storage time prior to installation and/or operation. Under no circumstances shall equipment be delivered to the site more than one month prior to installation without written authorization from the Engineer.
 - 2. All equipment having moving parts such as gears, electric motors, etc. and/or instruments shall be stored in a temperature and humidity controlled building approved by the Engineer until such time as the equipment is to be installed.
 - 3. All equipment shall be stored fully lubricated with oil, grease, etc. unless otherwise instructed by the manufacturer.
 - 4. Moving parts shall be rotated a minimum of once weekly to insure proper lubrication and to avoid metal-to-metal "welding". Upon installation of the equipment, the Contractor shall start the equipment, at least half load, once weekly

for an adequate period of time to insure that the equipment does not deteriorate from lack of use.

5. Lubricants shall be changed upon completion of installation and as frequently as required, thereafter during the period between installation and acceptance.
6. Prior to acceptance of the equipment, the Contractor shall have the manufacturer inspect the equipment and certify that its condition has not been detrimentally affected by the long storage period. Such certifications by the manufacturer shall be deemed to mean that the equipment is judged by the manufacturer to be in a condition equal to that of equipment that has been shipped, installed, tested and accepted in a minimum time period. As such, the manufacturer will guaranty the equipment equally in both instances. If such a certification is not given, the equipment shall be judged to be defective. It shall be removed and replaced at the Contractor's expense.

1.04 PROTECTION AFTER INSTALLATION

- A. Provide protection of installed products to prevent damage from subsequent operations. Remove when no longer needed, prior to completion of work.
- B. Control traffic to prevent damage to equipment and surfaces.
- C. Provide coverings to protect finished surfaces from damage.

PART 2 PRODUCTS (NOT USED)

PART 3 EXECUTION (NOT USED)

END OF SECTION

SECTION 01700 CONTRACT CLOSEOUT

PART 1 GENERAL

1.01 REQUIREMENTS INCLUDED

Comply with requirements stated in Conditions of the Contract and in Specifications for administrative procedures in closing out the work.

1.02 SUBSTANTIAL COMPLETION

- A. The Contractor shall submit the following items when the Contractor considers the work to be substantially complete:
1. A written notice that the work, or designated portion thereof, is substantially complete.
 2. A list of items to be completed or corrected.
- B. Within a reasonable time after receipt of such notice, the Engineer and Owner shall make an inspection to determine the status of completion.
- C. Project record documents and operations and maintenance manuals must be submitted before the project shall be considered substantially complete.
- D. If the Engineer determines that the work is not substantially complete:
1. The Engineer shall notify the Contractor in writing, stating the reasons.
 2. The Contractor shall remedy the deficiencies in the work and send a second written notice of substantial completion to the Engineer.
 3. The Engineer shall reinspect the work.
- E. When the Engineer finds that the work is substantially complete:
1. He shall prepare and deliver to the Owner a tentative Certificate of Substantial Completion (Manatee County Project Management Form PMD-8) with a tentative list of the items to be completed or corrected before final payment.
 2. The Engineer shall consider any objections made by the Owner as provided in Conditions of the Contract. When the Engineer considers the work substantially complete, he will execute and deliver to the Owner and the Contractor a definite Certificate of Substantial Completion (Manatee County Project Management Form PMD-8) with a revised tentative list of items to be completed or corrected.

1.03 FINAL INSPECTION

- A. When the Contractor considered the work to be complete, he shall submit written certification stating that:
1. The Contract Documents have been reviewed.
 2. The work has been inspected for compliance with Contract Documents.
 3. The work has been completed in accordance with Contract Documents.
 4. The equipment and systems have been tested in the presence of the Owner's representative and are operational.

5. The work is completed and ready for final inspection.
- B. The Engineer shall make an inspection to verify the status of completion after receipt of such certification.
- C. If the Engineer determines that the work is incomplete or defective:
 1. The Engineer shall promptly notify the Contractor in writing, listing the incomplete or defective work.
 2. The Contractor shall take immediate steps to remedy the stated deficiencies and send a second written certification to Engineer that the work is complete.
 3. The Engineer shall reinspect the work.
- D. Upon finding the work to be acceptable under the Contract Documents, the Engineer shall request the Contractor to make closeout submittals.
- E. For each additional inspection beyond a total of three (3) inspections for substantial and final completion due to the incompleteness of the work, the Contractor shall reimburse the Owner for the Engineer's fees.

1.04 CONTRACTOR'S CLOSEOUT SUBMITTALS TO ENGINEER

- A. Project Record Documents (prior to substantial completion).
- B. Operation and maintenance manuals (prior to substantial completion).
- C. Warranties and Bonds.
- D. Evidence of Payment and Release of Liens: In accordance with requirements of General and Supplementary Conditions.
- E. Certification letter from Florida Department of Transportation and Manatee County Department of Transportation, as applicable.
- F. Certificate of Insurance for Products and Completed Operations.
- G. Final Reconciliation, Warranty Period Declaration, and Contractor's Affidavit (Manatee County Project Management Form PMD-9).

1.05 FINAL ADJUSTMENT OF ACCOUNTS

- A. Submit a final statement of accounting to the Engineer.
- B. Statement shall reflect all adjustments to the Contract Sum:
 1. The original Contract Sum.
 2. Additions and deductions resulting from:
 - a. Previous Change Orders
 - b. Unit Prices
 - c. Penalties and Bonuses
 - d. Deductions for Liquidated Damages
 - e. Other Adjustments
 3. Total Contract Sum, as adjusted.

4. Previous payments.
5. Sum remaining due.

- C. Project Management shall prepare a final Change Order, reflecting approved adjustments to the Contract Sum which were not previously made by Change Orders.

1.06 FINAL APPLICATION FOR PAYMENT

Contractor shall submit the final Application for Payment in accordance with procedures and requirements stated in the Conditions of the Contract.

PART 2 PRODUCTS (NOT USED)

PART 3 EXECUTION (NOT USED)

END OF SECTION

SECTION 01710 CLEANING

PART 1 GENERAL

1.01 REQUIREMENTS INCLUDED

Execute cleaning during progress of the work and at completion of the work, as required by the General Conditions.

1.02 DISPOSAL REQUIREMENTS

Conduct cleaning and disposal operations to comply with all Federal, State and Local codes, ordinances, regulations and anti-pollution laws.

PART 2 PRODUCTS

2.01 MATERIALS

- A. Use only those cleaning materials which will not create hazards to health or property and which will not damage surfaces.
- B. Use only those cleaning materials and methods recommended by manufacturer of the surface material to be cleaned.
- C. Use cleaning materials only on surfaces recommended by cleaning material manufacturer.

PART 3 EXECUTION

3.01 DURING CONSTRUCTION

- A. Execute periodic cleaning to keep the work, the site and adjacent properties free from accumulation of waste materials, rubbish and wind-blown debris, resulting from construction operations.
- B. Provide on-site containers for the collection of waste materials, debris and rubbish.
- C. Remove waste materials, debris and rubbish from the site periodically and dispose of at legal disposal areas away from the site.

3.02 DUST CONTROL

- A. Clean interior spaces prior to the start of finish painting and continue cleaning on an as-needed basis until painting is finished.
- B. Schedule operations so that dust and other contaminants resulting from cleaning process will not fall on wet or newly-coated surfaces.

3.03 FINAL CLEANING

- A. Employ skilled workmen for final cleaning.
- B. Broom clean exterior paved surfaces; rake clean other surfaces of the grounds.

- C. Prior to final completion or Owner occupancy, Contractor shall conduct an inspection of sight-exposed interior and exterior surfaces and all work areas to verify that the entire work is clean.

END OF SECTION

SECTION 01720 PROJECT RECORD DOCUMENTS

PART 1 GENERAL

1.01 REQUIREMENTS INCLUDED

- A. Contractor shall maintain at the site for the Owner one record copy of:
 - 1. Drawings.
 - 2. Specifications.
 - 3. Addenda.
 - 4. Change Orders and other modifications to the Contract.
 - 5. Engineer's field orders or written instructions.
 - 6. Approved shop drawings, working drawings and samples.
 - 7. Field test records.
 - 8. Construction photographs.

1.02 MAINTENANCE OF DOCUMENTS AND SAMPLES

- A. Store documents and samples in Contractor's field office apart from documents used for construction.
 - 1. Provide files and racks for storage of documents.
 - 2. Provide locked cabinet or secure storage space for storage of samples.
- B. File documents and samples in accordance with CSI format.
- C. Maintain documents in a clean, dry, legible, condition and in good order. Do not use record documents for construction purposes.
- D. Make documents and samples available at all times for inspection by the Engineer.

1.03 MARKING DEVICES

- A. Provide felt tip marking pens for recording information in the color code designated by the Engineer.

1.04 RECORDING

- A. Label each document "PROJECT RECORD" in neat large printed letters.
- B. Record information concurrently with construction progress.
- C. Do not conceal any work until required information is recorded.
- D. Drawings; Legibly mark to record actual construction:
 - 1. All underground piping with elevations and dimensions. Changes to piping location. Horizontal and vertical locations of underground utilities and appurtenances, referenced to permanent surface improvements. Actual installed pipe material, class, etc. Locations of drainage ditches, swales, water lines and force mains shall be shown every 200 feet (measured along the centerline) or

- alternate lot lines, whichever is closer. Dimensions at these locations shall indicate distance from centerline of right-of-way to the facility.
2. Field changes of dimension and detail.
 3. Changes made by Field Order or by Change Order.
 4. Details not on original contract drawings.
 5. Equipment and piping relocations.
 6. Locations of all valves, fire hydrants, manholes, water and sewer services, water and force main fittings, underdrain cleanouts, catch basins, junction boxes and any other structures located in the right-of-way or easement, shall be located by elevation and by station and offset based on intersection P.I.'s and centerline of right-of-way. For facilities located on private roads, the dimensioning shall be from centerline of paving or another readily visible baseline.
 7. Elevations shall be provided for all manhole rim and inverts; junction box rim and inverts; catch basin rim and inverts; and baffle, weir and invert elevations in control structures. Elevations shall also be provided at the PVI's and at every other lot line or 200 feet, whichever is less, of drainage swales and ditches. Bench marks and elevation datum shall be indicated.
 8. Slopes for pipes and ditches shall be recalculated, based on actual field measured distances, elevations, pipe sizes, and type shown. Cross section of drainage ditches and swales shall be verified.
 9. Centerline of roads shall be tied to right-of-way lines. Elevation of roadway centerline shall be given at PVI's and at all intersections.
 10. Record drawings shall show bearings and distances for all right-of-way and easement lines, and property corners.
 11. Sidewalks, fences and walls, if installed at the time of initial record drawing submittal, shall be located every 200 feet or alternate lot lines, whichever is closer. Dimensions shall include distance from the right-of-way line and the back of curb and lot line or easement line.
 12. Sanitary sewer mainline wyes shall be located from the downstream manhole. These dimensions shall be provided by on-site inspections or televising of the sewer following installation.
 13. Elevations shall be provided on the top of operating nuts for all water and force main valves.
 14. Allowable tolerance shall be ± 6.0 inches for horizontal dimensions. Vertical dimensions such as the difference in elevations between manhole inverts shall have an allowable tolerance of $\pm 1/8$ inch per 50 feet (or part thereof) of horizontal distance up to a maximum tolerance of ± 2 inch.
 15. Properly prepared record drawings on mylar, together with two copies, shall be certified by a design professional (Engineer and/or Surveyor registered in the State of Florida), employed by the Contractor, and submitted to the Owner/Engineer.

E. Specifications and Addenda; Legibly mark each Section to record:

1. Manufacturer, trade name, catalog number and supplier of each product and item of equipment actually installed.
2. Changes made by field order or by change order.

F. Shop Drawings (after final review and approval):

1. Five sets of record drawings for each process equipment, piping, electrical system and instrumentation system.

- A. Prior to substantial completion and prior to starting the bacteria testing of water lines, deliver signed and sealed Record Documents and Record Drawings to the Engineer. These will be reviewed and verified by the inspector. If there are any required changes or additions, these shall be completed and the entire signed and sealed set resubmitted prior to final pay application.
- B. The Contractor shall employ a Professional Engineer or Surveyor registered in the State of Florida to verify survey data and properly prepare record drawings. Record drawings shall be certified by the professional(s) (Engineer or Surveyor licensed in Florida), as stipulated by the Land Development Ordinance and submitted on signed and sealed paper drawings, signed and dated mylar drawings together with an AutoCAD version on a recordable compact disk (CD).
- C. The CD shall contain media in AutoCad Version 2004 or later, or in any other CAD program compatible with AutoCad in DWG or DXF form. All fonts, line types, shape files or other pertinent information used in the drawing and not normally included in AutoCad shall be included on the media with a text file or attached noted as to its relevance and use.
- D. Accompany submittal with transmittal letter, containing:
 - 1. Date.
 - 2. Project title and number.
 - 3. Contractor's name and address.
 - 4. Title and number of each Record Document.
 - 5. Signature of Contractor or his authorized representative.

Note: The data required to properly prepare these record drawings shall be obtained at the site, at no cost to the County by the responsible design professional or his/her duly appointed representative. The appointed representative shall be a qualified employee of the responsible design professional or a qualified inspector retained by the responsible design professional on a project-by-project basis.

PART 2 STANDARDS

2.01 MINIMUM RECORD DRAWING STANDARDS FOR ALL RECORD DRAWINGS SUBMITTED TO MANATEE COUNTY

- A. Record drawings shall be submitted to at least the level of detail in the contract documents. It is anticipated that the original contract documents shall serve as at least a background for all record information. Original drawings in CAD format may be requested of the Engineer. Refer to Manatee County Utility Standards for additional information.
- B. Drawings shall meet the criteria of paragraph 1.04 D above.

PART 3 EXECUTION (NOT USED)

END OF SECTION

SECTION 01730 OPERATING AND MAINTENANCE DATA

PART 1 GENERAL

1.01 REQUIREMENTS INCLUDED

- A. Compile product data and related information appropriate for Owner's maintenance and operation of products furnished under Contract.

Prepare operating and maintenance data as specified in this and as referenced in other pertinent sections of Specifications.

- B. Instruct Owner's personnel in maintenance of products and equipment and systems.
- C. Provide three (3) sets of operating and maintenance manuals for each piece of equipment provided within this Contract.

1.02 FORM OF SUBMITTALS

- A. Prepare data in form of an instructional manual for use by Owner's personnel.

- B. Format:

1. Size: 8-1/2 inch x 11 inch
2. Paper: 20 pound minimum, white, for typed pages
3. Text: Manufacturer's printed data or neatly typewritten
4. Drawings:
 - a. Provide reinforced punched binder tab, bind in with text.
 - b. Fold larger drawings to size of text pages.
5. Provide fly-leaf for each separate product or each piece of operating equipment.
 - a. Provide typed description of product and major component parts of equipment.
 - b. Provide indexed tabs.
6. Cover: Identify each volume with typed or printed title "OPERATING AND MAINTENANCE INSTRUCTIONS". List:
 - a. Title of Project.
 - b. Identity of separate structures as applicable.
 - c. Identity of general subject matter covered in the manual.

- C. Binders:

1. Commercial quality three-ring binders with durable and cleanable plastic covers.
2. Maximum ring size: 1 inch.
3. When multiple binders are used, correlate the data into related consistent groupings.

1.03 MANUAL FOR EQUIPMENT AND SYSTEMS

- A. Submit three copies of complete manual in final form.
- B. Content for each unit of equipment and system, as appropriate:

1. Description of unit and component parts.
 - a. Function, normal operating characteristics and limiting conditions.
 - b. Performance curves, engineering data and tests.
 - c. Complete nomenclature and commercial number of replaceable parts.
2. Operating Procedures:
 - a. Start-up, break-in, routine and normal operating instructions.
 - b. Regulation, control, stopping, shut-down and emergency instructions.
 - c. Summer and winter operating instructions.
 - d. Special operating instructions.
3. Maintenance Procedures:
 - a. Routine operations.
 - b. Guide to "trouble-shooting".
 - c. Disassembly, repair and reassembly.
 - d. Alignment, adjusting and checking.
4. Servicing and lubricating schedule.
 - a. List of lubricants required.
5. Manufacturer's printed operating and maintenance instructions.
6. Description of sequence of operation by control manufacturer.
7. Original manufacturer's parts list, illustrations, assembly drawings and diagrams required for maintenance.
 - a. List of predicted parts subject to wear.
 - b. Items recommended to be stocked as spare parts.
8. As installed control diagrams by controls manufacturer.
9. Each contractor's coordination drawings.
 - a. As installed color coded piping diagrams.
10. Charts of valve tag numbers, with location and function of each valve.
11. List of original manufacturer's spare parts, manufacturer's current prices and recommended quantities to be maintained in storage.
12. Other data as required under pertinent sections of specifications.

C. Content, for each electric and electronic system, as appropriate:

1. Description of system and component parts.
 - a. Function, normal operating characteristics and limiting conditions.
 - b. Performance curves, engineering data and tests.
 - c. Complete nomenclature and commercial number of replaceable parts.
2. Circuit directories of panelboards.
 - a. Electrical service.
 - b. Controls.
 - c. Communications.
3. As-installed color coded wiring diagrams.
4. Operating procedures:
 - a. Routine and normal operating instructions.
 - b. Sequences required.
 - c. Special operating instructions.
5. Maintenance procedures:
 - a. Routine operations.
 - b. Guide to "trouble-shooting".
 - c. Disassembly, repair and reassembly.
 - d. Adjustment and checking.
6. Manufacturer's printed operating and maintenance instructions.
7. List of original manufacture's spare parts, manufacturer's current prices and recommended quantities to be maintained in storage.

8. Prepare and include additional data when the need for such data becomes apparent during instruction of Owner's personnel.

D. Prepare and include additional data when the need for such data becomes apparent during instruction on Owner's personnel.

E. Additional requirements for operating and maintenance data: Respective sections of Specifications.

1.04 SUBMITTAL SCHEDULE

A. Submit one copy of completed data in final form fifteen days prior to substantial completion.

1. Copy will be returned after substantial completion, with comments (if any).

B. Submit two copies of approved data in final form. Final acceptance will not be provided until the completed manual is received and approved.

1.05 INSTRUCTION OF OWNER'S PERSONNEL

A. Prior to final inspection or acceptance, fully instruct Owner's designated operating and maintenance personnel in operation, adjustment and maintenance of products, equipment and systems.

B. Operating and maintenance manual shall constitute the basis of instruction.

1. Review contents of manual with personnel in full detail to explain all aspects of operations and maintenance.

PART 2 PRODUCTS (NOT USED)

PART 3 EXECUTION (NOT USED)

END OF SECTION

SECTION 01740 WARRANTIES AND BONDS

PART 1 GENERAL

1.01 REQUIREMENTS INCLUDED

- A. Compile specified warranties and bonds.
- B. Compile specified service and maintenance contracts.
- C. Co-execute submittals when so specified.
- D. Review submittals to verify compliance with Contract Documents.
- E. Submit to Engineer for review and transmittal to Owner.

1.02 SUBMITTAL REQUIREMENTS

- A. Assemble warranties, bonds and service and maintenance contracts, executed by each of the respective manufacturers, suppliers and subcontractors.
- B. Number of original signed copies required: Two each.
- C. Table of Contents: Neatly typed, in orderly sequence. Provide complete information for each item.
 - 1. Product or work item.
 - 2. Firm, with name of principal, address and telephone number.
 - 3. Scope.
 - 4. Date of beginning of warranty, bond or service and maintenance contract.
 - 5. Duration of warranty, bond or service maintenance contract.
 - 6. Provide information for Owner's personnel:
 - a. Proper procedure in case of failure.
 - b. Instances which might affect the validity of warranty or bond.
 - 7. Contractor, name of responsible principal, address and telephone number.

1.03 FORM OF SUBMITTALS

- A. Prepare in duplicate packets.
- B. Format:
 - 1. Size 8-1/2 inch x 11 inch punched sheets for standard 3-ring binder. Fold larger sheets to fit into binders.
 - 2. Cover: Identify each packet with typed or printed title "WARRANTIES AND BONDS". List:
 - a. Title of Project.
 - b. Name of Contractor.
- C. Binders: Commercial quality, three-ring, with durable and cleanable plastic covers.

1.04 TIME OF SUBMITTALS

- A. Make submittals within ten days after date of substantial completion and prior to final request for payment.
- B. For items of work, where acceptance is delayed materially beyond date of substantial completion, provide updated submittal within ten days after acceptance, listing date of acceptance as start of warranty period.

1.05 SUBMITTALS REQUIRED

- A. Submit warranties, bonds, service and maintenance contracts as specified in respective sections of Specifications.
- B. Approval by the Owner of all documents required under this section is a pre-requisite to requesting a final inspection and final payment

PART 2 PRODUCTS (NOT USED)

PART 3 EXECUTION (NOT USED)

END OF SECTION

DIVISION 2 SITE WORK

SECTION 02064 MODIFICATIONS TO EXISTING STRUCTURES, PIPING AND EQUIPMENT

PART 1 GENERAL

1.01 SCOPE OF WORK

Furnish all labor, materials, equipment and incidentals required to modify, alter and/or convert existing structures as shown or specified and as required for the installation of piping, mechanical equipment and appurtenances. Existing piping and equipment shall be removed and dismantled as necessary for the performance of facility alterations in accordance with the requirements herein specified.

PART 2 PRODUCTS (NOT USED)

PART 3 EXECUTION

3.01 GENERAL

- A. The Contractor shall cut, repair, reuse, excavate, demolish or otherwise remove parts of the existing structures or appurtenances, as indicated on the Contract Drawings, herein specified, or necessary to permit completion of the work under this Contract. The Contractor shall dispose of surplus materials resulting from the above work in an approved manner. The work shall include all necessary cutting and bending of reinforcing steel, structural steel, or miscellaneous metal work found embedded in the existing structures.
- B. The Contractor shall dismantle and remove all existing equipment, piping, and other appurtenances required for the completion of the work. Where called for or required, the contractor shall cut existing pipelines for the purpose of making connections thereto. Anchor bolts for equipment and structural steel removed shall be cut off one inch below the concrete surface. Surface shall be finished as specified in the Contract Documents.
- C. At the time that a new connection is made to an existing pipeline, additional new piping, extending to and including a new valve, shall be installed. Pipe anchorage, if required, is part of the installation shall also be installed as directed by the Engineer.
- D. No existing structure, equipment, or appurtenance shall be shifted, cut, removed, or otherwise altered except with the express approval of and to the extent approved by the Engineer.
- E. When removing materials or portions of existing utility pipelines and/or structures or when making openings in walls and partitions, the Contractor shall take all precautions and use all necessary barriers and other protective devices so as not to damage the structures beyond the limits necessary for the new work, and not to damage the structures or contents by falling or flying debris. Unless otherwise permitted, line drilling will be required in cutting existing concrete.
- F. Materials and equipment removed in the course of making alterations and additions shall

remain the property of the Owner, except that items not salvageable, as determined by the Engineer and the Owner, shall become the property of the Contractor to be disposed of by him off the work site at his own place of disposal. Operating equipment shall be thoroughly cleaned, lubricated, and greased for protection during prolonged storage.

- G. All alterations to existing utility pipes and structures shall be done at such time and in such manner as to comply with the approved time schedule. So far as possible before any part of the work is started, all tools, equipment, and materials shall be assembled and made ready so that the work can be completed without delay.
- H. All workmanship and new materials involved in constructing the alterations shall conform to the General Specifications for the classes of work insofar as such specifications are applicable.
- I. All cutting of existing concrete or other material to provide suitable bonding to new work shall be done in a manner to meet the requirements of the respective section of these Specifications covering the new work. When not covered, the work shall be carried on in the manner and to the extent directed by the Resident Project Representative.
- J. Surfaces of seals visible in the completed work shall be made to match as nearly as possible the adjacent surfaces.
- K. Non-shrink grout shall be used for setting wall castings, sleeves, leveling pump bases, doweling anchors into existing concrete and elsewhere as shown.
- L. Where necessary or required for the purpose of making connections, the Contractor shall cut existing pipelines in a manner to provide an approved joint. Where required, he shall use flanges, or provide Dresser Couplings, all as required.
- M. The Contractor shall provide flumes, hoses, piping and other related items to divert or provide suitable plugs, bulkheads, or other means to hold back the flow of water or other liquids, all as required in the performance of the work under this Contract.
- N. Care shall be taken not to damage any part of existing buildings or foundations or outside structures.

3.02 CONNECTING TO EXISTING PIPING AND EQUIPMENT

The Contractor shall verify exact location, material, alignment, joint, etc. of existing piping and equipment prior to making the connections called out in the Drawings. The verifications shall be performed with adequate time to correct any potential alignment or other problems prior to the actual time of connection. A Manatee County representative must be present for all tie-ins for a visual inspection.

3.03 REMOVAL AND ABANDONMENT OF ASBESTOS CEMENT PIPE AND APPURTENANCES

- A. All work associated with the removal or abandonment of existing asbestos cement pipe and appurtenances shall be performed by a licensed asbestos abatement contractor or subcontractor registered in the State of Florida.
- B. The asbestos abatement contractor or subcontractor shall contact the appropriate regulatory agencies prior to removal or abandonment of any asbestos material and shall

obtain all required permits and licenses and issue all required notices. The Contractor shall be responsible for all fees associated with permits, licenses and notices to the governing regulatory agencies.

- C. All work associated with removal or abandonment of asbestos cement pipe and appurtenances shall be performed in accordance with the standards listed below and all other applicable local, State, or Federal standards.
 - 1. Florida Administrative Code, Chapter 17-251, "Asbestos".
 - 2. National Emission Standards Hazardous Air Pollution (NESHAP), 40 CFR, Part 61, Subpart M, latest revision.
 - 3. Occupational Safety and Health Act, 29 CFR
 - 4. The Environmental Protection Agency (EPA) Asbestos Abatement Worker Protection Rule.
 - 5. Florida Statute 455.300.

3.04 ASBESTOS CEMENT PIPE REMOVAL

- A. All asbestos cement pipe sections shown on the Drawings to be removed, and all related valves, fittings and appurtenances shall be removed in their entirety and disposed of by the Contractor in accordance with this Section. After removal of the facilities, all trenches shall be backfilled in accordance with the Contract Documents. The cost of disposing of the removed materials shall be borne by the Contractor.
- B. The Contractor shall make necessary provisions for the Engineer's representative to monitor all removal operations.
- C. The cutting of existing asbestos-cement (A/C, aka "Transite") pipe shall be by hand saw only activities by a licensed asbestos abatement contractor. No machine cutting shall be allowed. Removal of all portions of pipe shall be double bagged prior to shipment. Longer sections of pipe removed may be shipped without double bagging. An asbestos manifest form must accompany each and every shipment of such pipe or pipe material waste to the Manatee County Lena Road Landfill. Prior to each shipment, a minimum of 24 hours notice to the Landfill field office (Phone #748-5543) is required.

3.05 IN-PLACE GROUTING OF EXISTING PIPE

- A. Where water and wastewater utility pipes are to be abandoned in place, they shall be filled with a sand/cement grout as specified herein. When such pipes are constructed with asbestos cement materials, the abandonment activities shall be performed by a licensed asbestos abatement contractor as specified in these Specifications.
- B. Grout shall be injected within the pipe sections indicated on the Drawings. The ends of these sections shall be capped and/or plugged. The grouting program shall consist of pumping sand-cement grout with suitable chemical additives at pressures necessary to fill the pipe sections shown on the Drawings to prevent the potential for future collapse.
- C. The pump used for grouting should be a continuous flow, positive displacement model with a pugmill type mixing vat having a minimum shaft speed of 60 rpm and incorporated as an integral part of the equipment. Alternate equipment may be used subject to the approval of the Engineer. The rate of pumping shall not exceed six (6) cubic feet per minute. The pumping pressures shall be in the range of 100 to 150 psi.

- D. The Contractor shall provide standpipes and/or additional means of visual inspection as required by the Engineer to determine if adequate grout material has filled the entire pipe section(s). The Contractor shall make necessary provisions for the Engineer's representative to monitor all grouting operations.
- E. All pipe to be abandoned shall be capped or plugged with a fitting or material that will prevent soil or other material from entering the pipe. All caps and plugs shall be subject to approval by the Engineer.

END OF SECTION

SECTION 02100 SITE PREPARATION

PART 1 GENERAL

1.01 SCOPE OF WORK

- A. This Section covers clearing, grubbing and stripping of the project site and/or along the pipeline route.
- B. The Contractor shall clear and grub all of the area within the limits of construction or as required, which includes, but is not limited to utility easements. The width of the area to be cleared shall be reviewed by the Engineer prior to the beginning of any clearing.
- C. The Contractor's attention is directed to any Soil Erosion and Sediment Control Ordinances in force in Manatee County. The Contractor shall comply with all applicable sections of these ordinances.

PART 2 PRODUCTS (NOT USED)

PART 3 EXECUTION

3.01 CLEARING

The surface of the ground, for the area to be cleared and grubbed shall be completely cleared of all timber, brush, stumps, roots, grass, weeds, rubbish and all other objectionable obstructions resting on or protruding through the surface of the ground. However, trees shall be preserved as hereinafter specified unless otherwise designated by the Engineer. Clearing operations shall be conducted so as to prevent damage to existing structures and installations and to those under construction, so as to provide for the safety of employees and others. Soil erosion control devices such as hay bales and silt fences shall be installed to satisfy all Federal, State and County requirements.

3.02 GRUBBING

Grubbing shall consist of the complete removal of all stumps, roots larger than 1-1/2 inches in diameter, matted roots, brush, timber, logs and any other organic or metallic debris not suitable for foundation purposes, resting on, under or protruding through the surface of the ground to a depth of 18 inches below the subgrade. All depressions excavated below the original ground surface for or by the removal of such objects, shall be refilled with suitable materials and compacted to a density conforming to the surrounding ground surface.

3.03 STRIPPING

In areas so designated, topsoil shall be stockpiled. Topsoil so stockpiled shall be protected until it is placed as specified. The Owner shall have the option to receive all excess topsoil materials. The Contractor shall pay all equipment and labor cost to deliver excess top soil material to a remote site chosen by the Owner within a five mile radius of the construction site. Should Owner not choose to receive any or all excess topsoil materials, the Contractor shall dispose of said material at no additional cost to Owner.

3.04 DISPOSAL OF CLEARED AND GRUBBED MATERIAL

The Contractor shall dispose of all material and debris from the clearing and grubbing operation by hauling such material and debris off site. The cost of disposal (including hauling) of cleared and grubbed material and debris shall be considered a subsidiary obligation of the Contractor; the cost of which shall be included in the prices bid for the various classes of work.

3.05 PRESERVATION OF TREES

Those trees which are not designated for removal by the Engineer shall be carefully protected from damage. The Contractor shall erect such barricades, guards and enclosures as may be considered necessary by him for the protection of the trees during all construction operation.

3.06 PRESERVATION OF DEVELOPED PRIVATE PROPERTY

- A. The Contractor shall exercise extreme care to avoid unnecessary disturbance of developed private property adjacent to proposed project site. Trees, shrubbery, gardens, lawns and other landscaping, which are not designated by the Engineer to be removed, shall be replaced and replanted to restore the construction easement to the condition existing prior to construction.
- B. All soil preservation procedures and replanting operations shall be under the supervision of a nursery representative experienced in such operations.
- C. Improvements to the land such as fences, walls, outbuildings and other structures which of necessity must be removed, shall be replaced with equal quality materials and workmanship.
- D. The Contractor shall clean up the construction site across developed private property directly after construction is completed upon approval of the Engineer.

3.07 PRESERVATION OF PUBLIC PROPERTY

The appropriate paragraphs of these Specifications shall apply to the preservation and restoration of public lands, parks, rights-of-way, easements and all other damaged areas. This includes, but is not limited to the trimming of trees damaged by contractor's equipment.

END OF SECTION

SECTION 02220 EXCAVATION, BACKFILL, FILL AND GRADING FOR STRUCTURES

PART 1 GENERAL

1.01 SCOPE OF WORK

- A. Structural excavation shall consist of the removal of material for the construction of foundations for structures and other excavation designated on the drawings or in these specifications.
- B. Structural excavation and backfill shall consist of furnishing material, if necessary and placing and compacting backfill material around structures to the lines and grades designated on the drawings, as specified or directed by the Engineer.
- C. Structural excavation and backfill shall include the furnishing of all materials, equipment and other facilities which may be necessary to perform the excavations, place and compact the backfill, install sheeting and bracing, and carry out any necessary dewatering. It shall also include the wasting or disposal of surplus excavated material in a manner and in locations approved by the Engineer.
- D. The Contractor is responsible for the protection of every tree which is scheduled to remain in the project area. This includes trees which may or may not be shown on the plans. Every tree shall be adequately protected in place at no additional cost to the County. This includes, but is not limited to, protecting the root systems and adjusting grades as necessary for tree/root protection.

1.02 QUALITY ASSURANCE

- A. Testing Agency:
 - 1. In place soil compaction tests shall be performed by a qualified testing laboratory.
 - 2. Compaction tests shall be taken every 500 feet, except in the road crossings or road shoulders. Tests are to be taken according to current FDOT Standards.
- B. Reference Standards:
 - 1. American Society for Testing and Materials (ASTM):
 - a. ASTM D1557, Moisture-Density Relations of Soils Using 10-lb. (4.5-kg) Rammer and 18-in. (457-mm) Drop.

1.03 JOB CONDITIONS

- A. The Contractor shall provide, operate and maintain all necessary pumps, discharge lines, well points, etc., in sufficient number and capacity to keep all excavation, bases, pits, etc., free from seepage, standing or running water at all times throughout the period of construction.
- B. The Contractor shall assume all responsibility for the security of the excavation required, employing bracing, lining or other accepted means necessary to accomplish same.

- C. Excavated areas shall be cleared of all debris, water, slush, muck, clay and soft or loose earth and shall be conditioned to the entire satisfaction of the Engineer.
- D. All excavated material unsuitable for use or which will not be used shall be disposed of in a manner consistent with State and County regulation.
- E. All unsuitable organic materials, roots, logs, etc., found during excavation shall be removed by the Contractor and the trench shall be refilled with suitable material.

PART 2 PRODUCTS

2.01 MATERIAL FOR CONTROLLED FILL

- A. Composition: Only approved material free from organic matter and lumps of clay, shall be used for backfill. Excavated earth free from debris or organic material may be used for backfilling foundations or fill.
- B. Crushed stone and shell shall meet or exceed current FDOT Standards.

2.02 UNSUITABLE MATERIAL

Unsuitable material shall be defined as highly organic soil per ASTM D2487 Group PT. This includes, but is not limited to, such items as topsoil, roots, vegetable matter, trash, debris, and clays that cannot be dried sufficiently to obtain specified compaction.

PART 3 EXECUTION

3.01 INSPECTION

- A. The Contractor shall verify that work preceding the affected work of this Section has been satisfactorily completed.
- B. Conditions adversely affecting the work of this Section shall be corrected to the satisfaction of the Engineer.

3.02 REMOVAL OF UNSUITABLE MATERIALS

- A. The Contractor shall remove unsuitable material from within the limits of the Work.
- B. Materials meeting requirements for controlled fill shall be stockpiled as necessary and in such a manner satisfactory to the Engineer.
- C. All material excavated shall be placed so as to minimize interference with public travel and to permit proper access for inspection of the work.

3.03 EXCAVATION

- A. When concrete or shell subbase footing is to rest on an excavated surface, care shall be taken not to disturb the natural soil. Final removal and replacement of the foundation material and subbase compaction to grade shall not be made until just before the concrete or masonry is placed.

- B. When any structural excavation is completed, the Contractor shall notify the Engineer who will make an inspection of the excavation. No concrete or masonry shall be placed until the excavation has been approved by the Engineer.
- C. The elevations of the footing bottom and the base slab as shown on the Drawings, shall be considered as approximate and the Engineer may order in writing, such changes in dimensions or elevations of the footings and slab base as necessary to secure satisfactory foundations.
- D. All excavation shall be made within an area bounded by lines five feet outside and parallel to the exterior walls of the structure to allow for correct forming, shoring and inspection of foundation work. Pouring of concrete against earth side walls shall not be permitted.
- E. If the ground is excavated below the grade called for by the Drawings or becomes unstable due to the Contractor's carelessness or operations, the ground shall be excavated to undisturbed native soil before continuing concreting operations.
- F. If in the opinion of the Engineer, the material at or below the normal grade of the bottom of the trench is unsuitable for pipe or structure foundation, it shall be removed to the depth directed by the Engineer and if so directed, replaced by crushed stone or washed shell.

3.04 STRUCTURAL BACKFILL

- A. Structural backfill shall not be placed until the footings or other portions of the structure or facility have been inspected by the Engineer and approved for backfilling.
- B. A minimum of 1-1/2" layer of lean concrete shall be placed as a working mat for the concrete base slabs and footings if required by the engineer.
- C. Fill shall be placed in uniform layers not more than 12" thick and compacted to a minimum of 98 percent of the maximum density determined by ASTM D1557, Method A or C, or as directed by the Engineer. The Contractor shall securely tamp the backfill with pneumatic rammer around all wall foundations. The method of compaction shall be satisfactory to the Engineer.
- D. Compaction of structural backfill by ponding and jetting may be permitted when, as determined by the Engineer: the backfill material is of such character that it will be self-draining when compacted; foundation materials will not soften or be otherwise damaged by the applied water; no damage from hydrostatic pressure will result to the structure. Ponding and jetting within two feet below finished subgrade shall not be permitted in roadway areas. At the discretion of the Engineer, ponding and jetting may be permitted with compaction layers not to exceed four feet.
- E. Surplus material not used on-site shall be removed and disposed of off-site by the Contractor. In no case shall surplus material be deposited on adjacent lands. Fill used for grading shall be placed in layers not to exceed 12 inches in thickness and shall be compacted to a density equal or greater to that of the surrounding natural ground.

3.05 BACKFILLING AROUND STRUCTURES

- A. Common fill and structural fill are specified for use as backfill against the exterior walls of the structures. Fill shall be placed in layers having a maximum thickness of eight (8) inches in loose state and shall be compacted sufficiently to prevent settlement. If

compaction is by rolling or ramming, material shall be wetted down as required. Where material can be suitably compacted by jetting or puddling, the Contractor may use one of these methods. No boulders shall be allowed to roll down the slopes and hit the walls.

- B. Backfilling shall be carried up evenly on all walls of an individual structure simultaneously. A variation of two (2) feet in elevation will be the maximum allowable. No backfill shall be allowed against walls until the walls and their supporting slabs, if applicable, have attained sufficient strength. Backfilling shall be subjected to approval by the Engineer.
- C. In locations where pipes pass through building walls, the Contractor shall take the following precautions to consolidate the refill up to an elevation of at least one foot above the bottom of the pipes:
 - 1. Place structural fill in such areas for a distance of not less than three feet either side of the center line of the pipe in level layers not exceeding 6-inches in depth.
 - 2. Wet each layer to the extent directed and thoroughly compact each layer with a power tamper to the satisfaction of the Engineer.
 - 3. Structural fill shall be of the quality specified under Part 2 of this Section.
- D. The surface of filled areas shall be graded to smooth true lines, strictly conforming to grades indicated on the grading plan. No soft spots or uncompacted areas shall be allowed in the work.
- E. Temporary bracing shall be provided as required during construction of all structures to protect partially completed structures against all construction loads, hydraulic pressure and earth pressure. The bracing shall be capable of resisting all loads applied to the walls as a result of backfilling.

3.06

FIELD QUALITY CONTROL

- A. The density of soil in place shall be a minimum of 95 percent in accordance with ASTM test 1557-70T, Method A or C.

END OF SECTION

SECTION 02221 TRENCHING, BEDDING AND BACKFILL FOR PIPE

PART 1 GENERAL

1.01 SCOPE OF WORK

- A. The Contractor shall furnish all labor, materials, equipment and incidentals necessary to perform all excavation, backfill, fill, grading, trench protection or other related work required to complete the piping work shown on the Drawings and specified herein. The work shall include, but not be limited to: vaults; duct conduit; pipe; roadways and paving; backfilling; required fill or borrow operations; grading; disposal of surplus and unsuitable materials; and all related work such as sheeting, bracing and dewatering.
- B. Prior to commencing work, the Contractor shall examine the site and review test borings if available, or undertake his own subsurface investigations and take into consideration all conditions that may affect his work.
- C. The Contractor is responsible for the protection of every tree which is scheduled to remain in the project area. This includes trees which may or may not be shown on the plans. Every tree shall be adequately protected in place at no additional cost to the County. This includes, but is not limited to protecting the root systems and adjusting grades as necessary for tree/root protection.

1.02 PROTECTION

- A. Sheeting and Bracing in Excavations:
 - 1. In connection with construction of underground structures, the Contractor shall properly construct and maintain cofferdams. These shall consist of: sheeting and bracing as required to support the sides of excavations, to prevent any movement which could in any way diminish the width of the excavation below that necessary for proper construction and to protect adjacent structures, existing yard pipe and/or foundation material from disturbance, undermining, or other damage. Care shall be taken to prevent voids outside of the sheeting, but if voids are formed, they shall be immediately filled and rammed.
 - 2. Trench sheeting for pipes: no sheeting is to be withdrawn if driven below, mid-diameter of any pipe and no wood sheeting shall be cut off at a level lower than one foot above the top of any pipe unless otherwise directed by the Engineer. During the progress of the work, the Engineer may direct the Contractor in writing to leave additional wood sheeting in place. If steel sheeting is used for trench sheeting, removal shall be as specified above, unless written approval is given for an alternate method of removal.
 - 3. All sheeting and bracing not left in place shall be carefully removed in such a manner as not to endanger the construction or other structures, utilities, existing piping, or property. Unless otherwise approved or indicated on the Drawings or in the Specification, all sheeting and bracing shall be removed after completion of the piping or structure, care being taken not to disturb or otherwise injure the pipeline or finished masonry. All voids left or caused by withdrawal of sheeting shall be immediately refilled with sand by ramming with tools specifically made for that purpose, by watering, or as may otherwise be directed.
 - 4. The Contractor shall construct, to the extent he deems it desirable for his method of operation, the cofferdams and sheeting outside the neat lines of the pipeline

trench or foundation unless otherwise indicated on the Drawings or directed by the Owner/Engineer. Sheeting shall be plumb and securely braced and tied in position. Sheeting, bracing and cofferdams shall be adequate to withstand all pressures to which the pipeline or structure will be subjected. Pumping, bracing and other work within the cofferdam shall be done in a manner to avoid disturbing any construction of the pipeline or the enclosed masonry. Any movement or bulging which may occur shall be corrected by the Contractor at his own expense so as to provide the necessary clearances and dimensions.

5. Drawings of the cofferdams and design computations shall be submitted to the Engineer and approved prior to any construction. However, approval of these drawings shall not relieve the Contractor of the responsibility for the cofferdams. The drawings and computations shall be prepared and stamped by a Registered Professional Engineer in the State of Florida and shall be in sufficient detail to disclose the method of operation for each of the various stages of construction, if required, for the completion of the pipeline and substructures.

B. Dewatering, Drainage and Flotation

1. The Contractor shall construct and place all pipelines, concrete work, structural fill, bedding rock and limerock base course, in-the-dry. In addition, the Contractor shall make the final 24" of excavation for this work in-the-dry and not until the water level is a minimum of 6" below proposed bottom of excavation.
2. The Contractor shall, at all times during construction, provide and maintain proper equipment and facilities to remove promptly and dispose of properly all water entering excavation and keep such excavations dry so as to obtain a satisfactory undisturbed subgrade foundation condition until the fill, structure, or pipes to be built thereon have been completed to such extent that they will not be floated or otherwise damaged by allowing water levels to return to natural elevations.
3. Dewatering shall at all times be conducted in such a manner as to preserve the natural undisturbed bearing capacity of the subgrade soils at proposed bottom of excavation.
4. Wellpoints may be required for dewatering the soil prior to final excavation for deeper in-ground structures or piping and for maintaining the lowered groundwater level until construction has been completed to avoid the structure, pipeline, or fill from becoming floated or otherwise damaged. Wellpoints shall be surrounded by suitable filter sand and no fines shall be removed by pumping. Pumping from wellpoints shall be continuous and standby pumps shall be provided.
5. The Contractor shall furnish all materials and equipment to perform all work required to install and maintain the proposed drainage systems for handling groundwater and surface water encountered during construction of structures, pipelines and compacted fills.
6. Where required, the Contractor shall provide a minimum of two operating groundwater observation wells at each structure to determine the water level during construction of the pipeline or structure. Locations of the observation wells shall be at structures and along pipelines as approved by the Engineer prior to their installation. The observation wells shall be extended to 6 inches above finished grade, capped with screw-on caps protected by 24" x 24" wide concrete base and left in place at the completion of this Project.
7. Prior to excavation, the Contractor shall submit his proposed method of dewatering and maintaining dry conditions to the Engineer for approval. Such approval shall not relieve the Contractor of the responsibility for the satisfactory performance of the system. The Contractor shall be responsible for correcting any disturbance of natural bearing soils for damage to pipeline or structures caused by an inadequate

dewatering system or by interruption of the continuous operation of the system as specified.

8. As part of his request for approval of a dewatering system, the Contractor shall demonstrate the adequacy of the proposed system and wellpoint filter sand by means of a test installation. Discharge water shall be clear, with no visible soil particles in a one quart sample. Discharge water shall not flow directly into wetlands or Waters of the State as defined by FDEP and SWFWMD.
9. During backfilling and construction, water levels shall be measured in observation wells located as directed by the Engineer.
10. Continuous pumping will be required as long as water levels are required to be below natural levels.

PART 2 PRODUCTS

2.01 MATERIALS

A. General

1. Materials for use as fill and backfill shall be described below. For each material, the Contractor shall notify the Engineer of the source of the material and shall furnish the Engineer, for approval, a representative sample weighing approximately 50 pounds, at least ten calendar days prior to the date of anticipated use of such material.
2. Additional materials shall be furnished as required from off-site sources and hauled to the site.

B. Structural Fill

1. Structural fill in trenches shall be used below spread footing foundations, slab-on-grade floors and other structures as backfill within three feet of the below grade portions of structures.
2. Structural fill material shall be a minimum of 60 percent clean sand, free of organic, deleterious and/or compressible material. Minimum acceptable density shall be 98 percent of the maximum density as determined by AASHTO T-180. Rock in excess of 2-1/2" in diameter shall not be used in the fill material. If the moisture content is improper for attaining the specified density, either water shall be added or material shall be permitted to dry until the proper moisture content for compaction is reached.

C. Common Fill

1. Common fill material shall be free from organic matter, muck or marl and rock exceeding 2-1/2" in diameter. Common fill shall not contain broken concrete, masonry, rubble or other similar materials. Existing soil may be used to adjust grades over the site with the exception of the construction area.
2. Material falling within the above specification, encountered during the excavation, may be stored in segregated stockpiles for reuse. All material which, in the opinion of the Engineer, is not suitable for reuse shall be spoiled as specified herein for disposal of unsuitable materials by the Contractor.

D. Crushed Stone

1. Crushed stone may be used for pipe bedding, manhole bases, as a drainage layer below structures with underdrains and at other locations indicated on the Drawings.
2. Crushed stone shall be size No. 57 with gradation as noted in Table 1 of Section 901 of Florida Department of Transportation, Construction of Roads and Bridges.

PART 3 EXECUTION

3.01 TRENCH EXCAVATION AND BACKFILLING

- A. Excavation for all trenches required for the installation of pipes and electrical ducts shall be made to the depths indicated on the Drawings and in such manner and to such widths as will give suitable room for laying the pipe or installing the ducts within the trenches.
- B. Rock shall be removed to a minimum 6" clearance around the bottom and sides of all the pipe or ducts being laid.
- C. Where pipes or ducts are to be laid in limerock bedding or encased in concrete, the trench may be excavated by machinery to or just below the designated subgrade provided that the material remaining in the bottom of the trench is no more than slightly disturbed.
- D. Where the pipes or ducts are to be laid directly on the trench bottom, the lower part of the trenches shall not be excavated to grade by machinery. The last of the material being excavated manually, shall be done in such a manner that will give a flat bottom true to grade so that pipe or duct can be evenly supported on undisturbed material. Bell holes shall be made as required.
- E. Backfilling over pipes shall begin as soon as practicable after the pipe has been laid, jointed and inspected and the trench filled with suitable compacted material to the mid-diameter of the pipe.
- F. Backfilling over ducts shall begin not less than three days after placing concrete encasement.
- G. All backfilling shall be prosecuted expeditiously and as detailed on the Drawings.
- H. Any space remaining between the pipe and sides of the trench shall be packed full by hand shovel with selected earth, free from stones having a diameter greater than 2" and thoroughly compacted with a tamper as fast as placed, up to a level of one foot above the top of the pipe.
- I. The filling shall be carried up evenly on both sides with at least one man tamping for each man shoveling material into the trench.
- J. The remainder of the trench above the compacted backfill, as just described above, shall be filled and thoroughly compacted by rolling, ramming, or puddling, as the Engineer may direct, sufficiently to prevent subsequent settling.

END OF SECTION

SECTION 02223 EXCAVATION BELOW GRADE AND CRUSHED STONE OR SHELL REFILL

PART 1 GENERAL

1.01 SCOPE OF WORK

- A. If in the opinion of the Engineer, the material at or below the normal grade of the bottom of the trench is unsuitable for pipe or structure foundation, it shall be removed to the depth directed by the Engineer and replaced by crushed stone or washed shell.

PART 2 PRODUCTS (NOT USED)

PART 3 MATERIALS

3.01 EXCAVATION AND DRAINAGE

- A. Whatever the nature of unstable material encountered or the groundwater conditions, trench stabilization shall be complete and effective.
- B. Should the Contractor excavate below the grade shown on the Contract drawings because of negligence or for his own convenience; due to failure in properly dewatering the trench; disturbs the subgrade before dewatering is sufficiently complete; he shall be directed by the Engineer to excavate below grade. The work of excavating below grade and furnishing and placing the approved refill material shall be performed at the Contractor's expense.

3.02 REFILL

- A. Should the material at the level of trench bottom consist of fine sand, sand and silt or soft earth, the subgrade material shall be removed as directed by the Engineer and the excavation shall be refilled with crushed stone or washed shell.

END OF SECTION

SECTION 02260 FINISH GRADING

PART 1 GENERAL

1.01 WORK INCLUDED

- A. The Contractor shall finish grade sub-soil.
- B. The Contractor shall cut out areas to receive stabilizing base course materials for paving and sidewalks.
- C. The Contractor shall place, finish grade and compact top soil.

1.02 PROTECTION

The Contractor shall prevent damage to existing fencing, trees, landscaping, natural features, bench marks, pavement and utility lines. Damage shall be corrected at no cost to the Owner.

PART 2 PRODUCTS

- A. Topsoil: Shall be friable loam free from subsoil, roots, grass, excessive amount of weeds or other organics, stones, and foreign matter; acidity range (pH) of 5.5 to 7.5; containing a minimum of 4 percent and a maximum of 25 percent organic matter. The Contractor may use topsoil stockpiles on site if they conform to these requirements.

PART 3 EXECUTION

3.01 SUB-SOIL PREPARATION

- A. The Contractor shall rough grade sub-soil systematically to allow for a maximum amount of natural settlement and compaction. Uneven areas and low spots shall be eliminated. Debris, roots, branches or other organics, stones, and sub-soil shall be removed by the Contractor and disposed of in a manner consistent with the latest Manatee County Standards as well as any affected regulatory agency. Should contaminated soil be found, the Contractor shall notify the Engineer.
- B. The Contractor shall cut out areas to sub-grade elevation to stabilize base material for paving and sidewalks.
- C. The Contractor shall bring sub-soil to required profiles and contour grades gradually; and blend slopes into level areas.
- D. The Contractor shall slope the structure grade a minimum of two (2) inches in ten (10) feet unless indicated otherwise on the Drawings.
- E. The Contractor shall cultivate sub-grade to a depth of 3 inches where the topsoil is to be placed. He shall repeat cultivation in areas where equipment use has compacted sub-soil.
- F. The Contractor shall not make grade changes which causes water to flow onto adjacent lands.

3.02

PLACING TOPSOIL

- A. The Contractor shall place topsoil in areas where seeding, sodding and planting is to be performed. He shall place from the following minimum depths, up to finished grade elevations:
 - 1. 6 inches for seeded areas
 - 2. 4-1/2 inches for sodded areas
 - 3. 24 inches for shrub beds
 - 4. 18 inches for flower beds
- B. The Contractor shall use topsoil in a dry state as determined by the Engineer. He shall place the material during dry weather.
- C. The Contractor shall use fine grade topsoil eliminating rough and low areas to ensure positive drainage. He shall maintain levels, profiles and contours of the sub-grades.
- D. The Contractor shall remove stone, roots, grass, weeds, debris, and other organics or foreign material while spreading the material.
- E. The Contractor shall manually spread topsoil around trees, plants and structures to prevent damage which may be caused by grading equipment.
- F. The Contractor shall lightly compact and place the topsoil.

3.03

SURPLUS MATERIAL

- A. The Contractor shall remove surplus sub-soil and topsoil from site at his expense.
- B. The Contractor shall leave stockpile areas and entire job site clean and raked, ready for landscaping operations.

END OF SECTION

SECTION 02276 TEMPORARY EROSION AND SEDIMENTATION CONTROL

PART 1 GENERAL

1.01 DESCRIPTION

- A. The work specified in this Section consists of the design, provision, maintenance and removal of temporary erosion and sedimentation controls as necessary.
- B. Temporary erosion controls include, but are not limited to: grassing, mulching, netting, watering, and the reseeding of on-site surfaces and spoil and borrow area surfaces, interceptor ditches at ends of berms and other such work at those locations which will ensure that erosion during construction will be either eliminated or maintained within acceptable limits as established by the Owner/Engineer.
- C. Temporary sedimentation controls include, but are not limited to: silt dams, traps, barriers, and appurtenances at the foot of sloped surfaces which shall ensure that sedimentation pollution will be either eliminated or maintained within acceptable limits as established by the Owner/Engineer.
- D. The Contractor is responsible for providing effective temporary erosion and sediment control measures during construction or until final controls become effective.

1.02 REFERENCE DOCUMENTS

- A. Florida Building Code.
- B. FDEP/COE Dredge and Fill Regulations and/or Permit as applicable.
- C. SWFWMD Permit Regulations and/or Permit as applicable.
- D. Florida Stormwater, Erosion and Sedimentation Control Inspector's Manual.

PART 2 PRODUCTS

2.01 EROSION CONTROL

- A. Netting - fabricated of material acceptable to the Owner.
- B. Seed and sod.

2.02 SEDIMENTATION CONTROL

- A. Bales - clean, seed free cereal hay type.
- B. Netting - fabricated of material acceptable to the Owner.
- C. Filter stone - crushed stone conforming to Florida Dept of Transportation specifications.
- D. Concrete block - hollow, non-load-bearing type.
- E. Concrete - exterior grade not less than one inch thick.

PART 3 EXECUTION

3.01 EROSION CONTROL

- A. Minimum procedures for grassing shall be:
1. Scarify slopes to a depth of not less than six inches and remove large clods, rock, stumps, roots larger than 1/2 inch in diameter and debris.
 2. Sow seed within twenty-four (24) hours after the ground is scarified with either mechanical seed drills or rotary hand seeders.
 3. Apply mulch loosely and to a thickness of between 3/4-inch and 1-1/2 inches.
 4. Apply netting over mulched areas on sloped surfaces.
 5. Roll and water seeded areas in a manner which will encourage sprouting of seeds and growing of grass. Reseed areas which exhibit unsatisfactory growth. Backfill and seed eroded areas.

3.02 SEDIMENTATION CONTROL

- A. The Contractor shall install and maintain silt dams, traps, barriers, and appurtenances as shown on the approved descriptions and working drawings. Deteriorated hay bales and dislodged filter stone shall be replaced by the Contractor at his expense.

3.03 PERFORMANCE

- A. The Contractor, at his own expense, shall immediately take whatever steps are necessary to correct any deficiencies of the temporary erosion and sediment control measures employed if they fail to produce results or do not comply with the requirements of the State of Florida or any other federal, governmental or regulatory agency.

END OF SECTION

SECTION 02485 SEEDING AND SODDING

PART 1 GENERAL

1.01 SCOPE OF WORK

- A. The Contractor shall furnish all labor, materials and equipment necessary to satisfactorily return all construction areas to their original conditions or better.
- B. Work shall include furnishing and placing seed or sod, fertilizing, planting, watering and maintenance until acceptance by Engineer/Owner.

1.02 RELATED WORK NOT INCLUDED

Excavation, filling and grading required to establish elevation shown on the Drawings are included under other sections of these Specifications.

1.03 QUALITY ASSURANCE

- A. It is the intent of this Specification that the Contractor is obliged to deliver a satisfactory stand of grass as specified. If necessary, the Contractor shall repeat any or all of the work, including grading, fertilizing, watering and seeding or sodding at no additional cost to the Owner until a satisfactory stand is obtained. For purposes of grassing, a satisfactory stand of grass is herein defined as a full lawn cover over areas to be sodded or seeded, with grass free of weeds, alive and growing, leaving no bare spots larger than 3/4 square yard within a radius of 8 feet.
- B. All previously grassed areas where pipelines are laid shall be sodded. All sodding and grassing shall be installed in accordance with these Specifications or as directed by the Engineer.

PART 2 PRODUCTS

2.01 MATERIALS

- A. Fertilizer: The fertilizer shall be of the slow-release type meeting the following minimum requirements: 12 percent nitrogen, 8 percent phosphorus, 8 percent potassium; 40 percent other available materials derived from organic sources. At least 50 percent of the phosphoric acid shall be from normal super phosphate or an equivalent source which will provide a minimum of two units of sulfur. The amount of sulfur shall be indicated on the quantitative analysis card attached to each bag or other container. Fertilizer shall be uniform in composition, dry and free flowing delivered to sites in original unopened containers bearing manufacturer's statement or guarantee.
- B. Seeding/Grassing: The Contractor shall grass all unpaved areas disturbed during construction which do not require sod. All grassing shall be completed in conformance with FDOT Specifications, Sections 570 and 981. The grassed areas shall be mulched and fertilized in accordance with FDOT Specifications, except that no additional payment will be made for mulching, fertilizing and/or watering.
- C. Sodding: Sod shall be provided as required on the construction drawings or at locations as

directed by the Engineer in accordance with Florida Department of Transportation, Specifications Section 575 and 981. The Contractor shall furnish bahia grass sod or match existing sod. Placement and watering requirements shall be in accordance with FDOT Specifications Section 575, except that no additional payment will be made for placement and/or watering. This cost shall be included in the Contract price bid for sodding.

- D. Topsoil: Topsoil stockpiled during excavation may be used as necessary. If additional topsoil is required to replace topsoil removed during construction, it shall be obtained off site at no additional cost to the Owner. Topsoil shall be fertile, natural surface soil, capable of producing all trees, plants and grassing specified herein.
- E. Water: It is the Contractor's responsibility to supply all water to the site, as required during seeding and sodding operations and through the maintenance period and until the work is accepted. The Contractor shall make whatever arrangements that may be necessary to ensure an adequate supply of water to meet the needs for his work. He shall also furnish all necessary hose, equipment, attachments and accessories for the adequate irrigation of lawns and planted areas as may be required. Water shall be suitable for irrigation and free from ingredients harmful to plant life.

PART 3 EXECUTION

3.01 INSTALLATION

- A. When the trench backfill has stabilized sufficiently, the Contractor shall commence work on lawns and grassed areas, including fine grading as necessary and as directed by the Engineer.
- B. Finish Grading: Areas to be seeded or sodded shall be finish graded, raked, and debris removed. Soft spots and uneven grades shall be eliminated. The Engineer shall approve the finish grade of all areas to be seeded or sodded prior to seed or sod application.
- C. Protection: Seeded and sodded areas shall be protected against traffic or other use by placing warning signs or erecting barricades as necessary. Any areas damaged prior to acceptance by the Owner shall be repaired by the Contractor as directed by the Engineer.

3.02 CLEANUP

Soil or similar materials spilled onto paved areas shall be removed promptly, keeping those areas as clean as possible at all times. Upon completion of seeding and sodding operations, all excess soil, stones and debris remaining shall be removed from the construction areas.

3.03 LANDSCAPE MAINTENANCE

- A. Any existing landscape items damaged or altered during construction by the Contractor shall be restored or replaced as directed by the Engineer.
- B. Maintain landscape work for a period of 90 days immediately following complete installation of work or until Owner accepts project. Watering, weeding, cultivating, restoration of grade, mowing and trimming, protection from insects and diseases, fertilizing and similar operations as needed to ensure normal growth and good health for live plant material shall be included at no additional cost to the Owner.

3.04

REPAIRS TO LAWN AREAS DISTURBED BY CONTRACTOR'S OPERATORS

Lawn areas planted under this Contract and all lawn areas damaged by the Contractor's operation shall be repaired at once by proper soil preparation, fertilizing and sodding, in accordance with these Specifications.

END OF SECTION

SECTION 02513 ASPHALT CONCRETE PAVING

PART 1 GENERAL

1.01 SCOPE OF WORK

The Contractor shall furnish all labor, materials and equipment necessary to complete all milling asphalt pavement and asphalt concrete paving (including restoration of driveways) as called out on the Contract Documents or as shown on the Drawings.

1.02 QUALITY ASSURANCE

- A. Qualifications of Asphalt Concrete Producer: The only materials permitted shall be furnished by a bulk asphalt concrete producer exclusively engaged in the production of hot-mix, hot-laid asphalt concrete.
- B. Qualification of Testing Agency: The Owner may employ a commercial testing laboratory to conduct tests and evaluations of asphalt concrete materials and design. The Contractor shall:
 - 1. Provide asphalt concrete testing and inspection service acceptable to Engineer.
 - 2. Include sampling and testing asphalt concrete materials proposed, and tests and calculations for asphalt concrete mixtures.
 - 3. Provide field testing facilities for quality control testing during paving operations.
- C. Requirements of Regulatory Agencies: The Contractor shall comply with the applicable requirements of:
 - 1. Manatee County Utility Operations Department
 - 2. Manatee County Transportation Department
 - 3. State of Florida Dept. of Transportation

1.03 PAVING QUALITY REQUIREMENTS

- A. General: In addition to other specified conditions, the Contractor shall comply with the following minimum requirements:
 - 1. In-place asphalt concrete course shall be tested for compliance with requirements for density, thickness and surface smoothness.
 - 2. Final surface shall be provided of uniform texture, conforming to required grades and cross sections.
 - 3. A minimum of four inch diameter pavement specimens for each completed course shall be taken from locations as directed by the Engineer.
 - 4. Holes from test specimens shall be repaved as specified for patching defective work.
- B. Density:
 - 1. When subjected to 50 blows of standard Marshall hammer on each side of an in place material specimen, densities shall be comparable to a laboratory specimen of same asphalt concrete mixture.
 - 2. The minimum acceptable density of in-place course material shall be 98% of the

recorded laboratory specimen density.

- C. Thickness: In-place compacted thicknesses shall not be acceptable if less than the minimum thicknesses shown on the Drawings.
- D. Surface Smoothness:
 - 1. Finished surface of each asphalt concrete course shall be tested for smoothness, using a 10 ft. straightedge applied parallel to and at right angles to centerline of paved areas.
 - 2. Surface areas shall be checked at intervals directed by Engineer.
 - 3. Surfaces shall not be acceptable if they exceed the following:
 - a. Base Course: 1/4 in. in 10 ft.
 - b. Surface Course: 3/16 in. in 10 ft.
 - c. Crowned Surfaces:
 - (1) Test crowned surfaces with a crown template, centered and at right angles to the crown.
 - (2) Surfaces will not be acceptable if varying more than 1/4 in. from the template.

1.04 SUBMITTALS

- A. Samples: The Contractor may be required to provide samples of materials for laboratory testing and job-mix design.
- B. Test Reports: The Contractor shall submit laboratory reports for following materials tests:
 - 1. Coarse and fine aggregates from each material source and each required grading:
 - a. Sieve Analysis: ASTM C 136 (AASHTO T 27).
 - b. Unit Weight of Slag: ASTM C29 (AASHTO T 19).
 - c. Soundness: ASTM C 88 (AASHTO T 104) for surface course aggregates only.
 - d. Sand Equivalent: ASTM D 2419 (AASHTO T 176).
 - e. Abrasion of Coarse Aggregate: ASTM C131 (AASHTO T 96), for surface course aggregates only.
 - 2. Asphalt cement for each penetration grade:
 - a. Penetration: ASTM D5 (AASHTO T49).
 - b. Viscosity (Kinematic): ASTM D2170 (AASHTO T 201).
 - c. Flash Point: ASTM D92 (AASHTO T 48).
 - d. Ductility: ASTM D 113 (AASHTO T 51).
 - e. Solubility: ASTM D 4 (AASHTO T 44).
 - f. Specific Gravity: ASTM D 70 (AASHTO T 43).
 - 3. Job-mix design mixtures for each material or grade:
 - a. Bulk Specific Gravity for Coarse Aggregate: ASTM C 117(AASHTO T 85).
 - b. Bulk Specific Gravity for Fine Aggregate: ASTM C 128(AASHTO T 84).
 - 4. Uncompacted asphalt concrete mix: Maximum Specific Gravity: ASTM D 2041 (AASHTO T 209).
 - 5. Compacted asphalt concrete mix:
 - a. Bulk Density: ASTM D 1188 (AASHTO T 166).
 - b. Marshall Stability and Flow: ASTM D 1559.
 - 6. Density and voids analysis:
 - a. Provide each series of asphalt concrete mixture test specimens, in accordance with A.I. MS-2 "Mix Design Methods for Asphalt Concrete".

- b. Use Marshall method of mix design unless otherwise directed or acceptable to the Engineer.
- c. Report the quantity of absorbed asphalt cement in pounds of dry aggregate, percent air voids, and percent voids in mineral aggregate.
- 7. Sampling and testing of asphalt concrete mixtures for quality control during paving operations:
 - a. Uncompacted asphalt concrete mix.
 - (1) Asphalt Cement Content: ASTM D 2172 (AASHO T 164).
 - (2) Penetration of Recovered Asphalt Cement: ASTM D 5(AASHO T 49).
 - (3) Ductibility of Recovered Asphalt Cement: ASTM D 113(AASHO T 51).
 - b. Compacted asphalt concrete mix:
 - (1) Bulk Density: ASTM D 1188 (AASHO T 166).
 - Marshall Stability and Flow: ASTM D1559).
 - c. Perform at least one test for each day's paving.
- 8. Asphalt plant inspection: ASTM D 290.
- 9. Additional testing:
 - a. Retesting shall be required if previous tests indicate insufficient values, or if directed by the Engineer.
 - b. Testing shall continue until specified values have been attained.
- 10. Asphalt concrete materials which do not comply with specified requirements shall not be permitted in the work.

1.05 JOB CONDITIONS

- A. Weather Limitations:
 - 1. Apply bituminous prime and tack coats only when the ambient temperature in the shade is 50 degrees F. and when the temperature has not been below 35 degrees F. for 12 hours immediately prior to application.
 - 2. Do not apply when the base surface is wet or contains an excess of moisture which would prevent uniform distribution and the required penetration.
 - 3. Construct asphalt concrete surface course only when atmospheric temperature is above 40 degrees F., when the underlying base is dry, and when weather is not rainy.
 - 4. Base course may be placed when air temperature is not below 30 degrees F. and rising, when acceptable to the Engineer.
- B. Grade Control: Establish and maintain the required lines and grades, including crown and cross-slope, for each course during construction operations.
- C. Traffic Control: Maintain vehicular and pedestrian traffic during paving operations, as required for other construction activities.

PART 2 PRODUCTS

2.01 MATERIALS

- A. Soil Cement or Shell Base Course: as specified in FDOT Section 270, "Material for Base and Stabilized Base", and as called for in the Contract Documents.
- B. Aggregate for Asphalt Concrete, General:

1. Sound, angular crushed stone, crushed gravel, or crushed slag: ASTM D 692.
2. Sand, stone, or slag screening: ASTM D 1073.
3. Provide aggregate in gradations for various courses to comply with local highway standards.

C. Surface Course Aggregates:

1. Provide natural sand, unless sand prepared from stone, slag, or gravel or combinations are required to suit local conditions.

D. Asphalt Cement: Comply with ASTM D 946 for 85-100 penetration grade.

E. Prime Coat:

1. Cut-back liquid asphalt.
2. Medium-Curing type: ASTM D 2027, Grade MC-70.

2.02 ASPHALT-AGGREGATE MIXTURES

A. Job-mix criteria:

1. Provide job-mix formulas for each required asphalt-aggregate mixture.
2. Establish a single percentage of aggregate passing each required sieve size, a single percentage of asphalt cement to be added to aggregate, and a single temperature at which asphalt concrete is to be produced.
3. Comply with the mix requirements of local governing highway standards.
4. Maintain material quantities within allowable tolerances of the governing standards.

2.03 TRAFFIC AND PARKING MARKING MATERIALS

A. Traffic lane marking paint with chlorinated rubber base.

B. Factory mixed, quick drying and non bleeding, FS TT-P-115C, Type III.

C. Color: Driving Lane Dividers - White
No Parking Zone - Yellow
Parking Dividers - White

PART 3 EXECUTION

3.01 SURFACE PREPARATION

A. Subbase Preparation:

1. The Contractor shall remove from the area all organic substance encountered to a depth of six or eight inches (6" or 8"), or to such depth and width as directed by the Engineer. The entire area shall be plowed and dragged prior to placing a stabilizing additive, if required to meet minimum bearing value.
2. Subbase shall be compacted to a minimum density of 98 percent of the maximum as determined by the Modified Proctor Density AASHTO T180, and shall have a minimum bearing value of 40 pounds per square inch as determined by the Florida

Bearing Test.

B. Base Course:

1. Check subgrade for conformity with elevations and section immediately before placing base material.
2. Place base material in compacted layers not more than 6 inches thick, unless continuing tests indicate the required results are being obtained with thicker layers.
3. In no case will more than 8-inches of compacted base be placed in one lift.
4. Spread, shape, and compact all base material deposited on the subgrade during the same day.
5. Compact base course material to be not less than 95% of maximum density: ASTM D 1557, Method D (98 percent maximum density: AASHTO T-180).
6. Test density of compacted base course: ASTM D 2167.
7. Conduct one test for each 250 sq. yds. of in-place material, but in no case not less than one daily for each layer.

C. Loose and Foreign Material:

1. Remove loose and foreign material from compacted subbase surface immediately before application of paving.
2. Use power brooms or blowers, and brooming as required.
3. Do not displace subbase material.

D. Prime Coat:

1. Uniformly apply at rate of 0.20 to 0.5 gal. per sq. yd. over compacted and cleaned subbase surface.
2. Apply enough material to penetrate and seal, but not flood the surface.
3. Allow to cure and dry as long as required to attain penetration and evaporation of volatile, and in no case less than 24 hours unless otherwise acceptable to the Engineer.
4. Blot excess asphalt with just enough sand to prevent pick-up under traffic.
5. Remove loose sand before paving.

E. Tack Coat:

1. Dilute material with equal parts of water and apply to contact surfaces of previously constructed asphalt concrete or portland cement concrete and similar surfaces.
2. Apply at rate of 0.05 to 0.15 gal. per sq. yd. of surface.
3. Apply tack coat by brush to contact surfaces of structures projecting into or abutting asphalt concrete pavement.
4. Allow surfaces to dry until material is at condition of tackiness to receive pavement.

3.02 MANHOLE FRAME / VALVE BOX ADJUSTMENTS (IF APPLICABLE)

A. Placing Manhole frames:

1. Surround manhole frames set to elevation with a ring of compacted asphalt concrete base prior to paving.
2. Place asphalt concrete mixture up to 1 in. below top of frame, slope to grade, and compact by hand tamping.

- B. Adjust manhole frames to proper position to meet paving.
- C. If permanent covers are not in place, provide temporary covers over openings until completion of rolling operations.
- D. Set cover manhole frames to grade, flush with surface of adjacent pavement.

3.03 PREPARING THE MIXTURE

- A. Comply with ASTM D 995 for material storage, control, and mixing, and for plant equipment and operation.
- B. Stockpiles:
 - 1. Keep each component of the various-sized combined aggregates in separate stockpiles.
 - 2. Maintain stockpiles so that separate aggregate sizes shall not be intermixed.
- C. Heating:
 - 1. Heat the asphalt cement at the mixing plant to viscosity at which it can be uniformly distributed throughout mixture
 - 2. Use lowest possible temperature to suit temperature-viscosity characteristics of asphalt.
 - 3. Do not exceed 350 degrees F. (176.6 degrees C.).
- D. Aggregate:
 - 1. Heat-dry aggregates to reduce moisture content to not more than 2.0%.
 - 2. Deliver dry aggregate to mixer at recommended temperature to suit penetration grade and viscosity characteristics of asphalt cement, ambient temperature, and workability of mixture.
 - 3. Accurately weigh or measure dry aggregates and weigh or meter asphalt cement to comply with job-mix formula requirements.
- E. Mix aggregate and asphalt cement to achieve 90-95% of coated particles for base mixtures and 85-90% of coated particles for surface mixture, when tested in accordance with ASTM D 2489.
- F. Transporting:
 - 1. Transport asphalt concrete mixtures from mixing site in trucks having tight, clean compartments.
 - 2. Coat hauling compartments with a lime-water mixture to prevent asphalt concrete mixture from sticking.
 - 3. Elevate and drain compartment of excess solution before loading mix.
 - 4. Provide covers over asphalt concrete mixture when transporting to protect from weather and to prevent loss of heat.
 - 5. During periods of cold weather or for long-distance deliveries, provide insulation around entire truck bed surfaces.

3.04 EQUIPMENT

- A. Provide size and quantity of equipment to complete the work specified within project time schedule.
- B. Bituminous Pavers: Self-propelled that spread hot asphalt concrete mixtures without tearing, shoving or gouging surfaces, and control pavement edges to true lines without use of stationary forms.
- C. Rolling Equipment:
 - 1. Self-propelled, steel-wheeled and pneumatic-tired rollers that can reverse direction without backlash.
 - 2. Other type rollers may be used if acceptable to the Engineer.
- D. Hand Tools: Provide rakes, lutes, shovels, tampers, smoothing irons, pavement cutters, portable heaters, and other miscellaneous small tools to complete the work specified.

3.05 PLACING THE MIX

- A. Place asphalt concrete mixture on prepared surface, spread and strike-off using paving machine.
- B. Spread mixture at a minimum temperature of 225 degrees F. (107.2 degrees C.).
- C. Inaccessible and small areas may be placed by hand.
- D. Place each course at thickness so that when compacted, it will conform to the indicated grade, cross-section, finish thickness, and density indicated.
- E. Paver Placing:
 - 1. Unless otherwise directed, begin placing along centerline of areas to be paved on crowned section, and at high side of sections on one-way slope, and in direction of traffic flow.
 - 2. After first strip has been placed and rolled, place succeeding strips and extend rolling to overlap previous strips.
 - 3. Complete base courses for a section before placing surface courses.
 - 4. Place mixture in continuous operation as practicable.
- F. Hand Placing:
 - 1. Spread, tamp, and finish mixture using hand tools in areas where machine spreading is not possible, as acceptable to Engineer.
 - 2. Place mixture at a rate that will insure handling and compaction before mixture becomes cooler than acceptable working temperature.
- G. Joints:
 - 1. Carefully make joints between old and new pavements, or between successive days' work, to ensure a continuous bond between adjoining work.
 - 2. Construct joints to have same texture, density and smoothness as adjacent sections of asphalt concrete course.
 - 3. Clean contact surfaces free of sand, dirt, or other objectionable material and apply tack coat.

4. Offset transverse joints in succeeding courses not less than 24 inches.
5. Cut back edge of previously placed course to expose an even, vertical surface for full course thickness.
6. Offset longitudinal joints in succeeding courses not less than 6 inches.
7. When the edges of longitudinal joints are irregular, honeycombed, or inadequately compacted, cut back unsatisfactory sections to expose an even, vertical surface for full course thickness.

3.06 COMPACTING THE MIX

- A. Provide sufficient rollers to obtain the required pavement density.
- B. Begin rolling operations as soon after placing when the mixture will bear weight of roller without excessive displacement.
- C. Do not permit heavy equipment, including rollers to stand on finished surface before it has thoroughly cooled or set.
- D. Compact mixture with hot hand tampers or vibrating plate compactors in areas inaccessible to rollers.
- E. Start rolling longitudinally at extreme lower side of sections and proceed toward center of pavement. Roll to slightly different lengths on alternate roller runs.
- F. Do not roll centers of sections first under any circumstances.
- G. Breakdown Rolling:
 1. Accomplish breakdown or initial rolling immediately following rolling of transverse and longitudinal joints and outside edge.
 2. Operate rollers as close as possible to paver without causing pavement displacement.
 3. Check crown, grade, and smoothness after breakdown rolling.
 4. Repair displaced areas by loosening at once with lutes or rakes and filling, if required, with hot loose material before continuing rolling.
- H. Second Rolling:
 1. Follow breakdown rolling as soon as possible, while mixture is hot and in condition for compaction.
 2. Continue second rolling until mixture has been thoroughly compacted.
- I. Finish Rolling:
 1. Perform finish rolling while mixture is still warm enough for removal of roller marks.
 2. Continue rolling until roller marks are eliminated and course has attained specified density.
- J. Patching:
 1. Remove and replace defective areas.
 2. Cut-out and fill with fresh, hot asphalt concrete.
 3. Compact by rolling to specified surface density and smoothness.

4. Remove deficient areas for full depth of course.
5. Cut sides perpendicular and parallel to direction of traffic with edges vertical.
6. Apply tack coat to exposed surfaces before placing new asphalt concrete mixture.

3.07 MARKING ASPHALT CONCRETE PAVEMENT

A. Cleaning:

1. Sweep surface with power broom supplemented by hand brooms to remove loose material and dirt.
2. Do not begin marking asphalt concrete pavement until acceptable to the Engineer.

B. Apply paint with mechanical equipment.

1. Provide uniform straight edges.
2. Not less than two separate coats in accordance with manufacturer's recommended rates.

3.08 CLEANING AND PROTECTION

A. Cleaning: After completion of paving operations, clean surfaces of excess or spilled asphalt materials to the satisfaction of the Engineer.

B. Protection:

1. After final rolling, do not permit vehicular traffic on asphalt concrete pavement until it has cooled and hardened, and in no case sooner than 6 hours.
2. Provide barricades and warning devices as required to protect pavement.
3. Cover openings of structures in the area of paving until permanent coverings are placed (if applicable).

END OF SECTION

SECTION 02575 PAVEMENT REPAIR AND RESTORATION

PART 1 GENERAL

1.01 SCOPE OF WORK

The Contractor shall furnish all labor, materials, equipment, obtain County or State right-of-way permits and incidentals required and remove and replace pavements over trenches excavated for installation of water or sewer lines and appurtenances as shown on the Contract Drawings.

1.02 GENERAL

- A. The Contractor shall take before and after photographs.
- B. The Contractor shall repair in a manner satisfactory to the County or State, all damage done to existing structures, pavement, driveways, paved areas, curbs and gutters, sidewalks, shrubbery, grass, trees, utility poles, utility pipe lines, conduits, drains, catch basin, flagstones, or stabilized areas or driveways and including all obstructions not specifically named herein, which results from this Project.
- C. The Contractor shall keep the surface of the backfilled area of excavation in a safe traffic bearing condition and firm and level with the remaining pavement until the pavement is restored in the manner specified herein. All surface irregularities that are dangerous or obstructive to traffic are to be removed. The repair shall conform to applicable requirements of Manatee County Transportation Department requirements for pavement repair and as described herein, including all base, subbase and asphalt replacement.
- D. All materials and workmanship shall meet or exceed the County requirements and as called for in the Contract Documents and nothing herein shall be construed as to relieve the Contractor from this responsibility.
- E. All street, road and highway repair shall be made in accordance with the FDOT and County details indicated on the Drawings and in accordance with the applicable requirements and approval of affected County and State agencies.

PART 2 PRODUCTS

2.01 PAVEMENT SECTION

- A. Asphaltic concrete shall consist of asphalt cement, coarse aggregate, fine aggregate and mineral filler conforming to FDOT Type S-III Asphalt. Pavement replacement thickness shall match that removed but in no case shall be less than 1-1/2" compacted thickness. All asphalt concrete pavement shall be furnished, installed and tested in accordance with FDOT Specifications for Road and Bridge Construction.
- B. Asphalt or crushed concrete or approved equal base material shall be furnished and installed under all pavement sections restored under this Contract. Asphalt base shall have a minimum 6" compacted thickness, meet requirements for FDOT ABC III (Minimum Marshall Stability of 1000) and be furnished, installed and tested in accordance with the requirements of the FDOT Standards. Crushed concrete base shall be 10" minimum compacted thickness. Crushed concrete aggregate material shall have a minimum LBR of

140 compacted to 99% T-180 AASHTO density. Asphalt base and crushed concrete base are acceptable. Other bases shall be submitted for approval.

- C. Prime and tack will be required and applied in accordance with Section 300 - FDOT Specifications: Prime and Tack Coat for Base Courses.

PART 3 EXECUTION

3.01 CUTTING PAVEMENT

- A. The Contractor shall saw cut in straight lines and remove pavement as necessary to install the new pipelines and appurtenances and for making connections to existing pipelines.
- B. Prior to pavement removal, the Contractor shall mark the pavement for cuts nearly paralleling pipe lines and existing street lines. Asphalt pavement shall be cut along the markings with a rotary saw or other suitable tool. Concrete pavement shall be scored to a depth of approximately two (2) inches below the surface of the concrete along the marked cuts. Scoring shall be done by use of a rotary saw, after which the pavement may be broken below the scoring with a jackhammer or other suitable equipment.
- C. The Contractor shall not machine pull the pavement until it is completely broken and separated along the marked cuts.
- D. The pavement adjacent to pipe line trenches shall neither be disturbed or damaged. If the adjacent pavement is disturbed or damaged, irrespective of cause, the Contractor shall remove and replace the pavement. In addition, the base and sub-base shall be restored in accordance with these Specifications, Florida Dept. of Transportation Standard Specifications and as directed by the Engineer.

3.02 PAVEMENT REPAIR AND REPLACEMENT

- A. The Contractor shall repair, to meet or exceed original surface material, all existing concrete or asphaltic pavement, driveways, or sidewalks cut or damaged by construction under this Contract. He shall match the original grade unless otherwise specified or shown on the Drawings. Materials and construction procedures for base course and pavement repair shall conform to those of the Florida Dept. of Transportation.
- B. The Contractor's repair shall include the preparation of the subbase and base, place and maintain the roadway surface, any special requirements whether specifically called for or implied and all work necessary for a satisfactory completion of this work. Stabilized roads and drives shall be finished to match the existing grade. Dirt roads and drives shall have the required depth of backfill material as shown on the Contract Drawings.
- C. The width of all asphaltic concrete repairs shall extend the full width and length of the excavation or to the limits of any damaged section. The edge of the pavement to be left in place shall be cut to a true edge with a saw or other approved method so as to provide a clean edge to abut the repair. The line of the repair shall be reasonably uniform with no unnecessary irregularities.

3.03 MISCELLANEOUS RESTORATION

Sidewalks or driveways cut or damaged by construction shall be restored in full sections or blocks to a minimum thickness of four inches. Concrete curb or curb and gutter shall be

restored to the existing height and cross section in full sections or lengths between joints. RCP pipe shall be repaired or installed in accordance with manufacturer's specifications. Grassed yards, shoulders and parkways shall be restored to match the existing sections with grass sod of a type matching the existing grass.

3.04 SPECIAL REQUIREMENTS

The restoration of all surfaces, as described herein, disturbed by the installation of pipelines shall be completed as soon as is reasonable and practical. The complete and final restoration of both paved and shell stabilized roads within a reasonable time frame is of paramount importance. To this end, the Contractor shall, as part of his work schedule, complete the restoration of any area of road within five weeks after removing the original surface. Successful leak testing shall be performed prior to restoring any area of road. All restoration and replacement or repairs are the responsibility of the Contractor.

3.05 CLEANUP

After all repair and restoration or paving has been completed, all excess asphalt, dirt and other debris shall be removed from the roadways. All existing storm sewers and inlets shall be checked and cleaned of any construction debris.

3.06 MAINTENANCE OR REPAIR

All wearing surfaces shall be maintained by the Contractor in good order suitable for traffic prior to completion and acceptance of the work.

END OF SECTION

SECTION 02590 WATER SERVICES ON PRIVATE PROPERTY

PART 1 GENERAL

1.01 SCOPE OF WORK

Furnish all labor, materials, equipment and incidentals necessary for complete installation of potable water services for and on the lots identified on the Drawings when authorized by the County and Property Owner. The Contractor shall construct water service lines on private property from the proposed County meter to a connection point within the customer's water system. In addition, the Contractor shall remove the existing water meter and box assembly and cap and abandon the existing water service at the service line, or as directed by the County. Backflow Preventers and associated Thermal Expansion Tanks and vacuum breakers on all outside hose bibbs shall be installed by the Contractor where cross connection risks are present, as required by the applicable County Ordinances and Plumbing Codes. Installation of Expansion Tanks will often require the Contractor to access inside existing buildings and coordinate work and timing with individual property owners.

1.02 GENERAL

- A. The work shall include furnishing and installing a pipe, fittings, valves, and appurtenances necessary to convey water from the customer's water meter at the property line to the house service connection, including restoration of all lawns, drives, walkways, plants, customer private property, and other activities necessary to restore the site to a condition equal to or better than that which existed prior to construction. The Contractor shall carefully examine the Drawings and shall be responsible for the proper fittings of materials and equipment in each building and on each lot or site. All work shall comply with local code requirements.
- B. Plumbing fixtures, devices and pipe shall be installed in such a manner to prohibit a cross connection or interconnection between a potable water supply and a polluted supply. The plumbing installation shall further prohibit the backflow of sewage, polluted water, or waste into the water supply system. The Contractor shall install vacuum breakers on all outside hose bibbs where backflow preventers are required.
- C. Required materials not covered by the Specifications shall meet the requirements of the local Plumbing Code, other applicable State and Local Ordinances and Codes, the AWWA, NSF, and shall conform to accepted plumbing practice.
- D. The Contractor shall coordinate all work called for in the Contract Documents with the County Meter Superintendent and other involved parties, and shall establish a work plan to install the new water service lines which results in minimal impact to customer private property.
- E. All work on customer service lines conducted on private property shall be performed by a plumber licensed in Manatee County and experienced in furnishing and installing potable water plumbing systems.
- F. Upon completion of water service construction on private property, the Contractor shall obtain a Building Department inspection and approval to place the system into operation.

- G. Pipe openings shall be closed with caps or plugs during installation. Fixtures and equipment shall be tightly covered and protected against dirt, water and chemical or mechanical injury. Upon completion of all work, the fixtures, materials and equipment shall be thoroughly cleaned, adjusted and operated.

1.03 SUBMITTALS

- A. The Contractor shall submit to the Engineer for review and approval in accordance with the Contract Documents: complete shop drawings, working drawings, and product data for all materials and equipment furnished under this Section. The Contractor shall meet with each property owner to coordinate the routing of the water service line on private property prior to the commencement of any work and shall document the agreed upon route on a sketch signed and dated by all parties and submit them to the Engineer.

1.04 CODES, ORDINANCES AND PERMITS

- A. The Contractor shall comply with all of the laws, ordinances, and codes, rules and regulations of the local and state authorities having jurisdiction over any of the work specified herein. He shall apply and pay for all necessary permits, including Manatee County Building Permits for all lots. Up to 11 permits at \$75 each may be required, with up to 10 adjacent lots on each permit.
- B. If any part of the Plans and Specifications conflict with existing laws and codes, the Contractor shall call it to the Engineer's attention prior to the commencement of work.

1.05 GUARANTEE

- A. The Contractor shall warrant all labor and materials free from defects for a period of one (1) year from the date of acceptance and shall, upon notification during this period, promptly repair or replace any defective items of material or equipment at no additional cost.

1.06 ACCESSIBILITY

- A. The Contractor shall inform himself fully regarding the peculiarities and limitations of the space available for the installation of all material in this Contract.
- B. The Contractor is responsible for obtaining access to the private properties identified on the Drawings. The County will issue notices to the Owners of the Properties requesting their cooperation with the Contractor.

PART 2 PRODUCTS

2.01 MATERIALS

- A. Refer to Manatee County Utility Standards (Manual) for details. All pipe, fittings, materials, and appurtenances shall be furnished and installed to meet the requirements of this project and the requirements of the Florida Building Code - Plumbing, and Residential Chapter 29 (Water Supply & Distribution).

- B. If required by site specific conditions, the Backflow Preventer, Thermal Expansion Tank, and vacuum breakers shall be in accordance with Manatee County Utility Standards, latest edition and are subject to the approval of the Engineer.
- C. Water service pipe shall be Schedule 40 PVC.
- D. A dielectric coupling shall be provided between ferrous and nonferrous materials.
- E. The Contractor shall furnish certified statements from the manufacturer that the material conforms to the requirements specified above.

PART 3 EXECUTION

3.01 PLANNING AND COORDINATION

- A. The Contractor shall coordinate with each water customer, property owner and the County Meter Superintendent to establish a reasonable plan and location for installation of each new customer water service line. The Contractor shall perform exploratory work and have all materials in hand at the commencement of construction to reduce the risk of delays in completion of the work associated with lack of materials.
- B. The Contractor shall schedule the installation of the new water service lines to coordinate with the installation of the new County water line, water services and water meters as a part of this project. The Contractor shall carefully schedule the work of subcontractor licensed plumbers to ensure that customer water service disruption is minimized and is not interrupted for longer than the period specified in the Specifications. The Contractor shall schedule the inspection of the work by Manatee County Building officials as necessary to allow for timely use of the new customer service.
- C. The County will provide new and/or existing water meters to the Contractor to install in proposed meter boxes. The Contractor shall remove existing meters from meter boxes as part of this Contract, return the meters to the County Meter Division, and shall verify with the County Meter Division which meters shall be reinstalled new and which will be reused. Just prior to removing an existing meter from service, the Contractor shall notify the customer, record the existing meter reading, and record the serial number prior to returning meters to the County meter division.

3.02 PRIVATE WATER SERVICE CONSTRUCTION

- A. The Contractor shall install new 1 inch diameter water service lines at a location on the customer's property that is agreed to by the property owner, minimizes impact to existing site features and private property improvements and which most directly connects the new water meter location with the connection point for the customers water service.
- B. The new water service connection on private property shall include new customer service line from the new meter location to the agreed upon point of connection with the customer house water service line; piping, fittings, valves, and appurtenances, excavation and backfill as required; restoration of grass, shrubs, drives, walkways, and other customer property damaged by construction and related work required to result in a new customer service line system that meets code requirements.

3.03 STERILIZATION

The entire potable water collection and distribution system shall be thoroughly sterilized with a solution of not less than 50 parts per million of available chlorine. The sterilizing solution shall be allowed to remain in the system for a period of three hours after which time all valves and faucets shall be opened and the system shall be flushed with clean water until the residual chlorine content is not greater than 0.92 parts per million, unless otherwise directed.

END OF SECTION

SECTION 02615 DUCTILE IRON PIPE AND FITTINGS

PART 1 GENERAL

1.01 SCOPE OF WORK

- A. The Contractor shall furnish all labor, materials, equipment and incidentals required to install ductile iron pipe and restrained joint ductile iron pipe and cast iron or ductile iron restrained joint fittings, complete, as shown on the Drawings and specified in these Standards.
- B. Fittings are noted on the drawings for the Contractor's convenience and do not relieve him from laying and jointing different or additional items where required.
- C. The Contractor shall furnish all labor, materials, equipment and incidentals required to install push-on joint or restrained joint ductile iron pipe, complete as shown on the Drawings and Specifications.
- D. Newly installed pipe shall be kept clean and free of all foreign matter. All DI pipe installed underground shall be poly wrapped unless noted otherwise on the plans.

1.02 SUBMITTALS

- A. The Contractor shall submit to the Engineer, within ten days after receipt of Notice to Proceed, a list of materials to be furnished, the names of the suppliers and the appropriate shop drawings for all ductile iron pipe and fittings.
- B. The Contractor shall submit the pipe manufacturer's certification of compliance with the applicable sections of the Specifications.

PART 2 PRODUCTS

2.01 MATERIALS

- A. Ductile iron pipe shall conform to ANSI/AWWA C150/A21.50 and ANSI/AWWA C151/A21.51. Thickness of pipe shall be Class 50 or pressure Class 350. All pipe not buried shall be Class 53. All ductile iron pipe shall be clearly marked on the outside of the barrel to readily identify it from cast iron.
- B. Unrestrained joint pipe shall be supplied in lengths not to exceed 21 feet. Unless otherwise called for in the Contract Documents, unrestrained joint pipe shall be either the rubber-ring type push-on joint or standard mechanical joint pipe as manufactured by the American Cast Iron Pipe Company, U.S. Pipe and Foundry Company, or approved equal.
- C. All fittings shall be pressure rated for 350 psi and meet the requirement of AWWA C110 or AWWA C153. Rubber gaskets shall conform to ANSI A21.11 for mechanical and push-on type joints for diameters up to 14" diameter. Gaskets for 16" diameter and larger pipe shall be EPDM (Ethylene-Propylene Dine Monomer) such as the "Fastite Gasket" of American Ductile Iron Pipe Co., or approved equal.
- D. Water Mains: All ductile iron pipe and fittings shall have a standard thickness cement lining on the inside in accordance with AWWA/ANSI C104/A21.4 and a coal tar enamel

coating on the outside. The coal tar enamel shall be in accordance with ANSI A21.4. All interior linings shall be EPA/NSF approved.

- E. Force Main Fittings: All ductile iron fittings shall have a factory applied fusion bonded epoxy or epoxy and polyethylene lining on the inside in accordance with manufacturer's specifications and a coal tar enamel coating on the outside. The coal tar enamel shall be in accordance with ANSI A21.4. The interior lining is to be based on manufacturer's recommendation for long-term exposure to raw sewage. It shall have a minimum ten year warranty covering failure of the lining and bond failure between liner and pipe.
- F. Restrained joints shall be provided at all horizontal and vertical bends and fittings, at casings under roads and railroads and at other locations shown on the Contract Drawings. Restrained joint pipe fittings shall be designed and rated for the following pressures: 350 psi for pipe sizes up to and including 24" diameter; 250 psi for pipe sizes 30" diameter and above.

2.02

IDENTIFICATION

- A. Each length of pipe and each fitting shall be marked with the name of the manufacturer, size and class and shall be clearly identified as ductile iron pipe. All gaskets shall be marked with the name of the manufacturer, size and proper insertion direction.
- B. Pipe shall be poly wrapped blue for potable water mains, purple for reclaimed water mains and green for sewage force mains. All potable water pipe shall be NSF certified and copies of lab certification shall be submitted to the Engineer.

END OF SECTION

SECTION 02616 DISINFECTING POTABLE WATER PIPE LINES

PART 1 GENERAL

1.01 SCOPE OF WORK

The Contractor shall furnish all labor, materials, equipment and incidentals required to clean and disinfect potable water pipe lines. This work is required to place all types of pipe into service as potable water lines.

1.02 CLEANING WATER MAINS

At the conclusion of the work, the Contractor shall thoroughly clean all of the new pipes to remove all dirt, stones, pieces of wood or other material which may have entered during the construction period per Section 02618.

1.03 DISINFECTING POTABLE WATER PIPE LINES

- A. All record drawing requirements must be submitted to the Owner/Engineer prior to starting the bacteriological testing of the water lines.
- B. Prior to being placed in service, all potable water pipe lines shall be chlorinated in accordance with AWWA 651, "Standard Procedure for Disinfecting Water Main". The procedure shall meet Health Department requirements. The location of the chlorination and sampling points shall be determined by the Engineer. Taps for chlorination and sampling shall be uncovered and backfilled by the Contractor as required.
- C. The general procedure for chlorination shall be to flush all dirty or discolored water from the lines, then introduce chlorine in approved dosages through a tap at one end while water is being withdrawn at the other end of the line. The chlorine solution shall remain in the pipe line for 24 hours.

Water for flushing, filling and disinfecting the new lines must be obtained without contaminating existing pipe lines. Water obtained from existing pipe lines for this purpose shall pass through an approved air gap or backflow prevention device.
- D. Following the chlorination period, all treated water shall be flushed from the lines at their extremities and replaced with water from the distribution system. Bacteriological sampling and analysis of the replacement water shall then be made by an approved laboratory or the Health Department in full accordance with the AWWA Manual C651. The line shall not be placed in service until the requirements of the State and County Public Health Department are met. Results of the bacteriological tests together with certified record drawings must be submitted to the Health Department (FDEP) within 30 days of the tests.
- E. Special disinfecting procedures when approved by the County, may be used where the method outlined above is not practical.

END OF SECTION

SECTION 02617 INSTALLATION AND TESTING OF PRESSURE PIPE

PART 1 GENERAL

1.01 INSTALLING PIPE AND FITTINGS

- A. The Contractor shall install all pipe in accordance with the recommendations of the pipe manufacturer and as specified herein.
- B. The Contractor shall take care in handling, storage and installation of pipe and fittings to prevent injury to the pipe or coatings. All pipe and fittings shall be examined before installation and pipe which is deemed to be defective by the Owner/Engineer shall not be installed.
- C. The Contractor shall thoroughly clean and keep thoroughly clean, all pipe and fittings prior to during and after installation.
- D. The Contractor shall lay the pipe to the lines and grades shown on the Contract Drawings with bedding and backfill as shown on the Drawings or called out in the Contract Documents. Blocking under the pipe shall not be permitted except through casing sleeves.
- E. The Contractor shall keep the open ends of all pipe closed with a tightly fitting plug when installation is not in progress or the potential exists for dirt or debris to enter the pipe.
- F. The pipe or accessories shall not be dropped into the trench under any circumstances.
- G. The Contractor shall construct all water mains pursuant to the provisions of "Recommended Standards for Water Works", Part 8, incorporated by reference in Rule 17-555.330(3), F.A.C.

1.02 PROCEDURE FOR TESTING WATER LINES, FORCE MAINS AND RECLAIMED WATER LINES

- A. A 48-hour notice is needed prior to testing. A letter stating the reasons testing should be scheduled ahead of other jobs must accompany all emergency testing requests.
- B. Engineer and Contractor must be present for all testing, except for testing tapping valves and sleeves.
- C. All pressure pipe lines shall remain undisturbed for 24 hours to develop complete strength at all joints. All pipe lines shall be subjected to a hydrostatic pressure test for two (2) hours at full working pressure, but not less than 180 psi for water/reclaimed (150 psi for force main). Maximum length of pipe to be tested at one time is 2,600 feet. If line is longer than 2,600 feet and cannot be sectioned in 2,600 feet (max.) lengths, the allowable leakage will be figured at 2,600 feet.
- D. Allowable leakage shall be determined by AWWA C600 table for hydrostatic tests. Leakage shall be defined as the quantity of water that must be supplied into the newly laid pipe, or any valved section thereof; to maintain the test pressure after the air in the pipe line has been expelled and the pipe has been filled with water.

- E. All digging on the job site in the right-of-way must be completed before any testing of water or sewer. Any digging or boring across water or sewer lines after they have been tested may result in a retest of the lines at the County's request.
- F. If any revisions or changes are made after initial testing, lines will be re-tested at the County's request.
- G. Disconnect water supply during test.
- H. All force mains will be tested from the valves in the valve vault at the lift station to the point of connection whether it be against a valve on another force main or into a manhole.
- I. All services to be aboveground during test. The services should be the correct length so they will be one (1) foot inside right-of-way line.
- J. All fire hydrant gate valves to be open during test.
- K. All visible leaks are to be repaired, regardless of the amount of leakage.
- L. Check gauge pressure periodically during test. If test pressure drops to 175 psi for water/reclaimed lines or to 145 psi for force mains during test, the line must be repumped back to 180 psi for water/reclaimed (150 psi force mains) and the amount of leakage measured. The test will continue on with the remaining time left. At the end of the test, the line must be repumped again back to 180 psi (150 psi for force main) and the amount of leakage measured and added to any previous leakage determined earlier in the test.
- M. After the line passes the test, the pressure will be blown off from the opposite end of line from the gauge location. Fire hydrants, services and end-of-line blow offs will be opened to demonstrate they were on line during the test.
- N. At end of test, the test gauge must return to zero. The pressure gauge must read 0 psi to a maximum of 300 psi in 5 psi increments.
- O. The section of line being tested must be identified on the charge sheet. The length and size of pipe, the exact area being tested and the valves being tested against, must be identified. Use Station numbers if available.
- P. A punch list must be made at the end of all tests.
- Q. A copy of the charge sheet will be given to the Engineer and the Contractor at the end of the test.

1.03

INSPECTION/TESTING PROCEDURE COVERING BORED PIPE LINES OR CASING AND CONDUITS INSTALLED ACROSS PREVIOUSLY TESTED AND/OR COUNTY ACCEPTED WATER AND SEWER PIPE WITHIN DEVELOPMENT PROJECTS UNDER ACTIVE CONSTRUCTION

- A. Prior to testing water and sewer lines, every effort will be made to install sleeves for underground utilities that will cross these water and sewer lines or services.
- B. Where it has not been possible to pre-install sleeves prior to testing and bores or conduits are required, it is the responsibility of the utility company and/or their Contractor performing the work to provide Manatee County Utility Operations Department or the

Engineer of Record with accurate horizontal and vertical as-built information of the sleeves, bores and conduits installed by said utility company. This applies to all bores and conduits crossing water and sewer lines.

- C. Procedures to be followed for installation of conduits, pipe lines and bores that will cross, or be closer than 5'-0" horizontally and 18 inches vertically to, previously tested water and sewer lines that are still under the ownership of the developer/contractor.
1. Notify the owner and obtain the best as-built information available. Allow sufficient time for the owner to field locate the existing pipe lines.
 2. Submit drawings of proposed location to the Owner and Manatee County Utility Operations Dept. Utility Locations Section for review.
 3. Obtain a County Right-of-Way Use Permit if the work area is within a dedicated area of right-of-way.
 4. Perform installation in the presence of a County representative. Call (941) 792-8811, ext. 5061 or ext. 5069 with at least two (2) working days notice.
 5. Submit two (2) copies of as-built information to the Owner to incorporate into the record drawings to be submitted to the County.
 6. Failure to follow steps 2) thru 5) will result in additional charges for retesting the previously tested water and sewer lines.
- D. Procedures to be followed for installation of conduits, pipe lines and bores crossing or closer than 5'-0" horizontally and 18 inches vertically to previously tested water and sewer lines that have been previously accepted by Manatee County:
1. Obtain record drawing information from the County.
 2. If roadway has been dedicated to Manatee County, obtain Right-of-Way Use Permit and copy the Project Management Department Locations Section with proposed location drawing.
 3. Follow procedures in "Sunshine State One-Call", paying special attention to the requirements of Section VII.
- E. Should water or sewer lines be damaged during the bore pipe line or casing installation, the cost of any repairs and retesting will be paid for by the utility company that installed the bore. The actual clearance between a bored casing crossing a water or sewer pipe should not be less than 18 inches.

END OF SECTION

SECTION 02618 PIPELINE CLEANING

PART 1 GENERAL

1.01 SCOPE OF WORK

- A. The Contractor shall furnish all labor, materials, equipment and incidentals required to clean all new lines 4" and larger, and existing pipelines as specified in this specification and as indicated on the Drawings.
- B. This work shall include the furnishing and installation of all pig launching and retrieval devices and the appropriate pigs for the cleaning procedure, and all necessary excavations, shutdowns, fittings and valves required.

1.02 RELATED WORK

- A. The contractor is responsible for all necessary supply water.
- B. The contractor is responsible for all necessary bypass pumping.
- C. The contractor is responsible for the proper disposal of any materials removed from the pipe lines as a result of the cleaning procedure.

1.03 SUBMITTALS

- A. The Contractor shall submit prior to construction, a cleaning plan, Shop Drawings, and layout diagram for approval to the Engineer.
- B. The Contractor shall submit to the Engineer a list of materials to be furnished, and the names of suppliers.

1.04 QUALIFICATIONS

- A. The Contractor performing this work shall be fully qualified, experienced and equipped to complete this work expeditiously and in a satisfactory manner.
- B. The Contractor shall also be capable of providing crews as needed to complete this work without undue delay.
- C. The Owner reserves the right to approve or disapprove the Contractor, based on the submitted qualifications.

PART 2 PRODUCTS

2.01 GENERAL

- A. The contractor shall be responsible for furnishing pigs in sufficient numbers and sizes, of appropriate densities, coatings and configurations to properly clean the piping systems.
- B. All pigs used for the cleaning of sewer or reclaimed water lines shall not be used in the cleaning of potable water lines.

2.02 MATERIALS

- A. The pig launching and retrieval equipment shall be of the latest design and construction and shall include the means to maintain constant monitoring of the in-line flows and pressures of the system being cleaned and the constant location of the cleaning pigs in the system. Launching and retrieval systems shall be fabricated, designed and manufactured according to ANSI standards and capable of withstanding working pressures of 150 psi. Launching and receiving devices shall be sized one diameter larger than the system to which it will be attached with a minimum length of 2.5 times the diameter.
- B. The contractor shall have available for immediate use an electronic pig detector for use in the system being cleaned to provide a means of tracking the passage of the pig in the system to locate areas of potential or suspected blockage and other disparities in the system.
- C. The pig shall be constructed of elastomer polyurethane with an open cell construction and a density equal to or suitable for use in the piping system being cleaned. Pig configuration shall consist of a parabolic nose with a concave base and coated with a resilient surface material that will maintain a peripheral seal and will effectively clean the piping system without over abrading the interior pipe wall. Pig characteristics shall include the ability to navigate through 90 degree bends, 180 degree turns, bi-directional fittings, full port valves, reduce its cross sectional area and return to its original design configuration and be propelled by hydraulic pressure.

PART 3 EXECUTION

3.01 PIPELINE CLEANING

- A. The cleaning of the pipe line shall be done by the controlled and pressurized passage of a polyurethane pig of varying dimensions, coatings and densities as determined by the Engineer through the piping system.
- B. A series of pigs shall be entered into the system at a point as near to the beginning as is logistically and mechanically feasible.
- C. A launching assembly shall be used as the entrance point for the pig. This assembly shall allow for the following:
 - 1. The entering of pigs into the system by providing the means to induce flow from an external source, independent of the flows and pressures immediately available from the system, on the back of the pig to develop sufficient pressure to force the pig through the system.
 - 2. A means to control and regulate the flow.
 - 3. A means to monitor the flows and pressures.
 - 4. A means to connect and disconnect from the system without any disruption to the operation of the system.
- D. The pig shall be removed or discharged from the system at a point as near to the end as is logistically and mechanically feasible.
- E. The contractor shall be responsible for the retrieval of the pig at the discharge point. This may include setting a trap that will not disrupt normal flow and operations but will capture

the pig and any debris. A retrieval assembly may also be used but said assembly shall be able to connect and disconnect from the system without any disruption to the operation of the system.

- F. Alternative launching and retrieval methods shall be done with the prior approval of the Engineer.
- G. Any pig that cannot progress through the piping system shall be located by the contractor and removed by excavation of the pipe in order to remove the blockage. All pipe repairs shall be the responsibility of the contractor and shall be performed with as little disruption to the system as possible.
- H. Any increase in pressure that cannot be accounted for, i.e. fittings or valves or additional cleaning runs, shall be investigated, per the Engineers' approval, by locating the pig at the beginning of the increased pressure and excavating to determine the cause of the pressure increase. All pipe repairs shall be the responsibility of the contractor and shall be performed with as little disruption to the system as possible.
- I. Final flushing of the cleansed lines shall be performed after the last successful run of the pig as determined by the Engineer. The contractor shall be responsible for all applicable flushing and disinfection requirements for potable water lines.

3.02 ACCEPTANCE

- A. The contractor shall maintain and provide a report at the end of the cleaning procedure containing the following:
 - 1. The pressures in the pipe during the pigging procedure.
 - 2. Any inline problems encountered during the procedure including all excavations with detailed locations, reason for the excavation and any corrective measures taken to the pipeline.
 - 3. A record of the pigs used, their sizes, styles and other pertinent information regarding what materials were used during the cleaning.
 - 4. An analysis of the condition of the pipeline before and after the cleaning procedure.

END OF SECTION

SECTION 02619 HORIZONTAL DIRECTIONAL DRILLING

PART 1 GENERAL

1.01 SCOPE

The Contractor shall furnish all labor, materials, equipment and incidentals required to install all pipe, fittings and appurtenances as shown on the Drawings and specified in the Contract Documents by Horizontal Directional Drilling (HDD).

1.02 GENERAL

- A. All existing structures, water and sewer lines, storm drains, utilities, driveways, sidewalks, signs, mail boxes, fences, trees, landscaping, and any other improvement or facility in the construction area that the Contractor disturbs for his own construction purposes shall be replaced to original condition at no additional cost to the County.
- B. For "Navigable Waters of the U.S." reference 33 of the Code of Federal Regulations, Part 329.
- C. For "Waters of the U.S." reference 33 of the Code of Federal Regulations, Part 323.
- D. For "Waters of the State" reference Section 62-301 of the Florida Administrative Code.

1.03 TESTING

- A. In place soil compaction tests shall be performed by a qualified testing laboratory.
- B. Compaction tests shall be taken at every excavation, except in the road crossings or road shoulders; tests are to be taken according to current FDOT Standards.
- C. All pipe shall be tested in accordance with the appropriate material specifications.
- D. Reference Standards: American Society for Testing and Materials (ASTM), D1557, Moisture-Density Relations of Soils Using 10-lb. Rammer and 18-in. Drop.
- E. The density of soil in place shall be a minimum of 95 percent in accordance with ASTM test 1557-70T, Method A or C.

1.04 QUALIFICATIONS

- A. Pipe Manufacture: All pipe and fittings shall be furnished by a single manufacturer who is fully experienced, reputable and qualified in the manufacture of the items to be furnished.
- B. Drilling Supervisor: The Contractor shall provide a competent boring specialist who shall remain on the project site during the entirety of the directional boring operation. This includes, but is not limited to, drilling fluid preparation, seaming, boring and pulling. The boring specialist shall have a minimum of five years experience in supervising directional bores of similar nature, diameter, materials and lengths.

- C. Pipe Fusion: All boring and fusing equipment shall be certified for operation. The Contractor responsible for thermal butt fusing pipe and fittings shall have manufacturer certification for performing such work or a minimum of five years experience performing this type of work. If no certification is available, written documentation of the required work experience shall be submitted for approval.
- D. Drilling Fluid Specialist: The personnel responsible for supervising the supply, mixing, monitoring fluid quality, pumping and re-circulation system proposed for the drilling fluid shall have a written certification issued by the Drilling Fluid manufacturer for performing such work or a minimum of five years experience performing this type of work. If no certification is available, written documentation of the required work experience for the proposed personnel shall be submitted for review and approval.

1.05 SUBMITTALS

- A. Detailed description including specifications and catalog cuts for:
 - 1. Shop drawings and catalog data for all HDD equipment.
 - 2. The pipe manufacturer's maximum degree of radial bending allowed for the pipe when full and when empty and pullback force recommended setting.
 - 3. Steering and tracking devices including specific tracer wire.
 - 4. Drilling fluids; the drilling fluid submittal shall include the ratio of mixture to water, including any additives, based on the Contractor's field observations prior to construction, knowledge and experience with drilling in similar conditions, and any soil data provided in the Contract Documents, which shall be verified by the fluid specialist.
 - 5. Shop drawings for the breakaway swivel, including the method of setting the swivels' break point and set point to be used.
 - 6. Pipe assembly procedure, details of support devices, and staging area layout including methods to avoid interference with local streets, driveways, and sidewalks.
 - 7. Details of pipe fusion procedures and copies of the fusion technician qualification certification or documentation.
 - 8. Drilling fluid technician qualification certification or documentation
- B. If the Contractor proposes any changes to the pull-back distance or profile shown on the drawings, he may be required to submit a complete design for the proposed pipe including an analysis for pull-back forces, external loads including full hydrostatic pressure if empty, external forces due to borehole collapse, ovalization during pull-back, thermal stress while exposed to Sun-light, shortening after release of pull-back force, and tensile stress during pull-back.
- C. Bore Plan: For all contiguous piping installations over 300 feet in length or any installations for piping larger than 4" in diameter, the Contractor shall submit a Bore Plan that includes the following:
 - 1. Contact information and experience for the drilling fluid specialist.
 - 2. The number of passes the bore will include to get the product pipe installed.
 - 3. The pilot bore and all reaming bore sizes including the final pullback with the product pipe.
 - 4. Drilling rod length in feet.
 - 5. The pilot bore, pre-ream bores (if any) and pullback production rate in minutes per (drilling) rod to maintain adequate mud flow.

6. Details of the entry and exit pit locations along with entry and exit angles for the bore, drawn to scale, depicting the position of all required equipment, access points, existing facilities to remain in place, existing traffic lanes to be maintained in operation, office trailers and storage sites.
 7. The method of fusing or joining pipe of adjacent bores to ensure that the joint is on grade with the installed pipe.
- D. Furnish a Bore Path Report to the Engineer within seven days of the completion of each bore path. Data collected by the County Representative does not relieve the Contractor from the responsibility of recording his own data. Include the following in the report:
1. Location of project, project name and number
 2. Name of person collecting data, including title, position and company name
 3. Investigation site location (Contract plans station number or reference to a permanent structure within the project right-of-way)
 4. Driller's Log & identification of the detection method used
 5. Elevations and offset dimensions of installed pipe as referenced to the drawings
 6. Data log of pullback force during product pipe installation
 7. All failed bores. Include length of pipe left in place and explanation of failed installation.

PART 2 PRODUCTS

2.01 MATERIALS

- A. Incidental materials that may or may not be used to install the product depending on field requirements are not paid for separately and will be included in the cost of the installed product.
- B. Drilling Fluids shall use a mixture of bentonite clay or other approved stabilizing agent mixed with potable water with a pH of 8.5 to 10.0 to create the drilling fluid for lubrication and soil stabilization. Vary the fluid viscosity to best fit the soil conditions encountered. Contractor shall have appropriate additives for drilling fluid available for different soil conditions that may be encountered. Do not use any other chemicals or polymer surfactants in the drilling fluid without written consent from the Engineer. Certify to the Engineer in writing that any chemicals to be added are environmentally safe and not harmful or corrosive to the product pipe.
- C. For drilling operations that will be below waters of the State of Florida, only bentonite free drilling fluids shall be used. Acceptable products are BioMax, manufactured by M-I Swaco, Inc., P.O. Box 2216, Laurel, Mississippi 39440, Phone: (800) 731-7331 or Bio-Bore, manufactured by Baroid Drilling Fluids, Inc., P.O. Box 1675, Houston, Texas 77251, Phone: (731) 987-5900 or approved equal.
- D. Identify the source of water for mixing the drilling fluid. Approvals and permits are required for obtaining water from such sources as streams, rivers, ponds or fire hydrants. Any water source used other than potable water may require a pH test.
- E. The tracer wire to be used for all directional drills shall be a solid, 10 gauge, high strength, copper clad steel wire with a polyethylene jacket of appropriate color manufactured by Copperhead Industries or Manatee County approved equal.

- F. Breakaway connectors shall be supplied by DCD Design & Manufacturing, Condux International, Inc. or approved equal.

PART 3 EXECUTION

3.01 SITE CONDITIONS

- A. Carry out excavation for entry, exit, recovery pits, slurry sump pits, or any other excavation as specified in the Contract documents. Sump pits are required to contain drilling fluids if vacuum devices are not operated throughout the drilling operation, unless approved by the Engineer.
- B. Within 48 hours of completing installation of the boring product, clean the work site of all excess slurry or spoils. Take responsibility for the removal and final disposition of excess slurry or spoils. Ensure that the work site is restored to pre-construction conditions or as identified on the plans.
- C. Exposure of product pipe to sunlight shall be limited to 14 consecutive days unless approved by the Engineer.
- C. The pipe shall be supported at intervals along its length with rollers or Teflon pads to minimize frictional forces when being pulled, and to hold the pipe above the ground. Surface cuts or scratches greater than or equal to the maximum defect depth in 3.08 E are not acceptable.

3.02 DAMAGE RESTORATION & REMEDIATION

- A. The Contractor shall take responsibility for restoration for any damage caused by heaving, settlement, separation of pavement, escaping drilling fluid (frac-out), or the directional drilling operation, at no cost to the County.
- B. When required by the Engineer, provide detailed plans which show how damage to any roadway facility will be remedied. These details will become part of the Record Drawings Package. Remediation Plans must follow the same guidelines for development and presentation of the Record Drawings. When remediation plans are required, they must be approved by the Engineer before any work proceeds.
- C. For HDD operations that will be below waters of the State of Florida, the contractor shall be responsible for any damage caused by the drilling operation, including, but not limited to, fracturing of the channel bottom. Any State or Federal required environmental cleanup due to the release of drilling fluids into State waters shall be at the Contractor's expense. The Contractor may at his own expense increase the depth of his drilling operations upon the approval from the Engineer.

3.03 QUALIFICATIONS FOR REJECTION OF DIRECTIONAL BORE

- A. The Engineer may reject any portion of the work that is deemed to be non-responsive to the Contract requirements or not in conformance with approved plans and submittals, and for other factors including the following:
 - 1. Failed Bore: When there is any indication that the installed product has sustained damage, stop all work, notify the County and investigate damage. The County may require a pressure and / or mandrel test at no additional cost to the County and

shall have a County representative present during the test. Perform all testing within 24 hours unless otherwise approved by the Engineer. Furnish a copy of the test results and all bore logs to the Engineer for review and approval. The Engineer is allowed up to 5 working days to approve or determine if the product installation is not in compliance with the specifications.

2. Obstructions: If an obstruction is encountered during boring which prevents completion of the installation in accordance with the design location and specification, the pipe may be taken out of service and left in place at the discretion of the Engineer.
3. Pull-back Failure: If the installed breakaway device should fail during pull back.
4. Loss of Drilling Fluids: If the drilling fluid is "lost" during the pull back of the product and can not be regained within the required timeframe of the manufacturer or if more than a reasonable amount of fluid is used to fill an unknown void and flow can not be regained. No pipe shall be pulled without visible flow of drilling fluid.
5. Test Failure: If the pipe shall fail a hydraulic pressure test as specified by the County.
6. Damaged Pipe: If at any time when the product is pulled back and any exposed areas have a greater than allowable "gouging" or visible marring of the pipe per the table in 3.08 E.
7. Alignment Tolerance Exceeded: If the vertical and horizontal limits are not within tolerances.
8. Defective Material: Any other defect in material or workmanship which would affect the quality, performance, or installation life of the installed pipeline.

- B. Remediation: All rejected bores shall be at the Contractors expense to correct and provide a satisfactory installed product. The Contractor shall submit to the Engineer a revised installation plan and procedure for approval before resuming work. The Engineer may require non-compliant installations to be filled with excavatable flowable fill or to be completely removed at no additional cost to the County.

3.04 PRODUCT LOCATING AND TRACKING

- A. The County recognizes walkover, wire line, and wire line with surface grid verification, or any other system as approved by the Engineer, as the accepted methods of tracking directional bores. Use a locating and tracking system capable of ensuring that the proposed installation is installed as intended. The locating and tracking system must provide information on:
1. Clock and pitch information
 2. Depth
 3. Transmitter temperature
 4. Battery status
 5. Position (x,y)
 6. Azimuth, where direct overhead readings (walkover) are not possible (i.e. sub aqueous)
- B. Ensure proper calibration of all equipment before commencing directional drilling operation.
- C. Prepare the Driller's Log. Take and record alignment readings or plot points such that elevations on top of and offset dimensions from the center of the product to a permanent fixed feature are provided. Such permanent fixed feature must have prior approval of the Engineer. Provide elevations and dimensions at all bore alignment corrections (vertical

and horizontal) with a minimum distance between points of 10 feet. Provide a sufficient number of elevations and offset distances to accurately plot the vertical and horizontal alignment of the installed product.

D. Installation Location Tolerances: The location of the initial bored hole shall be deemed acceptable by the Engineer if the deviations of the bore from the design alignment or approved adjustments do not exceed the following tolerances:

1. Profile:
 - a. 2.0 feet within a length of 100 feet
 - b. No reverse curvature within 200 feet
 - c. Total deviation not to exceed 5 feet
2. Alignment:
 - a. 3.0 feet within a length of 200 feet
 - b. No reverse curvature
 - c. Total deviation not to exceed 7.0 feet

3.05 PRODUCT BORE HOLE DIAMETER

Minimize potential damage from soil displacement/settlement by limiting the ratio of the bore hole to the product size. The size of the back reamer bit or pilot bit, if no back reaming is required, will be limited relative to the product diameter to be installed as follows:

Maximum Pilot or Back-Reamer Bit Diameter When Rotated 360 Degrees	
Nominal Inside Pipe Diameter Inches	Bit Diameter Inches
2	4
3	6
4	8
6	10
8	12
10	16
12 and greater	Maximum Product OD plus 6

3.06 EQUIPMENT REQUIREMENTS

- A. The HDD equipment selected by the Contractor shall be capable of drilling, steering, tracking, reaming and installing the pipeline through all the subsurface conditions that may be present at the site.
- B. Match equipment to the size of pipe being installed. Obtain the Engineer's approval for installations differing from the above chart. Ensure that the drill rod can meet the bend radius required for the proposed installation.
- C. All HDD equipment shall have a data logger to record pull back force during all pipe installations.
- D. All HDD equipment that has the capability to exceed the maximum recommended pulling force shall have a breakaway swivel properly attached to the product pipe that will release if the pullback force exceeds the pipe manufacturers recommended pulling force.

3.07 THRUST / PULLBACK REQUIREMENTS

The Contractor shall provide as part of the required working drawings submittal complete data regarding the operational and maximum thrust or pulling forces to be used for the initial drill head and back-reamer installations, and the final pull-back of the pipe. Gages or other measurement tools shall be used to monitor the forces being used.

3.08 INSTALLATION PROCESS

- A. Ensure adequate removal of soil cuttings and stability of the bore hole by monitoring the drilling fluids such as the pumping rate, pressures, viscosity and density during the pilot bore, back reaming and pipe installation. Relief holes can be used as necessary to relieve excess pressure down hole. Obtain the Engineer’s approval of the location and all conditions necessary to construct relief holes to ensure the proper disposition of drilling fluids is maintained and unnecessary inconvenience is minimized to other facility users.
- B. The Contractor shall determine the pull-back rate in order to allow the removal of soil cuttings without building excess down-hole pressure and to avoid local heaving, or spills. Contain excess drilling fluids at entry and exit points until they are recycled and separated from excavated materials, or removed from the site or vacuumed during drilling operations. Ensure that entry and exit pits and storage tanks are of sufficient size to contain the expected return of drilling fluids and soil cuttings. The bored hole shall always be maintained full of drilling fluids for support of surfaces, and the fluid re-circulation equipment shall operate continuously until the pipe installation is completed and accepted by the Engineer.
- C. Ensure that all drilling fluids are disposed of or recycled in a manner acceptable to the appropriate local, state, or federal regulatory agencies. When drilling in suspected contaminated ground, test the drilling fluid for contamination and appropriately dispose of it. Remove any excess material upon completion of the bore. If in the drilling process it becomes evident that the soil is contaminated, contact the Engineer immediately. Do not continue drilling without the Engineer’s approval.
- D. The timing of all boring processes is critical. Install a product into a bore hole within the same day that the pre-bore is completed to ensure necessary support exists. Once pullback operations have commenced, the operation shall continue without interruption until the pipe is completely pulled into the borehole.
- D. E. All prepared pipe that is being used for installation shall be adequately supported off the ground along the entire length to avoid damaging of the material during pullback due to ground surface conditions. Surface cuts or scratches greater than or equal to the maximum defect depth are not acceptable.

Pipe Size	Max. Defect Depth
In.	In.
4	1/16
6	1/11
8	5/32
10	3/16
12	1/4
> 12	Per Pipe Manufacturer’s Recommendations

- F. The drilling fluid specialist shall remain on the project site during the entirety of the

directional boring operation to ensure proper mixture and production of drilling fluids needed for the bore.

- G. Upon successful completion of the pilot hole, the borehole shall be reamed to a minimum of 25 percent greater than the outside diameter of the pipe being installed.
- H. For bores with more than two radii of curvature (entrance and exit), the borehole should be reamed up to 50 percent larger than the outside diameter of the carrier pipe. Prereaming may be necessary dependent on size of material to be pulled.
- I. Additional passes for prereaming may be required for larger pipe. Incremental increases shall be used as needed until appropriate bore hole size has been achieved.
- J. Prereaming must be accomplished with no product attached to the reamer head on all bore pipe 6" and larger. The bore product maybe pulled back on final pass of prereaming upon prior approval from the Engineer.
- K. After reaming the borehole to the required diameter, the pipe shall be pulled through the hole. In front of the pipe shall be a breakaway swivel and barrel reamer to compact the borehole walls.
- L. The Contractor shall not attempt to ream at a rate greater than the drilling equipment and drilling fluid system are designed to safely handle.
- M. Install all piping such that their location can be readily determined by electronic designation after installation. For non-conductive installations, externally attach two (2) tracer wires; see Section 2.01 - Materials, Part I. above, to the product pipe. Connect any break in the conductor line before construction with an electrical clamp, or solder, and coat the connection with a rubber or plastic insulator to maintain the integrity of the connection from corrosion. Clamp connections must be made of brass or copper and of the butt end type with wires secured by compression. Soldered connections must be made by tight spiral winding of each wire around the other with a finished length minimum of 3 inches overlap. Tracking conductors must extend 2 feet beyond bore termini. Test conductors for continuity. Each conductor that passes must be identified as such by removing the last 6 inches of the sheath. No deductions are allowed for failed tracking conductors. Upon completion of the directional bore, the Contractor shall demonstrate to the County that the wire is continuous and unbroken through the entire run of the pipe by providing full signal conductivity (including splices) when energizing for the entire run in the presence of the County Representative. If the wire is broken, the Contractor shall repair or replace it at no additional cost to the County.

END OF SECTION

SECTION 02620 POLYETHYLENE (PE) PRESSURE PIPE

PART 1 GENERAL

1.01 SCOPE OF WORK

- A. The Contractor shall furnish all labor, materials, equipment and incidentals required to install polyethylene pressure pipe, fittings and appurtenances as shown on the Drawings and specified in the Contract Documents and these Standards.
- B. Newly installed pipe shall be kept clean and free of all foreign matter & gouges.
- C. All pipe shall be correctly color coded / identified.

1.02 QUALIFICATIONS

All polyethylene pipe, fittings and appurtenances shall be furnished by a single manufacturer who is fully experienced, reputable and qualified in the manufacture of the items to be furnished.

1.03 SUBMITTALS

- A. The Contractor shall submit to the Engineer, within ten days after receipt of Notice to Proceed, a list of materials to be furnished, the names of the suppliers and the appropriate shop drawings for all polyethylene pipe and fittings.
- B. The Contractor shall submit the pipe manufacturer's certification of compliance with the applicable sections of the Specifications.
- C. The Contractor shall submit shop drawings showing installation method and the proposed method and specialized equipment to be used.

PART 2 PRODUCTS

2.01 POLYETHYLENE PRESSURE PIPE

- A. Polyethylene pipe 4" diameter and larger shall be high-density PE 3408 polyethylene resin per ASTM D 3350, Cell Classification 345464C, Class 160, DR 11, CPChem DriscoPlex 4000, 4300 or 4500 or an approved equal, meeting the requirements of AWWA C906. All pipe materials used in potable water systems shall comply with NSF Standard 61. Outside diameters of water, reclaimed water and pressure sewer HDPE pipes shall be ductile iron size (DIPS).
- B. Polyethylene pipe and tubing 3" diameter and smaller shall be pressure Class 200, DR 9 "Driscopipe 5100", Endo Pure by Endot, or equal, meeting the requirements of AWWA C901 (latest revision) and the following ASTM requirements:

Material Designation PPI/ASTM PE 3408
Material Classification ASTM D-1248 III C5 P34
Cell Classification ASTM D-3350

2.02 JOINTS

- A. Where PE pipe is joined to PE pipe, it shall be by thermal butt fusion. Thermal fusion shall be accomplished in accordance with the written instructions of the pipe manufacturer and fusion equipment supplier. The installer of the thermal butt fused PE pipe shall have received training in heat fusion pipe joining methods and shall have had experience in performing this type of work.
- B. Where thermal butt fusion cannot be used, or when specifically called for on the plans, electro-fused couplings may be used. Fusion shall be in accordance with the written instructions of the fitting manufacturer.
- C. Flanged joints, mechanical joints, tapping saddles, and molded fittings shall be in accordance with AWWA C901, C906 or C909, ASTM D3350 and D3140, as applicable. Fusion and mechanical connections are allowed, chemical (solvents, epoxies, etc.) are not allowed.

2.03 DETECTION

- A. Direct buried HDPE pipe shall have 3" detectable metallic tape of the proper color placed directly above the pipe and 12" below finished grade or 6" detectable tape between 12" and 24" below finished grade.
- B. Direct buried or horizontal directional drilled HDPE pipe shall also have a tracer wire installed along the pipe alignment. The tracer wire to be used shall be a solid, 10 gauge, high strength, copper clad steel wire with a polyethylene jacket of appropriate color manufactured by Copperhead Industries or Manatee County approved equal.

2.04 IDENTIFICATION

- A. Pipe shall bear identification markings in accordance with AWWA C906.
- B. Pipe shall be color coded blue for water, purple (Pantone 522 C) for reclaimed water or green for pressure sewer using a solid pipe color or embedded colored stripes. Where stripes are used, there shall be a minimum of three stripes equally spaced.

PART 3 EXECUTION

3.01 INSTALLING POLYETHYLENE PRESSURE PIPE AND FITTINGS

All polyethylene pressure pipe shall be installed by direct bury, directional bore, or a method approved by the Owner/Engineer prior to construction. If directional bore is used, or if directed by the Owner/Engineer, the entire area of construction shall be surrounded by silt barriers during construction.

3.02 INSPECTION AND TESTING

All pipelines shall remain undisturbed for 24 hours to develop complete strength at all joints. All pipelines shall be subjected to a hydrostatic pressure and leak test per section 02617.

END OF SECTION

SECTION 02622 POLYVINYL CHLORIDE (PVC) PIPE AND FITTINGS (AWWA SPECIFICATIONS C-900 & C-905)

PART 1 GENERAL

1.01 SCOPE OF WORK

The Contractor shall furnish all labor, materials, equipment and incidentals required to install the plastic piping, fittings and appurtenances complete and ready for use as specified in the Contract Documents and these Standards.

1.02 DESCRIPTION OF SYSTEM

The Contractor shall install the piping in the locations as shown on the Drawings.

1.03 QUALIFICATIONS

All plastic pipe, fittings and appurtenances shall be furnished by a single manufacturer who is fully experienced, reputable, qualified and specializes in the manufacture of the items to be furnished. The pipe and fittings shall be designed, constructed and installed in accordance with the best practices and methods and shall comply with these Specifications.

1.04 SUBMITTALS

- A. The Contractor shall submit shop drawings to the Engineer including, but not limited to, dimensions and technical specifications for all piping.
- B. The Contractor shall submit to the Engineer, samples of all materials specified herein.
- C. The Contractor shall submit and shall comply with pipe manufacturer's recommendation for handling, storing and installing pipe and fittings.
- D. The Contractor shall submit pipe manufacturer's certification of compliance with these Specifications.

1.05 TOOLS

The Contractor shall supply special tools, solvents, lubricants, and caulking compounds required for proper installation.

PART 2 PRODUCTS

2.01 MATERIALS

- A. Pressure Class-Rated Polyvinyl Chloride (PVC) Pipe
 - 1. Pressure class-rated PVC pipe and accessories four to twelve inches (4"-12") in diameter, shall meet the requirements of AWWA Specification C-900 "Polyvinyl Chloride (PVC) Pressure Pipe". Pipe shall be Class 150, meeting requirements of Dimension Ratio (DR) 18 and shall have the dimension of ductile iron outside diameters. Each length of pipe shall be hydrotested to four (4) times its class

- pressure by the manufacturer in accordance with AWWA C-900.
2. PVC pipe 14" through 36" shall meet the requirements of AWWA Standard C-905, Polyvinyl Chloride (PVC) Water Transmission Pipe. Pipe 14" thru 24" for potable and reclaim water shall meet the requirements for dimension ratio (DR) 18. Each length of pipe shall be tested at twice the pressure rating (PR 235 psi) for a minimum dwell of 5 seconds in accordance with AWWA C-905. Fourteen inch (14") thru 36" PVC pipe for sewer force mains shall meet AWWA C-905 requirements for dimension ratio (DR) 21. Each length of pipe shall be tested at twice the pressure rating (PR 200 psi) for a minimum dwell of five seconds in accordance with AWWA C-905. Pipe shall be listed by Underwriters Laboratories. Provisions shall be made for expansion and contraction at each joint with an elastomeric ring, and shall have an integral thickened bell as part of each joint. PVC Class pipe shall be installed as recommended by the manufacturer. Pipe shall be furnished in nominal lengths of approximately 20 feet, unless otherwise directed by the Engineer. Pipe and accessories shall bear the NSF mark indicating pipe size, manufacturer's names, AWWA and/or ASTM Specification number, working pressure, and production code.
 3. Gaskets for 16" diameter and larger pipe used for potable water pipe shall be EPDM (Ethylene-Propylene Dine Monomer).
 4. PVC pipe 3" and less in diameter may be constructed using pipe conforming to ASTM D2241 with push-on joints. Pipe shall be 200 psi pipe-SDR 21 unless otherwise specified by the Engineer. This PVC pipe shall not be used for working pressures greater than 125 psi.
 5. Pipe shall be blue for potable water mains, green for sewage force mains and purple for reclaimed water mains. All potable water pipe shall be NSF certified and copies of lab certification shall be submitted to the Engineer.
 6. Where colored pipe is unavailable, white PVC color coded spiral wrapped pipe shall be installed.

B. Joints

1. The PVC joints for pipe shall be of the push-on type unless otherwise directed by the Engineer so that the pipe and fittings may be connected on the job without the use of solvent cement or any special equipment. The push-on joint shall be a single resilient gasket joint designed to be assembled by the positioning of a continuous, molded resilient ring gasket in an annular recess in the pipe or fitting socket and the forcing of the plain end of the entering pipe into the socket, thereby compressing the gasket radially to the pipe to form a positive seal. The gasket and annular recess shall be designed and shaped so that the gasket is locked in place against displacement as the joint is assembled. The resilient ring joint shall be designed for thermal expansion or contraction with a total temperature change of at least 75 degrees F in each joint per length of pipe. The bell shall consist of an integral wall section with a solid cross section elastomeric ring which shall meet requirements of ASTM F-477. The thickened bell section shall be designed to be at least as strong as the pipe wall. Lubricant furnished for lubricating joints shall be nontoxic, shall not support the growth of bacteria, shall have no deteriorating effects on the gasket or pipe material, and shall not impart color, taste, or odor to the water. Gaskets shall be suitable for use with potable water, reclaimed water or sanitary sewer as applicable.
2. Restrained joints shall be provided at all horizontal and vertical bends and fittings, at casings under roads and railroads and at other locations shown on the Contract Drawings. PVC joints for pipe shall be restrained by the following methods: thrust blocks, restraining glands such as Certa-Lok Restraining Joint Municipal Water

Pipe by the Certain Teed Corporation of Valley Forge, PA, or approved equal. All Grip, Star Grip by Star Products, MJR by Tyler Pipe, Tyler, Texas. Restrained joint PVC pipe shall be installed in strict accordance with the manufacturer's recommendation.

C. Fittings

1. All fittings for class-rated PVC pipe shall be ductile iron with mechanical joints and shall conform to the specifications for ductile iron fittings, unless otherwise directed. Class 200, C-900 PVC fittings are allowable for sewage force main applications up to and including 12" diameter only. DR ratio shall be the same as the pipe.
2. The manufacturer of the pipe shall supply all polyvinyl chloride accessories as well as any adapters and/or specials required to perform the work as shown on the Drawings and specified herein. Standard double bell couplings will not be accepted where the pipe will slip completely through the coupling.

PART 3 EXECUTION

3.01 INSTALLATION

The Contractor shall install the plastic pipe in strict accordance with the manufacturer's technical data and printed instructions. Direct bury pipe shall have 3" detectable metallic tape of the proper color placed directly above the pipe 12" below finished grade or 6" detectable tape between 12" and 24" below grade.

3.02 INSPECTION AND TESTING

All pipe lines shall remain undisturbed for 24 hours to develop complete strength at all joints. All pipe lines shall be subjected to a hydrostatic pressure test for two (2) hours at full working pressure, but not less than 180 psi for water/reclaimed (150 psi for force main). All visible leaks shall be repaired and retested for approval by the County. Prior to testing, the pipe lines shall be supported in a manner approved by the Engineer to prevent movement during tests.

END OF SECTION

SECTION 02640 VALVES AND APPURTENANCES

PART 1 GENERAL

1.01 SCOPE OF WORK

- A. The Contractor shall furnish all labor, materials, equipment and incidentals required and install complete and ready for operation all valves and appurtenances as shown on the Drawings and as specified herein.
- B. All valves and appurtenances shall be of the size shown on the Drawings and, to the extent possible, all equipment of the same type on the Project shall be from one manufacturer.
- C. All valves and appurtenances shall have the name of the manufacturer and the working pressure for which they are designed cast in raised letters upon some appropriate part of the body.
- D. All valves shall have a factory applied, fusion bonded epoxy coating on interior and exterior unless noted otherwise in the plans or this specification.
- E. The equipment shall include, but not be limited to, the following:
 - 1. Gate valves (Sec. 2.01)
 - 2. Pressure Sustaining and Check Valves (Sec. 2.02)
 - 3. Ball Valves for PVC Pipe (Sec. 2.03)
 - 4. Butterfly Valves (Sec. 2.04)
 - 5. Plug Valves (Sec. 2.05)
 - 6. Valve Actuators (Sec. 2.06)
 - 7. Air Release Valves (Sec. 2.07)
 - 8. Valves Boxes (Sec. 2.08)
 - 9. Corporation Cocks (Sec. 2.09)
 - 10. Flange Adapter Couplings (Sec. 2.10)
 - 11. Flexible Couplings (Sec. 2.11)
 - 12. Hose Bibs (Sec. 2.12)
 - 13. Slow Closing Air and Vacuum Valves (Sec. 2.13)
 - 14. Surge Anticipator Valve (Sec. 2.14)
 - 15. Check Valves (Sec. 2.15)
 - 16. Hydrants (Sec. 2.16)
 - 17. Restraining Clamps (Sec. 2.17)
 - 18. Tapping Sleeves and Tapping Valves (Sec. 2.18)
 - 19. Single Acting Altitude Valves (Sec. 2.19)

1.02 DESCRIPTION OF SYSTEMS

All of the equipment and materials specified herein are intended to be standard for use in controlling the flow of potable water, reclaim water, wastewater, etc., depending on the applications.

1.03 QUALIFICATIONS

All of the types of valves and appurtenances shall be products of well established reputable firms who are fully experienced and qualified in the manufacture of the particular equipment to be furnished. The equipment shall be designed, constructed and installed in accordance with the best practices and methods and shall comply with these Specifications as applicable. Valves shall be as covered under mechanical devices in Section 8 of ANSI/NSF Standard 61.

1.04 SUBMITTALS

- A. Submit to the Engineer within 30 days after execution of the contract a list of materials to be furnished, the names of the suppliers and the date of delivery of materials to the site.
- B. Complete shop drawings of all valves and appurtenances shall be submitted to the Engineer for approval in accordance with the Specifications.

1.05 TOOLS

Special tools, if required for normal operation and maintenance shall be supplied with the equipment.

PART 2 PRODUCTS

2.01 GATE VALVES

- A. All buried valves shall have cast or ductile iron three (3) piece valve bodies.
- B. Where indicated on the drawings or necessary due to locations, size, or inaccessibility, chain wheel operators shall be furnished with the valves. Such operators shall be designed with adequate strength for the valves with which they are supplied and provide for easy operation of the valve. Chains for valve operators shall be galvanized.
- C. Where required, gate valves shall be provided with a box cast in a concrete slab and a box cover. Length of box shall include slab thickness. Box cover opening shall be for valve stem and nut. Valve wrenches and extension stems shall be provided by the manufacturer to actuate the valves. The floor box and cover shall be equal to those manufactured by Rodney Hunt Machine Company, Orange, Massachusetts, Clow, DeZurik or approved equal.
- D. Gate valves with 3"-20" diameters shall be resilient seated, manufactured to meet or exceed the requirements of AWWA C509 or C515 and UL/FM of latest revision and in accordance with the following specifications. Valves shall have an unobstructed waterway equal to or greater than the full nominal diameter of the valve.
- E. Wrench nut shall be provided for operating the valve.
- F. Valves shall be suitable for an operating pressure of 200 psi and shall be tested in accordance with AWWA C509 or C515. Mueller, Kennedy, M&H, and Clow are acceptable valves.
- G. All bonnet bolts, nuts and studs shall be stainless steel.

2.02 PRESSURE SUSTAINING AND CHECK VALVE

- A. Pressure sustaining and check valve shall be pilot operated diaphragm actuated valve with cast iron body, bronze trim, and 125-pound flanged ends. The valve shall be hydraulically operated, diaphragm type globe valve. The main valve shall have a single removable seat and a resilient disc, of rectangular cross section, surrounded on three and a half sides. The stainless steel stem shall be fully guided at both ends by a bearing in the valve cover, and an integral bearing in the valve seat. It shall be sleeved at both ends with delrin. No external packing glands are permitted and there shall be no pistons operating the main valve or any controls. The valve shall be equipped with isolation cocks to service the pilot system while permitting flow if necessary. Main valve and all pilot controls shall be manufactured in the United States of America. Valve shall be single chamber type, with seat cut to 5 degrees taper.
- B. Valve shall maintain a minimum (adjustable) upstream pressure to a preset (adjustable) maximum. The pilot system shall consist of two direct acting, adjustable, spring loaded diaphragm valves.
- C. Valve shall be cast iron (ASTM A48) with main valve trim of brass (QQB-B-626) and bronze (ASTM B61). The pilot control valves shall be cast brass (ASTM B62) with 303 stainless steel trim. All ferrous surfaces inside and outside shall have a 2-part epoxy coating. Valve shall be similar in all respects to CLA-VAL Company, Model 692G-01ABKG, as manufactured by CLA-VAL Company, Winter Park, Florida, or similar pressure sustaining and check valve as manufactured by Golden Alderson; or approved equal.

2.03 BALL VALVES FOR PVC PIPE

- A. Ball valves for PVC pipe shall be of PVC Type 1 with union, socket, threaded or flanged ends as required. Ball valves shall be full port, full flow, all plastic construction, 150 psi rated with teflon seat seals and T-handles. PVC ball valves shall be as manufactured by Celanese Piping Systems, Inc., Wallace and Tiernan, Inc., Plastiline, Inc., or approved equal.
- B. All valves shall be mounted in such a position that valve position indicators are plainly visible when standing on the floor.

2.04 BUTTERFLY VALVES

- A. Butterfly valves shall conform to the AWWA Standard Specifications for Rubber Seated Butterfly Valves, Designated C504, except as hereinafter specified. Valves, except as specified hereinafter, shall be Class 150A or B, except that valves furnished downstream of the high service pumps shall be Class 250 and equal to those manufactured by Henry Pratt Company, DeZurik, Mueller, or approved equal. M&H/Kennedy/Clow are not generally approved equals. Ductile iron conforming to ASTM A536, Grade 65-45-12 shall be provided for all Class 250 valves. All valves shall be leak tested at 200 psi.
- B. The face-to-face dimensions of flanged end valves shall be in accordance with Table 1 of above mentioned AWWA Specification for short-body valve. Adequate two-way thrust bearings shall be provided. Flange drilling shall be in accordance with ANSI B16.1.
- C. Valve seats shall be an EPDM elastomer. Valve seats 24 inches and larger shall be field adjustable and replaceable without dismounting operator disc or shaft and without removing the valve from the line. All retaining segments and adjusting devices shall be of corrosion resistant material with stainless Nylock screws and be capable of the 1/8-inch

adjustment. Valves 20 inches and smaller shall have bonded or mechanically restrained seats as outlined in AWWA C 504. Where the EPDM seat is mounted on the valve body, the mating edge of the valve disc shall be 18-8 stainless steel or Nickel-Chrome, 80-20%. Where the EPDM seat is mounted on the valve disc, the valve body shall be fitted with an 18-8 stainless steel seat offset from the shaft, mechanically restrained and covering 360 degrees of the peripheral opening or seating surface.

- D. The valve body shall be constructed of ductile iron or close grain cast iron per ASTM A126, Class B with integrally cast hubs for shaft bearing housings of the through boss-type. Butterfly valves of the "wafer" or "spool" type will not be accepted.
- E. The valve shaft shall be turned, ground, and polished constructed of 18-8, ASTM A-276, Type 304 stainless steel and designed for both torsional and shearing stresses when the valve is operated under its greatest dynamic or seating torque. Shaft shall be of either a one piece unit extending full size through the valve disc and valve bearing or it may be of a stub shaft design. Shaft bearings shall be teflon or nylon, self-lubricated type.
- F. All valves shall be subject to hydrostatic and leakage tests at the point of manufacture. The hydrostatic test for Class 250 valves shall be performed with an internal hydrostatic pressure equal to 500 psi applied to the inside of the valve body of each valve for a period of five minutes. During the hydrostatic test, there shall be no leakage through the metal, the end joints or the valve shaft seal. The leakage test for the Class 250 valves shall be performed at a differential pressure of 230 psi and against both sides of the valve. No adjustment of the valve disc shall be necessary after pressure test for normal operation of valve. The Class 150 valves shall be tested in conformance with AWWA C-504.
- G. In general, the butterfly valve operators shall conform to the requirements of Section 3.8 of the AWWA Standard Specifications for Rubber Seated Butterfly Valves, Designation C504, insofar as applicable, and as herein specified.
- H. Gearing for the operators shall be totally enclosed in a gear case in accordance with paragraph 3.8.3 of the above mentioned AWWA Standard Specification.
- I. Operators shall be capable of seating and unseating the disc against the full design pressure of velocity, as specified for each class, into a dry system downstream and shall transmit a minimum torque to the valve. Operators shall be rigidly attached to the valve body.
- J. The manufacturer shall certify that the required tests on the various materials and on the completed valves have been satisfactory and that the valves conform with all requirements of this Specification and the AWWA standard.
- K. Where indicated on the Drawings, extension stems, floor stands, couplings, stem guides, and floor boxes as required shall be furnished and installed.

2.05 PLUG VALVES

- A. All plug valves shall be eccentric plug valves capable of sustaining 150 psi in either direction without leaking.

Exception: Single direction plug valves may be used if it is clearly demonstrated they will never be required to resist pressure in both directions either in service or during pipe line testing.

- B. Plug valves shall be tested in accordance with current AWWA Standard C-504-80 Section 5. Each valve shall be performance tested in accordance with paragraph 5.2 and shall be given a leakage test and hydrostatic test as described in paragraphs 5.3 and 5.4. Plug valves shall be Kennedy or Dezurik.
- C. Plug valves shall be of the non-lubricated eccentric type with resilient faced plugs and shall be furnished with end connections as shown on the Plans. Flanged valves shall be faced and drilled to the ANSI 150 lb. standard. Mechanical joint ends shall be to the AWWA Standard C111-72. Bell ends shall be to the AWWA Standard C100-55 Class B. Screwed ends shall be to the NPT standard.
- D. Plug valve bodies shall be of ASTM A126 Class B Semi-steel, 31,000 psi tensile strength minimum in compliance with AWWA Standard C507-73, Section 5.1 and AWWA Standard C504-70 Section 6.4. Port areas for valves 20-inches and smaller shall be 80 percent of full pipe area. Valves 24 inch and larger shall have a minimum port area between 80 and 100 percent of full nominal pipe area. All exposed nuts, bolts, springs, washers, etc. shall be zinc or cadmium plated. Resilient plug facings shall be of Hycar or Neoprene.
- E. Plug valves shall be furnished with permanently lubricated stainless steel or oil-impregnated bronze upper and lower plug stem bushings. These bearings shall comply with current AWWA Standards.

2.06 VALVE ACTUATORS

- A. General
 - 1. All valve actuators shall conform to Section 3.8 of the AWWA Standard Specification and shall be either manual or motor operated.
 - 2. Actuators shall be capable of seating and unseating the disc against the full design pressure and velocity, as specified for each class, into a dry system downstream, and shall transmit a minimum torque to the valve. Actuators shall be rigidly attached to the valve body.
 - 3. Butterfly valve actuators shall conform to the requirements of Section 3.8 of the AWWA Standard specifications for Rubber Seated Butterfly Valves, Designated C504, insofar as applicable and as herein specified.
- B. Manual Actuators
 - 1. Manual actuators shall have permanently lubricated, totally enclosed gearing with handwheel and gear ratio sized on the basis of actual line pressure and velocities. Actuators shall be equipped with handwheel, position indicator, and mechanical stop-limiting locking devices to prevent over travel of the disc in the open and closed positions. They shall turn counter-clockwise to open valves. Manual actuators shall be of the traveling nut, self-locking type and shall be designed to hold the valve in any intermediate position between fully open and fully closed without creeping or fluttering. Actuators shall be fully enclosed and designed to produce the specified torque with a maximum pull of 80 pounds on the handwheel or chainwheel. Actuator components shall withstand an input of 450 foot pounds for 30" and smaller and 300 foot pounds for larger than 30" size valves at extreme actuator positions without damage. Valves located above grade shall have handwheel and position indicator, and valves located below grade shall be equipped with a two inch (2") square AWWA operating nut located at ground level

and cast iron extension type valve box. Valve actuators shall conform to AWWA C504, latest revision.

C. Motor Actuators (Modulating)

1. The motor actuated valve controller shall include the motor, actuator unit gearing, limit switch gearing, limit switches, position transmitter which shall transmit a 4-20 mA DC signal, control power transformer, electronic controller which will position the valve based on a remote 4-20 milliamp signal, torque switches, bored and keywayed drive sleeve for non-rising stem valves, declutch lever and auxiliary handwheel as a self-contained unit.
2. The motor shall be specifically designed for valve actuator service using 480 volt, 60 Hertz, three phase power as shown, on the electrical drawings. The motor shall be sized to provide an output torque and shall be the totally enclosed, non-ventilated type. The power gearing shall consist of helical gears fabricated from heat treated alloy steel forming the first stage of reduction. The second reduction stage shall be a single stage worm gear. The worm shall be of alloy steel with carburized threads hardened and ground for high efficiency. The worm gear shall be of high tensile strength bronze with hobbled teeth. All power gearing shall be grease lubricated. Ball or roller bearings shall be used throughout. Preference will be given to units having a minimum number of gears and moving parts. Spur gear reduction shall be provided as required.
3. Limit switches and gearing shall be an integral part of the valve control. The limit switch gearing shall be made of bronze and shall be grease lubricated, intermittent type and totally enclosed to prevent dirt and foreign matter from entering the gear train. Limit switches shall be of the adjustable type capable of being adjusted to trip at any point between fully opened valve and fully closed valve.
4. The speed of the actuator shall be the responsibility of the system supplier with regard to hydraulic requirements and response compatibility with other components within the control loop. Each valve controller shall be provided with a minimum of two rotor type gear limit switches, one for opening and one for closing. The rotor type gear limit switch shall have two normally open and two normally closed contacts per rotor. Gear limit switches must be geared to the driving mechanism and in step at all times whether in motor or manual operation. Provision shall be made for two additional rotors as described above, each to have two normally open and two normally closed contacts. Each valve controller shall be equipped with a double torque switch. The torque switch shall be adjustable and will be responsive to load encountered in either direction of travel. It shall operate during the complete cycle without auxiliary relays or devices to protect the valve, should excessive load be met by obstructions in either direction of travel. The torque switch shall be provided with double-pole contacts.
5. A permanently mounted handwheel shall be provided for manual operation. The handwheel shall not rotate during electric operations, but must be responsive to manual operation at all times except when being electrically operated. The motor shall not rotate during hand operation nor shall a fused motor prevent manual operation. When in manual operating position, the unit will remain in this position until motor is energized at which time the valve operator will automatically return to electric operation and shall remain in motor position until handwheel operation is desired. This movement from motor operation to handwheel operation shall be accomplished by a positive declutching lever which will disengage the motor and motor gearing mechanically, but not electrically. Hand operation must be reasonably fast. It shall be impossible to place the unit in manual operation when the motor is running. The gear limit switches and torque switches shall be housed

in a single easily accessible compartment integral with the power compartment of the valve control. All wiring shall be accessible through this compartment. Stepping motor drives will not be acceptable.

6. The motor with its control module must be capable of continuously modulating over its entire range without interruption by heat protection devices. The system, including the operator and control module must be able to function, without override protection of any kind, down to zero dead zone.
7. All units shall have strip heaters in both the motor and limit switch compartments.
8. The actuator shall be equipped with open-stop-close push buttons, an auto-manual selector switch, and indicating lights, all mounted on the actuator or on a separate locally mounted power control station.
9. The electronics for the electric operator shall be protected against temporary submergence.
10. Actuators shall be Limitorque L120 with Modutronic Control System containing a position transmitter with a 4-20MA output signal or equal.

D. Motor Actuators (Open-Close)

1. The electronic motor-driven valve actuator shall include the motor, actuator gearing, limit switch gearing, limit switches, torque switches, fully machined drive sleeve, declutch lever, and auxiliary handwheel as a self-contained unit.
2. The motor shall be specifically designed for valve actuator service and shall be of high torque totally enclosed, nonventilated construction, with motor leads brought into the limit switch compartment without having external piping or conduit box.
 - (a) The motor shall be of sufficient size to open or close the valve against maximum differential pressure when voltage to motor terminals is 10% above or below nominal voltage.
 - (b) The motor shall be prelubricated and all bearings shall be of the anti-friction type.
3. The power gearing shall consist of helical gears fabricated from heat treated steel and worm gearing. The worm shall be carburized and hardened alloy steel with the threads ground after heat treating. The worm gear shall be of alloy bronze accurately cut with a hobbing machine. All power gearing shall be grease lubricated. Ball or roller bearings shall be used throughout.
4. Limit switches and gearing shall be an integral part of the valve actuator. The switches shall be of the adjustable rotor type capable of being adjusted to trip at any point between fully opened valve and fully closed valve. Each valve controller shall be provided with a minimum of two rotor type gear limit switches, one for opening and one for closing (influent valves require additional contacts to allow stopping at an intermediate position). The rotor type gear limit switch shall have two normally open and two normally closed contacts per rotor. Additional switches shall be provided if shown on the control and/or instrumentation diagrams. Limit switches shall be geared to the driving mechanism and in step at all times whether in motor or manual operation. Each valve actuator shall be equipped with a double torque switch. The torque switch shall be adjustable and will be responsive to load encountered in either direction of travel. It shall operate during the complete cycle without auxiliary relays or devices to protect the valve should excessive load be met by obstructions in either direction of travel. Travel and thrusts shall be independent of wear in valve disc or seat rings.
5. A permanently mounted handwheel shall be provided for manual operation. The handwheel shall not rotate during electric operation except when being electrically operated. The motor shall not rotate during hand operation, nor shall a fused motor prevent manual operation. When in manual operating position, the unit will

remain in this position until motor is energized at which time the valve actuator will automatically return to electric operation and shall remain in motor position until handwheel operation is desired. Movement from motor operation to handwheel operation shall be accomplished by a positive declutching lever which will disengage the motor and motor gearing mechanically, but not electrically. Hand operation must be reasonably fast. It shall be impossible to place the unit in manual operation when the motor is running.

6. Valve actuators shall be equipped with an integral reversing controller and three phase overload relays, Open-Stop-Close push buttons, local-remote-manual selector switch, control circuit transformer, three-phase thermal overload relays and two pilot lights in a NEMA 4X enclosure. In addition to the above, a close coupled air circuit breaker or disconnect switch shall be mounted and wired to the valve input power terminals for the purpose of disconnecting all underground phase conductors.
7. The valve actuator shall be capable of being controlled locally or remotely via a selector switch integral with the actuator. In addition, an auxiliary dry contact shall be provided for remote position feedback.
8. Valve A.C. motors shall be designed for operation on a 480 volt, 3-phase service. Valve control circuit shall operate from a fuse protected 120 volt power supply.
9. Motor operators shall be as manufactured by Limitorque Corporation, Type L120 or approved equal.

2.07

AIR RELEASE VALVES

The air release valves for use in water or force mains shall be installed as shown on the Drawings. The valves shall have a cast iron body cover and baffle, stainless steel float, bronze water diffuser, Buna-N or Viton seat, and stainless steel trim. The fittings shall be threaded. The air release valves shall be Model 200A or 400A as manufactured by APCO Valve and Primer Corporation, Schaumburg, Illinois; or approved equal.

2.08

VALVE BOXES

- A. Buried valves shall have cast-iron three piece valve boxes or HDPE adjustable valve boxes. Cast iron valve boxes shall be provided with suitable heavy bonnets and shall extend to such elevation at or slightly above the finished grade surface as directed by the Engineer. The barrel shall be two-piece, screw type, having a 5-1/4 inch shaft. The upper section shall have a flange at the bottom with sufficient bearing area to prevent settling and shall be complete with cast iron covers. Covers shall have WATER, SEWER, or RECLAIM, as applicable, cast into the top.
- B. All valves shall have actuating nuts extended to within four (4) feet of the top of the valve box. All valve extensions will have a centering guide plate two (2) inches maximum below the actuating nut. The valve extension shall be fastened to the existing nut with a set screw. Valve boxes shall be provided with a concrete base and a valve nameplate engraved with lettering 1/8-inch deep as shown on the Drawings.
- C. HDPE adjustable valve boxes shall be one complete assembled unit composed of the valve box and extension stem. All moving parts of the extension stem shall be enclosed in a housing to prevent contact with the soil. Valve box assembly shall be adjustable to accommodate variable trench depths.
- D. The entire assembly shall be made of heavy wall high density polyethylene. All exterior components shall be joined with stainless steel screws. The valve box top section shall be

adaptable to fit inside a valve box upper section.

- E. The stem assembly shall be of a telescoping design that allows for variable adjustment length. The stem material shall be of plated steel square tubing. The stem assembly shall have a built-in device that keeps the stem assembly from disengaging at its fully extended length. The extension stem must be torque tested to 1000 foot pounds. Covers shall have WATER, SEWER or RECLAIMED clearly and permanently impressed into the top surface.

2.09 CORPORATION COCKS

Corporation cocks for connections to cast-iron, ductile iron or steel piping shall be all brass or bronze suitable for 180 psi operating pressure and similar to Mueller Co. H-10046 or approved equal by Clow Corp., and shall be of sizes required and/or noted on the Drawings.

2.10 FLANGE ADAPTER COUPLINGS

Flange adapter couplings shall be of the size and pressure rating required for each installation and shall be suitable for use on either cast iron or ductile iron pipe. They shall be similar or approved equal to Dresser Company, Style 128. All couplings shall have a sufficient number of factory installed anchor studs to meet or exceed a minimum test pressure rating of 230 psi minimum.

2.11 FLEXIBLE COUPLINGS

Flexible couplings shall be either the split type or the sleeve type as shown on the Drawings.

1. Split type coupling shall be used with all interior piping and with exterior pipings noted on the Drawings. The couplings shall be mechanical type for radius groove piping. The couplings shall mechanically engage and lock grooved pipe ends in a positive couple and allow for angular deflection and contracting and expansion.
2. Couplings shall consist of malleable iron, ASTM Specification A47, Grade 32510 housing clamps in two or more parts, a single chlorinated butyl composition sealing gasket with a "C" shaped cross-section and internal sealing lips projecting diagonally inward, and two or more oval track head type bolts with hexagonal heavy nuts conforming to ASTM Specification A 183 and A194 to assemble the housing clamps. Bolts and nuts shall be hot dipped galvanized after fabrication.
3. Victaulic type couplings and fittings may be used in lieu of flanged joints. Pipes shall be radius grooved as specified for use with the Victaulic couplings. Flanged adapter connections at fittings, valves, and equipment shall be Victaulic Vic Flange Style 741, equal by Gustin-Bacon Group, Division of Certain-Teed Products, Kansas City, Kansas, or approved equal.
4. Sleeve type couplings shall be used with all buried piping. The couplings shall be of steel and shall be Dresser Style 38 or 40, as shown on the Drawings, or equal. The coupling shall be provided with hot dipped galvanized steel bolts and nuts unless indicated otherwise.
5. All couplings shall be furnished with the pipe stop removed.
6. Couplings shall be provided with gaskets of a composition suitable for exposure to the liquid within the pipe.
7. If the Contractor decides to use victaulic couplings in lieu of flanged joints, he shall be responsible for supplying supports for the joints.

2.12 HOSE BIBS

Hose bibs shall be 3/4" or 1" brass, polished chromium plated brass, with vacuum breaker as noted on the drawings.

2.13 SLOW CLOSING AIR AND VACUUM VALVES

- A. The Contractor shall furnish and install slow closing air and vacuum valves as shown on the Drawings which shall have two (2) independent valves bolted together. The air and vacuum valve shall have all stainless steel float, guided on both ends with stainless shafts. The air and vacuum valve seat shall be Buna-N to insure drop tight closure. The Buna-N seat shall be fastened to the cover stainless shoulder screws in a manner to prevent distortion of the seat. The float shall be guided at both ends with stainless steel bushings.
- B. The valve cover shall have a male lip designed to fit into the body register for accurate alignment of the float into the Buna-N seat. The valve cover shall have 250-pound class flanged outlet connection.
- C. The surge check valve shall be bolted to the inlet of the air and vacuum valve and consist of a body, seat, disc, and compression spring. A surge check unit shall operate on the interphase between the kinetic energy and relative velocity flows of air and water, so that after air passes through, and water rushes into the surge check, the disc starts to close, reducing the rate of flow of water into the air valve by means of throttling orifices in the disc to prevent water hammer in the air valves. The surge check orifices must be adjustable type for regulation in the field to suit operating conditions. Valve shall be rated for 250-pound class working pressure.
- D. The complete slow closing air and vacuum valve with air release valve shall have been flow tested in the field, substantiated with test data to show reduction of surge pressure in the valve. Flow test data shall be submitted with initial shop drawings for approval.
- E. Valve exterior to be painted Red Oxide, Phenolic TT-P86, Primer or approved equal for high resistance to corrosion.
- F. All materials of construction shall be certified in writing to conform to ASTM specifications as follows:

Air Valve Cover, Body, and Surge Check Body	Cast Iron	ASTM A48, Class 30
Float	Stainless Steel	ASTM A240
Surge Check Seat and Disc	Stainless Steel	ASTM A582
Air Valve Seat	Buna-N	
Spring	Stainless Steel	T302

2.14 SURGE ANTICIPATOR VALVES

- A. Surge anticipator valves shall be furnished for the pumping systems as shown on the Drawings. The valve shall be hydraulically operated, pilot controlled, and diaphragm or piston actuated. The main valve shall be cast iron conforming to ASTM A48 with bronze trim conforming to ASTM B61 and flanged ends conforming to ANSI B161.1. The main valve shall be globe type with a single removable seat and a resilient disc.
- B. The diaphragm actuated valve shall have a stainless steel stem guided at both ends by a bearing in the valve cover and an integral bearing surface in the seat. No external packing glands shall be permitted. The valve shall be fully serviceable without removing it from the line. The pilot system shall be of noncorrosive construction and provided with isolation cocks.
- C. The piston actuated valve shall operate on the differential piston principle. The valve piston shall be guided on its outside diameter. The valve shall be able to operate in any position and shall be fully serviceable without removing it from the line. The pilot system shall be provided with isolation cocks, and be of noncorrosive materials of construction.
- D. The valve shall be designed specifically to minimize the effects of water hammer, resulting from power failure at the pumping station, or from normal stopping and starting of pumping operators. The valve shall open hydraulically on a down surge, or low pressure wave created when the pump stops, remain open during the low pressure cycle in order to be open when the high pressure wave returns. The high pressure pilot shall be adjustable over a 20 to 200 psi range and the low pressure pilot shall be adjustable over a 15 to 75 psi range. The valve shall be the 250 Class.

2.15 CHECK VALVES

- A. Check valves for cast iron and ductile iron pipe lines shall be swing type and shall meet the material requirements of AWWA Specification C508. The valves shall be iron body, bronze mounted, single disc, 175 psi working water pressure and nonshock. Valves shall be as manufactured by Mueller, Clow, Kennedy, or M&H. Valves 8" and larger shall be air cushioned to reduce valve slam.
- B. When there is no flow through the line, the disc shall hang lightly against its seat in practically a vertical position. When open, the disc shall swing clear of the waterway.
- C. Check valves shall have bronze seat and body rings, extended bronze hinge pins and bronze nuts on the bolts of bolted covers. The interior and exterior of the valve body shall have a factory applied fusion bonded or 10 mil 2 part epoxy coating (Protecto 401 or approved equal).
- D. Valves shall be so constructed that disc and body seat may easily be removed and replaced without removing the valve from the line. Valves shall be fitted with an extended hinge arm with outside lever and weight. Weights provided and approved by the Engineer shall be installed.

2.16 HYDRANTS

Hydrants shall be AVK Series 2780 (nostalgic style with stainless steel bolts), American Darling B-84-B or Mueller Super Centurion 250, or approved equal and shall conform to the "Standard Specification for Fire Hydrants for Ordinary Water Works Service", AWWA C502, and UL/FM certified, and shall in addition meet the specific requirements and exceptions which follow:

1. Hydrants shall be according to manufacturer's standard pattern and of standard size, and shall have one 4-1/2" steamer nozzle and two 2-1/2" hose nozzles.
2. Hydrant inlet connections shall have mechanical joints for 6" ductile-iron pipe.
3. Hydrant valve opening shall have an area at least equal to that area of a 5-1/4" minimum diameter circle and be obstructed only by the valve rod. Each hydrant shall be able to deliver 500 gallons minimum through its two 2-1/2" hose nozzles when opened together with a loss of not more than 2 psi in the hydrants.
4. Each hydrant shall be designed for installation in a trench that will provide 5-ft. cover.
5. Hydrants shall be hydrostatically tested as specified in AWWA C502.
6. Hydrants shall be rated at 200 psi.
7. All nozzle threads shall be American National Standard.
8. Each nozzle cap shall be provided with a Buna N rubber washer.
9. Hydrants shall be so arranged that the direction of outlets may be turned 90 degrees without interference with the drip mechanism and without the mechanism obstructing the discharge from any outlet.
10. Hydrants must be capable of being extended without removing any operating parts.
11. Hydrants shall have bronze-to-bronze seatings as per AWWA C502-85.
12. Hydrant main valve closure shall be of the compression type opening against the pressure and closing with the pressure. The resilient seat material shall meet the requirements of AWWA C-509 and shall preferably be EPDM Elastomer.
13. Internal and below ground iron parts (bonnet, nozzle section and base) shall have a fusion bonded epoxy coating per AWWA C550. Aboveground external hydrant parts (cap, bonnet and nozzle section) shall be either epoxy coated together with a UV resistant polyester coating or have two shop coats of paint per AWWA C502. The lower stand pipe or barrel shall be protected with asphaltic coatings per AWWA C502.
14. Exterior nuts, bolts and washer shall be stainless steel. Bronze nuts may be used below grade.
15. All internal operating parts shall be removable without requiring excavation.

2.17 RESTRAINING CLAMPS

Restraining clamp assemblies as detailed in the drawings for use at hydrant connections to water mains, or at fittings where shown on the Drawings, shall be as manufactured by American Cast Iron Pipe, Star Pipe Products, U.S. Pipe; or approved equal.

2.18 TAPPING SLEEVES AND GATE VALVES

- A. Tapping valves shall meet the requirement of AWWA C500. The valves shall be flanged, shall be mechanical joint outlet with nonrising stem, designed for vertical burial and shall open left or counterclockwise. Stuffing boxes shall be the "O-ring" type. Operating nut shall be AWWA Standard 2" square for valves 2" and up. The valves shall be provided with an overload seat to permit the use of full size cutters. Gaskets shall cover the entire area of flange surfaces and shall be supplied with EPDM wedges up to 30" diameter.
- B. Tapping sleeves and saddles shall seal to the pipe by the use of a confined "O" ring gasket, and shall be able to withstand a pressure test of 180 psi for one hour with no leakage in accordance with AWWA C110, latest edition. A stainless steel 3/4" NPT test plug shall be provided for pressure testing. All bolts joining the two halves shall be stainless steel and shall be included with the sleeve or saddle. Sleeves and saddles shall

be protected from corrosion by being fusion applied epoxy coated, or be made of 18-8 Type 304 stainless steel. Saddle straps shall be 18-8 Type 304 stainless steel.

2.19 SINGLE ACTING ALTITUDE VALVES

A. Function

1. The altitude control valve shall be of the single acting type, closing off tightly when the water reaches the maximum predetermined level in the tank to prevent overflow; and opening to permit replenishing of the tank supply when the water level drops approximately 6" to 12" below the maximum level.
2. A hand operated valve in the power water line to the top of the piston shall permit adjustment of the speed of valve closing. The tank water level control shall be by means of a diaphragm operated, spring loaded, three way pilot which directs power water to or from the top of the main valve piston. The three way pilot shall be of bronze construction. The diaphragm surface exposed to the tank head shall be not less than 57 sq. inches. It shall be possible to adjust the spring above the diaphragm for water level control approximately 20% above or below the factory setting.

B. Description

1. The main valve shall operate on the differential piston principle such that the area on the underside of the piston is no less than the pipe area on the upper surface of the piston is of a greater area than the underside of the piston.
2. The valve piston shall be guided on its outside diameter by long stroke stationary Vee ports which shall be downstream of the seating surface to minimize the consequences of throttling. Throttling shall be done by the valve Vee ports and not the valve seating surfaces.
3. The valve shall be capable of operating in any position and shall incorporate only one flanged cover at the valve top from which all internal parts shall be accessible. There shall be no stems, stem guides, or spokes within the waterway. There shall be no springs to assist the valve operation.

C. Construction

1. The valve body shall be of cast iron ASTM A-126 with flanges conforming to the latest ANSI Standards. The valve shall be extra heavy construction throughout. The valve interior trim shall be bronze B-62 as well as the main valve operation.
2. The valve seals shall be easily renewable while no diaphragm shall be permitted within the main valve body.
3. All controls and piping shall be of non-corrosive construction.
4. A visual valve position indicator shall be provided for observing the valve piston position at any time.

D. Figure Number

The valves shall be the 20" Globe type (Fig. 3200-D) as manufactured by GA Industries of Mars, Pennsylvania, or approved equal.

PART 3 EXECUTION

3.01 INSTALLATION

- A. All valves and appurtenances shall be installed in the location shown, true to alignment and rigidly supported. Any damage occurring to the above items before they are installed shall be repaired to the satisfaction of the Engineer.
- B. After installation, all valves and appurtenances shall be tested at least two hours at the working pressure corresponding to the class of pipe, unless a different test pressure is specified. If any joint proves to be defective, it shall be repaired to the satisfaction of the Engineer.
- C. Install all floor boxes, brackets, extension rods, guides, the various types of operators and appurtenances as shown on the Drawings that are in masonry floors or walls, and install concrete inserts for hangers and supports as soon as forms are erected and before concrete is poured. Before setting these items, the Contractor shall check all plans and figures which have a direct bearing on their location and he shall be responsible for the proper location of these valves and appurtenances during the construction of the structures.
- D. Pipe for use with flexible couplings shall have plain ends as specified in the respective pipe sections.
- E. Flanged joints shall be made with high strength, low alloy Corten bolts, nuts and washers. Mechanical joints shall be made with mild corrosion resistant alloy steel bolts and nuts. All exposed bolts shall be painted the same color as the pipe. All buried bolts and nuts shall be heavily coated with two (2) coats of bituminous paint comparable to Inertol No. 66 Special Heavy.
- F. Prior to assembly of split couplings, the grooves as well as other parts shall be thoroughly cleaned. The ends of the pipes and outside of the gaskets shall be moderately coated with petroleum jelly, cup grease, soft soap or graphite paste, and the gasket shall be slipped over one pipe end. After the other pipe has been brought to the correct position, the gasket shall be centered properly over the pipe ends with the lips against the pipes. The housing sections then shall be placed. After the bolts have been inserted, the nuts shall be tightened until the housing sections are firmly in contact, metal-to-metal, without excessive bolt tension.
- G. Prior to the installation of sleeve-type couplings, the pipe ends shall be cleaned thoroughly for a distance of 8". Soapy water may be used as a gasket lubricant. A follower and gasket, in that order, shall be slipped over each pipe to a distance of about 6" from the end.
- H. Valve boxes with concrete bases shall be installed as shown on the Drawings. Mechanical joints shall be made in the standard manner. Valve stems shall be vertical in all cases. Place cast iron box over each stem with base bearing on compacted fill and the top flush with final grade. Boxes shall have sufficient bracing to maintain alignment during backfilling. Knobs on cover shall be parallel to pipe. Remove any sand or undesirable fill from valve box.

3.02 HYDRANTS

- A. Hydrants shall be set at the locations designated by the Engineer and/or as shown on the Drawings and shall be bedded on a firm foundation. A drainage pit on crushed stone as shown on the Drawings shall be filled with gravel or crushed stone and satisfactorily

compacted. During backfilling, additional gravel or crushed stone shall be brought up around and 6" over the drain port. Each hydrant shall be set in true vertical alignment and shall be properly braced. Concrete thrust blocks shall be placed between the back of the hydrant inlet and undisturbed soil at the end of the trench. Minimum bearing area shall be as shown on the plans. Felt paper shall be placed around the hydrant elbow prior to placing concrete. CARE MUST BE TAKEN TO INSURE THAT CONCRETE DOES NOT PLUG THE DRAIN PORTS. Concrete used for backing shall be as specified herein.

- B. When installations are made under pressure, the flow of water through the existing main shall be maintained at all times. The diameter of the tap shall be a minimum of 2" less than the inside diameter of the branch line.
- C. The entire operation shall be conducted by workmen thoroughly experienced in the installation of tapping sleeves and valves, and under the supervision of qualified personnel furnished by the manufacturer. The tapping machine shall be furnished by the Contractor if tap is larger than 12" in diameter.
- D. The Contractor shall determine the locations of the existing main to be tapped to confirm the fact that the proposed position for the tapping sleeve will be satisfactory and no interference will be encountered such as the occurrence of existing utilities or of a joint or fitting at the location proposed for the connection. No tap will be made closer than 30" from a pipe joint.
- E. Tapping valves shall be set in vertical position and be supplied with a 2" square operating nut for valves 2" and larger. The valve shall be provided with an oversized seat to permit the use of full sized cutters.
- F. Tapping sleeves and valves with boxes shall be set vertically or horizontally as indicated on the Drawings and shall be squarely centered on the main to be tapped. Adequate support shall be provided under the sleeve and valve during the tapping operation. Sleeves shall be no closer than 30" from water main joints. Thrust blocks shall be provided behind all tapping sleeves. Proper tamping of supporting earth around and under the valve and sleeve is mandatory. After completing the tap, the valve shall be flushed to ensure that the valve seat is clean.

3.03 SHOP PAINTING

Ferrous surfaces of valves and appurtenances shall receive a coating of rust-inhibitive primer. All pipe connection openings shall be capped to prevent the entry of foreign matter prior to installation.

3.04 FIELD PAINTING

All metal valves and appurtenances specified herein and exposed to view shall be painted.

3.05 INSPECTION AND TESTING

Completed pipe shall be subjected to hydrostatic pressure test for two hours at 180 psi. All leaks shall be repaired and lines retested as approved by the Engineer. Prior to testing, the pipelines shall be supported in an approved manner to prevent movement during tests.

END OF SECTION

SECTION 02999 MISCELLANEOUS WORK AND CLEANUP

PART 1 GENERAL

1.01 SCOPE OF WORK

- A. This Section includes items and operations which are not specified in detail as separate items, but may be sufficiently described as to the kind and extent of work involved. The Contractor shall furnish all labor, materials, equipment and incidentals necessary to complete all work under this Section.
- B. The work of this Section may include, but is not limited to the following:
1. Restoration of roads, sidewalks, driveways, curbing and gutters, fences, guardrails, lawns, shrubbery and any other existing items damaged or destroyed.
 2. Crossing utilities.
 3. Relocation of existing water, reclaim water, or sewer lines less than four inches diameter, water and sanitary sewer services, low pressure gas lines, telephone lines, electric lines, cable TV lines as shown on the Contract Drawings.
 4. Restoring easements (servitudes) and rights-of-way.
 5. Clean up.
 6. Incidental work (project photographs, testing, shop drawings, traffic control, record drawings, etc.).
 7. Excavation and Embankment - As defined in the Florida Department of Transportation Standard Specifications for Road and Bridge Construction (1991 Edition or latest revision).
 8. Stormwater and erosion control devices.

1.02 SUBMITTAL OF LUMP SUM BREAKDOWN

Contractor shall submit to the Owner/Engineer, a breakdown of the lump sum bid for Miscellaneous Work and Cleanup Item in the Proposal within 10 days after date of Notice to Proceed.

1.03 WORK SPECIFIED UNDER OTHER SECTIONS

All work shall be completed in a workmanlike manner by competent workmen in full compliance with all applicable sections of the Contract Documents.

PART 2 PRODUCTS

2.01 MATERIALS

Materials required for this Section shall equal or exceed materials that are to be restored. The Contractor may remove and replace or reuse existing materials with the exception of paving.

PART 3 EXECUTION

3.01 RESTORING OF SIDEWALKS, ROADS, CURBING, FENCES AND GUARDRAILS

- A. The Contractor shall protect existing sidewalks & curbing. If necessary, sidewalks & curbing shall be removed from joint to joint and replaced after backfilling. Curbing damaged during construction because of the Contractor's negligence or convenience, shall be replaced with sidewalks & curbing of equal quality and dimension at no cost to the Owner.
- B. At the locations necessary for the Contractor to remove, store and replace existing fences and guardrails during construction, the sections removed shall be only at the direction of the Engineer. If any section of fence is damaged due to the Contractor's negligence, it shall be replaced at no cost to the Owner with fencing equal to or better than that damaged and the work shall be satisfactory to the Engineer.
- C. Guardrails in the vicinity of the work shall be protected from damage by the Contractor. Damaged guardrails shall be replaced in a condition equal to those existing
- D. Road crossings shall be restored in accordance with the Contract Documents and current FDOT Standards. Compensation for road restoration shall be included under the Road Restoration Bid Item if specified or under Miscellaneous Cleanup if it is not specified.

3.02 CROSSING UTILITIES

This item shall include any extra work required in crossing culverts, water courses, drains, water mains and other utilities, including all sheeting and bracing, extra excavation and backfill, or any other work required or implied for the proposed crossing, whether or not shown on the Drawings.

3.03 RELOCATIONS OF EXISTING GAS LINES, TELEPHONE LINES, ELECTRIC LINES AND CABLE TV LINES

The Contractor shall notify the proper utility involved when relocation of these utility lines is required. The Contractor shall coordinate all relocation work by the utility so that construction shall not be hindered.

3.04 RESTORING THE EASEMENTS AND RIGHTS-OF-WAY

The Contractor shall be responsible for all damage to private property due to his operations. He shall protect from injury all walls, fences, cultivated shrubbery, pavement, underground facilities, including water, sewer and reclaimed water lines and services, or other utilities which may be encountered along the easement. If removal and replacement is required, it shall be done in a workmanlike manner, at his expense, so that the replacement are equivalent to that which existed prior to construction.

3.05 STORMWATER AND EROSION CONTROL DEVICES

The Contractor shall be responsible for, provide, and install all stormwater and erosion control devices necessary to insure satisfactory compliance with the Florida Department of Environmental Protection Stormwater, Erosion, and Sedimentation Control Inspector's Manual.

END OF SECTION

DIVISION 3 CONCRETE

SECTION 03200 CONCRETE REINFORCEMENT

PART 1 GENERAL

1.01 WORK INCLUDED

- A. Reinforcing steel bars and welded steel wire fabric for cast-in-place concrete, complete with tie wire.
- B. Support chairs, bolsters, bar supports and spacers, for reinforcing.

1.02 QUALITY ASSURANCE

Perform concrete reinforcing work in accordance with ACI 318 unless specified otherwise in this Section.

1.03 REFERENCES

- A. ACI 318 - Building Code Requirements for Reinforced Concrete.
- B. ASTM A185 - Welded Steel Wire Fabric for Concrete Reinforcement.
- C. ASTM A615 - Deformed and Plain Billet Steel Bars for Concrete Reinforcement.
- D. CRSI 63 - Recommended practice for placing reinforcing bars.
- E. CRSI 65 - Recommended practice for placing bar supports, specifications and nomenclature.
- F. ACI 315 - American Concrete Institute - Manual of Standard Practice.

1.04 SHOP DRAWINGS

- A. Submit shop drawings in accordance with Contract Documents.
- B. Indicate bar sizes, spacings, locations and quantities of reinforcing steel and wire fabric, bending and cutting schedules and supporting and spacing devices.
- C. Manufacturer's Literature: Manufacturer's specifications and installation instructions for splice devices.

PART 2 PRODUCTS

2.01 REINFORCING

- A. Reinforcing steel: Grade 60, Minimum Yield Strength 60,000 psi, deformed billet steel bars, ASTM A615; plain finish.
- B. Welded steel wire fabric: Deformed wire, ASTM A497; smooth wire ASTM A185 in flat

sheets; plain finish.

2.02 ACCESSORY MATERIALS

- A. Tie wire: Minimum 16 gauge annealed type, or patented system accepted by Engineer.
- B. Chairs, bolsters, bar supports, spacers: Sized and shaped for strength and support of reinforcing during construction conditions.
- C. Special chairs, bolsters, bar supports, spacers (where adjacent to architectural concrete surfaces): Stainless steel type sized and shaped as required.

2.03 FABRICATION

- A. Fabricate concrete reinforcing in accordance with ACI 315.
- B. Locate reinforcing splices, not indicated on Drawings, at points of minimum stress. Location of splices shall be reviewed by Engineer.
- C. Where indicated, weld reinforcing bars in accordance with AWS D12.1.

PART 3 EXECUTION

3.01 PLACEMENT

- A. Reinforcing shall be supported and secured against displacement. Do not deviate from true alignment.
- B. Before placing concrete, ensure reinforcing is clean, free of loose scale, dirt, or other foreign coatings which would reduce bond to concrete.

3.02 QUALITY ASSURANCE

- A. Acceptable Manufacturers: Regularly engaged in manufacture of steel bar and welded wire fabric reinforcing.
- B. Installer Qualifications: Three years experience in installation of steel bar and welded wire fabric reinforcing.
- C. Allowable Tolerances:
 - 1. Fabrication:
 - a. Sheared length: ± 1 in.
 - b. Depth of truss bars: $+0, -1/2$ in.
 - c. Stirrups, ties and spirals: $\pm 1/4$ in.
 - d. All other bends: ± 1 in.
 - 2. Placement:
 - a. Concrete cover to form surfaces: $\pm 1/4$ in.
 - b. Minimum spacing between bars: 1 in.
 - c. Top bars in slabs and beams:
 - (1) Members 8 in. deep or less: $\pm 1/4$ in.
 - (2) Members more than 8 in.: $\pm 1/2$ in.
 - d. Crosswise of members: Spaced evenly within 2 in. of stated separation.

- e. Lengthwise of members: Plus or minus 2 in.
- 3. Maximum bar movement to avoid interference with other reinforcing steel, conduits, or embedded items: 1 bar diameter.

3.04 PRODUCT DELIVERY, STORAGE AND HANDLING

- A. Deliver reinforcement to project site in bundles marked with metal tags indicating bar size and length.
- B. Handle and store materials to prevent contamination.

3.05 INSTALLATION

- A. Placement:
 - 1. Bar Supports: CRSI 65.
 - 2. Reinforcing Bars: CRSI 63.
- B. Steel Adjustment:
 - 1. Move within allowable tolerances to avoid interference with other reinforcing steel, conduits, or embedded items.
 - 2. Do not move bars beyond allowable tolerances without concurrence of Engineer.
 - 3. Do not heat, bend, or cut bars without concurrence of Engineer.
- C. Splices:
 - 1. Lap splices: Tie securely with wire to prevent displacement of splices during placement of concrete.
 - 2. Splice devices: Install in accordance with manufacturer's written instructions.
 - 3. Do not splice bars without concurrency of Engineer, except at locations shown on Drawings.
- D. Wire Fabric:
 - 1. Install in longest practicable length.
 - 2. Lap adjoining pieces one full mesh minimum, and lay splices with 16 gauge wire.
 - 3. Do not make end laps midway between supporting beams, or directly over beams of continuous structures.
 - 4. Offset end laps in adjacent widths to prevent continuous laps.
- E. Cleaning: Remove dirt, grease, oil, loose mill scale, excessive rust, and foreign matter that will reduce bond with concrete.
- F. Protection During Concreting: Keep reinforcing steel in proper position during concrete placement.

END OF SECTION

SECTION 03300 CAST-IN-PLACE CONCRETE

PART 1 GENERAL

1.01 WORK INCLUDED

Poured-in-place concrete slabs, thrust blocks, pile caps and pipe support cradles.

1.02 QUALITY ASSURANCE

Perform cast-in-place concrete work in accordance with ACI 318, unless specified otherwise in this Section.

1.03 TESTING LABORATORY SERVICES

- A. Inspection and testing will be performed by the testing laboratory currently under contract to Manatee County in accordance with the Contract Documents.
- B. Provide free access to work and cooperate with appointed firm.
- C. Submit proposed mix design of each class of concrete to inspection and testing firm for review prior to commencement of work.
- D. Tests of cement and aggregates may be performed to ensure conformance with requirements stated herein.
- E. Three concrete test cylinders will be taken for every 100 cu. yds. or part thereof of each class of concrete placed each day. Smaller pours shall have cylinders taken as directed by the Engineer.
- F. One slump test will be taken for each set of test cylinders taken.

1.04 REFERENCES

- A. ASTM C33 - Concrete Aggregates
- B. ASTM C150 - Portland Cement
- C. ACI 318 - Building Code Requirements for Reinforced Concrete
- D. ASTM C260 - Air Entraining Admixtures for Concrete
- E. ASTM C94 - Ready-Mixed Concrete
- F. ACI 304 - Recommended Practice for Measuring, Mixing, Transporting and Placing Concrete
- G. ACI 305 - Recommended Practice for Hot Weather Concreting

PART 2 PRODUCTS

2.01 CONCRETE MATERIALS

- A. Cement: Moderate-Type II, High early strength-Type III, Portland type, ASTM C150.
- B. Fine and Coarse Aggregates: ASTM C33.
- C. Water: Clean and free from injurious amounts of oil, alkali, organic matter, or other deleterious material.

2.02 ADMIXTURES

- A. Air Entrainment: ASTM C260.
- B. Chemical: ASTM C494 Type A - water reducing admixture.

2.03 ACCEPTABLE MANUFACTURERS

Acceptable Products:

- 1. Pozzolith
- 2. WRDA

2.04 ACCESSORIES

Non-shrink grout: Premixed compound consisting of non-metallic aggregate, cement, water reducing and plasticizing agents; capable of developing minimum compressive strength of 2400 psi in 2 days and 7000 psi in 28 days.

2.05 CONCRETE MIXES

- A. Mix concrete in accordance with ASTM C94.
- B. Provide concrete of following strength:
 - 1. Required concrete strengths as determined by 28 day cylinders shall be as shown on the Drawings, but shall not be less than 3000 psi.
 - 2. Select proportions for normal weight concrete in accordance with ACI 301 3.8 Method 1, Method 2, or Method 3. Add air entraining agent to concrete to entrain air as indicated in ACI 301 Table 3.4.1.
 - 3. All mixes shall be in accordance with FDOT Specifications.
- C. Use set-retarding admixtures during hot weather only when accepted by Engineer.
- D. Add air entraining agent to concrete mix for concrete work exposed to exterior.

2.06 FORMS

- A. Forms shall be used for all concrete masonry, including footings. Form shall be so constructed and placed that the resulting concrete will be of the shape, lines, dimensions, appearance and to the elevations indicated on the Drawings.
- B. Forms shall be made of wood, metal, or other approved material. Wood forms shall be constructed of sound lumber or plywood of suitable dimensions, free from knotholes and loose knots; where used for expose surfaces, boards shall be dressed and matched.

Plywood shall be sanded smooth and fitted with tight joints between panels. Metal forms shall be of an approved type for the class of work involved and of the thickness and design required for rigid construction.

- C. Edges of all form panels in contact with concrete shall be flush within 1/32-inch and forms for plane surfaces shall be such that the concrete will be plane within 1/16-inch in four feet. Forms shall be tight to prevent the passage of mortar and water and grout.
- D. Forms for walls shall have removable panels at the bottom for cleaning, inspection and scrubbing-in of bonding paste. Forms for walls of considerable height shall be arranged with tremies and hoppers for placing concrete in a manner that will prevent segregation and accumulation of hardened concrete on the forms or reinforcement above the fresh concrete.
- E. Molding or bevels shall be placed to produce a 3/4-inch chamfer on all exposed projecting corners, unless otherwise shown on the Drawings. Similar chamfer strips shall be provided at horizontal and vertical extremities of all wall placements to produce "clean" separation between successive placements as called for on the Plans.
- F. Forms shall be sufficiently rigid to withstand vibration, to prevent displacement or sagging between supports and constructed so the concrete will not be damaged by their removal. The Contractor shall be entirely responsible for their adequacy.
- G. Forms, including new pre-oiled forms, shall be oiled before reinforcement is placed, with an approved nonstaining oil or liquid form coating having a non-paraffin base.
- H. Before form material is re-used, all surfaces in contact with concrete shall be thoroughly cleaned, all damaged places repaired, all projecting nails withdrawn, all protrusions smoothed and in the case of wood forms pre-oiled.
- I. Form ties encased in concrete shall be designed so that after removal of the projecting part, no metal shall be within 1-inch of the face of the concrete. That part of the tie to be removed shall be at least 1/2-inch diameter or be provided with a wood or metal cone at least 1/2-inch in diameter and 1-inch long. Form ties in concrete exposed to view shall be the cone-washer type equal to the Richmond "Tyscru". Throughbolts or common wire shall not be used for form ties.

PART 3 EXECUTION

3.01 PLACING CONCRETE

- A. Place concrete in accordance with ACI 304.
- B. Notify Engineer minimum 24 hours prior to commencement of concreting operations.
- C. Verify anchors, seats, plates and other items to be cast into concrete are placed, held securely and will not cause hardship in placing concrete. Rectify same and proceed with work.
- D. Maintain records of poured concrete items. Record date, location of pour, quantity, air temperature and test samples taken.
- E. Ensure reinforcement, inserts, embedded parts, formed expansion and contraction joints

are not disturbed during concrete placement.

- F. Prepare previously placed concrete by cleaning with steel brush and applying bonding agent. Apply bonding agent in accordance with manufacturer's recommendations.
- G. Pour concrete continuously between predetermined construction and control joints. Do not break or interrupt successive pours such that cold joints occur.
- H. In locations where new concrete is dowelled to existing work, drill holes in existing concrete, insert steel dowels and pack solidly with non-shrink grout.
- I. Excessive honeycomb or embedded debris in concrete is not acceptable. Notify Engineer upon discovery.
- J. Conform to ACI 305 when concreting during hot weather.

3.02 SCREEDING

Screed surfaces level, maintaining flatness within a maximum deviation of 1/8" in 10 feet.

3.03 PATCHING

Allow Engineer to inspect concrete surfaces immediately upon removal of forms. Patch imperfections as directed. All patching procedures shall be submitted to and approved by the Engineer prior to use.

3.04 DEFECTIVE CONCRETE

- A. Modify or replace concrete not conforming to required lines, details and elevations.
- B. Repair or replace concrete not properly placed resulting in excessive honeycomb and other defects. Do not patch, fill, touch-up, repair, or replace exposed architectural concrete except upon express direction of Engineer for each individual area.

3.05 CONCRETE FINISHING

Provide concrete surfaces to be left exposed, columns, beams and joists with smooth rubbed finish.

3.06 CURING AND PROTECTION

Beginning immediately after placement, protect concrete from premature drying, excessively hot or cold temperatures and mechanical injury. Maintain concrete with minimal moisture loss at relatively constant temperature for a period of 7 days or until concrete strengths reaches 75% of the 28 day design strength.

Protection against moisture loss may be obtained with spray on curing compounds or plastic sheets. Protection against heat or cold may be obtained with insulated curing blankets or forms.

3.07 CONCRETE DRIVEWAY RESTORATION

Concrete driveways shall be restored with 6 inches of 3,000 psi concrete with W2.5 X

W2.5, 6X6 wire mesh. Place ½ inch expansion joint between back of curb and new concrete. Area beneath restoration shall be mechanically tamped prior to placing concrete.

3.08

CONCRETE SIDEWALK RESTORATION

Concrete sidewalks across driveways shall be restored with 6 inches of 3,000 psi concrete with W2.5 X W2.5, 6X6 wire mesh. Place ½ inch expansion joint between back of curb and new concrete. Area beneath restoration shall be mechanically tamped prior to placing concrete.

Concrete sidewalks outside of driveways shall be restored with 4 inches of 3,000 psi concrete per FDOT Design Standards, Sections 522 & 310

END OF SECTION

SECTION 05550 AIR RELEASE ENCLOSURE

PART 1 GENERAL

1.01 SCOPE OF WORK

The Contractor shall furnish all labor, materials, equipment and incidentals required to install the above ground air release enclosure as listed in the specifications and as shown on the Drawings.

1.02 RELATED WORK

The contractor shall be responsible for any related work necessary for the proper installation of enclosure. This shall include, but is not limited to, any required bypass pumping, any required earthwork and any required concrete work.

1.03 SUBMITTALS

- A. Submit to the Engineer shop drawings and schedules of all enclosure systems and appurtenances required. Submit design data and specification data sheets listing all parameters used in the enclosure system design.
- B. Submit to the Engineer the name of the enclosure supplier and a list of materials to be furnished.

1.04 REFERENCE STANDARDS

- A. American Water Works Association (AWWA).
- B. American Society for Testing and Materials (ASTM).
- C. Where reference is made to the above standard, the revision in effect at the time of bid opening shall apply.

1.05 QUALITY ASSURANCE

The enclosure manufacturer shall be a company specializing in the manufacture of such enclosures with at least five (5) years of successful field experience and being lab certified as meeting A.S.S.E 1060 requirements.

1.06 DELIVERY, STORAGE AND HANDLING

- A. Care shall be taken in shipping, handling and placing to avoid damaging. Any material damaged in shipment shall be replaced as directed by the Engineer.
- B. Any material showing deterioration, or which has been exposed to any other adverse storage condition that may have caused damage, even though no such damage can be seen, shall be marked as rejected and removed at once from the work.

PART 2 PRODUCTS

2.01 GENERAL

All enclosures shall comply with the standard detail for shape and size and shall include a 24"W x 30"H access door with a hasp for a padlock. The enclosure shall be securely attached to a concrete base with anchor brackets installed on the interior of the enclosure, through the flange base of the enclosure itself or through a stainless steel anchor hinge.

2.02 ALUMINUM ENCLOSURE

- A. The roof, walls and access panels shall be constructed of mill finish aluminum, ASTM B209, solid sheet construction, with a wall thickness of one eighth inch.
- B. All structural members shall be aluminum. No wood or "particle board" shall be allowed in assembly.
- C. Multi-sectional enclosures shall fit together with overlapping "tongue and groove" joints and be secured internally with mechanical fasteners.
- D. All assembly fasteners shall be stainless steel or aluminum.

2.03 STAINLESS STEEL ENCLOSURE

- A. The roof, walls and access panels shall be constructed stainless steel, type 316, solid sheet construction, with a wall thickness of one eighth inch.
- B. All structural members shall be stainless steel. No wood or "particle board" shall be allowed in assembly.
- C. Multi-sectional enclosures shall fit together with overlapping "tongue and groove" joints and be secured internally with mechanical fasteners.
- C. All assembly fasteners shall be stainless steel.

FIBERGLASS ENCLOSURE

- A. Enclosure shall be a 1 piece molded fiberglass enclosure with a base flange for mounting to the concrete slab and a full recessed door opening with a lip. Enclosure shall be by Allied Molded Products, or approved equal. Color shall be as directed by the Engineer.
- B. Full length piano style hinge, door latch, padlock hasp and all bolts and other hardware shall be of stainless steel.

PART 3 EXECUTION

3.01 INSTALLATION

Enclosure shall be assembled and mounted plumb, level and square on the concrete pad according to the manufacturer's instructions and the contract drawings.

END OF SECTION

WATER LINE IMPROVEMENTS
WASHINGTON GARDENS
PLAN & PROFILE STA. 32+00 TO 38+00

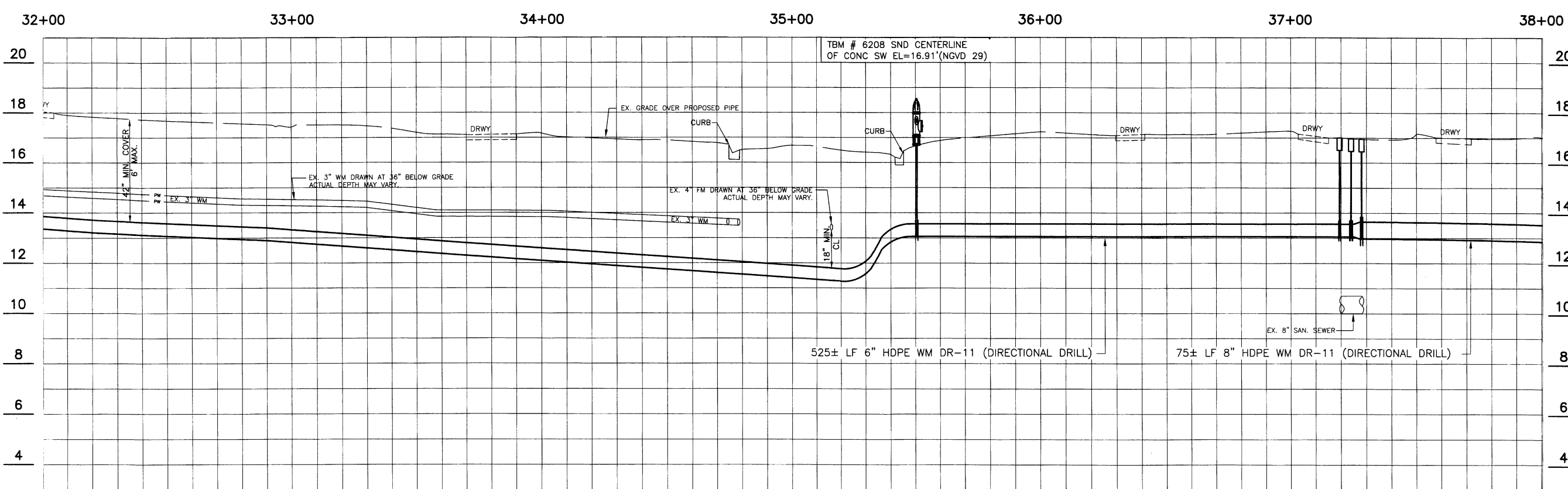
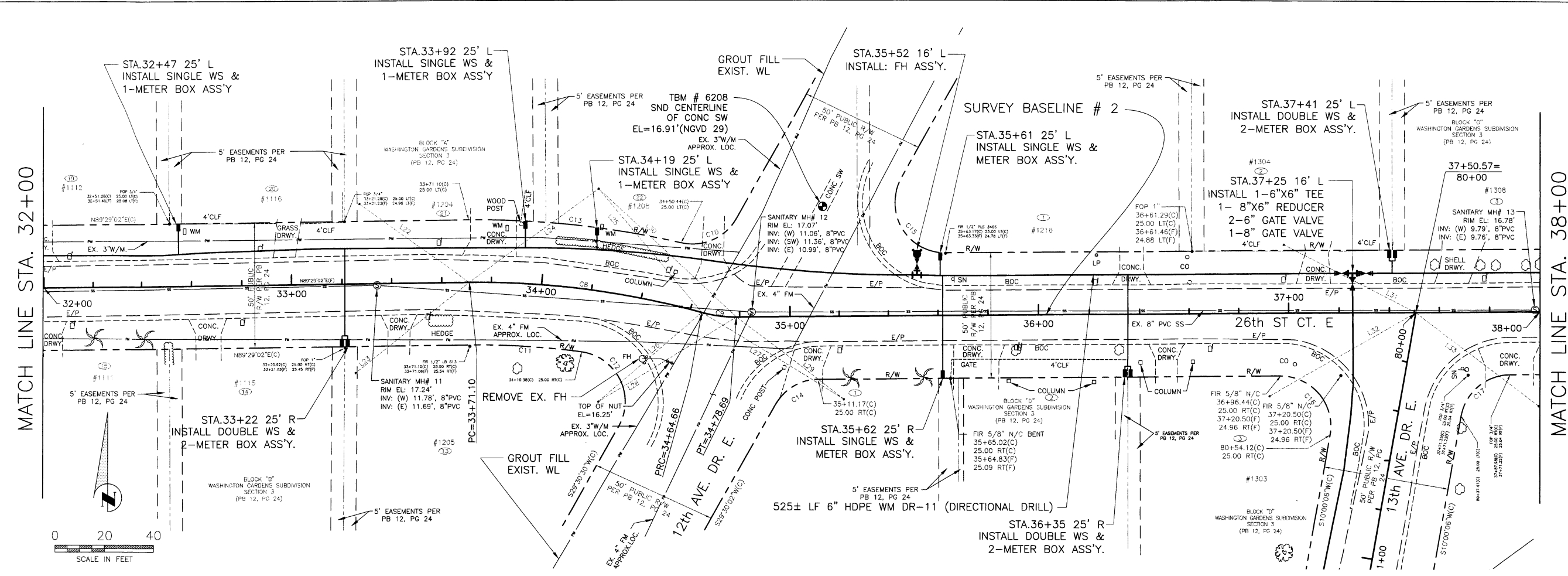

NO.	REVISION DESCRIPTION	BY	DATE

PROJECT #	404-6076770															
SURVEY #	1512 & 1432															
SEC./TWN./RGE	12/34S/17E															
SCALE	1"=20'															
<table border="1"> <thead> <tr> <th> </th> <th>BY</th> <th>DATE</th> </tr> </thead> <tbody> <tr> <td>SURVEYED</td> <td>FDC</td> <td>DEC. 2009</td> </tr> <tr> <td>DESIGNED</td> <td>JS/BLR</td> <td>FEB. 2010</td> </tr> <tr> <td>DRAWN</td> <td>BLR</td> <td>FEB. 2010</td> </tr> <tr> <td>CHECKED</td> <td>JS</td> <td>MAY 2010</td> </tr> </tbody> </table>			BY	DATE	SURVEYED	FDC	DEC. 2009	DESIGNED	JS/BLR	FEB. 2010	DRAWN	BLR	FEB. 2010	CHECKED	JS	MAY 2010
	BY	DATE														
SURVEYED	FDC	DEC. 2009														
DESIGNED	JS/BLR	FEB. 2010														
DRAWN	BLR	FEB. 2010														
CHECKED	JS	MAY 2010														

JAMES STOCKWELL, P.E.
FLORIDA P.E. # 67198

6/15/10
J. Stockwell
Signature & Date

SHEET 8 OF 20

COPYRIGHT 2010 MANATEE COUNTY GOVERNMENT P.A. WATER LINE IMPROVEMENTS - WASHINGTON GARDENS SUBDIVISION SECTION 3 (PB 12, PG 24)



**WATER LINE IMPROVEMENTS
WASHINGTON GARDENS
PLAN & PROFILE STA. 38+00 to 42+00**

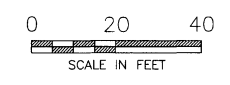
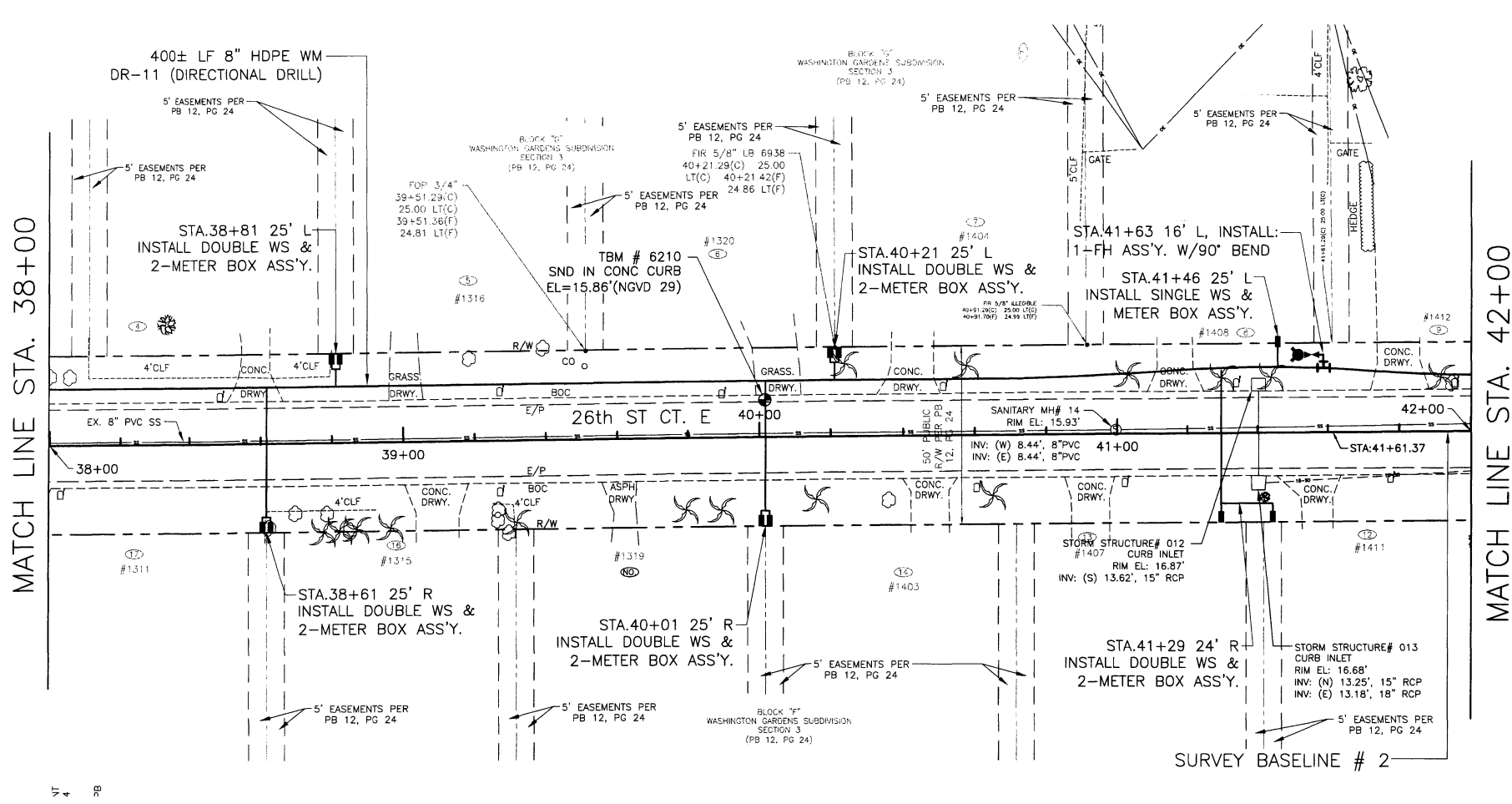

NOTES:

1. Where proposed waterline is within 10ft of Sanitary Sewer or 6ft of Forcemain (horizontal distance) all joints must be restrained in accordance with Manatee County Utility Standards or approved equal.
2. Contractor shall connect all existing water services from existing meter boxes to proposed new meter boxes unless where noted otherwise. Where existing meter boxes are on private property, the Contractor shall install (min. 1" dia. or larger where required by plumbing code) PVC schd 40 service line from the existing meter box to the new meter box along a route agreed to by the Project Representative and the property owner. The County requires all work on private property to be installed by a plumber licensed in Manatee County. All work shall meet the Florida Building Code and Manatee County Utility Standards and Codes. typ.

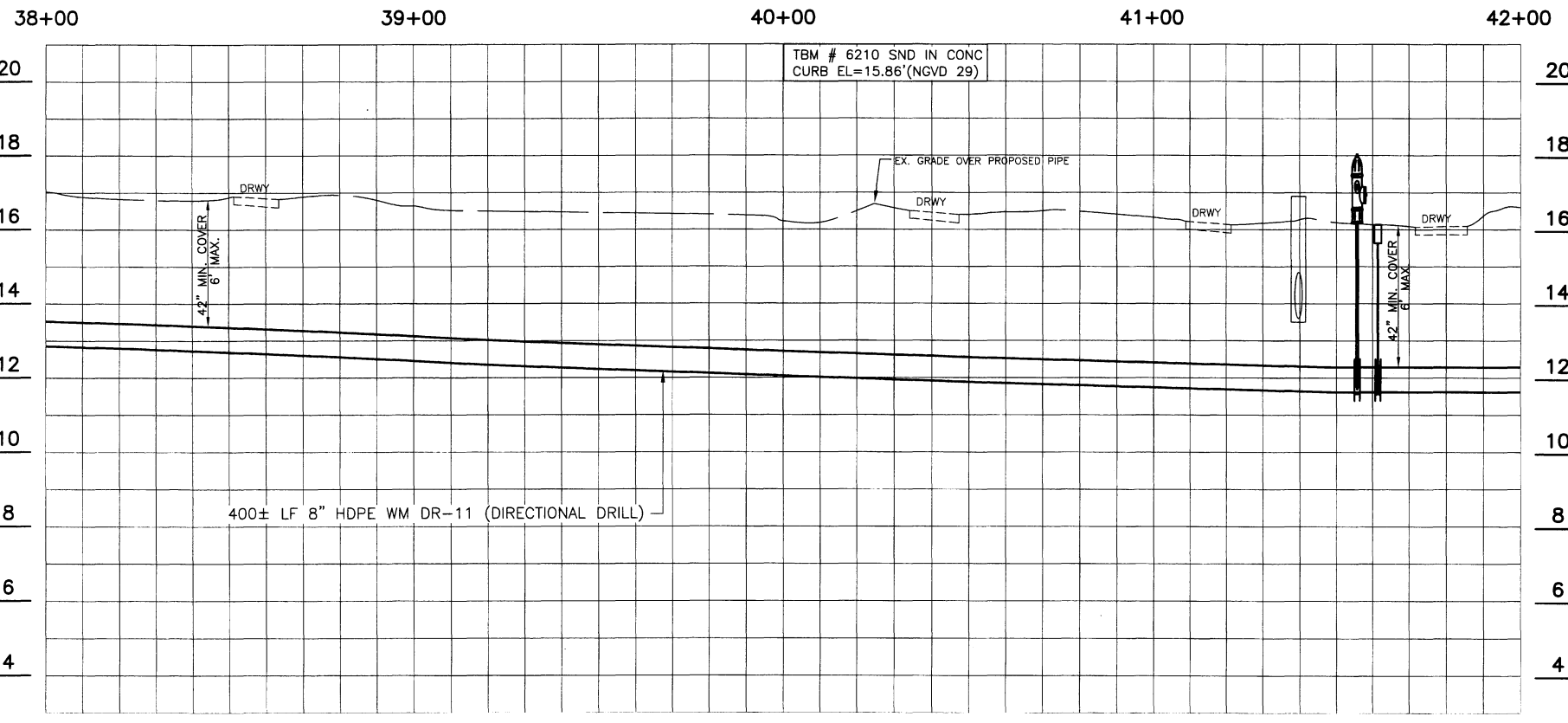

COPYRIGHT 2010 MANATEE COUNTY GOVERNMENT BY WFLA-TV, INC. DATE: 10/18/2010 10:18 AM Bruce Robertson, I.T., ARCH. Full sized D (36.00 x 24.00 inches)

NO.	REVISION DESCRIPTION	BY	DATE

PROJECT #	404-6076770
SURVEY #	1512 & 1432
SEC./TWN./RGE	12/34S/17E
SCALE	1"=20'
BY	DATE
SURVEYED	FDC DEC. 2009
DESIGNED	JS/BLR FEB. 2010
DRAWN	BLR FEB. 2010
CHECKED	JS MAY 2010

JAMES STOCKWELL, P.E.
FLORIDA P.E. # 67198
James Stockwell
Signature & Date
SHEET 9 OF 20

WATER LINE IMPROVEMENTS
WASHINGTON GARDENS
PLAN & PROFILE STA. 42+00 TO 44+11.84

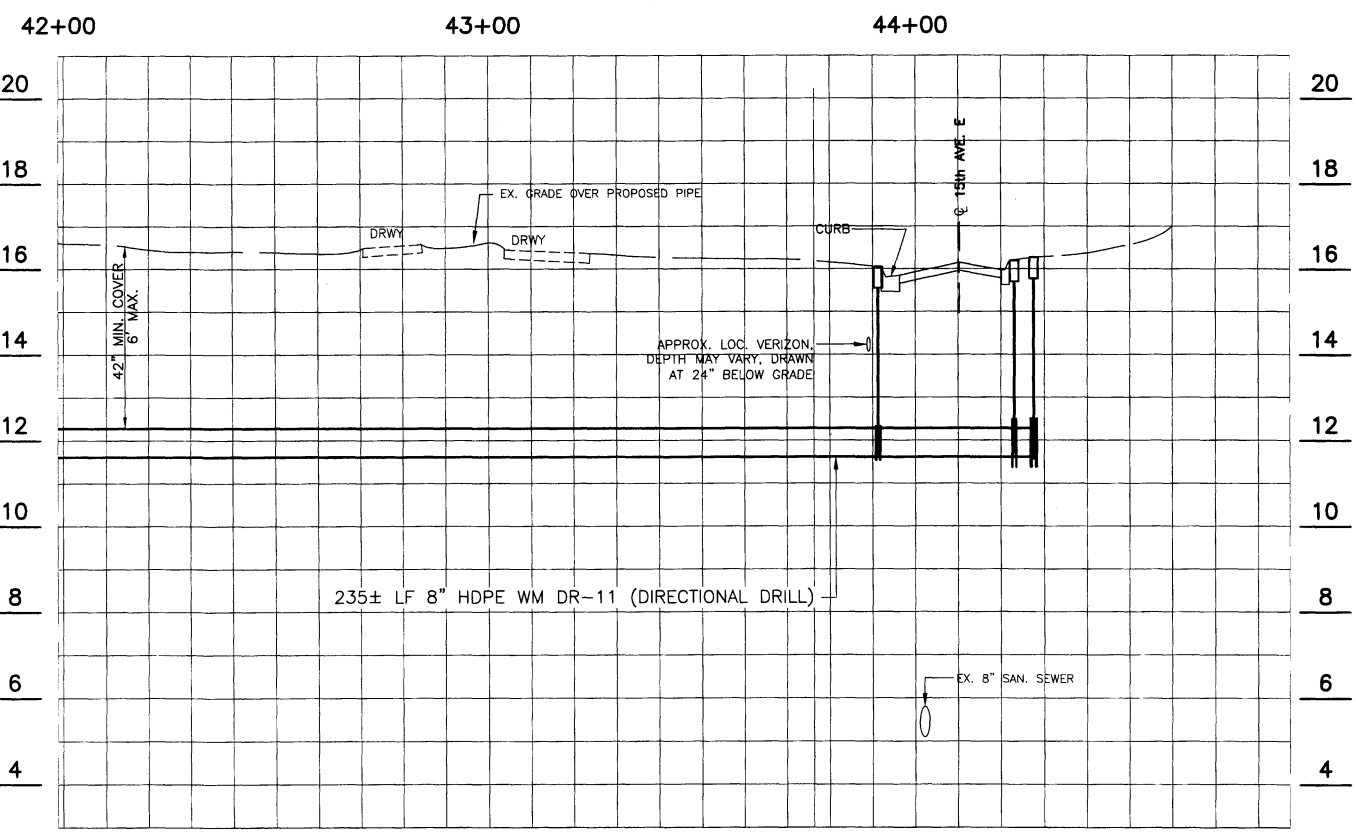
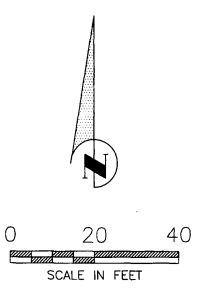
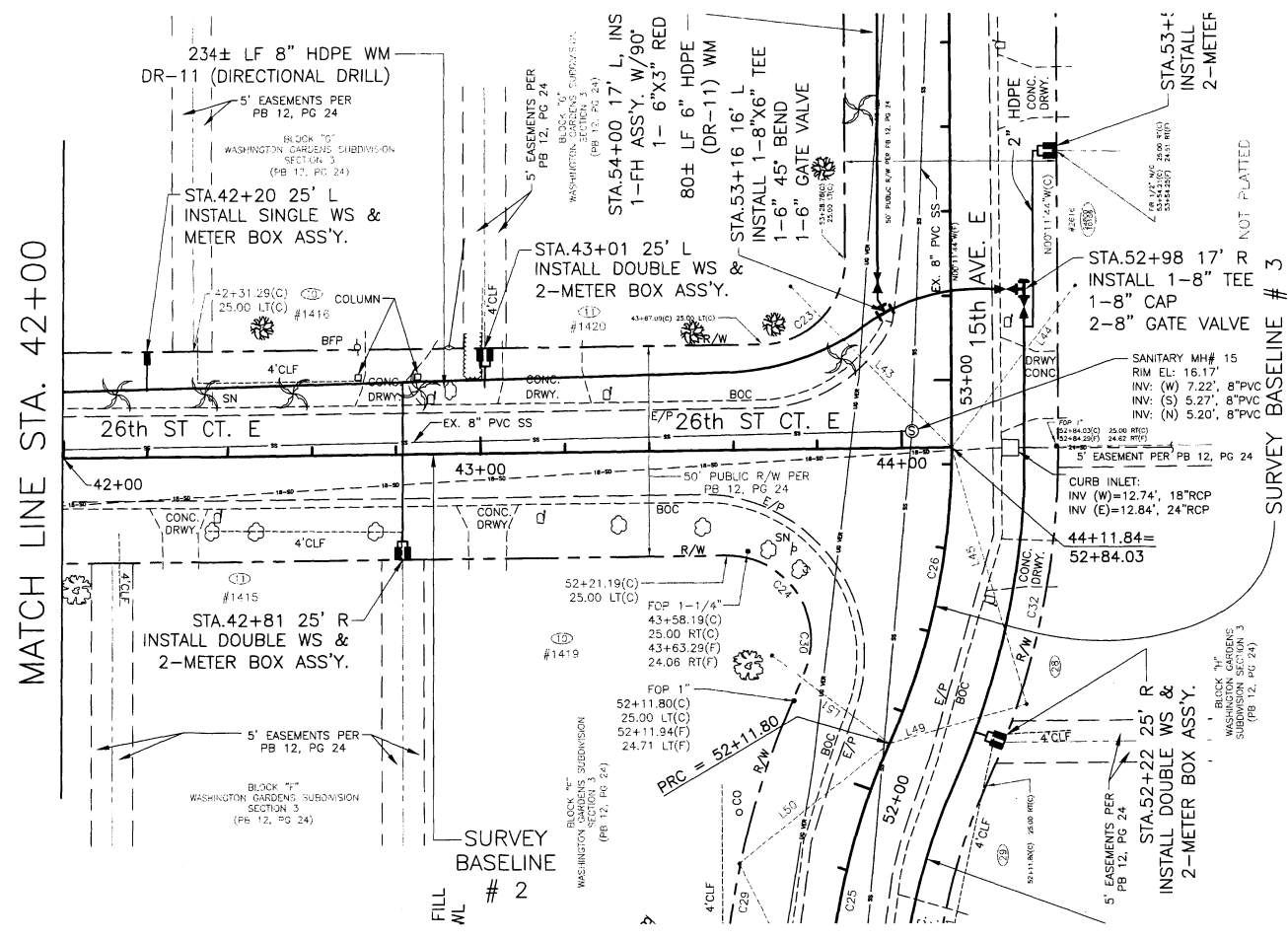

SANITARY SEWER

- SANITARY M/H
RIM EL=17.57'
INV (E)=10.55', 8"PVC
INV (S)=8.82', 8"PVC
INV (W)=8.74', 8"PVC
- SANITARY M/H
RIM EL=17.39'
INV (N)=11.18', 8"PVC
INV (E)=11.18', 8"PVC
INV (W)=11.08', 8"PVC
- SANITARY M/H
RIM EL=17.49'
INV (E)=12.10', 8"PVC
INV (W)=12.06', 8"PVC
- SANITARY M/H
RIM EL=17.34'
INV (W)=13.49', 8"PVC
- SANITARY M/H
RIM EL=18.22'
INV (N)=12.24', 8"PVC
INV (E)=12.45', 8"PVC
INV (S)=12.36', 8"PVC
- SANITARY M/H
RIM EL=18.15'
INV (E)=13.48', 8"PVC
INV (W)=13.40', 8"PVC
- SANITARY M/H
RIM EL=18.55'
INV (W)=14.23', 8"PVC
- SANITARY M/H
RIM EL=18.77'
INV (NE)=17.06', 12"x18"ERCP
INV (SW)=17.05', 12"x18"ERCP
- SANITARY M/H
RIM EL=19.05'
INV (E)=14.86', 8"PVC
- SANITARY M/H
RIM EL=18.25'
INV (N)=16.59', 12"RCP
INV (S)=16.53', 12"RCP
INV (W)=16.87', 12"RCP
- SANITARY M/H
RIM EL=17.24'
INV (E)=11.69', 8"PVC
INV (W)=11.78', 8"PVC
- SANITARY M/H
RIM EL=17.07'
INV (E)=10.99', 8"PVC
INV (S)=11.36', 4"PVC
INV (W)=11.06', 8"PVC
- SANITARY M/H
RIM EL=16.78'
INV (E)=9.76', 8"PVC
INV (W)=9.79', 8"PVC
- SANITARY M/H
RIM EL=15.93'
INV (E)=8.44', 8"PVC
INV (W)=8.44', 8"PVC
- SANITARY M/H
RIM EL=16.17'
INV (N)=5.20', 8"PVC
INV (S)=5.27', 8"PVC
INV (W)=7.22', 8"PVC
- SANITARY M/H
RIM EL=17.72'
INV (NE)=4.66', 8"PVC
INV (E)=4.55', 8"PVC
INV (S)=4.59', 8"PVC
- SANITARY M/H
RIM EL=15.03'
INV (N)=6.48', 8"PVC
INV (E)=6.57', 8"PVC
- SANITARY M/H
RIM EL=17.31'
INV (S)=7.78', 8"PVC
INV (W)=7.74', 8"PVC
- SANITARY AIR RELEASE VALVE
RIM EL=17.20'
TOP OF VALVE EL=14.42'
- SANITARY M/H
RIM EL=16.36'
INV (SE)=12.56', 8"PVC
INV (W)=12.57', 8"PVC
(VISIBLE FLOW SE)

STORM DRAIN

- DRAINAGE M/H
RIM EL=18.02'
INV (N)=13.23', 42"RCP
INV (E)=13.22', 42"RCP
- DRAINAGE M/H
RIM EL=18.31'
INV (W)=13.07', 42"RCP
INV (S)=13.06', 42"RCP
- GI GRATE EL=16.92'
INV (N)=13.23', 29"x46"ERCP
INV (S)=13.26', 29"x46"ERCP
INV (W)=15.03', 14"x23"ERCP
- GI GRATE EL=16.39'
INV (S)=13.29', 29"x46"ERCP
INV (W)=15.05', 12"x12"OPENING
- GI GRATE EL=16.58'
INV (W)=14.81', 12"RCP
INV (E)=14.65', 12"x12"OPENING
INV (S)=14.69', 12"RCP
INV (W)=14.72', 12"RCP
- GI GRATE EL=17.98'
INV (W)=16.10', 12"RCP
INV (S)=15.96', 12"RCP
INV (W)=16.92', 12"x8"OPENING
- GI GRATE EL=17.97'
INV (N)=16.13', 12"RCP
INV (S)=16.18', 12"RCP
INV (W)=16.96', 12"x8"OPENING
- GI GRATE EL=18.77'
INV (NE)=17.06', 12"x18"ERCP
INV (SW)=17.05', 12"x18"ERCP
- GI GRATE EL=18.85'
INV (E)=17.16', 12"x18"ERCP
INV (W)=17.17', 12"x18"ERCP
- GI GRATE EL=18.25'
INV (N)=16.59', 12"RCP
INV (S)=16.53', 12"RCP
INV (W)=16.87', 12"RCP
- GI GRATE EL=18.36'
INV (N)=16.48', 12"RCP
INV (S)=16.48', 12"RCP
INV (W)=17.25', 22"x8"OPENING
- CI SOLID TOP
RIM EL=17.07'
INV (S)=13.62', 15"RCP
- CI SOLID TOP
INV (N)=13.25', 15"RCP
INV (S)=13.18', 18"RCP
- CI SOLID TOP
INV (W)=12.74', 18"RCP
INV (E)=12.84', 24"RCP
- GI GRATE EL=14.91'
INV (S)=12.67', 12"RCP
- CI SOLID TOP
INV (S)=12.59', 12"RCP
INV (S)=12.59', 12"x18"ERCP
- GI GRATE EL=15.62'
INV (E)=10.31', 14"x22"ERCP

NO.	REVISION DESCRIPTION	BY	DATE

PROJECT #	404-6076770
SURVEY #	1512 & 1432
SEC./TWN./RGE	12/34S/17E
SCALE	1"=20'
SURVEYED	FDC DEC. 2009
DESIGNED	JS/BLR FEB. 2010
DRAWN	BLR FEB. 2010
CHECKED	JS MAY 2010

JAMES STOCKWELL, P.E.
FLORIDA P.E. # 67198

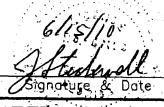



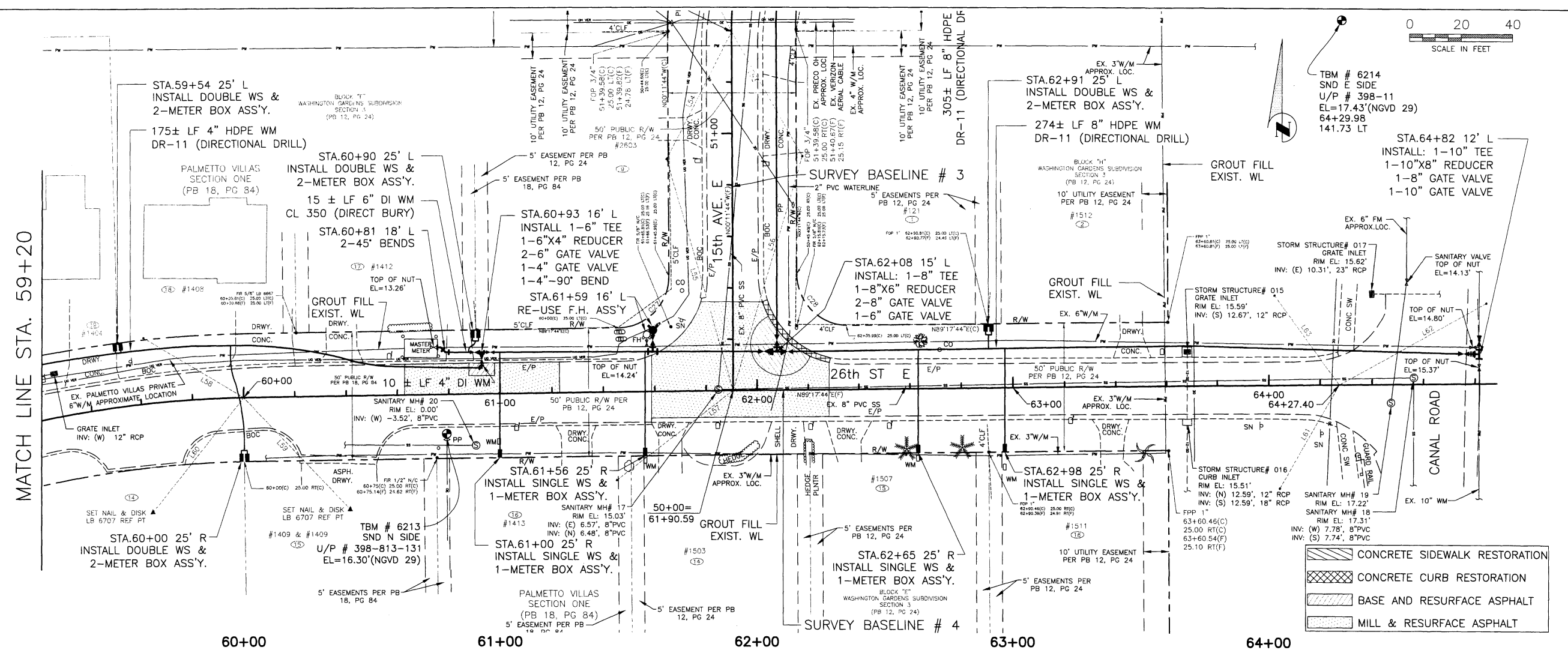
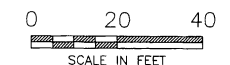

Signature & Date

COPYRIGHT 2010 MANATEE COUNTY GOVERNMENT "P:\WTR LINE Proj\Water Line - Washington Gardens\WMS\Water Line Improv - Washington Gardens.dwg;P&P 10. 6/14/2010 10:18 AM Bruce Robertson, J.T. ARCH full bleed 0 (36.00 x 24.00 inches)

WATER LINE IMPROVEMENTS
WASHINGTON GARDENS
PLAN & PROFILE STA. 60+00 to 64+82



-  CONCRETE SIDEWALK RESTORATION
-  CONCRETE CURB RESTORATION
-  BASE AND RESURFACE ASPHALT
-  MILL & RESURFACE ASPHALT

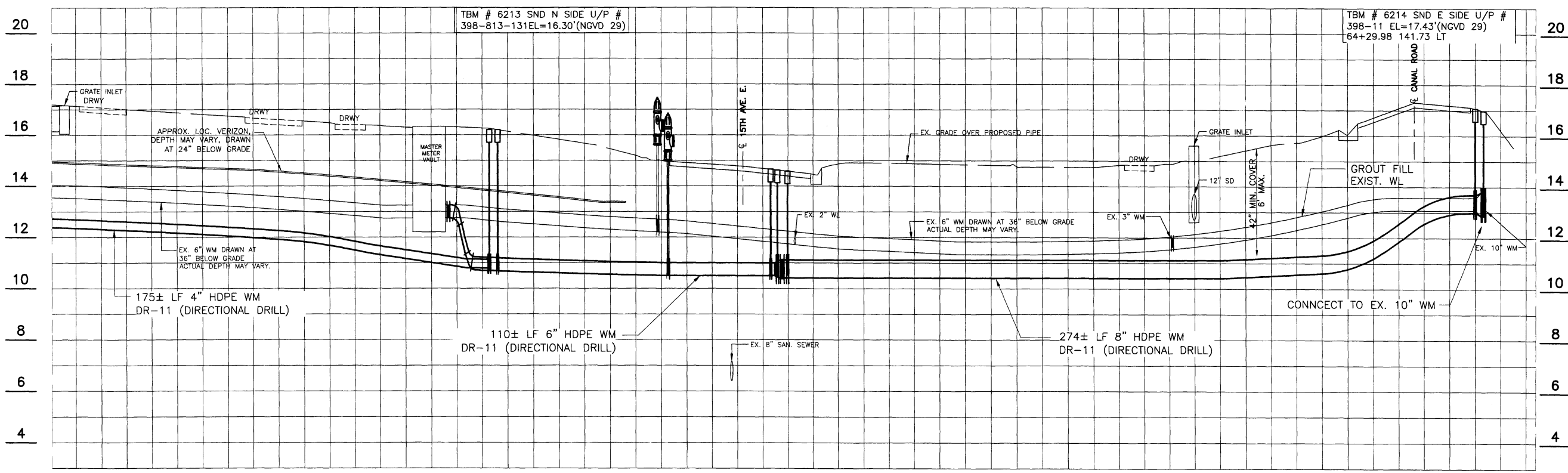

NO.	REVISION DESCRIPTION	BY	DATE

PROJECT #	404-6076770
SURVEY #	1512 & 1432
SEC./TWN./RGE	12/34S/17E
SCALE	1"=20'
BY	DATE
SURVEYED	FDC DEC. 2009
DESIGNED	JS/BLR FEB. 2010
DRAWN	BLR FEB. 2010
CHECKED	JS MAY 2010
JAMES STOCKWELL, P.E.	
FLORIDA P.E. # 67198	
<i>James Stockwell</i> Signature & Date	

SHEET 12 OF 20

COPYRIGHT 2010 MANATEE COUNTY GOVERNMENT, P:\WORK\LINE Proj\Water Line - Washington Gardens\DWG\Water Line Improv - Washington Gardens\DWG\Water Line Improv - Washington Gardens.dwg, Paper 12, E/14/2010 10:19 AM Bruce Robertson, 1:1, A:RGT, full sheet D (38.00 x 24.00 inches)

**WATER LINE IMPROVEMENTS
WASHINGTON GARDENS
PLAN & PROFILE STA. 71+50 TO 75+32**

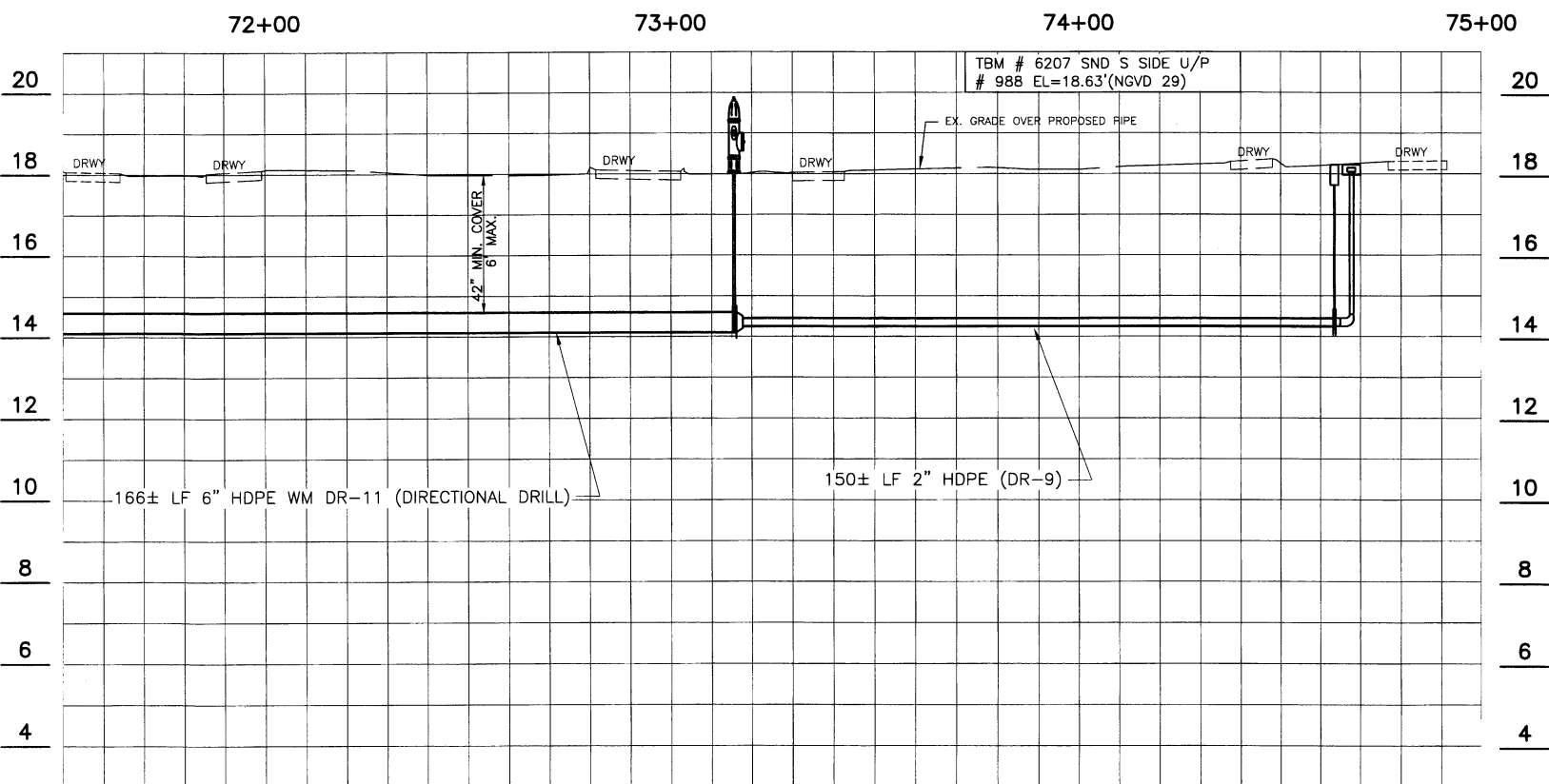
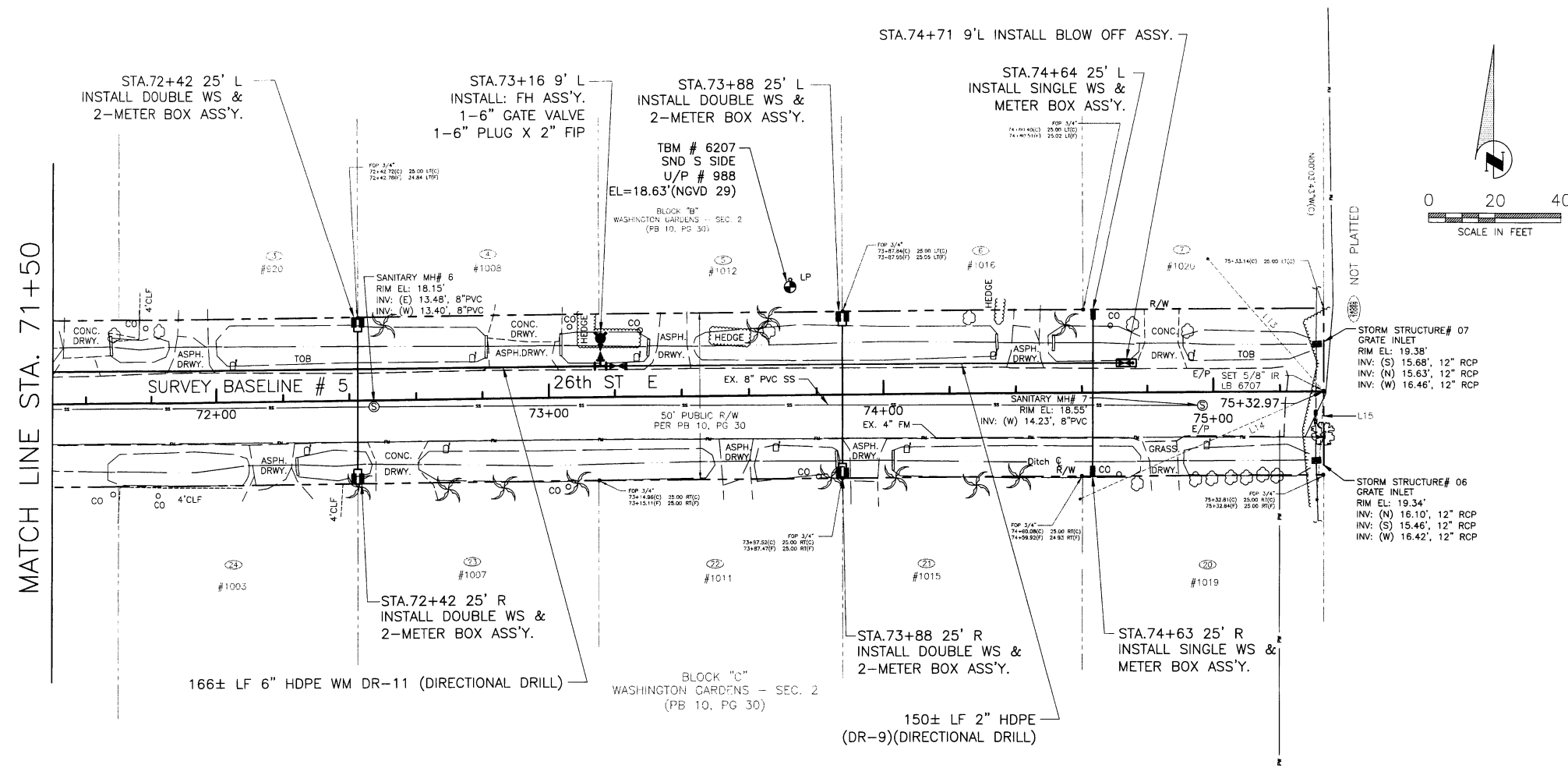

NO.	REVISION DESCRIPTION	BY	DATE

PROJECT #	404-6076770
SURVEY #	1512 & 1432
SEC./TWN./RGE	12/34S/17E
SCALE	1"=20'
SURVEYED	FDC DEC. 2009
DESIGNED	JS/BLR FEB. 2010
DRAWN	BLR FEB. 2010
CHECKED	JS MAY 2010

JAMES STOCKWELL, P.E.
FLORIDA P.E. # 67198

James Stockwell
Signature & Date

COPYRIGHT 2010 MANATEE COUNTY GOVERNMENT | P:\MTR LINE Proj\Water Line - Washington Gardens\DWG\Water Line Improv - Washington Gardens.dwg, P&P 13, 6/15/2010 10:19 AM Bruce Robertson, 1:1 ARCH Tui, bired D, 136.00 x 24.00 inches

**WATER LINE IMPROVEMENTS
WASHINGTON GARDENS
PLAN & PROFILE STA. 80+00 to 83+00**

NO.	REVISION DESCRIPTION	BY	DATE

PROJECT #	404-6076770
SURVEY #	1512 & 1432
SEC./TWN./RGE	12/34S/17E
SCALE	1"=20'
SURVEYED	FDC DEC. 2009
DESIGNED	JS/BLR FEB. 2010
DRAWN	BLR FEB. 2010
CHECKED	JS MAY 2010

JAMES STOCKWELL, P.E.
FLORIDA P.E. # 67198

6/15/10
Stockwell
Signature & Date

MATCH LINE STA. 91+00

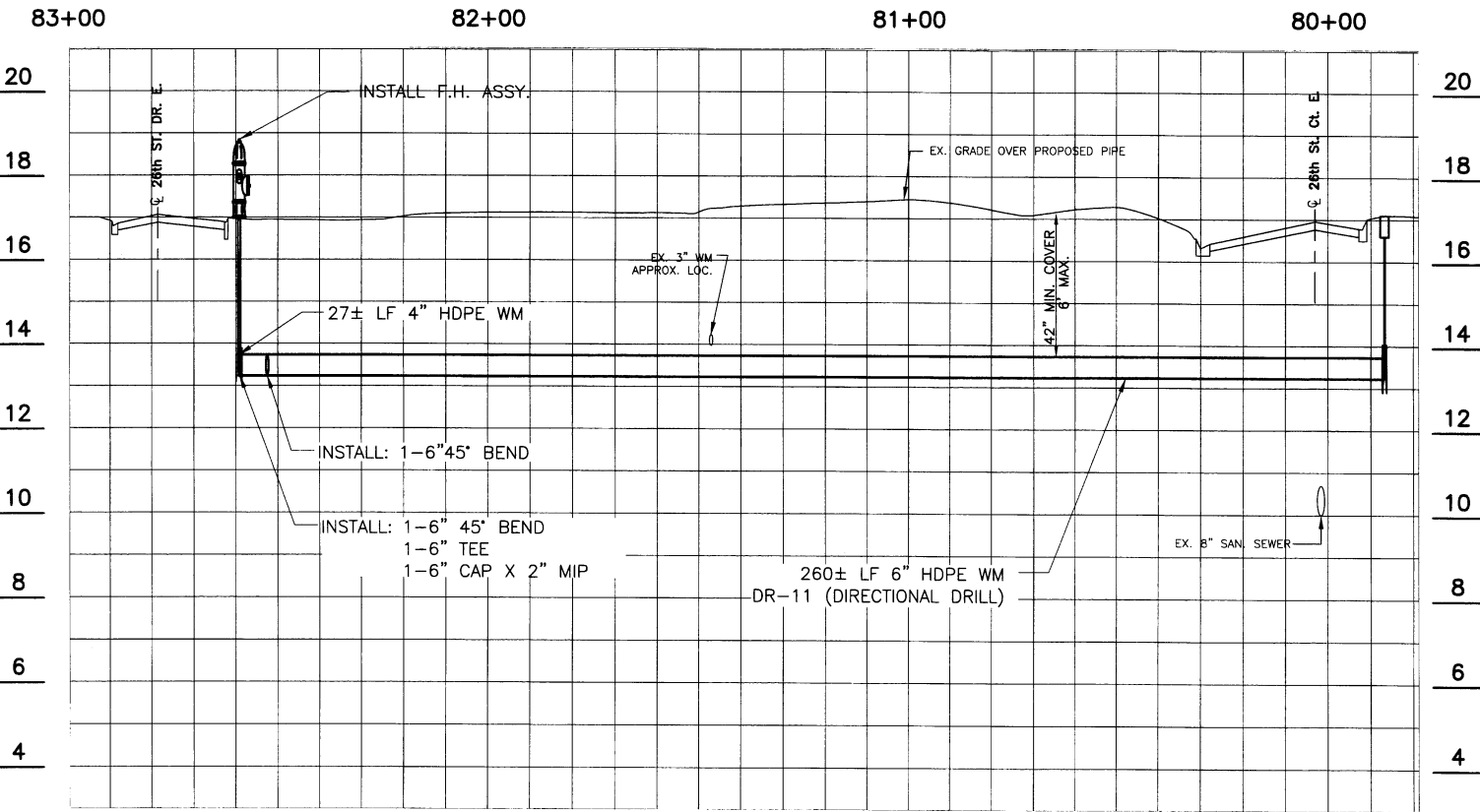
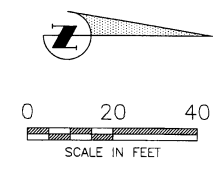
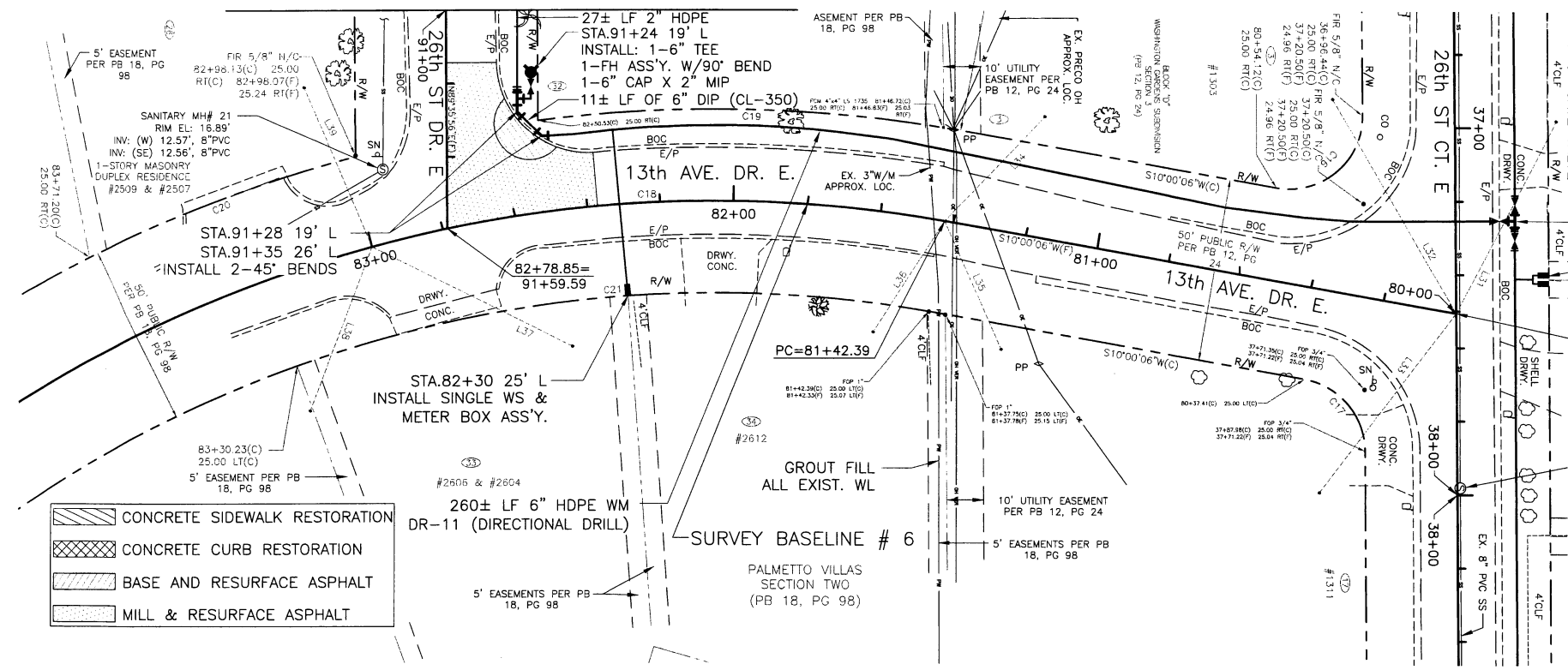

COPYRIGHT 2010 MANATEE COUNTY GOVERNMENT P:\S\1013 Linc Proj\Water Line Improv - Washington Gardens\DWG\Water Line Improv - Washington Gardens.dwg, PLOT 14, 6/14/2010 10:19 AM Bruce Robinson, 1:1, ARCH, Full, Sheet D (56.00 x 24.00 inches)

WATER LINE IMPROVEMENTS
WASHINGTON GARDENS
DETAILS

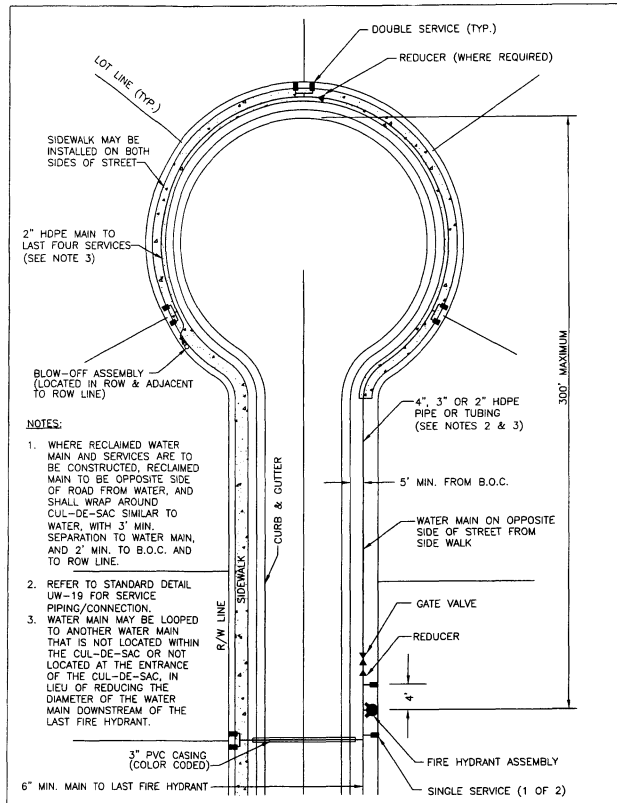

MANATEE COUNTY PUBLIC WORKS DEPARTMENT		CUL-DE-SAC MAINS	UW-20
REV. BY DATE	DATE OF APPROVAL		
CLB/KE 02/09	MARCH 17, 2009		
JAA/JB 10/08			
JAA/JEA 02/09			

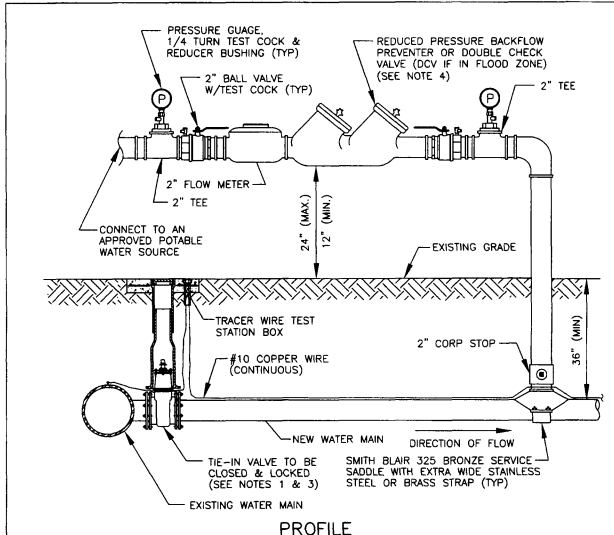

- NOTES:**
- FOR TIE-IN VALVE, SEE DETAIL UW-4 FOR TAPPING SLEEVE VALVE, DETAIL UW-2 FOR GATE VALVE AND DETAIL UW-3 FOR BUTTERFLY VALVE.
 - CORPORATION STOP CONNECTIONS TO WATER MAINS SHALL BE AT A SUFFICIENT DISTANCE FROM NEW TAPPING SLEEVE & VALVE (TIE-IN VALVE). ALL CORPORATION STOP TAPS SHALL BE PLACED NO CLOSER THAN 30" OR A DISTANCE EQUAL TO (1) MAIN PIPE DIAMETER PLUS (2) TAP DIAMETERS (WHICHEVER IS LARGER) FROM THE NEW TIE-IN VALVE (TAPPING VALVE & SLEEVE). A CROSS MAY BE INSTALLED IF THE EXISTING WATER MAIN IS NOT LARGER THAN THE NEW WATER MAIN.
 - IF THE EXISTING WATER MAIN IS LOCATED UNDER PAVEMENT OR CLOSE TO THE ROADWAY, BOTH JUMPER CORPORATION STOPS MAY CONNECT TO THE NEW WATER MAIN LOCATED OUTSIDE OF THE PAVEMENT. AN ADDITIONAL GATE VALVE OR BUTTERFLY VALVE SHALL BE INSTALLED AND THE VALVE MAY BE LOCATED AT THE ROW LINE. PIPING AND APPURTENANCES BETWEEN THE EXISTING MAIN AND ISOLATION VALVE AND JUMPER SHALL BE DISINFECTED BY SPRAYING OR SWABBING.
 - BACKFLOW PREVENTER SHALL BE STRUCTURALLY SUPPORTED.
 - SEE DETAIL UW-22 FOR ADDITIONAL JUMPER CONNECTION NOTES.

MANATEE COUNTY PUBLIC WORKS DEPARTMENT		TEMPORARY JUMPER CONNECTION	UW-21
REV. BY DATE	DATE OF APPROVAL		
CLB/KE 02/09	MARCH 17, 2009		
JAA/JB 10/08			
JAA/JEA 02/09			

- A TEMPORARY JUMPER CONNECTION IS REQUIRED AT ALL CONNECTIONS BETWEEN EXISTING ACTIVE POTABLE WATER MAINS AND PROPOSED NEW WATER MAIN IMPROVEMENTS WITH THE FOLLOWING EXCEPTIONS:
 - PROJECTS THAT INCLUDE A PERMANENT BACKFLOW PREVENTER AT THE RIGHT-OF-WAY WHICH IS ADJACENT TO THE EXISTING WATER MAIN;
 - PROJECTS THAT INCLUDE NEW WATER MAINS THAT ARE LESS THAN OR EQUAL TO 18 LINEAR FEET IN LENGTH; OR
 - OTHER PROPOSED CASES THAT ARE APPROVED BY MANATEE COUNTY AND THE CONSTRUCTION DRAWINGS SPECIFICALLY STATE THAT A TEMPORARY JUMPER CONNECTION IS NOT REQUIRED.
- A TEMPORARY JUMPER SHALL BE USED AND BE CONNECTED TO AN APPROVED POTABLE WATER SOURCE (E.G., EXISTING FIRE HYDRANT, EXISTING SERVICE TAP OR TANK TRUCK, ETC.) AS SHOWN IN THE STANDARD TEMPORARY JUMPER DETAIL UW-21. A TEMPORARY JUMPER SHALL BE USED FOR FILLING ANY NEW WATER MAIN OF ANY SIZE. FOR FLUSHING OF NEW MAINS UP TO 6 INCHES IN DIAMETER (3.0 FPS MINIMUM VELOCITY, PREFERABLY 3.5 FPS) AND FOR DISINFECTION OF ANY NEW MAIN OF ANY SIZE, WATER MAINS WITH A PIPE DIAMETER GREATER THAN OR EQUAL TO 6 INCHES SHALL BE DISINFECTED BY SPRAYING OR SWABBING PER SECTION 4.8 OF AWWA C651. UNLESS APPROVED OTHERWISE, THE REMAINDER OF THE NEW MAIN SHALL BE DISINFECTED IN ACCORDANCE WITH SECTION 4.4.3.3 OF AWWA C651. THE USE OF TABLETS IS PROHIBITED.
- A SEPARATE AND SUCCESSFUL HYDROSTATIC TEST ON THE NEW SYSTEM SHALL OCCUR BETWEEN THE TIE-IN VALVE AND THE CLOSEST DOWNSTREAM GATE VALVE OR BUTTERFLY VALVE BEFORE PERFORMING A HYDROSTATIC TEST ON THE REMAINDER OF THE NEWLY-CONSTRUCTED WATER MAIN. THE TIE-IN VALVE AND THE CLOSEST DOWNSTREAM GATE VALVE OR BUTTERFLY VALVE SHALL BE CLOSED DURING THE HYDROSTATIC TEST OF THE REMAINDER OF THE NEWLY CONSTRUCTED WATER MAIN.
- THE JUMPER SHALL INCLUDE A FLOW METER TO ENSURE THAT THE FLOW FROM THE SUPPLY SOURCE IS AT A CONSTANT MEASURED RATE WHILE CHLORINATING THE NEW MAIN. THE CHLORINE CONCENTRATION SHALL BE MEASURED AT REGULAR INTERVALS TO ENSURE THAT IT IS FED AT A CONSTANT RATE OF NOT LESS THAN 25 MILLIGRAMS PER LITER (MG/L) OF FREE CHLORINE.
- AFTER PRELIMINARY FLUSHING (WATERMANS WITH DIAMETERS LESS THAN 6 INCHES) AND PIGGING (WATERMANS WITH DIAMETERS GREATER THAN OR EQUAL TO 6 INCHES) OF THE NEW WATER MAIN, A MINIMUM FEED CONCENTRATION OF 25 MG/L OF FREE CHLORINE IS REQUIRED. THE CHLORINATED WATER SHALL BE RETAINED IN THE MAIN FOR AT LEAST 24 HOURS AND ALL PORTIONS OF THE MAIN SHALL HAVE A RESIDUAL OF NOT LESS THAN 10 MG/L OF FREE CHLORINE AT THE END OF THIS 24-HOUR PERIOD. THE CONTRACTOR SHALL PROVIDE THE INSPECTOR DOCUMENTATION THAT THE AFORESAID CONCENTRATIONS HAVE BEEN ACHIEVED. FINAL FLUSHING OF THE MAINS SHALL OCCUR PRIOR TO PERFORMING BACTERIOLOGICAL EVALUATIONS AND THE TOTAL CHLORINE RESIDUAL IN THE MAINS SHALL BE NO MORE THAN 4.0 MG/L IN ANY BACTERIOLOGICAL SAMPLE. IF THE CHLORINE RESIDUAL EXCEEDS 4.0 MG/L, A SAMPLE SHALL BE OBTAINED AT THE TEST COCK LOCATED UPSTREAM OF THE BACKFLOW PREVENTER, TO ENSURE THAT THE TOTAL CHLORINE RESIDUAL OF THE NEW MAIN DOES NOT EXCEED THE RESIDUAL OF THE EXISTING SYSTEM.
- THE JUMPER CONNECTION SHALL ALSO BE USED TO MAINTAIN A MINIMUM PRESSURE OF 20 PSI IN THE NEW MAINS CONTINUOUSLY AFTER DISINFECTION AND UNTIL FDFP/FDOH CLEARANCE LETTER IS OBTAINED.
- ALL TEMPORARY BACKFLOW DEVICES OR "JUMPER" INSTALLATIONS DURING PIPELINE CONSTRUCTION MUST SHOW CERTIFICATION THAT THEY HAVE BEEN TESTED ANNUALLY ACCORDING TO THE FLORIDA BUILDING CODE, PLUMBING SECTION, CHAPTER 3, SECTION 312.81, SECTION 608, AND RESOLUTION 897-125. ANNUAL CERTIFICATION MUST BE VALID AT TIME OF INSTALLATION AND PROVIDED TO THE MANATEE COUNTY INSPECTOR UPON REQUEST.
- EXCEPT AS REQUIRED TO FLUSH LINES GREATER THAN 6 INCHES IN DIAMETER, THE LOCKABLE TIE-IN VALVE SHALL REMAIN CLOSED AND SHALL BE LOCKED IN THE CLOSED POSITION BY MANATEE COUNTY. THE TIE-IN VALVE SHALL REMAIN CLOSED AND LOCKED UNTIL THE NEW SYSTEM HAS BEEN CLEARED FOR USE BY THE FDFP/FDOH AND ALL OTHER PERTINENT AGENCIES.
- AFTER RECEIPT OF CLEARANCE FOR USE BY FDFP/FDOH, MANATEE COUNTY, AND ALL OTHER PERTINENT AGENCIES, THE CONTRACTOR SHALL REMOVE THE TEMPORARY JUMPER CONNECTION. THE CORPORATION STOPS ARE TO BE CLOSED AND FLUSHED WITH 2-INCH BRASS WIRE.
- ALL INSTALLATION AND MAINTENANCE OF THE TEMPORARY JUMPER CONNECTION AND ASSOCIATED BACKFLOW PREVENTION DEVICE, FLOW METER, FITTINGS, VALVES, ETC., SHALL BE THE RESPONSIBILITY OF THE CONTRACTOR.
- IF THE WATER MAIN TO RECEIVE FINAL FLUSH IS GREATER THAN 6 INCHES IN DIAMETER OR SUCH LENGTH THAT A FULL PIPE FLUSH AT THE MINIMUM VELOCITY CANNOT BE ACCOMPLISHED, THE FOLLOWING PROCEDURE SHALL BE UTILIZED:
 - CHECK THE PRESSURE ON THE UPSTREAM SIDE OF THE JUMPER TO ENSURE THAT THERE IS ADEQUATE PRESSURE ON THE EXISTING SYSTEM.
 - OPEN DOWNSTREAM VALVES IN THE NEW SYSTEM PRIOR TO FLUSH.
 - PARTIALLY OPEN THE TIE-IN VALVE AND MAINTAIN A LOWER PRESSURE ON THE DOWNSTREAM SIDE OF THE JUMPER THAN THE PRESSURE ON THE UPSTREAM SIDE OF THE JUMPER WHILE FLUSHING/PIGGING THE NEW WATER MAIN.
 - MANATEE COUNTY PERSONNEL SHALL OPERATE THE TIE-IN VALVE TO ENSURE THAT A PRESSURE DIFFERENTIAL IS MAINTAINED.
 - CLOSE TIE-IN VALVE AND THEN CLOSE ALL DOWNSTREAM VALVES IN THE NEW SYSTEM.
 - CLOSE TIE-IN VALVE AND THEN CLOSE ALL DOWNSTREAM VALVES IN THE NEW SYSTEM.
 - THE TIE-IN VALVE SHALL REMAIN CLOSED IF THE POTABLE WATER SOURCE IS A TANK TRUCK.

MANATEE COUNTY PUBLIC WORKS DEPARTMENT		TEMPORARY JUMPER CONNECTION NOTES	UW-22
REV. BY DATE	DATE OF APPROVAL		
CLB/KE 02/09	MARCH 17, 2009		
JAA/JB 10/08			
JAA/JEA 02/09			

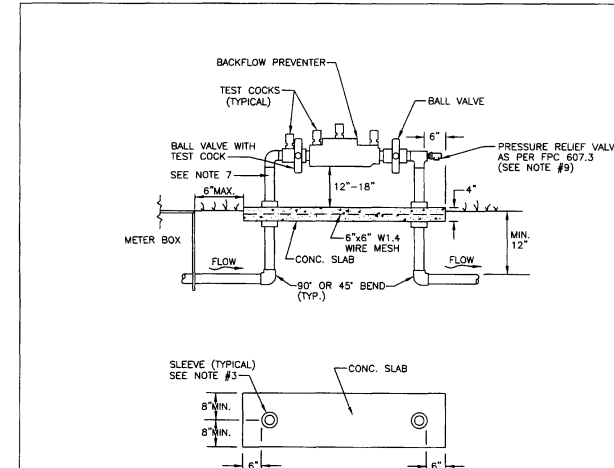

- NOTES:**
- BACKFLOW DEVICE MUST BE INSTALLED IMMEDIATELY DOWNSTREAM OF METER, AS SHOWN ABOVE.
 - COPPER PIPE TYPE "K" OR BRASS PIPE MINIMUM SCHEDULE 40 SHALL BE USED TO A MINIMUM DEPTH OF 12" BELOW GRADE.
 - PIPES PASSING THROUGH OR ENCASED IN CONCRETE MUST BE PROPERLY PROTECTED AND SLEEVED.
 - THE SYSTEM MUST MEET ALL REQUIREMENTS OF THE FLORIDA PLUMBING CODE (LATEST EDITION) AND THE MANATEE COUNTY BACKFLOW PREVENTION ORDINANCE (LATEST EDITION).
 - ALL EXPOSED EDGES OF CONCRETE SHALL BE CHAMFERED 1/2".
 - BACKFLOW PREVENTER SHALL BE TESTED AT THE TIME OF INSTALLATION.
 - PRESSURE REDUCING VALVE REQUIRED UPSTREAM OF BACKFLOW IF SYSTEM PRESSURE EXCEEDS 80 PSI.
 - 3" MINIMUM CLEARANCE FROM LANDSCAPING PLANTS TO EDGE OF CONCRETE SLAB AND CLEAR OPENING FOR ACCESS FROM STREET.
 - IN ADDITION TO THE PRV, THE BUILDING DEPT. MAY REQUIRE AN APPROVED DEVICE FOR THERMAL EXPANSION CONTROL.
 - REFER TO STANDARD DETAIL UW-15 FOR LIFT STATIONS.

MANATEE COUNTY PUBLIC WORKS DEPARTMENT		3/4" & 1" BACKFLOW PREVENTER	UW-12
REV. BY DATE	DATE OF APPROVAL		
CLB/KE 03/06	MARCH 17, 2009		
JAA/JB 10/08			
JAA/JEA 02/09			

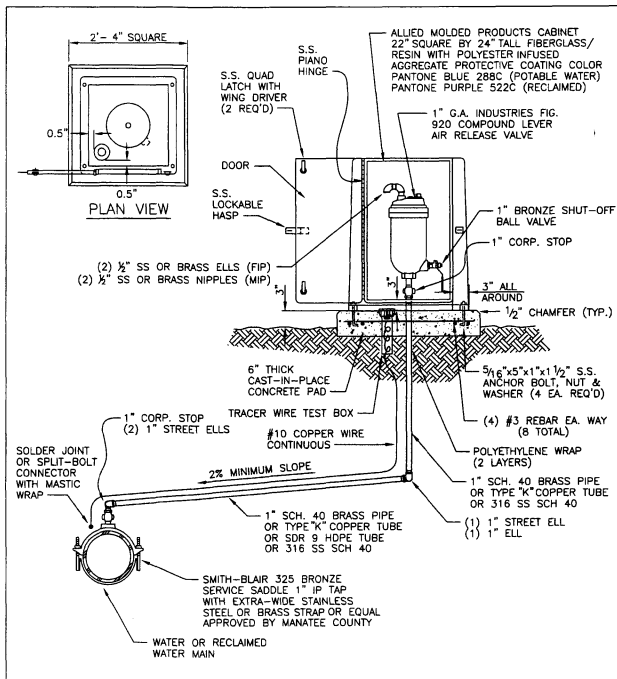

- NOTES:**
- AIR RELEASE VALVES TO BE INSTALLED AT HIGH POINTS ALONG WATER MAINS WHERE SPECIFICALLY INDICATED ON THE PLAN.
 - AIR VENT ORIFICE TO BE SIZED IN ACCORDANCE WITH MANUFACTURER'S RECOMMENDATION FOR WATER MAIN SIZE.
 - ALL INCIDENTAL FITTINGS AND HARDWARE TO BE STAINLESS STEEL.
 - ALL PIPE THREADS TO BE SEALED AIR TIGHT.
 - VENT PIPE TO BE LAID ACCURATELY ON SLOPE, WITHOUT HIGH OR LOW POINTS.

MANATEE COUNTY PUBLIC WORKS DEPARTMENT		ABOVE-GROUND AIR RELEASE VALVE ASSY. FOR 12-INCH AND SMALLER WATER MAINS	UW-9
REV. BY DATE	DATE OF APPROVAL		
CLB/KE 02/05	MARCH 17, 2009		
JAA/JB 10/08			
JAA/JEA 02/09			

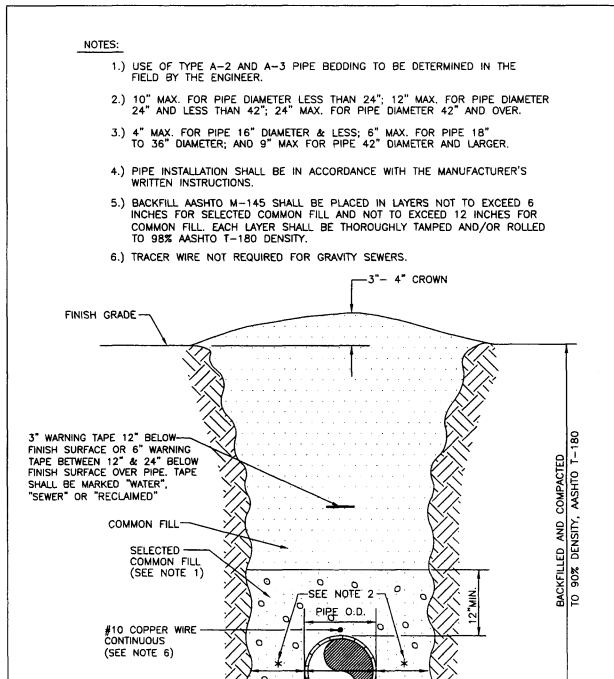

- NOTES:**
- USE OF TYPE A-2 AND A-3 PIPE BEDDING TO BE DETERMINED IN THE FIELD BY THE ENGINEER.
 - 10" MAX. FOR PIPE DIAMETERS LESS THAN 24"; 12" MAX. FOR PIPE DIAMETER 24" AND LESS THAN 42"; 24" MAX. FOR PIPE DIAMETER 42" AND OVER.
 - 4" MAX. FOR PIPE 16" DIAMETER & LESS; 6" MAX. FOR PIPE 18" TO 36" DIAMETER; AND 9" MAX. FOR PIPE 42" DIAMETER AND LARGER.
 - PIPE INSTALLATION SHALL BE IN ACCORDANCE WITH THE MANUFACTURER'S WRITTEN INSTRUCTIONS.
 - BACKFILL AASHTO M-145 SHALL BE PLACED IN LAYERS NOT TO EXCEED 6 INCHES FOR SIZE AND COMMON FILL AND NOT TO EXCEED 12 INCHES FOR COMMON FILL. EACH LAYER SHALL BE THOROUGHLY TAMPED AND/OR ROLLED TO 98% AASHTO T-180 DENSITY.
 - TRACER WIRE NOT REQUIRED FOR GRAVITY SEWERS.

MANATEE COUNTY PUBLIC WORKS DEPARTMENT		TRENCH WITH UNIMPROVED SURFACE TYPE A-1 PIPE BEDDING	UG-11
REV. BY DATE	DATE OF APPROVAL		
CLB/KE 02/05	MARCH 17, 2009		
JAA/JB 10/08			
JAA/JEA 02/09			

- NOTES:**
- USE OF TYPE A-2 AND A-3 PIPE BEDDING TO BE DETERMINED IN THE FIELD BY THE ENGINEER.
 - 10" MAX. FOR PIPE DIAMETERS LESS THAN 24"; 12" MAX. FOR PIPE DIAMETER 24" AND LESS THAN 42"; 24" MAX. FOR PIPE DIAMETER 42" AND OVER.
 - 4" MAX. FOR PIPE 16" DIAMETER & LESS; 6" MAX. FOR PIPE 18" TO 36" DIAMETER; AND 9" MAX. FOR PIPE 42" DIAMETER AND LARGER.
 - PIPE INSTALLATION SHALL BE IN ACCORDANCE WITH THE MANUFACTURER'S WRITTEN INSTRUCTIONS.
 - ASPHALTIC CONCRETE FRICTION COURSE WITH PRIME COAT SHALL BE THE SAME DEPTH AND TYPE AS EXISTING OR A MINIMUM OF ONE INCH, WHICHEVER IS GREATER.
 - SHEETING ORDERED LEFT IN PLACE TO BE CUT OFF 24" BELOW FINISHED GRADE OR 12" BELOW FINISHED GRADE.
 - BASE SHALL BE 8" MINIMUM THICKNESS CRUSHED CONCRETE SAND ASPHALT BASE WILL BE AN ACCEPTABLE ALTERNATIVE.
 - BACKFILL AASHTO M-145 SHALL BE PLACED IN LAYERS NOT TO EXCEED 6 INCHES. EACH LAYER SHALL BE THOROUGHLY TAMPED AND/OR ROLLED TO 98% AASHTO T-180 DENSITY.
 - TEMPORARY PATCHES WILL BE INSTALLED TO PROVIDE A SMOOTH ALL WEATHER SURFACE AT ALL TIME. PERMANENT REPLACEMENT TO BE MADE AS SOON AS POSSIBLE.
 - RESTORE SIGNAGE & MARKING WITH THERMOPLASTIC PER FOOT STANDARDS.
 - TRACER WIRE NOT REQUIRED FOR GRAVITY SEWERS.
 - NOTES 5), THRU 11) ARE MINIMUM REQUIREMENTS. REFER TO MANATEE COUNTY HIGHWAY AND TRAFFIC STANDARDS FOR ADDITIONAL REQUIREMENTS.

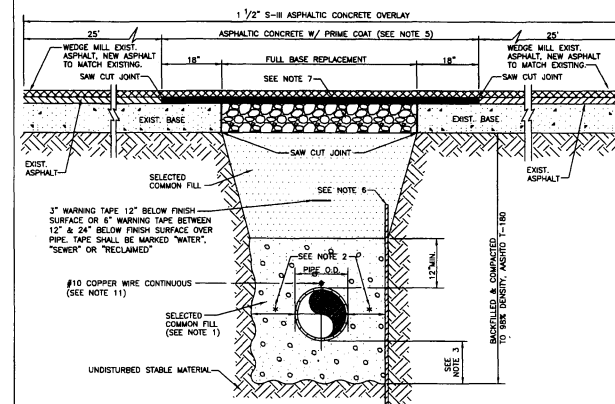

MANATEE COUNTY PUBLIC WORKS DEPARTMENT		TRENCH WITH ASPHALT PAVEMENT SURFACE TYPE A-1 PIPE BEDDING	UG-12
REV. BY DATE	DATE OF APPROVAL		
CLB/KE 02/05	MARCH 17, 2009		
JAA/JB 10/08			
JAA/JEA 02/09			

PIPE SIZE (IN.)	THRUST BLOCK DIMENSIONS B ft. x d inches					
	90° BEND	45° BEND	22.5° BEND	11.25° BEND	DEAD END & TEE	45° WYE
4	1.5 3 1/2	1.1 3 1/2	0.8 3 1/2	0.6 3 1/2	1.3 3 1/2	1.1 3 1/2
6	2.2 5 1/2	1.6 3 3/4	1.2 3 3/4	0.8 3 3/4	1.9 4 1/2	1.6 3 3/4
8	2.9 7	2.1 5	1.5 3 3/4	1.1 3 3/4	2.4 5 1/2	2.0 4 3/4
10	3.5 8 1/2	2.6 6 1/4	1.9 4 1/2	1.3 3 3/4	3.0 7 1/2	2.5 6
12	4.2 10	3.1 7 1/2	2.2 5 1/2	1.6 3 3/4	3.5 8 1/2	3.0 7 1/2
14	4.9 11 3/4	3.6 8 3/4	2.6 6 1/4	1.8 4 1/2	4.1 9 3/4	3.4 8 1/2
16	5.5 13 1/4	4.1 9 3/4	2.9 7	2.1 5	4.7 11 1/4	3.9 9 1/4
18	6.2 15	4.6 11	3.3 8	2.3 5 1/2	5.2 12 1/4	4.4 10 1/4
20	6.9 16 1/2	5.0 12	3.6 8 3/4	2.6 6 1/4	5.8 14	4.9 11 1/4
24	8.2 19 3/4	6.0 14 1/2	4.3 10 1/2	3.1 7 1/2	6.9 16 1/2	5.8 14
30	10.1 24 1/4	7.5 18	5.3 12 1/2	3.8 9	8.5 20 1/2	7.2 17 1/2
36	12.1 29	8.9 21 1/2	6.4 15 1/2	4.5 10 3/4	10.2 24 1/2	8.6 20 3/4

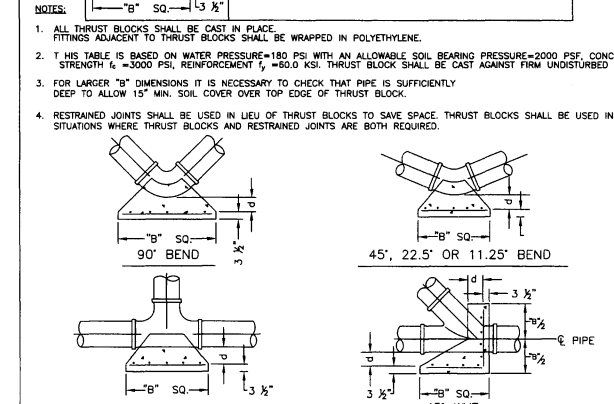

- NOTES:**
- ALL THRUST BLOCKS SHALL BE CAST IN PLACE. FITTINGS ADJACENT TO THRUST BLOCKS SHALL BE WRAPPED IN POLYETHYLENE.
 - T HIS TABLE IS BASED ON WATER PRESSURE=180 PSI WITH AN ALLOWABLE SOIL BEARING PRESSURE=2000 PSF. CONCRETE STRENGTH f_c =3000 PSI, REINFORCEMENT f_y =50.0 KSI. THRUST BLOCK SHALL BE CAST AGAINST FIRM UNDISTURBED SOIL.
 - FOR LARGER "B" DIMENSIONS IT IS NECESSARY TO CHECK THAT PIPE IS SUFFICIENTLY DEEP TO ALLOW 15" MIN. SOIL COVER OVER TOP EDGE OF THRUST BLOCK.
 - RESTRAINED JOINTS SHALL BE USED IN LIEU OF THRUST BLOCKS TO SAVE SPACE. THRUST BLOCKS SHALL BE USED IN SITUATIONS WHERE THRUST BLOCKS AND RESTRAINED JOINTS ARE BOTH REQUIRED.

MANATEE COUNTY PUBLIC WORKS DEPARTMENT		CONCRETE THRUST BLOCKS	UG-7
REV. BY DATE	DATE OF APPROVAL		
CLB/KE 2/05	MARCH 17, 2009		
JAA/JB 10/08			
JAA/JEA 2/09			

DATE					
BY					
REVISION DESCRIPTION					
NO.					
PROJECT #	404-6076770				
SURVEY #	1512 & 1432				
SEC./TWN./RGE	12/34S/17E				
SCALE	1"=20'				
	BY	DATE			
SURVEYED	FDC	DEC. 2009			
DESIGNED	JS/BLR	FEB. 2010			
DRAWN	BLR	FEB. 2010			
CHECKED	JS	MAY 2010			
JAMES STOCKWELL, P.E.					
FLORIDA P.E. # 67198					

