

RFO No.
18-R0685990V
REPLACE MOTOR CONTROL PANELS FOR
EFFLUENT STORAGE LAKE PUMPBACK
STATIONS, SWWRF (910-82, 285-14)
June 19, 2018

Manatee County BCC
Procurement Division
1112 Manatee Avenue West Ste 803
Bradenton, FL 34205
purchasing@mymanatee.org



NOTICE TO OFFERORS
REQUEST FOR OFFERS NUMBER 18-R0685990V
Replace Motor Control Panels for Effluent Storage
Lake Pumpback Stations, SWWRF

Manatee County, a political subdivision of the State of Florida will receive offers from individuals, corporations, partnerships, and other legal entities authorized to do business in the State of Florida (Offerors), to provide a turn-key operation for the replacement of two motor control panels for the effluent storage lake pumpback stations at the Southwest Water Reclamation Facility (SWWRF) including design, permitting, labor, material, equipment, and electrical Services, as specified in this Request for Offers.

DATE, TIME AND PLACE DUE:

The Due Date and Time for submission of Offers in response to this RFO is **August 8, 2018 by 3:00 P.M. ET**. Offers must be delivered to the following location: Manatee County Administration Building, 1112 Manatee Ave. W., Suite 803, Bradenton, FL 34205 or via email to the Designated Procurement Contact shown below.

SOLICITATION INFORMATION CONFERENCE:

In order to ensure that all prospective Offerors have sufficient information and understanding of County's needs, a Non-Mandatory Information Conference will be held at 10:00 AM, on June 29, 2018 at the Southwest Water Reclamation Facility (SWWRF), located at 5101 65th Street West, Bradenton, FL 34210, followed by a Mandatory Tour of the Project Site at 10:30 AM. Attendance to this non-mandatory information conference is not required, but is strongly encouraged. A Mandatory Site Tour will be held at the project site located at 5101 65th St. West, Bradenton, FL at ~~10:30~~. Attendance to the Mandatory Site Tour is required.

QUESTIONS AND CLARIFICATION REQUESTS:

Submit all questions, inquiries, or requests concerning interpretation, clarification or additional information pertaining to this Request for Offer to the Manatee County Procurement Division by July 12, 2018. Questions and inquiries should be submitted via email to purchasing@mymanatee.org or to the Designated Procurement Contact shown below.

Important: A prohibition of lobbying is in place. Review Section A.09 carefully to avoid violation and possible sanctions.

DESIGNATED PROCUREMENT CONTACT: Olga Valcich, CPPB, Procurement Agent
(941) 749-3055, Fax (941) 749-3034
Email: olga.valcich@mymanatee.org
Manatee County Financial Management Department
Procurement Division

AUTHORIZED FOR RELEASE: 

Table of Contents

Request for Offers

Section		Page
A	Instructions to Offerors	4
B	Evaluation of Offers	14
C	Negotiation of the Agreement	15

Attachments

Attachment A	Acknowledgement of Addenda Form	17
Attachment B	Offer Signature Form	18
Attachment C	Public Contracting and Environmental Crimes Certification Form	19
Attachment D	Insurance and Bond Requirements	21
Attachment E	Affidavit of No Conflict	29

Exhibits

Exhibit 1	Scope of Work
Exhibit 2	Offer Response Requirements
Exhibit 3	Sample Agreement
Exhibit 4	Square D Motor Control Drawings

SECTION A
INSTRUCTIONS TO OFFERORS
RFO NUMBER 18-R068599OV

To receive consideration, Offerors must meet the minimum qualification requirements and comply with the instructions contained in this Request for Offerors (RFO). Offers will be accepted from a single business entity, joint venture, partnership or corporation.

A.01 OFFER DUE DATE

The Due Date and Time for submission of Offers in response to this Request for Offers (RFO) is **August 8, 2018 by 3:00 P.M. ET.** Offers must be delivered to Manatee County Administration Building, 1112 Manatee Ave. W., Suite 803, Bradenton, FL 34205 or via email to the Designated Procurement Contact via email at olga.valcich@mymanatee.org. It will be the responsibility of the Offeror to deliver its Offer to the Manatee County Procurement Division for receipt by the Due Date and Time regardless of the method of delivery.

A.02 SUBMISSION OF OFFERS

A. The contents of the Offer package, if submitted in hard copy, must include:

- One (1) bound original identifying Offeror and marked "ORIGINAL" and containing all required information.
- Two (2) bound copy(s) identifying Offeror and marked "COPY" with all required information and identical to the original.
- One (1) electronic format copy identifying Offeror. Electronic format copy should be submitted on a Universal Serial Bus (USB) portable flash memory drives or compact disc (CD) in MicroSoft Office® or Adobe Acrobat® portable document format (PDF) in one continuous file. Do not password protect or otherwise encrypt electronic Offer copies. Electronic copies must contain an identical Offer to the original.

Submit the hard copy Offer package with the following information: RFO 18-R068599OV, Replacement of Two Motor Control Panels for the Effluent Storage Lake Pumpback Stations at SWWRF and Offeror's name. Hard copy Offers are to be delivered to Manatee County Procurement Division at the following address:

Manatee County
Procurement Division
1112 Manatee Avenue West, Suite 803
Bradenton, FL 34205

- B. The contents of the Offer package, if submitted electronically, must include: One (1) electronic format original identifying Offeror. Electronic submission should be submitted in MicroSoft Office® or Adobe Acrobat® portable document format (PDF) in a single, continuous document. Do not password protect or otherwise encrypt electronic Offer submission. Electronic format original must contain all required information.

Submit the electronic Offer package with the following information: RFO No. 18-R068599OV, Replacement of Two Motor Control Panels for the Effluent Storage Lake Pumpback Stations at SWWRF and Offeror's name. Electronic package is to be delivered to the Designated Procurement Contact via email at olga.valcich@mymanatee.org.

RFO NUMBER 18-R068599OV

A.03 ORGANIZATION OF OFFERS

Offers must be organized and arranged with tabs in the same order as listed in the subsections within Exhibit 2 identifying the response to each specific item.

Offers must clearly indicate the legal name, address and telephone number of the Offeror. Offers must be signed by an individual authorized to make representations for the Offeror.

A.04 ADDENDA

Any interpretations, corrections or changes to this RFO will be made by addenda. Addenda will be posted on the Procurement Division’s web page of the Manatee County Government (hereinafter referred to as County) website at <http://www.mymanatee.org/purchasing> > *Bids and Proposals*. For those solicitations that are advertised on DemandStar, addenda will also be posted on the DemandStar distribution system on the ‘Planholders’ link.

All addenda are a part of the RFO and each Offeror will be bound by such addenda. It is the responsibility of each Offeror to read and comprehend all addenda issued. Failure of any Offeror to acknowledge an issued addendum in its Offer will not relieve the Offeror from any obligation contained therein.

Manatee County will not be responsible for oral interpretations given by other sources including County staff, representative, or others. The issuance of a written addendum by the Procurement Division is the only official method whereby interpretation, clarification or additional information will be given.

A.05 OFFEROR EXPENSES

All costs incurred by Offeror in responding to this RFO and to participate in any interviews/presentations/demonstrations, including travel, will be the sole responsibility of the Offeror.

A.06 FALSE OR MISLEADING STATEMENTS

Offers which contain false or misleading statements or which provide references which do not support an attribute or condition claimed by the Offeror, may be rejected. If, in the opinion of the County, such information was intended to mislead the County in its evaluation of the Offer, and the attribute, condition or capability is a requirement of this RFO. Such Offeror will be disqualified from consideration for this RFO and may be disqualified from submitting a response on future solicitation opportunities with the County.

A.07 WITHDRAWAL OR REVISION OF OFFERS

Offerors may withdraw Offers under the following circumstances:

- a. If Offeror discovers a mistake(s) prior to the Due Date and Time. Offeror may withdraw its Offer by submitting a written notice to the Procurement Division. The notice must be received in the Procurement Division prior to the Due Date and Time for receiving Offers. A copy of the request shall be retained and the unopened Offer returned to the Offeror; or
- b. After the Offers are opened but before a contract is signed, Offeror alleges a material mistake of fact if:

1. The mistake is clearly evident in the solicitation document; or
2. Offeror submits evidence which clearly and convincingly demonstrates that a mistake was made in the Offer. Request to withdraw an Offer must be in writing and approved by the Procurement Official.

A.08 JOINT VENTURES

Offerors intending to submit an Offer as a joint venture with another entity are required to have filed proper documents with the Florida Department of Business and Professional Regulation and all other State or local licensing agencies as required by Florida Statute Section 489.119, prior to the Due Date and Time.

A.09 LOBBYING

After the issuance of any solicitation or during renegotiations, prospective Offerors, or their agents, representatives or persons acting on behalf of such Offeror, shall not contact, communicate with or discuss any matter relating in any way to the solicitation with any officer, agent or employee of Manatee County other than the Procurement Official or designee. This prohibition includes copying such persons on written communication, including email correspondence. This requirement begins at the time of advertisement of the RFO and ends upon final execution of the contract or at the time the solicitation is cancelled or the renegotiation efforts are terminated. The prohibition does not apply to presentations made to the evaluation committee or at a County Commission meeting where the Commission is considering approval of a proposed contract. Violators of this prohibition will be subject to sanctions as provided in the Manatee County Code of Ordinances Section 2-26-31 and 2-26-32. Sanctions may include (a) written warning; (b) termination of contracts; and (c) debarment or suspension.

A.10 EXAMINATION OF OFFERS

The examination and evaluation of the Offers submitted in response to this solicitation generally requires a period of not less than ninety (90) calendar days. Therefore, Offers submitted in response to this RFO must be valid for ninety (90) calendar days after the Due Date.

A.11 ERRORS OR OMISSIONS

Once an Offer is opened, the County will not accept any request by Offeror to correct errors or omissions in the Offer other than as identified in paragraph A.07.

A.12 DETERMINATION OF RESPONSIBLENESS AND RESPONSIVENESS

The County will conduct a due diligence review of all Offers received to determine if the Offeror is responsible and responsive.

To be responsive an Offeror must submit an Offer that conforms in all material respects to the requirements of this RFO and contains all the information, fully completed attachments and forms, and other documentation required. Offers that are deemed non-responsive will not be considered or evaluated.

To be responsible, an Offeror must meet the minimum qualification requirements and have the capability to perform the Scope of Services contained in this RFO. Offers submitted by Offerors that are deemed non-responsible will not be considered or evaluated.

A.13 RESERVED RIGHTS

The County reserves the right to accept or reject any and all Offers, to waive irregularities and technicalities, to request additional information and documentation, and to cancel this solicitation at any time prior to execution of the contract. In the event only one Offer is received, the County reserves the right to negotiate with the Offeror. The County reserves the right to award the contract to a responsive and responsible Offeror which in its sole determination is the best value and in the best interests of the County.

The County reserves the right to conduct an investigation as it deems necessary to determine the ability of any Offeror to perform the work or service requested. Upon request by the County, Offeror shall provide all such information to the County. Additional information may include, but will not be limited to, current financial statements prepared in accordance with generally accepted accounting practices and certified by an independent CPA or official of Offeror; verification of availability of equipment and personnel; and past performance records.

A.14 APPLICABLE LAWS

Offeror must be authorized to transact business in the State of Florida. All applicable laws and regulations of the State of Florida and ordinances and regulations of Manatee County will apply to any resulting contract. This solicitation process will be conducted in accordance with Manatee County Code of Ordinances, Chapter 2-26.

A.15 TAXES

Manatee County is exempt from Federal Excise and State Sales Taxes. (F.E.T. Cert. No. 59-78-0089K; Florida Sales Tax Exempt Cert. No. 85-8012622206C-6). Therefore, the Offeror is prohibited from delineating a separate line item in its Offer for any sales or service taxes.

The Offeror who is awarded the Agreement (Successful Offeror) will be responsible for the payment of taxes of any kind, including but not limited to sales, consumer, use, and other similar taxes payable on account of the work performed and/or materials furnished under the award in accordance with all applicable laws and regulations.

A.16 SCRUTINIZED COMPANIES

Pursuant to Florida Statute Section 287.135, as of July 1, 2012, a company that, at the time of submitting a response for a new contract or renewal of an existing contract, is on the Scrutinized Companies with Activities in Sudan List or the Scrutinized Companies with Activities in the Iran Petroleum Energy Sector List, created pursuant to Florida Statute Section 215.473, is ineligible for, and may not submit a response for or enter into or renew a contract with an agency or local governmental entity for goods or services of \$1 million or more.

A.17 COLLUSION

Offeror certifies that its Offer is made without prior understanding, agreement, or connection with any other corporation, firm or person submitting an Offer for the same materials, services, supplies, or equipment and is in all respects fair and without collusion or fraud.

Any such violation may result in contract cancellation, return of materials or discontinuation of services and the possible removal of Offeror from participation in future County solicitations for a specified period.

The County reserves the right to disqualify an Offeror during any phase of the solicitation process and terminate for cause any resulting contract upon evidence of collusion with intent to defraud on the part of the Offeror.

A.18 CODE OF ETHICS

With respect to this Offer, if any Offeror violates, directly or indirectly, the ethics provisions of the Manatee County Procurement Code and/or Florida criminal or civil laws related to public procurement, including but not limited to Florida Statutes Chapter 112, Part II, Code of Ethics for Public Officers and Employees, such Offeror will be disqualified from eligibility to perform the work described in this RFO, and may also be disqualified from submitting any future bids or Offers to supply goods or services to Manatee County.

A.19 PUBLIC ENTITY CRIMES

In accordance with Section 287.133, Florida Statutes, a person or affiliate who has been placed on the convicted vendor list following a conviction for a public entity crime may not submit an Offer on a contract to provide any goods or services to a public entity, may not submit an Offer on a contract with a public entity for the construction or repair of a public building or public work, may not submit Offers on leases or real property to a public entity, may not be awarded or perform work as a contractor, supplier, subcontractor, or consultant under a contract with any public entity, and may not transact business with any public entity in excess of the threshold amount provided in Section 287.017 for Category Two for a period of 36 months from the date of being placed on the convicted vendor list.

In addition, Manatee County Code of Laws Chapter 2-26 Article V prohibits the award of County contracts to any person or entity who/which has, within the past 5 years, been convicted of, or admitted to in court or sworn to under oath, a public entity crime or of any environmental law that, in the reasonable opinion of the Procurement Official, establishes reasonable grounds to believe the person or business entity will not conduct business in a reasonable manner.

To ensure compliance with the foregoing, Manatee County Code of Laws requires all persons or entities desiring to contract with Manatee County to execute and file with the Procurement Official an affidavit, executed under the pain and penalties of perjury, confirming that person, entity, and any person(s) affiliated with the entity, does not have such a record and is therefore eligible to seek and be awarded business with Manatee County. Offeror must complete Attachment C and submit with its Offer.

A.20 AMERICANS WITH DISABILITIES

Manatee County does not discriminate upon the basis of any individual's disability status. This non-discrimination policy involves every aspect of County's functions including one's access to participation, employment, or treatment in its programs or activities. Anyone requiring reasonable accommodation for an information conference or Offer opening should contact the person named on the cover page of this document at least twenty-four (24) hours in advance of either activity.

A.21 EQUAL EMPLOYMENT OPPORTUNITY

In accordance with Title VI of the Civil Rights Act of 1964, Title 15, Part 8 of the Code of Federal Regulations and the Civil Rights Act of 1992, Manatee County hereby notifies all Offerors that it will affirmatively ensure minority business enterprises are afforded full opportunity to participate in response to this Request For Offer and will not be discriminated against on the grounds of race, color, national origin, religion, sex, age, handicap, or marital status in consideration of award.

A.22 MINORITY AND/OR DISADVANTAGED BUSINESS ENTERPRISE

The State of Florida Office of Supplier Diversity provides the certification process and maintains the database of certified MBE/DBE firms. Additional information may be obtained at <http://www.osd.dms.state.fl.us/iframe.htm> or by calling (850) 487-0915.

A.23 DISCLOSURE

Upon receipt, all inquiries and responses to inquiries related to this Request for Offer become "Public Records", and shall be subject to public disclosure consistent with Florida Statute, Chapter 119.

Offers become subject to disclosure thirty (30) days after the opening or if a notice of intent to award decision is made earlier than this time as provided by Florida Statutes § 119.071(1)(b). No announcement or review of the Offers shall be conducted at the public opening.

If County rejects all Offers and concurrently notices its intent to reissue the solicitation, the rejected Offers are exempt from public disclosure until such time the County provides notice of an intended decision concerning the reissued solicitation or until County withdraws the reissued solicitation. An Offer is not exempt for longer than twelve (12) months after the initial notice of rejection of all Offers.

Pursuant to Florida Statute 119.0701, to the extent Successful Offeror is performing services on behalf of County, Successful Offeror must:

- a. Keep and maintain public records required by public agency to perform the service. That information and data it manages as part of the services may be public record in accordance with Chapter 119, Florida Statutes and Manatee County public record policies. Offeror agrees, prior to providing goods/services, it will implement policies and procedures, which are subject to approval by County, to maintain, produce, secure, and retain public records in accordance with applicable laws, regulations, and County policies including but not limited to Section 119.0701, Florida Statutes.

- b. Upon request from the public agency's custodian of public records, provide the public agency with a copy of the requested records or allow the records to be inspected or copied within a reasonable time at a cost that does not exceed the cost provided in Florida Statutes, Chapter 119, or as otherwise provided by law.
- c. Ensure that public records that are exempt or confidential and exempt from public records disclosure requirements are not disclosed except as authorized by law for the duration of the contract term and following completion of the contract if the Successful Offeror does not transfer the records to the public agency.
- d. Upon completion of the contract, transfer, at no cost, to the public agency all public records in possession of contractor or keep and maintain public records required by the public agency to perform the service. If the Successful Offeror transfers all public records to County upon completion of the contract, the Successful Offeror shall destroy any duplicate public records that are exempt or confidential and exempt from public records disclosure requirements. If the Successful Offeror keeps and maintains public records upon completion of the contract, the Successful Offeror shall meet all applicable requirements for retaining public records. All records stored electronically must be provided to County, upon request from County's custodian of public records, in a format that is compatible with the information technology systems of County.

IF THE SUCCESSFUL OFFEROR HAS QUESTIONS REGARDING THE APPLICATION OF CHAPTER 119, FLORIDA STATUTES, TO ITS DUTY TO PROVIDE PUBLIC RECORDS RELATING TO ANY RESULTING CONTRACT, CONTACT COUNTY'S CUSTODIAN OF PUBLIC RECORDS AT: (941) 742-5845, DEBBIE.SCACCIANOCE@MYMANATEE.ORG, ATTN: RECORDS MANAGER, 1112 MANATEE AVENUE WEST, BRADENTON, FL 34205.

A.24 TRADE SECRETS

Manatee County is subject to Chapter 119, Florida Statutes. Therefore, all documents, materials, and data submitted as part of an Offer in response to a Request for Offer are governed by the disclosure, exemption and confidentiality provisions relating to public records in Florida Statutes.

Except for materials that are 'trade secrets' as defined by Chapter 812, Florida Statutes, ownership of all documents, materials and data submitted as part of an Offer in response to the Request for Offer shall belong exclusively to County.

To the extent that Offeror desires to maintain the confidentiality of materials that constitute trade secrets pursuant to Florida law, trade secret material submitted must be segregated from the portions of the Offer that are not declared as trade secret. In addition, Offeror shall cite, for each trade secret claimed, the Florida Statute number which supports the designation. Further, Offeror shall offer a brief written explanation as to why the cited Statute is applicable to the information claimed as trade secret. Additionally, Offeror shall provide a hard copy of its Offer that redacts all information designated as trade secret.

In conjunction with trade secret designation, Offeror acknowledges and agrees that:

1. Trade secret requests made after the opening will not be considered. However, County reserves the right to clarify the Offerors request for trade secret at any time; and
2. County and its officials, employees, agents, and representatives are hereby granted full rights to access, view, consider, and discuss the information designated as trade secret throughout the evaluation process and until final execution of any awarded purchase order or contract; and
3. That after notice from County that a public records request has been made pursuant to Offeror's Offer, the Offeror at its sole expense, shall be responsible for defending its determination that submitted material is a trade secret and is not subject to disclosure. Action by Offeror in response to notice from the County shall be taken immediately, but no later than 10 calendar days from the date of notification or Offeror will be deemed to have waived the trade secret designation of the materials.

Notwithstanding any other provision in this solicitation, designation of the entire Offer as 'trade secret', 'proprietary', or 'confidential' is not permitted and may result in a determination that the Offer is non-responsive.

A.25 CONFIDENTIALITY OF SECURITY RELATED RECORDS

- a. Pursuant to Florida Statutes § 119.071(3), the following records (hereinafter referred to collectively as "the Confidential Security Records") are confidential and exempt from the disclosure requirements of Florida Statutes § 119.07(1):
 - i. A Security System Plan or portion thereof for any property owned by or leased to County or any privately owned or leased property held by County.
 - ii. Building plans, blueprints, schematic drawings, and diagrams, including draft, preliminary, and final formats, which depict the internal layout and structural elements of a building, arena, stadium, water treatment facility, or other structure owned or operated by County.
 - iii. Building plans, blueprints, schematic drawings, and diagrams, including draft, preliminary, and final formats, which depict the internal layout or structural elements of an attractions and recreation facility, entertainment or resort complex, industrial complex, retail and service development, office development, or hotel or motel development in the possession of, submitted to County.
- b. Successful Offeror agrees that, as provided by Florida Statute, it shall not, as a result of a public records request, or for other reason disclose the contents of, or release or provide copies of the Confidential Security Records to any other party absent the express written authorization of County's Property Management Director or to comply with a court order requiring such release or disclosure. To the extent Successful Offeror receives a request for such records, it shall immediately contact the County's designated Contract administrator who shall coordinate County's response to the request.

A.26 E-VERIFY

Prior to the employment of any person under this contract, the Successful Offeror shall utilize the U.S. Department of Homeland Security's E-Verify system to verify the employment eligibility of (a) all persons employed during the contract term by the Successful Offeror to perform employment duties within Florida and (b) all persons, including subcontractors, assigned by the Successful Offeror to perform work pursuant to the contract with Manatee County. For more information on this process, please refer to United States Citizenship and Immigration Service site at: <http://www.uscis.gov/>.

Only those individuals determined eligible to work in the United States shall be employed under this contract.

By submission of an Offer in response to this RFO, the Successful Offeror commits that all employees and subcontractors will undergo e-verification before placement on this contract.

The Successful Offeror shall maintain sole responsibility for the actions of its employees and subcontractors. For the life of the contract, all employees and new employees brought in after contract award shall be verified under the same requirement stated above.

A.27 LICENSES AND PERMITS

The Successful Offeror shall be solely responsible for obtaining all necessary license and permit fees, including, but not limited to, all license fees, permit fees, impact fees, or inspection fees, and responsible for the costs of such fees. Successful Offeror is solely responsible for ensuring all work complies with all Federal, State, local, and Manatee County ordinances, orders, codes, laws, rules, regulations, directives, and guidelines.

A.28 BINDING OFFER

Offers will remain valid for a period of 120 days following the Due Date and Time and will be considered a binding offer to perform the required services and/or provide the required goods. The submission of an Offer will be taken as prima facie evidence that the Offeror has familiarized itself with the contents of this Solicitation.

A.29 SOLICITATION SCHEDULE

The following schedule has been established for this Solicitation process. Refer to the County's website (www.mymanatee.org > Online Services > *Bids & Proposals*) for meeting locations and updated information pertaining to any revisions to this schedule.

Scheduled Item	Scheduled Date
Non-Mandatory Solicitation Information Conference at the SWWRF, 5101 65 th Street West, Bradenton, FL 34210, with a Mandatory Site Tour of the Project at 10:45 AM.	June 29, 2018 at 10:00 A.M.
Question and Clarification Deadline	July 12, 2018
Final Addendum Posted	July 25, 2018
Offer Response Due Date and Time	August 8, 2018, by 3:00 P.M.
Interviews/Presentations (if conducted)	August 16, 2018 at 10:00 A.M.
Evaluation Completed	August 31, 2018
Projected Award	September, 2018

END SECTION A

**SECTION B
EVALUATION OF OFFERS
RFO NUMBER 18-R068599OV**

B.01 EVALUATION

Evaluation of Offers will be conducted by County staff and will consider all information submitted by each responsible and responsive Offeror, any clarification information provided by an Offeror, feedback received from Offeror’s references, and any other relevant information received regarding Offeror, to ascertain the ability of the Offeror to perform the scope of services as stated in this RFO. Each Offeror must ensure that its Offer contains all the information requested in this RFO and reflects Offeror’s best offer.

As part of the evaluation process the County may request additional information or clarification from Offerors for the purpose of further evaluation of (a) conformance to the solicitation requirements, (b) the abilities of the Offeror, and (c) understanding of the proposal submitted. Additional information and/or clarification must be submitted by Offeror within the requested time-period.

Additionally, interviews, presentations and/or demonstrations may be conducted with Offerors as part of the evaluation process. If conducted, only those offers that are deemed by the County as having a reasonable probability of being selected for award will be invited to meet with the County. Offerors should make arrangements to attend the interviews, presentations and/or demonstrations if invited. The interviews, presentations and/or demonstrations are closed to the public.

B.02 RECOMMENDATION FOR NEGOTIATION

A recommendation will be made as to the Offeror(s) with whom the County should enter into negotiations, if any. Upon approval of the recommendation, the Successful Offeror will be invited to enter negotiations led by the County Procurement Division.

B.03 EVALUATION CRITERIA

The following evaluation criteria have been established for this RFO.

Criteria	Maximum Points
Offeror & Team's Experience	35
Capacity of In House Work	20
Testing / Inspection / Quality Control	25
Fees	20
Total:	100

B.04 RECOMMENDATION FOR AWARD

Upon successful completion of negotiations, a recommendation for award to the Successful Offeror(s) will be presented for approval per County ordinances, policies and procedures.

END SECTION B

SECTION C
NEGOTIATION OF THE AGREEMENT
RFO NUMBER 18-R068599OV

C.01 GENERAL

- a. The Offer will serve as a basis for negotiating an agreement, but not compel adherence to its terms or conditions.
- b. Upon submission, all Offers become the property of Manatee County which has the right to use any or all ideas presented in any Offer submitted in response to this Request for Offer whether, or not, the Offer is accepted.
- c. All products and papers produced during the solicitation process become the property of Manatee County upon termination or completion of the engagement.
- d. To indemnify and hold County, and its officials, employees, agents and representatives harmless from any actions, damages (including attorney's fees and costs), or claims arising from or related to the designation of trade secrets by the Offeror, including actions or claims arising from County's non-disclosure of the trade secret materials.

C.02 AGREEMENT

The selected Offeror(s) will be required to negotiate a contract in a form and with provisions acceptable to the County. Negotiated contracts may or may not include all elements of this RFO or the resulting successful Offer where alternatives provide best value, are desirable to the County, and the parties agree to such terms.

C.03 AWARD

County may not make award to an Offeror who is delinquent in payment of any taxes, fees, fines, contractual debts, judgments, or any other debts due and owed to County, or is in default on any contractual or regulatory obligation to County. By submitting this solicitation response, Offeror attests that it is not delinquent in payment of any such debts due and owed to County, nor is it in default on any contractual or regulatory obligation to County. In the event the Offeror's statement is discovered to be false, Offeror will be subject to suspension and/or debarment and County may terminate any contract it has with Offeror.

Award of an agreement is subject to the successful negotiations and the approval of either the Procurement Official or the Board of County Commissioners (as provided for in the current Manatee County Procurement Code).

The parties will negotiate the terms and conditions of the agreement, which may or may not include renewal, assignment, termination, insurance, auditing or any other relevant contractual term and the circumstances in which it may be renewed, assigned or terminated.

END SECTION C

**ATTACHMENT A
ACKNOWLEDGMENT OF ADDENDA
RFO NUMBER 18-R068599OV**

The undersigned acknowledges receipt of the following addenda:

Addendum No. _____	Date Received:
Addendum No. _____	Date Received:
Addendum No. _____	Date Received:
Addendum No. _____	Date Received:
Addendum No. _____	Date Received:
Addendum No. _____	Date Received:
Addendum No. _____	Date Received:
Addendum No. _____	Date Received:
Addendum No. _____	Date Received:

Print or type Offeror's information below:

Name of Offeror	Telephone Number
Street Address	City/State/Zip
Email Address	Website Address
Print Name & Title of Authorized Official	Signature of Authorized Official
	Date

**ATTACHMENT B
OFFER SIGNATURE FORM
RFO NUMBER 18-R068599OV**

The undersigned represents that:

- (1) by signing the Offer, that he/she has the authority and approval of the legal entity purporting to submit the Offer and any additional documentation which may be required such as the Joint Venture Agreement or Joint Venture Affidavit, if applicable;
- (2) all facts and responses set forth in the Offer are true and correct;
- (3) if the Offeror is selected by County to negotiate an agreement, that Offeror's negotiators will negotiate in good faith to establish an agreement to provide the services described in the Scope of Services of this RFO;
- (4) by submitting an Offer and signing below, the Offeror agrees to all terms and conditions in this RFO, which incorporates all addenda, appendices, exhibits, and attachments, in its entirety, and is prepared to sign the Contract as written. The Offeror understands that if it submits exceptions to the Contract in its Offer, the Offeror's Offer may be determined non-responsive; and
- (5) the Offeror, which includes all companies included in a partnership or joint venture, is not on the Scrutinized Companies with Activities in Sudan List or the Scrutinized Companies with Activities in the Iran Petroleum Energy Sector List.

Print or type Offeror's information below:

Name of Offeror	Telephone Number
Street Address	City/State/Zip
Email Address	Web Address
Print Name & Title of Authorized Officer	Signature of Authorized Officer Date

ATTACHMENT C
PUBLIC CONTRACTING AND ENVIRONMENTAL CRIMES CERTIFICATION
RFO NUMBER 18-R068599OV

SWORN STATEMENT PURSUANT TO SECTION 2-26 ARTICLE V,
MANATEE COUNTY PROCUREMENT CODE

THIS FORM MUST BE SIGNED AND SWORN TO IN THE PRESENCE OF A NOTARY PUBLIC OR OTHER OFFICIAL AUTHORIZED TO ADMINISTER OATHS.

This sworn statement is submitted to Manatee County by _____
[print individual's name and title]

for _____
[name of entity submitting sworn statement]

whose business address is: _____

and (if applicable) its Federal Employer Identification Number (FEIN) is _____. If the entity has no FEIN, include the Social Security Number of the individual signing this sworn statement:

I understand that no person or entity shall be awarded or receive a county contract for public improvements, procurement of goods or services (including professional services) or a county lease, franchise, concession or management agreement, or shall receive a grant of county monies unless such person or entity has submitted a written certification to County that it has not:

(1) been convicted of bribery or attempting to bribe a public officer or employee of Manatee County, the State of Florida, or any other public entity, including, but not limited to the Government of the United States, any state, or any local government authority in the United States, in that officer's or employee's official capacity; or

(2) been convicted of an agreement or collusion among Offerors or prospective Offerors in restraint of freedom of competition, by agreement to bid a fixed price, or otherwise; or

(3) been convicted of a violation of an environmental law that, in the sole opinion of the County's Purchasing Director, reflects negatively upon the ability of the person or entity to conduct business in a responsible manner; or

(4) made an admission of guilt of such conduct described in items (1), (2) or (3) above, which is a matter of record, but has not been prosecuted for such conduct, or has made an admission of guilt of such conduct, which is a matter of record, pursuant to formal prosecution. An admission of guilt shall be construed to include a plea of nolo contendere; or

(5) where an officer, official, agent or employee of a business entity has been convicted of or has admitted guilt to any of the crimes set forth above on behalf of such and entity and pursuant to the direction or authorization of an official thereof (including the person committing the offense, if he is an official of the business entity), the business shall be chargeable with the conduct herein above set forth. A business entity shall be chargeable with the conduct of an affiliated entity, whether wholly owned, partially owned, or one which has common ownership or a common Board of Directors.

For purposes of this Form, business entities are affiliated if, directly or indirectly, one business entity controls or has the power to control another business entity, or if an individual or group of individuals controls or has the power to control both entities. Indicia of control shall include, without limitation, interlocking management or ownership, identity of interests amount family members, shared organization of a business entity following the ineligibility of a business entity under this Article, or using substantially the same management, ownership or principles as the ineligible entity.

Any person or entity who claims that this Article is inapplicable to him/her/it because a conviction or judgment has been reversed by a court of competent jurisdiction, shall prove the same with documentation satisfactory to Manatee County's Purchasing Official. Upon presentation of such satisfactory proof, the person or entity shall be allowed to contract with Manatee County.

I UNDERSTAND THAT ANY CONTRACT OR BUSINESS TRANSACTION SHALL PROVIDE FOR SUSPENSION OF PAYMENTS, OR TERMINATION, OR BOTH, IF THE PROCUREMENT DIVISION OR THE COUNTY ADMINISTRATOR DETERMINES THAT **SUCH PERSON OR ENTITY HAS MADE FALSE CERTIFICATION.**

[Signature]

STATE OF FLORIDA
COUNTY OF _____

Sworn to and subscribed before me this _____ day of _____, 201____ by_____.

Personally known _____ OR Produced identification _____
[Type of identification]

_____ My commission expires _____ Notary
Public Signature

[Print, type or stamp Commissioned name of Notary Public]

Signatory Requirement - In the case of a business entity other than a partnership or a corporation, this affidavit shall be executed by an authorized agent of the entity. In the case of a partnership, this affidavit shall be executed by the general partner(s). In the case of a corporation, this affidavit shall be executed by the corporate president.

**ATTACHMENT D
INSURANCE AND BOND REQUIREMENTS
RFO NO. 19-R068599OV**

Work under the resulting Agreement cannot commence until all insurance coverages indicated herein have been obtained. The cost for insurance coverages is the sole responsibility of successful Offeror. The Successful Offeror shall obtain and submit to the Procurement Division within ten (10) calendar days from the date of notice of intent to award, proof the following minimum amounts of insurance on a standard ACORD form (inclusive of any amounts provided by an umbrella or excess policy). **NOTE: Only those insurances and/or bonds designated with and “X” apply to work under the resulting Agreement).**

<u>STANDARD INSURANCES</u>	<u>REQUIRED LIMITS</u>
<p>1. <input checked="" type="checkbox"/> Automobile Liability Insurance:</p>	<p>Coverage must be afforded under a per occurrence policy form including coverage for all owned, hired and non-owned vehicles for bodily injury and property damage of not less than:</p> <ul style="list-style-type: none"> • \$ <u>1,000,000</u> Combined Single Limit; OR • \$ <u>500,000</u> Bodily Injury and \$ <u>500,000</u> Property Damage • \$ <u>10,000</u> Personal Injury Protection (No Fault) • \$ <u>500,000</u> Hired, Non-Owned Liability • \$ <u>10,000</u> Medical Payments <p><i>This policy shall contain severability of interests' provisions.</i></p>
<p>2. <input checked="" type="checkbox"/> Commercial General Liability Insurance:</p> <p><i>(Per Occurrence form only; claims-made form is not acceptable)</i></p>	<p>Coverage shall be afforded under a per occurrence policy form, policy shall be endorsed and name “Manatee County, a political subdivision of the State of Florida” as an Additional Insured, and include limits not less than:</p> <ul style="list-style-type: none"> • \$ <u>1,000,000</u> Single Limit Per Occurrence • \$ <u>2,000,000</u> Aggregate • \$ <u>1,000,000</u> Products/Completed Operations Aggregate • \$ 1,000,000 Personal and Advertising Injury Liability • \$ 50,000 Fire Damage Liability • \$ <u>10,000</u> Medical Expense, and • \$ <u>1,000,000</u>, Third Party Property Damage • \$ _____ Project Specific Aggregate (Required on projects valued at over \$<u>10,000,000</u>) <p><i>This policy shall contain severability of interests' provisions.</i></p>
<p>3. <input checked="" type="checkbox"/> Employer’s Liability Insurance</p>	<p>Coverage limits of not less than:</p> <ul style="list-style-type: none"> • \$ <u>100,000</u> Each Accident • \$ <u>500,000</u> Disease Each Employee • \$ <u>500,000</u> Disease Policy Limit
<p>4. <input checked="" type="checkbox"/> Worker’s Compensation Insurance</p>	<p>Coverage limits of not less than:</p> <ul style="list-style-type: none"> • Statutory workers’ compensation coverage shall apply for all employees in compliance with the laws and statutes of the State of Florida and the federal government.

<input type="checkbox"/> US Longshoremen & Harbor Workers Act Coverage <input type="checkbox"/> Jones Act Coverage	<ul style="list-style-type: none"> If any operations are to be undertaken on or about navigable waters, coverage must be included for the US Longshoremen & Harbor Workers Act and Jones Act. <p>Should 'leased employees' be retained for any part of the project or service, the employee leasing agency shall provide evidence of Workers' Compensation coverage and Employer's Liability coverage for all personnel on the worksite and in compliance with the above Workers' Compensation requirements.</p> <p>NOTE: Workers' Compensation coverage is a firm requirement. Elective exemptions are considered on a case-by-case basis and are approved in a very limited number of instances.</p>
<u>OTHER INSURANCES</u>	<u>REQUIRED LIMITS</u>
5. <input type="checkbox"/> Aircraft Liability Insurance	<p>Coverage shall be afforded under a per occurrence policy form, policy shall be endorsed and name 'Manatee County' a political subdivision of the State of Florida' as an Additional Insured, and include limits not less than:</p> <ul style="list-style-type: none"> \$ _____ Each Occurrence Property and Bodily Injury with no less than <u>\$100,000</u> per passenger each occurrence or a 'smooth' limit. \$ _____ General Aggregate
6. <input type="checkbox"/> Unmanned Aircraft Liability Insurance (Drone)	<p>Coverage shall be afforded under a per occurrence policy form, policy shall be endorsed and name 'Manatee County' a political subdivision of the State of Florida' as an Additional Insured, and include limits not less than:</p> <ul style="list-style-type: none"> \$ _____ Each Occurrence Property and Bodily Injury; Coverage shall specifically include operation of Unmanned Aircraft Systems (UAS), including liability and property damage. \$ _____ General Aggregate
7. <input type="checkbox"/> Installation Floater Insurance	<p>When the contract or agreement does not include construction of, or additions to, above ground building or structures, but does involve the installation of machinery or equipment, Installation Floater Insurance shall be afforded under a per occurrence policy form, policy shall be endorsed and name "Manatee County, a political subdivision of the State of Florida" as an Additional Insured, and include limits not less than:</p> <ul style="list-style-type: none"> 100% of the completed value of such addition(s), building(s), or structure(s)
8. <input type="checkbox"/> Professional Liability and/or Errors and Omissions (E&O) Liability Insurances	<p>Coverage shall be afforded under either an occurrence policy form or a claims-made policy form. If the coverage form is on a claims-made basis, then coverage must be maintained for a minimum of three years from termination of date of the contract. Limits must not be less than:</p> <ul style="list-style-type: none"> \$ _____ Bodily Injury and Property Damage Each Occurrence \$ _____ General Aggregate

<p>9. <input type="checkbox"/> Builder’s Risk Insurance</p>	<p>When the contract or agreement includes the construction of roadways and/or the addition of a permanent structure or building, including the installation of machinery and/or equipment, Builder’s Risk Insurance shall be afforded under a per occurrence policy form, policy shall be endorsed and name “Manatee County, a political subdivision of the State of Florida” as an Additional Insured, and include limits not less than:</p> <ul style="list-style-type: none"> • An amount equal to 100% of the completed value of the project, or the value of the equipment to be installed • The policy shall not carry a self-insured retention/deductible greater than \$10,000 <p>Coverage shall be for all risks and include, but not be limited to, storage and transport of materials, equipment, supplies of any kind whatsoever to be used on or incidental to the project, theft coverage, and Waiver of Occupancy Clause Endorsement, where applicable.</p>
<p>10. <input type="checkbox"/> Cyber Liability Insurance</p>	<p>Coverage shall comply with Florida Statute 501.171, shall be afforded under a per occurrence policy form, policy shall be endorsed and name “Manatee County, a political subdivision of the State of Florida” as an Additional Insured, and include limits not less than:</p> <ul style="list-style-type: none"> • \$_____ Security Breach Liability • \$_____ Security Breach Expense Each Occurrence • \$_____ Security Breach Expense Aggregate • \$_____ Replacement or Restoration of Electronic Data • \$_____ Extortion Threats • \$_____ Business Income and Extra Expense • \$_____ Public Relations Expense <p>NOTE: Policy must not carry a self-insured retention/deductible greater than <u>\$25,000</u>.</p>
<p>11. <input type="checkbox"/> Hazardous Materials Insurance (As Noted)</p>	<p>Hazardous materials include all materials and substances that are currently designated or defined as hazardous by the law or rules of regulation by the State of Florida or federal government.</p> <p>All coverage shall be afforded under either an occurrence policy form or a claims-made policy form, and the policy shall be endorsed and name “Manatee County, a political subdivision of the State of Florida” as an Additional Insured. If the coverage form is on a claims-made basis, then coverage must be maintained for a minimum of three years from termination of date of the contract. Limits must not be less than:</p> <p><input type="checkbox"/> Pollution Liability</p> <ul style="list-style-type: none"> • Amount equal to the value of the contract, subject to a <u>\$1,000,000</u> minimum, for Bodily Injury and Property Damage to include sudden and gradual release, each claim and aggregate.

	<input type="checkbox"/> Asbestos Liability (If handling within scope of Contract) <ul style="list-style-type: none"> Amount equal to the value of the contract, subject to a <u>\$1,000,000</u> minimum, for Bodily Injury and Property Damage to include sudden and gradual release, each claim and aggregate. <input type="checkbox"/> Disposal <p>When applicable, Successful Offeror shall designate the disposal site and furnish a Certificate of Insurance from the disposal facility for Environmental Impairment Liability Insurance covering liability.</p> <ul style="list-style-type: none"> Amount equal to the value of the contract, subject to a <u>\$1,000,000</u> minimum, for Liability for Sudden and Accidental Occurrences, each claim and an aggregate. Amount equal to the value of the contract, subject to a <u>\$1,000,000</u> minimum, for Liability for Non-Sudden and Accidental Occurrences, each claim and an aggregate.
12. <input type="checkbox"/> Hazardous Waste Transportation Insurance	<p>Successful Offeror shall designate the hauler and have the hauler furnish a Certificate of Insurance for Automobile Liability insurance with Endorsement MCS-90 for liability arising out of the transportation of hazardous materials. EPA identification number shall be provided.</p> <p>All coverage shall be afforded under either an occurrence policy form or a claims-made policy form and the policy shall be endorsed and name "Manatee County, a political subdivision of the State of Florida" as an Additional Insured. If the coverage form is on a claims-made basis, then coverage must be maintained for a minimum of three years from termination of date of the contract. Limits must not be less than:</p> <ul style="list-style-type: none"> Amount equal to the value of the contract, subject to a <u>\$1,000,000</u> minimum, per accident.
13. <input type="checkbox"/> Liquor Liability Insurance	<p>Coverage shall be afforded under a per occurrence policy form, policy shall be endorsed and name "Manatee County, a political subdivision of the State of Florida" as an Additional Insured, and include limits not less than:</p> <ul style="list-style-type: none"> <u>\$1,000,000</u> Each Occurrence and Aggregate
14. <input type="checkbox"/> Garage Keeper's Liability Insurance	<p>Coverage shall be required if the maintenance, servicing, cleaning or repairing of any County motor vehicles is inherent or implied within the provision of the contract.</p> <p>Coverage shall be afforded under a per occurrence policy form, policy shall be endorsed and name "Manatee County, a political subdivision of the State of Florida" as an Additional Insured, and include limits not less than:</p> <ul style="list-style-type: none"> Property and asset coverage in the full replacement value of the lot or garage.

<p>15. <input type="checkbox"/> Bailee's Customer Liability Insurance</p>	<p>Coverage shall be required for damage and/or destruction when County property is temporarily under the care or custody of a person or organization, including property that is on, or in transit to and from the person or organization's premises. Perils covered should include fire, lightning, theft, burglary, robbery, explosion, collision, flood, earthquake and damage or destruction during transportation by a carrier.</p> <p>Coverage shall be afforded under a per occurrence policy form, policy shall be endorsed and name "Manatee County, a political subdivision of the State of Florida" as an Additional Insured, and include limits not less than:</p> <ul style="list-style-type: none"> • Property and asset coverage in the full replacement value of the County asset(s) in the Successful Offeror's care, custody and control.
<p>16. <input type="checkbox"/> Hull and Watercraft Liability Insurance</p>	<p>Coverage shall be afforded under a per occurrence policy form, policy shall be endorsed and name "Manatee County, a political subdivision of the State of Florida" as an Additional Insured, and include limits not less than:</p> <ul style="list-style-type: none"> • \$ _____ Each Occurrence • \$ _____ General Aggregate • \$ _____ Fire Damage Liability • \$ <u>10,000</u> Medical Expense, and • \$ _____ Third Party Property Damage • \$ _____ Project Specific Aggregate (Required on projects valued at over \$10,000,000)
<p>17. <input type="checkbox"/> Other (Please Specify)</p>	

BOND REQUIREMENTS

<p>18. <input checked="" type="checkbox"/> Bid Bond</p>	<p>A Bid Bond in the amount of 5% of the total offer. Bid bond shall be submitted with the sealed response and shall include project name, location, and / or address and project number.</p> <p>In lieu of the bond, the bidder may file an alternative form of security in the amount of _____ in the form of a money order, a certified check, a cashier's check, or an irrevocable letter of credit issued to Manatee County.</p> <p>NOTE: A construction project over \$200,000 requires a Bid Bond in the amount of 5% of the total bid offer.</p>
<p>19. <input checked="" type="checkbox"/> Payment and Performance Bond</p>	<p>A Payment and Performance Bond shall be submitted by Successful Bidder for 100% of the award amount and shall be presented to Manatee County within ten (10) calendar days of issuance of the notice of intent to award.</p> <p>NOTE: A construction project over \$200,000 requires a Payment and Performance Bond.</p>

Approved: _____

Date: _____

INSURANCE REQUIREMENTS

I. THE POLICIES BELOW ARE TO CONTAIN, OR BE ENDORSED TO CONTAIN, THE FOLLOWING PROVISIONS:

1. Commercial General Liability and Automobile Liability Coverages

- a. **“Manatee County, a Political Subdivision of the State of Florida,” is to be named as an Additional Insured in respect to:** Liability arising out of activities performed by or on behalf of the Successful Offeror, his agents, representatives, and employees; products and completed operations of the Successful Offeror; or automobiles owned, leased, hired or borrowed by the Successful Offeror. The coverage shall contain no special limitation(s) on the scope of protection afforded to the County, its officials, employees or volunteers.

In addition to furnishing a Certificate of Insurance, the Successful Offeror shall provide the endorsement that evidences Manatee County being listed as an Additional Insured. This can be done in one of two ways: (1) an endorsement can be issued that specifically lists “Manatee County, a Political Subdivision of the State of Florida,” as Additional Insured; or, (2) an endorsement can be issued that states that all Certificate Holders are Additional Insured with respect to the policy.

- b. The Successful Offeror's insurance coverage shall be primary insurance with respect to the County, its officials, employees and volunteers. Any insurance or self-insurance maintained by the County, its officials, employees or volunteers shall be excess of Successful Offeror's insurance and shall be non-contributory.
- c. The insurance policies must be on an occurrence form, unless specifically noted otherwise.

2. Workers' Compensation and Employers' Liability Coverages

The insurer shall agree to waive all rights of subrogation against the County, its officials, employees and volunteers for losses arising from work performed by the Successful Offeror for the County.

II. GENERAL INSURANCE PROVISIONS APPLICABLE TO ALL POLICIES:

1. Prior to the execution of contract, or issuance of a Purchase Order, and then annually upon the anniversary date(s) of the insurance policy's renewal date(s) for as long as this contract remains in effect, Successful Offeror shall furnish the County with a Certificate(s) of Insurance (using an industry accepted certificate form, signed by the Issuer, with applicable endorsements, and containing the solicitation or contract number, and title or description) evidencing the coverage set forth above and naming “Manatee County, a Political Subdivision of the State of Florida” as an Additional Insured on the applicable coverage(s) set forth above. In addition, when requested in writing from the County, Successful Offeror will provide the County with a certified copy of all applicable insurance policies. The address where such certificates and certified policies shall be sent or delivered is as follows unless otherwise provided:

**Manatee County, a Political Subdivision of the State of Florida
Attn: Purchasing Division - Procurement
1112 Manatee Avenue West**

Bradenton, FL 34205

2. The project's solicitation number and title shall be listed on each Certificate of Insurance or policy.
 3. If the policy contains an aggregate limit, confirmation is needed in writing (letter, email, etc.) that the aggregate limit has not been eroded to procurement representative when supplying Certificate of Insurance.
 4. Successful Offeror shall provide thirty (30) days written notice of any cancellation, non-renewal, termination, material change, or reduction in coverage of any insurance policies to procurement representative including solicitation number and title with all notices.
 5. Successful Offeror agrees that should at any time Successful Offeror fail to meet or maintain the required insurance coverage(s) as set forth herein, the County may terminate this contract.
 6. The Successful Offeror waives all subrogation rights against Manatee County, a Political Subdivision of the State of Florida, for all losses or damages which occur during the contract and for any events occurring during the contract period, whether the suit is brought during the contract period or not.
 7. The Successful Offeror has sole responsibility for all insurance premiums and policy deductibles.
 8. It is the Successful Offeror's responsibility to ensure that his agents, representatives and subcontractors comply with the insurance requirements set forth herein. Successful Offeror shall include his agents, representatives, and subcontractors working on the project or at the worksite as insured under its policies, or Successful Offeror shall furnish separate certificates and endorsements for each agent, representative, and subcontractor working on the project or at the worksite. All coverages for agents, representatives, and subcontractors shall be subject to all the requirements set forth to the procurement representative.
 9. All required insurance policies must be written with a carrier having a minimum A.M. Best rating of A- FSC VII or better. In addition, the County has the right to review the Successful Offeror's deductible or self-insured retention and to require that it be reduced or eliminated.
- II. Successful Offeror understands and agrees that the stipulated limits of coverage listed herein in this insurance section shall not be construed as a limitation of any potential liability to the County, or to others, and the County's failure to request evidence of this insurance coverage shall not be construed as a waiver of Successful Offeror's obligation to provide and maintain the insurance coverage specified.
- III. Successful Offeror understands and agrees that the County does not waive its immunity and nothing herein shall be interpreted as a waiver of the County's rights, including the limitation of waiver of immunity, as set forth in Florida Statutes 768.28, or any other statutes, and the County expressly reserves these rights to the full extent allowed by law.
- IV. The enclosed Hold Harmless Agreement shall be signed by the Successful Offeror and shall become a part of the contract.
- V. No award shall be made until the Procurement Division has received the Certificate of Insurance and Hold Harmless Agreement in accordance with this section.

INSURANCE STATEMENT

THE UNDERSIGNED has read and understands the insurance requirements applicable to any contract resulting from this solicitation and shall provide the insurances required by this Attachment within ten (10) days from the date of Notice of Intent to Award.

Offeror Name: _____ Date: _____

Signature
(Authorized
Official): _____

Printed Name/Title: _____

Insurance Agency: _____

Agent Name: _____ Agent Phone: _____

Return this signed statement with your offer.

EXHIBIT "E"
AFFIDAVIT OF NO CONFLICT
RFO No. 18-68599OV

COUNTY OF _____
STATE OF _____

BEFORE ME, the undersigned authority, this ____ day of _____, 20__ personally appeared,
_____, a principal with full authority to bind
_____ (hereinafter the "Affiant"), who being first duly
sworn, deposes and says:

(a) is not currently engaged or will not become engaged in any obligations, undertakings or contracts that will require the Affiant to maintain an adversarial role against the County or that will impair or influence the advice, recommendations or quality of work provided to the County; and

(b) has provided full disclosure of all potentially conflicting contractual relationships and full disclosure of contractual relationships deemed to raise a question of conflict(s); and

(c) has provided full disclosure of prior work history and qualifications that may be deemed to raise possible question of conflict(s).

Affiant makes this affidavit for the purpose of inducing Manatee County, a political subdivision of the State of Florida, to enter into an Agreement for 18-R068599OV.

If applicable, on a separate page Bidder shall disclose the name of any officer, director or agent of Bidder who is also an employee of the County and the name of any County employee who owns, directly or indirectly, any interest in the Bidder's firm or any of its branches. If no conflicts of interest are present, submit a statement to that affect.

Signature

Print Name

SUBSCRIBED to and sworn before me this ____ day of _____, 20__.

[Notary Seal]

Notary Public

My commission expires: _____

Notary Signature

Print Name

Personally known OR produced identification. Type of identification produced _____

_____.

**SCOPE OF WORK
RFO NUMBER 18-R068599OV**

1.01 BACKGROUND INFORMATION

Studies show that in many communities, up to 50 percent of the scarce drinking water that flow through water meters each month is used to maintain landscape and turf grass. The Southwest Water Treatment Facility helps to reverse this process by extensive treatment and disinfection of the wastewater and provides residential irrigation to the citizens of Manatee County. In addition, many golf courses and farms throughout the county use reclaimed water thus saving even more potable water. The SWWRF is a 15 MGD (15 Million Gallon Plant / Day) facility. In order to continue to process this much water, all motor control panels, instrumentation and control equipment are required to run efficiently. Currently, two (2) motor control electrical pump panels for the Effluent Storage Lake Pumpback Stations need replacement. Detailed Scope of Work and general requirements are provided below.

Panels were placed into service approximately 17 years ago,

1.02 SCOPE

Successful Offeror shall provide a turn-key operation for the design, all shop drawings, working drawings, equipment, labor, materials, supplies, licensing, transportation, and other components necessary to provide replacement of two (2) Motor Control Panels for the Effluent Storage Lake Pumpback Stations at the Southwest Water Reclamation Facility with new UL listed VFD (Vertical Frequency Drive) Pump Control Panels. The PLC (Programmable Logic Controller) and HMI (Human Machine Interface) programming to be done by Owner.

The Project Scope includes the following:

- (1) Engineering design of duplex 75 HP VFD Pump Control Panels including instrumentation and control equipment.
- (2) Complete submittals including bill of material, equipment data sheets, and shop drawings
- (3) Complete as-built engineered computer aided design (CAD) shop drawings.
- (4) The panels will have EtherNet control of VFD by a CompactLogic controller communicating by Ethernet wireless radio to Plant SCADA.
- (5) Citech and Rockwell SCADA programming shall be performed by the Owner.
- (6) There is no bypass, motor thermals, leak, off delay timers, estop, and external motor disconnect needed for these panels. No HOAs or other controls on dead front except VFD keypads for manual control.
- (7) The door section main breaker shall have a disconnect and a dead front panel switch for the Maintenance Mode Main Breaker. Coordination of main breaker settings programmed by bidder. Add 20 amp 450v 3 phase beaker to one panel for Monitoring Well # 2 feed.
- (8) EtherNet radio to be mounted on existing DFS tower.
- (9) Provide VFD startup assistance and I/O / panel test report.
- (10) Field wires terminated from existing control panels will be identified and re-terminated into new panels. Owner will assist with lifting old panels, removal, and disposal.
- (11) New level and Flow meters are to be supplied by owner. Flow tubes to be installed by owner. Bidder to supply sunshields and install meter transmitters in sunshields, rewire with new conduit, conductors, and new tested grounding system. All discrete I/O is 24 VDC and analog is 4-20Ma. All I/O points both discrete and analog will be wired to individual surge

protectors.

(12) A *partial* parts list with details is provided in Section 1.06. Selected Offeror shall verify the needed panel size and component requirements. Panels must provide a complete functional unit.

1.03 GENERAL REQUIREMENTS

Successful Offeror shall provide the following requirements:

- A. Electrical Contractor License, minimum of 5 years' experience municipal and/or industrial experience performing this type of work.
- B. Registration with the Department of Business and Regulations.
- C. Qualifying Agent has been the same Qualifying Agent of the Offeror for a period of at least 5 years.
- D. All work is to be performed during normal working hours, Monday through Friday, 7:00 A.M. to 5:00 P.M. ET, holidays excluded.
- E. Four (4) copies of complete manuals for equipment and system.
- F. Warranty of Work from date of substantial completion.

1.04 SERVICE REQUIREMENTS

Successful Offeror's services shall include but not be limited to:

- A. Engineering design of duplex 75 HP VFD Pump Control Panels, including instrumentation and control equipment.
- B. Complete submittals including bill of material, equipment data sheets, and shop drawings.
- C. Complete as-built engineering CAD shop drawings.
- D. Panels will have EtherNet control of VFD by a CompactLogic controller communicating by Ethernet wireless radio to Plant SCADA system.
- E. Citech and Rockwell SCADA programming shall be performed by the Owner.
- F. There is no bypass, motor thermals, leak, off delay timers, estop, and external motor disconnect needed for these panels. No HOAs or other controls on dead front except VFD keypads for manual control.
- G. The door section main breaker shall have a disconnect and a dead front panel switch for the Maintenance Mode Main Breaker. Coordination of main breaker settings programmed by offeror. Add 20 amp 480V, 3 phase breaker to one panel for Monitoring Well #2 feed.
- H. EtherNet radio to be mounted on existing DFS (Data Flow System) tower.
- I. Provide VFD startup assistance and I/O (Input/Output) panel test report.
- J. Field wires terminated from existing control panels will be identified and re-terminated into new panels. Owner will assist with lifting old panels, removal, and disposal.
- K. New level and Flow Meters are to be supplied by Owner. Flow tubes to be installed by Owner. Successful Offeror shall supply sunshields and install meter transmitters in sunshields, rewire with new conduit, conductors, and new tested grounding system. All discrete I/O is 24 VDC and analog is 4-20 Ma. All I/O points both discrete and analog will be wired to individual surge protectors.
- L. An *incomplete* parts list (Exhibit 1, Scope of Work) is provided in this RFO to assist the Offeror in the process. Offeror shall *verify* needed panel size and component requirements. Panels must provide a complete functional unit.
- M. Successful Offeror shall verify all components for proper application, voltages, and current for this project and supply submittals for review before purchase.

N. Square D Motor Control Center Drawings (Exhibit 4) attached for reference. Information contained shall be verified by Offeror.

1.05 TECHNICAL REQUIREMENTS

Successful Offeror shall:

- A. Comply with National Electrical Code.
- B. Comply with all County, Federal, State and Local regulatory agencies.
- C. Comply with County Health Department regulations.
- D. Electrical Contractor shall self-perform over 60 percent of the total labor using his own workforce.
- E. Successful Offeror shall provide function and working panels

1.06 SPECIFICATIONS

Offeror shall provide a turn-key operation for the replacement of two motor control panels for the effluent storage lake pumpback stations at the SWWRF per the following specifications:

QTY PER PANEL	PART NO.	MANUFACTURER	DESCRIPTION
1			3 door Stainless Steel Enclosure, approximately 90" x90"x24" – Powder coated white, inside and out with deadfront on VFD side. Sunshields Front and Back.
As Required			Exhaust Fans and Internal Filter Racks – suited for VFD heat removal (Air Filter Spares) – POLYKLEAN WHITE 12" + 135" + ½"
2	357-035-120	AAF	Size to be determined
1	10HH2-T-STAT	Dayton	Fan Controller suited for VFD heat removal- CHKDB3250FT38WSERIES C, K-Frame Molded Case 250-amp Circuit Breaker – 65KA Trip Unit: 310 Plus Electronic ALSI Trip with Maintenance
1	CHKDB3250FT38W	Eaton or Equal	Mode
As Required			Panel Lighting
2	CIMR-PW4A0103FAA	YASKAWA	IQpump10D) 75HP VFD, 480 Volt NEMA 1 Wall Mount
2	SI-EN3	YASKAWA	Ethernet IP Card
2	UUX00527	YASKAWA	Door Keypad Mounting Kit (Keypad is removable)
2	V1K130A00	ABB or equal	Windings
2	KDRULH3L	ABB or equal	124 AMP Open Style Panel Mount Input Line Reactor 3% Dim: 9x 11 x 7.5 inches
1	ENH500	EnGenius Technologies	Outdoor Wireless Ethernet Bridge

1	TK-Ct2-CAT5E-POE	Total Protections Solutions	Surge Protection for CAT 6
1		CITEL or equal	480 VDC TVSS
1	HSP121BT-1RU	EDCO	110 Surge Arrestor
2			VFD Main Breakers – offset to deadfront
1			Control Transformer
As Required			Fusing and Circuit Breakers, as required
1	PRO 700	APC	UPS for PLC radio, meters, and Maintenance Bypass Switch
1	1769-L18ER-BB1B	Rockwell	Port, IGB SD Card, NoAxis CIP Motion
1	1734-IE4C	Rockwell	24V Dc 3 Channel High Density Analog Current Input Module, Allen-Bradley 1734-MB Point I/O Mounting Base, mounts directly on the DIN-rail and forms the interconnect for the POINTBus backplane communication and field power-bud distribution. The mechanical keying of the mounting base prevents incorrect module placement, Series A
1	1734-TB /SDN10-24-100P	Sola	Power Supply Output: 10A, 22.5-28.5VDC IN:85-264VAC Din Mount
2			Analog Signal Isolation
1	1761614	PHOENIX CONTACT	Industrial Ethernet Switch – FL SWITCH SFN 8TX
1			GFCI receptacle and breaker
2			Door Mounted HOA Switches
1		E & H	Level Meter
1		ABB	Mag Flow Meter
1			ARV installed before meter
1			Sunshield with room for 2 Meters 16” deep Powder coated White, inside and out, with standoff backplane for meters
1	LM-PP31A-18	Lightning Master	½” x 18” Aluminum Streamer Retarding Air Terminal w ½” Thread, ½” lock washer and jam nut – for above antenna
1	LM-FAB-Swivel-SS	Lightning Master	Universal Swivel Base w ½” Thread – Stainless Steel
1			Grounding rods and wire – 5 Ohms from panel and tower to ground NEC

Offeror shall verify all components for proper application, voltages, and current for this project and supply submittals for review before purchase.

1.07 **EXPECTED OUTCOMES OR DELIVERABLES / HOW PERFORMANCE WILL BE MEASURESED OR EVALUATED**

- A. Panels shall be shop-tested and inspected prior to shipment with documented results provided to the County.

- B. County will inspect and test the panels at the conclusion of the installation and prior to acceptance. Final payment will be held until the county's final acceptance is made.

[END OF EXHIBIT 1]

EXHIBIT 2
OFFER RESPONSE REQUIREMENTS
RFO NUMBER 18-R068599OV

This section identifies specific information which must be contained within the proposal and the order in which such information should be organized. The information each Offeror provides will be used to determine those Offerors with the background, experience and capacity to perform the scope of services as stated in this RFO and which Offer best meets the overall needs of the County. For more information on the evaluation process, refer to Section B, Evaluation of Offers.

2.01 INFORMATION TO BE SUBMITTED

The contents of each Offer will be organized and arranged with tabs in the same order as listed below and with the same TAB numbers. The Offer should contain sufficient detail to permit the County to conduct a meaningful evaluation. However, overly elaborate responses are not requested or desired.

2.02 OFFER FORMAT

- A.** The contents of the Offer package, if submitted in hard copy, must include one bound original, two bound copy(s), and one electronic format copy. The contents of the Offer package, if submitted electronically, must include one electronic format original.

NOTE: Electronic submissions should be submitted on a USB drive or compact disc in Microsoft Office® or Adobe Acrobat® PDF format **in one file** that includes all required TAB sections shown below in a continuous file. Do not submit proposal with separate files for each TAB section. Do not password protect or otherwise encrypt electronic submissions. For more information regarding submission of offers, refer to the Request for Offers, Section A.02, Submission of Offers.

B. TAB 1 - INTRODUCTION

Include the following in Tab 1 of the Offer.

1. A cover page that identifies Offeror, the RFO by title and the RFO number.
2. An introductory letter/statement that describe your proposal in summary form (limit 2 pages).
3. A table of contents.

C. TAB 2 – MINIMUM QUALIFICATION REQUIREMENTS

In Tab 2 submit the information and documentation requested that confirms Offeror meets the following minimum qualification requirement(s):

1. Offeror must possess a current, valid Certified and/or Registered Electrical License issued by the Florida Department of Business and Professional Regulations and as required by Florida Statutes, Chapter 489, for a period of five (5) consecutive years immediately prior to the Due Date and Time.

Provide a copy of Offeror’s Certified and/or Registered Electrical License issued by the Florida Department of Business and Professional Regulations.

2. Offeror (the business organization) has been in continuous existence, licensed and registered as required by Florida Division of Corporations to do business in Florida for at least five (5) consecutive years immediately prior to the Due Date and Time for submission of offers.

No documentation is required. The County will verify registration at www.sunbiz.org.

3. Offeror has a certified or registered Qualifying Agent, as required by Florida Statutes § 489.119, and that Qualifying Agent has been the same Qualifying Agent of the Bidder for a period of at least five (5) consecutive years.

No documentation is required. The County will verify offeror's annual reports at www.sunbiz.org.

4. Offeror has provided electrical services for at least five clients since June 1, 2011 in which each service included the replacement of an electrical motor control panel.

Provide the following information for each of the five qualifying clients:

- a) Name of client
- b) Location (City/State)
- c) Client contact name
- d) Contact phone
- e) Contact email
- f) Service dates (Start/End)

5. Offeror Is NOT listed on the Florida State Board of Administration, Scrutinized List of Prohibited Companies found at the SBAFLA website at <http://www.sbafla.com/fsb/FundsWeManage/FRSPensionPlan/PFIA/tabid/1478/ItemId/3354/Default.aspx>

No documentation is required. The County will verify.

6. Offeror has not been convicted of a public entity crime per Section 287.133, Florida Statutes or environmental law in the past five years.

Offeror must complete Attachment C and submit with its Offer attesting that it has not been convicted of a public entity crime or environmental law in the past five years.

7. If Offeror is submitting as a joint venture must file the required documents with the Florida Department of Business and Professional Regulation as required by Florida Statute Section 489.119, prior to the Due Date and Time.

If Offeror is a joint venture, provide a copy of Offeror's approved filing with the Florida Department of Business and Professional Regulation. If Offeror is not a joint venture, provide a statement to that effect.

8. Offeror has no reported conflict of interests in relation to this RFO.

Disclose the name of any officer, director or agent who is also an employee of the County. Disclose the name of any County employee who owns, directly or indirectly, any interest in the Offeror's firm or any of its branches. If no conflicts of interests are present, Offeror must submit a statement to that affect.

D. TAB 3 – FORMS

Provide the completed and executed Attachments included in this RFO in Tab 3.

1. Attachment A, Acknowledgement of Addenda Form
2. Attachment B, Offer Signature Form
3. Attachment C, Public Contracting and Environmental Crimes Certification Form
4. Attachment D, Insurance and Bond Requirements
5. Attachment E, Affidavit of No Conflict
6. Exhibit 2, Fee Form

E. TAB 4 - TRADE SECRETS

Pursuant to Section A.24, Trade Secrets, identify any trade secret being claimed in TAB 4.

NOTE: Designation of the entire Proposal as "Trade 'Secret', 'Proprietary' or 'Confidential' is not permitted and may result in a determination that the Proposal is non-responsive and therefore will not be evaluated or considered. Offeror must submit purported trade secret information as follows:

1. Trade secret material must be segregated from the portions of the Offer that are not being declared as trade secret. NOTE: Trade secret requests made after the Due Date and Time are not allowed.
2. Offeror shall cite, for each trade secret claimed, the Florida Statute number which supports the designation. Further, Proposer shall offer a brief written explanation as to why the cited Statute is applicable to the information claimed as trade secret.
3. Offeror shall provide an additional hard copy and electronic copy of its proposal that redacts all designated trade secrets.

F. TAB 5 - OFFEROR STATEMENT OF ORGANIZATION

In Tab 5, provide information and documentation on Offeror as follows:

1. Legal contracting name including any dba.
2. State of organization or incorporation.
3. Ownership structure of Offeror's company.
(e.g., Sole Proprietorship, Partnership, Limited Liability Corporation, Corporation)
4. Contact information for Offeror's corporate headquarters and local office (if different)
NOTE: local is defined as Manatee, DeSoto, Hardee, Hillsborough, Pinellas or Sarasota counties. Include the following:
 - (a) Address
 - (b) City, State, Zip
 - (c) Phone
 - (d) Number of years at the location
5. List of officers, owners and/or partners, or managers of the firm. Include names, business addresses, email addresses, and phone numbers.
6. Contact information for Offeror's primary and secondary representatives during this RFO process to include the following information:

- (a) Name
 - (b) Phone
 - (c) E-mail
 - (d) Mailing Address
 - (e) City, State, Zip
7. Provide a brief summary regarding any **prior or pending litigation**, either civil or criminal, involving a governmental agency or which may affect the performance of the services to be rendered herein, in which the Offeror, any of its partners, employees or subcontractors is or has been involved within the last three years.
 8. Provide details of any ownership changes to Offeror's organization in the past three years or changes anticipated within six months of the Due Date and Time (e.g., mergers, acquisitions, changes in executive leadership).

G. TAB 6 – OFFEROR AND TEAM’S EXPERIENCE

In Tab 6, provide details of Offeror and its team's experience to include the following:

1. Provide a summary of Offeror's background, size and years in business.
2. Provide Offeror's years of experience in engineering design as well as installation and rehabilitation of motor control panels, including instrumentation and control equipment services, particularly for other government agencies.
3. Identify and include information regarding experience and qualifications of Offeror's key staff to be assigned to the services. Include a resume for each with their full names, the name of the firm(s) for their current and previous employers for the past ten years, professional credentials (e.g., certifications and/or licenses), and roles and duties which the individuals will provide to the County. Include the address of their current primary office location, email address and phone number.
4. Identify any proposed sub-contractors to accomplish the work. Include the name of the individual(s) to be assigned, and an overview of their experience and qualifications related to electrical services and motor control panels.
5. Describe any significant or unique accomplishments or recognition received by Offeror or its subcontractors in previous similar services.
6. Provide a minimum of five client references for services, similar in scope as defined in this RFO, who are agreeable to responding to an inquiry by the County. References should include the following information:
 - a. Client name
 - b. Client address
 - c. Client contact name
 - d. Client contact phone numbers
 - e. Client contact email address
 - f. Brief description of services provided (1-2 sentences)
 - g. Performance period (start/end dates)

H. TAB 7 - CAPACITY

Provide the following information regarding Offeror's capacity for the provision of services.

1. Details of Offeror's staffing resources, at the location that will provide services to the County as well as corporately; by discipline and the number of personnel within each discipline.
2. Offeror's staffing resources includes sub-contractors, submit the name of the firm(s) who will perform each discipline.
3. Detail how subcontractors will be used and to what extent.

4. An organizational diagram clearly identifying key personnel (e.g., manager, supervisor, foreman) who are designated to provide services to the County and indicate their functional relationship to each other.
5. Describe Offeror's plans, policies, and/or strategies in which County citizens would receive consideration for employment and county suppliers of goods and services would be utilized.
6. If Offeror is teaming with other entities (subcontractors or joint venture) to provide the required goods and services, detail any prior similar work any two or more team members have jointly performed.
7. If a joint venture is proposed, provide an affidavit attesting to the formulation of the joint venture and provide proof of incorporation as a joint venture or a copy of the formal joint venture agreement between all joint venture parties, indicating their respective roles, responsibilities, and levels of participation in the project.
8. An explanation, in general terms, of Offerors' financial capacity to perform the scope of services. If Offeror is filing a proposal as a joint venture, details must be provided to demonstrate financial capacity of each entity.
9. Provide a statement on company letterhead and signed by a company official authorizing a County auditor and/or financial analysts access to your financial records, including all records prepared by an independent firm, or the financial records of other entities for which you have ownership interest. Such access will occur at the primary location of the Offeror, or such other location as may be agreed, for the purposes of verifying financial representations, and/or to review and assess the historical and current financial capacity of Offeror's business entity and its expected ability to meet ongoing financial obligations related to the required services, if awarded a contract. If an audit is conducted, the County's audit and/or financial analysts will report their findings in a summary report to the Procurement Official, which will be placed in the proposal files for subsequent use, review, and discussions during evaluations.
10. Disclose any ownership interest in other entities proposed for goods or services. This ownership disclosure includes ownership by the Offeror through a parent, subsidiary or holding company or any other form of business entity.
11. Detail Offeror and any subcontractor's current workloads and any projected changes to the workload within the next six months.

I. TAB 9 – APPROACH

Provide Offeror's project approach to include the following:

1. A narrative of Offeror's approach to project management.
2. Details of implementation plan and schedule for work specified.
3. A narrative that clearly demonstrate Offeror's ability and willingness to meet schedule and budget requirements.
4. Provide a narrative of the proposed approach and methodology for engaging with County representatives in-the-course of performing the duties.
5. Offeror's Risk Management Plan that includes a list of risks related to the provision of services, the potential consequences or impact of each (e.g., cost, schedule, technical) and Offeror's proposed mitigation procedures for each item.
6. The County is deeply committed to respecting the environment and providing a safe work environment. Include a detailed description of the Offeror's safety plan and strategies to control the environment of the work site during on site operations.
7. Provide sample reports of equipment testing to be performed as part of the services.

J. FEES PROPOSAL

Offerors should use the Fees form on the following page for submitting its Fees. Fees must be submitted as all-inclusive to provide removal and replacement of two pump panels at the Southwest Water Reclamation Facility (SWWRF), Lake Pumpback Stations in accordance with the requirements set forth in this RFO.

Submit one hard copy original and one duplicate hard copy of the Fees form in a separate envelope labeled 'Fees' with the Offeror's name clearly marked on the outside of the package. Include Offeror's Fees form with the original hard copy of the offer response. Do Not include a copy of the Fees form in the duplicate hard copy.

Offeror's fees shall remain firm for a minimum of 120 calendar days from the execution of the Agreement.

[Remainder of page intentionally left blank]

**EXHIBIT 2
FEES FORM
RFO NUMBER 18-R068599OV**

. Provide a full detailed breakdown of Lump Sum prices to provide a turn-key operation for the Replacement of Two Motor Control Panels including design, permitting, labor, material, equipment and electrical services at the at the Southwest Water Reclamation Facility (SWWRF) Lake Pumpback Stations.

Offeror shall provide a detailed Schedule of Value breakdown for each item.

Item No.	Description	U/M	EST. QTY	UNIT PRICE	EXTENDED PRICE
1	Mobilization/Demobilization	LS	1	\$	\$
2	Removal / Replacement of two (2) Motor Control Panels at the SWWRF	LS	1	\$	\$
3	Design, Shop Drawings, Working Drawings2) Motor Control Panels	LS	1	\$	\$
	TOTAL BASE BID				\$
	Contract Contingency Work (Used only with County Approval)	10%			\$
	Total Offer for Bid with Contract Contingency				\$

Project Shall be completed within _____ calendar days from the date of commencement.

END EXHIBIT 2



AGREEMENT No. 18-R068599OV

**Replace Motor Control Panels for Effluent Storage Lake Pumpback
Stations, SWWRF**

between

**MANATEE COUNTY
(COUNTY)**

and

(CONSULTANT)

**AGREEMENT FOR Remove Replacement Motor Control Panels for Effluent Storage
Lake Pumpback Stations, SWWRF]**

THIS AGREEMENT is made and entered into as of this _____ day of _____, 2018, by and between **MANATEE COUNTY**, a political subdivision of the State of Florida, (“**COUNTY**”), with offices located at 1112 Manatee Avenue West, Bradenton, Florida 34205, and [**INSERT COMPANY NAME**], a [Company/Corporation], (“**CONSULTANT**”) with offices located at [Insert address], and duly authorized to conduct business in the State of Florida. COUNTY and CONSULTANT are collectively referred to as the “Parties” and individually as “Party.”

WHEREAS, CONSULTANT engages in the business of providing [INSERT TYPE OF SERVICE]; and

WHEREAS, COUNTY has determined that it is necessary, expedient and in the best interest of COUNTY to retain CONSULTANT to render the professional services described in this Agreement; and

WHEREAS, this Agreement is a result of CONSULTANT’S submission of a proposal in response to Request for Proposal No. [INSERT RFP NUMBER] and COUNTY thereafter conducted a competitive selection process in accordance with the Manatee County Procurement Code.

NOW, THEREFORE, the COUNTY and CONSULTANT, in consideration of the mutual covenants, promises, and representations contained herein, the sufficiency of which is hereby acknowledged, the Parties hereto agree as follows:

ARTICLE 1. SCOPE OF SERVICES

CONSULTANT shall provide professional services as described in Exhibit A, Scope of Services. “Task” as used in this Agreement, refers to particular categories/groupings of services specified in Exhibit A.

ARTICLE 2. EXHIBITS INCORPORATED

This Agreement consists of a primary contract and <number> exhibits, which are as follows:

- Exhibit A** Scope of Services
- Exhibit B** Fee Rate Schedule
- Exhibit C** Work Assignment
- Exhibit D** Affidavit of No Conflict
- Exhibit E** Insurance and Bond Requirements

These Exhibits are attached hereto and are incorporated into this Agreement. In the event of a conflict between the terms and conditions provided in the Articles of this Agreement and any Exhibit, the provisions contained within these Articles shall prevail unless the Exhibit specifically states that it shall prevail.

ARTICLE 3. AGREEMENT TERM

- A. This Agreement shall commence on the date of execution by COUNTY (“Effective Date”). This Agreement shall remain in force until all Work Assignments issued during the effective period of this Agreement are completed, unless terminated by COUNTY pursuant to Article 12, but not to exceed [INSERT NUMBER OF YEARS].
- B. COUNTY reserves the right to extend the initial term of [NUMBER OF YEARS] for an additional [NUMBER OF YEARS] not to exceed a total of [NUMBER OF YEARS].

ARTICLE 4. COMPENSATION

- A. Compensation payable to CONSULTANT for services rendered and expenditures incurred in providing the services specified in Exhibit A shall be established for each written Work Assignment issued in accordance with Article 9.
- B. Compensation to CONSULTANT shall be based on actual hours performed times fee rate of the individual performing the work, plus reimbursable expenses up to the maximum compensation authorized for each Work Assignment.
- C. The fee rates specified in Exhibit B shall be the total compensation for services and shall contain all costs to include salaries, office operation, transportation, equipment, overhead, general and administrative, incidental expenses, fringe benefits and operating margin.

ARTICLE 5. INVOICES AND TIME OF PAYMENT

- A. Subject to the provisions of this Agreement, COUNTY shall pay CONSULTANT for the services specified in **Exhibit A** at a rate of compensation according to the deliverable payment schedule stated in **Exhibit B**.
- B. COUNTY shall approve of all invoices prior to payment.
- C. When CONSULTANT seeks payment for any deliverable or reimbursable expense, it shall provide COUNTY with an invoice that includes a description of authorized work performed and/or expense incurred, and the total unpaid compensation CONSULTANT represents as being due and owing as of the invoice date. All invoices shall include the Integrated Fund Accounting System (IFAS) number which COUNTY shall assign to this Agreement and will be provided to CONSULTANT in writing, upon execution of this Agreement.
- D. If any Task requires units of deliverables, such units must be received and accepted in writing by the COUNTY prior to payment.

- E. COUNTY shall have forty-five (45) days from the receipt of an invoice seeking payment of fees or costs to either pay the invoice, or notify CONSULTANT that the deliverable, or any part thereof, is unacceptable, and/or that any asserted expense is not reimbursable.
- F. COUNTY shall have the right to retain from any payment due CONSULTANT under this Agreement, an amount sufficient to satisfy any amount of liquidated damages due and owing to COUNTY by CONSULTANT on any other Agreement between CONSULTANT and COUNTY.
- G. If any Work Assignment requires units of deliverables, then such units must be received and accepted in writing by the COUNTY prior to payment.
- H. All costs of providing the services shall be the responsibility of CONSULTANT, with the exception of reimbursement by COUNTY for costs deemed reimbursable in Exhibit B.
- I. Any dispute between COUNTY and CONSULTANT with regard to the percentage of the Work Assignment that has been completed or CONSULTANT'S invoice shall be resolved pursuant to the dispute resolution procedures established by Manatee County Procurement Code and Article 14 of this Agreement.

ARTICLE 6. RESPONSIBILITIES OF CONSULTANT

- A. CONSULTANT shall appoint an Agent with respect to the services to be performed by CONSULTANT pursuant to this Agreement. CONSULTANT'S Agent shall have the authority to make representations on behalf of CONSULTANT, receive information, and interpret and define the needs of CONSULTANT and make decisions pertinent to services covered by this Agreement. CONSULTANT'S Agent shall have the right to designate other employees of CONSULTANT to serve in his or her absence. CONSULTANT reserves the right to designate a different agent, provided that COUNTY is given advance written notice thereof.
- B. CONSULTANT shall perform the work in accordance with the terms and conditions of this Agreement.
- C. CONSULTANT shall ensure that all employees assigned to render services under this Agreement are duly qualified, registered, licensed or certified to provide the services required.
- D. CONSULTANT shall be responsible for collecting all existing data required for the successful completion of each task.
- E. CONSULTANT shall not engage in any obligations, undertakings, contracts or professional obligations that create a conflict of interest, or even an appearance of a conflict of interest, with respect to the services provided pursuant to this Agreement. CONSULTANT attests to this via an Affidavit of No Conflict, **Exhibit D**.

- F. CONSULTANT shall be entitled to rely upon information provided from COUNTY. Information includes, but is not limited to, additional services, consultations, investigations, and reports necessary for the execution of CONSULTANT'S work under this Agreement. CONSULTANT shall be fully responsible for verifying, to the extent practicable, documents and information provided by COUNTY and identifying any obvious deficiencies concerning the documents and information provided. CONSULTANT shall notify COUNTY of any errors or deficiencies noted in such information provided and assist, to the extent practicable, COUNTY in the identification and resolution of same. CONSULTANT agrees to incorporate the provisions of this paragraph in any subcontract into which it might enter with reference to the work performed under this Agreement.
- G. CONSULTANT shall be responsible for the professional quality technical accuracy, and the coordination of all designs, drawings, specifications, and other services furnished by CONSULTANT under this Agreement. CONSULTANT shall, without additional compensation, correct or revise any errors or deficiencies in its designs, drawings, specifications, and other services.
- H. CONSULTANT shall maintain an adequate and competent staff of professionally qualified persons during the term of this Agreement for the purpose of rendering the required services hereunder. CONSULTANT shall not sublet, assign or transfer any services under this Agreement without prior written consent of COUNTY.
- I. COUNTY may require in writing that CONSULTANT remove from the project any of CONSULTANT'S personnel that COUNTY determines to be incompetent, careless or otherwise objectionable. No claims for an increase in compensation or agreement term based on COUNTY'S use of this provision will be valid.

ARTICLE 7. RESPONSIBILITIES OF COUNTY

- A. COUNTY shall, through its County Administrator, appoint an individual to serve as County Representative. The County Representative shall have the authority to transmit instructions, receive information, interpret and define the policy of COUNTY and make decisions pertinent to services covered by this Agreement. COUNTY reserves the right to designate a different County Representative, provided that CONSULTANT is given written notice thereof.
- B. COUNTY shall make available, at no cost to CONSULTANT, information relative to the project that is useful in the performance of the Scope of Services.
- C. COUNTY shall provide prompt notice to CONSULTANT whenever COUNTY observes or otherwise becomes aware of any defect in the performance of work under this Agreement.
- D. COUNTY shall give careful and reasonable consideration to the findings and recommendations of CONSULTANT, and shall respond and issue notices to proceed in a timely manner.

- E. COUNTY personnel shall be available on a time-permitting basis, where required and necessary to assist CONSULTANT. The availability and necessity of said personnel to assist CONSULTANT shall be at the discretion of COUNTY.
- F. COUNTY shall perform the responsibilities enumerated in this Article at no cost to CONSULTANT.

ARTICLE 8. COUNTY'S PROJECT MANAGER

The Project Manager, shall be appointed to represent COUNTY in all technical matters pertaining to and arising from the work and performance of this Agreement. The Project Manager shall have the following responsibilities:

- A. The examination of all reports, sketches, drawings, estimates, proposals, and any other documents provided by CONSULTANT.
- B. Providing CONSULTANT written decisions of COUNTY'S approval or disapproval of these documents within a reasonable time.
- C. Transmission of instructions, receipt of information, and interpretation of COUNTY policies and decisions with respect to design, materials and other matters pertinent to the services provided under this Agreement.
- D. Provide CONSULTANT with prompt written notice whenever COUNTY observes, or otherwise becomes aware of, any defects or changes necessary in a project.

ARTICLE 9. WORK ASSIGNMENTS

- A. CONSULTANT shall provide services only after receipt of a written Work Assignment issued in accordance with this Article and in accordance with the form provided in **Exhibit C**. Work Assignments shall be signed by CONSULTANT and COUNTY and shall constitute supplemental agreements entered into under the terms and conditions of this Agreement.
- B. Each Work Assignment shall establish the following:
 - 1. A title for the project and a general description of the purpose for the work.
 - 2. From the services listed in **Exhibit A**, the specific services to be provided under the Work Assignment and any additional information necessary to describe the nature of these services.
 - 3. The services that will be furnished for a fixed fee and the services to be furnished based upon time and charges provided.
 - 4. The maximum total compensation and reimbursable expenses that will be paid to

CONSULTANT by COUNTY upon completion of the Work Assignment.

5. An agreed upon date of completion for each Work Assignment. Where identified services within a Work Assignment must be completed by a specific date prior to the completion of the entire Work Assignment, such date shall be stated in the Work Assignment.
 6. Additional duties and obligations of the Parties with respect to a Work Assignment that are not provided for in this Agreement.
 7. The identification of the person(s) who will serve as CONSULTANT'S Project Manager and COUNTY'S Project Manager for the Work Assignment.
- C. When a Work Assignment calls for the preparation of plans, specifications, maps and reports, these items as well as all data collected, together with summaries and charts of said date, shall be considered works made for hire and shall become the property of COUNTY without restriction or limitation on their use; and shall be made available, upon request, to COUNTY at any time. CONSULTANT shall not copyright any material or product developed under this Agreement.
- D. All final plans, documents, reports, studies and other data prepared by CONSULTANT shall bear the endorsement of a person in the full employ of CONSULTANT.
- E. It shall be the responsibility of CONSULTANT to ensure that all projects and services are completed timely. If the completion of a project or service is expected to be delayed, CONSULTANT shall promptly submit a written request to the Project Manager which identifies the reason(s) for the delay and the amount of time related to each reason. The Project Manager will promptly review the request and make a determination as to granting all or part of the requested extension. If the Project Manager determines that an extension of a Work Assignment deadline is appropriate, a recommendation for a Change Order shall be initiated.
- F. Any Work Assignment, including reimbursable expenses, shall not be effective until approved and executed by the County.
- G. When a Work Assignment is complete, CONSULTANT shall notify COUNTY in writing. Thereupon COUNTY, within thirty (30) days, shall either provide its written acceptance or give CONSULTANT written notice of any unfinished or improperly performed services to be finished or corrected. If such written notice of acceptance or exception is not given within this period of time, the services shall be deemed to have been accepted by COUNTY. However, acceptance of the work performed by CONSULTANT shall never be construed as an acceptance of improper, defective or deficient work.

ARTICLE 10. NEGOTIATION OF WORK ASSIGNMENT

For each project, grouping of substantially similar services and activities for a group of projects, feasibility studies or special projects, COUNTY shall negotiate each Work Assignment based

upon estimated hours and/or fee rates, projected by CONSULTANT and in accordance with the rate schedule specified in **Exhibit B**. Compensation for each Work Assignment shall be based on actual hours performed and/or fee rates, but in no event shall CONSULTANT be eligible for reimbursement in excess of the amount established in a Work Assignment. COUNTY'S Purchasing Official may authorize, in writing, in advance, adjustments in the compensation for particular phases or tasks established in the Work Assignment provided such adjustments do not exceed the maximum compensation and reimbursable expenditures authorized for the particular Work Assignment.

ARTICLE 11. COUNTY OWNERSHIP OF WORK PRODUCT

The Parties agree that COUNTY shall have exclusive ownership of all reports, documents, designs, ideas, materials, reports, concepts, plans, creative works, and other work product developed for or provided to COUNTY in connection with this Agreement, and all patent rights, copyrights, trade secret rights and other intellectual property rights relating thereto (collectively "the Intellectual Property"). CONSULTANT hereby assigns and transfers all rights in the Intellectual Property to COUNTY. CONSULTANT further agrees to execute and deliver such assignments and other documents as COUNTY may later require to perfect, maintain and enforce COUNTY'S rights as sole owner of the Intellectual property, including all rights under patent and copyright law.

ARTICLE 12. TERMINATION OF AGREEMENT

A. TERMINATION FOR CAUSE:

1. COUNTY shall have the right, by written notice to CONSULTANT, to terminate this Agreement, in whole or in part, for failure to substantially comply with the terms and conditions of this Agreement (Work Assignments, if applicable), to include:
 - a. Failure to provide products or services that comply with the specifications herein or that fail to meet COUNTY'S performance standards;
 - b. Failure to deliver the supplies or perform the services within the time specified in the Work Assignments; or
 - c. Progress that is at a rate that disrupts the overall performance of this Agreement.
2. Prior to termination for default, COUNTY shall provide adequate written notice to CONSULTANT, affording CONSULTANT the opportunity to cure the deficiencies or to submit a specific plan to resolve the deficiencies within ten (10) days (or the period specified in the notice) after receipt of the notice. Failure to adequately cure the deficiency shall result in termination action.
3. Such termination may also result in suspension or debarment of CONSULTANT in accordance with Manatee County's Procurement Ordinance, Chapter 2-26. CONSULTANT shall be liable for any damage to COUNTY resulting from

CONSULTANT'S default of the Agreement. This liability includes any increased costs incurred by COUNTY in completing contract performance.

4. In the event of termination of this Agreement, CONSULTANT shall be liable for any damage to COUNTY resulting from CONSULTANT'S default of this Agreement. This liability includes any increased costs incurred by COUNTY in completing performance under this Agreement.
5. In the event of termination by COUNTY for any cause, CONSULTANT shall not have any right or claim against COUNTY for lost profits or compensation for lost opportunities. After a receipt of COUNTY'S Notice of Termination and except as otherwise directed by COUNTY, CONSULTANT shall:
 - a. Stop work on the date and to the extent specified;
 - b. Terminate and settle all orders and subcontracts relating to the performance of the terminated work;
 - c. Transfer all work in process, completed work, and other materials related to the terminated work as directed by COUNTY; and
- b. Continue and complete all parts of that work that have not been terminated.

B. TERMINATION WITHOUT CAUSE:

COUNTY may terminate this Agreement, in whole or in part, or individual Work Assignments without cause. COUNTY shall provide CONSULTANT a written "Notice of Intent to Terminate" thirty (30) days prior to the date of termination. If this Agreement is terminated by the COUNTY without cause, CONSULTANT shall be entitled to payment for all services performed to the satisfaction of the COUNTY and all expenses incurred under this Agreement prior to termination, less any costs, expenses or damages due to the failure of the CONSULTANT to properly perform pursuant to this Agreement. CONSULTANT shall not be entitled to any other compensation, including anticipated profits on unperformed services.

ARTICLE 13. TRANSITION SERVICES UPON TERMINATION

Upon termination or expiration of this Agreement, CONSULTANT shall cooperate with COUNTY to assist with the orderly transfer of the services provided by CONSULTANT to COUNTY. Prior to termination or expiration of this Agreement, COUNTY may require CONSULTANT to perform and, if so required, CONSULTANT shall perform, certain transition services necessary to shift the services of CONSULTANT to another provider or to COUNTY itself as described below (the "Transition Services"). The Transition Services may include but shall not be limited to:

- A. Working with COUNTY to jointly develop a mutually agreed upon Transition Services plan to facilitate the termination of the services;

- B. Executing the Transition Services plan activities;
- C. Answering questions regarding the services on an as-needed basis; and
- D. Providing such other reasonable services needed to effectuate an orderly transition to a new service provider or to COUNTY.

ARTICLE 14. DISPUTE RESOLUTION

Disputes shall be resolved in accordance with the Manatee County Purchasing Code (Chapter 2-26 of the Manatee County Code of Ordinances). Any dispute resolution constituting a material change in this Agreement shall not be final until an amendment to this Agreement has been approved and executed by the County Purchasing Official. If such dispute involves the percentage of the work completed by CONSULTANT, COUNTY shall, as promptly and reasonably as possible after resolution of such dispute, forward payment to CONSULTANT of any amount that is determined to be owed by the COUNTY.

CONSULTANT agrees it must exhaust all dispute resolution procedures set forth in Manatee County's Purchasing Code prior to instituting any action in state or federal court or before any administrative agency or tribunal.

ARTICLE 15. COMPLIANCE WITH LAWS

All services rendered or performed by CONSULTANT pursuant to the provisions of this Agreement shall be in compliance with all applicable local, state and federal laws and ordinances. CONSULTANT shall have and keep current at all times during the term of this Agreement all licenses and permits as required by law.

ARTICLE 16. NON-DISCRIMINATION

CONSULTANT shall not discriminate against any employee or applicant for employment because of race, color, sex, creed, national origin, disability or age, and will take affirmative action to ensure that all employees and applicants are afforded equal employment opportunities without discrimination because of race, color or national origin. Such action will be taken with reference to, but shall not be limited to, recruitment, employment, job assignment, promotion, upgrading, demotion, transfer, layoff or termination, rates of training or retraining (including apprenticeship and on-the-job training).

No person in the United States shall, on the grounds of race, color or national origin be excluded from participation in, be denied the proceeds of, or be subject to discrimination in the performance of this Agreement.

ARTICLE 17. MAINTENANCE OF RECORDS; AUDITS; LICENSES

- A. CONSULTANT shall maintain records, accounts, property records, and personnel records in accordance with generally accepted accounting principles, as deemed necessary by COUNTY to assure proper accounting of funds and compliance with the provisions of this Agreement.
- B. CONSULTANT shall provide COUNTY all information, reports, records and documents required by this Agreement or by COUNTY ordinances, rules or procedures, or as needed by COUNTY to monitor and evaluate CONSULTANT'S performance. Such materials shall also be made available to COUNTY upon request for auditing purposes. Inspection or copying will occur during normal business hours, and as often as COUNTY may deem necessary. COUNTY shall have the right to obtain and inspect any audit pertaining to the performance of this Agreement or CONSULTANT made by any local, state or federal agency. To the extent such materials are in the possession of a third party, CONSULTANT must obtain them from that third party, or certify in writing to COUNTY why it was unable to do so. CONSULTANT shall retain all records and supporting documents related to this Agreement in accordance with all applicable laws, rules and regulations, and, at a minimum, retain all records and supporting documents related to this Agreement, except duplicate copies or drafts, for at least three (3) years after the termination date.
- C. CONSULTANT shall obtain any licenses required to provide the Scope of Services and maintain full compliance with any licensure requirements. Copies of reports provided to or by any licensing or regulatory agency shall be forwarded to COUNTY within ten (10) days of receipt by CONSULTANT. CONSULTANT shall immediately notify COUNTY if the required licenses of any of its principles or agents working on this Agreement are terminated, suspended, revoked or are otherwise invalid and/or are no longer in good standing.

ARTICLE 18. PUBLIC RECORDS

Pursuant to Florida Statutes §119.0701, to the extent CONSULTANT is performing services on behalf of COUNTY, CONSULTANT shall:

- A. Keep and maintain public records that would ordinarily be required by COUNTY to perform the service.
- B. Upon request from COUNTY'S custodian of public records, provide COUNTY with a copy of the requested records or allow the records to be inspected or copied within a reasonable time at a cost that does not exceed the cost provided in Chapter 119, Florida Statutes, or as otherwise provided by law.
- C. Ensure that public records that are exempt or confidential from public records disclosure requirements are not disclosed except as authorized by law for the duration of this Agreement and following completion of this Agreement if CONSULTANT does not transfer the records to COUNTY.

D. Upon completion of this Agreement, transfer, at no cost, to COUNTY all public records in possession of CONSULTANT or keep and maintain public records required by COUNTY to perform the service. If CONSULTANT transfers all public records to COUNTY upon completion of this Agreement, CONSULTANT shall destroy any duplicate public records that are exempt or confidential and exempt from public records disclosure requirements. If CONSULTANT keeps and maintains public records upon completion of this Agreement, CONSULTANT shall meet all applicable requirements for retaining public records. All records stored electronically must be provided to COUNTY, upon request from COUNTY'S custodian of public records, in a format that is compatible with the information technology systems of COUNTY.

IF CONSULTANT HAS QUESTIONS REGARDING THE APPLICATION OF CHAPTER 119, FLORIDA STATUTES, TO COUNTY'S DUTY TO PROVIDE PUBLIC RECORDS RELATING TO THIS AGREEMENT, CONTACT THE CUSTODIAN OF PUBLIC RECORDS AT:

Phone: 941.742.5845

Email: Debbie.Scaccianoce@mymanatee.org

**Mail or hand delivery:
Attn: Records Manager
1112 Manatee Avenue West
Bradenton, FL 34205**

ARTICLE 19. INDEMNIFICATION

Each Party shall defend, indemnify, and hold harmless the other, its officers, employees and agents, from any and all third-party claims, liabilities, loss, or cause of action of property damage or bodily injury, including death, arising out of any negligent actions or omissions of the indemnifying party, its agents, officers, employees or agents in the performance of this Agreement, including without limitation, defects in design, or errors or omissions that result in material cost increases to the indemnified party. Such indemnification shall include, but not be limited to, the payment of all valid claims, losses, and judgements of any nature whatsoever in connection therewith and the payment of all related fees and costs, including attorneys' fees, incurred by the indemnified party in connection with the indemnifying party's activities arising out of the performance of this Agreement. This indemnification obligation shall not be construed to negate, abridge or reduce any other rights or remedies which otherwise may be available to an indemnified party or person described in this paragraph or deemed to affect the rights, privileges and immunities of COUNTY as set forth in Section 768.28, Florida Statutes.

ARTICLE 20. NO WAIVER OF SOVEREIGN IMMUNITY

Nothing herein shall be interpreted as a waiver by COUNTY of its rights, including the limitations of the waiver of immunity as set forth in Florida Statutes § 768.28, or any other

statutes or immunities. COUNTY expressly reserves these rights to the full extent allowed by law.

ARTICLE 21. INSURANCE

- A. CONSULTANT shall, at its own cost and expense, acquire and maintain (and cause any subcontractors, representatives, or agents to acquire and maintain) insurance policies that comply with the Insurance Requirements, attached as **Exhibit E**, during the term of this Agreement, to include any renewal terms.
- B. Certificates of Insurance and copies of policies evidencing the insurance coverage specified in **Exhibit E** shall be filed with the Purchasing Official before the Effective Date of this Agreement. The required certificates shall identify the type of policy, policy number, date of expiration, amount of coverage, companies affording coverage, shall refer specifically to the title of this Agreement, and shall name Manatee County as an additional insured. No changes shall be made to the insurance coverage without prior written approval by COUNTY'S Risk Management Division.
- C. Insurance shall remain in force for at least three (3) years after completion of services under this Agreement in the amounts and types of coverage as required by **Exhibit E**, including coverage for all products and services completed under this Agreement.
- D. If the initial insurance expires prior to the termination of this Agreement, renewal Certificates of Insurance and required copies of policies shall be furnished by CONSULTANT and delivered to the Purchasing Official thirty (30) days prior to the date of their expiration.

ARTICLE 22. LEGAL SERVICES

If notified in writing by the Office of the County Attorney, CONSULTANT agrees to provide litigation services up to and including the date of the completion of litigation as follows:

- A. Coordinate and communicate directly with the Office of the County Attorney.
- B. Provide any personnel performing services under this Agreement to testify in any litigation proceeding.
- C. Perform litigation services as directed by the Office of the County Attorney that may include but are not limited to:
 - 1. Predisposition, pretrial, or prehearing preparation.
 - 2. Preparation of court exhibits.
 - 3. Attendance and testimony at depositions, pretrial hearings, or other court hearings.
 - 4. Any other services deemed necessary by the assigned attorney to successfully litigate and

defend COUNTY'S position in court.

- D. Compensation for litigation services shall not exceed CONSULTANT'S Fee Rate Schedule specified in **Exhibit B**. The hourly billing rates shall contain all costs to include salaries, overhead, general and administrative, incidental expenses, fringe benefits and operating margin.
- E. CONSULTANT'S travel expenses will be submitted and paid in accordance with Florida Statutes § 112.061 provided prior approval of the travel is obtained from the County Attorney or the County Attorney's designee.
- F. CONSULTANT shall submit monthly statements for litigation services rendered to the Office of the County Attorney for approval, providing detailed accounting sufficient for pre-audit and specifying services performed, the dates of the services, hours expended for each service, the name of the person who performed the service, the service and a breakdown of approved expenses incurred with all receipts and invoices attached.

ARTICLE 23. SOLICITATION OF AGREEMENT

CONSULTANT warrants that it has not employed or retained any company or person other than a bona fide employee working solely for CONSULTANT to solicit or secure this Agreement, and that it has not paid or agreed to pay any company or person other than an employee working solely for CONSULTANT, any fee, commission, percentage, brokerage fee, gift, contingent fee, or any other consideration contingent upon or resulting from the award or making of this Agreement. For breach or violation of this warranty, COUNTY shall have the right to annul this Agreement without liability, or at its discretion, to deduct from this Agreement price or consideration or otherwise recover the full amount of such fee, commission, percentage, brokerage fee, gifts, or contingent fee.

ARTICLE 24. ASSIGNMENT AND SUBCONTRACTING

CONSULTANT shall not assign or transfer any right or duty under this Agreement to any other party without the prior written consent of COUNTY. In the event CONSULTANT asserts it is necessary to utilize the services of third parties to perform any service under this Agreement, CONSULTANT shall first obtain prior written approval of COUNTY.

Approval to utilize any third party shall not relieve CONSULTANT from any direct liability or responsibility to COUNTY pursuant to the provisions of this Agreement, or obligate COUNTY to make any payments other than payments due to CONSULTANT as outlined in this Agreement. All terms and conditions of this Agreement shall extend to and be binding on any approved purchaser, assignee, or other successor in interest.

Assignment, pledging, sale, transfer or encumbering of any interest or rights under this Agreement, to anyone other than the CONSULTANT, without the prior written consent of the COUNTY, shall be grounds for immediate termination of this Agreement.

ARTICLE 25. CERTIFICATION OF NON-PAYMENT OF COMMISSION OR GIFT

CONSULTANT warrants that it has not employed or retained any company or person other than a bona fide employee working solely for CONSULTANT to solicit or secure this Agreement, and that it has not paid or agreed to pay any company or person other than an employee working solely for CONSULTANT, any fee, commission, percentage, brokerage fee, gift, contingent fee, or any other consideration contingent upon or resulting from the award or making of this Agreement. For breach or violation of this warranty, COUNTY shall have the right to annul this Agreement, without liability or at its discretion to deduct from the agreement price consideration or otherwise recover the full amount of such fee, commission, percentage, brokerage fee, gifts, or contingent fee.

ARTICLE 26. KEY PERSONNEL

The following key personnel are hereby assigned to this Agreement by CONSULTANT:

Enter Name, Title

CONSULTANT shall not remove such key personnel from providing the services contemplated by this Agreement; provided, however, that the removal of such personnel due to their incapacity, voluntary termination, or termination due to just cause will not constitute a violation of this Agreement. The COUNTY will require that, at a minimum, any proposed replacement have equal or greater qualifications and experience as the key personnel being replaced. CONSULTANT shall not make any personnel changes of the key personnel until written notice is made to and approved by the COUNTY.

ARTICLE 27. SUB-CONSULTANTS

If CONSULTANT receives written approval from the COUNTY to use the services of a sub-consultant(s), CONSULTANT shall utilize the sub-consultant fees specified in **Exhibit B**. CONSULTANT shall notify COUNTY of any replacements or additions to **Exhibit B** and receive prior written approval of COUNTY for replacements or additions before the use of the sub-consultant.

ARTICLE 28. PROFESSIONAL LIABILITY.

To the fullest extent allowed by law, the individuals performing professional services pursuant to this Agreement shall be personally liable for negligent acts or omissions. To the fullest extent allowed by law, CONSULTANT shall likewise be liable for negligent acts or omissions in the performance of professional services pursuant to this Agreement.

ARTICLE 29. NOTICES

All notices, requests and authorizations provided for herein shall be in writing and shall be delivered by hand or mailed through the U.S. Mail, addressed as follows:

To COUNTY: Manatee County Government
Department
Attn:
Address
City, State, Zip
Phone: (941)
Email:

To CONSULTANT: Consultant Name
Attn: Representative Name
Address
City, State, Zip
Phone: ()
Email:

ARTICLE 30. RELATIONSHIP OF PARTIES

The relationship of CONSULTANT to COUNTY shall be that of an independent contractor. Nothing herein contained shall be construed as vesting or delegating to CONSULTANT or any of the officers, employees, personnel, agents, or sub-consultants of CONSULTANT any rights, interest or status as an employee of COUNTY. COUNTY shall not be liable to any person, firm or corporation that is employed by Agreements or provides goods or services to CONSULTANT in connection with this Agreement or for debts or claims accruing to such parties. CONSULTANT shall promptly pay, discharge or take such action as may be necessary and reasonable to settle such debts or claims.

ARTICLE 31. NO CONFLICT

By accepting award of this Agreement, CONSULTANT, which shall include its directors, officers and employees, represents that it presently has no interest in and shall acquire no interest in any business or activity which would conflict in any manner with the performance of duties or services required hereunder.

ARTICLE 32. ETHICAL CONSIDERATIONS

CONSULTANT recognizes that in rendering the services pursuant to the provisions of this Agreement, CONSULTANT is working for the residents of Manatee County, Florida, subject to public observation, scrutiny and inquiry; and based upon said recognition CONSULTANT shall, in all of its relationships with COUNTY pursuant to this Agreement, conduct itself in accordance with all of the recognized applicable ethical standards set by any related national societies, and the reasonable traditions to perform the services. CONSULTANT shall be truthful in its communications with COUNTY personnel regarding matters pertaining to this Agreement and the scope of services rendered to COUNTY.

ARTICLE 33. PUBLIC ENTITY CRIMES

CONSULTANT has been made aware of the Florida Public Entity Crimes Act, Florida Statutes § 287.133, specifically section 2(a), and COUNTY'S requirement that CONSULTANT comply with it in all respects prior to and during the term of this Agreement.

ARTICLE 34. TAXES

COUNTY is exempt from Federal Excise and State Sales Taxes (F.E.T. Exemption Certificate No. 59-78-0089K; FL Sales Tax Exemption Certificate No. 51-02-027548-53C). Therefore, CONSULTANT is prohibited from charging or imposing any sales or service taxes. Nothing herein shall affect CONSULTANT'S normal tax liability.

CONSULTANT shall be responsible for payment of federal, state, and local taxes which may be imposed upon CONSULTANT under applicable law to the extent that CONSULTANT is responsible for the payment of same under applicable law.

ARTICLE 35. FORCE MAJEURE

Neither party shall be considered in default in performance of its obligations hereunder to the extent that performance of such obligations or any of them is delayed or prevented by Force Majeure.

Force Majeure shall include, but not be limited to, hostility, revolution, civil commotion, strike, epidemic, accident, fire, flood, wind, earthquake, hurricane, explosion, lack of or failure of transportation facilities, any law, proclamation, regulation, ordinance or other act of government, or any act of God or any cause whether of the same or different nature, existing or future; provided that the cause, whether or not enumerated in this Article, is beyond the control and without the fault or negligence of the party seeking relief under this Article.

ARTICLE 36. GOVERNING LAW, JURISDICTION AND VENUE

This Agreement shall be governed by the laws of the State of Florida. Any action filed regarding this Agreement will be filed only in Manatee County, Florida, or if in Federal Court, the Middle District of Florida, Tampa Division.

ARTICLE 37. ATTORNEY FEES

In the event of any litigation arising under the terms of this Agreement, each party shall be responsible for their own attorney's fees, including appellate fees, regardless of the outcome of the litigation.

ARTICLE 38. PATENT AND COPYRIGHT RESPONSIBILITY

Any material, design or supplied specified by CONSULTANT or supplied by CONSULTANT pursuant to this Agreement shall not knowingly infringe any patent or copyright, and

CONSULTANT shall be solely responsible for securing any necessary licenses required for patented or copyrighted material utilized by CONSULTANT in the performance of the professional [Enter Type of Service] services.

ARTICLE 39. AMENDMENTS

This Agreement and Exhibits referenced herein constitute the entire Agreement between the parties with respect to subject matter and mutually agree that no verbal agreements, representations, warranties or other understandings affecting the same exist. No amendment hereof shall be effective until and unless reduced to writing and executed by the parties. The parties shall execute any additional documents as may be necessary to implement and carry out the intent of this Agreement.

ARTICLE 40. SEVERABILITY

It is understood and agreed by the parties hereto that if any part, term, or provision of this Agreement is held to be illegal or in conflict with any law, the validity of the remaining portions or provisions shall not be affected, and the rights and obligations of the parties shall be construed and enforced as if this Agreement did not contain the particular part, term or provision held to be invalid.

ARTICLE 41. LEGAL REFERENCES

All references to statutory sections or chapters shall be construed to include subsequent amendments to such provisions, and to refer to the successor provision of any such provision. References to “applicable law” and “general law” shall be construed to include provisions of local, state and federal law, whether established by legislative action, administrative rule or regulation, or judicial decision.

ARTICLE 42. HEADINGS, CONSTRUCTION

The parties agree that they have each participated in the drafting of this Agreement and that the rules with respect to construing ambiguities against the drafter of a contract shall not apply in any action or litigation regarding this Agreement. All articles and descriptive headings of paragraphs of this Agreement are inserted for convenience only and shall not affect the construction or interpretation hereof.

ARTICLE 43. TIME

For purposes of computing any period of number of days hereunder for notices or performance of ten (10) days or less, Saturdays, Sundays and holidays shall be excluded, unless otherwise stated.

ARTICLE 44. AUTHORITY TO EXECUTE

Each of the Parties hereto covenants to the other Party that it has lawful authority to enter into this Agreement.

IN WITNESS WHEREOF, the parties hereto have caused this Agreement to be duly executed effective as of the date set forth above.

CONSULTANT NAME

By: _____

Print Name & Title of Above Signer

Date: _____

**MANATEE COUNTY, a political subdivision of the
State of Florida**

By: its Board of County Commissioners

By: _____

Chairperson

Date: _____

**ATTEST: ANGELINA COLONNESO
CLERK OF THE CIRCUIT COURT AND COMPTROLLER**

By: _____

Deputy Clerk

EXHIBIT A
SCOPE OF SERVICES

EXHIBIT B
FEE RATE SCHEDULE

EXHIBIT C
WORK ASSIGNMENT

WORK ASSIGNMENT NUMBER: _____

Pursuant to the Manatee County, Florida, Agreement for Professional _____ Services entered into by and between MANATEE COUNTY, a political subdivision of the State of Florida, hereinafter referred to as "COUNTY" and Insert Consultant name _____, hereinafter referred to as "CONSULTANT," a determination has been made by COUNTY that there is a need for the performance of or rendering of services by CONSULTANT of a certain "Work Assignment" under the purview of said Agreement, and CONSULTANT is hereby authorized to perform or render the particular services of work described as follows:

TITLE OF THE PROJECT: _____

PHASES AND/OR TASKS OF PROFESSIONAL SERVICES AUTHORIZED:

CONSULTANT shall perform tasks as more specifically detailed in Attachments 1 through 3 as follows:

- Attachment 1, Scope of Services
- Attachment 2, Hourly Fee Schedule
- Attachment 3, Schedule

Compensation to CONSULTANT for rendering all of the above identified services and products shall not exceed \$ _____. Compensation for the tasks shall not exceed the amounts set forth as follows:

Task/Description # _____ - \$ _____

Task/Description # _____ - \$ _____

COUNTY may authorize, in writing, in advance, adjustments in the compensation for particular tasks established above, provided such adjustments do not exceed the maximum compensation authorized for this Work Assignment.

Partial compensation may be requested on a monthly basis for unit prices and actual hours incurred but not to exceed the percentage of the task completed.

CONSULTANT agrees to perform or render services in accordance with this Agreement No. _____ for Professional _____ Services and this Work Assignment dated _____.

CONSULTANT NAME, Consultant

By: _____

Print Name: _____

Title: _____

Date: _____

**MANATEE COUNTY, a political
subdivision of the State of Florida**

By: _____

Date: _____

EXHIBIT D
AFFIDAVIT OF NO CONFLICT

STATE OF _____

COUNTY OF _____

BEFORE ME, the undersigned authority, this day personally appeared [INSERT NAME] _____
_____, as [INSERT TITLE] _____ of
[INSERT SUPPLIER NAME] _____, with full authority to bind
(hereinafter "CONSULTANT"), who being first duly sworn, deposes and says that
CONSULTANT:

(a) Is not currently engaged and will not become engaged in any obligations,
undertakings or contracts that will require CONSULTANT to maintain an adversarial role
against the County or that will impair or influence the advice, recommendations or quality of
work provided to the County; and

(b) Has provided full disclosure of all potentially conflicting contractual relationships
and full disclosure of contractual relationships deemed to raise a question of conflict(s); and

(c) Has provided full disclosure of prior work history and qualifications that may be
deemed to raise a possible question of conflict(s).

Affiant makes this Affidavit for the purpose of inducing Manatee County, a political subdivision
of the State of Florida, to enter into this Agreement No. _____
for _____.

DATED this _____ day of _____, _____.

Signature

The foregoing instrument was sworn to and acknowledged before me this _____ day of
_____, 20____, by _____, as
_____ of _____. He/she is personally known to me or
has produced _____ as identification.

Notary Public, State of Florida at Large

Commission No. _____

EXHIBIT E
INSURANCE AND BOND REQUIREMENTS

The CONSULTANT will not commence work under the resulting Agreement until all insurance coverages indicated herein have been obtained. The CONSULTANT shall obtain and submit to the Procurement Division within ten (10) calendar days from the date of notice of intent to award, at its expense, the following minimum amounts of insurance (inclusive of any amounts provided by an umbrella or excess policy): Work under this Agreement cannot commence until all insurance coverages indicated herein have been obtained on a standard ACORD form (inclusive of any amounts provided by an umbrella or excess policy):

<u>STANDARD INSURANCES</u>	<u>REQUIRED LIMITS</u>
<p>1. <input checked="" type="checkbox"/> Automobile Liability Insurance:</p>	<p>Coverage must be afforded under a per occurrence policy form including coverage for all owned, hired and non-owned vehicles for bodily injury and property damage of not less than:</p> <ul style="list-style-type: none"> • \$ <u>1,000,000</u> Combined Single Limit; OR • \$ <u>500,000</u> Bodily Injury <u>and</u> \$ <u>500,000</u> Property Damage • \$<u>10,000</u> Personal Injury Protection (No Fault) • \$ <u>500,000</u> Hired, Non-Owned Liability • \$<u>10,000</u> Medical Payments <p><i>This policy shall contain severability of interests' provisions.</i></p>
<p>2. <input checked="" type="checkbox"/> Commercial General Liability Insurance:</p> <p><i>(Per Occurrence form only; claims-made form is not acceptable)</i></p>	<p>Coverage shall be afforded under a per occurrence policy form, policy shall be endorsed and name "Manatee County, a political subdivision of the State of Florida" as an Additional Insured, and include limits not less than:</p> <ul style="list-style-type: none"> • \$ <u>1,000,000</u> Single Limit Per Occurrence • \$ <u>2,000,000</u> Aggregate • \$<u>1,000,000</u> Products/Completed Operations Aggregate • \$ 1,000,000 Personal and Advertising Injury Liability • \$ 50,000 Fire Damage Liability • \$ <u>10,000</u> Medical Expense, and • \$ <u>1,000,000</u>, Third Party Property Damage • \$ _____ Project Specific Aggregate (Required on projects valued at over \$<u>10,000,000</u>) <p><i>This policy shall contain severability of interests' provisions.</i></p>
<p>3. <input checked="" type="checkbox"/> Employer's Liability Insurance</p>	<p>Coverage limits of not less than:</p> <ul style="list-style-type: none"> • \$<u>100,000</u> Each Accident • \$<u>500,000</u> Disease Each Employee • \$<u>500,000</u> Disease Policy Limit •

<p>4. <input checked="" type="checkbox"/> Worker’s Compensation Insurance</p> <p><input type="checkbox"/> US Longshoremen & Harbor Workers Act Coverage</p> <p><input type="checkbox"/> Jones Act Coverage</p>	<p>Coverage limits of not less than:</p> <ul style="list-style-type: none"> • Statutory workers’ compensation coverage shall apply for all employees in compliance with the laws and statutes of the State of Florida and the federal government. • If any operations are to be undertaken on or about navigable waters, coverage must be included for the US Longshoremen & Harbor Workers Act and Jones Act. <p>Should ‘leased employees’ be retained for any part of the project or service, the employee leasing agency shall provide evidence of Workers’ Compensation coverage and Employer’s Liability coverage for all personnel on the worksite and in compliance with the above Workers’ Compensation requirements.</p> <p>NOTE: Workers’ Compensation coverage is a firm requirement. Elective exemptions are considered on a case-by-case basis and are approved in a very limited number of instances.</p>
<p><u>OTHER INSURANCES</u></p>	<p><u>REQUIRED LIMITS</u></p>
<p>5. <input type="checkbox"/> Aircraft Liability Insurance</p>	<p>Coverage shall be afforded under a per occurrence policy form, policy shall be endorsed and name ‘Manatee County’ a political subdivision of the State of Florida’ as an Additional Insured, and include limits not less than:</p> <ul style="list-style-type: none"> • \$ _____ Each Occurrence Property and Bodily Injury with no less than <u>\$100,000</u> per passenger each occurrence or a ‘smooth’ limit. • \$ _____ General Aggregate
<p>6. <input type="checkbox"/> Unmanned Aircraft Liability Insurance (Drone)</p>	<p>Coverage shall be afforded under a per occurrence policy form, policy shall be endorsed and name ‘Manatee County’ a political subdivision of the State of Florida’ as an Additional Insured, and include limits not less than:</p> <ul style="list-style-type: none"> • \$ _____ Each Occurrence Property and Bodily Injury; Coverage shall specifically include operation of Unmanned Aircraft Systems (UAS), including liability and property damage. • \$ _____ General Aggregate
<p>7. <input type="checkbox"/> Installation Floater Insurance</p>	<p>When the contract or agreement does not include construction of, or additions to, above ground building or structures, but does involve the installation of machinery or equipment, Installation Floater Insurance shall be afforded under a per</p>

	<p>occurrence policy form, policy shall be endorsed and name “Manatee County, a political subdivision of the State of Florida” as an Additional Insured, and include limits not less than:</p> <ul style="list-style-type: none"> • 100% of the completed value of such addition(s), building(s), or structure(s)
<p>8. <input type="checkbox"/> Professional Liability and/or Errors and Omissions (E&O) Liability Insurances</p>	<p>Coverage shall be afforded under either an occurrence policy form or a claims-made policy form. If the coverage form is on a claims-made basis, then coverage must be maintained for a minimum of three years from termination of date of the contract. Limits must not be less than:</p> <ul style="list-style-type: none"> • \$ _____ Bodily Injury and Property Damage Each Occurrence • \$ _____ General Aggregate
<p>9. <input type="checkbox"/> Builder’s Risk Insurance</p>	<p>When the contract or agreement includes the construction of roadways and/or the addition of a permanent structure or building, including the installation of machinery and/or equipment, Builder’s Risk Insurance shall be afforded under a per occurrence policy form, policy shall be endorsed and name “Manatee County, a political subdivision of the State of Florida” as an Additional Insured, and include limits not less than:</p> <ul style="list-style-type: none"> • An amount equal to 100% of the completed value of the project, or the value of the equipment to be installed • The policy shall not carry a self-insured retention/deductible greater than \$10,000 <p>Coverage shall be for all risks and include, but not be limited to, storage and transport of materials, equipment, supplies of any kind whatsoever to be used on or incidental to the project, theft coverage, and Waiver of Occupancy Clause Endorsement, where applicable.</p>
<p>10. <input type="checkbox"/> Cyber Liability Insurance</p>	<p>Coverage shall comply with Florida Statute 501.171, shall be afforded under a per occurrence policy form, policy shall be endorsed and name “Manatee County, a political subdivision of the State of Florida” as an Additional Insured, and include limits not less than:</p> <ul style="list-style-type: none"> • \$_____ Security Breach Liability • \$_____ Security Breach Expense Each Occurrence • \$_____ Security Breach Expense Aggregate • \$_____ Replacement or Restoration of Electronic Data

	<ul style="list-style-type: none"> • \$_____ Extortion Threats • \$_____ Business Income and Extra Expense • \$_____ Public Relations Expense <p>NOTE: Policy must not carry a self-insured retention/deductible greater than <u>\$25,000</u>.</p>
<p>11. <input type="checkbox"/> Hazardous Materials Insurance (As Noted)</p>	<p>Hazardous materials include all materials and substances that are currently designated or defined as hazardous by the law or rules of regulation by the State of Florida or federal government.</p> <p>All coverage shall be afforded under either an occurrence policy form or a claims-made policy form, and the policy shall be endorsed and name “Manatee County, a political subdivision of the State of Florida” as an Additional Insured. If the coverage form is on a claims-made basis, then coverage must be maintained for a minimum of three years from termination of date of the contract. Limits must not be less than:</p> <p><input type="checkbox"/> <i>Pollution Liability</i></p> <ul style="list-style-type: none"> • Amount equal to the value of the contract, subject to a <u>\$1,000,000</u> minimum, for Bodily Injury and Property Damage to include sudden and gradual release, each claim and aggregate. <p><input type="checkbox"/> <i>Asbestos Liability (If handling within scope of Contract)</i></p> <ul style="list-style-type: none"> • Amount equal to the value of the contract, subject to a <u>\$1,000,000</u> minimum, for Bodily Injury and Property Damage to include sudden and gradual release, each claim and aggregate. <p><input type="checkbox"/> <i>Disposal</i></p> <p>When applicable, CONSULTANT shall designate the disposal site and furnish a Certificate of Insurance from the disposal facility for Environmental Impairment Liability Insurance covering liability.</p> <ul style="list-style-type: none"> • Amount equal to the value of the contract, subject to a <u>\$1,000,000</u> minimum, for Liability for Sudden and Accidental Occurrences, each claim and an aggregate. • Amount equal to the value of the contract, subject to a <u>\$1,000,000</u> minimum, for Liability for Non-Sudden and Accidental Occurrences, each claim and an aggregate.
<p>12. <input type="checkbox"/> Hazardous Waste Transportation Insurance</p>	<p>CONSULTANT shall designate the hauler and have the hauler furnish a Certificate of Insurance for Automobile Liability insurance with Endorsement MCS-90 for liability arising out of the transportation of hazardous materials. EPA identification</p>

	<p>number shall be provided.</p> <p>All coverage shall be afforded under either an occurrence policy form or a claims-made policy form and the policy shall be endorsed and name “Manatee County, a political subdivision of the State of Florida” as an Additional Insured. If the coverage form is on a claims-made basis, then coverage must be maintained for a minimum of three years from termination of date of the contract. Limits must not be less than:</p> <ul style="list-style-type: none"> • Amount equal to the value of the contract, subject to a <u>\$1,000,000</u> minimum, per accident.
<p>13. <input type="checkbox"/> Liquor Liability Insurance</p>	<p>Coverage shall be afforded under a per occurrence policy form, policy shall be endorsed and name “Manatee County, a political subdivision of the State of Florida” as an Additional Insured, and include limits not less than:</p> <ul style="list-style-type: none"> • <u>\$1,000,000</u> Each Occurrence and Aggregate
<p>14. <input type="checkbox"/> Garage Keeper’s Liability Insurance</p>	<p>Coverage shall be required if the maintenance, servicing, cleaning or repairing of any County motor vehicles is inherent or implied within the provision of the contract.</p> <p>Coverage shall be afforded under a per occurrence policy form, policy shall be endorsed and name “Manatee County, a political subdivision of the State of Florida” as an Additional Insured, and include limits not less than:</p> <ul style="list-style-type: none"> • Property and asset coverage in the full replacement value of the lot or garage.
<p>15. <input type="checkbox"/> Bailee’s Customer Liability Insurance</p>	<p>Coverage shall be required for damage and/or destruction when County property is temporarily under the care or custody of a person or organization, including property that is on, or in transit to and from the person or organization’s premises. Perils covered should include fire, lightning, theft, burglary, robbery, explosion, collision, flood, earthquake and damage or destruction during transportation by a carrier.</p> <p>Coverage shall be afforded under a per occurrence policy form, policy shall be endorsed and name “Manatee County, a political subdivision of the State of Florida” as an Additional Insured, and include limits not less than:</p> <ul style="list-style-type: none"> • Property and asset coverage in the full replacement value of the County asset(s) in the CONSULTANT’S care, custody and control.

<p>16. <input type="checkbox"/> Hull and Watercraft Liability Insurance</p>	<p>Coverage shall be afforded under a per occurrence policy form, policy shall be endorsed and name “Manatee County, a political subdivision of the State of Florida” as an Additional Insured, and include limits not less than:</p> <ul style="list-style-type: none"> • \$ _____ Each Occurrence • \$ _____ General Aggregate • \$ _____ Fire Damage Liability • \$10,000 Medical Expense, and • \$ _____ Third Party Property Damage • \$ _____ Project Specific Aggregate (Required on projects valued at over \$10,000,000)
<p>17. <input type="checkbox"/> Other [Specify]</p>	

<u>BOND REQUIREMENTS</u>	
<p>1. <input type="checkbox"/> Bid Bond</p>	<p>A Bid Bond in the amount of \$ _____ or _____% of the total offer. Bid bond shall be submitted with the sealed response and shall include project name, location, and / or address and project number.</p> <p>In lieu of the bond, the bidder may file an alternative form of security in the amount of \$ _____ or _____% of the total offer. in the form of a money order, a certified check, a cashier’s check, or an irrevocable letter of credit issued to Manatee County.</p> <p>NOTE: A construction project over \$200,000 requires a Bid Bond in the amount of 5% of the total bid offer.</p>
<p>2. <input type="checkbox"/> Payment and Performance Bond</p>	<p>A Payment and Performance Bond shall be submitted by Successful Bidder for 100% of the award amount and shall be presented to Manatee County within ten (10) calendar days of issuance of the notice of intent to award.</p> <p>NOTE: A construction project over \$200,000 requires a Payment and Performance Bond.</p>

Approved: _____

Date: _____

INSURANCE REQUIREMENTS

I. THE POLICIES ARE TO CONTAIN, OR BE ENDORSED TO CONTAIN, THE FOLLOWING PROVISIONS:

Commercial General Liability and Automobile Liability Coverages

- a. **“Manatee County, a Political Subdivision of the State of Florida,” is to be named as an Additional Insured in respect to:** Liability arising out of activities performed by or on behalf of the CONSULTANT, his agents, representatives, and employees; products and completed operations of the CONSULTANT; or automobiles owned, leased, hired or borrowed by the CONSULTANT. The coverage shall contain no special limitation(s) on the scope of protection afforded to the COUNTY, its officials, employees or volunteers.

In addition to furnishing a Certificate of Insurance, the CONSULTANT shall provide the endorsement that evidences Manatee COUNTY being listed as an Additional Insured. This can be done in one of two ways: (1) an endorsement can be issued that specifically lists “Manatee County, a Political Subdivision of the State of Florida,” as Additional Insured; or, (2) an endorsement can be issued that states that all Certificate Holders are Additional Insured with respect to the policy.

- b. The CONSULTANT'S insurance coverage shall be primary insurance with respect to the COUNTY, its officials, employees and volunteers. Any insurance or self-insurance maintained by the COUNTY, its officials, employees or volunteers shall be excess of CONSULTANT's insurance and shall be non-contributory.
- c. The insurance policies must be on an occurrence form.

Workers' Compensation and Employers' Liability Coverages

The insurer shall agree to waive all rights of subrogation against the COUNTY, its officials, employees and volunteers for losses arising from work performed by the CONSULTANT for the COUNTY.

II. GENERAL INSURANCE PROVISIONS APPLICABLE TO ALL POLICIES:

- a. Prior to the execution of contract, or issuance of a Purchase Order, and then annually upon the anniversary date(s) of the insurance policy's renewal date(s) for as long as this contract remains in effect, CONSULTANT shall furnish the COUNTY with a Certificate(s) of Insurance (using an industry accepted certificate form, signed by the Issuer, with applicable endorsements, and containing the solicitation or contract number, and title or description) evidencing the coverage set forth above and naming “Manatee County, a Political Subdivision of the State of Florida” as an Additional Insured on the applicable coverage(s) set forth above.
- b. If the policy contains an aggregate limit, confirmation is needed in writing (letter, email, etc.) that the aggregate limit has not been eroded to procurement representative when supplying Certificate of Insurance.

In addition, when requested in writing from the COUNTY, CONSULTANT will provide the COUNTY with a certified copy of all applicable policies. The address where such certificates and certified policies shall be sent or delivered is as follows:

Manatee County, a Political Subdivision of the State of Florida
Attn: Risk Management Division
1112 Manatee Avenue West, Suite 969
Bradenton, FL 34205

- c. The project's solicitation number and title shall be listed on each certificate.
 - d. CONSULTANT shall provide thirty (30) days written notice to the Risk Manager of any cancellation, non-renewal, termination, material change, or reduction in coverage of any insurance policies to procurement representative including solicitation number and title with all notices.
 - e. CONSULTANT agrees that should at any time CONSULTANT fail to meet or maintain the required insurance coverage(s) as set forth herein, the COUNTY may terminate this contract.
 - f. The CONSULTANT waives all subrogation rights against COUNTY, a Political Subdivision of the State of Florida, for all losses or damages which occur during the contract and for any events occurring during the contract period, whether the suit is brought during the contract period or not.
 - g. The CONSULTANT has sole responsibility for all insurance premiums and policy deductibles.
 - h. It is the CONSULTANT'S responsibility to ensure that his agents, representatives and subcontractors comply with the insurance requirements set forth herein. CONSULTANT shall include his agents, representatives, and subcontractors working on the project or at the worksite as insured under its policies, or CONSULTANT shall furnish separate certificates and endorsements for each agent, representative, and subcontractor working on the project or at the worksite. All coverages for agents, representatives, and subcontractors shall be subject to all of the requirements set forth to the procurement representative.
 - i. All required insurance policies must be written with a carrier having a minimum A.M. Best rating of A- FSC VII or better. In addition, the COUNTY has the right to review the CONSULTANT's deductible or self-insured retention and to require that it be reduced or eliminated.
- III.** CONSULTANT understands and agrees that the stipulated limits of coverage listed herein in this insurance section shall not be construed as a limitation of any potential liability to the COUNTY, or to others, and the COUNTY'S failure to request evidence of this insurance coverage shall not be construed as a waiver of CONSULTANT'S obligation to provide and maintain the insurance coverage specified.
- IV.** The enclosed Hold Harmless Agreement shall be signed by the CONSULTANT and shall become a part of the contract.

V. CONSULTANT understands and agrees that the COUNTY does not waive its immunity and nothing herein shall be interpreted as a waiver of the COUNTY'S rights, including the limitation of waiver of immunity, as set forth in Florida Statutes 768.28, or any other statutes, and the COUNTY expressly reserves these rights to the full extent allowed by law.

VI. No award shall be made until the Procurement Division has received the Certificate of Insurance and Hold Harmless Agreement in accordance with this section.

VII. BONDING REQUIREMENTS

Bid Bond/Certified Check. By submitting a proposal, the CONSULTANT agrees should its proposal be accepted, **to execute the form of Agreement and present the same to COUNTY for approval within ten (10) calendar days after notice of intent to award.** The CONSULTANT further agrees that failure to execute and deliver said form of Agreement **within ten (10) calendar days** will result in damages to COUNTY and as guarantee of payment of same a bid bond/certified check shall be enclosed within the submitted sealed proposal in the amount of five (5%) percent of the total amount of the proposal. The CONSULTANT further agrees that in case the CONSULTANT fails to enter into an Agreement, as prescribed by COUNTY, the bid bond/certified check accompanying the proposal shall be forfeited to COUNTY as agreed liquidated damages. If COUNTY enters into an agreement with a CONSULTANT, or if COUNTY rejects any and/or all proposals, accompanying bond will be promptly returned.

Payment and Performance Bonds. Prior to commencing work, the CONSULTANT shall obtain, for the benefit of and directed to COUNTY, a Payment and Performance Bond satisfying the requirements of Section 255.05, Florida Statutes, covering the faithful performance by the CONSULTANT of its obligation under the Contract Documents, including but not limited to the construction of the project on the project site and the payment and obligations arising thereunder, including all payments to Subcontractors, laborers, and materialmen. The surety selected by the CONSULTANT to provide the Payment and Performance Bond shall be approved by COUNTY prior to issuance of such Bond, which approval shall not be unreasonably withheld or delayed provided that surety is rated A- or better by Best's Key Guide, latest edition.

Failure to provide the required bonds on the prescribed form may result in CONSULTANT being deemed nonresponsive. Bonds must be in the form prescribed in Section 255.05, Florida Statutes, and must not contain notice, demand or other terms and conditions, including informal pre-claim meetings, not provided for in Section 255.05, Florida Statutes.

Bonds shall be in an amount equal to 100% of the contract price issued by a duly authorized and nationally recognized surety company, authorized to do business in the State of Florida, satisfactory to COUNTY. Surety shall be rated as "A-" or better by Best's Key Guide, latest edition. The attorney-in-fact who signs the bonds must file with the bonds, a certificate and effective dated copy of power-of-attorney. Payment and Performance Bonds shall be issued to "Manatee County, a political subdivision of the State of Florida", **within ten (10) calendar days after issuance of notice of intent to award.**

In addition, pursuant to Section 255.05(1)(b), Florida Statutes, prior to commencing work, the CONSULTANT shall be responsible and bear all costs associated to record the Payment and Performance Bond with the Manatee County Clerk of the Circuit Court. A certified copy of said recording shall be furnished to the Procurement Division upon filing. Pursuant to Section 255.05(1)(b), Florida Statutes, COUNTY will make no payment to the CONSULTANT until the CONSULTANT has complied with this paragraph.

Furnishing Payment and Performance Bonds shall be requisite to execution of an Agreement with COUNTY. Said Payment and Performance Bonds will remain in force for the duration of this Agreement with the premiums paid by the CONSULTANT. Failure of the CONSULTANT to execute such Agreement and to supply the required bonds shall be just cause for cancellation of the award. COUNTY may then contract with the next lowest, responsive and responsible CONSULTANT or re-advertise this RFP.

Failure of COUNTY at any time to require performance by the CONSULTANT of any provisions set out in the resulting Agreement will in no way affect the right of COUNTY, thereafter, to enforce those provisions.

[Remainder of page intentionally left blank]

CONSULTANT'S INSURANCE STATEMENT

THE UNDERSIGNED has read and understands the aforementioned insurance and bond requirements of this Agreement and shall provide the insurance and bonds required by this section within ten (10) days from the date of notice of intent to award.

Consultant Name: _____ Date: _____

Authorized
Signature: _____

Print Name: _____

Insurance Agency: _____

Agent Name: _____ Agent Phone: _____

Surety Agency: _____

Surety Name: _____ Surety Phone: _____

Please return this completed and signed statement with your agreement.

EXHIBIT 4

RFO 18-R068599OV

Motor Control Center Drawings

**W A R N I N G -- THESE DRAWINGS MAY CONTAIN ERRORS
VERIFY AGAINST SQUARE D ORIGINAL HARD COPY DRAWINGS BEFORE USING**

These drawings have been translated from original drawings. The translation process can introduce errors into the drawings in unknown ways. Only original hard copy drawings provided by Square D Company to its customers should be relied upon by its customers or others. If these drawings are to be used by the customer, they must first be verified against the Square D Company hard copy drawings.

REV	DESCRIPTION	BY	DATE			

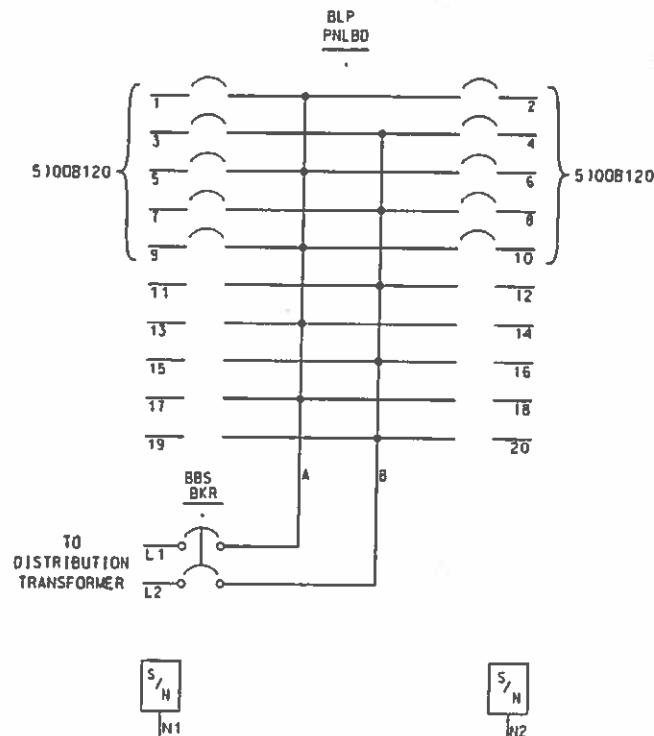

JOB NAME: STORAGE POND IMPROVEMENTS	EQUIPMENT DESIGNATION: MCC-1
JOB LOCATION: MANATEE, FL	EQUIPMENT TYPE: MODEL 6 MOTOR CONTROL CENTER
DRAWN BY: VTL	DRAWING TYPE: ELEMENTARY DIAGRAM
ENGR: TLT	SQUARE D COMPANY
DATE: APRIL 3, 2001	
DRAWING STATUS: RECORD	DWG# E14122970-009-02 PG 1 OF 1 REV -

W A R N I N G -- THESE DRAWINGS MAY CONTAIN ERRORS
 VERIFY AGAINST SQUARE D ORIGINAL HARD COPY DRAWINGS BEFORE USING

These drawings have been translated from original drawings. The translation process can introduce errors into the drawings in unknown ways. Only original hard copy drawings provided by Square D Company to its customers should be relied upon by its customers or others. If these drawings are to be used by the customer, they must first be verified against the Square D Company hard copy drawings.

REV	DESCRIPTION	BY	DATE
A	REV TEXT	BC	05/16/01

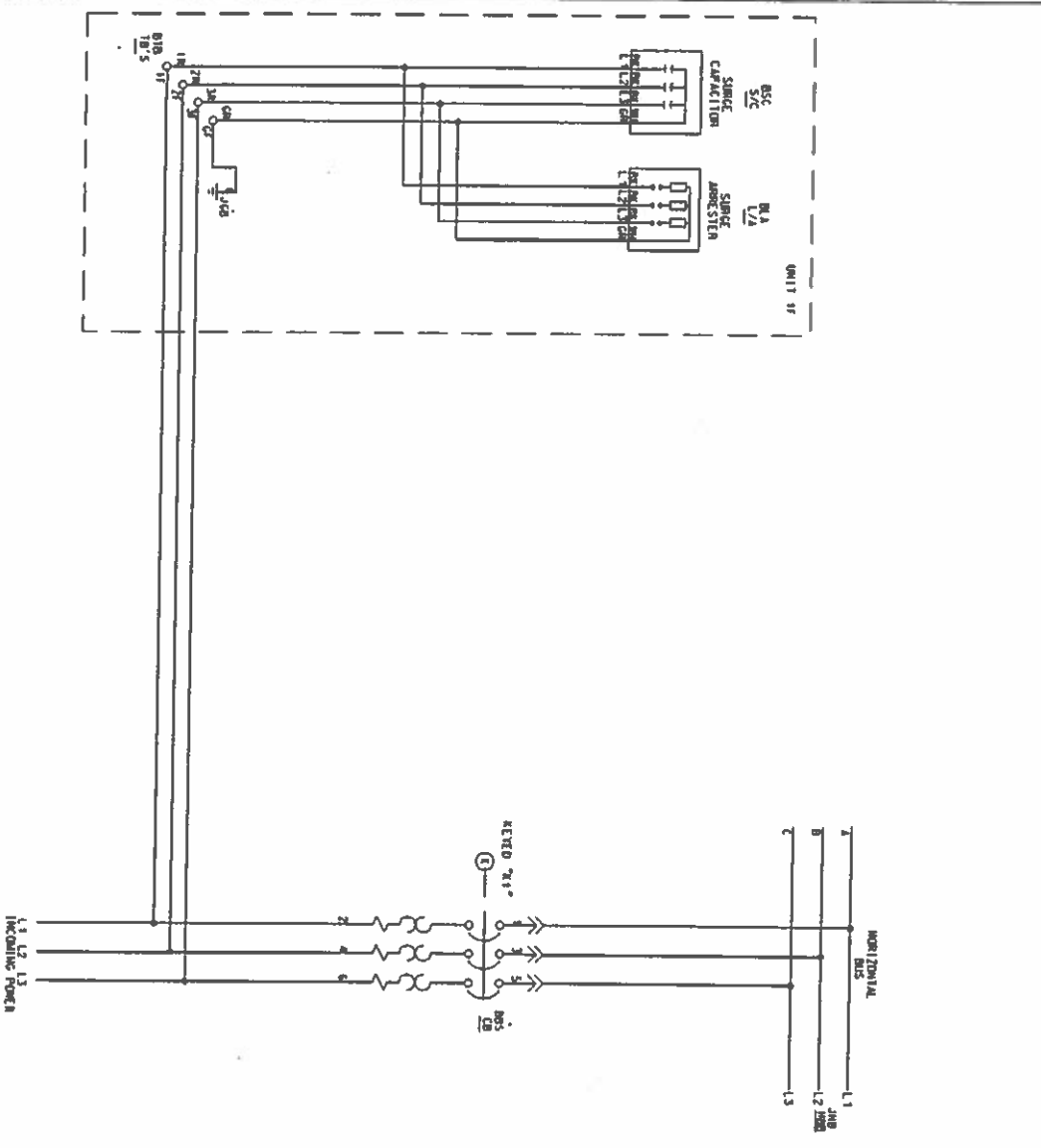

JOB NAME:	STORAGE POND IMPROVEMENTS	EQUIPMENT DESIGNATION:	MCC-1
JOB LOCATION:	MANATEE, FL	EQUIPMENT TYPE:	MODEL 6 MOTOR CONTROL CENTER
DESIGN NO:	VTL	DRAWING TYPE:	ELEMENTARY DIAGRAM
CHG#:	T-1	DATE:	APRIL 3, 2001
DRAWING STATUS:	RECORD	OWNER:	E14122970-009-03

**W A R N I N G -- THESE DRAWINGS MAY CONTAIN ERRORS
VERIFY AGAINST SQUARE D ORIGINAL HARD COPY DRAWINGS BEFORE USING**

These drawings have been translated from original drawings. The translation process can introduce errors into the drawings in unknown ways. Only original hard copy drawings provided by Square D Company to its customers should be relied upon by its customers or others. If these drawings are to be used by the customer, they must first be verified against the Square D Company hard copy drawings.

REV	DESCRIPTION	BY	DATE			
A	REV TEXT	DC	05/16/01			

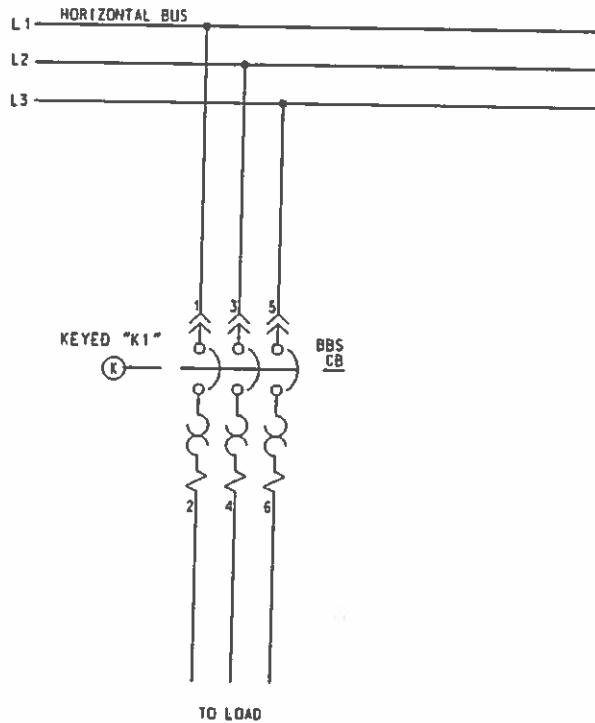

JOB NAME:	STORAGE POND IMPROVEMENTS	EQUIPMENT DESIGNATION:	MCC-1
JOB LOCATION:	MANATEE, FL	EQUIPMENT TYPE:	MODEL 6 MOTOR CONTROL CENTER
DRAWN BY:	VTL	DRAWING TYPE:	ELEMENTARY DIAGRAM
ENGR:	TLT	SQUARE D COMPANY	
DATE:	APRIL 3, 2001		
DRAWING STATUS:	RECORD	DWG#	E 14122970-009-04 PG 1 OF 1 REV A

**W A R N I N G -- THESE DRAWINGS MAY CONTAIN ERRORS
 VERIFY AGAINST SQUARE D ORIGINAL HARD COPY DRAWINGS BEFORE USING**

These drawings have been translated from original drawings. The translation process can introduce errors into the drawings in unknown ways. Only original hard copy drawings provided by Square D Company to its customers should be relied upon by its customers or others. If these drawings are to be used by the customer, they must first be verified against the Square D Company hard copy drawings.

REV	DESCRIPTION	BY	DATE			

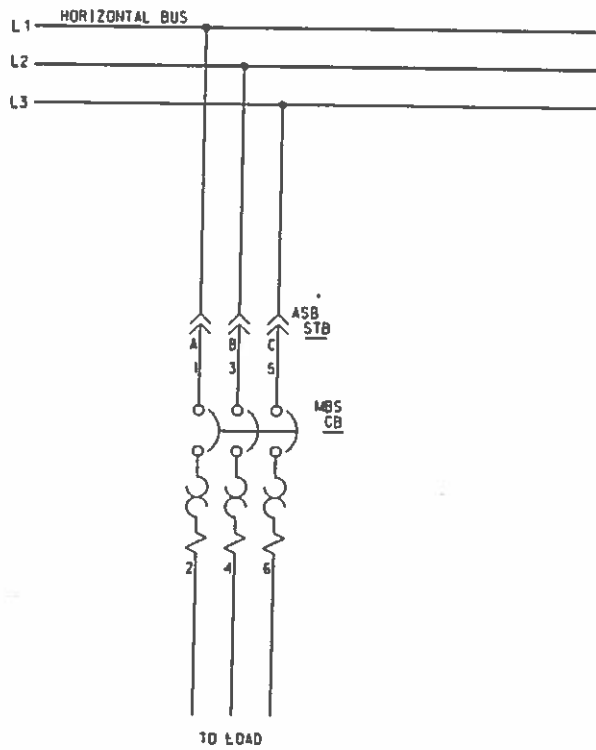

JOB NAME:	STORAGE POND IMPROVEMENTS	EQUIPMENT DESIGNATION:	MCC-1
JOB LOCATION:	MANATEE, FL	EQUIPMENT TYPE:	MODEL 6 MOTOR CONTROL CENTER
DRAWN BY:	VTL	DRAWING TYPE:	ELEMENTARY DIAGRAM
ENGR:	TLT	SQUARE D COMPANY	
DATE:	APRIL 3, 2001		
DRAWING STATUS:	RECORD	DWG#	E 14122970-009-05
		PG	1 OF 1
		REV	-

**W A R N I N G -- THESE DRAWINGS MAY CONTAIN ERRORS
 VERIFY AGAINST SQUARE D ORIGINAL HARD COPY DRAWINGS BEFORE USING**

These drawings have been translated from original drawings. The translation process can introduce errors into the drawings in unknown ways. Only original hard copy drawings provided by Square D Company to its customers should be relied upon by its customers or others. If these drawings are to be used by the customer, they must first be verified against the Square D Company hard copy drawings.

REV	DESCRIPTION	BY	DATE			

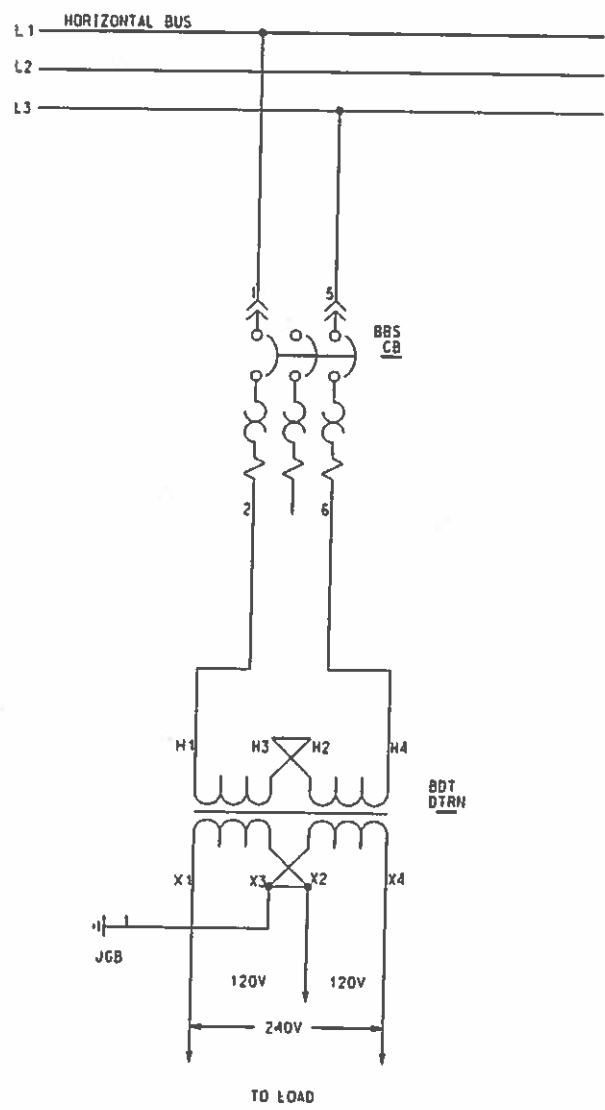

JOB NAME:	STORAGE POND IMPROVEMENTS	EQUIPMENT DESIGNATION:	MCC-1
JOB LOCATION:	MANATEE, FL	EQUIPMENT TYPE:	MODEL 6 MOTOR CONTROL CENTER
DRAWN BY:	VTL	DRAWING TYPE:	ELEMENTARY DIAGRAM
ENGR:	TLT	SQUARE D COMPANY	
DATE:	APRIL 3, 2001	DWG#	E14122970-009-06
DRAWING STATUS:	RECORD	PG	1 OF 1 REV -

**W A R N I N G -- THESE DRAWINGS MAY CONTAIN ERRORS
VERIFY AGAINST SQUARE D ORIGINAL HARD COPY DRAWINGS BEFORE USING**

These drawings have been translated from original drawings. The translation process can introduce errors into the drawings in unknown ways. Only original hard copy drawings provided by Square D Company to its customers should be relied upon by its customers or others. If these drawings are to be used by the customer, they must first be verified against the Square D Company hard copy drawings.

REV	DESCRIPTION	BY	DATE			

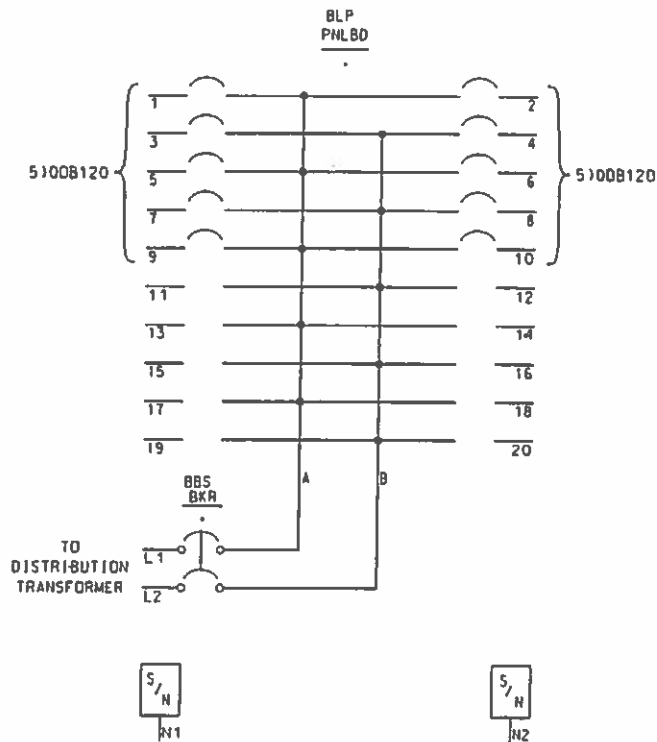

JOB NAME: STORAGE POND IMPROVEMENTS	EQUIPMENT DESIGNATION: MCC-2
JOB LOCATION: MANATEE, FL	EQUIPMENT TYPE: MODEL 6 MOTOR CONTROL CENTER
DRAWN BY: VTL	DRAWING TYPE: ELEMENTARY DIAGRAM
ENGR: YLT	SQUARE D COMPANY
DATE: APRIL 3, 2001	
DRAWING STATUS: RECORD	DWG# E14122970-010-02 PG 1 OF 1 REV. -

W A R N I N G --- THESE DRAWINGS MAY CONTAIN ERRORS
 VERIFY AGAINST SQUARE D ORIGINAL HARD COPY DRAWINGS BEFORE USING

These drawings have been translated from original drawings. The translation process can introduce errors into the drawings in unknown ways. Only original hard copy drawings provided by Square D Company to its customers should be relied upon by its customers or others. If these drawings are to be used by the customer, they must first be verified against the Square D Company hard copy drawings.

REV	DESCRIPTION	BY	DATE
A	REV TEXT	DC	05/16/01

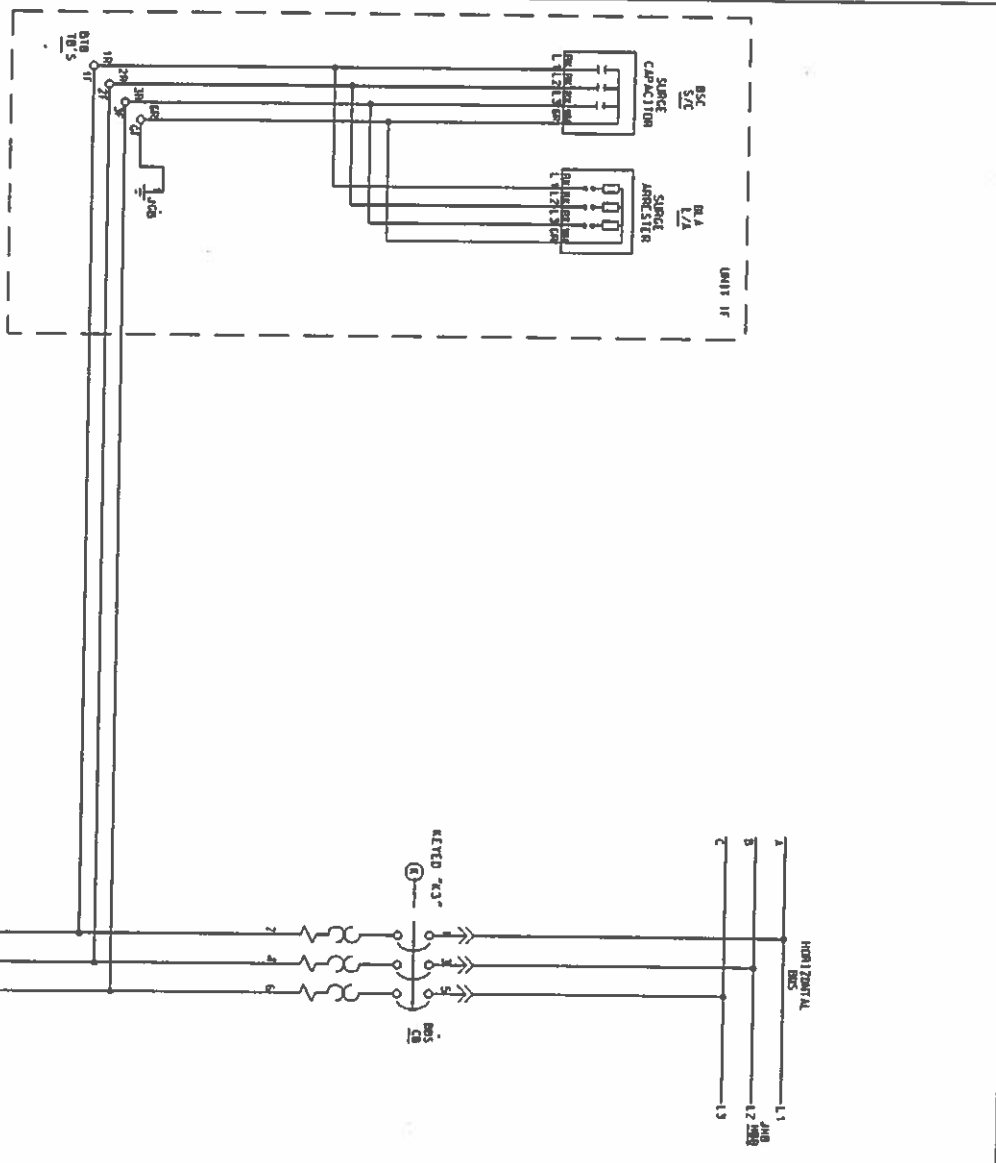

JOB NAME:	STEWART POND IMPROVEMENTS	EQUIPMENT DESIGNATION:	MCC-2
JOB LOCATION:	MANATEE, FL	EQUIPMENT TYPE:	MOTOR & MOTOR CONTROL CENTER
DRAWN BY:	VTL	DRAWING TYPE:	ELEMENTARY DIAGRAM
ENGINEER:	J.T.	DATE:	APRIL 3, 2001
DRAWING STATUS:	RECORD	DWG#	E14122970-010-03

SQUARE D COMPANY

**W A R N I N G -- THESE DRAWINGS MAY CONTAIN ERRORS
VERIFY AGAINST SQUARE D ORIGINAL HARD COPY DRAWINGS BEFORE USING**

These drawings have been translated from original drawings. The translation process can introduce errors into the drawings in unknown ways. Only original hard copy drawings provided by Square D Company to its customers should be relied upon by its customers or others. If these drawings are to be used by the customer, they must first be verified against the Square D Company hard copy drawings.

REV	DESCRIPTION	BY	DATE			
A	REV TEXT	DC	05/16/01			

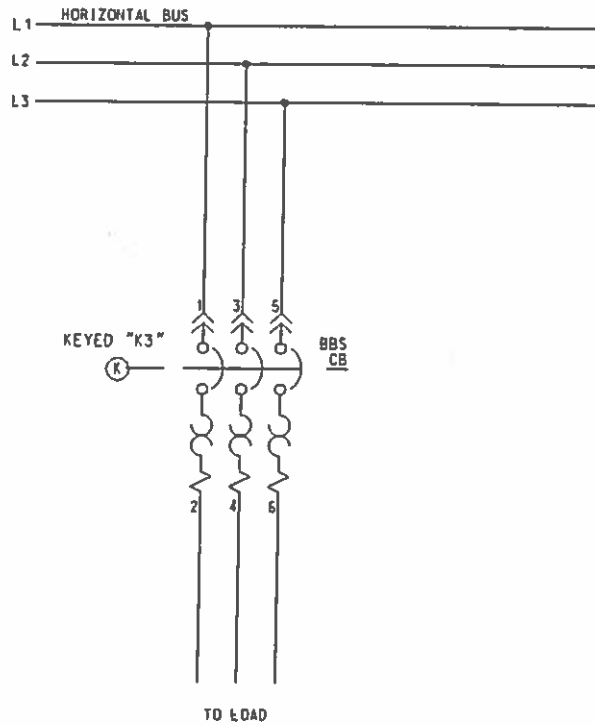

JOB NAME:	STORAGE POND IMPROVEMENTS	EQUIPMENT DESIGNATION:	MCC-2
JOB LOCATION:	MANATEE, FL	EQUIPMENT TYPE:	MODEL 6 MOTOR CONTROL CENTER
DRAWN BY:	VTL	DRAWING TYPE:	ELEMENTARY DIAGRAM
ENGR:	TLT	SQUARE D COMPANY	
DATE:	APRIL 3, 2001		
DRAWING STATUS:	RECORD	DWG#	E 14122970-010-04
		PG	1 OF 1
		REV	A

**W A R N I N G -- THESE DRAWINGS MAY CONTAIN ERRORS
VERIFY AGAINST SQUARE D ORIGINAL HARD COPY DRAWINGS BEFORE USING**

These drawings have been translated from original drawings. The translation process can introduce errors into the drawings in unknown ways. Only original hard copy drawings provided by Square D Company to its customers should be relied upon by its customers or others. If these drawings are to be used by the customer, they must first be verified against the Square D Company hard copy drawings.

REV	DESCRIPTION	BY	DATE			

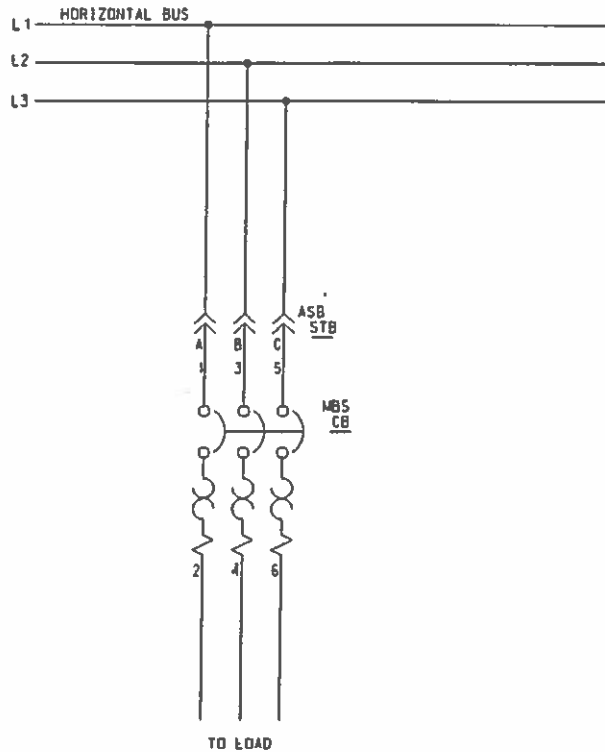

JOB NAME: STORAGE POND IMPROVEMENTS	EQUIPMENT DESIGNATION: MCC-2
JOB LOCATION: MANATEE, FL	EQUIPMENT TYPE: MODEL 6 MOTOR CONTROL CENTER
DRAWN BY: VTL	DRAWING TYPE: ELEMENTARY DIAGRAM
ENGR: TLT	SQUARE D COMPANY
DATE: APRIL 3, 2001	
DRAWING STATUS: RECORD	DWC# E 14122970-010-05 PG 1 OF 1 REV -

**W A R N I N G -- THESE DRAWINGS MAY CONTAIN ERRORS
VERIFY AGAINST SQUARE D ORIGINAL HARD COPY DRAWINGS BEFORE USING**

These drawings have been translated from original drawings. The translation process can introduce errors into the drawings in unknown ways. Only original hard copy drawings provided by Square D Company to its customers should be relied upon by its customers or others. If these drawings are to be used by the customer, they must first be verified against the Square D Company hard copy drawings.

REV	DESCRIPTION	BY	DATE			

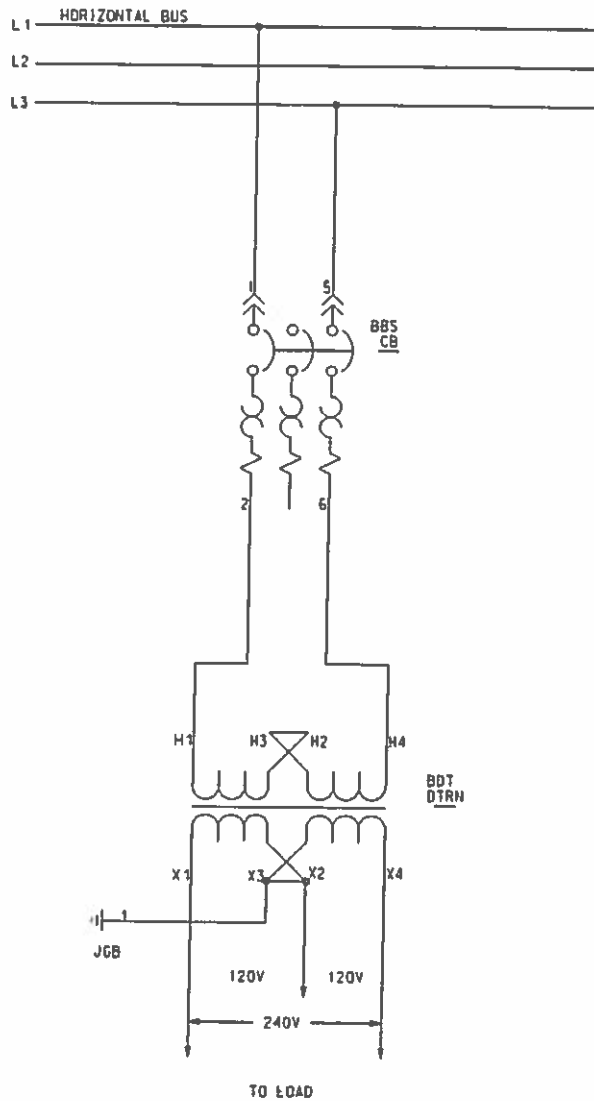

JOB NAME: STORAGE POND IMPROVEMENTS	EQUIPMENT DESIGNATION: MCC-2
JOB LOCATION: MANATEE, FL	EQUIPMENT TYPE: MODEL 6 MOTOR CONTROL CENTER
DRAWN BY: VTL	DRAWING TYPE: ELEMENTARY DIAGRAM
ENGR: TLT	SQUARE D COMPANY
DATE: APRIL 3, 2001	
DRAWING STATUS: RECORD	DWG# E14122970-010-06 PG 1 OF 1 REV -

**W A R N I N G -- THESE DRAWINGS MAY CONTAIN ERRORS
VERIFY AGAINST SQUARE D ORIGINAL HARD COPY DRAWINGS BEFORE USING**

These drawings have been translated from original drawings. The translation process can introduce errors into the drawings in unknown ways. Only original hard copy drawings provided by Square D Company to its customers should be relied upon by its customers or others. If these drawings are to be used by the customer, they must first be verified against the Square D Company hard copy drawings.

REV	DESCRIPTION	BY	DATE			

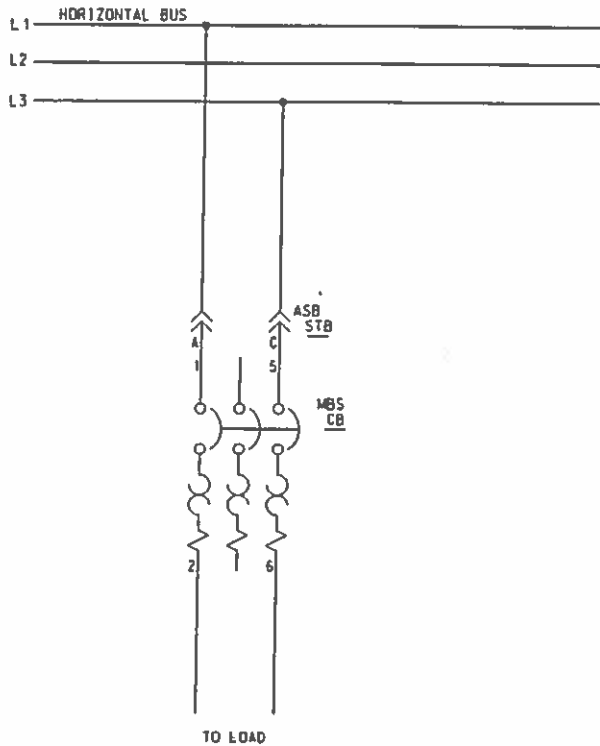

JOB NAME: STORAGE POND IMPROVEMENTS	EQUIPMENT DESIGNATION: MCC-2
JOB LOCATION: MANATEE, FL	EQUIPMENT TYPE: MODEL & MOTOR CONTROL CENTER
DRAWN BY: VTL	DRAWING TYPE: ELEMENTARY DIAGRAM
ENGR:	SQUARE D COMPANY
DATE: APRIL 3, 2001	
DRAWING STATUS: RECORD	DWG# E 14122970-010-07 PG 1 OF 1 REV -

W A R N I N G --- THESE DRAWINGS MAY CONTAIN ERRORS
 VERIFY AGAINST SQUARE D ORIGINAL HARD COPY DRAWINGS BEFORE USING

These drawings have been translated from original drawings. The translation process can introduce errors into the drawings in unknown ways. Only original hard copy drawings provided by Square D Company to its customers should be relied upon by its customers or others. If these drawings are to be used by the customer, they must first be verified against the Square D Company hard copy drawings.

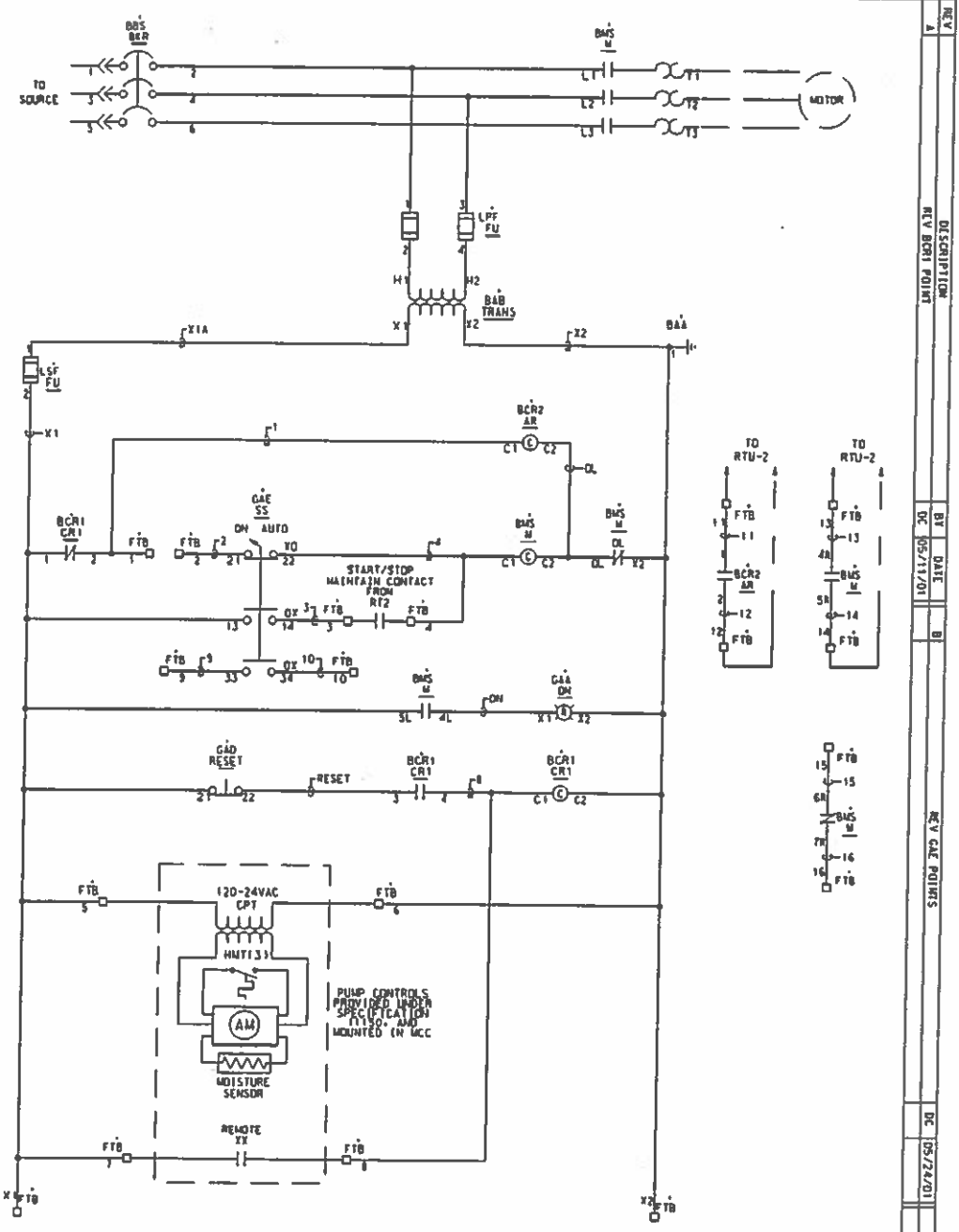

REV	DESCRIPTION	BY	DATE	REV	DATE POINTS
A	REV BCR1 POINT	DC	05/11/01	B	DC 105/22/01

JOB NAME	STORAGE POND IMPROVEMENTS	EQUIPMENT DESIGNATION	MCC-3
JOB LOCATION	MANATEE, FL	EQUIPMENT TYPE	MOTOR CONTROL CENTER
DRAWN BY	VLT	DRAWING TYPE	ELEMENTARY DIAGRAM
DATE	APRIL 3, 2001	DWG NO.	E14122970-011-01
DRAWING STATUS	RECORD		

SQUARE D COMPANY
 Pg 1 of 1 REV B

**W A R N I N G -- THESE DRAWINGS MAY CONTAIN ERRORS
VERIFY AGAINST SQUARE D ORIGINAL HARD COPY DRAWINGS BEFORE USING**

These drawings have been translated from original drawings. The translation process can introduce errors into the drawings in unknown ways. Only original hard copy drawings provided by Square D Company to its customers should be relied upon by its customers or others. If these drawings are to be used by the customer, they must first be verified against the Square D Company hard copy drawings.

REV	DESCRIPTION	BY	DATE			

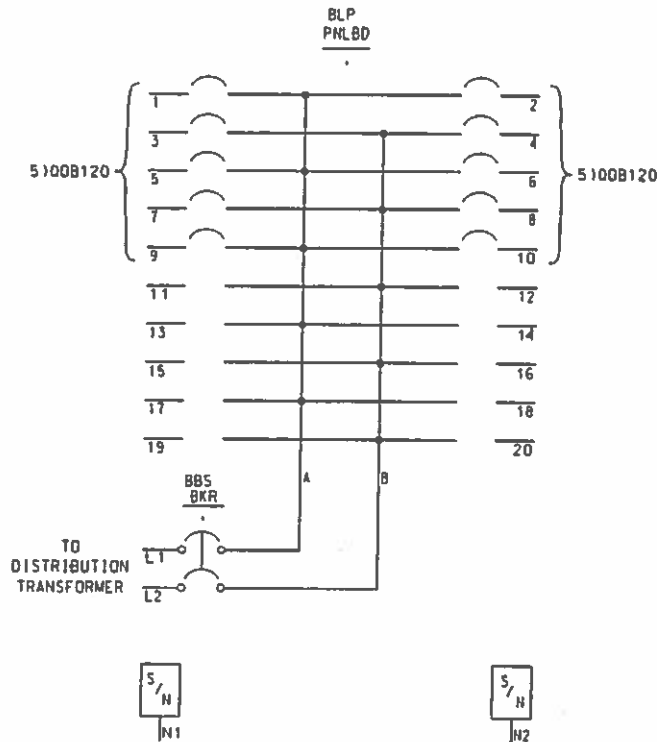

JOB NAME: STORAGE POND IMPROVEMENTS	EQUIPMENT DESIGNATION: MCC-3
JOB LOCATION: MANATEE, FL	EQUIPMENT TYPE: MODEL 6 MOTOR CONTROL CENTER
DRAWN BY: VTL	DRAWING TYPE: ELEMENTARY DIAGRAM
ENGR: TLT	SQUARE D COMPANY
DATE: APRIL 3, 2001	DWG# E 14122970-011-02
DRAWING STATUS: RECORD	PG 1 OF 1 REV -

W A R N I N G --- THESE DRAWINGS MAY CONTAIN ERRORS
 VERIFY AGAINST SQUARE D ORIGINAL HARD COPY DRAWINGS BEFORE USING

These drawings have been translated from original drawings. The translation process can introduce errors into the drawings in unknown ways. Only original hard copy drawings provided by Square D Company to its customers should be relied upon by its customers or others. If these drawings are to be used by the customer, they must first be verified against the Square D Company hard copy drawings.

REV	DESCRIPTION	BY	DATE
1	REV TEST	DC	05/16/01

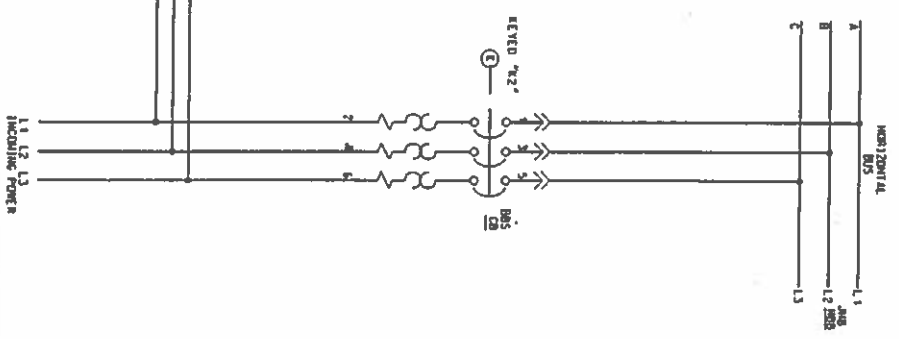
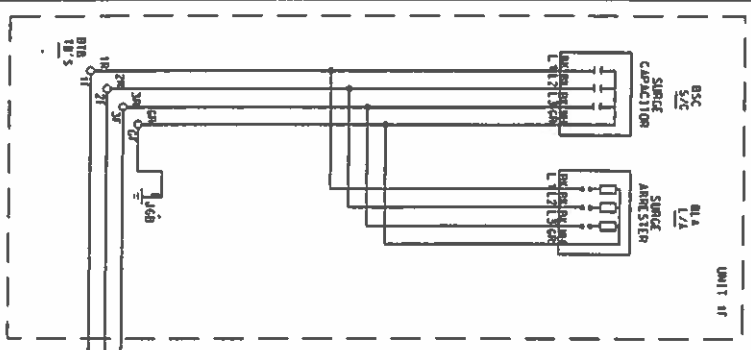

JOB NAME:	STORAGE POND IMPROVEMENTS	EQUIPMENT DESIGNATION:	MCC-3
JOB LOCATION:	MANATEE, FL	EQUIPMENT TYPE:	MOTOR & MOTOR CONTROL CENTER
DRAWN BY:	VLT	DRAWING TYPE:	ELEMENTARY DIAGRAM
DATE:	APRIL 3, 2001		
DRAWING STATUS:	RECORD		

1 of 1 REV A

**W A R N I N G -- THESE DRAWINGS MAY CONTAIN ERRORS
VERIFY AGAINST SQUARE D ORIGINAL HARD COPY DRAWINGS BEFORE USING**

These drawings have been translated from original drawings. The translation process can introduce errors into the drawings in unknown ways. Only original hard copy drawings provided by Square D Company to its customers should be relied upon by its customers or others. If these drawings are to be used by the customer, they must first be verified against the Square D Company hard copy drawings.

REV	DESCRIPTION	BY	DATE			

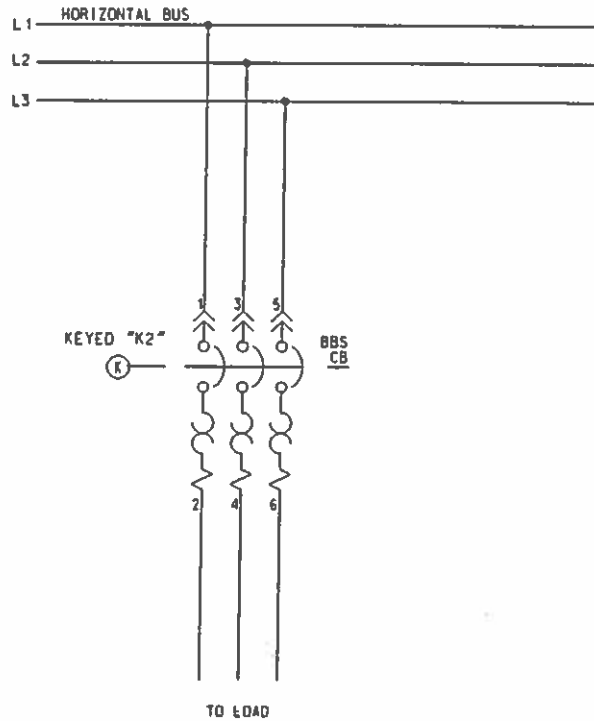

JOB NAME: STORAGE POND IMPROVEMENTS	EQUIPMENT DESIGNATION: MCC-3
JOB LOCATION: MANATEE, FL	EQUIPMENT TYPE: MODEL 6 MOTOR CONTROL CENTER
DRAWN BY: VTL	DRAWING TYPE: ELEMENTARY DIAGRAM
ENGR: TLT	SQUARE D COMPANY
DATE: APRIL 3, 2001	
DRAWING STATUS: RECORD	DWG# E14122970-011-04
PG 1 OF 1 REV A	

**W A R N I N G -- THESE DRAWINGS MAY CONTAIN ERRORS
VERIFY AGAINST SQUARE D ORIGINAL HARD COPY DRAWINGS BEFORE USING**

These drawings have been translated from original drawings. The translation process can introduce errors into the drawings in unknown ways. Only original hard copy drawings provided by Square D Company to its customers should be relied upon by its customers or others. If these drawings are to be used by the customer, they must first be verified against the Square D Company hard copy drawings.

REV	DESCRIPTION	BY	DATE			

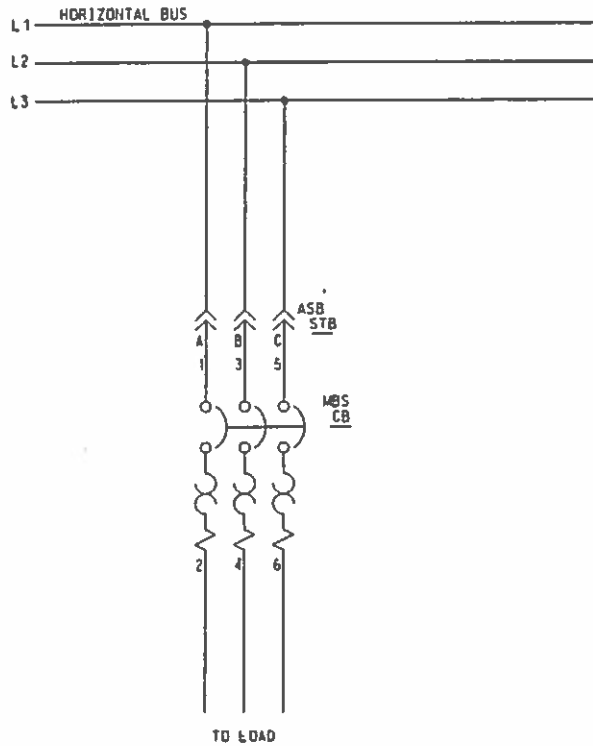

JOB NAME: STORAGE POND IMPROVEMENTS	EQUIPMENT DESIGNATION: MCC-3
JOB LOCATION: MANATEE, FL	EQUIPMENT TYPE: MODEL 6 MOTOR CONTROL CENTER
DRAWN BY: VTL	DRAWING TYPE: ELEMENTARY DIAGRAM
ENGR: TLT	SQUARE D COMPANY
DATE: APRIL 3, 2001	
DRAWING STATUS: RECORD	DWG# E14122970-011-05 PG 1 OF 1 REV -

**W A R N I N G -- THESE DRAWINGS MAY CONTAIN ERRORS
VERIFY AGAINST SQUARE D ORIGINAL HARD COPY DRAWINGS BEFORE USING**

These drawings have been translated from original drawings. The translation process can introduce errors into the drawings in unknown ways. Only original hard copy drawings provided by Square D Company to its customers should be relied upon by its customers or others. If these drawings are to be used by the customer, they must first be verified against the Square D Company hard copy drawings.

REV	DESCRIPTION	BY	DATE			

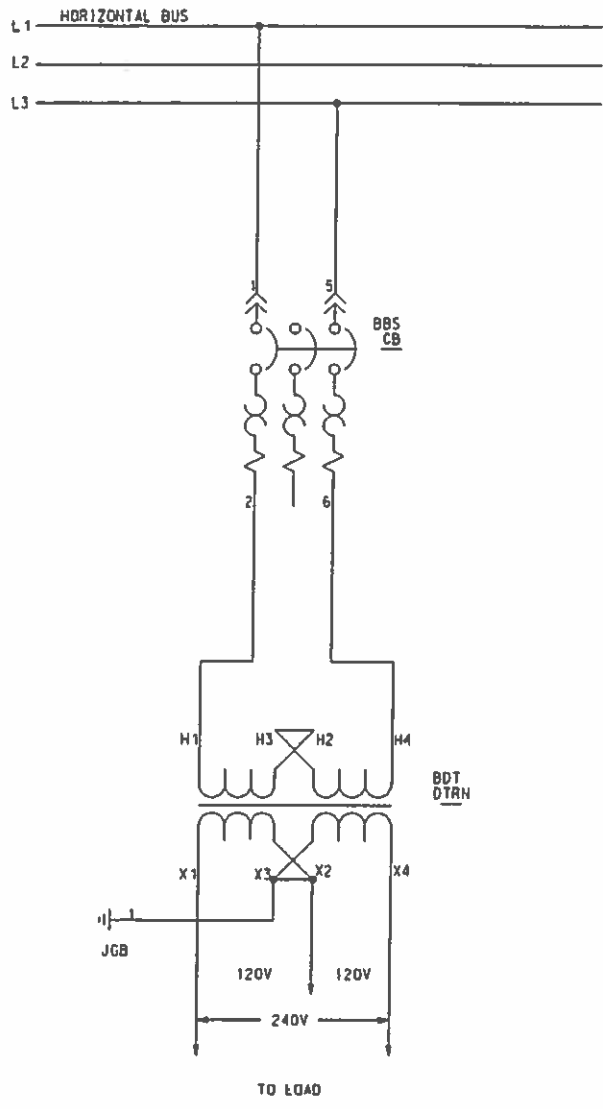

JOB NAME: STORAGE POND IMPROVEMTES	EQUIPMENT DESIGNATION: MCC-3
JOB LOCATION: MANATEE, FL	EQUIPMENT TYPE: MODEL 6 MOTOR CONTROL CENTER
DRAWN BY: VTL	DRAWING TYPE: ELEMENTARY DIAGRAM
ENGR: TLT	SQUARE D COMPANY
DATE: APRIL 3, 2001	
DRAWING STATUS: RECORD	DWG# E14122970-011-06 Pg 1 OF 1 REV -

W A R N I N G -- THESE DRAWINGS MAY CONTAIN ERRORS
 VERIFY AGAINST SQUARE D ORIGINAL HARD COPY DRAWINGS BEFORE USING

These drawings have been translated from original drawings. The translation process can introduce errors into the drawings in unknown ways. Only original hard copy drawings provided by Square D Company to its customers should be relied upon by its customers or others. If these drawings are to be used by the customer, they must first be verified against the Square D Company hard copy drawings.

REV	DESCRIPTION	BY	DATE

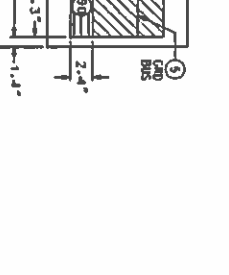
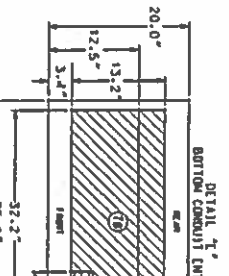
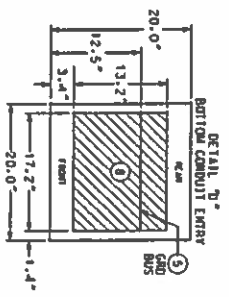
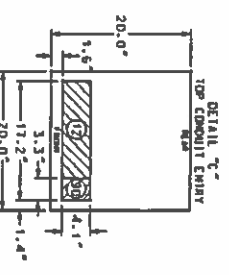
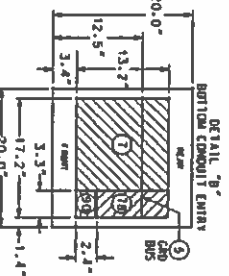
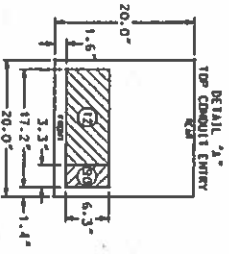
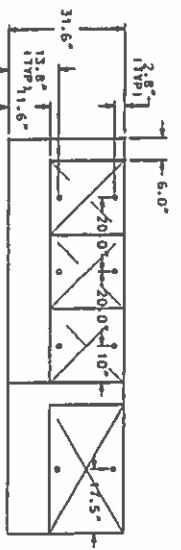
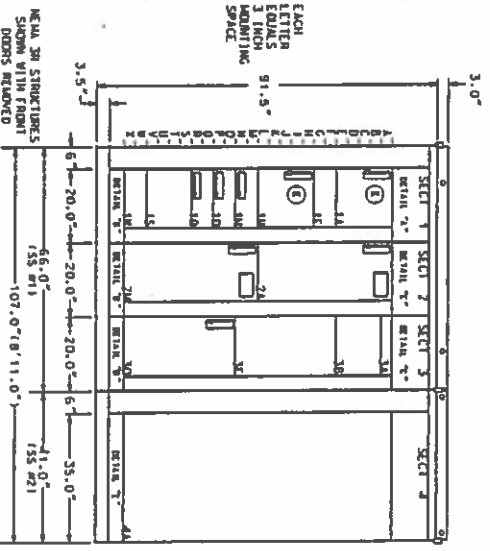
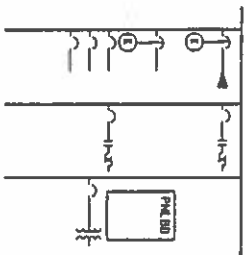

CROSSHATCHED AREA REPRESENTS CONDUIT ENTRY AREA. NUMBERS IN CIRCLES INDICATE VERTICAL CLEARANCE IN INCHES TO NEAREST OBSTRUCTION. ALL DETAILS ARE TOP VIEW.

MODEL 6
 MOTOR CONTROL CENTER
 INDUSTRIAL PACKAGE

FRONT ELEVATION

FLOOR PLAN

GENERAL NOTES

- ENCLOSURE DATA:
 - ENCLOSURE CLASS: 1 TYPE B WIRING
 - PANEL SYSTEM: 240 VOLT 3 PHASE 3 WIRE 60 HZ
 - 22-000 APPS SHORT CIRCUIT RATING
 - POWER ENTERS MAIN BREAKER TOP SECTION 1
- FED BY:
 - INCORPORATE PANEL DATA
 - GROUND CABLE QUANTITY: 1 1/2 250 MCM
 - MAIN HORIZONTAL BUS: 0600 AMP T1M PLATED COPPER
 - VERTICAL BUS: 0200 AMP T1M PLATED COPPER
 - VERTICAL CONDUIT BUS: 25X1.10 COPPER
 - WIRING SHALL BE CONFORMED TO STRUCTURE
- ENCLOSURE DATA:
 - ENCLOSURE CLASSIFICATION: FINISH 489 MEDIUM LIGHT GREY
 - ENCLOSURE TYPE: 1
 - APPROX. SHIPPING WEIGHT: 1567
 - SHIPPING SPLIT # 1: 3150lbs.
 - SHIPPING SPLIT # 2: 1050lbs.
 - SHIPPING SPLIT # 3: 1050lbs.
 - SHIPPING SPLIT # 4: 1050lbs.
 - SHIPPING SPLIT # 5: 1050lbs.
 - SHIPPING SPLIT # 6: 1050lbs.
 - SHIPPING SPLIT # 7: 1050lbs.
 - SHIPPING SPLIT # 8: 1050lbs.
 - SHIPPING SPLIT # 9: 1050lbs.
 - SHIPPING SPLIT # 10: 1050lbs.
 - SHIPPING SPLIT # 11: 1050lbs.
 - SHIPPING SPLIT # 12: 1050lbs.
 - SHIPPING SPLIT # 13: 1050lbs.
 - SHIPPING SPLIT # 14: 1050lbs.
 - SHIPPING SPLIT # 15: 1050lbs.
 - SHIPPING SPLIT # 16: 1050lbs.
 - SHIPPING SPLIT # 17: 1050lbs.
 - SHIPPING SPLIT # 18: 1050lbs.
 - SHIPPING SPLIT # 19: 1050lbs.
 - SHIPPING SPLIT # 20: 1050lbs.
 - SHIPPING SPLIT # 21: 1050lbs.
 - SHIPPING SPLIT # 22: 1050lbs.
 - SHIPPING SPLIT # 23: 1050lbs.
 - SHIPPING SPLIT # 24: 1050lbs.
 - SHIPPING SPLIT # 25: 1050lbs.
 - SHIPPING SPLIT # 26: 1050lbs.
 - SHIPPING SPLIT # 27: 1050lbs.
 - SHIPPING SPLIT # 28: 1050lbs.
 - SHIPPING SPLIT # 29: 1050lbs.
 - SHIPPING SPLIT # 30: 1050lbs.
 - SHIPPING SPLIT # 31: 1050lbs.
 - SHIPPING SPLIT # 32: 1050lbs.
 - SHIPPING SPLIT # 33: 1050lbs.
 - SHIPPING SPLIT # 34: 1050lbs.
 - SHIPPING SPLIT # 35: 1050lbs.
 - SHIPPING SPLIT # 36: 1050lbs.
 - SHIPPING SPLIT # 37: 1050lbs.
 - SHIPPING SPLIT # 38: 1050lbs.
 - SHIPPING SPLIT # 39: 1050lbs.
 - SHIPPING SPLIT # 40: 1050lbs.
 - SHIPPING SPLIT # 41: 1050lbs.
 - SHIPPING SPLIT # 42: 1050lbs.
 - SHIPPING SPLIT # 43: 1050lbs.
 - SHIPPING SPLIT # 44: 1050lbs.
 - SHIPPING SPLIT # 45: 1050lbs.
 - SHIPPING SPLIT # 46: 1050lbs.
 - SHIPPING SPLIT # 47: 1050lbs.
 - SHIPPING SPLIT # 48: 1050lbs.
 - SHIPPING SPLIT # 49: 1050lbs.
 - SHIPPING SPLIT # 50: 1050lbs.
 - SHIPPING SPLIT # 51: 1050lbs.
 - SHIPPING SPLIT # 52: 1050lbs.
 - SHIPPING SPLIT # 53: 1050lbs.
 - SHIPPING SPLIT # 54: 1050lbs.
 - SHIPPING SPLIT # 55: 1050lbs.
 - SHIPPING SPLIT # 56: 1050lbs.
 - SHIPPING SPLIT # 57: 1050lbs.
 - SHIPPING SPLIT # 58: 1050lbs.
 - SHIPPING SPLIT # 59: 1050lbs.
 - SHIPPING SPLIT # 60: 1050lbs.
 - SHIPPING SPLIT # 61: 1050lbs.
 - SHIPPING SPLIT # 62: 1050lbs.
 - SHIPPING SPLIT # 63: 1050lbs.
 - SHIPPING SPLIT # 64: 1050lbs.
 - SHIPPING SPLIT # 65: 1050lbs.
 - SHIPPING SPLIT # 66: 1050lbs.
 - SHIPPING SPLIT # 67: 1050lbs.
 - SHIPPING SPLIT # 68: 1050lbs.
 - SHIPPING SPLIT # 69: 1050lbs.
 - SHIPPING SPLIT # 70: 1050lbs.
 - SHIPPING SPLIT # 71: 1050lbs.
 - SHIPPING SPLIT # 72: 1050lbs.
 - SHIPPING SPLIT # 73: 1050lbs.
 - SHIPPING SPLIT # 74: 1050lbs.
 - SHIPPING SPLIT # 75: 1050lbs.
 - SHIPPING SPLIT # 76: 1050lbs.
 - SHIPPING SPLIT # 77: 1050lbs.
 - SHIPPING SPLIT # 78: 1050lbs.
 - SHIPPING SPLIT # 79: 1050lbs.
 - SHIPPING SPLIT # 80: 1050lbs.
 - SHIPPING SPLIT # 81: 1050lbs.
 - SHIPPING SPLIT # 82: 1050lbs.
 - SHIPPING SPLIT # 83: 1050lbs.
 - SHIPPING SPLIT # 84: 1050lbs.
 - SHIPPING SPLIT # 85: 1050lbs.
 - SHIPPING SPLIT # 86: 1050lbs.
 - SHIPPING SPLIT # 87: 1050lbs.
 - SHIPPING SPLIT # 88: 1050lbs.
 - SHIPPING SPLIT # 89: 1050lbs.
 - SHIPPING SPLIT # 90: 1050lbs.
 - SHIPPING SPLIT # 91: 1050lbs.
 - SHIPPING SPLIT # 92: 1050lbs.
 - SHIPPING SPLIT # 93: 1050lbs.
 - SHIPPING SPLIT # 94: 1050lbs.
 - SHIPPING SPLIT # 95: 1050lbs.
 - SHIPPING SPLIT # 96: 1050lbs.
 - SHIPPING SPLIT # 97: 1050lbs.
 - SHIPPING SPLIT # 98: 1050lbs.
 - SHIPPING SPLIT # 99: 1050lbs.
 - SHIPPING SPLIT # 100: 1050lbs.

SECTION LOCATION	FOR NAME	FOR LOCATION	STORAGE POINT IDENTIFIERS	EQUIPMENT DESIGNATION	MODEL & MOTOR CONTROL CENTER ELEVATION
SECTION LOCATION WITHIN 28 STRUC	SECTION 1	MANATEE, FL		MC-2	
	SECTION 2				
	SECTION 3				
	SECTION 4				
	SECTION 5				
	SECTION 6				
	SECTION 7				
	SECTION 8				
	SECTION 9				
	SECTION 10				
	SECTION 11				
	SECTION 12				
	SECTION 13				
	SECTION 14				
	SECTION 15				
	SECTION 16				
	SECTION 17				
	SECTION 18				
	SECTION 19				
	SECTION 20				
	SECTION 21				
	SECTION 22				
	SECTION 23				
	SECTION 24				
	SECTION 25				
	SECTION 26				
	SECTION 27				
	SECTION 28				
	SECTION 29				
	SECTION 30				
	SECTION 31				
	SECTION 32				
	SECTION 33				
	SECTION 34				
	SECTION 35				
	SECTION 36				
	SECTION 37				
	SECTION 38				
	SECTION 39				
	SECTION 40				
	SECTION 41				
	SECTION 42				
	SECTION 43				
	SECTION 44				
	SECTION 45				
	SECTION 46				
	SECTION 47				
	SECTION 48				
	SECTION 49				
	SECTION 50				
	SECTION 51				
	SECTION 52				
	SECTION 53				
	SECTION 54				
	SECTION 55				
	SECTION 56				
	SECTION 57				
	SECTION 58				
	SECTION 59				
	SECTION 60				
	SECTION 61				
	SECTION 62				
	SECTION 63				
	SECTION 64				
	SECTION 65				
	SECTION 66				
	SECTION 67				
	SECTION 68				
	SECTION 69				
	SECTION 70				
	SECTION 71				
	SECTION 72				
	SECTION 73				
	SECTION 74				
	SECTION 75				
	SECTION 76				
	SECTION 77				
	SECTION 78				
	SECTION 79				
	SECTION 80				
	SECTION 81				
	SECTION 82				
	SECTION 83				
	SECTION 84				
	SECTION 85				
	SECTION 86				
	SECTION 87				
	SECTION 88				
	SECTION 89				
	SECTION 90				
	SECTION 91				
	SECTION 92				
	SECTION 93				
	SECTION 94				
	SECTION 95				
	SECTION 96				
	SECTION 97				
	SECTION 98				
	SECTION 99				
	SECTION 100				

W A R N I N G --- THESE DRAWINGS MAY CONTAIN ERRORS
 VERIFY AGAINST SQUARE D ORIGINAL HARD COPY DRAWINGS BEFORE USING

These drawings have been translated from original drawings. The translation process can introduce errors into the drawings in unknown ways. Only original hard copy drawings provided by Square D Company to its customers should be relied upon by its customers or others. If these drawings are to be used by the customer, they must first be verified against the Square D Company hard copy drawings.

REV	DESCRIPTION	BY	DATE

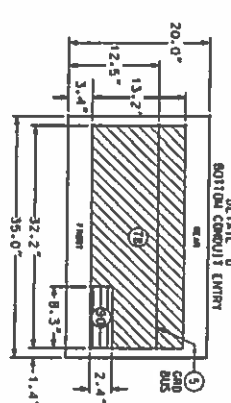
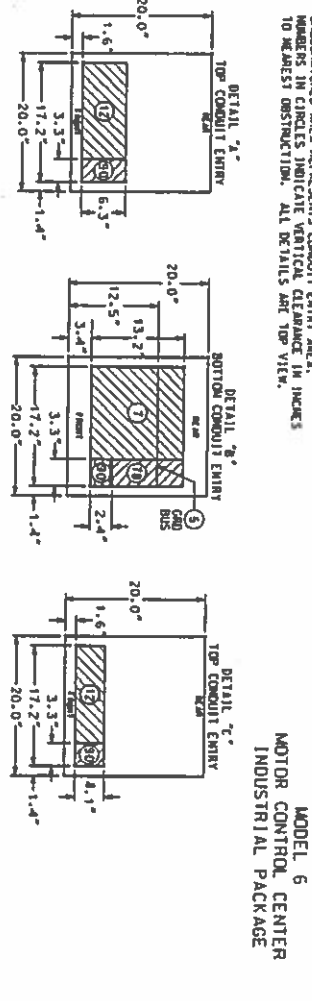
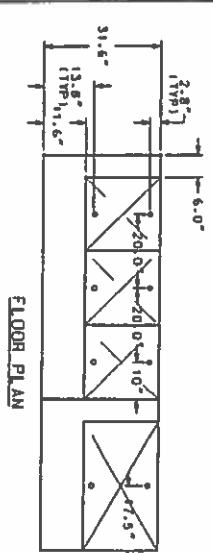
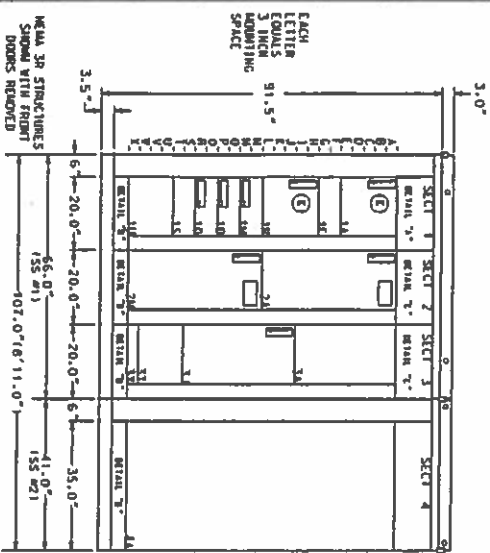
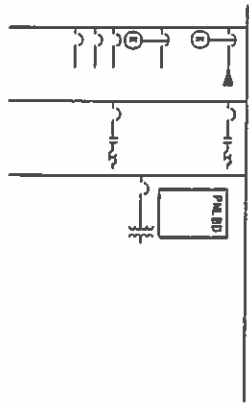

GENERAL NOTES

MEKA CLASS 1 TYPE B WIRING
 POWER SYSTEM DATA:
 480 VOLTS 3 PHASE 3 WIRE 60 HZ
 22,000 AMP SHORT CIRCUIT RATING
 FED BY ENTENS MAIN BREAKER TOP SECTION 1
 INCOMING CABLE DATA:
 POWER CABLE: QUANTITY (3) 350 MCM PER PHASE
 GROUND CABLE QUANTITY (1) 250 MCM
 BUS SYSTEM DATA:
 VERTICAL BUS: 480V, BUS: 0600 AMP 7M PLATED COPPER
 HORIZONTAL BUS: 480V, BUS: 250V, 10 COPPER
 HORIZONTAL GROUND BUS: 250V, 10 COPPER
 UNITS SECURELY GROUND TO STRUCTURE

ENCLOSURE DATA:
 ENCLOSURE POSITION FINISH: 489 MEDIUM LIGHT GREY
 20" DEEP MEKA TYPE 3B OUTDOOR ENCLOSURE
 APPROX. SHIPPING WEIGHTS:
 SHIPPING WEIGHT # 1: 3150lbs. TOTAL: 4200lbs.
 SHIPPING WEIGHT # 2: 1050lbs.
 SHIPPING WEIGHT # 3: 1-2,3
 CU VERT CRD BUS: 1-2,3
 FISHPANE BAR: 1-2,3
 MASTER HP GREY: 1

LEGEND

SECTION LOCATION WITHIN 3B STRUCTURE	SEE SECTION DETAILS FOR CONDUIT ENTRY
--------------------------------------	---------------------------------------

JOB NAME	STORAGE BOND IMPROVEMENTS
JOB LOCATION	MANATEE, FL
DRAWING BY	VLT
DATE	APRIL 3, 2001
DRAWING STATUS	RECORD

EQUIPMENT DESIGNATION	MODEL	6 MOTOR CONTROL CENTER
EQUIPMENT TYPE	ELEVATION	

DRWG F.14172970-011-01

**W A R N I N G -- THESE DRAWINGS MAY CONTAIN ERRORS
VERIFY AGAINST SQUARE D ORIGINAL HARD COPY DRAWINGS BEFORE USING**

These drawings have been translated from original drawings. The translation process can introduce errors into the drawings in unknown ways. Only original hard copy drawings provided by Square D Company to its customers should be relied upon by its customers or others. If these drawings are to be used by the customer, they must first be verified against the Square D Company hard copy drawings.

REV	DESCRIPTION	BY	DATE								
A	REV DISC AMPS	DC	05/10/01								
COMPONENT INFORMATION											
MCC DESIGNATION											
MCC-1								CONTROL (or DISTRIBUTION) TRANSFORMER			
UNIT LOC	NAMEPLATE DESIGNATION	UNIT TYPE	SIZE	HP	DISC AMPS	VA	FUSE SIZE		UNIT FEATURES	DRAWING NUMBER	
							PRJ	SEC			
1A	MAIN BREAKER	MN.BKR			250				U232.Y532.U678.L3. U291.Y141	E14122970-009-03-1	
1F	SURGE ARRESTER	MT.UNIT							U678.L3.U291		
1H	AUXILIARY POWER RECEPTACLE	BR.BKR			200				U678.L3.Y141	E14122970-009-04-1	
1M	SPARE	6"BRBKR			20				U678	E14122970-009-05-1	
1O	SPARE	6"BRBKR			20				U678	E14122970-009-05-1	
1Q	SPARE	6"BRBKR			20				U678	E14122970-009-05-1	
1S		SPACE							U678		
1W		SPACE							U678		
2A	SUBMERSIBLE PUMP SP-1-1	FVNR	4	75	250	300	1.6	3.2	FT.X11.A11.R174.C2. U112.P1.N300.U678. U258.L3	E14122970-009-01-1	
2M	SUBMERSIBLE PUMP SP-1-2	FVNR	4	75	250	300	1.6	3.2	FT.X11.A11.R174.C2. U112.P1.N300.U678. U258.L3	E14122970-009-01-1	
3A		SPACE									
3B	RELAY PANEL 1	MT.UNIT							U678.L3		
3F	LP1	PANELBD			25				U372.U678.L3.BB1	E14122970-009-02-1	
3O		1PXFMR			15	(5K)			U243.U678.L3	E14122970-009-06-1	
4A	RELAY SECTION	MT.UNIT							U678.L3		
A11 ADDL PB		BB1 BR BKR INSTALLED		C2 ON-AUTO SS		FT FUSED CTRL XFMR					
L3 WHITE INTERIORS		N300 CNTRL XFMR TAPS		P1 RED ON P.L.		R174 X040 RELAY					
U112 12" DR/UNIT EXT		U232 SERV ENTR LABEL		U243 UNIT MOUNTED		U258 WIRE LABELS					
U291 SURGE PRDT.		U372 FED FROM XFMR		U678 UNIT NP GREY		X11 1 NO 1 NC INTK.					
Y141 KEY INTERLOCK		Y532 HIGH IC BREAKER									
JOB NAME: STORAGE POND IMPROVEMENTS				EQUIPMENT DESIGNATION: MCC-1							
JOB LOCATION: MANATEE, FL				EQUIPMENT TYPE: MODEL 6 MOTOR CONTROL CENTER							
DRAWN BY: VTL				DRAWING TYPE: COMPONENT INFORMATION							
ENGR: JLT				 SQUARE D COMPANY							
DATE: APRIL 3, 2001											
DRAWING STATUS: RECORD				DWG# I 14122970-009-01				PG 1 OF 1		REV A	

**W A R N I N G -- THESE DRAWINGS MAY CONTAIN ERRORS
VERIFY AGAINST SQUARE D ORIGINAL HARD COPY DRAWINGS BEFORE USING**

These drawings have been translated from original drawings. The translation process can introduce errors into the drawings in unknown ways. Only original hard copy drawings provided by Square D Company to its customers should be relied upon by its customers or others. If these drawings are to be used by the customer, they must first be verified against the Square D Company hard copy drawings.

REV	DESCRIPTION	BY	DATE																										
A	REV DISC AMPS	DC	05/10/01																										
COMPONENT INFORMATION																													
MCC DESIGNATION																													
				MCC-2		CONTROL (or DISTRIBUTION) TRANSFORMER																							
UNIT LOC	NAMEPLATE DESIGNATION	UNIT TYPE	SIZE	HP	DISC AMPS	VA	FUSE SIZE		UNIT FEATURES	DRAWING NUMBER																			
							PR1	SEC																					
1A	MAIN BREAKER	MN.BKR			250				U232.Y532.U678.L3, U291.Y141	E14122970-010-03-1																			
1F	SURGE ARRESTER	MT.UNIT							U678.L3.U291																				
1H	AUXILIARY POWER RECPACLE	BR.BKR			200				U678.L3.Y141	E14122970-010-04-1																			
1M	SPARE	6"BRBKR			20				U678	E14122970-010-05-1																			
1O	SPARE	6"BRBKR			20				U678	E14122970-010-05-1																			
1O	POWER CENTER PC2	6"BRBKR			20				U678.TPB	E14122970-010-07-1																			
1S		SPACE							U678																				
1W	RELAY PANEL 2	SPACE							U678																				
2A	SUBMERSIBLE PUMP SP-2-1	FVNR	4	75	250	300	1.6	3.2	FT.X11.A11.R174.C2, U112.P1.N300.U678. U258.L3	E14122970-010-01-1																			
2M	SUBMERSIBLE PUMP SP-2-2	FVNR	4	75	250	300	1.6	3.2	FT.X11.A11.R174.C2, U112.P1.N300.U678. U258.L3	E14122970-010-01-1																			
3A		SPACE																											
3B		MT.UNIT							U678.L3																				
3F	LP2	PANELBD			25				U372.U678.L3.BB1	E14122970-010-02-1																			
3D		1PXFMR			15	(5K)			U243.U678.L3	E14122970-010-06-1																			
4A	RELAY SECTION	MT.UNIT							U678.L3																				
<table style="width: 100%; border: none;"> <tr> <td style="width: 33%;">A11 ADDL PB</td> <td style="width: 33%;">BB1 BR BKR INSTALLED</td> <td style="width: 33%;">C2 ON-AUTO SS</td> <td style="width: 33%;">FT FUSED CTRL XFMR</td> </tr> <tr> <td>L3 WHITE INTERIORS</td> <td>N300 CNTRL XFMR TAPS</td> <td>P1 RED ON P.L.</td> <td>R174 X040 RELAY</td> </tr> <tr> <td>U112 12" DR/UNIT EXT</td> <td>U232 SERV ENTR LABEL</td> <td>U243 UNIT MOUNTED</td> <td>U258 WIRE LABELS</td> </tr> <tr> <td>U291 SURGE PROT.</td> <td>U372 FED FROM XFMR</td> <td>U678 UNIT NP GREY</td> <td>X11 1 NO 1 NC INTK.</td> </tr> <tr> <td>Y141 KEY INTERLOCK</td> <td>Y532 HIGH IC BREAKER</td> <td>TPB TWO POLE BKR</td> <td></td> </tr> </table>										A11 ADDL PB	BB1 BR BKR INSTALLED	C2 ON-AUTO SS	FT FUSED CTRL XFMR	L3 WHITE INTERIORS	N300 CNTRL XFMR TAPS	P1 RED ON P.L.	R174 X040 RELAY	U112 12" DR/UNIT EXT	U232 SERV ENTR LABEL	U243 UNIT MOUNTED	U258 WIRE LABELS	U291 SURGE PROT.	U372 FED FROM XFMR	U678 UNIT NP GREY	X11 1 NO 1 NC INTK.	Y141 KEY INTERLOCK	Y532 HIGH IC BREAKER	TPB TWO POLE BKR	
A11 ADDL PB	BB1 BR BKR INSTALLED	C2 ON-AUTO SS	FT FUSED CTRL XFMR																										
L3 WHITE INTERIORS	N300 CNTRL XFMR TAPS	P1 RED ON P.L.	R174 X040 RELAY																										
U112 12" DR/UNIT EXT	U232 SERV ENTR LABEL	U243 UNIT MOUNTED	U258 WIRE LABELS																										
U291 SURGE PROT.	U372 FED FROM XFMR	U678 UNIT NP GREY	X11 1 NO 1 NC INTK.																										
Y141 KEY INTERLOCK	Y532 HIGH IC BREAKER	TPB TWO POLE BKR																											
JOB NAME: STORAGE POND IMPROVEMENTS					EQUIPMENT DESIGNATION: MCC-2																								
JOB LOCATION: MANATEE, FL					EQUIPMENT TYPE: MODEL 6 MOTOR CONTROL CENTER																								
DRAWN BY: VIL					DRAWING TYPE: COMPONENT INFORMATION																								
ENGR: TLT					SQUARE D COMPANY																								
DATE: APRIL 3, 2001																													
DRAWING STATUS: RECORD					DWG# 114122970-010-01		PG 1 OF 1		REV A																				

**W A R N I N G -- THESE DRAWINGS MAY CONTAIN ERRORS
VERIFY AGAINST SQUARE D ORIGINAL HARD COPY DRAWINGS BEFORE USING**

These drawings have been translated from original drawings. The translation process can introduce errors into the drawings in unknown ways. Only original hard copy drawings provided by Square D Company to its customers should be relied upon by its customers or others. If these drawings are to be used by the customer, they must first be verified against the Square D Company hard copy drawings.

REV	DESCRIPTION	BY	DATE												
A	REV DISC AMPS	DC	05/10/01												
COMPONENT INFORMATION															
MCC DESIGNATION															
MCC-3							CONTROL (or DISTRIBUTION) TRANSFORMER								
UNIT LOC	NAMEPLATE DESIGNATION	UNIT TYPE	SIZE	HP	DISC AMPS	VA	FUSE SIZE		UNIT FEATURES	DRAWING NUMBER					
							PRI	SEC							
1A	MAIN BREAKER	MN.BKR			250				U232.Y532.U678.L3. U291.Y141	E14122970-011-03-1					
1F	SURGE ARRESTER	MT.UNIT							U678.L3.U291						
1H	AUXILIARY POWER RECEPTACLE	BR.BKR			200				U678.L3.Y141	E14122970-011-04-1					
1M	SPARE	6"BRBKR			20				U678	E14122970-011-05-1					
1O	SPARE	6"BRBKR			20				U678	E14122970-011-05-1					
1O	SPARE	6"BRBKR			20				U678	E14122970-011-05-1					
1S		SPACE							U678						
1U	RELAY PANEL 3	MT.UNIT							U678.L3						
2A	SUBMERSIBLE PUMP SP-3-1	FVNR	4	75	250	300	1.6	3.2	FT.X11.A11.R174.C2. U112.P1.N300.U678. U258.L3	E14122970-011-01-1					
2M	SUBMERSIBLE PUMP SP-3-2	FVNR	4	75	250	300	1.6	3.2	FT.X11.A11.R174.C2. U112.P1.N300.U678. U258.L3	E14122970-011-01-1					
3A	LP3	PANELBD			25				U372.U678.L3.BB1	E14122970-011-02-1					
3J		1PXFMR			15	(5K)			U243.U678.L3	E14122970-011-06-1					
3T		SPACE							U678						
3X		SPACE													
4A	RELAY SECTION	MT.UNIT							U678.L3						
<table style="width: 100%; border: none;"> <tr> <td style="width: 33%;">A11 SINGLE FUNC. PB L3 WHITE INTERIORS U112 12" DR/UNIT EXT U291 SURGE PROT. Y141 KEY INTERLOCK</td> <td style="width: 33%;">BB1 BR BKR INSTALLED N300 CNTRL XFMR TAPS U232 SERV ENTR LABEL U372 FED FROM XFMR Y532 HIGH IC BREAKER</td> <td style="width: 33%;">C2 ON-AUTO SS P1 RED ON P.L. U243 UNIT MOUNTED U678 UNIT NP GREY</td> <td style="width: 33%;">FT FUSED CTRL XFMR R174 X040 RELAY U258 WIRE LABELS X11 1 NO 1 NC INTK.</td> </tr> </table>												A11 SINGLE FUNC. PB L3 WHITE INTERIORS U112 12" DR/UNIT EXT U291 SURGE PROT. Y141 KEY INTERLOCK	BB1 BR BKR INSTALLED N300 CNTRL XFMR TAPS U232 SERV ENTR LABEL U372 FED FROM XFMR Y532 HIGH IC BREAKER	C2 ON-AUTO SS P1 RED ON P.L. U243 UNIT MOUNTED U678 UNIT NP GREY	FT FUSED CTRL XFMR R174 X040 RELAY U258 WIRE LABELS X11 1 NO 1 NC INTK.
A11 SINGLE FUNC. PB L3 WHITE INTERIORS U112 12" DR/UNIT EXT U291 SURGE PROT. Y141 KEY INTERLOCK	BB1 BR BKR INSTALLED N300 CNTRL XFMR TAPS U232 SERV ENTR LABEL U372 FED FROM XFMR Y532 HIGH IC BREAKER	C2 ON-AUTO SS P1 RED ON P.L. U243 UNIT MOUNTED U678 UNIT NP GREY	FT FUSED CTRL XFMR R174 X040 RELAY U258 WIRE LABELS X11 1 NO 1 NC INTK.												
JOB NAME: STORAGE POND IMPROVEMENTS						EQUIPMENT DESIGNATION: MCC-3									
JOB LOCATION: MANATEE, FL						EQUIPMENT TYPE: MODEL 6 MOTOR CONTROL CENTER									
DRAWN BY: VTL						DRAWING TYPE: COMPONENT INFORMATION									
ENGR: TLT						SQUARE D COMPANY									
DATE: APRIL 3, 2001															
DRAWING STATUS: RECORD						DWG# 114122970-011-01		PG 1 OF 1		REV A					

**W A R N I N G -- THESE DRAWINGS MAY CONTAIN ERRORS
VERIFY AGAINST SQUARE D ORIGINAL HARD COPY DRAWINGS BEFORE USING**

These drawings have been translated from original drawings. The translation process can introduce errors into the drawings in unknown ways. Only original hard copy drawings provided by Square D Company to its customers should be relied upon by its customers or others. If these drawings are to be used by the customer, they must first be verified against the Square D Company hard copy drawings.

REV	DESCRIPTION	BY	DATE			
-----	-------------	----	------	--	--	--

F.O. #14122970-009 Section 1 of 4 NEMA 3R 600 A Horizontal Bus 300 A Vertical Bus Service Entrance? Y Neutral Bus? N	F.O. #14122970-009 Section 2 of 4 NEMA 3R 600 A Horizontal Bus 300 A Vertical Bus Service Entrance? N Neutral Bus? N	F.O. #14122970-009 Section 3 of 4 NEMA 3R 600 A Horizontal Bus 300 A Vertical Bus Service Entrance? N Neutral Bus? N	F.O. #14122970-009 Section 4 of 4 NEMA 3R 600 A Horizontal Bus N/A A Vertical Bus Service Entrance? N Neutral Bus? N
--	--	--	--

JOB NAME: STORAGE POND IMPROVEMENTS	EQUIPMENT DESIGNATION: MCC-1
JOB LOCATION: MANATEE, FL	EQUIPMENT TYPE: MODEL 6 MOTOR CONTROL CENTER
DRAWN BY: VTL	DRAWING TYPE: NAMEPLATE INFORMATION
ENGR: TLT	 SQUARE D COMPANY
DATE: APRIL 3, 2001	
DRAWING STATUS: RECORD	DWG# N14122970-009-01 Pg 1 OF 1 REV -

**W A R N I N G -- THESE DRAWINGS MAY CONTAIN ERRORS
VERIFY AGAINST SQUARE D ORIGINAL HARD COPY DRAWINGS BEFORE USING**

These drawings have been translated from original drawings. The translation process can introduce errors into the drawings in unknown ways. Only original hard copy drawings provided by Square D Company to its customers should be relied upon by its customers or others. If these drawings are to be used by the customer, they must first be verified against the Square D Company hard copy drawings.

REV	DESCRIPTION	BY	DATE

SHORT-CIRCUIT-CURRENT RATING

WHEN PROTECTED BY KH CIRCUIT BREAKER OR - AMPERE
MAXIMUM CLASS - FUSES, THE SHORT-CIRCUIT-CURRENT RATING
OF THIS MOTOR-CONTROL-CENTER SECTION IS 25K AMPS RMS
SYMMETRICAL, 480 VOLTS MAXIMUM.

DO NOT INSTALL THIS SECTION ON CIRCUITS WITH AVAILABLE
FAULT CURRENTS HIGHER THAN THIS VALUE.

DO NOT INSTALL THIS SECTION ON CIRCUITS WITH AVAILABLE
FAULT CURRENTS HIGHER THAN THE LOWEST SHORT-CIRCUIT-CURRENT
RATING OF ANY INSTALLED UNIT.

REFER TO INDIVIDUAL UNIT RATING LABELS TO DETERMINE UNIT
SHORT-CIRCUIT-CURRENT RATINGS.

ADDITIONAL OR REPLACEMENT UNITS OR SECTIONS MUST BE OF
THE SAME MANUFACTURER AND TYPE WITH A
SHORT-CIRCUIT-CURRENT RATING EQUAL TO OR GREATER
THAN THE AVAILABLE FAULT CURRENT.

80438-788-01



REV -

SHORT-CIRCUIT-CURRENT RATING

THE SHORT-CIRCUIT-CURRENT RATING OF THIS MOTOR-CONTROL-CENTER
SECTION IS - AMPS RMS SYMMETRICAL,
 - VOLTS MAXIMUM.

DO NOT INSTALL THIS SECTION ON CIRCUITS WITH AVAILABLE
FAULT CURRENTS HIGHER THAN THIS VALUE.

DO NOT INSTALL THIS SECTION ON CIRCUITS WITH AVAILABLE
FAULT CURRENTS HIGHER THAN THE LOWEST SHORT-CIRCUIT-CURRENT
RATING OF ANY INSTALLED UNIT.

REFER TO INDIVIDUAL UNIT RATING LABELS TO DETERMINE UNIT
SHORT-CIRCUIT-CURRENT RATINGS.

ADDITIONAL OR REPLACEMENT UNITS OR SECTIONS MUST BE OF
THE SAME MANUFACTURER AND TYPE WITH A
SHORT-CIRCUIT-CURRENT RATING EQUAL TO OR GREATER
THAN THE AVAILABLE FAULT CURRENT.

80438-789-01



REV -

JOB NAME:	STORAGE POND IMPROVEMENTS	EQUIPMENT DESIGNATION:	MCC-1
JOB LOCATION:	MANATEE, FL	EQUIPMENT TYPE:	MODEL 6 MOTOR CONTROL CENTER
DRAWN BY:	VTL	DRAWING TYPE:	SHORT CIRCUIT CURRENT RATING
ENGR:	TLT		
DATE:	APRIL 3, 2001	DWG#	N14122970-009-02
DRAWING STATUS:	RECORD	PG	1 OF 1 REV -

**W A R N I N G -- THESE DRAWINGS MAY CONTAIN ERRORS
VERIFY AGAINST SQUARE D ORIGINAL HARD COPY DRAWINGS BEFORE USING**

These drawings have been translated from original drawings. The translation process can introduce errors into the drawings in unknown ways. Only original hard copy drawings provided by Square D Company to its customers should be relied upon by its customers or others. If these drawings are to be used by the customer, they must first be verified against the Square D Company hard copy drawings.

REV	DESCRIPTION	BY	DATE			
-----	-------------	----	------	--	--	--

F.O. #14122970-010	F.O. #14122970-010	F.O. #14122970-010	F.O. #14122970-010
Section 1 of 4	Section 2 of 4	Section 3 of 4	Section 4 of 4
NEMA 3R	NEMA 3R	NEMA 3R	NEMA 3R
600 A Horizontal Bus	600 A Horizontal Bus	600 A Horizontal Bus	600 A Horizontal Bus
300 A Vertical Bus	300 A Vertical Bus	300 A Vertical Bus	N/A A Vertical Bus
Service Entrance? Y	Service Entrance? N	Service Entrance? N	Service Entrance? N
Neutral Bus? N	Neutral Bus? N	Neutral Bus? N	Neutral Bus? N

JOB NAME: STORAGE POND IMPROVEMENTS	EQUIPMENT DESIGNATION: MCC-2
JOB LOCATION: MANATEE, FL	EQUIPMENT TYPE: MODEL 6 MOTOR CONTROL CENTER
DRAWN BY: VTL	DRAWING TYPE: NAMEPLATE INFORMATION
ENGR: TLT	 SQUARE D COMPANY
DATE: APRIL 3, 2001	
DRAWING STATUS: RECORD	DWG# N14122970-010-01 PG 1 OF 1 REV -

**W A R N I N G -- THESE DRAWINGS MAY CONTAIN ERRORS
VERIFY AGAINST SQUARE D ORIGINAL HARD COPY DRAWINGS BEFORE USING**

These drawings have been translated from original drawings. The translation process can introduce errors into the drawings in unknown ways. Only original hard copy drawings provided by Square D Company to its customers should be relied upon by its customers or others. If these drawings are to be used by the customer, they must first be verified against the Square D Company hard copy drawings.

REV	DESCRIPTION	BY	DATE			

SHORT-CIRCUIT-CURRENT RATING

WHEN PROTECTED BY KH CIRCUIT BREAKER OR - AMPERE
MAXIMUM CLASS - FUSES, THE SHORT-CIRCUIT-CURRENT RATING
OF THIS MOTOR-CONTROL-CENTER SECTION IS 25K AMPS RMS
SYMMETRICAL, 480 VOLTS MAXIMUM.

DO NOT INSTALL THIS SECTION ON CIRCUITS WITH AVAILABLE
FAULT CURRENTS HIGHER THAN THIS VALUE.

DO NOT INSTALL THIS SECTION ON CIRCUITS WITH AVAILABLE
FAULT CURRENTS HIGHER THAN THE LOWEST SHORT-CIRCUIT-CURRENT
RATING OF ANY INSTALLED UNIT.

REFER TO INDIVIDUAL UNIT RATING LABELS TO DETERMINE UNIT
SHORT-CIRCUIT-CURRENT RATINGS.

ADDITIONAL OR REPLACEMENT UNITS OR SECTIONS MUST BE OF
THE SAME MANUFACTURER AND TYPE WITH A
SHORT-CIRCUIT-CURRENT RATING EQUAL TO OR GREATER
THAN THE AVAILABLE FAULT CURRENT.

80438-788-01
SQUARE D
REV -

SHORT-CIRCUIT-CURRENT RATING

THE SHORT-CIRCUIT-CURRENT RATING OF THIS MOTOR-CONTROL-CENTER
SECTION IS - AMPS RMS SYMMETRICAL,
 - VOLTS MAXIMUM.

DO NOT INSTALL THIS SECTION ON CIRCUITS WITH AVAILABLE
FAULT CURRENTS HIGHER THAN THIS VALUE.

DO NOT INSTALL THIS SECTION ON CIRCUITS WITH AVAILABLE
FAULT CURRENTS HIGHER THAN THE LOWEST SHORT-CIRCUIT-CURRENT
RATING OF ANY INSTALLED UNIT.

REFER TO INDIVIDUAL UNIT RATING LABELS TO DETERMINE UNIT
SHORT-CIRCUIT-CURRENT RATINGS.

ADDITIONAL OR REPLACEMENT UNITS OR SECTIONS MUST BE OF
THE SAME MANUFACTURER AND TYPE WITH A
SHORT-CIRCUIT-CURRENT RATING EQUAL TO OR GREATER
THAN THE AVAILABLE FAULT CURRENT.

80438-789-01
SQUARE D
REV -

JOB NAME: STORAGE POND IMPROVEMENTS	EQUIPMENT DESIGNATION: MCC-2
JOB LOCATION: MANATEE, FL	EQUIPMENT TYPE: MODEL 6 MOTOR CONTROL CENTER
DRAWN BY: VTL	DRAWING TYPE: SHORT CIRCUIT CURRENT RATING
ENGR: TLT	SQUARE D COMPANY
DATE: APRIL 3, 2001	DWG# N14122970-010-02
DRAWING STATUS: RECORD	PG 1 OF 1 REV -

**W A R N I N G -- THESE DRAWINGS MAY CONTAIN ERRORS
VERIFY AGAINST SQUARE D ORIGINAL HARD COPY DRAWINGS BEFORE USING**

These drawings have been translated from original drawings. The translation process can introduce errors into the drawings in unknown ways. Only original hard copy drawings provided by Square D Company to its customers should be relied upon by its customers or others. If these drawings are to be used by the customer, they must first be verified against the Square D Company hard copy drawings.

REV	DESCRIPTION	BY	DATE			
-----	-------------	----	------	--	--	--

F.O. #14122970-011	F.O. #14122970-011	F.O. #14122970-011	F.O. #14122970-011
Section 1 of 4	Section 2 of 4	Section 3 of 4	Section 4 of 4
NEMA 3R	NEMA 3R	NEMA 3R	NEMA 3R
600 A Horizontal Bus	600 A Horizontal Bus	600 A Horizontal Bus	600 A Horizontal Bus
300 A Vertical Bus	300 A Vertical Bus	300 A Vertical Bus	N/A A Vertical Bus
Service Entrance? Y	Service Entrance? N	Service Entrance? N	Service Entrance? N
Neutral Bus? N	Neutral Bus? N	Neutral Bus? N	Neutral Bus? N

JOB NAME: STORAGE POND IMPROVEMENTS	EQUIPMENT DESIGNATION: MCC-3
JOB LOCATION: MANATEE, FL	EQUIPMENT TYPE: MODEL 6 MOTOR CONTROL CENTER
DRAWN BY: VTL	DRAWING TYPE: NAMEPLATE INFORMATION
ENGR: TLT	SQUARE D COMPANY
DATE: APRIL 3, 2001	
DRAWING STATUS: RECORD	DWG# N14122970-011-01 PG 1 OF 1 REV -

**W A R N I N G -- THESE DRAWINGS MAY CONTAIN ERRORS
VERIFY AGAINST SQUARE D ORIGINAL HARD COPY DRAWINGS BEFORE USING**

These drawings have been translated from original drawings. The translation process can introduce errors into the drawings in unknown ways. Only original hard copy drawings provided by Square D Company to its customers should be relied upon by its customers or others. If these drawings are to be used by the customer, they must first be verified against the Square D Company hard copy drawings.

REV	DESCRIPTION	BY	DATE

SHORT-CIRCUIT-CURRENT RATING

WHEN PROTECTED BY KH CIRCUIT BREAKER OR - AMPERE
MAXIMUM CLASS - FUSES, THE SHORT-CIRCUIT-CURRENT RATING
OF THIS MOTOR-CONTROL-CENTER SECTION IS 25K AMPS RMS
SYMMETRICAL, 480 VOLTS MAXIMUM.

DO NOT INSTALL THIS SECTION ON CIRCUITS WITH AVAILABLE
FAULT CURRENTS HIGHER THAN THIS VALUE.

DO NOT INSTALL THIS SECTION ON CIRCUITS WITH AVAILABLE
FAULT CURRENTS HIGHER THAN THE LOWEST SHORT-CIRCUIT-CURRENT
RATING OF ANY INSTALLED UNIT.

REFER TO INDIVIDUAL UNIT RATING LABELS TO DETERMINE UNIT
SHORT-CIRCUIT-CURRENT RATINGS.

ADDITIONAL OR REPLACEMENT UNITS OR SECTIONS MUST BE OF
THE SAME MANUFACTURER AND TYPE WITH A
SHORT-CIRCUIT-CURRENT RATING EQUAL TO OR GREATER
THAN THE AVAILABLE FAULT CURRENT.

80438-788-01

 **SQUARE D**

REV -

SHORT-CIRCUIT-CURRENT RATING

THE SHORT-CIRCUIT-CURRENT RATING OF THIS MOTOR-CONTROL-CENTER
SECTION IS - AMPS RMS SYMMETRICAL,
 - VOLTS MAXIMUM.

DO NOT INSTALL THIS SECTION ON CIRCUITS WITH AVAILABLE
FAULT CURRENTS HIGHER THAN THIS VALUE.

DO NOT INSTALL THIS SECTION ON CIRCUITS WITH AVAILABLE
FAULT CURRENTS HIGHER THAN THE LOWEST SHORT-CIRCUIT-CURRENT
RATING OF ANY INSTALLED UNIT.

REFER TO INDIVIDUAL UNIT RATING LABELS TO DETERMINE UNIT
SHORT-CIRCUIT-CURRENT RATINGS.

ADDITIONAL OR REPLACEMENT UNITS OR SECTIONS MUST BE OF
THE SAME MANUFACTURER AND TYPE WITH A
SHORT-CIRCUIT-CURRENT RATING EQUAL TO OR GREATER
THAN THE AVAILABLE FAULT CURRENT.

80438-789-01

 **SQUARE D**

REV -

JOB NAME:	STORAGE POND IMPROVEMENTS	EQUIPMENT DESIGNATION:	MCC-3
JOB LOCATION:	MANATEE, FL	EQUIPMENT TYPE:	MODEL 6 MOTOR CONTROL CENTER
DRAWN BY:	VTL	DRAWING TYPE:	SHORT CIRCUIT CURRENT RATING
ENGR:	TLT	 SQUARE D COMPANY	
DATE:	APRIL 3, 2001	DWG#	N14122970-011-02
DRAWING STATUS:	RECORD	PG	1 OF 1
		REV	-