



SOUTHWEST WASTEWATER COLLECTION SYSTEM
master plan update

FINAL UPDATE | MAY 2018

Engineers...Working Wonders With Water®



SOUTHWEST COUNTY WASTEWATER COLLECTION SYSTEM MASTER PLAN UPDATE

May 2018

FINAL



Laura B. Baumberger
P. E. No. 65401



MANATEE COUNTY
SOUTHWEST COUNTY WASTEWATER COLLECTION SYSTEM
MASTER PLAN UPDATE

TABLE OF CONTENTS

| | | <u>Page No.</u> |
|---|---|------------------------|
| EXECUTIVE SUMMARY | | ES-1 |
| CHAPTER 1 - INTRODUCTION | | |
| 1.1 | BACKGROUND | 1-1 |
| 1.2 | PREVIOUS MASTER PLAN | 1-3 |
| 1.3 | OBJECTIVES | 1-3 |
| 1.4 | SUMMARY OF REPORT CHAPTERS..... | 1-4 |
| 1.5 | ACKNOWLEDGEMENTS | 1-4 |
| 1.6 | REFERENCES | 1-5 |
| CHAPTER 2 - STUDY AREA | | |
| 2.1 | CLIMATE AND TOPOGRAPHY | 2-1 |
| 2.2 | INFLOW AND INFILTRATION | 2-3 |
| 2.3 | EXISTING INFRASTRUCTURE..... | 2-3 |
| CHAPTER 3 - PLANNING AND PERFORMANCE FRAMEWORK | | |
| 3.1 | BACKGROUND | 3-1 |
| 3.2 | POPULATION PROJECTIONS..... | 3-1 |
| | 3.2.1 County Population Projections..... | 3-1 |
| | 3.2.2 Planned Developments | 3-5 |
| | 3.2.3 WWCS Master Plan Population Projections | 3-8 |
| 3.3 | HISTORICAL FLOWS..... | 3-15 |
| | 3.3.1 Historical Wastewater Flows and Peaking Factors | 3-15 |
| | 3.3.2 Historical Wet Weather Flows..... | 3-16 |
| 3.4 | DIURNAL CURVES | 3-25 |
| 3.5 | PROJECTED WASTEWATER FLOWS | 3-30 |
| 3.6 | PERFORMANCE CRITERIA | 3-33 |
| | 3.6.1 System Reliability and Redundancy | 3-33 |
| | 3.6.2 Force Main Capacity | 3-33 |
| | 3.6.3 Gravity Sewer Design..... | 3-33 |
| | 3.6.4 Lift Stations | 3-34 |
| | 3.6.5 Wastewater Performance Criteria Summary..... | 3-34 |
| 3.7 | PLANNING FRAMEWORK SUMMARY | 3-35 |
| CHAPTER 4 - WASTEWATER MODEL DEVELOPMENT AND CALIBRATION | | |
| 4.1 | INTRODUCTION | 4-1 |

| | | |
|-----|--|------|
| 4.2 | MODEL UPDATE..... | 4-1 |
| | 4.2.1 Existing Hydraulic Model | 4-1 |
| | 4.2.2 Model Infrastructure | 4-2 |
| | 4.2.3 Model Review and Diagnostic Checks..... | 4-10 |
| 4.3 | MODEL DEVELOPMENT | 4-10 |
| | 4.3.1 Scenario Management | 4-10 |
| 4.4 | MODEL CALIBRATION | 4-11 |
| | 4.4.1 Calibration Standards and Expected Accuracy..... | 4-12 |
| | 4.4.2 Field Test | 4-13 |
| | 4.4.3 Base Model Calibration | 4-14 |
| | 4.4.4 Wet Weather Methodology | 4-17 |
| | 4.4.5 Wet Weather Model Calibration..... | 4-19 |
| 4.5 | CALIBRATION SUMMARY | 4-23 |
| | 4.5.1 Recommendations for Future Modeling Efforts..... | 4-23 |

CHAPTER 5 - EXISTING (2015) SCENARIO EVALUATION

| | | |
|-----|--|------|
| 5.1 | INTRODUCTION | 5-1 |
| 5.2 | EXISTING COLLECTION SYSTEM ASSUMPTIONS | 5-1 |
| 5.3 | EXISTING SYSTEM ANALYSIS | 5-2 |
| | 5.3.1 2015 LOS Analysis..... | 5-3 |
| | 5.3.2 2015 Wet Weather Analysis | 5-5 |
| | 5.3.3 Areas Not Meeting Performance Criteria | 5-12 |
| | 5.3.4 Recommended Improvements..... | 5-14 |
| 5.4 | SUMMARY AND RECOMMENDATIONS | 5-16 |

Chapter 6 - FUTURE SCENARIOS

| | | |
|-----|--|------|
| 6.1 | INTRODUCTION | 6-1 |
| 6.2 | FUTURE COLLECTION SYSTEM ASSUMPTIONS | 6-2 |
| 6.3 | 2020 SCENARIO | 6-3 |
| | 6.3.1 2020 Wastewater Infrastructure..... | 6-4 |
| | 6.3.2 2020 LOS Analysis..... | 6-9 |
| | 6.3.3 2020 Wet Weather Analysis | 6-11 |
| | 6.3.4 Planned and Recommended Improvements..... | 6-14 |
| 6.4 | 2025 SCENARIO | 6-14 |
| | 6.4.1 2025 Wastewater Infrastructure..... | 6-17 |
| | 6.4.2 2025 LOS Analysis..... | 6-18 |
| | 6.4.3 2025 Wet Weather Analysis | 6-18 |
| | 6.4.4 Recommended Improvements..... | 6-22 |
| 6.5 | 2035 SCENARIO | 6-22 |
| | 6.5.1 2035 Wastewater Infrastructure..... | 6-24 |
| | 6.5.2 2035 LOS Analysis..... | 6-24 |
| | 6.5.3 2035 Wet Weather Analysis | 6-26 |
| | 6.5.4 Recommended Improvements..... | 6-26 |
| 6.6 | PLANNED DEVELOPMENT SCENARIO..... | 6-28 |
| | 6.6.1 Planned Development Wastewater Infrastructure..... | 6-28 |
| | 6.6.2 Planned Development LOS Analysis | 6-30 |
| | 6.6.3 Planned Development Wet Weather Analysis | 6-30 |
| | 6.6.4 Recommended Improvements..... | 6-30 |

| | | |
|-----|---|------|
| 6.7 | BUILD-OUT SCENARIO | 6-33 |
| | 6.7.1 Build-Out Wastewater Infrastructure | 6-33 |
| | 6.7.2 Build-Out Analysis | 6-37 |
| 6.8 | WATER RECLAMATION FACILITY CAPACITY | 6-37 |
| 6.9 | SUMMARY | 6-39 |

Chapter 7 - CAPITAL IMPROVEMENT PROGRAM

| | | |
|-----|---|------|
| 7.1 | INTRODUCTION | 7-1 |
| 7.2 | COST ESTIMATING ACCURACY | 7-2 |
| 7.3 | COST ESTIMATING METHODOLOGY AND UNIT COSTS..... | 7-2 |
| 7.4 | WASTEWATER COLLECTION SYSTEM COST ESTIMATES | 7-4 |
| 7.5 | 5-YEAR CIP | 7-13 |
| 7.6 | 10-YEAR CIP | 7-13 |
| 7.7 | 20-YEAR CIP | 7-13 |
| 7.8 | SUMMARY | 7-13 |

Chapter 8 - CONCLUSIONS AND RECOMMENDATIONS

| | | |
|-----|---|-----|
| 8.1 | INTRODUCTION | 8-1 |
| 8.2 | SOUTHWEST WWCS MASTER PLAN CONCLUSIONS..... | 8-1 |
| 8.3 | CIP RECOMMENDATIONS | 8-2 |
| 8.4 | FUTURE PLANNING RECOMMENDATIONS | 8-4 |

LIST OF APPENDICES

| | |
|------------|---|
| APPENDIX A | EXCERPT FROM MANATEE COUNTY COMPREHENSIVE PLAN |
| APPENDIX B | FDOT INTENSITY-DURATION-FREQUENCY CURVES |
| APPENDIX C | EXCERPT FROM MANATEE COUNTY UTILITY DESIGN STANDARDS |
| APPENDIX D | LIFT STATION INFORMATION PROVIDED BY COUNTY |
| APPENDIX E | MODEL FLEX TABLES |
| APPENDIX F | FIELD TEST PLAN |
| APPENDIX G | CALIBRATION RESULTS |
| APPENDIX H | LIFT STATION PERFORMANCE CRITERIA EVALUATION |
| APPENDIX I | EXCERPT OF FY2015 - 2019 WW CIP |
| APPENDIX J | RECOMMENDED CIP PROJECT SUMMARY FORMS |
| APPENDIX K | RESULTS OF THE EVALUATIONS OF CURRENT CIP PROJECTS AS PLANNED BY THE COUNTY |

LIST OF TABLES

| | | |
|-----------|---|------|
| Table 2.1 | Manatee County Climate | 2-1 |
| Table 2.2 | Summary of Existing Infrastructure | 2-6 |
| Table 2.3 | Force Main Installation Dates | 2-8 |
| Table 2.4 | Gravity Main and Force Main Diameters..... | 2-9 |
| Table 2.5 | Gravity Main and Force Main Material | 2-10 |
| Table 3.1 | Population Projections Provided By County | 3-2 |
| Table 3.2 | Planned Developments..... | 3-6 |

| | | |
|------------|---|------|
| Table 3.3 | Population Projections (Excluding Population Served by Septic Tanks)..... | 3-8 |
| Table 3.4 | Future Land Use Categories | 3-12 |
| Table 3.5 | Build-Out Population Estimate | 3-14 |
| Table 3.6 | Historical Wastewater Flows – Southwest Service Area | 3-15 |
| Table 3.7 | Wastewater Level of Service (LOS) | 3-16 |
| Table 3.8 | Flow and Rainfall Analysis | 3-19 |
| Table 3.9 | Storm Event – 24-Hour Rainfall | 3-20 |
| Table 3.10 | Summary of Wet and Dry Weather Flows | 3-22 |
| Table 3.11 | Projected Wastewater Flows – Southwest Service Area | 3-31 |
| Table 3.12 | Performance Criteria Summary..... | 3-35 |
| Table 4.1 | Descriptions of Wastewater Model Simulations | 4-11 |
| Table 4.2 | Base Calibration Results..... | 4-15 |
| Table 4.3 | Wet Weather Calibration Summary..... | 4-20 |
| Table 5.1 | 2015 LOS Lift Stations with more than 5 Pump Cycles per Hour | 5-3 |
| Table 5.2 | 2015 Wet Weather Maximum Force Main Velocities..... | 5-7 |
| Table 5.3 | High Pump Starts in 2015 Wet Weather Scenario | 5-9 |
| Table 5.4 | 2015 Wet Weather Manhole Overflow Summary | 5-11 |
| Table 5.5 | 2015 Wet Weather Gravity Main Surge Summary..... | 5-11 |
| Table 5.6 | Summary of Recommended Improvements | 5-15 |
| Table 6.1 | Wastewater Infrastructure Added in 2020 Scenario | 6-8 |
| Table 6.2 | Lift Station Firm Capacity Exceedances in 2020 LOS Scenario | 6-9 |
| Table 6.3 | 2020 Wet Weather Manhole Overflow Summary | 6-14 |
| Table 6.4 | Wastewater Infrastructure Added in 2025 Scenarios | 6-18 |
| Table 6.5 | 2025 Wet Weather Gravity Main Surge Summary..... | 6-22 |
| Table 6.6 | Wastewater Infrastructure Added in 2035 Scenarios | 6-24 |
| Table 6.7 | Wastewater Infrastructure Added in Planned Development | 6-28 |
| Table 6.8 | Wastewater Infrastructure Added in Build-Out Scenario | 6-33 |
| Table 6.9 | Summary of Projected and Simulated Flows..... | 6-38 |
| Table 6.10 | Comparison of Simulated Peaking Factor and Population Density..... | 6-38 |
| Table 6.11 | Summary Recommended Future Infrastructure | 6-41 |
| Table 7.1 | Unit Pipe Costs for PVC and DIP..... | 7-3 |
| Table 7.2 | Pump Replacement Costs by Horsepower | 7-4 |
| Table 7.3 | Master Plan Recommended Infrastructure Improvements | 7-5 |
| Table 7.4 | Recommended Changes to FY 2015-2019 CIP Projects | 7-10 |
| Table 7.5 | Complete 20-Year Wastewater Collection System CIP..... | 7-14 |
| Table 7.6 | 20-Year CIP Summary..... | 7-17 |
| Table 8.1 | 20-Year CIP Summary..... | 8-3 |

LIST OF FIGURES

| | | |
|------------|---|------|
| Figure 1.1 | Location Map | 1-2 |
| Figure 2.1 | Manatee County Topography | 2-2 |
| Figure 2.2 | Sources of Inflow and Infiltration | 2-4 |
| Figure 2.3 | Typical Wastewater Flow Components | 2-5 |
| Figure 2.4 | Existing Collection System..... | 2-7 |
| Figure 3.1 | Septic Tank Locations | 3-3 |
| Figure 3.2 | Historical and Projected Population | 3-4 |
| Figure 3.3 | Planned Developments..... | 3-7 |
| Figure 3.4 | Sewer Shed Boundaries | 3-10 |
| Figure 3.5 | Future Land Use | 3-13 |

| | | |
|-------------|---|------|
| Figure 3.6 | Historical Annual Average Flow | 3-17 |
| Figure 3.7 | Maximum Month and Maximum Day Peaking Factors | 3-18 |
| Figure 3.8 | SWWRF Hydrograph | 3-24 |
| Figure 3.9 | MLS 1-D Diurnal Curve | 3-26 |
| Figure 3.10 | MLS #5 (MH 18814) Diurnal Curve | 3-27 |
| Figure 3.11 | MLS #5 (MH 19462) Diurnal Curve | 3-28 |
| Figure 3.12 | Typical Diurnal Curve | 3-29 |
| Figure 3.13 | Southwest Service Area Flow Projections..... | 3-32 |
| Figure 4.1 | Existing Model Infrastructure | 4-3 |
| Figure 4.2 | Typical Lift Station Configuration | 4-7 |
| Figure 4.3 | 1-D MLS Base Calibration Results..... | 4-16 |
| Figure 4.4 | Example Unit Hydrograph..... | 4-18 |
| Figure 4.5 | SWFWMD Rainfall Gauges and Data | 4-21 |
| Figure 4.6 | SWWRF Wet Weather Calibration Results | 4-22 |
| Figure 5.1 | 2015 LOS Results..... | 5-4 |
| Figure 5.2 | 2015 Wet Weather Results | 5-6 |
| Figure 6.1 | 2020 Infrastructure..... | 6-5 |
| Figure 6.2 | 2020 Force Main Diameters..... | 6-6 |
| Figure 6.3 | 2020 LOS Results..... | 6-10 |
| Figure 6.4 | 2020 Wet Weather Results | 6-12 |
| Figure 6.5 | 2025 Infrastructure..... | 6-15 |
| Figure 6.6 | 2025 Force Main Diameters..... | 6-16 |
| Figure 6.7 | 2025 LOS Results..... | 6-19 |
| Figure 6.8 | 2025 Wet Weather Results | 6-20 |
| Figure 6.9 | 2035 Infrastructure..... | 6-23 |
| Figure 6.10 | 2035 LOS Results..... | 6-25 |
| Figure 6.11 | 2035 Wet Weather Results | 6-27 |
| Figure 6.12 | Planned Development Infrastructure..... | 6-29 |
| Figure 6.13 | Planned Development LOS Results..... | 6-31 |
| Figure 6.14 | Planned Development Wet Weather Results | 6-32 |
| Figure 6.15 | Build-Out Infrastructure..... | 6-34 |
| Figure 6.16 | Build-Out Force Main Diameters..... | 6-35 |
| Figure 6.17 | Existing, Future, and Build-Out Infrastructure | 6-36 |
| Figure 6.18 | Permitted Vs. Projected SWWRF Capacity..... | 6-40 |
| Figure 7.1 | Master Plan Recommended Infrastructure Improvements | 7-8 |
| Figure 7.2 | Recommended Changes to FY 2015-2019 CIP Projects | 7-12 |

INTRODUCTION

Manatee County completed its most recent Southwest Service Area Wastewater Collection System (WWCS) Master Plan in 2009 (Greeley and Hansen, 2009). Carollo Engineers, Inc. (Carollo) was retained to assist the County in updating their hydraulic model and to develop a WWCS Master Plan Update through build-out. Major scope elements included data collection, development of wastewater flow projections and peaking factors, updating and calibrating the previous hydraulic model, evaluation of existing and future scenarios for dry and wet weather conditions (2015, 2020, 2025, 2035, planned development, and build-out), and development of a 20-year Capital Improvement Plan (CIP) for the Southwest Service Area collection system.

PLANNING FRAMEWORK

The Southwest WWCS Master Plan Update documents planning information that serves as the framework for the collection system model and master planning analyses. Factors including population and flow projections, peaking factors, wet weather analyses, and diurnal curves were evaluated and incorporated into the WWCS model.

Population projections were provided by the County in the form of Traffic Analysis Zone (TAZ) GIS shapefiles in 5-year increments through 2040. TAZ are the basic geographic unit used to inventory demographic and land use data. The projections were adjusted to account for population served by septic tanks, which are included in the TAZ projections.

Future population growth through 2035 was assumed to only occur within planned developments (developer projects that have been submitted to the County for review and approval). Information on planned developments was provided by the County and incorporated into this Master Plan Update. The population in the planned development scenario assumes the planned developments are built to capacity (maximum population proposed by the developer project).

Build-out population includes the connection of small septic tank parcels (under 1 acre) to the sewer infrastructure, the redevelopment and connection of large septic parcels (over 1 acre), and the connection of all other undeveloped land (not included in a planned development). Sewer shed boundaries were drawn for each existing, future, and build-out lift station, based on existing infrastructure, planned developments, and the location of undeveloped and septic parcels.

The build-out population of the large septic parcels and the undeveloped parcels (collectively referred to as build-out parcels) were based on the future land use type, parcel area (acres), maximum gross potential residential density (dwelling unit/acre), a population density of 2.34 persons per dwelling unit based on the 2010 Census (Manatee County

Planning Department), and the assumption that the land would be developed to 75 percent of the allowable maximum density.

The County's historical water reclamation facility (WRF) influent flow data, which is presented in Chapter 3 (Table 3.6), was analyzed to determine the maximum month and maximum day peaking factors in each service area. For the Southwest Service Area, the maximum month peaking factor ranged from 1.13 to 1.30 over the last 10 years. Peak daily flows over the last five years ranged from 1.56 to 2.62 times the annual average. The historical average flow per person has decreased by approximately 31.5 percent since 2005, from 159.40 gallons per capita per day (gpcd) to 109.06 gpcd in 2014. The five-year average flow per person is 108.72 gpcd.



Wastewater flow generation varies throughout the day based on customer water use patterns and industrial/commercial contributions. Because the hydraulic models are developed to model movement of wastewater flow throughout an extended period of time, diurnal curves are used to vary the wastewater generation in the model. Refer to Chapter 3 for more information on diurnal curves. Temporary flowmeters were installed throughout the County in order to record actual flow data. Representative data from two consecutive days were chosen to develop diurnal curves that were input into the hydraulic models.

Projected annual average flows were developed using the current per capita wastewater flow LOS values (115 gpcd for the Southwest Service Area). Projected maximum monthly flows were calculated using a monthly peaking factor of 1.31, per County Policy 9.1.3.1. The actual maximum 10-year monthly peaking factor for the Southwest Service Area (1.30) is similar to this policy value. Figure ES.1 shows the projected wastewater flows for the Southwest Service Area through 2035.

A detailed wet weather analysis was completed using historical daily rainfall and wastewater flows for the Southwest WRF (SWWRF) and the master lift stations (MLSs) in the Southwest Service Area. Data from June through September 2013 was analyzed. Based on the wet weather analysis, and consulting with County staff, it was decided that a 3-day storm event that occurred in September 2013 be used to calibrate the base wet weather scenario and to model future wet weather scenarios. The 3-day storm event was chosen over a 24-hour design storm due to the larger impact a series of lower intensity rainfall events have on the collection system (as compared to an isolated, 24-hour storm with higher intensity).

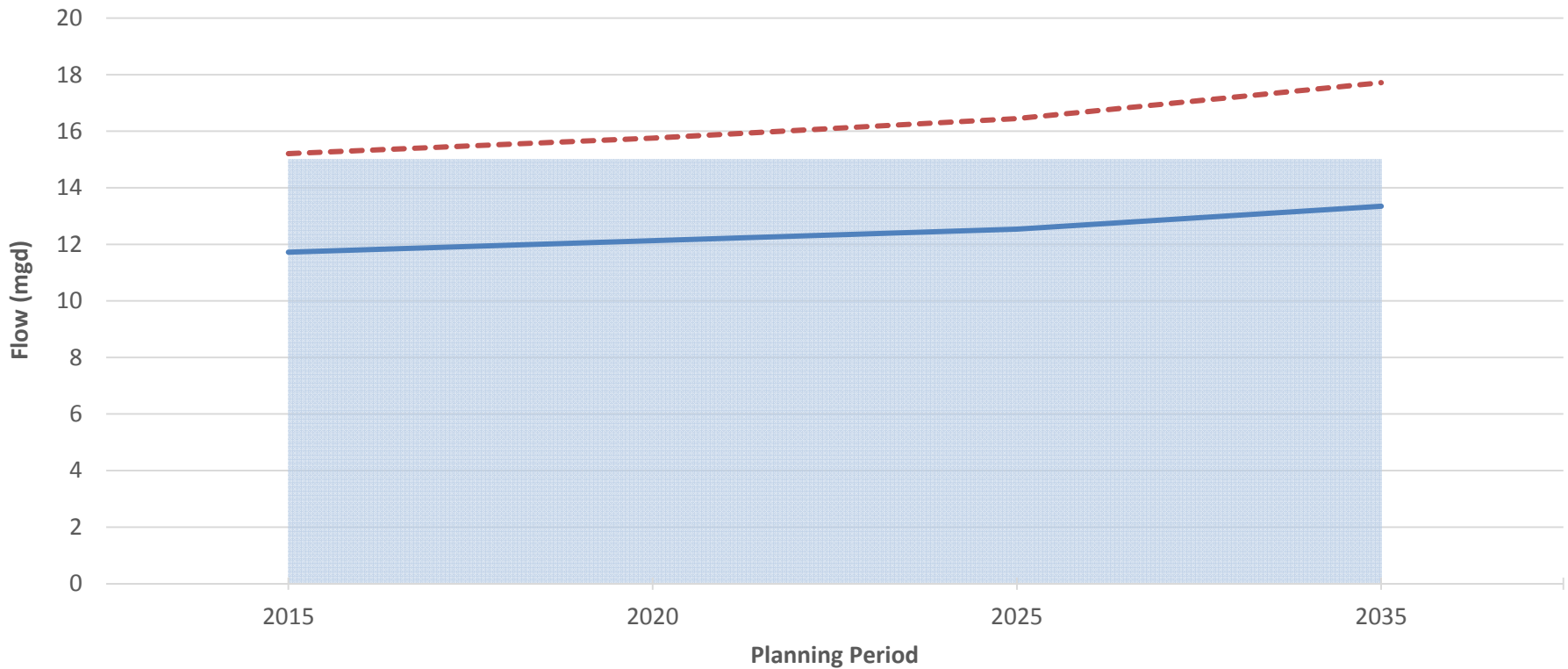
Criteria for measuring and evaluating the performance and design of the infrastructure in the Southwest Service Area WWCS included force main velocity, gravity pipeline depth, wet well diameter and volume, and pump capacity and cycle times. Comparison of the system's capabilities against these performance and design criteria provides a mechanism for identifying existing or future needs and serves as a guide for capital improvement projects. The performance criteria are based on County design standards, commonly accepted engineering standards, and applicable regulations such as the Florida Administrative Code (FAC) and 10 State Standards.



-  Current SWWRF Permitted Capacity
-  Projected AADF Based on TAZ Population and LOS per Capita (1)
-  Projected Sanitary Flows Based on TAZ Population and Acutal Per Capita Factor (1)

SOUTHWEST SERVICE AREA PROJECTED WASTEWATER FLOWS

FIGURE ES.1

MANATEE COUNTY
SOUTHWEST WWGS MASTER PLAN UPDATE

Note:

1. Includes flow from Longboat Key and USF/Airport area.



MODEL DEVELOPMENT AND CALIBRATION

The County's previous model was constructed during the 2009 update of the master plan using the County's GIS database. The previous model was built using the Bentley SewerCAD hydraulic modeling software. It should be noted that the model has been updated using the Bentley SewerGEMS software, a fully dynamic, multi-platform sanitary and combined sewer modeling solution. For an overview of the major model elements and the infrastructure included in the model, please refer to Chapter 4.

An extensive comparison of the previous model infrastructure, the most recent GIS database, and spreadsheet data provided by the County was conducted. Level of Service (LOS) and wet weather scenarios were created in the model for each planning period (2015, 2020, 2025, 2035, planned development, and build-out). The LOS scenarios have a 72-hour simulation period and the wet weather scenarios have 96-hour simulation period.

Hydraulic models are built from the best available information regarding the physical attributes and operational conditions of the collection system. There are a number of parameters that are not directly known and cannot be directly measured. For this reason, these parameters must be assumed initially based on typical values and engineering judgment. Every collection system is unique. For this reason, industry standard of care dictates that a model be validated to ensure that the assumptions built into the model are reasonable and provide results that correctly reflect the operation of the system. This validation process is commonly referred to as calibration.

In the United States, calibration standards to assess the accuracy of model calibration have yet to be developed and depend heavily on the complexity of the system and availability of data to develop the model. Based on the Wastewater Planning Users Group (WaPUG), a section of the Chartered Institution of Water and Environment Management, it is recommended that the average base wastewater flow be within 10 percent of actual measured data and the average wet weather flow be within +20 percent to -10 percent.

A wastewater collection system field test was performed in April 2015 to gather actual pressure and flow data throughout the system. The model was calibrated by comparing this field data with the model's simulated results. Flow results of the model, after adjustments, were reasonable and match the actual system data relatively closely, under both the base and wet weather conditions. The average daily flow to the SWWRF was within 2 percent in the base scenario and within +/- 4 percent in the wet weather scenarios. Both calibration results meet the generally accepted standards used to determine the adequacy of model calibration, according to the WaPUG, therefore the model is considered robustly calibrated. Care should be taken when modifying the model parameters, as changes may affect the overall results and reliability of the model. The calibration methodology and results are discussed further in Chapter 4.

EXISTING COLLECTION SYSTEM ANALYSIS

Evaluations of the collection system, based on the LOS and wet weather flow conditions, were completed to verify that the existing infrastructure satisfies the selected performance criteria and to identify necessary corrective actions. Based on the 2015 LOS and Wet Weather modeling results, the majority of the modeled infrastructure in the Southwest Service Area meet the performance requirements. However, deficiencies were identified at:

- Some major transmission force main trunks,
- A few major connecting gravity mains,
- Several smaller gravity collectors, and
- At a percentage of lift stations.

Fortunately, improvement projects for the most critical of these deficiencies have been previously identified and programmed into the current County CIP (FY 2015-2019), and projects are either under design or scheduled for construction. Additional evaluations were completed using the future model scenarios (2020 through build-out) in order to propose the most suitable corrective actions. Table ES.1 summarizes the force main deficiencies identified using the 2015 scenarios of the model and a recommended solution. **Error! Reference source not found.** also shows which of the deficiencies fall into projects that are within the scope of the currently adopted FY 2015-2019 CIP, and which ones have been identified as part of this Master Plan. Details of each deficiency and/or proposed project are included in Chapters 5 through 7.

| Table ES.1 Summary of Recommended Force Main Improvements Southwest WWCS Master Plan Update Manatee County | |
|---|--|
| 2015 Scenario Deficient Force Main ID or Alignment | Recommendation |
| Projects Already in the Planning or Design Phase | |
| 27-A MLS (RTU 138) Force Main from 51 st Street West to the SWWRF ⁽¹⁾ | No changes to the current CIP project are recommended. |
| Lift Station 23-A (RTU 410) Force Main (Segment 2) ⁽¹⁾ | Continue with plans to upsize existing 6-inch force main with an 8-inch (CIP # WW01037). |
| FM-139-1 (MLS 12-A Force Main Segment 1) | Part of CIP ID WW00975. See recommended change to CIP project in Appendix K. |
| FM-237-1, FM-237-2, FM-237-3, FM-237-4 (MLS 1-D Force Main Segments 1-4) | Complete CIP ID 6035781 and part of CIP ID 6085780. See recommended change to CIP project in Appendix K. |

| Table ES.1 Summary of Recommended Force Main Improvements Southwest WWCS Master Plan Update Manatee County | |
|---|--|
| 2015 Scenario Deficient Force Main ID or Alignment | Recommendation |
| FM-203-1, FM-203-2, FM-203-3 (MLS 1-M Force Main Segments 1-3) | Part of CIP ID 6085780. No changes to the current CIP project are recommended. |
| FM-071-1 (MLS #5 Force Main Segment 1) | Part of CIP ID WW00974. See recommended change to CIP project in Appendix K. |
| FM-SWWRF-Outfall (Headworks Influent Force Main) | Upsize as part of the future headworks project is recommended. |
| Projects Identified in this Master Plan | |
| FM-101-1 and FM-101-2 (Bayshore Yacht Basin Lift Station Force Main) | Upsize force main to 16-inch. |
| <u>Notes:</u> (1) Expenditures committed by FY 2015 in the adopted CIP. | |

Deficiencies in major gravity mains are identified by manhole overflows and/or surcharged gravity mains. Manhole overflows occurred upstream of Lift Station RTUs 136, 141, and 457 during the wet weather scenario. The gravity main along Cortez Road, connecting Anna Maria Island (MLS #5) and other smaller basins to MLS 1-M (RTU 203) was surcharged during the wet weather scenario. Surcharging was also observed upstream of MLS 13-A (RTU 408) and Lift Station 36-A (RTU 241). The deficient gravity portions (1,350 and 1,250 linear feet, respectively) connect 54,390 linear feet (10.3 miles) and 6,770 linear feet (1.28 miles) of force main, respectively, to MLS 13-A (RTU 408) and Lift Station 36-A. These deficiencies are observed mostly during wet weather conditions.

Lift stations where one or more of the performance criteria such as pump cycles, pump capacity and wet well storage capacity are currently not met were identified in model simulations. Deficiencies of a nature that result in a higher operating cost to the County are considered major. As such, the pump activity criterion (greater than five pump start/stop cycles per hour) is given more relevance and has been represented in maps. Efforts to resolve sustained deficiencies are proposed in this Master Plan.

FUTURE SCENARIOS

Future scenarios were evaluated for planning years 2020, 2025, 2035, planned development, and build-out in order to assess the performance of the existing and future infrastructure under increased wastewater loads.

Improvements included in the 2020 scenario were limited to projects currently under design or construction or in the County's current 5-year CIP (FY 2015-2019), including:

- MLS #5 (RTU 071) Force Main Rehabilitation
- 1-M Master Lift Station (RTU 203) Force Main Rehabilitation
- 1-D Master Lift Station (RTU 273) Force Main Rehabilitation
- 12-A Master Lift Station (RTU 139) Force Main Rehabilitation
- 13-A Master Lift Station (RTU 408) Force Main Rehabilitation
- 27-A Master Lift Station (RTU 138) Force Main Rehabilitation
- Force Main 27A - 53rd Avenue West from 43rd Street West to 75th Street West
- Lift Station 18-M (RTU 116) Rehabilitation
- Lift Station 17-A (RTU 404) Force Main Reroute and Rehabilitation
- Fiddler's Green Lift Station (RTU 250) Pumps Replacement
- Lift Station 23-A (RTU 410) Force Main Rehabilitation
- 51st Street Gravity Main Sewer Replacement
- Lift Station 31-A (RTU 126) Force Main Renewal
- Spanish Park Lift Station (RTU 213) Force Main Renewal
- Windmill Village Lift Station (RTU 405) Force Main Renewal

Because the MLS #5 (RTU 071) force main extension is anticipated to be partially funded by developers, it was also assumed to be completed by 2020. An upsized SWWRF headworks influent force main was included in the model by 2020 so that the pipe current diameter would not be hydraulically limiting for the collection system evaluation. Upgrades to this influent line will be included in a future headworks project planned by the County (expected to be completed by 2018). The future pipe diameter should be evaluated as part of that project.

In addition to the projects listed above, the following new developments and associated infrastructure were brought online in 2020:

- Lake Flores (split into two new lift stations: F300 and F301)
- Longbar Pointe (Lift Station F302)
- Peninsula Bay (Lift Station F303)
- Three vacant lots (served by Lift Station F305)
- Palma Sola Grande (Included with Lift Station 19-D (RTU 217))
- 43rd Terrace (Included with MLS 1-M (RTU 203))

The following infrastructure updates are included in the 2025 scenarios:

- The Bayshore Yacht Basin Lift Station (RTU 101) force main is upsized from 10-inch to 16-inch. The pumps were converted to VFDs and the wet well capacity was increased. A 16-foot by 16-foot square wet well was used in 2025 and beyond scenarios. Infrastructure sizing was based on detailed calculations provided by the County as the available calibration data for this lift station was not reliable. The County should install a temporary flowmeter to determine actual flows (average and wet weather) to confirm appropriate sizing of future infrastructure.

For simplicity, the future lift station was modeled in the same location as the existing lift station. The future 16-inch force main will be approximately 800 linear feet based on the new location (at the southeast corner of 26th Street West and South Radcliffe Place).

- The pumps at Lift Station RTUs 136, 457, 217, and 437 were upsized to prevent manhole overflows and/or surcharged gravity upstream of the lift station.
- Approximately 1,250 linear feet of 15-inch and 850 linear feet of 18-inch gravity main that connect 6,770 linear feet of force main to Lift Station 36-A (RTU 241) is upsized to 21-inch and 24-inch, respectively. This segment experiences a significant bottleneck when routing flow from other lift stations.

In addition to the improvements identified based on the 2105 and 2020 scenario evaluations, the following improvements are needed by 2025 due to the additional flows from the USF/Airport areas:

- A new pump design point was assigned at Lift Station 7-A (RTU 137) and the discharge force main was upsized from a 6-inch to an 8-inch diameter pipe.
- A new pump design point was assigned at the Crosley Estate Lift Station (RTU 149). This is required due to the new pumps at Lift Station 7-A (RTU 137)
- Upsize Lift Station 6-A (RTU 136) force main from an 8-inch to a 12-inch diameter.
- A new pump design point was assigned at Lift Station 9-A (RTU 436) and the force main was upsized from a 6-inch to a 12-inch diameter pipe. The new force main was also extended up to a manhole at the corner of Whitfield Avenue and Persimmon Place because the existing gravity main on 15th Street East and Idelwild Court does not have sufficient capacity for the additional flows. The wet well for this lift station was also shown to have limited storage capacity. Due to the additional flows expected from the USF/Airport areas, the County has identified this lift station wet well to be upsized. For the 2025 and beyond scenarios, a 12-foot diameter wet well was used. It is recommended that the County verify the actual influent flows (average and wet weather) at this lift station to confirm the appropriate size needed.

The following infrastructure improvements have been included in the 2035 scenarios:

- Upsize existing 8-inch gravity main upstream of MLS 1-M (RTU 203) with a 12-inch diameter pipe.
- Upsize existing 18-inch gravity main upstream of MLS 13-A (RTU 408) along 63rd Avenue East (from Pennsylvania Avenue to 5th Street Circle) with 24-inch pipe.
- The following improvements are required to meet additional flows from the USF/Airport areas:
 - New pumps at the Airport Industrial Park Lift Station (RTU 469).
 - Upsize the existing 14-inch force main along US 41 (from Magellan Drive to 69th Avenue West) with a 16-inch pipe.

Table ES.2 provides a summary of the infrastructure (force mains, gravity mains, and lift stations) added in each of the future scenarios. The inventory for 2020 includes FY 2015-2019 CIP projects as proposed after careful evaluation of current design plans by the County. Please refer to figures presented in Chapter 6 which show the infrastructure added in each future scenario and the sizing of future force mains.

| Table ES.2 Summary Recommended Future Infrastructure Southwest WWCS Master Plan Update Manatee County | | | | | |
|--|--------------------------------------|------------------------|------------------------|---|-----------------------------|
| Force Main Diameter | 2020 (Feet)⁽¹⁾ | 2025 (Feet) | 2035 (Feet) | Planned Development (Feet) | Build-Out (Feet) |
| 4 | 5,523 | | | | 21,944 |
| 6 | 1,598 | | | | 1,492 |
| 8 | 11,987 | 1,615 | | | |
| 10 | | | | | |
| 12 | 845 | 7,962 | | 8,296 | 2,171 |
| 14 | | | | | |
| 16 | 9,502 | 800 | | | |
| 18 | 4,776 | | | | |
| 20 | 26,555 | | 1,027 | | |
| 24 | 11,447 | | | | |
| 27 | 25,360 | | | | |
| 30 | | | | | |
| 36 | | | | | |
| 42 | 6,870 | | | | |
| Total Force Main Length | 104,463 | 10,377 | 1,027 | 8,296 | 25,607 |

| Table ES.2 Summary Recommended Future Infrastructure Southwest WWCS Master Plan Update Manatee County | | | | | |
|--|--------------------------------------|------------------------|------------------------|---|-----------------------------|
| Force Main Diameter | 2020 (Feet)⁽¹⁾ | 2025 (Feet) | 2035 (Feet) | Planned Development (Feet) | Build-Out (Feet) |
| Gravity Main Diameter | 2020 (Feet) | 2025 (Feet) | 2035 (Feet) | Planned Development (Feet) | Build-Out (Feet) |
| 10 | | | 948 | | |
| 12 | | | 1,061 | | |
| 21 | | 1,247 | | | |
| 24 | | 2,228 | 1,430 | | |
| Total Gravity Main Length | 0 | 3,575 | 2,491 | 0 | 0 |
| New Lift Stations | 5 | 1 | 0 | 1 | 11 |
| Existing Lift Stations with New Pumps | 1 | 9 | 1 | 0 | 1 |
| Notes: | | | | | |
| (1) Includes FY 2015-2019 CIP projects as proposed after careful evaluation of current design plans by the County. | | | | | |

The results for the 2035 Wet Weather scenario are provided in Figure ES.2. As shown, there are a few force mains that experience a peak velocity of over 6 fps. These are either for a short period of time (less than 10 percent of total simulation period) or are most likely caused by potential inaccuracies of the pump curve (pumps not operating on their curve).

There is only one force main coming online by the planned development scenario (to serve planned developments beyond 2035). Given the growth of Longbar Pointe by the planned development scenario, a 12-inch diameter force main will be required. It is the County's preference to add a new 12-inch parallel pipe with the full carrying capacity in order to change the use of the existing 8-inch force main (currently on El Conquistador Parkway and 53rd Avenue West) from sanitary sewer to reclaimed water service. Infrastructure added at build-out is to serve future growth. All build-out infrastructure was sized to meet the performance criteria presented in Chapter 3.

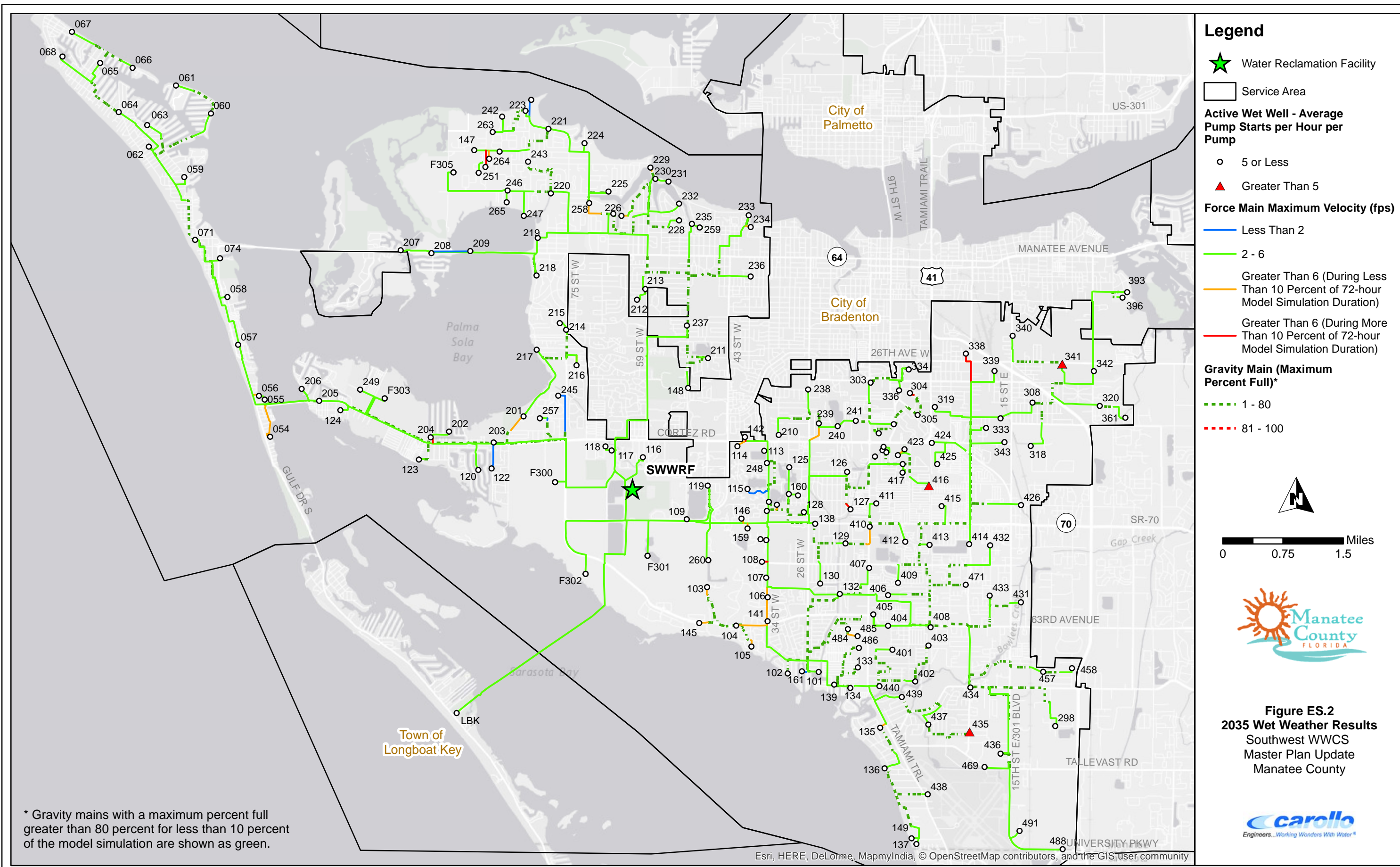

Legend

- Water Reclamation Facility
- Service Area
- Active Wet Well - Average Pump Starts per Hour per Pump**
 - 5 or Less
 - Greater Than 5
- Force Main Maximum Velocity (fps)**
 - Less Than 2
 - 2 - 6
 - Greater Than 6 (During Less Than 10 Percent of 72-hour Model Simulation Duration)
 - Greater Than 6 (During More Than 10 Percent of 72-hour Model Simulation Duration)
- Gravity Main (Maximum Percent Full)***
 - 1 - 80
 - 81 - 100

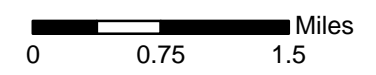

Figure ES.2
2035 Wet Weather Results
 Southwest WWCS
 Master Plan Update
 Manatee County



* Gravity mains with a maximum percent full greater than 80 percent for less than 10 percent of the model simulation are shown as green.

SWWRF CAPACITY AND PROJECTED WASTEWATER FLOW

The SWWRF is currently permitted for 15.0 mgd based on three month rolling average daily flow (3MRADF). The average ratio between the County's annual average daily flow (AADF) and the 3MRADF was determined to be essentially one in the LOS Evaluation project (Carollo, 2015). Table ES.3 summarizes the projected flows based on LOS and historical peaking factors, as described in Chapter 3. The model simulated LOS and maximum wet weather flows are also shown. Both the projected AADF and the simulated LOS flows show that the SWWRF capacity would have been exceeded by 2015.

Figure 6.18 in Chapter 6 shows a comparison of the SWWRF permitted capacity with flows projected using the strict interpretation of the LOS, the simulated LOS flows, and projections using the actual per capita wastewater generation factor (84.75 gpcd, calculated during model calibration). If current and future system loads are calculated using the actual per capita factor, the SWWRF would not be expected to reach capacity until after the end of this Master Plan period (2035). It is recommended that the County continue to monitor the actual per capita factor, perform periodic reviews of the expected LOS, and update projections and wet weather model simulations accordingly.

| Year | Projected Flows (mgd) ⁽¹⁾ | | | Average Simulated Flows (mgd) | | Simulated Peaking Factor ⁽⁵⁾ |
|---------------------|--------------------------------------|------------------------------|----------------------------|-------------------------------|------------------------------------|---|
| | AADF | Maximum Month ⁽²⁾ | Maximum Day ⁽³⁾ | LOS | Maximum Wet Weather ⁽⁴⁾ | |
| 2015 | 15.2 | 19.9 | 39.9 | 15.9 | 40.6 | 2.55 |
| 2020 | 15.8 | 20.7 | 41.3 | 16.5 | 44.9 | 2.72 |
| 2025 | 16.5 | 21.6 | 43.1 | 16.8 | 45.5 | 2.71 |
| 2035 | 17.7 | 23.2 | 46.4 | 18.1 | 47.0 | 2.60 |
| Planned Development | 19.3 | 25.2 | 50.5 | 19.6 | 47.7 | 2.43 |
| Build-Out | 21.9 | 28.7 | -- ⁽⁶⁾ | 22.4 | 51.0 | 2.28 |

Notes:

(1) Based on TAZ populations and LOS per capita for the Southwest Service Area, plus average daily flow from the Town of Longboat Key (which was assumed constant throughout the planning period) and average daily flows from the USF/Airport areas.

(2) Based on the County's Peaking Factor of 1.31 per County Policy 9.1.3.1.

(3) Based on 5-year maximum historical maximum day peaking factor (2.62).

(4) Based on sanitary loads and day of maximum flow from September 2013 3-day storm event.

(5) Calculated by dividing maximum day wet weather flow by the average LOS flow.

(6) Maximum day peaking factor of 2.62 is not anticipated at build-out due to the increased population density (persons/acre) as described in Table 6.10 in Chapter 6.

CAPITAL IMPROVEMENT PROGRAM

The CIP provides an estimate of the planning level costs associated with the improvements recommended through the 20-year (2035) planning period. The cost estimates presented in this Master Plan are considered Class 4 accuracy level (within +50 percent to -30 percent) unless otherwise noted.

Table ES.4 presents a list of recommended wastewater infrastructure improvements to allow the existing collection system to meet the selected performance criteria. Recommended changes to current FY 2015-2019 force main CIP projects are shown in Table ES.5, along with an estimated associated budget savings. New recommended projects are anticipated to come online by 2025 (unless otherwise noted) based on the amount of time it takes to budget in a new CIP cycle, plan, design, procure, and construct a CIP project. Projects proposed as part of this Master Plan were further classified for completion by either 2025 or 2035 depending on the priority based on relative risk to the collection system. Because the MLS #5 (RTU 071) force main extension will be partially funded by developers, it was assumed to be completed by 2020.

The locations of the recommended projects are shown in Figure ES.3 with the corresponding project numbers identified. Table ES.6 provides a summary of the total 20-year CIP, including existing CIP projects and recommended master plan projects.

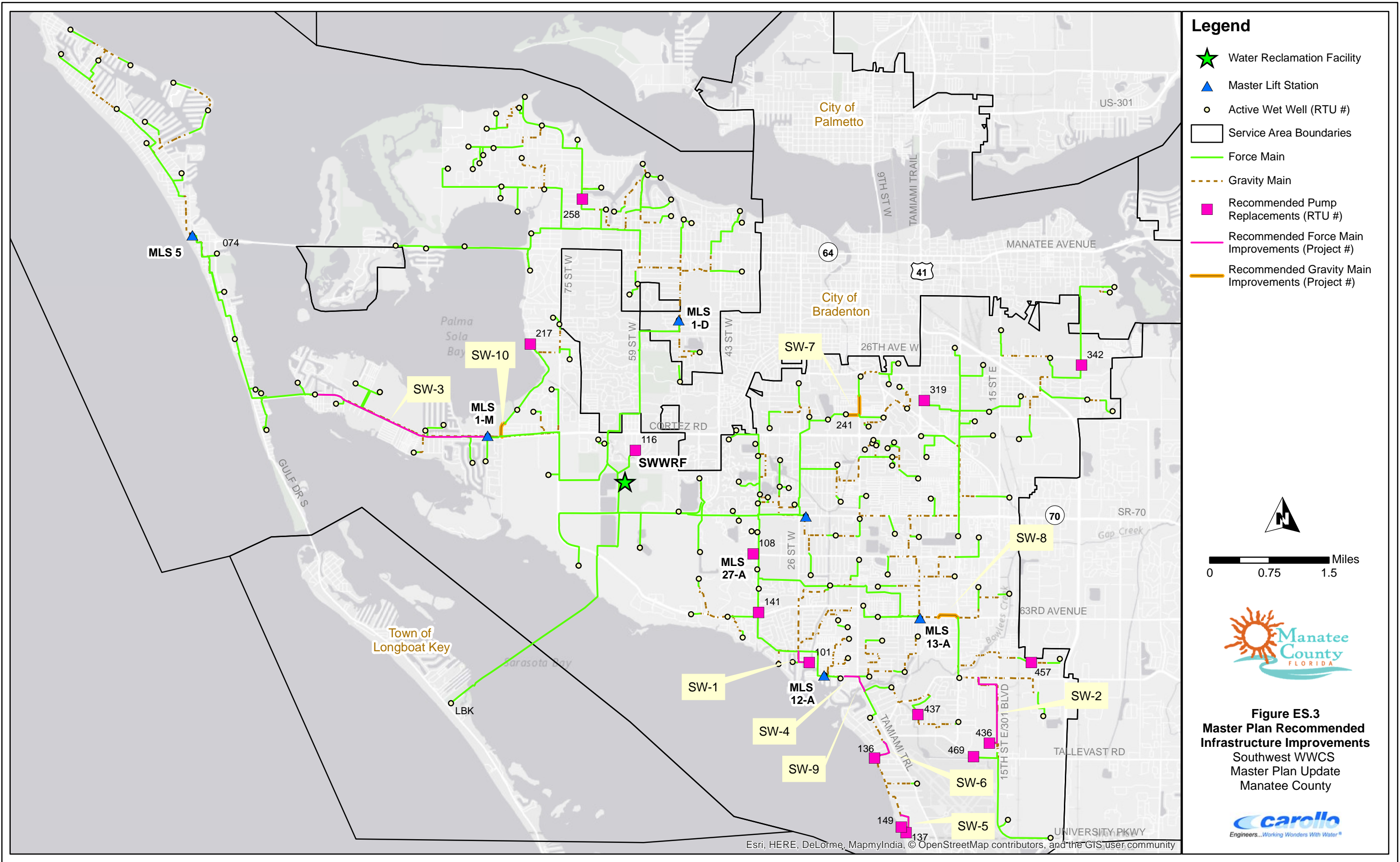

- Legend**
- Water Reclamation Facility
 - Master Lift Station
 - Active Wet Well (RTU #)
 - Service Area Boundaries
 - Force Main
 - Gravity Main
 - Recommended Pump Replacements (RTU #)
 - Recommended Force Main Improvements (Project #)
 - Recommended Gravity Main Improvements (Project #)

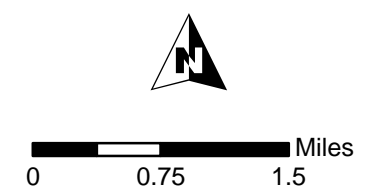

Figure ES.3
Master Plan Recommended
Infrastructure Improvements
 Southwest WWCS
 Master Plan Update
 Manatee County



Esri, HERE, DeLorme, MapmyIndia, © OpenStreetMap contributors, and the GIS user community

| Table ES.4 Master Plan Recommended Infrastructure Improvements Southwest WWCS Master Plan Update Manatee County | | | | | |
|--|--|-------------------------|------------------------|--------------------------------|------------------------------------|
| Master Plan Project | | | | | Project Cost Estimate (\$M) |
| Lift Station Evaluation/Replacement Projects | | | | | |
| Project ID | Description | | | Recommended Year Online | Total Project Cost |
| SW-1 | Bayshore Yacht Basin Lift Station relocation and upgrades. Project includes new building, new pumps with variable frequency drives, 16-foot square wet well, and 800 LF of 16-inch force main ⁽¹⁾ | | | 2025 | \$3.50 |
| SW-2 | Upsize Lift Station 9-A (RTU 436) force main (approximately 6,060 feet) to 12-inch pipe, replace the pumps (40 hp), and evaluate and upsize wet well ⁽²⁾ | | | 2025 | \$2.26 |
| Subtotal Lift Stations | | | | | \$5.76 |
| Pipeline Projects | | | | | |
| Project ID | Description | Diameter (inch) | Length (feet) | Recommended Year Online | Total Project Cost |
| SW-3 | Extend MLS #5 (RTU 071) force main along Cortez Road to MLS 1-M (RTU 203) ⁽³⁾ | 20 | 10,113 | 2020 | \$5.05 |
| SW-4 | Upsize force main connecting Lift Stations 2-A, 1-A, and 16-A (RTUs 439, 135, and 440) to MLS 12-A | 20 | 965 | 2025 | \$0.48 |
| SW-5 | Upsize Lift Station 7-A (RTU 137) force main | 8 | 1,615 | 2025 | \$0.32 |
| SW-6 | Upsize Lift Station 6-A (RTU 136) force main | 12 | 1,902 | 2025 | \$0.57 |
| SW-7 | Upsize MLS 36-A (RTU 241) influent gravity main | 21 | 1,247 | 2025 | \$1.11 |
| | | 24 | 850 | | |
| SW-8 | Upsize MLS 13-A (RTU 408) Influent Gravity Main | 24 | 1,350 | 2035 | \$0.81 |
| SW-9 | Upsize Force Main on US 41 (from Magellan Drive to 69th Avenue West) | 16 | 1,027 | 2035 | \$0.41 |
| SW-10 | Upsize the existing 8-inch gravity main upstream of MLS 1-M (RTU 203) on Palma Sola Boulevard. | 12 | 1,061 | 2035 | \$0.32 |
| Subtotal Pipeline Projects | | | | | \$9.07 |
| Pump Replacement Projects | | | | | |
| Project ID | Description | Horse-power (hp) | Number of Pumps | Recommended Year Online | Total Project Cost |
| SW-11 | Replace pumps at the following lift station RTUs to prevent manhole overflows and surcharging in upstream gravity system: 136 457 | | 2 (each) | 2025 | |
| | | 15 | | | \$0.04 |
| | | 10 | | | \$0.04 |

| Table ES.4 Master Plan Recommended Infrastructure Improvements Southwest WWCS Master Plan Update Manatee County | | | | | |
|---|--|---------------------------------|----------|------------------------------------|--|
| Master Plan Project | | | | | Project Cost Estimate (\$M) |
| Lift Station Evaluation/Replacement Projects | | | | | |
| Project ID | Description | | | Recommended Year Online | Total Project Cost |
| SW-12 | Replace pumps at the following lift station RTUs to prevent surcharging in upstream gravity system: 217 437 | 15 5 | 2 (each) | 2025 | \$0.04 \$0.03 |
| SW-13 | Replace pumps at the following lift station RTUs to provide additional capacity for USF/Airport flows: 137 149 | 5 2 | 2 (each) | 2025 | \$0.03 \$0.03 |
| SW-14 | Replace pumps at the following lift station RTUs to meet firm pump capacity under future LOS conditions ⁽⁴⁾ : 108 116 141 258 319 342 | 15 20 15 2 15 30 | 2 (each) | 2025 | \$0.04 \$0.04 \$0.04 \$0.03 \$0.04 \$0.05 |
| SW-15 | Replace pumps at Airport Industrial Park lift station (RTU 469) | 2 | 2 | 2035 | \$0.03 |
| Subtotal Pump Replacement Projects | | | | | \$0.48 |
| Total | | | | | \$15.31 |
| Notes: | | | | | |
| (1) Because this is expected to be partially funded by developers, the County anticipates this project coming online by 2020. | | | | | |
| (2) Carollo completed a separate, concurrent project to provide a cost estimate for the relocation of this lift station (2016). | | | | | |
| (3) Cost estimate based on a 12-foot diameter wet well. | | | | | |
| (4) Firm pumping capacity exceeded during LOS scenario based on rated pump capacity provided by County. | | | | | |

| Table ES.5 Recommended Changes to FY 2015-2019 CIP Projects Southwest WWCS Master Plan Update Manatee County | | | | | | | | |
|---|---|------------------------------------|-----------------------------------|----------------------|--|---|---|--|
| FY 2015-2019 CIP Project | | | As Proposed in Master Plan | | | | | |
| Project ID | Description | FY 2015-2019 CIP Cost (\$M) | Diameter (inch) | Length (feet) | Estimated Savings⁽¹⁾ (%) | Entire Project Length⁽²⁾ (feet) | Percent of Project Changed⁽³⁾ (%) | Savings with Respect to FY 2015-2019 CIP Cost (\$M) |
| WW00974 | MLS #5 (RTU 071) Force Main Replacement | \$4.17 | 16 | 8,781 | 30.4% | 13,557 | 100% | \$1.27 |
| | | | 18 | 3,465 | | | | |
| | | | 18 | 1,311 | | | | |
| WW00975 | MLS 12-A (RTU 139) Force Main Replacement - First Segment Only | \$4.50 | 20 | 3,393 | 16.7% | 10,297 | 33% | \$0.25 |
| 6035781 | MLS 1-D (RTU 237) Force Main Replacement | \$3.00 | 20 | 4,637 | 22.6% | 12,150 | 100% | \$0.68 |
| | | | 20 | 7,513 | | | | |
| 6085780 | Extension of MLS 1-D (RTU 237) Force Main, part of the 1-M MLS (RTU 203) Force Main CIP Description | \$2.72 | 20 | 205 | 37.6% | 16,730 | 13.5% | \$0.14 |
| | | | 20 | 694 | | | | |
| | | | 24 | 1,364 | | | | |
| WW00976 | MLS 13-A (RTU 408) Force Main Replacement - Second Segment Only | \$5.28 | 27 | 304 | 25.0% | 13,255 | 2.3% | \$0.03 |
| WW01037 | Lift Station 23-A (RTU 410) Force Main Replacement | \$0.33 | 8 | 1,385 | -33.7% ⁽⁴⁾ | 1,385 | 100% | (\$0.11) ⁽⁴⁾ |
| Total Savings due to Recommended Changes to FY 2015-2019 CIP Projects (Thousand Dollars) | | | | | | | | \$2.25 |
| Notes: | | | | | | | | |
| (1) With respect to projected CIP costs of the segment proposed for change. | | | | | | | | |
| (2) Scaled length of segments included in the original CIP description from model. | | | | | | | | |
| (3) Based on length only. | | | | | | | | |
| (4) Additional expenditures instead of savings. Proposed change includes upside of the CIP project as planned. | | | | | | | | |

**Table ES.6 20-Year CIP Summary
Southwest WWCS Master Plan Update
Manatee County**

| Description | Service Area | Fiscal Year ⁽¹⁾ | | | | | | | | | | |
|--|----------------------------|----------------------------|-----------------|-----------------|---------------|---------------|---------------|---------------|---------------|---------------|----------------|---------------|
| | | 2016 | 2017 | 2018 | 2019 | 2020 | 2021 | 2022 | 2023 | 2024 | 2025 | 2026 - 2035 |
| Existing CIP Projects⁽²⁾ | North | \$5.42 | - | \$0.52 | - | - | - | - | - | - | - | - |
| | Southeast | \$1.12 | \$2.62 | \$5.00 | - | - | - | - | - | - | - | - |
| | Southwest | \$22.49 | \$1.55 | \$1.05 | - | - | - | - | - | - | - | - |
| | County-wide ⁽³⁾ | - | \$2.50 | \$3.00 | \$5.00 | \$2.00 | \$2.00 | \$2.00 | \$2.00 | \$2.00 | \$2.00 | \$20.00 |
| | Subtotal | \$29.02 | \$6.67 | \$9.57 | \$5.00 | \$2.00 | \$2.00 | \$2.00 | \$2.00 | \$2.00 | \$2.00 | \$2.00 |
| Savings to CIP Projects Due to Evaluations in Master Plan Updates | Southeast | - | \$(0.81) | \$(3.24) | - | - | - | - | - | - | - | - |
| | Southwest | \$(2.25) | - | - | - | - | - | - | - | - | - | - |
| | Subtotal | \$(2.25) | \$(0.81) | \$(3.24) | - | - | - | - | - | - | - | - |
| Recommended Master Plan Projects | North | - | - | - | - | \$1.15 | \$1.17 | \$0.95 | \$0.54 | \$0.54 | \$0.64 | - |
| | Southeast | \$0.17 | \$0.17 | \$0.22 | - | - | - | - | - | - | - | - |
| | Southwest | - | - | - | - | \$5.05 | \$2.77 | \$3.07 | \$1.50 | - | \$1.35 | \$1.57 |
| | Subtotal | \$2.01 | \$1.50 | \$1.68 | \$0.14 | \$6.20 | \$4.23 | \$4.31 | \$2.04 | \$0.54 | \$1.99 | \$1.57 |
| Existing CIP and Recommended Projects - Total⁽⁴⁾ | \$28.78 | \$7.36 | \$8.01 | \$5.14 | \$8.20 | \$6.23 | \$6.31 | \$4.04 | \$2.54 | \$3.99 | \$21.57 | |

- Notes:
- (1) Costs shown in \$M.
 - (2) Includes Collections, Restoration & Rehab, and Transportation-related projects from the adopted FY 2015-2019 CIP. Does not include MARS or Treatment projects.
 - (3) AMP recommended projects are assumed to be completed using funds from the End of Service Life CIP (which is included in the existing County-wide CIP projects). A budget amount of \$2 M per year was assumed for fiscal years 2021 through 2035.
 - (4) Includes cost savings for the Southeast and Southwest Service Areas.

SUMMARY AND CONCLUSIONS

The Southwest WWCS Master Plan provides recommendations to allow the wastewater collection system to meet the County's selected performance criteria and to provide wastewater service as future growth occurs within the County.

The primary wastewater collection system issues the County will need to address in the near future are the hydraulic challenges associated with master lift station discharge force mains, the upgrade of the force mains connecting upstream of the SWWRF influent pipe, and the capacity limitation in the 24-inch gravity pipe upstream of MLS 1-M (RTU 203). The County was already aware of the capacity limitations in the force mains stated above and has CIP projects in place to alleviate them (see Appendix I). A new project to extend the MLS #5 (RTU 071) force main all the way to MLS 1-M (RTU 203) to divert a large portion of flow from the 24-inch gravity main on Cortez Road was identified in this Master Plan as a high priority project.

Other issues identified in the Southwest WWCS included force mains with limited capacity (velocities higher than 6 fps for long durations), lift stations with firm capacity exceeded during LOS conditions, and localized surcharges and/or overflows in the gravity system due to capacity constraints. These issues were gradually solved between planning years 2025 and 2035 with several infrastructure improvement projects. Improvements are also required due to the additional flows expected from the USF/Airport areas.

Although the WWCS Master Plan presents planning scenarios based on best available information, the County should continue to update the land use plan, hydraulic model, and Master Plan as new developments, land use changes, or additional information becomes available. In addition, the County should continue their efforts in identifying infrastructure prone to inflow and infiltration (I&I) and planning for the repair and/or replacement of aging infrastructure.

INTRODUCTION

Manatee County (County) requested that Carollo Engineers, Inc. (Carollo) prepare an update to its Wastewater Collection System (WWCS) Master Plan for each of its three service areas (North, Southeast, and Southwest). The purpose of this project is to define anticipated future population growth and wastewater flow projections, complete and document updates to the County's Southwest Service Area hydraulic model, provide future infrastructure recommendations to accommodate projected flows, and develop a 20-year capital improvements program (CIP). This chapter presents a brief background of the Southwest Service Area WWCS, objectives of the Master Plan project, and a description of all report chapters.

1.1 BACKGROUND

Manatee County is located on the west coast of Florida and is part of the Bradenton-Sarasota-Venice Metropolitan Statistical Area. Based on information from the US Census Bureau, the total County area is approximately 893 square miles, of which 741 square miles are land and 152 square miles are water. The County's collection system is separated into three service areas, each with their own collection system and water reclamation facility (WRF): North, Southeast, and Southwest. Figure 1.1 shows the location of Manatee County and the three service area boundaries. Currently, the County provides wastewater services to a population of approximately 258,967 (not including those served by septic tanks), 44.6 percent of which reside within the Southwest Service Area. The population within the Southwest Service Area is projected to grow by 16.6 percent by 2035 (see Table 3.1).

The majority of the County's original wastewater collection system was constructed in multiple phases between 1974 and 1978. Approximately 56.9 percent of the force mains in the Southwest Service Area were installed between 1970 and 1989. The County provides wastewater collection services to most of the developed areas within the County, including the Cities of Bradenton Beach, and Anna Maria and the Town of Longboat Key (excluding the Cities of Bradenton and Palmetto), including residential, commercial, and industrial users. Although they don't provide wastewater collection services for the Town of Longboat Key, the County receives flow from the Town (via a 20-inch force main owned and operated by the Town) and treats it at the Southwest Water Reclamation Facility (SWWRF).

Wastewater in the County is collected by relatively small diameter gravity mains and is transported by gravity flow to 591 County-owned lift stations and 367 privately-owned lift stations. The County maintains just over 80 miles of force mains up to 48 inches and over 350 miles of gravity sewers up to 36 inches in the Southwest Service Area.

In the Southwest Service Area, a majority of the wastewater flow is conveyed to the SWWRF via one of five master lift stations MLSs: 12-A, 13-A, 27-A, 1-D, and 1-M. An additional MLS (#5) conveys flow from Anna Maria Island to MLS 1-M on the mainland.

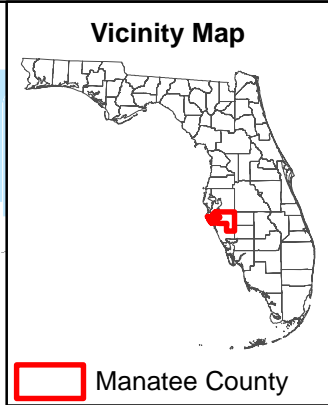
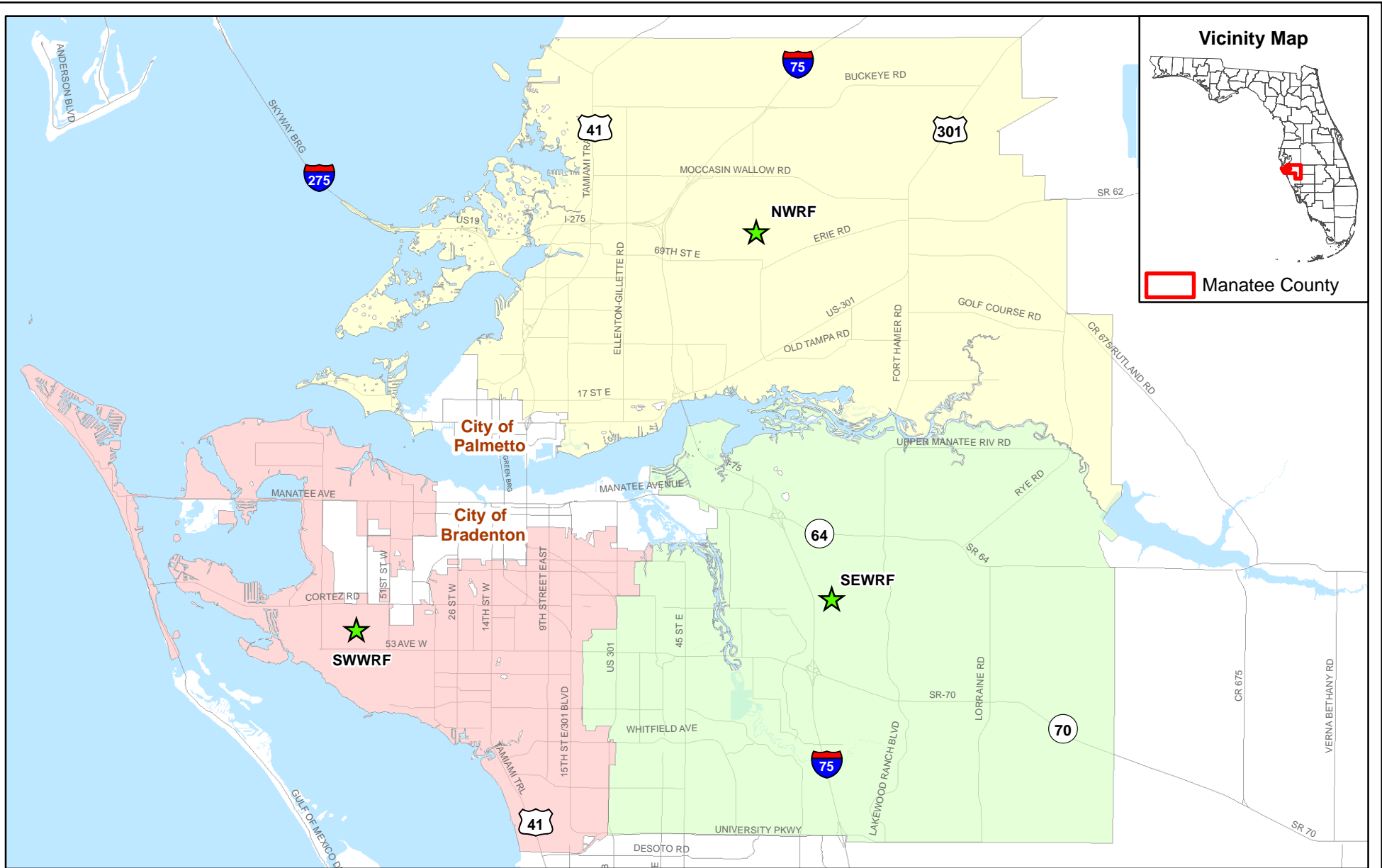

Legend

- ★ Water Reclamation Facility
- Major Roads
- Service Area**
- North
- Southeast
- Southwest

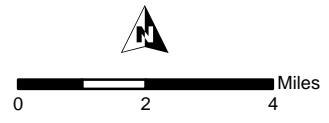

Figure 1.1
Location Map
 Southwest WWCS Master Plan Update
 Manatee County
carollo
 Engineers...Working Wonders With Water®

1.2 PREVIOUS MASTER PLAN

The County's previous Southwest WWCS Master Plan was completed in 2006 by McKim & Creed. The 2006 Master Plan identified several pump replacements required at the time the report was released, some of which are already in progress or planned to be complete by 2020. Some others have also been identified as needs in this Master Plan. The recommended infrastructure and improvements from the previous master plan were evaluated to determine if these projects are still required and sized properly with respect to the updated population projections.

1.3 OBJECTIVES

The purpose of this Master Plan Update is to identify capacity deficiencies in the existing wastewater collection system, develop feasible alternatives to correct these deficiencies, and plan the infrastructure that will serve future developments. The objectives of the Southwest County WWCS Master Plan Update are to:

1. Update existing infrastructure in the hydraulic model.
2. Develop wastewater flow projections for use in the hydraulic models.
3. Conduct field testing to calibrate the model to represent existing conditions, as of April, 2015.
4. Provide the County the Southwest Service Area hydraulic model.
5. Select performance criteria used to evaluate the adequacy of the wastewater collection system infrastructure. Complete an assessment of the capacity of the collection system relative to current and future flows.
6. Develop land use maps to reflect the projected population growth in the Southwest Service Area.
7. Develop projects for future wastewater infrastructure based on planned developments, projected populations, and wastewater flows.
8. Develop a 5-year, 10-year, and 20-year CIP for recommended wastewater infrastructure improvements.
9. Prepare a CIP with cost estimates for the infrastructure recommended through 2035, with a detailed implementation schedule for the first five years.
10. Compile project data and analyses into a comprehensive Master Plan Update report.

1.4 SUMMARY OF REPORT CHAPTERS

The Southwest County WWCS Master Plan Update report contains eight chapters, followed by appendices that provide supporting documentation for the information presented in the report. A summary of the content of each chapter is provided below:

Chapter 1 - Introduction: Description of project background, objectives, acknowledgements, and project references.

Chapter 2 - Study Area: Provides background information on local climate, topography, inflow and infiltration, and the existing Southwest Service Area collection system.

Chapter 3 - Planning Framework: Description of the methodology used to determine wastewater peaking factors, diurnal flow patterns, flow projections, and the performance criteria used to evaluate existing and future infrastructure.

Chapter 4 - Wastewater Model Development and Calibration: Description of the Southwest Service Area wastewater model development, including data input into the model, and calibration methodology and results.

Chapter 5 - Existing (2015) Scenario Evaluation: Modeling evaluation and results for the existing collection system, including identification of existing wastewater collection system deficiencies and recommendations for infrastructure improvements.

Chapter 6 - Future Scenario Evaluations: Modeling evaluation and results for the future collection system, including identification of deficiencies and recommendations for infrastructure needed at 5-year (2020), 10-year (2025), 20-year (2035), planned development, and ultimate build-out conditions.

Chapter 7 - Capital Improvements Plan: Description of methodology for cost estimates and a summary of recommended CIP projects.

Chapter 8 - Conclusions and Recommendations: Summary of wastewater system improvements and CIP projects.

1.5 ACKNOWLEDGEMENTS

Carollo Engineers wishes to thank County staff involved in this project, including Jeff Goodwin, Sia Mollanazar, Scott May, Dave Branning, Anthony Benitez, Nick Wagner, Rob Shankle, Ralph Braun, Martin Rafferty, Bill Elmore, Jeff Blosser, Mark Simpson, John Osborne, and all others that provided assistance in collecting data and providing input throughout the project. County staff was instrumental in completing this project.

1.6 REFERENCES

The following documents were referenced in the preparation of this Master Plan Update:

Carollo Engineers, Inc. June 2015. Manatee County Level of Service Evaluation.

Carollo Engineers, Inc. December 2014. SWWRF Collection System and Rubonia Area Inflow and Infiltration Study.

Carollo Engineers, Inc. October 2014. Forcemain and Valve Asset Management Program.

Florida Department of Transportation. August 2001. Intensity-Duration-Frequency Curve.

Health Educations Services Division. 2004 Edition. Recommended Standards for Wastewater Facilities “(Ten State Standards)”.

Manatee County Building and Development Services Department. February 2015. Population Projections.

Manatee County Public Works Department. May 2011. Public Works Utility Standards.

Manatee County. Manatee County Comprehensive Plan (Complete Through Supplement #21)

National Oceanic and Atmospheric Administration (NOAA) Office of Hydrology (HYDRO), 1977. Technical Memorandum No. 35 (HYDRO-35).

Renaissance Planning Group. May 2006. Manatee County Carrying Capacity Study.

U.S. Weather Bureau. 1961. Technical Paper No. 40 (TP-40).

STUDY AREA

Chapter 2 presents the climate and topography in Manatee County, background information on inflow and infiltration, and an overview of the Southwest Service Area collection system.

2.1 CLIMATE AND TOPOGRAPHY

Manatee County is located in the western central part of Florida, along the Gulf of Mexico. The terrain in Manatee County is mostly flat, with an average elevation of 49.76 feet above mean sea level. The Southwest Service Area has an average elevation of 8.59 feet above mean sea level. Figure 2.1 illustrates the general topography of the North, Southeast, and Southwest Service Areas.

The climate in Manatee County is characterized by mild, dry winters, and hot, wet summers. Table 2.1 summarizes the maximum and minimum monthly temperatures as well as the average monthly precipitation. Approximately 60 percent of the annual rainfall occurs between June and September.

| Month | Average Maximum Temperature (°F) | Average Minimum Temperature (°F) | Average Monthly Rainfall (inches) |
|---------------|---|---|--|
| January | 71.5 | 49.8 | 2.7 |
| February | 73.9 | 52.3 | 2.7 |
| March | 77.8 | 56.1 | 3.7 |
| April | 82.2 | 60.1 | 2.4 |
| May | 87.8 | 66.4 | 2.5 |
| June | 90.2 | 72.0 | 7.9 |
| July | 90.8 | 73.5 | 8.0 |
| August | 91.0 | 73.9 | 8.4 |
| September | 89.4 | 72.4 | 7.7 |
| October | 85.0 | 66.0 | 2.7 |
| November | 78.7 | 58.3 | 2.2 |
| December | 73.2 | 52.4 | 2.5 |
| Annual | 82.6 | 62.8 | 53.4 |

General Note:
Source: <http://www.usa.com/manatee-county-fl-weather.htm>

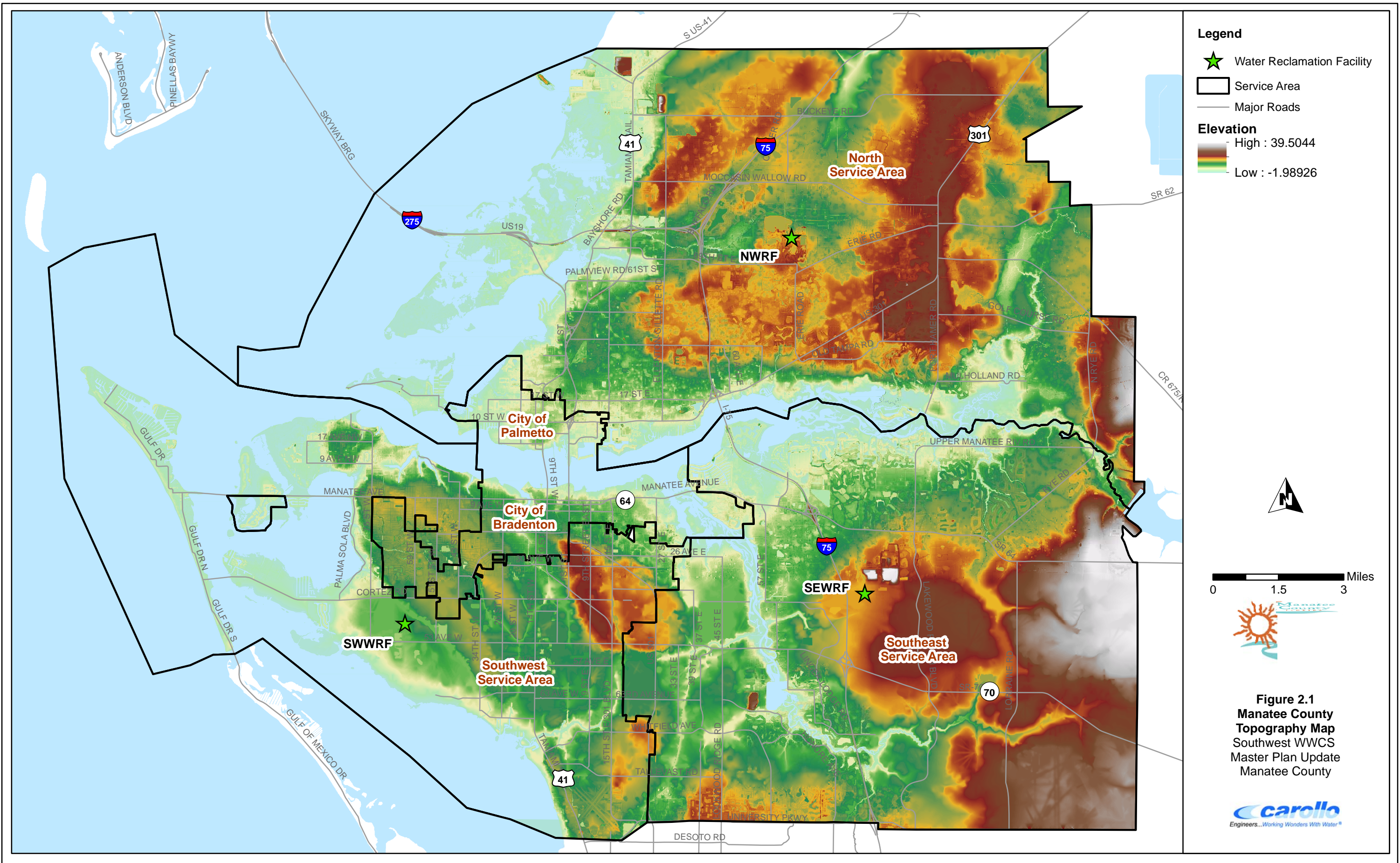

Legend

- Water Reclamation Facility
- Service Area
- Major Roads

Elevation

- High : 39.5044
- Low : -1.98926

Miles
0 1.5 3



Figure 2.1
Manatee County
Topography Map
 Southwest WWCs
 Master Plan Update
 Manatee County



2.2 INFLOW AND INFILTRATION

All wastewater collection systems experience inflow and infiltration (I&I), although the characteristics and severity vary by region and individual collection systems. Some of the most common sources of I&I are shown on Figure 2.2. Infiltration is defined as groundwater (groundwater infiltration) or storm water flows (trench infiltration) that enter the sewer system by percolating through the soil and then through defects in pipelines, manholes, and joints. Examples of infiltration entry points are cracks in pipelines, misaligned joints, and root penetration. Inflow is defined as storm water that enters the sewer system via storm drain cross connections, leaky manhole covers, cleanouts, or illegal storm drain connections.

I&I entering the sewer system increases both the flow volume and peak flows, as illustrated in Figure 2.3. If too much I&I enters the sewer system such that the sewer system is operating at or above its capacity, sanitary sewer overflows (SSOs) could occur. Although both inflow and infiltration are expected to contribute to peak flows after a rainfall event, infiltration is difficult to quantify and was not specifically evaluated for this report. Each of the wastewater flow components shown in Figure 2.3 were not evaluated individually. Chapter 3 discusses the total flows (dry and wet weather) that were evaluated for this Master Plan Update.

Carollo performed an I&I Study in 2014 that evaluated the Southwest Service Area and the Rubonia area of the North Service Area. Due to a higher percentage of older clay pipes, its proximity to the coast, and low elevation of infrastructure, the Southwest Service Area experiences, on average, moderate to high I&I. More detailed results of a wet weather analysis, including inflow percentages, are presented in Chapter 3.

2.3 EXISTING INFRASTRUCTURE

The County's wastewater collection system in the Southwest Service Area consists of gravity sewers, lift stations, and associated force mains that collect and convey flow to the SWWRF, which is located at 5101 65th Street West, Bradenton, Florida.

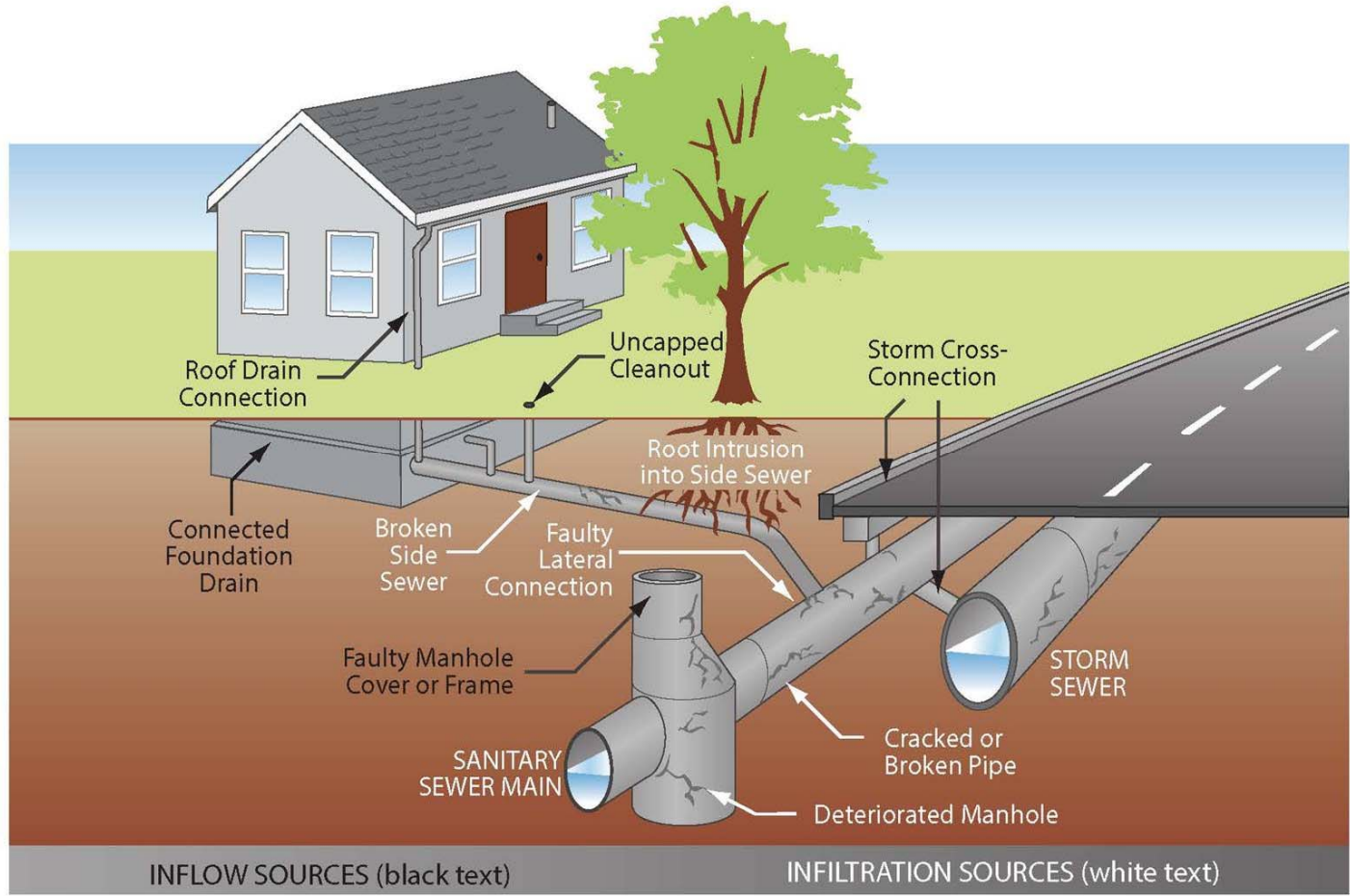

SOURCES OF INFLOW AND INFILTRATION

FIGURE 2.2

MANATEE COUNTY
SOUTHWEST WWCS MASTER PLAN UPDATE

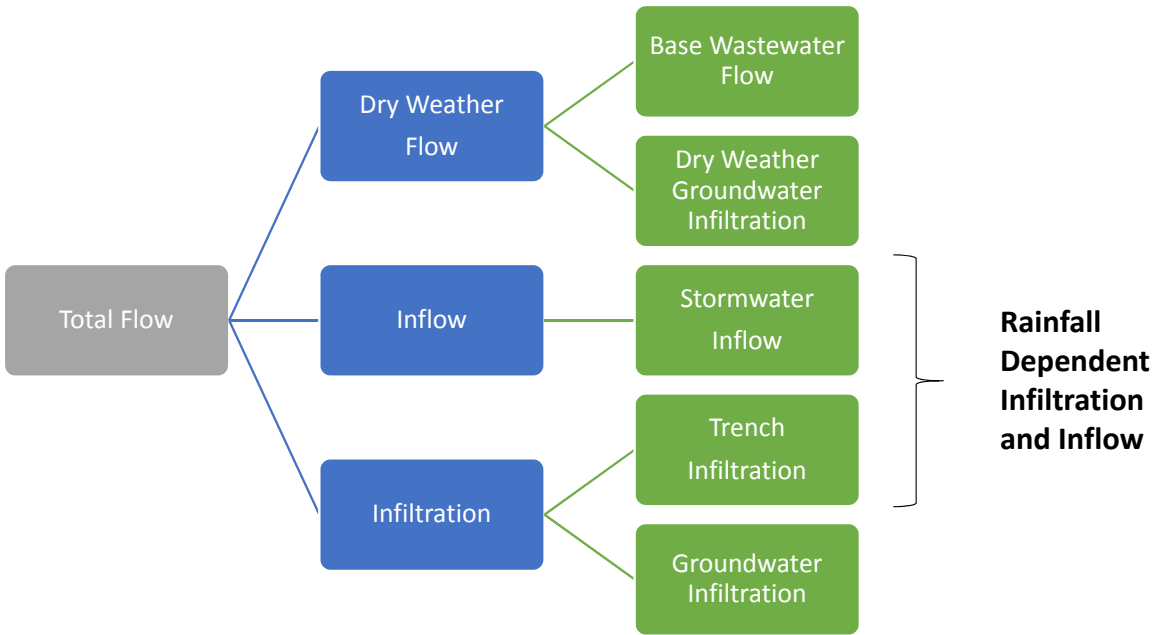
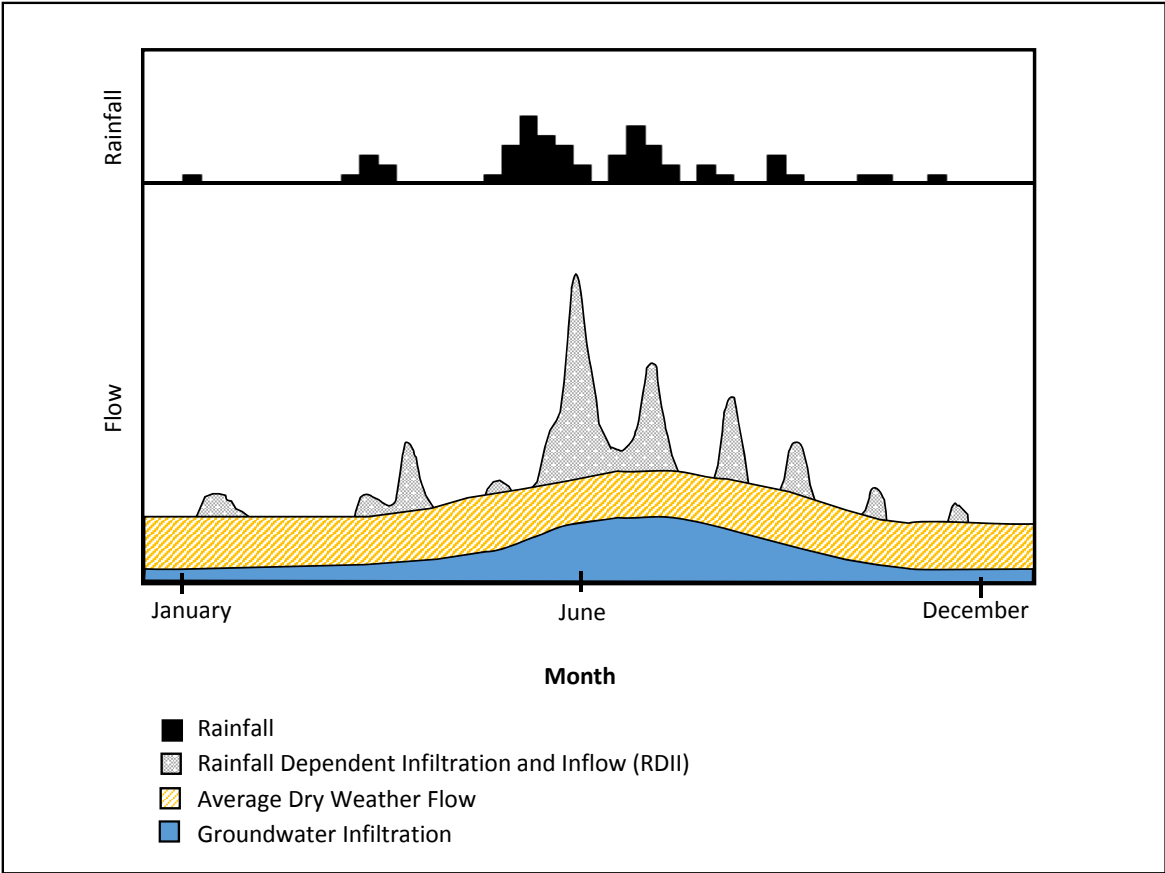

Note: This figure is not based on flow data specific to the County or this Master Plan

TYPICAL WASTEWATER FLOW COMPONENTS

FIGURE 2.3



Figure 2.4 shows the existing collection system in the Southwest Service Area. The existing infrastructure within the Southwest Service Area and the entire County is summarized in Table 2.2. The infrastructure in the Southwest Service Area includes 211 County-owned lift stations, approximately 81 miles of force main, 357 valves, 7,495 manholes, and more than 350 miles of gravity pipe.

Table 2.3 lists the installation year of force mains for each service area. Approximately 41 percent of the force mains in the Southwest Service Area were installed prior to 1980. Table 2.4 and Table 2.5 summarize the existing gravity pipes and force mains by diameter and material, respectively. Approximately 61 percent of the force mains and 87 percent of the gravity collection pipes in the Southwest Service Area are 8 inches in diameter or smaller. The force mains in the Southwest Service Area reach up to 42 inches in diameter and the gravity pipes reach up to 36 inches in diameter. Less than 20 percent of the gravity pipes in the Southwest Service Area are polyvinyl chloride (PVC) and approximately 69 percent are vitrified clay (VCP) material.

| Table 2.2 Summary of Existing Infrastructure⁽¹⁾ Southwest WWCS Master Plan Update Manatee County | | | |
|--|-----------------------------------|--|--------------------------------|
| | Southwest Service Area | Total in All County Service Areas | Percentage of Total |
| Master Lift Stations | 6 | 15 | 40.0% |
| Lift Stations | 205 | 576 | 35.6% |
| Manholes | 7,495 | 17,904 | 41.9% |
| System Valves ⁽²⁾ | 238 | 1,602 | 14.9% |
| Control Valves ⁽³⁾ | 119 | 785 | 15.2% |
| Gravity Main (miles) | 360.7 | 821.4 | 43.9% |
| Force Main (miles) | 80.8 | 350.3 | 23.1% |
| Notes: | | | |
| (1) Based on GIS database as of January 2015. Does not include private or abandoned infrastructure. | | | |
| (2) System valves in the GIS represent isolation valves. | | | |
| (3) Control valves in the GIS represent air release valves (ARVs). | | | |

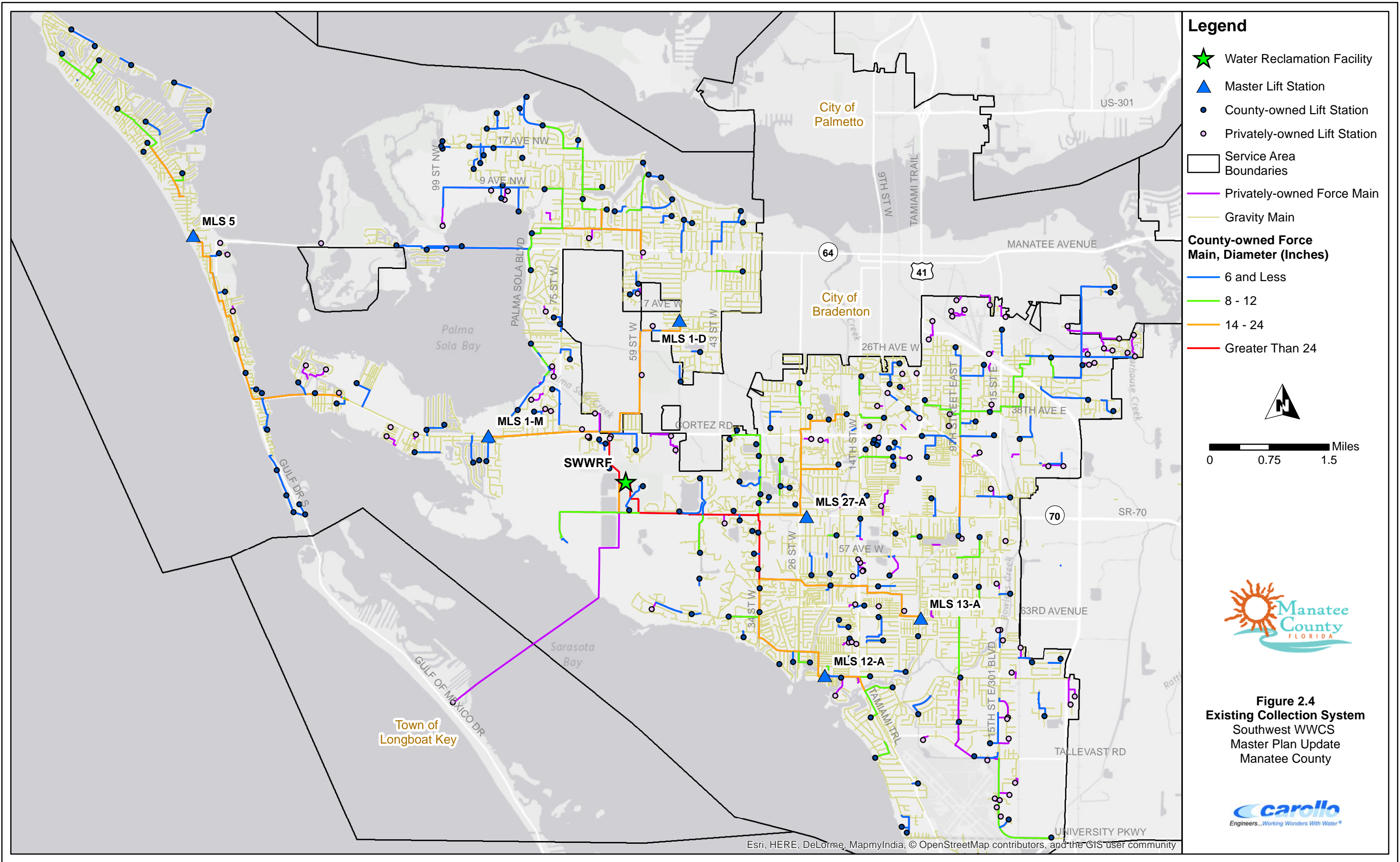

Figure 2.4
Existing Collection System
 Southwest WWCs
 Master Plan Update
 Manatee County

| Table 2.3 Force Main Installation Dates Southwest WWCS Master Plan Update Manatee County | | | | |
|---|---|------------------|------------------|------------------|
| Year Installed | Length of Pipe (miles) (Percent of Service Area Total) | | | |
| | North | Southeast | Southwest | Total |
| Prior to 1980 | 2.1 (2%) | 0.8 (0.5%) | 32.8 (40.6%) | 35.7 (10.2%) |
| 1980-1989 | 29 (26.7%) | 37.1 (23%) | 13.3 (16.4%) | 79.3 (22.6%) |
| 1990-1999 | 18.3 (16.9%) | 38.8 (24.1%) | 9.4 (11.6%) | 66.5 (19.0%) |
| 2000-2009 | 53.6 (49.5%) | 73.7 (45.7%) | 20.9 (25.9%) | 148.2 (42.3%) |
| 2010-2015 | 3.9 (3.6%) | 8.5 (5.2%) | 2.6 (3.3%) | 15 (4.3%) |
| Unknown | 1.4 (1.3%) | 2.3 (1.4%) | 1.8 (2.2%) | 5.5 (1.6%) |
| Total | 108.3 | 161.2 | 80.8 | 350.3 |
| <u>General Note:</u> Based on GIS database as of January 2015. Does not include private or abandoned infrastructure. | | | | |

| Table 2.4 Gravity Main and Force Main Diameters Southwest WWCS Master Plan Update Manatee County | | | | |
|---|---|------------------------------|---|------------------------------|
| Diameter (inches) | Gravity Main | | Force Main | |
| | Length in Southwest Service Area (miles) | Percent by Length | Length in Southwest Service Area (miles) | Percent by Length |
| 4 and Less | 1.5 | 0.4% | 15.1 | 18.7% |
| 6 | 4.5 | 1.3% | 22.5 | 27.8% |
| 8 | 306.7 | 85.1% | 11.6 | 14.4% |
| 10 | 17.5 | 4.9% | 3.4 | 4.2% |
| 12 | 9.1 | 2.5% | 5.6 | 6.9% |
| 14 | 0 | 0.4% | 1.5 | 1.8% |
| 15 | 9.6 | 2.7% | 0.0 | 0.0% |
| 16 | 0.1 | 0.0% | 3.3 | 4.1% |
| 18 | 4.3 | 1.2% | 3.1 | 3.9% |
| 20 | 0.0 | 0.0% | 6.0 | 7.4% |
| 21 | 0.6 | 0.2% | 0.0 | 0.0% |
| 24 | 2.4 | 0.7% | 5.1 | 6.3% |
| 27 | 0.0 | 0.0% | 0.0 | 0.0% |
| 30 | 2.3 | 0.6% | 2.8 | 3.5% |
| Greater than 30 | 1.7 | 0.5% | 0.9 | 1.1% |
| Total | 360.5 | 100% | 80.8 | 100% |
| <u>General Note:</u> Based on GIS database as of January 2015. Does not include private or abandoned infrastructure. | | | | |

| Table 2.5 Gravity Main and Force Main Material Southwest WWCS Master Plan Update Manatee County | | | | |
|---|---|--------------------------|---|--------------------------|
| Material | Gravity Main | | Force Main | |
| | Length in Southwest Service Area (miles) | Percent by Length | Length in Southwest Service Area (miles) | Percent by Length |
| Cast Iron | 1.7 | 0.5% | 11.3 | 13.9% |
| Ductile Iron | 4.3 | 1.2% | 14.5 | 17.9% |
| HDPE | 0.2 | 0.1% | 7.5 | 9.3% |
| PVC | 61.6 | 17.1% | 34.9 | 43.1% |
| VCP | 249.1 | 69.1% | 0.0 | 0.0% |
| Unknown or Other | 43.8 | 12.1% | 12.7 | 15.7% |
| Total | 360.6 | 100% | 80.8 | 100% |
| <u>General Note:</u> Based on GIS database as of January 2015. Does not include private or abandoned infrastructure. | | | | |

PLANNING AND PERFORMANCE FRAMEWORK

3.1 BACKGROUND

Chapter 3 presents the population and flow data used for updating the County's wastewater collection system hydraulic model and developing the Southwest County Wastewater Collection System (WWCS) Master Plan Update. It outlines the planning framework used as the basis for load (flow) inputs into the model. It also presents the performance criteria used to evaluate the system and recommend future projects.

The remainder of the chapter is divided into the following sections:

Section 3.2 – Population Projections: Provides a summary of population projections for each wastewater service area and the current planned residential developments for the Southwest Service Area.

Section 3.3 – Historical Wastewater Flows: Provides a summary of the County's historical wastewater flow data, peaking factors, historical rainfall data, and an inflow analysis.

Section 3.4 – Diurnal Curves: Summarizes typical diurnal curves of sanitary flows for the Southwest Service Area collection system based on recent derived flow data from SCADA .

Section 3.5 – Projected Wastewater Flows: Describes how future flow projections were calculated based on future population, land use, and historical per capita flows.

Section 3.6 – Performance Criteria: Defines criteria, or standards of measurement, for evaluating the performance and design of the County's wastewater collection system.

Section 3.7 – Planning Framework Summary: Provides a summary of wastewater flows, population, and performance criteria used as the basis for developing the model and Southwest WWCS Master Plan Update.

3.2 POPULATION PROJECTIONS

This section describes the County's population projections and planned developments proposed by developers, along with the methodology used for distributing the existing and future population in the model. The methodology for calculating the projected build-out population for the Southwest Service Area is also summarized in this section.

3.2.1 County Population Projections

Population projections were provided by the County in the form of Traffic Analysis Zone (TAZ) GIS shapefiles. Population projections were provided in 5-year increments through 2040. Future scenarios to be included in the models and the Southwest WWCS Master

Plan Update are the 5-year (2020), 10-year (2025), and 20-year (2035) planning periods, planned development, and build-out. The planned development scenario, described further in Section 3.2.2, is an interim scenario between 2035 and build-out and includes the maximum population within all planned developments currently proposed by developers.

Table 3.1 summarizes the population projections provided by the County. These population projections include population served by private homeowner septic tanks. Figure 3.1 shows the Southwest Service Area boundary and the location of parcels served by septic tanks. Figure 3.2 shows the historical and projected population for each service area through 2035.

| Table 3.1 Population Projections Provided By County Southwest WWCS Master Plan Update Manatee County | | | | |
|---|-----------------|------------------|------------------|-----------------|
| Year | North | Southeast | Southwest | Total |
| 2015 | 59,535 | 96,950 | 117,434 | 273,919 |
| 2020 | 66,140 (11%) | 106,990 (10%) | 122,222 (4%) | 295,352 (8%) |
| 2025 | 72,772 (10%) | 117,077 (9%) | 127,053 (4%) | 316,902 (7%) |
| 2030 | 79,364 (9%) | 127,086 (9%) | 131,816 (4%) | 338,266 (7%) |
| 2035 | 85,988 (8%) | 137,152 (8%) | 136,624 (4%) | 359,764 (6%) |
| General Notes: Includes population served by septic tanks. Percentages shown represent the percent increase in population as compared to the previous planning period. | | | | |

The County's population data is broken down into residential, employment, school, and hotel populations for each TAZ area in 5-year increments. When distributing population in the model, each category was adjusted such that the total population reflects an equivalent residential population. Therefore, the total population (sum of residential, employment, school, and hotel) in the model is equivalent to the total TAZ residential population, while still accounting for flows associated with the other population categories.

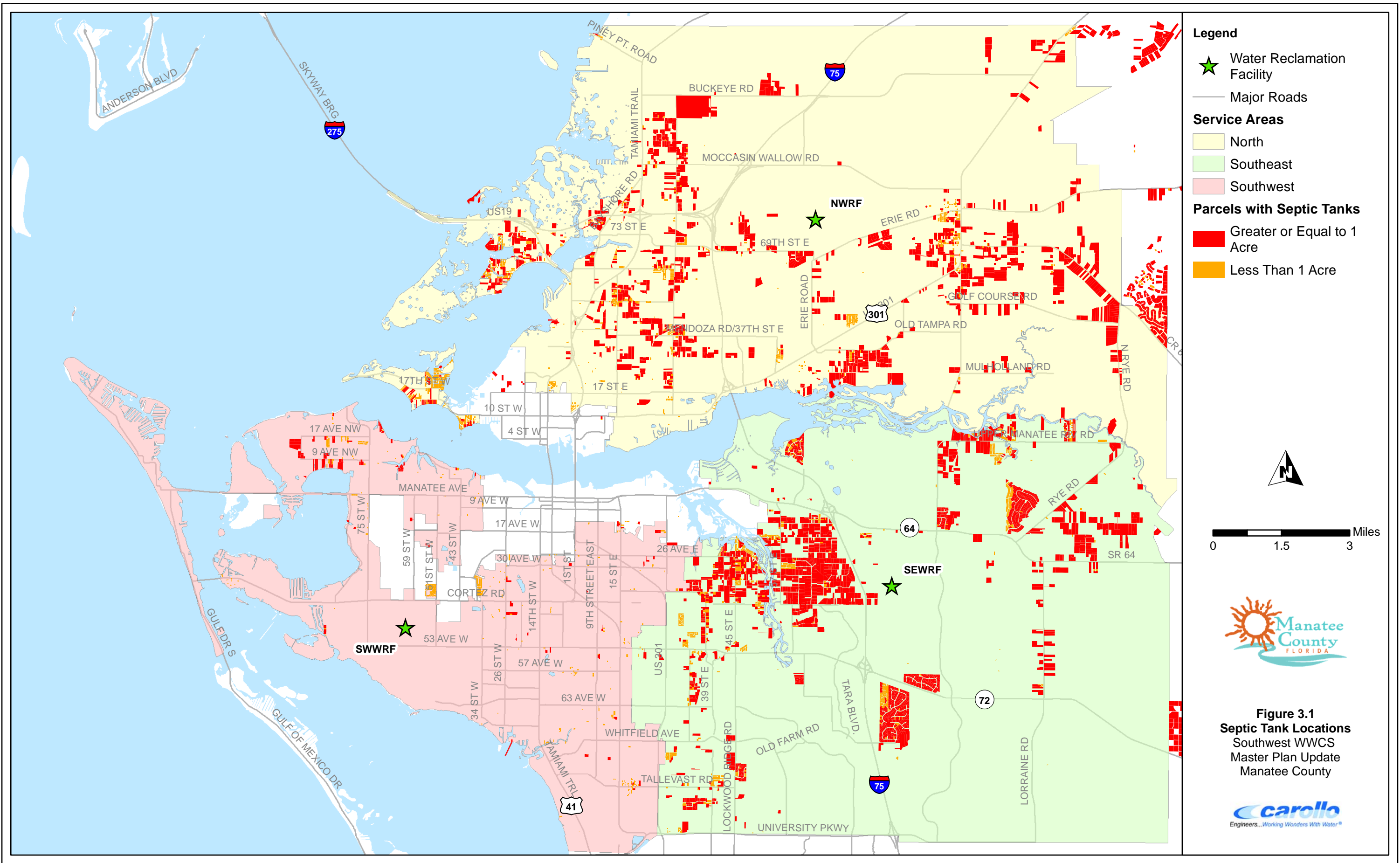

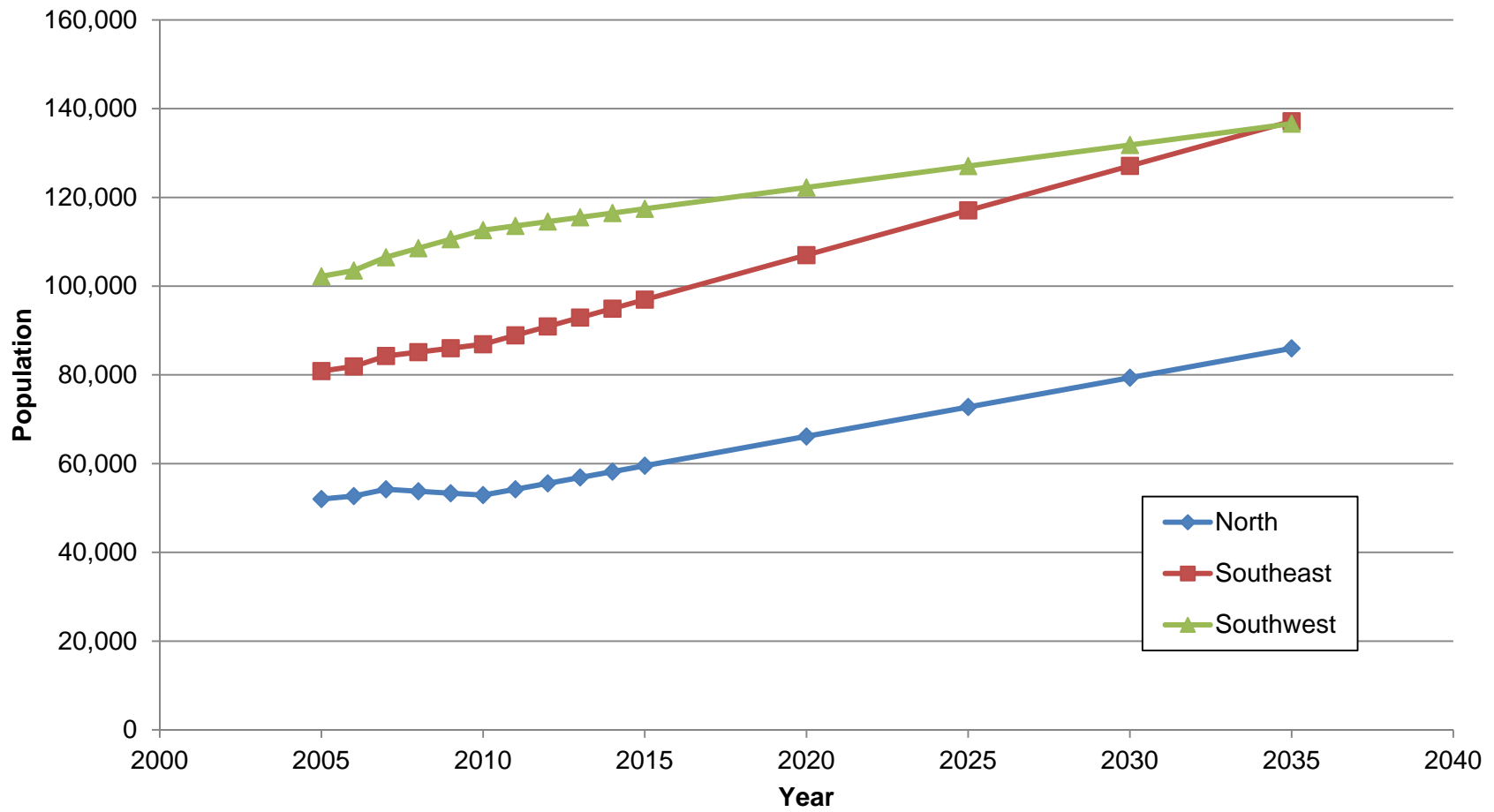

**HISTORICAL AND PROJECTED
POPULATION**

FIGURE 3.2

MANATEE COUNTY
SOUTHWEST WWCS MASTER PLAN UPDATE

3.2.2 Planned Developments

Population growth through 2035 was assumed to occur within known planned developments proposed by developers. The planned developments may be new (future) or an extension of an existing development. The County's GIS Concurrency and Future Development Applications shapefiles and a spreadsheet of the planned developments provided by County Public Works staff were used to delineate the new, future sewer shed boundaries. Table 3.2 lists the planned developments for the Southwest Service Area, as provided by the County. The County's three digit RTU number is used to identify existing lift station sewer sheds, and an "F" number is used to denote future sewer sheds within known proposed developments currently in the planning and/or design phase.

The County's planned developments were based on information received from various developers. The rate of growth within the planned developments, based on the number of dwelling units anticipated to be online as proposed by the developers, was higher than the total TAZ projections provided by the County. Therefore, the growth within the planned developments was scaled down to match the TAZ-based population projections through 2035. The populations shown in Table 3.2 represent the scaled populations used in the model. In addition to the populations shown in Table 3.2, the County is expecting growth in the University of South Florida (USF) Sarasota-Manatee campus and airport areas. These additional flows were added to the model on top of the projected flow based on population. This is discussed further in Section 3.5.

The maximum potential population within the planned developments is included in the planned development scenario, which assumes all developments are built to capacity (based on the maximum number of dwelling units as provided by the developer applications). It was assumed that all other undeveloped parcels would remain undeveloped for purposes of this planning period. Figure 3.3 shows the planned developments and their corresponding lift stations and sewer sheds. Figure 3.3 also shows existing sewer sheds that have future population growth.

**Table 3.2 Planned Developments
Southwest WWCS Master Plan Update
Manatee County**

| Planned Development Name | Corresponding Sewer Shed RTU | Population Type ⁽¹⁾ | Year Online | Maximum Build-Out Potential | | Population in Existing (2015) Scenario | Planning Period | | | | | | | | | | | | | | |
|--|------------------------------|--------------------------------|-------------|-----------------------------|--|--|------------------|----------------------------|------------------|----------------------------|-----------------------------|---------------------------------------|------------------|----------------------------|-----------------------------|---------------------------------------|------------------|----------------------------|-----------------------------|---------------------------------------|---|
| | | | | Population | Equivalent Dwelling Units (EDU's) ⁽²⁾ | | 2020 | | 2025 | | | 2035 | | | | Planned Development | | | | | |
| | | | | | | | Population Added | EDU's Added ⁽²⁾ | Population Added | EDU's Added ⁽²⁾ | Cumulative Population Added | Cumulative EDU's Added ⁽²⁾ | Population Added | EDU's Added ⁽²⁾ | Cumulative Population Added | Cumulative EDU's Added ⁽²⁾ | Population Added | EDU's Added ⁽²⁾ | Cumulative Population Added | Cumulative EDU's Added ⁽²⁾ | |
| Lake Flores 1 | F300 | RES | 2020 | 7,866 | 3,361 | 0 | 1,089 | 465 | 1,191 | 509 | 2,280 | 974 | 2,820 | 1,205 | 5,100 | 2,179 | 2,767 | 1,182 | 7,867 | 3,362 | |
| Lake Flores 1 | F300 | EMP | 2020 | 2,251 | 962 | 0 | 559 | 239 | 566 | 242 | 1,125 | 481 | 649 | 277 | 1,774 | 758 | 479 | 205 | 2,253 | 963 | |
| Lake Flores 2 | F301 | RES | 2020 | 7,866 | 3,361 | 0 | 1,089 | 465 | 1,190 | 509 | 2,279 | 974 | 2,819 | 1,205 | 5,098 | 2,179 | 2,767 | 1,182 | 7,865 | 3,361 | |
| Lake Flores 2 | F301 | EMP | 2020 | 2,251 | 962 | 0 | 558 | 238 | 566 | 242 | 1,124 | 480 | 648 | 277 | 1,772 | 757 | 478 | 204 | 2,250 | 962 | |
| Palma Sola Grande | 217 | RES | Existing | 37 | 16 | 0 | 28 | 12 | 0 | 0 | 28 | 12 | 0 | 0 | 28 | 12 | 9 | 4 | 37 | 16 | |
| Vacant Lots | F305 | RES | 2020 | 378 | 162 | 0 | 105 | 45 | 180 | 77 | 285 | 122 | 0 | 0 | 285 | 122 | 94 | 40 | 379 | 162 | |
| 43rd Terrace W | 203 | RES | Existing | 70 | 30 | 14 | 35 | 15 | 16 | 7 | 51 | 22 | 0 | 0 | 51 | 22 | 5 | 2 | 70 | 30 | |
| Longbar Pointe | F302 | RES | 2020 | 7,481 | 3,197 | 0 | 830 | 355 | 563 | 241 | 1,393 | 595 | 1,240 | 530 | 2,633 | 1,125 | 4,848 | 2,072 | 7,481 | 3,197 | |
| Peninsula Bay - North side of Cortez Rd, (298 Acres) | F303 | RES | 2020 | 4,390 | 1,876 | 0 | 495 | 212 | 559 | 239 | 1,054 | 450 | 1,395 | 596 | 2,449 | 1,047 | 1,941 | 829 | 4,390 | 1,876 | |
| Total Population/EDUs Added | | | | | | | 4,788 | 2,046 | 4,831 | 2,065 | - | - | 9,571 | 4,090 | - | - | 13,388 | 5,721 | - | 13,928 | |
| Total Population in Previous Planning Period | | | | | | | 115,425 | - | 120,213 | - | - | - | - | 125,044 | - | - | - | 134,615 | - | - | - |
| Total Projected Population | | | | | | | 120,213 | - | 125,044 | - | - | - | - | 134,615 | - | - | - | 148,003 | - | - | - |

Notes:
(1) RES = Residential, EMP = Employment, SCH = School. Employment and School populations shown are an equivalent residential population.
(2) Based on 2.34 persons per EDU.

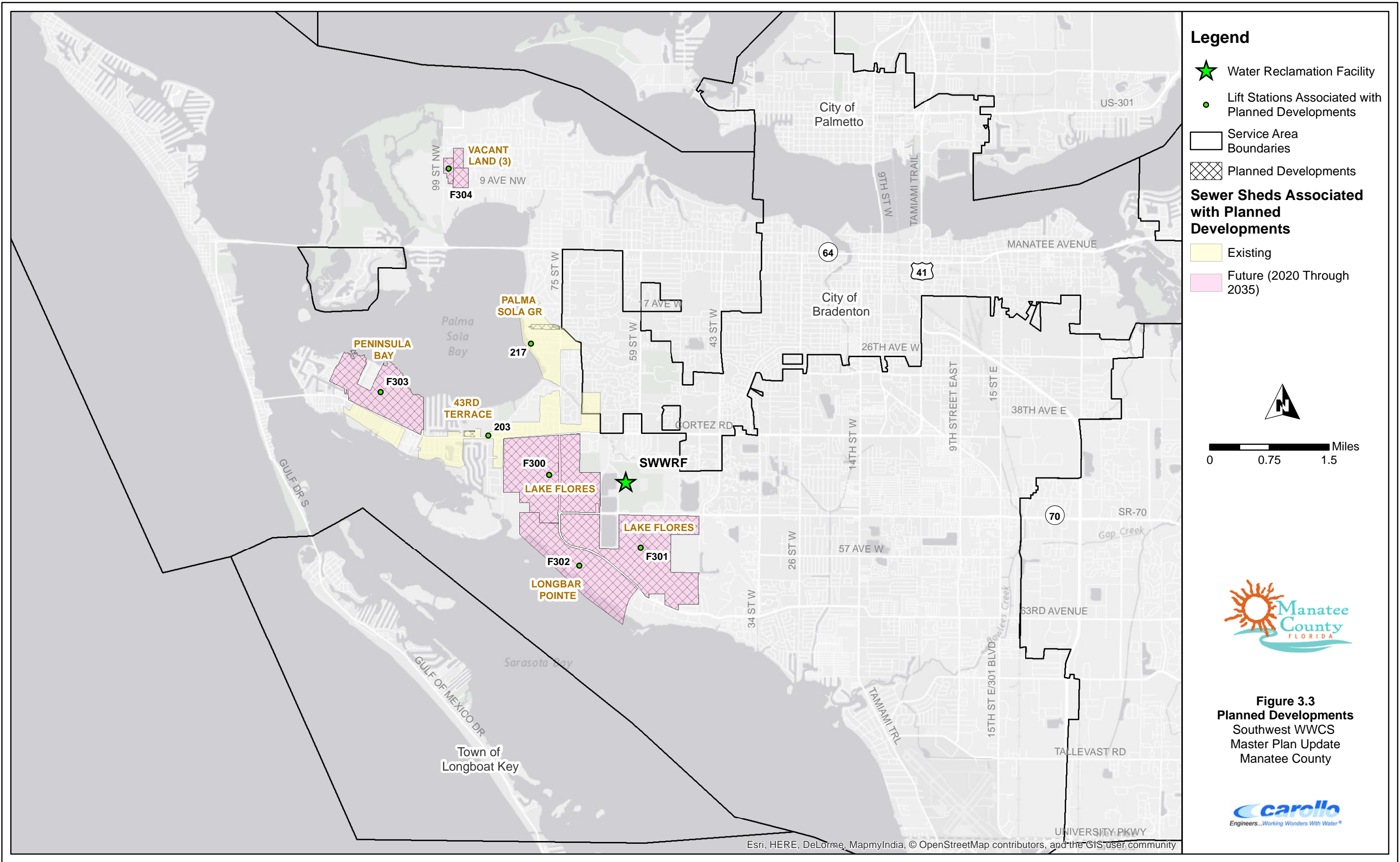

- Legend**
- Water Reclamation Facility
 - Lift Stations Associated with Planned Developments
 - Service Area Boundaries
 - Planned Developments
- Sewer Sheds Associated with Planned Developments**
- Existing
 - Future (2020 Through 2035)

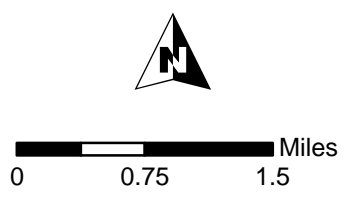

Figure 3.3
Planned Developments
 Southwest WWC
 Master Plan Update
 Manatee County



3.2.3 WWCS Master Plan Population Projections

Because the TAZ population projections provided by the County include residents served by septic tanks, this population was adjusted prior to entering population into the model. This section discusses the methodology and assumptions used in calculating the future population and distributing it to each sewer shed (lift station area) in the model.

Table 3.3 lists the population for each service area used as the basis for the WWCS Master Plan Updates. The population projections from 2015 through the planned development scenario do not include the population served by septic tanks. The septic tank population was subtracted from the total populations presented in Table 3.1 using a septic parcel database provided by the County.

An estimated ultimate build-out population was calculated for each service area, which includes the population served by septic tanks. The methodology used to calculate the build-out population is presented in Section 3.2.3.2.

The population projections listed in Table 3.3 was used as the basis of this WWCS Master Plan Update and to generate flow projections for wastewater collection system hydraulic model.

| Table 3.3 Population Projections (Excluding Population Served by Septic Tanks) Southwest WWCS Master Plan Update Manatee County | | | | |
|--|----------------|------------------|------------------|----------------|
| Year | North | Southeast | Southwest | Total |
| 2015 | 53,115 | 90,427 | 115,425 | 258,967 |
| 2020 | 59,720 | 100,467 | 120,213 | 280,400 |
| 2025 | 66,352 | 110,554 | 125,044 | 301,950 |
| 2030 | 72,944 | 120,563 | 129,807 | 323,314 |
| 2035 | 79,568 | 130,629 | 134,615 | 344,812 |
| Planned Development ⁽¹⁾ | 136,766 | 171,498 | 148,003 | 456,267 |
| Build-Out ⁽²⁾ | 323,009 | 255,013 | 167,969 | 745,991 |
| Notes: | | | | |
| (1) Assumes maximum population growth within planned developments. | | | | |
| (2) Includes population served by septic tanks and growth of all undeveloped parcels. | | | | |

3.2.3.1 Population Distribution to Sewer Sheds in Hydraulic Model

Using County GIS data (pressurized main, gravity main, service lateral, and planned development shapefiles), the boundary for each existing and future County-owned lift station service area (sewer shed) was delineated. The existing and future population was

geographically distributed among the sewer sheds in order to determine the location and magnitude of wastewater flows.

The following assumptions were made when assigning population to the sewer sheds:

- Parcels that are already developed will not increase in population. A "developed" parcel is one that has a service lateral identified in GIS or that is along a street that has a gravity main. The existing (2015) population was distributed among the developed parcels within the existing sewer sheds.
- Undeveloped parcels include parcels that are not currently connected to the County's wastewater infrastructure or parcels that are connected but not yet developed (no residential homes or commercial buildings connected to sewer system).
- All future growth (population increase) through 2035 will occur in known planned developments (as provided by the County and shown in Table 3.2). Where available, actual design plans were used to add future infrastructure to the model.
- The planned development scenario includes the maximum growth of the planned developments, but does not include the population served by septic tanks or undeveloped parcels not located in a planned development.
- Build-out includes the septic tank population and undeveloped parcels not included in a planned development.
- Parcels that are currently served by septic tanks will remain on septic through the planned development scenario but will be connected to the County's sewer system for the build-out scenario.
- Individual sewer shed boundaries were created for each of the planned developments (termed "future" with an associated F number).
- Build-out sewer shed boundaries were created by encompassing large areas of undeveloped land and/or undeveloped parcels not included with an existing sewer shed or planned development (termed "build-out" with an associated BO number).

Figure 3.4 illustrates all sewer shed boundaries (existing, future (planned developments), and build-out) for the Southwest Service Area.

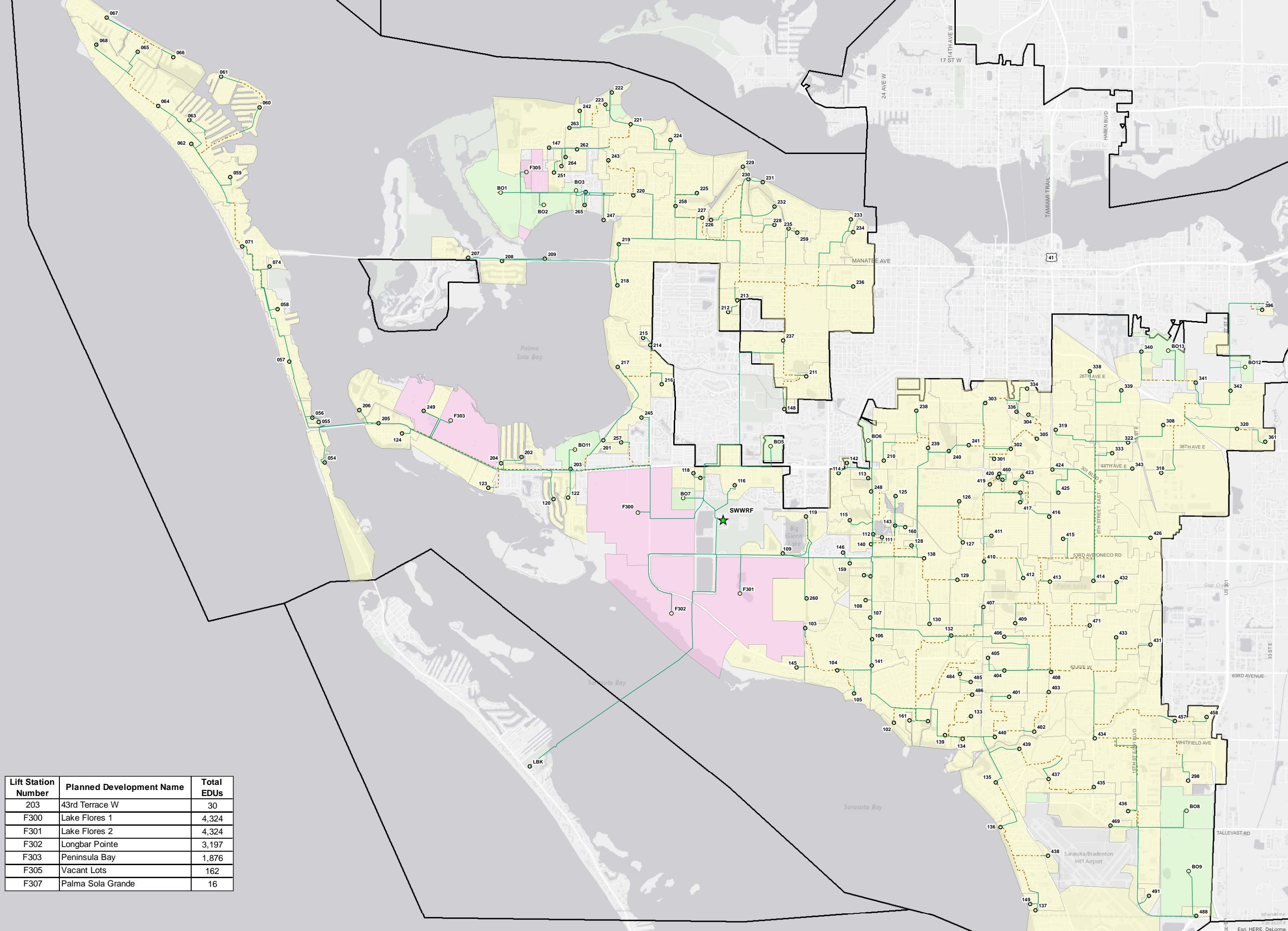

Legend

- ★ Water Reclamation Facility
- Lift Station (RTU #)
- ▭ Service Area
- Force Main
- - - Gravity Main

Sewer Shed (Year Online)

- Existing (2015)
- Future (2020 to 2035)
- Build-Out (Beyond 2035)

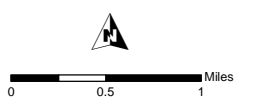

Figure 3.4
Sewer Shed Boundaries
 Southwest WWCS
 Master Plan Update
 Manatee County



| Lift Station Number | Planned Development Name | Total EDUs |
|---------------------|--------------------------|------------|
| 203 | 43rd Terrace W | 30 |
| F300 | Lake Flores 1 | 4,324 |
| F301 | Lake Flores 2 | 4,324 |
| F302 | Longbar Pointe | 3,197 |
| F303 | Peninsula Bay | 1,876 |
| F305 | Vacant Lots | 162 |
| F307 | Palma Sola Grande | 16 |

3.2.3.2 Build-Out Population Methodology

Build-out population projections were determined by analyzing the following types of parcels:

1. Parcels not currently developed and/or connected to the County's wastewater infrastructure and not included in a planned development
2. Large septic parcels (greater than one acre)
3. Small septic parcels (one acre and less)

For build-out, the large septic parcels and undeveloped parcels (collectively referred to as "build-out parcels") are assumed to be developed (or redeveloped) at 75 percent of the maximum allowable density, as described below. The small septic parcels are assumed to connect to the County's infrastructure at build-out as a single dwelling unit per parcel. The following information was used to estimate the build-out population within the service area:

- Future land use type
- Parcel area (acres)
- Maximum (gross) potential residential density (dwelling unit/acre)
- Factor of 0.75 to account for development to 75 percent of the allowable maximum density
- Population density (2.34 persons/dwelling unit)

The County's future land use GIS shapefile was used to assign the future land use type to the build-out parcels. The gross maximum potential residential density (dwelling units per acre, or du/acre) provided in the County's Comprehensive Plan was applied to each build-out parcel based on land use type. A factor of 0.75 was applied because it was assumed that the build-out parcels will only be developed (or redeveloped) to 75 percent of their maximum capacity (per input from the County's Building and Development Services Department).

Table 3.4 summarizes the County's land use types and maximum (gross) potential residential density used in determining the build-out population. An excerpt from the County's Comprehensive Plan outlining the future land use densities is provided in Appendix A. Figure 3.5 shows the future land use type for all parcels within the Southwest Service Area. Residential land use categories are combined into single-family (RES-6 and less) and multi-family (RES-9 and higher) for illustrative purposes in Figure 3.5.

| Table 3.4 Future Land Use Categories Southwest WWCS Master Plan Update Manatee County | |
|---|--|
| Future Land Use Category^(1,2) | Maximum (Gross) Potential Residential Density (du/acre) |
| Agriculture/Rural (AG/R) | 0.2 |
| City (CITY) ⁽³⁾ | 0.5 |
| Estate Rural (ER) | 0.2 |
| Residential-1 (RES-1) | 1 |
| Residential 3.0 (RES-3) | 3 |
| Urban Fringe 3.0 (UF-3) | 3 |
| Residential-6 (RES-6) | 6 |
| Residential-9 (RES-9) | 9 |
| Residential-12 (RES-12) | 12 |
| Residential-16 (RES-16) | 16 |
| Low Intensity Office (OL) | 6 |
| Retail/Office/Residential (ROR) | 9 |
| Industrial-Light (IL) | 1 |
| Mixed Use (MU) | 9 |
| Mixed Use Community (MU-C) | 3 |
| Notes: | |
| (1) From Manatee County's Comprehensive Plan (Supplement #21). | |
| (2) Future land use categories with a zero net potential residential density (i.e. conservation lands, medium/heavy industrial) were not included in this table. | |
| (3) This land use type was one of the land use types provided in GIS; however, it was not listed in the Comprehensive Plan. A density of 0.5 du/acre was assumed. | |

The total area of build-out parcels was calculated from GIS for each land use type and multiplied by the density to determine the number of potential future dwelling units. The County's historical population density of 2.34 persons per dwelling unit (provided by the County) was then applied to determine the maximum population. The total maximum population within the build-out parcels and the small septic parcels was added to the existing population to estimate the total build-out population. These projected populations were distributed among the existing, future, and build-out sewer sheds based on the location of the parcel.

Table 3.5 provides a breakdown of the build-out population, including maximum growth within the planned developments and undeveloped parcels, redevelopment of large septic parcels, and the connection of small septic parcels. The total area and resulting population for each future land use category is also shown for the undeveloped and large septic parcels.

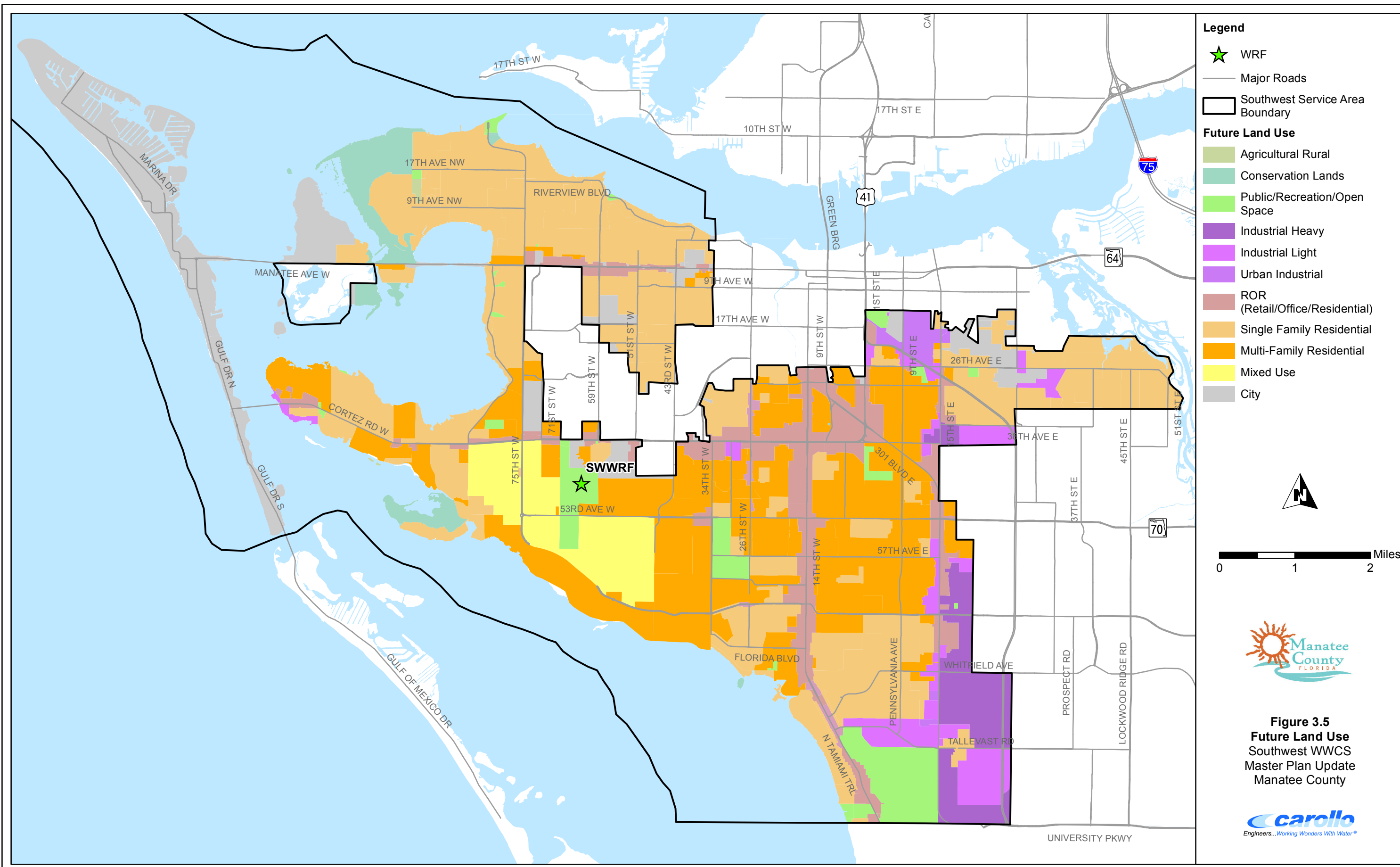

- Legend**
- WRF
 - Major Roads
 - Southwest Service Area Boundary
- Future Land Use**
- Agricultural Rural
 - Conservation Lands
 - Public/Recreation/Open Space
 - Industrial Heavy
 - Industrial Light
 - Urban Industrial
 - ROR (Retail/Office/Residential)
 - Single Family Residential
 - Multi-Family Residential
 - Mixed Use
 - City

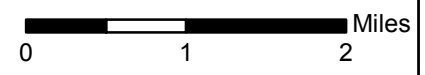

Figure 3.5
Future Land Use
 Southwest WWCs
 Master Plan Update
 Manatee County



| Table 3.5 Build-Out Population Estimate Southwest WWCS Master Plan Update Manatee County | | | | |
|--|----------------------------|-------------------|---|-------------------|
| Land Use Category⁽¹⁾ | Undeveloped Parcels | | Large Septic Parcels (> 1 acre)⁽²⁾ | |
| | Area (Acres) | Population | Area (Acres) | Population |
| AG/R | 0.0 | 0 | 0.0 | 0 |
| CITY | 157.5 | 0 | 0.0 | 0 |
| ER | 0.0 | 0 | 0.0 | 0 |
| RES-1 | 336.2 | 590 | 66.7 | 117 |
| RES-3 | 98.5 | 519 | 76.0 | 400 |
| UF-3 | 0.0 | 0 | 0.0 | 0 |
| RES-6 | 374.4 | 3,942 | 55.6 | 585 |
| RES-9 | 222.9 | 3,521 | 10.1 | 160 |
| RES-12 | 0.0 | 0 | 0.0 | 0 |
| RES-16 | 141.2 | 3,965 | 3.7 | 104 |
| OL | 14.1 | 148 | 4.5 | 47 |
| ROR | 222.5 | 3,514 | 11.9 | 188 |
| IL | 435 | 763 | 0.0 | 0 |
| MU | 0.0 | 0 | 0.0 | 0 |
| MU-C | 0.0 | 0 | 0.0 | 0 |
| Subtotal | 2,002.3 | 17,101 | 228.5 | 1,601 |
| Projected 2035 Population | 134,615 | | | |
| Build-Out Population of Small Septic Parcels (<1 acre) ⁽³⁾ | 1,264 | | | |
| Added Population in Planned Development Scenario ⁽⁴⁾ | 13,388 | | | |
| Total Build-Out Population | 167,969 | | | |
| Notes: | | | | |
| (1) Future land use categories with a zero net potential residential density (i.e. conservation lands, medium/heavy industrial) were not included in this table. | | | | |
| (2) Septic parcels larger than one acre were assumed to be redeveloped based on future land use type prior to connecting to the County's sewer network. | | | | |
| (3) Based on one dwelling unit per parcel and 2.34 persons per dwelling unit. | | | | |
| (4) Based on the difference between the total maximum population within the planned developments (based on maximum dwelling units from developers) and the total future population added through 2035. | | | | |

3.3 HISTORICAL FLOWS

Historical water reclamation facility (WRF) influent flow data was analyzed to determine the average per capita wastewater flow generation and the maximum month and maximum day peaking factors in each service area. Historical wet weather was also analyzed in order to determine an appropriate design storm to model wet weather for the future scenarios.

3.3.1 Historical Wastewater Flows and Peaking Factors

Table 3.6 summarizes the historical flow from 2005 through 2014, peaking factors, and average flow per person for the Southwest Service Area. The maximum monthly and daily flows have been compared to the annual average flow to determine the maximum month and maximum day peaking factors, respectively.

| Table 3.6 Historical Wastewater Flows – Southwest Service Area Southwest WWCS Master Plan Update Manatee County | | | | | | | |
|--|----------------------------------|------------------------------|----------------------------------|----------------------------|--------------------------------|---------------------------------|---------------------------------------|
| Year | Annual Average Flow (mgd) | Max. Month Flow (mgd) | Max. Month Peaking Factor | Max. Day Flow (mgd) | Max. Day Peaking Factor | Population⁽¹⁾ | Average Flow per Person (gpcd) |
| 2005 | 15.97 | 18.26 | 1.14 | - | - | 100,201 | 159.40 |
| 2006 | 15.70 | 20.02 | 1.28 | - | - | 101,510 | 154.68 |
| 2007 | 12.26 | 13.88 | 1.13 | - | - | 104,495 | 117.35 |
| 2008 | 10.75 | 13.01 | 1.21 | - | - | 106,535 | 100.92 |
| 2009 | 11.00 | 12.71 | 1.16 | - | - | 108,575 | 101.33 |
| 2010 | 11.83 | 14.27 | 1.21 | 18.50 | 1.56 | 110,615 | 106.90 |
| 2011 | 11.79 | 14.66 | 1.24 | 18.86 | 1.60 | 111,577 | 105.63 |
| 2012 | 12.08 | 15.68 | 1.30 | 31.60 | 2.62 | 112,539 | 107.30 |
| 2013 | 13.02 | 16.42 | 1.26 | 31.66 | 2.43 | 113,501 | 114.71 |
| 2014 | 12.48 | 14.58 | 1.17 | 22.07 | 1.77 | 114,463 | 109.06 |
| 10-Year Avg. | 12.69 | 15.35 | 1.21 | - | - | - | 117.73 |
| 5-Year Avg. | 12.24 | 15.12 | 1.24 | 20.84 | 1.68 | - | 108.72 |
| 10-Year Max | 15.97 | 20.02 | 1.30 | - | - | - | 159.40 |
| 5-Year Max | 13.02 | 16.42 | 1.30 | 31.66 | 2.62 | - | 114.71 |
| Notes: | | | | | | | |
| (1) Population estimates provided by County Planning Department. Population includes the Town of Longboat Key. | | | | | | | |

The maximum month peaking factor ranged from 1.13 to 1.30 over the past 10 years, and the maximum day peaking factor ranged from 1.56 to 2.62 over the past five years. The average flow per person has decreased by approximately 32 percent between 2005 and 2014, from 159.4 gpcd to 109.1 gpcd. The 5-year average flow per person in the Southwest Service Area is approximately 109 gpcd. The Southwest Service Area is an older system and experiences more inflow and infiltration (I&I), which results in a higher maximum day peaking factor and average flow per person than the other two service areas.

The historical annual average flow from 2005 to 2014 is presented in Figure 3.6. The maximum month and maximum day peaking factors are shown in Figure 3.7

The County recently revised the level of service (LOS) for the North and Southeast Service Areas. Table 3.7 compares the historical five-year average flow per person to the previous and revised LOS values for each service area. As shown, the historical average flow per person for the North and Southeast Service Areas was far less than the previous LOS. The previous LOS values were very conservative and could have led to premature or unnecessary capital improvement projects. The revised LOS values for the North and Southeast more accurately represent the current conditions of the collection system. Since the LOS was not revised by the County for the Southwest Service Area, the previous LOS of 115 gpcd was used for projecting flows in the model scenarios (2015 through build-out).

| Table 3.7 Wastewater Level of Service (LOS) Southwest WWCS Master Plan Update Manatee County | | | |
|---|---|--------------------------------|---|
| Service Area | Historical 5-Year Average Flow per Person (gpcd) | Previous LOS (gpcd) | Revised LOS⁽¹⁾ (gpcd) |
| North | 73.6 | 95 | 80 |
| Southeast | 69.3 | 95 | 85 |
| Southwest | 108.7⁽²⁾ | 115 | 115 |
| <u>Notes:</u> | | | |
| (1) The County revised the LOS for the North and Southeast Service areas in 2015. | | | |
| (2) Historical average per capita calculation includes Town of Longboat Key population. | | | |

3.3.2 Historical Wet Weather Flows

The purpose of analyzing historical wet weather events is to determine how the collection system reacts to rainfall. Depending on factors such as age, location, pipe material, and construction methods, different areas of the collection system may react differently to a particular rainfall event. For example, a low-lying area with older infrastructure may have significantly higher flows for an extended period following a rainfall event. Alternatively, flows may not increase as much in an area with a higher elevation and/or with newer infrastructure.

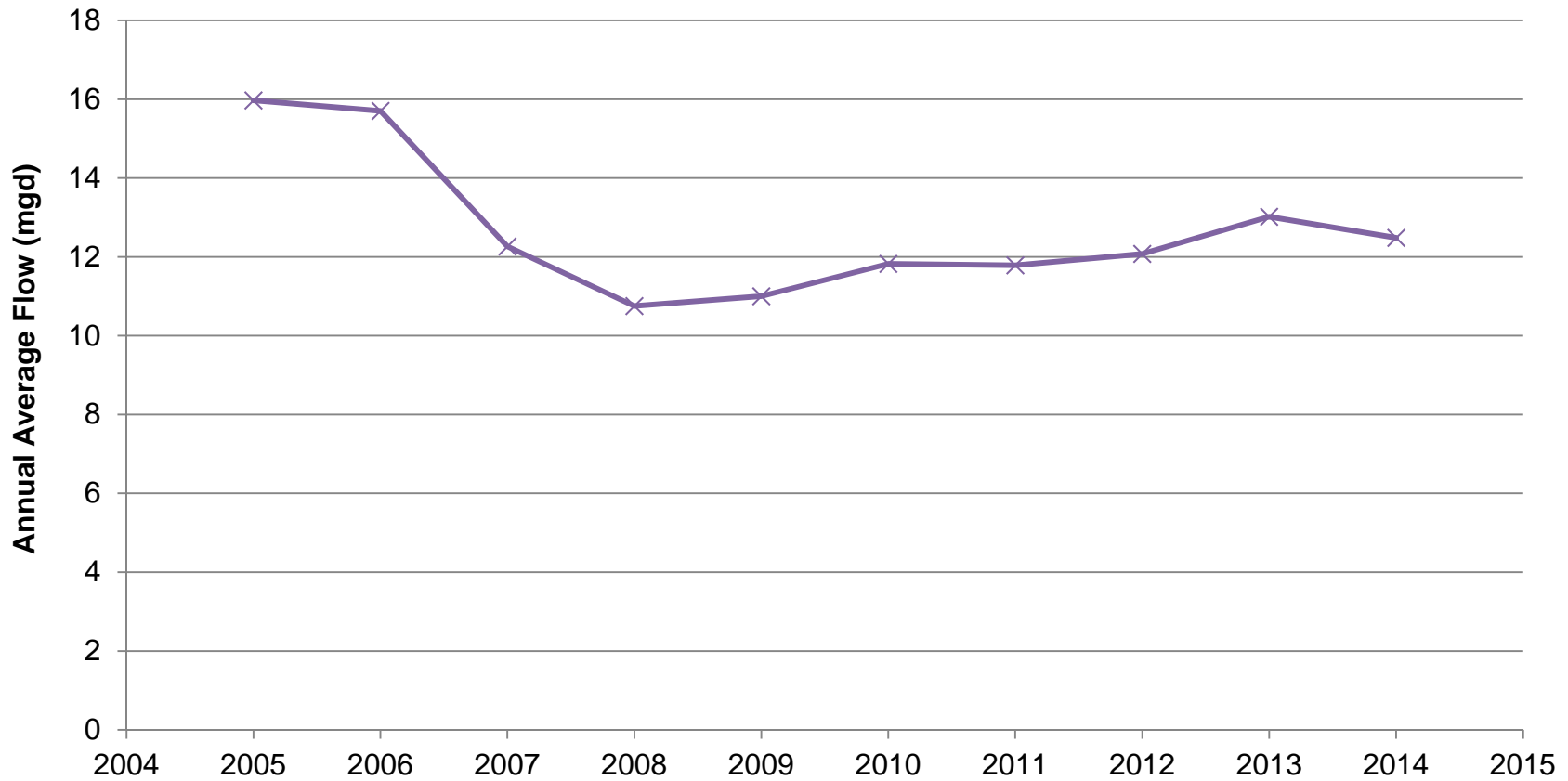

HISTORICAL ANNUAL AVERAGE FLOW

FIGURE 3.6

MANATEE COUNTY
SOUTHWEST WWCS MASTER PLAN UPDATE

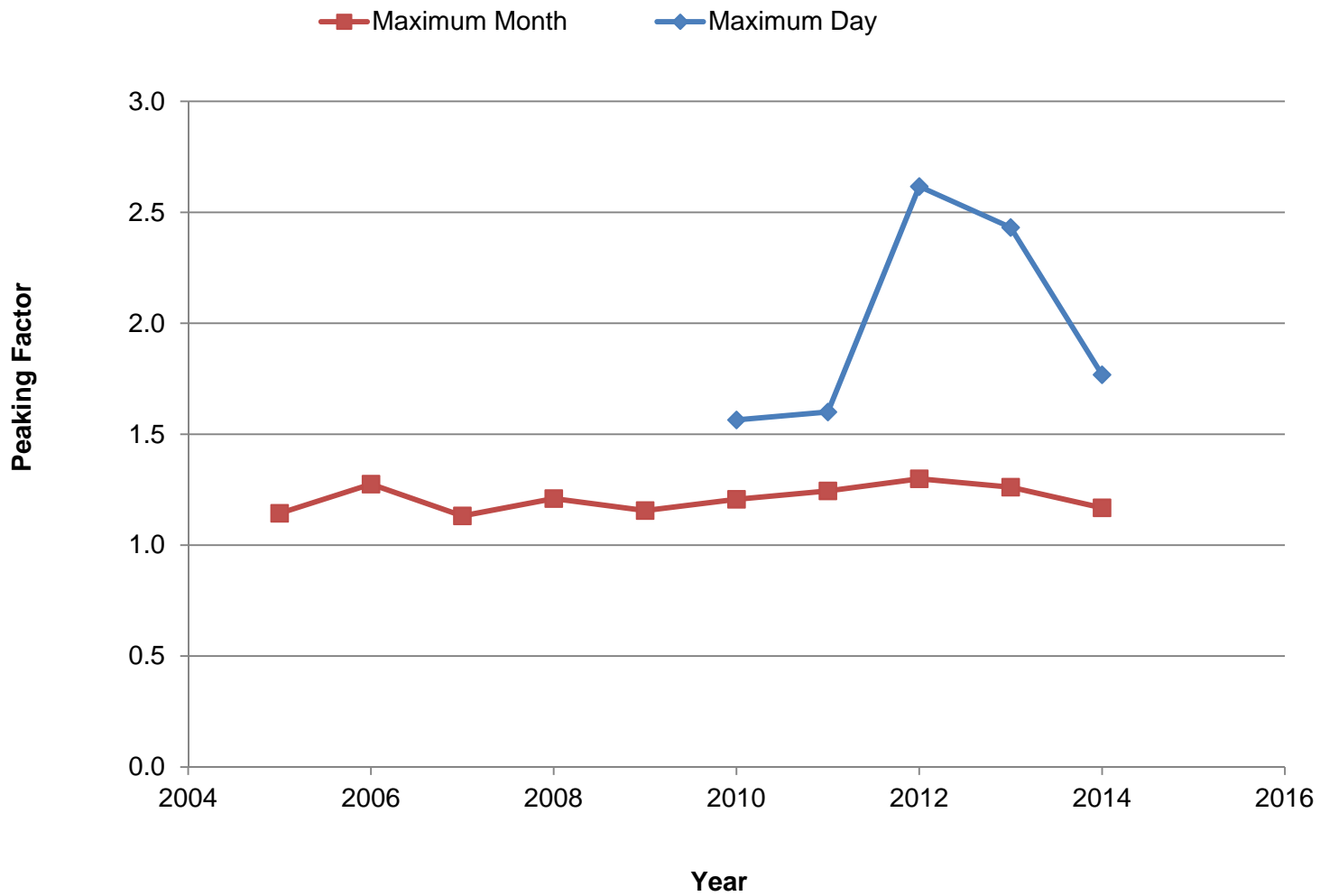

MAXIMUM MONTH AND MAXIMUM DAY PEAKING FACTORS

FIGURE 3.7

MANATEE COUNTY
SOUTHWEST WWCS MASTER PLAN UPDATE



Because of this, some locations within the Southwest Service Area have been analyzed separately to see how each area reacted to historical rainfall events that occurred during a wet weather period. This section describes the methodology behind the determination of the wet weather period used to calibrate the hydraulic model.

Hourly flow and rainfall data from SCADA for the Southwest Water Reclamation Facility (SWWRF), SCADA-derived daily flow data at four master lift stations (1-M, 1-D, 13-A, and 27-A), and pump speed and pressure time series for MLS 12-A (from which flow patterns can be theoretically calculated) for September 23-25, 2013 was used to assess and calibrate wet weather flows for the Southwest Service Area. These data are shown in Table 3.8. Table 3.8 also includes the maximum daily rainfall for each location. It should be noted that the minimum, average, and maximum at master lift stations are from September 23-25, 2013, whereas the rainfall data is the total during the period of analysis (August 1, 2013 – September 30, 2013). The date of the maximum flow and maximum rainfall are also listed in Table 3.8.

| Table 3.8 Flow and Rainfall Analysis Southwest WWCS Master Plan Update Manatee County | | | | | |
|--|----------------------------|---------------------------------------|---------------------|----------------------------------|---|
| WRF/MLS | Rain Gauge Location | Daily Flow (mgd)⁽¹⁾ | | | Maximum Day Rainfall⁽²⁾ (inches) (Date) |
| | | Min | Average | Max (Date) | |
| SWWRF | SWWRF | 16.43 | 22.68 | 31.66 (9/25/13) | 2.35 (9/24/13) |
| MLS 27-A (RTU 138) | MLS 27-A (RTU 138) | 3.77 | 4.00 | 4.22 (9/25/13) | 2.06 (9/25/13) |
| MLS 12-A (RTU 139) | MLS 12-A (RTU 139) | 1.72 ⁽³⁾ | 2.72 ⁽³⁾ | 3.28 ⁽³⁾ (9/24/13) | 1.67 (9/24/13) |
| MLS 1-M (RTU 203) | MLS 1-M (RTU 203) | 3.07 | 3.98 | 4.90 (9/25/13) | 2.54 (9/25/13) |
| MLS 1-D (RTU 237) | MLS 1-D (RTU 237) | 1.04 | 2.38 | 3.54 (9/25/13) | 2.06 (9/25/13) |
| MLS 13-A (RTU 408) | MLS 13-A (RTU 408) | 3.89 | 4.21 | 4.84 (9/25/13) | 1.90 (9/25/13) |
| Notes: | | | | | |
| (1) Based on SCADA and SCADA-derived flow data recorded for September 2013, unless noted otherwise. | | | | | |
| (2) Maximum daily rainfall between 8/1/13 and 9/30/13. | | | | | |
| (3) Based on pump speed and pressure time series for the week of September 22-28, 2013. | | | | | |

During the period analyzed, a large storm event occurred from September 23 to 25, 2013. In total, the storm amounted to 6.85 inches of rainfall at the SWWRF over the 3-day period. The maximum flow at the SWWRF and MLSs occurred during this storm event. Even though flows lower than the minimum daily shown in Table 3.8 (which occurred between the September 23 to 25, 2013 period) occurred in the August through September, 2013 period, no flows lower than the dry weather flows measured and/or recorded during the dry weather calibration period of April 2015, were used to calculate inflow volumes. Such values were deemed incorrect by both Carollo and the County, and therefore dismissed. The maximum daily flow related to the storm event of September 23-25, 2013 at the SWWRF corresponds to the highest daily flow seen by the SWWRF within the past five years (the 5-year max). The 5-year maximum day flows and peaking factors are shown in Table 3.6.

The maximum daily rainfall shown in Table 3.8 was compared to the Florida Department of Transportation (FDOT) Intensity-Duration-Frequency (IDF) curves (Appendix B) to determine the storm's severity. The FDOT IDF curve for Zone 6 (which includes Manatee County) has been used to determine 24-hour duration rainfall amounts for 2-, 5-, 10-, and 25-year storm events within the County. The FDOT IDF curves were developed using depth-duration-frequency data presented in the 1977 National Oceanic and Atmospheric Administration (NOAA) Office of Hydrology (HYDRO) Technical Memorandum No. 35 (HYDRO-35) and the 1961 U.S. Weather Bureau Technical Paper No. 40 (TP-40). HYDRO-35 and TP-40 include data from 2,100 National Weather Service (NWS) rain gauges. Precipitation amounts for storms with 5 to 60 minute durations were recorded at 200 rain gauge stations with an average 60-year period of record. Hourly data have been recorded at approximately 1,900 rain gauges since the 1940s. The predicted rainfall amounts for a 24-hour duration rainfall event, based on the IDF curves, and are presented in Table 3.9.

| Table 3.9 Storm Event – 24-Hour Rainfall⁽¹⁾ Southwest WWCS Master Plan Update Manatee County | |
|--|---------------------------------|
| Storm Event Period | Rainfall Amount (inches) |
| 2-year | 5.76 |
| 5-year | 7.2 |
| 10-year | 8.52 |
| 25-year | 10.08 |
| Notes: (1) Based on 24-hour duration - FDOT IDF curve (2001) | |

Based on the rainfall amounts in Table 3.9 and the maximum daily rainfall amount presented in Table 3.8, no 2-year or greater storm events (based on a 24-hour storm duration) occurred from August 2013 to September 2013. Only total daily rainfall data was available for this time period and therefore it is unknown how the rainfall was distributed

throughout the day. If the total daily rainfall occurred in a shorter amount of time (less than 24 hours), it is possible that a 2-year or greater storm event did occur during a shorter period time.

Because the peak daily rainfall from August to September 2013 did not qualify as a 2-year storm event, the wet weather analysis at the SWWRF was expanded to include June and July 2013, to determine if any major storm events occurred within the entire summer of 2013. Evaluation of this expanded period showed that a 5-year, 24-hour storm event (7.75 inches) occurred in the Southwest Service Area on July 1, 2013.

In order to determine the impact of the various storm events, the amount of inflow was calculated by comparing the dry weather flow to the total and wet weather flows. The dry weather flow is the wastewater flow without influence from rain. Flow from dry weather days was averaged to determine the base, dry weather sanitary flow. A dry weather day is one that has no rainfall and was preceded by two days with a combined rainfall less than 0.02 inches. Flow data from September 26 to 30, 2013 was not included in the dry weather flow calculation, due to suspected ground saturation following the September 23-25, 2013 storm event.

Frequent rainfall events throughout the summer can cause the water table to be elevated for extended periods of time. In some cases the water table can be at or near ground level. During these times, the flow may not return to its base, dry weather flow immediately after a rainfall event. The dry weather flows in June and July 2013 appeared to be falsely elevated due to the saturated ground (extended I&I). Therefore, the dry weather flows calculated for September 2013, which appeared to be more representative of the true dry weather flow, were applied to the entire June to September 2013 data. It is assumed that the base sanitary flow would be approximately equal from June through September, with little to no impact from variations in seasonal population.

The dry weather flows were compared to the average flow during September 2013 and over the entire 2013 summer (June to September 2013) to determine the average inflow. It has also been compared to the 3-day storm event (September 23-25, 2013) and the maximum 24-hour storm event (within the June to September 2013 period) to determine maximum inflow. Due to extended infiltration caused by saturated ground conditions, there were some instances in which the maximum flow occurred up to two days after the rainfall event. Even though this maximum flow occurred after the rainfall event, it was still used to determine the maximum inflow. A summary of the dry and wet weather flows for the Southwest Service Area, including percent inflow where available, are presented in Table 3.10.

Table 3.10 suggests that a large, 24-hour storm event results in less inflow than a series of smaller storm events occurring over a few days. As shown in Table 3.10, the Southwest Service Area experiences, on average, moderate inflow (13 to 18 percent). The largest 24-hour storm event at the SWWRF (7.75 inches) was associated with 40 percent inflow compared with 59 percent inflow following the three-day September storm event

(6.85 inches total with a 24-hour maximum of 2.35 inches). Infiltration is also expected to contribute to increased flows during and after a storm event due to saturated ground conditions, especially in coastal areas or where the pipes are below the water table. However, infiltration is difficult to quantify and has not been evaluated for this report.

| Table 3.10 Summary of Wet and Dry Weather Flows Southwest WWCS Master Plan Update Manatee County | | | | | |
|---|---------------------------------------|-----------------------------|---|--|--|
| Location | | Summer⁽¹⁾ | September 2013⁽²⁾ | September Storm Event⁽³⁾ | 24-Hour Storm Event⁽⁴⁾ |
| SWWRF | Dry Weather Flow ⁽⁵⁾ (mgd) | 12.97 | | | |
| | Flow (mgd) | 14.99 | 15.81 | 31.66 | 21.45 ⁽⁶⁾ |
| | Inflow (mgd) | 2.02 | 2.83 | 18.69 | 8.84 |
| | Percent Inflow | 13% | 18% | 59% | 40% ⁽⁶⁾ |
| MLS 27-A | Dry Weather Flow ⁽⁷⁾ (mgd) | 2.58 | | | |
| | Flow (mgd) | NA | -(8) | 4.0 | NA |
| | Inflow (mgd) | NA | -(8) | 1.42 | NA |
| | Percent Inflow | NA | -(8) | 35% | NA |
| MLS 12-A | Dry Weather Flow ⁽⁷⁾ (mgd) | 0.76 | | | |
| | Flow (mgd) | NA | -(8) | 2.72 | NA |
| | Inflow (mgd) | NA | -(8) | 1.96 | NA |
| | Percent Inflow | NA | -(8) | 72% | NA |
| MLS 1-M | Dry Weather Flow ⁽⁷⁾ (mgd) | 1.74 | | | |
| | Flow (mgd) | NA | 2.24 | 3.98 | NA |
| | Inflow (mgd) | NA | 0.5 | 2.24 | NA |
| | Percent Inflow | NA | 22% | 56% | NA |

| Table 3.10 Summary of Wet and Dry Weather Flows Southwest WWCS Master Plan Update Manatee County | | | | | |
|--|---------------------------------------|-----------------------------|---|--|--|
| Location | | Summer⁽¹⁾ | September 2013⁽²⁾ | September Storm Event⁽³⁾ | 24-Hour Storm Event⁽⁴⁾ |
| MLS 1-D | Dry Weather Flow ⁽⁷⁾ (mgd) | 1.23 | | | |
| | Flow (mgd) | NA | -(8) | 2.38 | NA |
| | Inflow (mgd) | NA | -(8) | 1.15 | NA |
| | Percent Inflow | NA | 35% | 48% | NA |
| MLS 13-A | Dry Weather Flow ⁽⁷⁾ (mgd) | 2.98 | | | |
| | Flow (mgd) | NA | 3.31 | 4.21 | NA |
| | Inflow (mgd) | NA | 1.06 | 1.23 | NA |
| | Percent Inflow | NA | 10% | 29% | NA |
| Notes: | | | | | |
| (1) Average flow data from 6/1/13 to 9/30/13. Not used for calibration. | | | | | |
| (2) Average flow data from 9/1/13 to 9/30/13. Not used for calibration. | | | | | |
| (3) Maximum daily flow that occurred between 9/23/13 and 9/25/13. Used for calibration. | | | | | |
| (4) The largest 24-hour storm event occurred on 7/1/13 and totaled 7.75 inches; the maximum flow that occurred between 7/1/13 and 7/3/13 was used as the storm flow. | | | | | |
| (5) Based on dry weather flow calculated from September 2013 flow data. | | | | | |
| (6) The 5-year storm event at the SWWRF was followed by a smaller rain event totaling 2 inches over 24-hours, which elevated the flow to 22.52 mgd and led to an estimated 42% inflow. | | | | | |
| (7) Based on dry flow recorded during April 2015 for base model calibration. | | | | | |
| (8) Data considered inaccurate. Not used for model calibration or Master Planning purposes. | | | | | |

The hydrograph for the SWWRF for the period of June 1, 2013 through September 30, 2013 is shown in Figure 3.8. The inflow volume is represented by the area between the blue flow curve and the orange dry weather flow line on the hydrographs. The dry weather flow is the average dry weather flow calculated for September. Large peaks in flow occur concurrently with rainfall events or directly after the events. The hydrograph demonstrates that periods of consecutive rainfall lead to elevated flows that can last for a number of days following the rainfall event. Because of its impact on the system, the three-day September 2013 storm event has been used to calibrate the wet weather scenario and applied to future scenarios as described in subsequent chapters.

The I&I Study completed by Carollo in 2014 investigated lift stations within the North and Southwest Service Areas which contributed the most I&I. The MLSs in the Southwest Service Area with the highest percentage of inflow during the storm event, after data corrections based on SCADA and pump speed and pressure time series, were MLS 12-A at 72 percent, MLS 1-M at 56 percent, and MLS 1-D at 48 percent.

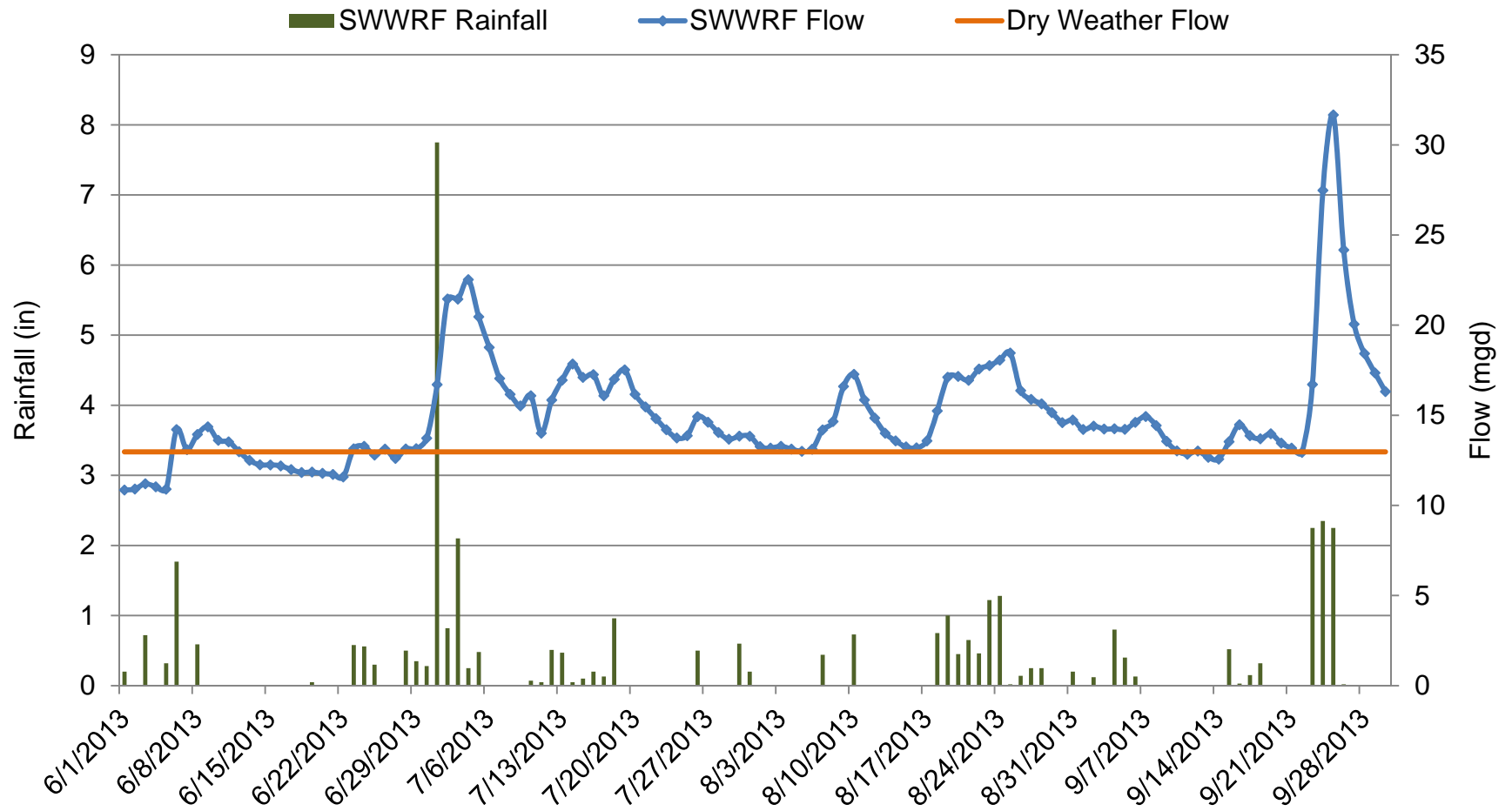

SWWRF HYDROGRAPH

FIGURE 3.8

MANATEE COUNTY
SOUTHWEST WWCS MASTER PLAN UPDATE

Although initial, incorrect historical data provided for MLS 12-A showed that this location was not prone to a very high inflow rate, comparisons of dry and wet weather flow trends calculated using pump speed and pressure time series at MLS 12-A confirmed that 12-A is highly impacted by inflow. The 2014 I&I Study identified a number of contributing lift stations within all of the above basins as well as the MLS 12-A and MLS 27-A basins themselves as candidates for future I&I inspection and repair work.

The wet weather scenarios in the hydraulic models account for the lift stations that are substantially impacted by inflow.

The County is in the process of inspecting and repairing gravity mains based on the recommendations from the 2014 I&I Study, which should reduce the future wet weather flows and maximum day peaking factors.

3.4 DIURNAL CURVES

Wastewater flow generation varies throughout the day based on customer water use patterns and industrial/commercial contributions. Because the hydraulic models are developed to model movement of wastewater flow throughout an extended period of time, diurnal curves are used to vary the wastewater generation at lift stations in the model.

Temporary flowmeters were installed throughout the County in order to record actual flow data that was used to calibrate the hydraulic models. This flow data was used to calibrate the model, as discussed in Chapter 4. The flow data was also used to develop diurnal curves for two MLSs in the Southwest Service Area: MLS 1-D (Figure 3.9) and MLS #5 (Figure 3.10 and Figure 3.11).

Overall, the diurnal curves show expected trends with the largest flow peaks occurring in the morning, typically between 6 am and 12 pm, and the evening, between 6 pm and 12 am. The lowest flows occur between approximately 12 am and 6 am. Representative data from two consecutive days were chosen to develop a typical diurnal curve, shown in Figure 3.12, which was input into the hydraulic model for all scenarios other than the calibration.

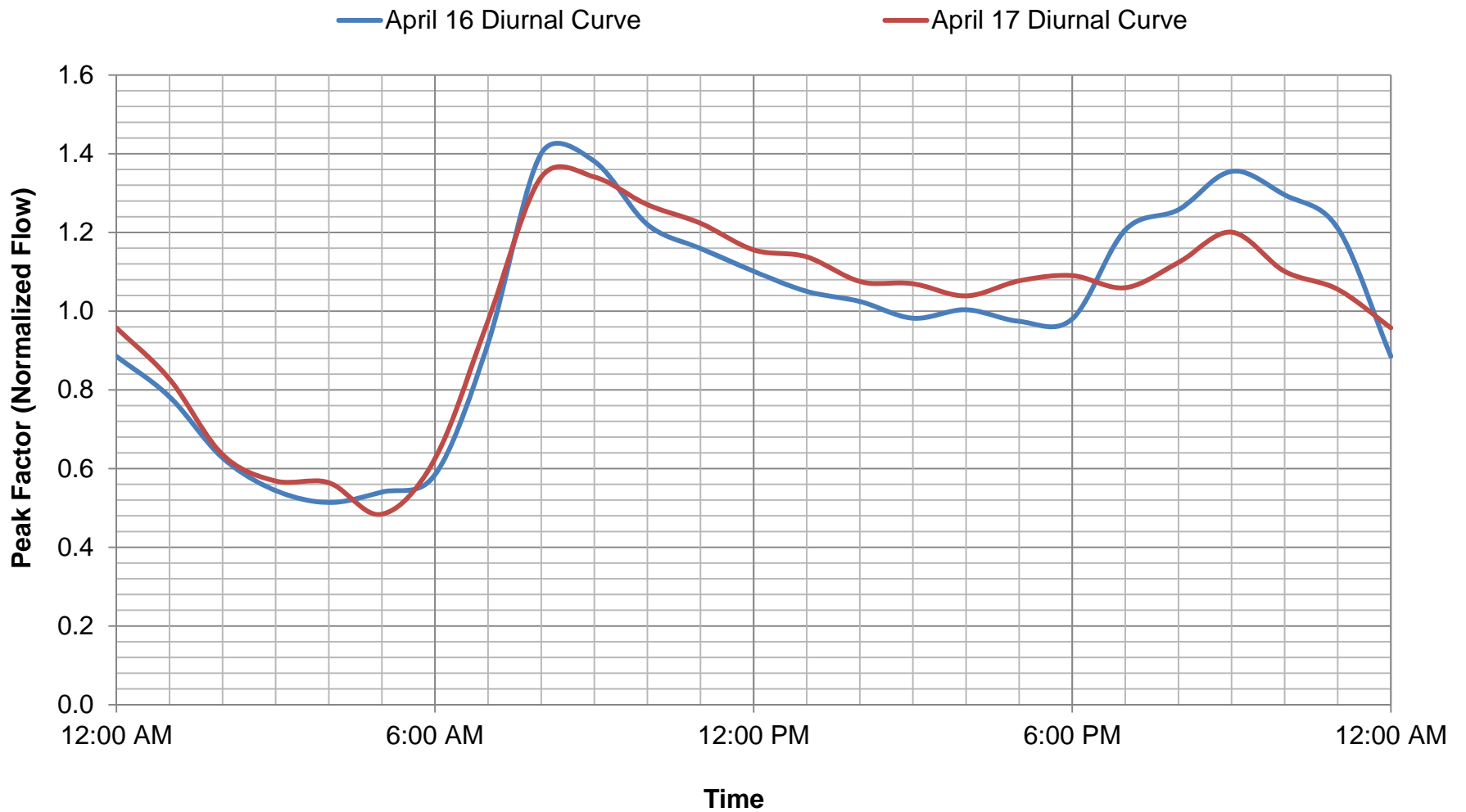

MLS 1-D DIURNAL CURVE

FIGURE 3.9

MANATEE COUNTY
SOUTHWEST WWCS MASTER PLAN UPDATE

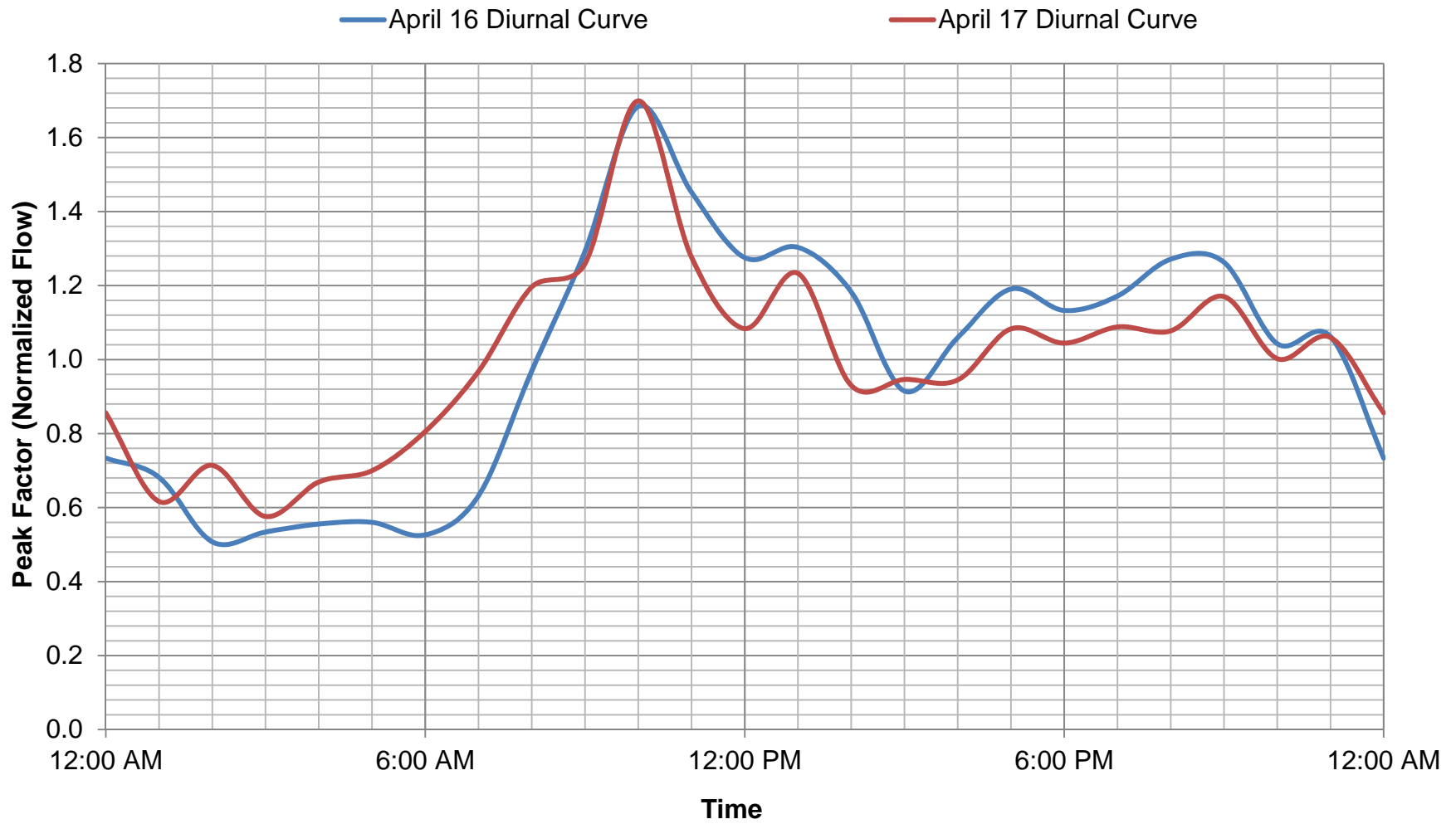

MLS #5 (MH 18814) DIURNAL CURVE

FIGURE 3.10

MANATEE COUNTY
SOUTHWEST WWCS MASTER PLAN UPDATE

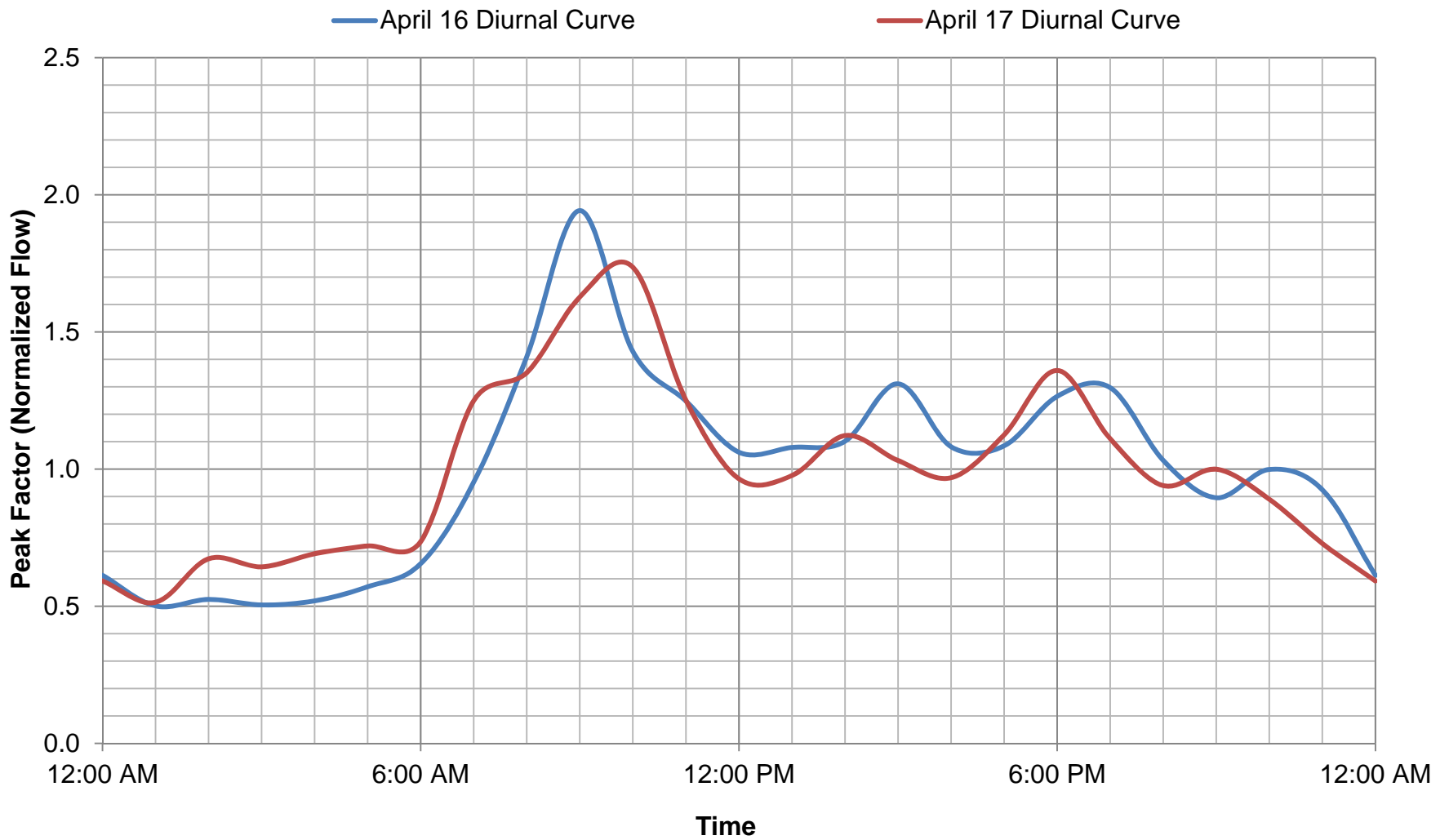

MLS #5 (MH 19462) DIURNAL CURVE

FIGURE 3.11

MANATEE COUNTY
SOUTHWEST WWCS MASTER PLAN UPDATE

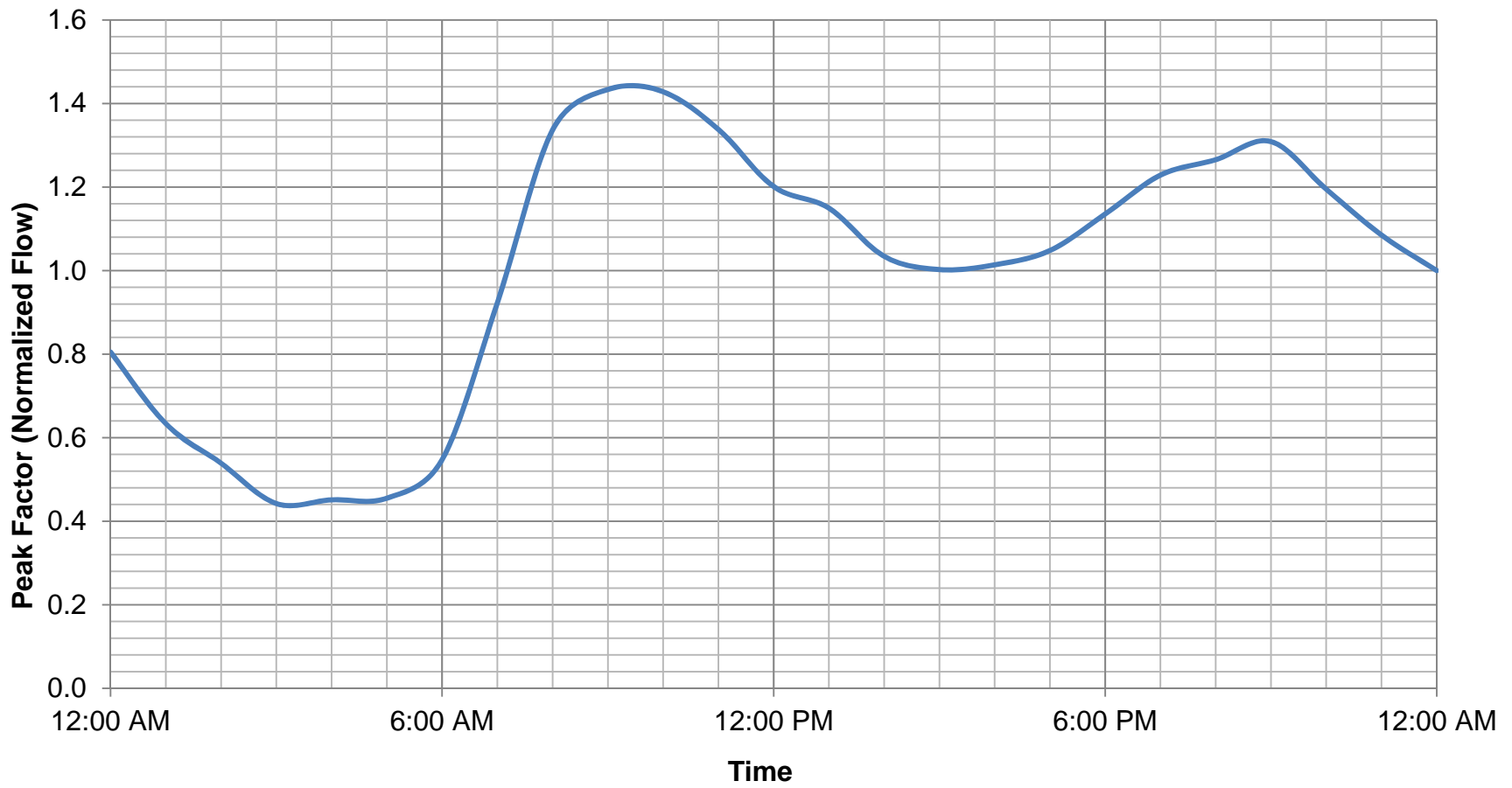

TYPICAL DIURNAL CURVE

FIGURE 3.12

MANATEE COUNTY
SOUTHWEST WWCS MASTER PLAN UPDATE

3.5 PROJECTED WASTEWATER FLOWS

Table 3.11 summarizes the projected annual average, maximum month, and maximum day wastewater flows for each planning period with and without the flows contributed by the Town of Longboat Key and the USF/airport area. The annual average flows have been developed using the per capita wastewater flow LOS value shown in Table 3.7. The projected maximum monthly flows have been calculated using a monthly peaking factor of 1.31, per County Policy 9.1.3.1. The actual maximum 10-year monthly peaking factor for the Southwest Service Area (1.30) is similar to this policy value. The USF/airport area is expected to contribute a total additional flow of 0.67 mgd. Approximately 0.13 mgd is expected by 2025 and 0.3 mgd is expected by 2035 (per County estimates).

Figure 3.13 illustrates the projected wastewater flows for the Southwest Service Area based on the LOS per capita value and 1.31 monthly peaking factor. It should be noted that the actual per capita flow is lower than the LOS value, which is also evident based on the historical data shown in Figure 3.13. Therefore, the projected annual average flows are not anticipated to reach the plant capacity until later than indicated in Figure 3.13. Further discussion of the SWWRF capacity and future expansions is provided in Chapter 6.

The historical 5-year maximum daily peaking factors were used to estimate future maximum daily flows. Although the September 2013 storm event was replicated to obtain wet weather flows in the future scenarios in the model, the projected flows using the peaking factors were also compared to the maximum flows generated in the model to confirm that the model generates flows that are comparable to the historical maximum day peaking factors. Note that simulated flows at the SWWRF include the flows from Longboat Key.

| Table 3.11 Projected Wastewater Flows – Southwest Service Area Southwest WWCS Master Plan Update Manatee County | | | | | | |
|--|--|--|--------------------------------------|---|--|--------------------------------------|
| Year | Southwest County Area Wastewater Flow (mgd)⁽¹⁾ | | | Total SWWRF Wastewater Flow, Including Longboat Key and USF/Airport Flows(mgd)⁽²⁾ | | |
| | Annual Average (LOS) | Maximum Month⁽³⁾ | Maximum Day⁽⁴⁾ | Annual Average (LOS) | Maximum Month⁽³⁾ | Maximum Day⁽⁴⁾ |
| Peaking Factor | 1 | 1.31 | 2.62 | 1 | 1.31 | 2.62 |
| 2014 | 12.48 | 14.58 | 22.07 | 14.42 | 18.90 | 37.79 |
| 2015 | 13.27 | 17.39 | 34.69 | 15.21 | 19.93 | 39.86 |
| 2020 | 13.82 | 18.11 | 36.13 | 15.76 | 20.65 | 41.30 |
| 2025 | 14.38 | 18.84 | 37.58 | 16.45 | 21.55 | 43.10 |
| 2030 | 14.93 | 19.56 | 39.01 | 17.00 | 22.27 | 44.53 |
| 2035 | 15.48 | 20.28 | 40.46 | 17.72 | 23.21 | 46.43 |
| Planned Development | 17.02 | 22.30 | 44.48 | 19.26 | 25.23 | 50.46 |
| Build-Out | 19.32 | 25.30 | 50.61 | 21.93 | 28.72 | 57.45 |

Notes:

(1) Based only on the estimated County TAZ populations presented in Table 3.3 and a future average flow per person of 115 gpcd. Does not include flow contributed by the Town of Longboat Key or the additional flow from the USF/airport area.

(2) Including the projected flow contributed by the Town of Longboat Key and the USF/Airport areas. The projected flow for the Town of Longboat Key is 1.94 mgd. Expected flows from the USF/Airport areas are estimated at 0.13 mgd at 2025, 0.3 mgd at 2035, and a total of 0.67 mgd at build-out. The peaking factors listed in this table were applied to the Longboat Key and USF/Airport flows to obtain total Maximum Month and Maximum Day flow projections.

(3) Based on monthly peaking factor of 1.31 per County Policy 9.1.3.1.

(4) Based on 5-year maximum day peaking factor (2.62) presented in Table 3.6.

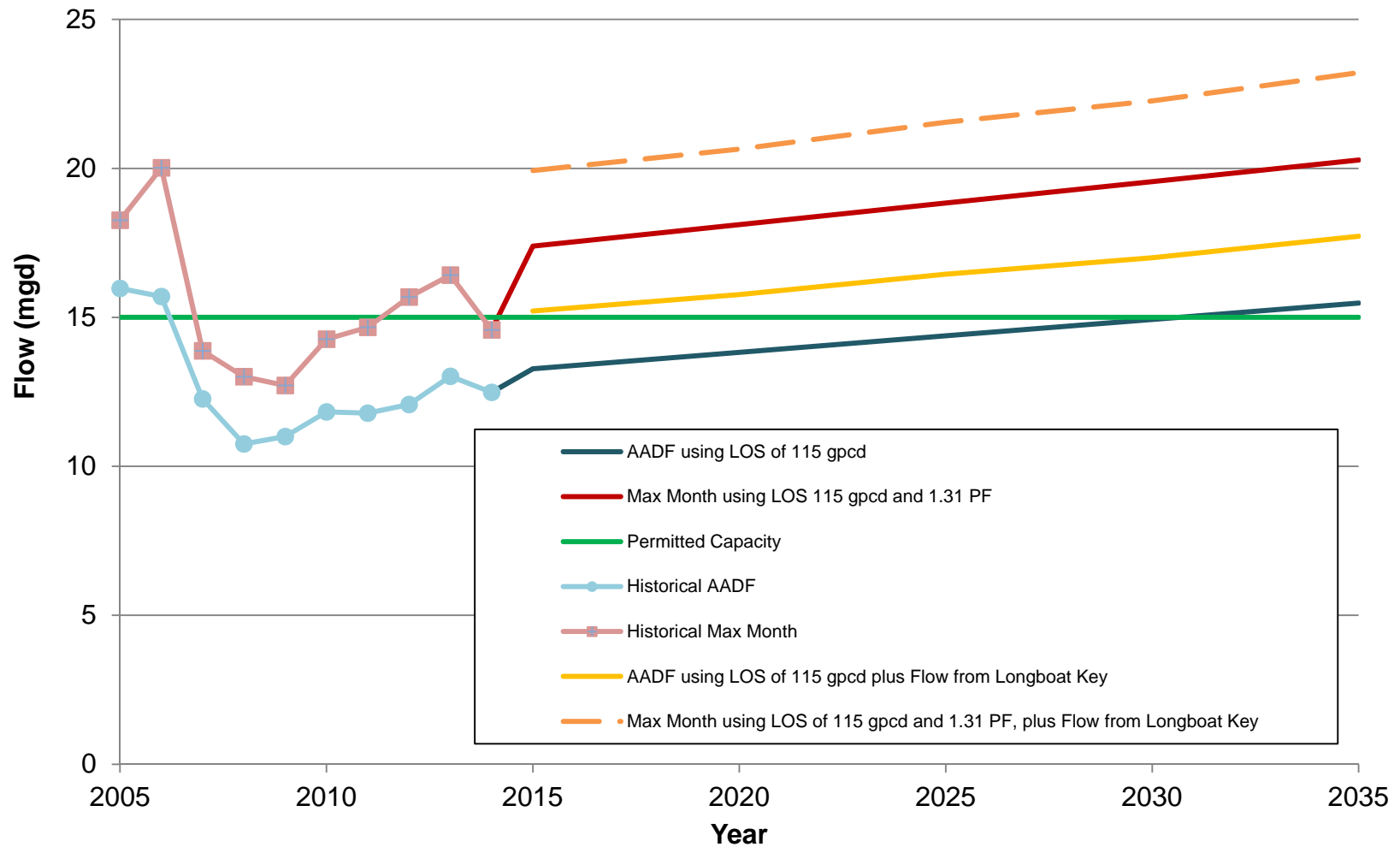

SOUTHWEST SERVICE AREA FLOW PROJECTIONS

FIGURE 3.13

MANATEE COUNTY
SOUTHWEST WWCS MASTER PLAN UPDATE



The treatment capacity of the SWWRF with respect to the projections shown in Table 3.11 and Figure 3.13 will be discussed in detail in Chapter 6.

3.6 PERFORMANCE CRITERIA

The purpose of this section is to define criteria, or standards of measurement, for evaluating the performance and design of the County's wastewater collection systems. Comparison of the systems' capabilities against these performance and design criteria provides the mechanism for identifying existing or future deficiencies and needs, and serves as a guide for capital improvement projects and budget planning. The performance criteria are based on the County's utility design criteria (excerpt provided in Appendix C), applicable regulations such as the Florida Administrative Code (FAC) and 10 State Standards, as well as accepted engineering standards.

The performance of existing force mains and pump stations will be based on the criteria described below. New infrastructure will also be sized to comply with the performance criteria.

3.6.1 System Reliability and Redundancy

Reliability of the County's wastewater collection system is provided by a combination of the following factors:

1. Wastewater collection, transfer pumping capability, and force main capacity to transport wastewater to the WRF.
2. Backup power supply for critical facilities.

3.6.2 Force Main Capacity

Force mains should have a minimum diameter of 4 inches and a velocity between 2 and 6 feet per second (fps). The minimum velocity, 2 fps, is required to provide scour velocity so that the solids deposited while the pumps are off will be transported when the pumps are operating. Hazen-William's roughness coefficients (c-factors) of 120 and 140 were used for existing metallic and plastic pipes, respectively, based on the model calibration discussed in Chapter 4. A c-factor of 120 was used for all future pipes based on the County's utility design criteria.

3.6.3 Gravity Sewer Design

The design velocity for a gravity pipeline should have a minimum velocity of 2 feet per second and a maximum velocity of 10 feet per second. The design limit depth is 80 percent of the pipe inside diameter. Minimum slopes are designed according to the 10 State Standards requirements. The minimum slopes for achieving a velocity of 2 feet per second are presented along with additional summary data in Table 3.12 at the end of this section.

3.6.4 Lift Stations

Multiple pumps are recommended at all lift stations. Equal size pumps are needed when only two pumps are provided. Capacities of pumps will be evaluated to provide a lift station capability with the largest pump out of service to handle the peak hour design flow rates per 10 State Standards requirements.

3.6.4.1 Normal Operation

Lift station wet well sizing takes into consideration the fill time, based on average flow, and the minimum pump cycle time. The minimum volume should equal four times the pump capacity in gpm (based on County utility design criteria) and should provide a retention period not to exceed 30 minutes of average daily design flow (per 10 State Standards). Wet wells should have a minimum diameter of 6 feet unless a smaller diameter is approved for a grinder pump application. When selecting the minimum cycle time, the pump manufacturer's duty cycle recommendations shall be utilized. Starting and stopping more than five times an hour for any one pump is not recommended based on the County utility design criteria.

3.6.4.2 Emergency Operation

The objective of emergency operation is to protect public health by preventing sewer back-ups and subsequent discharge into streets, water bodies, and public or private property. The most common emergency would be a power outage. The County has onsite backup generators at each of the master lift stations and various area lift stations as well as portable generators that can be used throughout each of the three service area lift stations.

3.6.5 Wastewater Performance Criteria Summary

Table 3.12 summarizes the performance and design criteria used to evaluate the wastewater collection system.

| Table 3.12 Performance Criteria Summary Southwest WWCS Master Plan Update Manatee County | |
|--|--|
| Description | Criteria |
| Force Main Criteria: Diameter Velocity C-factor | <p>≥ 4 inches</p> <p>≥ 2 fps and < 6 fps</p> <p>140 (existing plastic pipes)</p> <p>120 (existing metallic pipes)</p> <p>120 (future pipes)</p> |
| Gravity Pipes Manning's n Flow Depth (d/D) Velocity Diameter (inches) 8 10 12 14 15 16 18 21 24 27 30 36 | <p>0.013</p> <p>0.80</p> <p>≥ 2 fps and < 10 fps</p> <p>Minimum Slope (ft/100 ft)</p> <p>0.4</p> <p>0.28</p> <p>0.22</p> <p>0.17</p> <p>0.15</p> <p>0.14</p> <p>0.12</p> <p>0.10</p> <p>0.08</p> <p>0.067</p> <p>0.058</p> <p>0.046</p> |
| Lift Station Criteria: Firm Capacity Wet Well Volume Wet Well Diameter Pump Start/Stop | <p>≥ peak hourly flow with largest pump out of service</p> <p>4 times the pump capacity in gpm</p> <p>≥ 6 feet</p> <p>≤5 per hour (duplex stations)</p> |

3.7 PLANNING FRAMEWORK SUMMARY

The planning information, data, and performance criteria relevant for updating the hydraulic models and developing the Southwest WWCS Master Plan are presented within this chapter. Population projections provided by the County Building and Development Services Department were revised to exclude the population served by septic tanks. The 2015 to 2035 scenarios include the population served by the County's wastewater system in the Southwest areas of the County including Anna Maria Island, and a patterned load to simulate flow contributed by the Town of Longboat Key and USF/Airport areas. The build-out scenario assumes that areas currently served by septic tanks will be connected to the County's wastewater system. The planned development scenario, an intermediate between the 2035 and build-out scenarios, includes the maximum population within the planned

developments. The planned development scenario does not include the septic population or growth of undeveloped parcels outside of the planned developments.

Historical wastewater flows were evaluated for the Southwest Service Area. Monthly flow data from the last 10 years were used to calculate maximum month peaking factors, and daily flow data from the last five years were used to calculate maximum day peaking factors. Historical flow data was used to calculate the average daily flow per person in each service area. The current LOS values were used in projecting future wastewater flows. A summary of the peaking factors and LOS values is provided in Table 3.13 located at the end of this section.

Wet weather flows and inflow contributions were evaluated for the Southwest Service Area using rainfall and flow data collected between June 1, 2013 and September 30, 2013, and time series of pump speed and pressure at certain master lift stations. Available flow data was evaluated for the SWWRF and five MLSs: 27-A (RTU #138), 12-A (RTU #139), 1-M (RTU #203), 1-D (RTU #237), and 13-A (RTU #408). The percent inflow for the month of September and for the three-day storm event that occurred from September 23 to September 25 was estimated using calculated dry weather flows. The Southwest Service Area experiences moderate to high inflow. Table 3.13 includes the percent inflow for locations where inflow data was available during the three-day storm event from September 23-25, 2013.

Based on the FDOT 24-hour rainfall intensity criteria, a 5-year storm occurred in July 2013. Analysis of the percent inflow indicate that successive rainfall events with low to medium intensity, such as the three-day storm that occurred in late September 2013, appear to have a greater impact on inflow compared with an isolated 24-hour storm event with higher intensity, even when the total rainfall amounts are similar.

Flow projections for 2015 through build-out have been developed for each service area based on population projections provided by the County, LOS values, historical maximum day peaking factors, and maximum month peaking factors based on County Policy 9.1.3.1. Flow projections and peaking factors are presented in Table 3.13.

Performance and design criteria were reviewed for the County's wastewater collection system including force mains, lift station wet wells, and gravity mains. Performance criteria used in evaluating future scenarios in the model are summarized in Table 3.13.

The data included in Table 3.13 were used to project future flows, calibrate the hydraulic model, and evaluate the existing and future collection system scenarios.

| Table 3.13 Summary of Planning and Performance Criteria Southwest WWCS Master Plan Update Manatee County | | | | |
|---|---|---|---|---|
| Wastewater Population and Flow Projections⁽¹⁾ | | | | |
| | Population Projections⁽²⁾ | Annual Average Level of Service Flow (mgd) | Max Month Flow (mgd)⁽³⁾ | Max Day Flow (mgd)⁽⁴⁾ |
| LOS (gpcd) | 115 | | | |
| Peaking Factor | - | 1 | 1.31 | 2.62 |
| 2015 | 115,425 | 14.42 | 18.90 | 37.79 |
| 2020 | 120,213 | 15.21 | 19.93 | 39.86 |
| 2025 | 125,044 | 15.76 | 20.65 | 41.30 |
| 2030 | 129,807 | 16.45 | 21.55 | 43.10 |
| 2035 | 134,615 | 17.00 | 22.27 | 44.53 |
| Planned Development | 148,003 | 17.72 | 23.21 | 46.43 |
| Build-Out | 167,969 | 19.26 | 25.23 | 50.46 |
| Wet Weather and Storm Event Flows | | | | |
| Location | | 3-Day Storm⁽⁵⁾ | 24-Hour Storm⁽⁶⁾ | |
| SWWRF | Dry Weather Flow ⁽⁷⁾ | 12.97 | | |
| | Total Rainfall (Maximum Daily Rainfall) (inches) ⁽⁸⁾ | 6.85 (2.35) | 7.75 | |
| | Flow (mgd) | 31.66 | 21.45 | |
| | Inflow (mgd) ⁽⁹⁾ | 18.69 | 8.84 | |
| | Percent Inflow ⁽¹⁰⁾ | 59% | 40% | |
| MLS 27-A (RTU #138) | Dry Weather Flow ⁽⁷⁾ | 2.58 | | |
| | Flow (mgd) | 4.0 | NA | |
| | Inflow (mgd) ⁽⁹⁾ | 1.42 | NA | |
| | Percent Inflow ⁽¹⁰⁾ | 35% | NA | |
| MLS 12-A (RTU #139) | Dry Weather Flow ⁽⁷⁾ | 0.76 | | |
| | Flow (mgd) | 2.72 | NA | |
| | Inflow (mgd) ⁽⁹⁾ | 1.96 | NA | |
| | Percent Inflow ⁽¹⁰⁾ | 72% | NA | |

| Table 3.13 Summary of Planning and Performance Criteria Southwest WWCS Master Plan Update Manatee County | | | |
|---|---------------------------------|--|----|
| MLS 1-M (RTU #203) | Dry Weather Flow ⁽⁷⁾ | 1.74 | |
| | Flow (mgd) | 3.98 | NA |
| | Inflow (mgd) ⁽⁹⁾ | 2.24 | NA |
| | Percent Inflow ⁽¹⁰⁾ | 56% | NA |
| MLS 1-D (RTU #237) | Dry Weather Flow ⁽⁷⁾ | 1.23 | |
| | Flow (mgd) | 2.38 | NA |
| | Inflow (mgd) ⁽⁹⁾ | 1.15 | NA |
| | Percent Inflow ⁽¹⁰⁾ | 48% | NA |
| MLS 13-A (RTU #408) | Dry Weather Flow ⁽⁷⁾ | 2.98 | |
| | Flow (mgd) | 4.21 | NA |
| | Inflow (mgd) ⁽⁹⁾ | 1.23 | NA |
| | Percent Inflow ⁽¹⁰⁾ | 29% | NA |
| Performance Criteria | | | |
| Description | | Criteria | |
| Force Main Criteria: Diameter Velocity C-factor | | ≥ 4 inches ≥ 2 fps and < 6 fps 140 (existing plastic pipes) 120 (existing metallic pipes) 120 (future pipes) | |
| Gravity Pipes Manning's n Flow Depth (d/D) Velocity Diameter (inches) | | 0.013 0.80 ≥ 2 fps and < 10 fps Minimum Slope (ft/100 ft) | |
| 8 | | 0.4 | |
| 10 | | 0.28 | |
| 12 | | 0.22 | |
| 14 | | 0.17 | |
| 15 | | 0.15 | |
| 16 | | 0.14 | |
| 18 | | 0.12 | |
| 21 | | 0.10 | |
| 24 | | 0.08 | |
| 27 | | 0.067 | |
| 30 | | 0.058 | |
| 36 | | 0.046 | |

**Table 3.13 Summary of Planning and Performance Criteria
Southwest WWCS Master Plan Update
Manatee County**

| | |
|--|--|
| <p>Lift Station Criteria:</p> <p>Firm Capacity</p> <p>Wet Well Volume</p> <p>Wet Well Diameter</p> <p>Pump Start/Stop</p> | <p>≥ peak hourly flow with largest pump out of service</p> <p>4 times the pump capacity in gpm</p> <p>≥ 6 feet</p> <p>≤5 per hour per pump (duplex stations)</p> |
| <p><u>Notes:</u></p> <p>(1) Includes the projected flow contributed by the Town of Longboat Key and the USF/Airport areas. The projected flow for Longboat Key is 1.94 mgd. Expected flows from the USF/Airport areas are estimated at 0.13 mgd at 2025, 0.3 mgd at 2035, and a total of 0.67 mgd at build-out. The peaking factors listed in this table were applied to the Longboat Key and USF/Airport flows to obtain total Maximum Month and Maximum Day flow projections.</p> <p>(2) Parcels served by septic tanks are not included in the 2015 through planned development scenario populations. Build-out projections include population currently served by septic tanks assuming these will be converted to the County's collection system.</p> <p>(3) Based on the maximum monthly peaking factor of 1.31 per County Policy 9.1.3.1.</p> <p>(4) Based on the actual 5-year maximum daily peaking factor.</p> <p>(5) 3-day storm occurred from September 23 to 25, 2013.</p> <p>(6) 24-hour storm event occurred on July 1, 2013 based on rainfall data from the SWWRF.</p> <p>(7) Based on dry weather flows calculated from September 2013 flow data.</p> <p>(8) Maximum 24-hour rainfall that occurred within the 3-day storm included in parentheses.</p> <p>(9) Inflow calculated by subtracting the average dry weather flow from the maximum flow occurring within the storm event.</p> <p>(10) Percent inflow calculated by comparing the average dry weather flow with the maximum day flow during each storm event.</p> | |

WASTEWATER MODEL DEVELOPMENT AND CALIBRATION

4.1 INTRODUCTION

A wastewater collection system hydraulic model requires large amounts of infrastructure, wastewater flow, and operational data. The quality of the information used in the modeling and planning work can have substantial consequences on model results. If the data is not accurate, the model may predict a result that is too conservative and therefore costly, or not sufficiently conservative which therefore may compromise the quality of service. All of the information that would ideally be used for a model is usually not available, and sometimes the data is not as precise or accurate as desired. Therefore, it is important to have a clear understanding of what is available and the assumptions that are made to compensate for missing information so model results can be interpreted appropriately.

This chapter describes the update and calibration of the County's Southwest Service Area Wastewater Collection System (WWCS) hydraulic model. The remainder of Chapter 4 is divided into the following sections:

Section 4.2 – Model Update: Provides an overview of the previous hydraulic model, types of infrastructure included in the model, and the model update and review process.

Section 4.3 – Model Development: Summarizes the scenarios and alternatives included in the model and the types of simulations used for each planning period.

Section 4.4 – Model Calibration: Provides a summary of the calibration standards and expected accuracy, dry and wet weather calibration methodology, and calibration results.

Section 4.5 – Calibration Summary: Summarizes the calibration results and provides recommendations for future modeling efforts.

4.2 MODEL UPDATE

A WWCS model is a simplified representation of the real collection system. WWCS models can assess the conveyance capacity of a collection system and be used to create "what if" scenarios to evaluate impacts of future developments and land use changes. As part of this WWCS Master Plan Update project, Carollo reviewed the previous hydraulic model and updated/expanded upon certain aspects of the model. This section summarizes the hydraulic model update and review process.

4.2.1 Existing Hydraulic Model

The County's previous model was built during the 2009 update of the master plan using the County's GIS database. The model was built using the Bentley SewerCAD hydraulic modeling software. It should be noted that the model has been updated using the

SewerGEMS software, also developed by Bentley. In addition to all the capabilities of SewerCAD, SewerGEMS incorporates dynamic equations for gravity systems and stormwater systems which involve surface water hydrology. Since Inflow & Infiltration (I&I) is an important component of any WWCS in Florida, especially in low-lying coastal areas with older infrastructure, SewerGEMS is considered more applicable to the County's collection system. SewerGEMS will produce more appropriate simulations and realistic results than SewerCAD. SewerGEMS also provides a dynamic solution appropriate for existing capacity analysis, detention, looped systems, and diversions. All model simulations were completed using SewerGEMS v8i.

An extensive comparison of the existing model infrastructure, the most recent GIS database, and spreadsheet data provided by the County (Appendix D) was conducted. Discrepancies between the model and GIS were reviewed with the County and the existing model was updated based on comments received by County staff. Additional information updated in the model includes:

- New diurnal wastewater flows patterns were calculated and assigned (as discussed in Chapter 3 and shown in Figures 3.9 through 3.12).
- New sanitary loads were calculated and assigned (original sanitary loads and "forced" flows were removed).
- Wet weather loads were assigned based on a historic storm event (discussed further in Section 4.4.4).
- Pump curves were reviewed and updated.
- Lift station pump controls were reviewed and updated.

4.2.2 Model Infrastructure

The physical components in the model are represented in a mathematical format so the modeling software can calculate the hydraulics within the network. To do this, all physical infrastructure is represented as either point entities (nodes) or line entities (links). Nodes include pressure junctions, manholes, wet wells, and pumps. Force mains and gravity mains are represented as links. Figure 4.1 shows the physical infrastructure included in the base, wet weather calibration, 2015 level of service (LOS), and 2015 Wet Weather scenarios of the Southwest model. The data input into the model for the wet wells and pumps (flex tables) are shown in Appendix E.

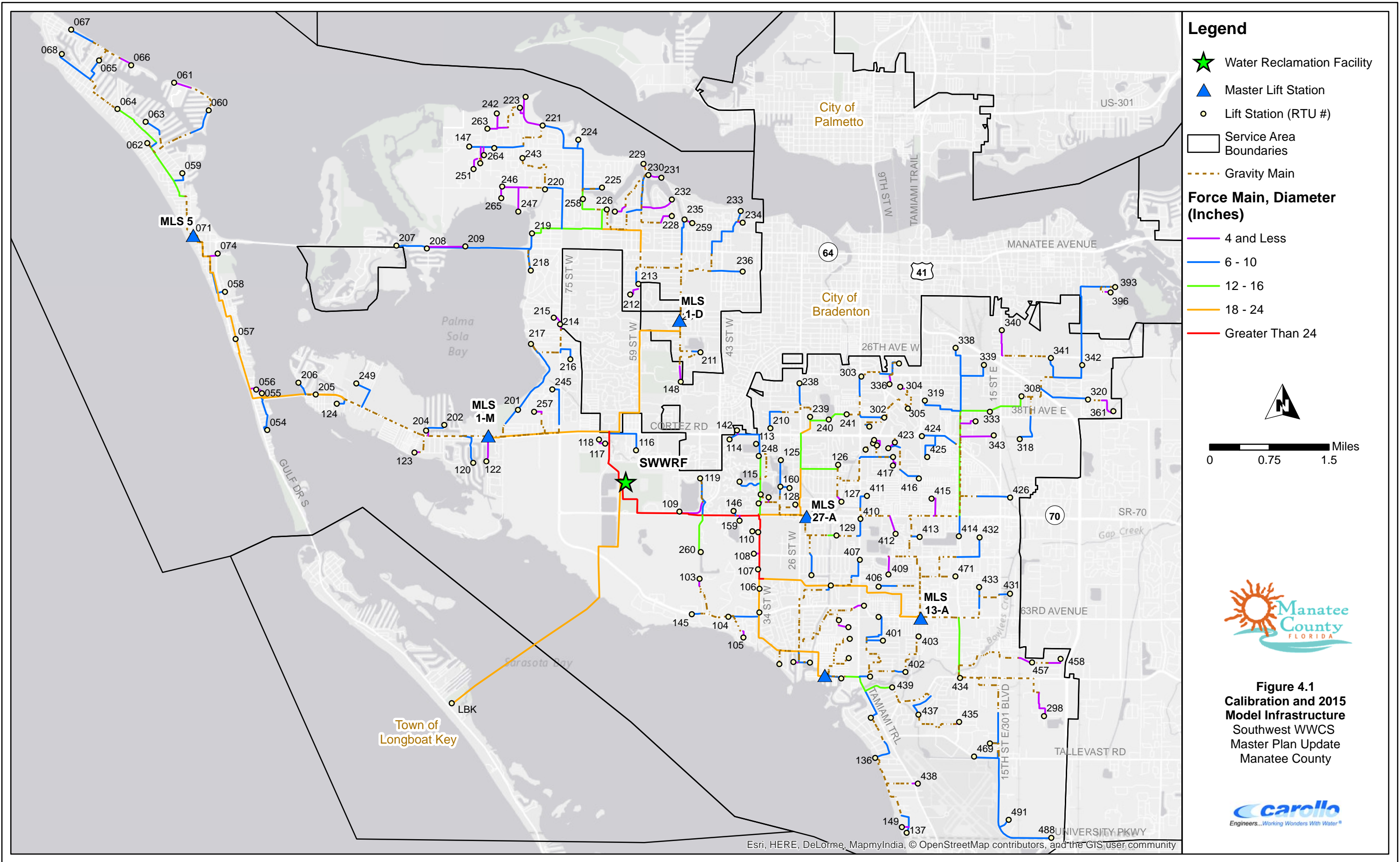

- Legend**
- ★ Water Reclamation Facility
 - ▲ Master Lift Station
 - Lift Station (RTU #)

Service Area Boundaries

--- Gravity Main

Force Main, Diameter (Inches)

- 4 and Less
- 6 - 10
- 12 - 16
- 18 - 24
- Greater Than 24

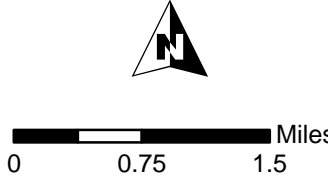

Figure 4.1
Calibration and 2015
Model Infrastructure
 Southwest WWCs
 Master Plan Update
 Manatee County



The following provides a brief overview of the major elements of the hydraulic model and the required input parameters associated with each:

- **Manholes:** Sewer manholes that connect multiple gravity mains or connect force mains to gravity mains. Required inputs include diameter, sanitary loads, and ground, rim, and invert elevations.
- **Conduits:** Gravity sewers are represented as conduits in the model. Input parameters include length, diameter, material, friction factor (Manning's n), and invert elevations.
- **Pressure Pipes:** Force mains are represented as pressure pipes in the model. Required input includes length, diameter, material, friction factor (Hazen Williams C), and invert elevations.
- **Pressure Junctions:** Pressure junctions are used to connect multiple force main segments. They are needed when an individual pipe changes in diameter or material and can be used to represent a pressure gauge. Required input includes ground and node elevations. Node elevations correspond to inverts of the contiguous pressure pipes.
- **Wet Wells:** Required input parameters for wet wells include cross section type (circular or variable area), wet well diameter or cross sectional area, and wet well base (bottom), ground (top), maximum (high water level), and minimum (low water level) elevations.
- **Pumps:** Input parameters for pumps include pump definition type (single point, variable speed, multiple point, etc.), pump capacity/head information, operational controls (on/off set points), ground elevation, and pump invert elevation.
- **Outfalls:** Outfalls represent where the flow leaves the system (i.e. treatment or storage facility). Required input parameters include boundary conditions (free outfall, normal, user defined tailwater, etc.), ground elevation, and invert elevation.
- **Patterns:** Diurnal patterns are used to simulate the variation in flow throughout the day. Patterns can be established for any time period, including multi-day patterns (48-hour, 72-hour, etc.).
- **Catchments:** Sewer sheds, or lift station tributary areas, are represented in the model as catchments, which are used in the wet weather scenarios. Required input parameters include user defined area and outflow element (typically a manhole). The area of a catchment affects the amount of I&I flow to a particular lift station. A smaller catchment will have less I&I than a larger catchment.
- **Flows:** The following are two types of wastewater flow sources that can be applied at individual model junctions (manholes, wet wells, and pressure junctions):

- Loads. Loads simulate base sanitary wastewater flows and may be used to represent dry weather flow or average flow. The base sanitary loads are multiplied by the diurnal patterns that vary the flow throughout the simulation.
- Stormwater Flows. Rainfall Derived Infiltration and Inflow (RDII) is applied in the model by assigning a unit hydrograph and a corresponding catchment (tributary area) to a given loading manhole. The unit hydrographs consist of several parameters that are used to adjust the volume of RDII that enters the system at a given location. These parameters are adjusted during the wet weather calibration process, described more in Section 4.4.4.

The following sections describe the physical components included in the Southwest model, the resources used to update the existing model, and assumptions made where actual information was not available.

4.2.2.1 Manholes and Gravity Mains

Although most of the County's pipelines are gravity mains used to collect flows in close proximity to lift stations, the majority of wastewater transmission needs are pressurized force mains due to the lack of elevation difference. Only those gravity mains needed to connect the pressurized network (those that receive flow from a force main) were included in the model, regardless of the gravity main's size. The gravity mains included in the 2015 scenario are shown in Figure 4.1.

All sanitary loads associated with existing or future populations were applied at a manhole(s) directly upstream of each wet well, referred to as the loading manhole(s). Every lift station also has an upstream gravity main(s), connecting the loading manhole(s) to the wet well; however, only the major or connecting gravity mains were evaluated for performance.

Manhole and gravity main data was provided in GIS shapefile format (up to date as of January 29, 2015). Missing manholes were either imported from GIS or drawn directly into the model and missing gravity mains were imported directly from GIS. Several assumptions were applied to the manholes and gravity mains:

- As needed, manhole invert elevations were adjusted to achieve a positive slope in the gravity mains or to smooth out the slope along a series of gravity segments where there were extreme differences in slope.
- Calculation instabilities and numerical issues within the model arise when there are short pipe segments following long pipe segments. This is because flow routing is a dynamic process that sometimes is truncated by the short length of a pipe (like a wave propagating in an enclosed container). In some cases, manholes were removed from the model and the gravity main reconnected to the next manhole (overall length of pipe unaffected) to reduce routing errors.

- Gravity mains that connect the loading manholes to the wet well were given a user defined length of at least 50 feet to prevent calculation issues in the model.
- For future and build-out lift stations, or where information was not available for an existing lift station, the gravity main connecting the loading manhole to the wet well was assumed to have a length of 100 feet, and a slope of 0.02 feet/feet.

4.2.2.2 Lift Stations

There are a total of 211 County-owned and 108 privately-owned lift stations in the Southwest Service Area, although only 194 existing lift stations were included in the base scenario (Figure 4.1). This includes no private lift stations. In order to simplify the model, some smaller County-owned lift stations and all private lift stations were excluded from the model. Flow from the excluded County-owned lift stations was assigned to the downstream lift stations to which they discharge. Flow from private lift stations was included with a nearby County-owned lift station.

Lift stations are represented in the model by a wet well, a combination of pumps, and a discharge node. Figure 4.2 shows the typical model layout of a lift station and the naming convention of the physical infrastructure in the model. The County's three-digit RTU number is used to identify County-owned lift stations and the Utility Work Operations on the Web (UWOW) number is used to identify private lift stations. All future components have been assigned a unique number, which is used in place of the RTU number: FXXX for future infrastructure installed from 2020 through 2035 and BO-X for infrastructure installed after 2035 (build-out). A single pump configuration, also shown in Figure 4.2, was used for future lift stations where an actual pump curve was not available.

The following data sources (included in Appendix D), provided by the County, were used to update the existing lift station infrastructure:

- Pump characteristic curves and flow-depth curves for VFD pumps (the latter derived from pump operation time series)
- County "Lift Station Flow Calculation Worksheets," which showed the current pump on/off depths, measured from the top of the wet well
- County "LSInfo_2015" (Lift Station spreadsheet), which provided wet well base and top elevations, diameter, influent line size and elevation, and force main length, diameter, material, and termination location. Pump model, pump rated capacity, impeller diameter, horse power, and discharge size was also provided.
- Collection system flow chart

Existing Lift Station

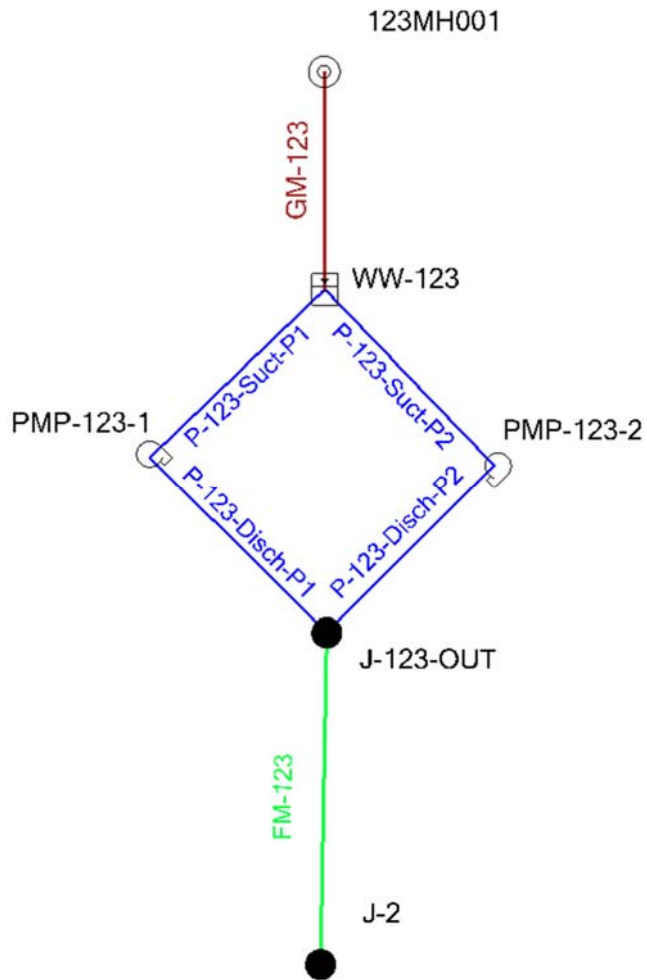

Future/Build-Out Lift Station

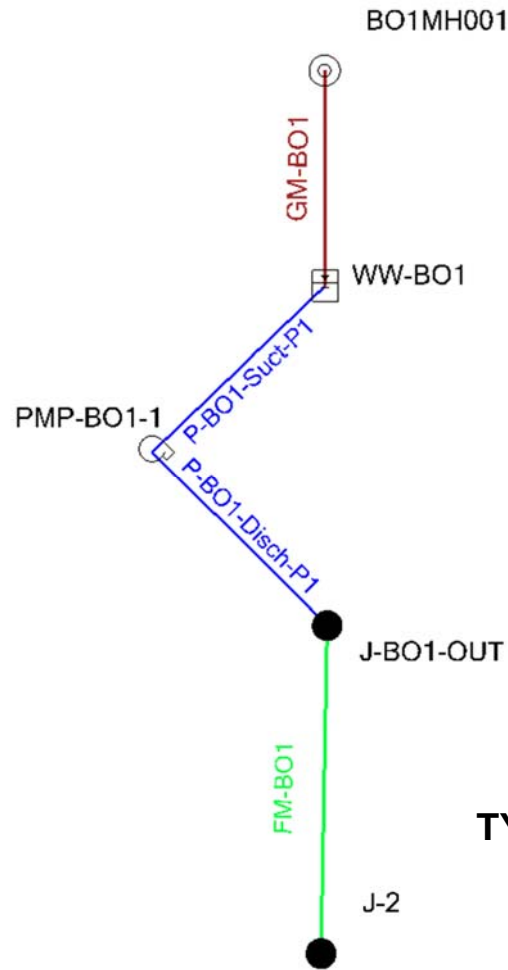

**TYPICAL LIFT STATION
CONFIGURATION**

FIGURE 4.2

MANATEE COUNTY
SOUTHWEST WWCS MASTER PLAN UPDATE

A multiple point type pump definition (Type 3) was used for all existing pumps. Pump curves were not available for Lift Stations 25-D and Manatee Woods (RTU 258 and RTU 319, respectively). For these, a pump definition based on the design point provided in the LSInfo 2015 spreadsheet (rated head and flow rate) was used. Pump curves can be easily updated in the model as the information becomes available. For future and build-out lift stations, the multiple point definition was used if the pump curve was available, otherwise a single point (1 Point GVF) pump definition was used. Wet well initial elevations were set at halfway between the pump on and off elevations, although this is one parameter that may have been changed throughout the calibration process.

Where information was not available, the following assumptions were made for all lift stations (existing, future, and build-out). It should be noted that the following assumptions were used for modeling purposes only and do not replace design standards:

- Top of the wet well is at ground elevation.
- Pump invert is 12 inches above the base of the wet well.
- Wet well depth is 21 feet.
- Pump off elevation is set to the pump invert elevation.
- Lead pump on elevation is 3.2 feet above the pump off elevation.
- Lag pump on elevation is 12 inches above the lead pump on elevation.
- Design points for future or build-out pumps (if pump curves were not available) were calculated based on future population (with some exceptions), LOS unit load generation factors (gpcd), head loss through the future pipe, and the pressure in the downstream force main. In some cases in the Southwest model, the assigned pump operating flow is higher than required based on population calculations. Instead, it was designed as the minimum acceptable such that the diameter in the discharging force main could be kept at a minimum of 4-inch per County request.

4.2.2.3 Master Lift Stations

There are six master lift stations in the Southwest Service Area (1-M, 1-D, 12-A, 13-A, 27-A, and #5), shown in Figure 4.1. Lift Station #5, although considered a MLS for being a major repump station, uses 1-M as an intermediary to convey flows to the SWWRF.

Each of the MLSs in the Southwest Service Area are operated by variable speed drive (VFD) pumps. VFD pumps were simulated using a flow-depth curve (Variable Speed, Type 4 pump definition), rather than the multiple point pump curves. SCADA data, provided by the County, including wet well level, pump flow rate, pump speed, and discharge pressure, was used to develop actual flow-depth curves to model the VFD pumps. For future scenarios, the flow-depth curves were modified to include the maximum pump flow rate and maximum wet well depth, allowing for a full range of pumping capacity.

Wet well elevations and pump invert elevations were updated based on record drawings provided by the County.

4.2.2.4 Force Mains

The force mains included in the 2015 scenario are shown in Figure 4.1. Missing force mains were imported from GIS. Pressure junctions along force mains were set to equal four feet below ground elevation, unless record drawings with actual elevations were provided or pressure calibration results indicated an elevation difference.

The placement of future force mains was aligned with existing roadways or future thoroughfares (provided by the County as a GIS shapefile), when possible. This will allow pipeline construction to occur within road right-of-way and utility easements when possible. The exact alignment of each force main and location of each lift station should be evaluated as actual development occurs. Slight changes in force main alignment should not impact model results or master planning recommendations.

The following assumptions were made when updating the existing force mains:

- A Hazen-Williams C factor of 140 was used for all plastic pipes (PVC and HDPE) and 120 was used for all metallic pipes.
- The nominal pipe diameter was used.
- Short force main segments were removed or the user-defined length was adjusted (overall pipe length remained unchanged) to prevent routing errors and instabilities, which can occur when short pipe segments are connected to long pipe segments.

4.2.2.5 Water Reclamation Facility

In the hydraulic model, flow is ultimately directed (or discharged) to what the model calls an outfall. An outfall may represent a treatment plant, a reservoir, or an emergency connection to another system. For the Southwest Service Area, there is only one outfall: the SWWRF. The SWWRF has a current permitted capacity of 15 million gallons per day (mgd) based on 3-month annual average daily flow (3MADF). Flow is transferred to the plant by one of two main force mains that transmit wastewater from inland served areas and Anna Maria Island; and one force main coming from the Town of Longboat Key. All three force mains converge into a single 42-inch pipe that discharges to the headworks influent channel. The outfall elevation used in the model (35.00 feet) was taken from record drawings of the headworks building.

4.2.2.6 Elevations

As the elevations in the previous model and GIS shapefiles were said to be unreliable, USGS topographic layers in GIS were used to re-assign ground elevations to all nodes (manholes, wet wells, and pressure junctions). It is important to note that the locations for infrastructure in the County shapefiles are not exact. Therefore, the elevations assigned to

them may not be the actual elevation. As provided, for a few locations, elevations from record drawings were used.

4.2.3 Model Review and Diagnostic Checks

The modeling software is capable of performing a number of diagnostic checks to identify errors in the data. The model review process included the following:

- Running queries to identify missing attributes, force mains not connected to the network, duplicate pipes, and pipes connected to more than one outfall.
- Verifying that the model data (i.e., inverts, diameters, etc.) was input correctly and that the flow direction, size, and layout of the modeled pipelines were logical.
- Reviewing pipeline connectivity to determine, in a general sense, how flows are routed through the collection system.

4.3 MODEL DEVELOPMENT

This section describes the background information on how the model was set up and run, the various types of scenarios and alternatives included, and the types of model simulations that were applied.

4.3.1 Scenario Management

SewerGEMS has the capability to create separate scenarios to represent different conditions within the model. These conditions can depict existing or future parameters to be analyzed in the network such as various sanitary load conditions, different pipe diameters and materials, modified operating controls, and alternate pipe configurations. These parameters can be added to a scenario as a data set and then modeled.

4.3.1.1 Scenarios and Alternatives

SewerGEMS allows the creation of multiple parent and child scenarios and alternatives. Child scenarios will automatically inherit the same set of data from the parent scenario from which it was created. Similarly, child alternatives will initially inherit the same data from their parent alternative. If a parent scenario or alternative is modified, all child scenarios or alternatives to the parent will automatically be updated. However, once a child alternative has itself been altered, the child alternative will no longer inherit changes from its parent alternative. It is important to ensure changes made in different scenarios have passed on to the other scenarios (if applicable), as intended.

4.3.1.2 Steady State and Extended Period Simulations

Models can be simulated in two different modes: steady state or extended period simulation (EPS). A steady state model predicts hydraulic behavior at one instant in time, assuming

that the collection system is close to steady state conditions. An EPS model performs a series of steady state balances at specified intervals.

An EPS model is able to predict wet well levels and mimic pumps turning on and off as conditions change throughout the day. Therefore, this type of simulation is commonly used to resolve system storage concerns, evaluate lift station capacity, and to solve operational problems, since an EPS model can simulate dynamic conditions. An EPS model requires diurnal flow pattern information and additional time-based operating control information for pumps. Diurnal patterns, based on field test data, as discussed in Chapter 3, were applied to each lift station. Wet well operational control information was provided by County staff (Appendix D), although this data may have been modified during the calibration process.

EPS scenarios, using a 3-second routing time step, were developed for base and wet weather conditions in each planning period through build-out. Table 4.1 summarizes the different model simulations evaluated for each planning period.

| Table 4.1 Descriptions of Wastewater Model Simulations Southwest WWCS Master Plan Update Manatee County | | | |
|---|--------------------|---------------------------|--|
| Planning Period | Scenario | Type of Simulation | Simulation Description⁽¹⁾ |
| Calibration | Base (Dry Weather) | Extended Period | 72-hour EPS analysis with dry (base) sanitary loads |
| | Wet Weather | Extended Period | 96-hour EPS analysis with base (dry) sanitary loads and a three-day storm event ⁽²⁾ |
| 2015, 2020, 2025, 2035, Planned Development, and Build-Out | LOS (Base) | Extended Period | 72-hour EPS analysis with LOS sanitary loads |
| | Wet Weather | Extended Period | 96-hour EPS analysis with base (dry) sanitary loads and a three-day storm event ⁽²⁾ |
| <p><u>Notes:</u></p> <p>(1) The purpose of the first 24 hours of each simulation is to allow the system to reach equilibrium. They are not analyzed in the results.</p> <p>(2) Based on calibration (dry) sanitary loads and the three-day storm event from September 23-25, 2013, as discussed in Chapter 3.</p> | | | |

4.4 MODEL CALIBRATION

Model calibration involves adjusting model parameter values until observed model results are within reasonable agreement with data measured in the field such as pressure and flow rate. The goal of calibration is to reproduce in the computer software a model network of the collection system that simulates the behavior of the existing system as close as

possible for the purpose of planning future infrastructure and evaluating system performance.

Model calibration is a key step in preparing the model for use and accomplishes the following purposes:

- Assist in confirming the distribution of wastewater sanitary loads
- Identify data errors or missing data parameters
- Discover anomalies
- Establish a degree of confidence in the model

4.4.1 Calibration Standards and Expected Accuracy

Hydraulic models are built from the best available information regarding the physical attributes and operational conditions of the collection system. There are a number of parameters that are not directly known and cannot be directly measured. For this reason, these parameters must be assumed initially based on typical values and engineering judgment. Every collection system is unique. For this reason, industry standard of care dictates that a model be validated to ensure that the assumptions built into the model are reasonable and provide results that correctly reflect the operation of the system. This validation process is commonly referred to as calibration.

Possible sources of error between field measurements and model results include errors in input data (measurement and typographical), errors in SCADA data used for calibration, unknown pipe roughness values, incorrect distribution of sanitary loads (population), errors in data derived from network maps or GIS, node elevation errors, errors introduced by a simplified representation of the network, errors (identified by model anomalies) that may be correlated to valves that unknowingly may be partially or fully closed in the field, outdated or unknown pump characteristic curves, and poorly calibrated measuring equipment.

It is not realistic to believe all errors can be eliminated; however, errors should be reduced to acceptable limits so that there is confidence in the model results. Even if high quality information for the physical attributes of the system is available and good estimates of sanitary loads are included in the model, differences between simulated and observed performance can still exist.

Once a model is considered calibrated, it can be used to estimate hydraulic characteristics of the real-world system at locations where measured data are unavailable or unknown, identify system deficiencies, and evaluate the system under future conditions.

In the United States, calibration standards to assess the accuracy of model calibration have yet to be developed and depend heavily on the complexity of the system and availability of data to develop the model. For that reason, the following calibration criteria have been suggested:

- An average pressure difference of ± 2.2 psi with a maximum difference of ± 7.3 psi with a "good" data set, and an average pressure difference of ± 4.3 psi with a maximum difference of ± 14.2 psi with a "poor" data set (Walski, 1983); and
- The difference between measured and simulated values should be ± 5 psi to ± 10 psi (Cesario and Davis, 1984).

Carollo used these criteria as general guidelines and took into account the availability and accuracy of the data for the Manatee County collection systems.

The Wastewater Planning Users Group (WaPUG), a section of the Chartered Institution of Water and Environmental Management, has established generally agreed upon principles for model verification. The base flow and wet weather calibration focused on meeting the recommendations on model verification contained in the "Code of Practice for the Hydraulic Modeling of Sewer Systems," published by the WaPUG (WaPUG 2002), as summarized below:

- **Base Wastewater Flow Calibration Standards:** Base flow calibration should be carried out for two base flow days, and the modeled flows and depths should be compared to the field measured flows and depths. Both the modeled and field measured flow hydrographs should closely follow each other in both shape and magnitude. In addition to the shape, the flow hydrographs should also meet the following criteria as a general guide:
 - The timing of flow peaks and troughs should be within one hour.
 - The peak flow rate should be within the range of ± 10 percent
 - The volume of flow (or the average rate of flow) should be within the range of ± 10 percent. If applicable, care should be taken to exclude periods of missing or inaccurate data.
- **Wet Weather Calibration Standards:** The model simulated flows and depths should be compared to the field measured flows and depths. The flow hydrographs should closely follow each other in both shape and magnitude, until the flow has substantially returned to dry weather flow rates. In addition to the shape, the flow hydrographs should also meet the following criteria as a general guide:
 - The timing of the peaks should be similar with regard to the duration of the events.
 - The peak flow rates at significant peaks should be in the range of +25 percent to -15 percent and should be generally similar throughout.
 - The volume of flow (or the average flow rate) should be within the range of +20 percent to -10 percent.

4.4.2 Field Test

A wastewater collection system field test was performed in April 2015 to gather pressure and flow data needed to calibrate the base model. The pressure and flow observed at

different locations during the field test were compared against the model results at the same locations. Adjustments in the model were made to correct the inconsistencies and improve the accuracy of the model. In addition to temporary flowmeters and pressure loggers, data from the County's SCADA system was also used to compare simulated flow at various lift stations. Specific locations of temporary flowmeters, pressure loggers, and SCADA-derived data are provided in the Field Test Plan, provided in Appendix F. Appendix G includes the calibration results for all locations indicated in the Field Test Plan.

The flow data gathered during the field test was also used to adjust or confirm the base calibration sanitary loading. The calibration sanitary loading was calculated based on the 2015 population and the total daily flow measured at the SWWRF during the dates of the field test.

4.4.3 Base Model Calibration

Data from the field test was evaluated to identify two days where the data was complete and when there was little or no rainfall. For the Southwest Service Area, April 16 and 17, 2015 were selected. The base calibration scenario was run as an EPS over a 72-hour period, where the first 24 hours were used to allow the system to fill and come to equilibrium. Only the last 48 hours of the simulation were used for calibration.

The following steps were taken to calibrate the Southwest model:

1. Distribute populations to the existing sewer sheds (as discussed in Chapter 3).
2. Apply sanitary loads (population), diurnal patterns, and unit flow factors (gpcd) to the loading manholes.
3. Identify calibration control points with reliable data and prepare calibration spreadsheet (for comparison of simulated and actual data).
4. Adjust model variables to match simulated flows and pressures with field measured/ SCADA data. Adjustments made to the model included:
 - a. Redistributing population among sewer sheds to adjust simulated flows and pressures, i.e. if simulated flows were higher than field or SCADA data, population was decreased in that area and vice versa.
 - b. Adjusting pump curves and VFD flow-depth curves.
 - c. Adjusting initial wet well levels and pump on and off elevations.
 - d. Adjusting (delaying) diurnal patterns.
 - e. Adjusting invert/node elevations to reduce routing discontinuities and overflows, and to match pressures measured in the field where available.
 - f. Eliminating or lengthening short segments of pipe that lead to routing errors.
 - g. Finding an optimal duration for the hydraulic and hydrological EPS time steps without compromising model run time (run time increases as the EPS time step is refined)

The model calibration scenario was reviewed for reasonableness and compared with measured data. Final overall calibration results should be reviewed on a continuous basis

and updated as known changes to the system occur. The overall simulated flows for the SWWRF, #5 MLS, 1-M MLS, 1-D MLS, 12-A MLS, 13-A MLS, and 27-A MLS are summarized in Table 4.2. Also shown in Table 4.2 are the simulated and field-measured pressure at several locations within the Southwest Service Area. The data shown in Table 4.2 reflects the average flow, pressure, the percent difference for flow and pressure throughout the 48-hour calibration simulation period. It should be noted that the flow at a few MLSs was estimated using pump speed and pressure from SCADA and in some instances resulted in questionable values. The overall simulated flow to the SWWRF is within 2 percent of the actual flow. Figure 4.3 shows the flow and pressure calibration results for MLS 1-D. Appendix G includes a complete graphical summary of the calibration results.

| Table 4.2 Base Calibration Results Southwest WWCS Master Plan Update Manatee County | | | |
|--|--|-------------------------------------|---|
| Average Daily Flow⁽¹⁾ | | | |
| Location | Field or SCADA Derived Flow (mgd)⁽²⁾ | Simulated Flow (mgd) | Percent Difference⁽³⁾ |
| SWWRF | 12.97 | 13.17 | 1.6% |
| 1-M MLS | 1.74 | 1.53 | -12.0% |
| #5 MLS | 0.71 | 0.68 | -4.8% |
| 1-D MLS | 1.23 | 1.17 | -4.6% |
| 12-A MLS | 0.76 | 0.70 | -8.0% |
| 13-A MLS | 2.98 | 2.90 | -2.5% |
| Pressure⁽¹⁾ | | | |
| Location | Field or SCADA Pressure (psi)⁽⁴⁾ | Simulated Pressure (psi) | Psi Difference⁽⁴⁾ |
| 1-M MLS | 17.4 | 16.81 | -0.59 |
| 1-D MLS | 10.3 | 9.49 | -0.81 |
| 12-A MLS | 18.3 | 20.76 | 2.46 |
| 27-A MLS | 10.0 | 12.71 | 2.71 |
| 13-A MLS | 15.2 | 16.33 | 1.13 |
| Notes: | | | |
| (1) Data reflects average of hourly field and model data points over the 48-hour calibration period. | | | |
| (2) Temporary flow meters were used at #5 MLS and 1-D MLS. SCADA data was available at the SWWRF. Flow was derived from pump speed and pressure time series for all other locations. | | | |
| (3) Percent difference = (Simulated - Actual)/Actual*100 | | | |
| (4) Expressed as psi for comparison with the calibration standards described in Section 4.4.1. | | | |

MLS 1D FM Pressure Calibration (RTU 237)

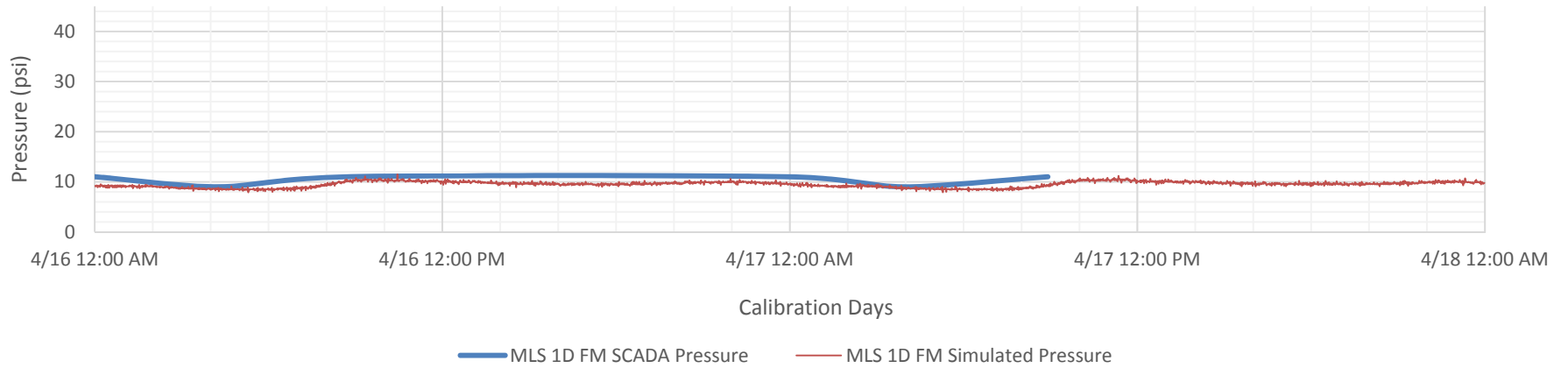

Upstream 1D MLS Calibration (MH 6090)

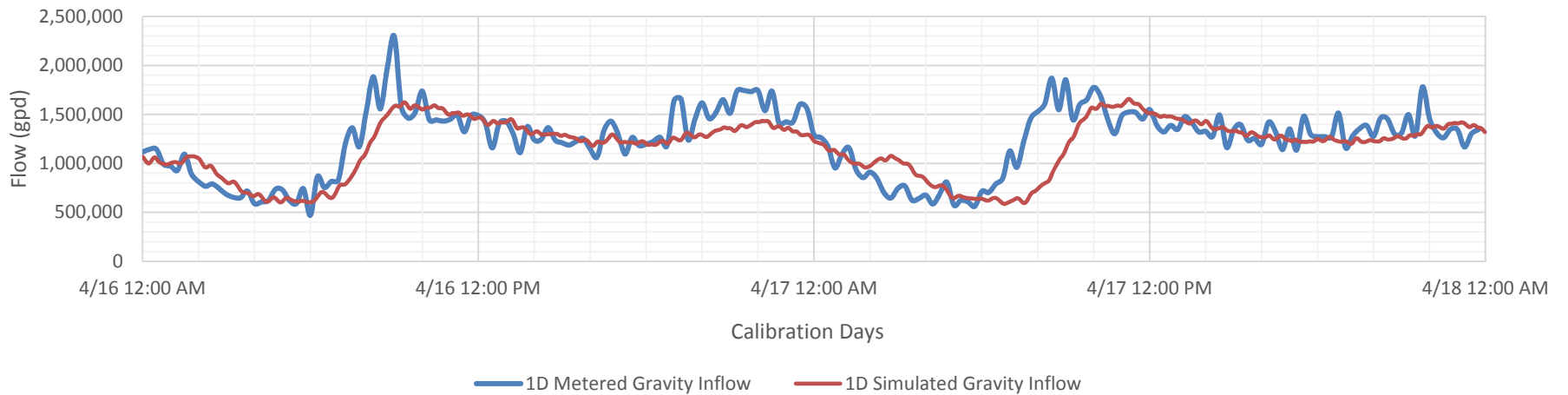

1-D MLS BASE CALIBRATION RESULTS

FIGURE 4.3

MANATEE COUNTY
SOUTHWEST WWCS MASTER PLAN UPDATE

4.4.4 Wet Weather Methodology

Based on the analysis of the historical wet weather data, and consulting with County staff, the 3-day storm event of September 2013 was used to calibrate the base wet weather scenario and to model future wet weather scenarios. The process to develop the wet weather scenarios consists of several elements:

- **Define RDII Tributary Areas.** For the wet weather scenarios, RDII flows are added to the dry sanitary loads. Sewer sheds were delineated in GIS using existing infrastructure and parcel boundaries and were imported to the model to serve as the RDII catchments. The total area contributing to I&I was calculated in GIS and excludes areas that were not expected to contribute to I&I, such as undeveloped and vacant land not connected to the sanitary sewer system. The tributary area provides a means to transform hourly rainfall depth from the rainfall hydrographs into a rainfall volume. The rainfall volume is transformed into actual RDII flows using the unit hydrograph, as described in the next step.
- **Create I&I Parameter Database.** The main step in the wet weather calibration process is creating custom unit hydrographs using the RTK method. The RDII unit hydrograph is the summation of three separate triangular hydrographs (short term, medium term, and long term), each being defined by three parameters: R, T, and K. R represents the fraction of rainfall over the sewer shed that enters the collection system; T represents the time to peak of the hydrograph; and K represents the ratio of time to recession to the time to peak. Therefore, there are a total of nine separate variables associated with each unit hydrograph. Figure 4.4 shows the shape of an example unit hydrograph.
- The nine variables in each unit hydrograph were initially set based on engineering judgment and then adjusted until the model simulated flow matched closely with the actual flow data. Because of the limited locations where actual hourly flow data was available (only average daily systems-derived flow was available at 1-D MLS, 13-A MLS, 27-A MLS, and 1-M MLS; hourly flows at the SWWRF were provided from historical SCADA, and hourly flows were calculated at 12-A MLS from historical pump speed and pressure time series), a series of approximated unit hydrographs for each location were developed. The level of accuracy of each series of unit hydrographs varied from one location to the other, as the quality of the data sets varied greatly.

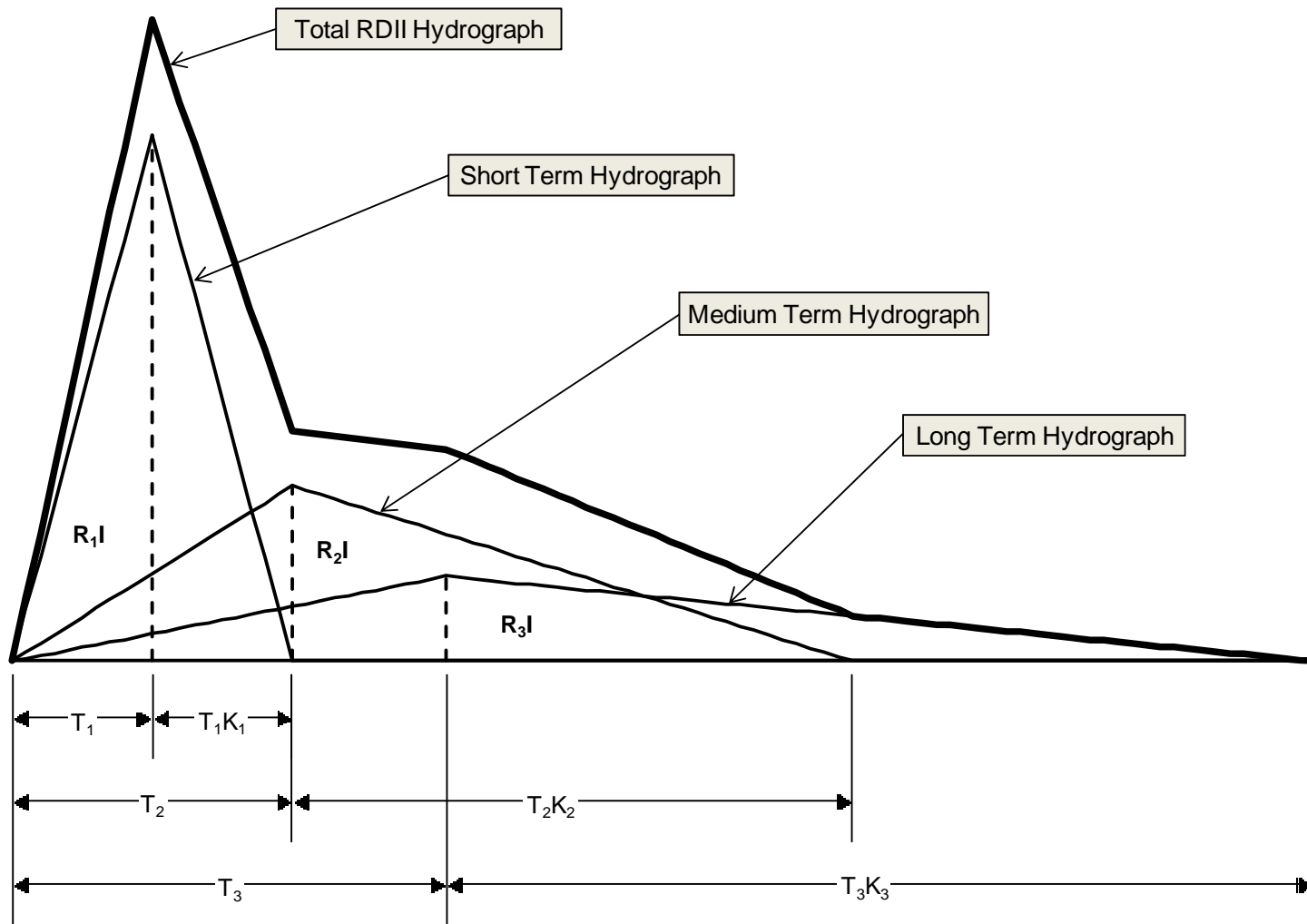

EXAMPLE RDII UNIT HYDROGRAPH

FIGURE 4.4

MANATEE COUNTY
SOUTHWEST WWCS MASTER PLAN UPDATE

- **Identify Calibration Rainfall Events.** As discussed in Chapter 3, the County's wastewater collection system appears to be impacted more from a prolonged storm of lower intensity than a 24-hour storm of higher intensity. Therefore, the 3-day storm event from September 2013 was used to calibrate the existing model and to model future wet weather scenarios.
- Rainfall data was available at several Southwest Florida Water Management District (SWFWMD) rain gauge locations located in the Service Area (Figure 4.5). Also shown in Figure 4.5 is the rainfall at the SWFWMD rain gauges during the September 2013 storm event. The Palma Sola Drain rain gauge was used to calculate the 1-D MLS area RTK values, the Bowles Creek rain gauge was used to calculate both 27-A and 12-A MLS RTK sets, and the Oneco rain gauge was used to calculate the 13-A MLS RTK set. The average rainfall at all gauges was used to calculate the RTK values associated with the remainder of the SWWRF area.

4.4.5 Wet Weather Model Calibration

The wet weather calibration enables the hydraulic model to more accurately simulate I&I entering the collection system during a large storm. As discussed, one unit hydrograph set was developed for each of the MLS basins, except for #5 MLS (no wet weather data was available for the time period in consideration). The wet weather calibration process is similar to the base calibration in that model variables (mainly catchment size and R, T, and K values) were adjusted to match simulated flows as closely as possible to actual flow data. The base calibration scenario was re-checked to ensure the base calibration results were not adversely affected by changes made during wet weather calibration.

Comparisons were made for the base and peak flows as well as the temporal distribution of flow at the SWWRF and 12-A MLS, where hourly data was available. According to the WaPUG, a hydraulic model is generally considered to be satisfactorily calibrated to wet weather flow conditions if the modeled peak flows are within +25 percent to -15 percent of the field measured data, and if the average modeled flows are within +20 percent to -10 percent of the field measured data.

Appendix G contains a detailed wet weather flow calibration summary for each of the monitored locations. A summary of the wet weather calibration results are presented in Table 4.3. The data shown in Table 4.3 reflects the average daily and peak flows, and percent difference over the 72-hour calibration period. An example of the wet weather calibration using SCADA derived flows for the SWWRF is shown in Figure 4.6

| Table 4.3 Wet Weather Calibration Summary Southwest WWCS Master Plan Update Manatee County | | | |
|---|---------------------------------------|----------------------------------|---|
| Average Daily Flow⁽¹⁾ | | | |
| Location | SCADA Flow (mgd)⁽²⁾ | Simulated Flow (mgd) | Percent Difference⁽³⁾ |
| SWWRF | 22.68 | 22.70 | 0.05% |
| 1-D MLS | 2.38 | 2.39 | 0.40% |
| 13-A MLS | 4.21 | 4.31 | 2.46% |
| 12-A MLS | 2.72 ⁽⁴⁾ | 2.55 | -6.20% |
| 27-A MLS | 4.00 | 3.67 | -8.36% |
| 1-M MLS | 3.98 | 3.71 | -6.86% |
| Peak Flow⁽⁴⁾ | | | |
| Location | Actual Peak Flow (mgd) | Simulated Peak Flow (mgd) | Percent Difference⁽³⁾ |
| SWWRF | 39.41 | 36.6 | -7.1% |
| 12-A MLS | 4.04 | 4.6 | +13.9% |
| Notes: | | | |
| (1) Average flow over the 3-day simulation period (September 23-25 2013). | | | |
| (2) From average daily flows derived from SCADA, except noted otherwise. | | | |
| (3) Percent Difference = (Simulated - Actual)/Actual*100. | | | |
| (4) Based on hourly data. | | | |

Overall, the simulated average daily flow to the SWWRF was within +/- 4 percent of the actual flow and 12-A was from -14.3 to -3.7 percent. The simulated peak hourly flow at the SWWRF was 7.1 percent below actual peak hourly flow and the simulated 12-A peak flow was 13.9 percent higher than the actual peak hourly flow. As shown, the SWWRF calibration falls within WaPUG's recommendation for wet weather calibration. The model was as thoroughly calibrated as possible, taking data availability and accuracy into account. It should be noted that several lift stations were manually operated during the actual storm event to prevent overflows, which cannot be replicated by the model, and thus affected calibration results. Several stations pumped extremely high flows, according to SCADA derived flow data.

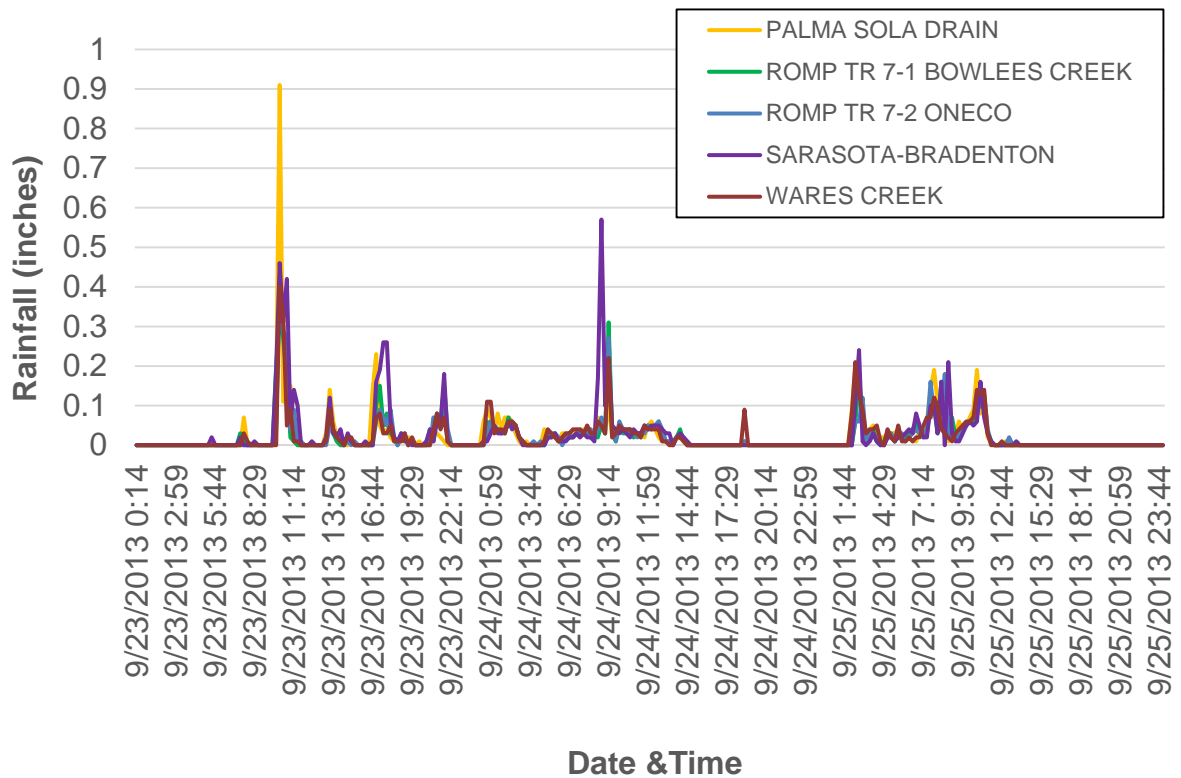
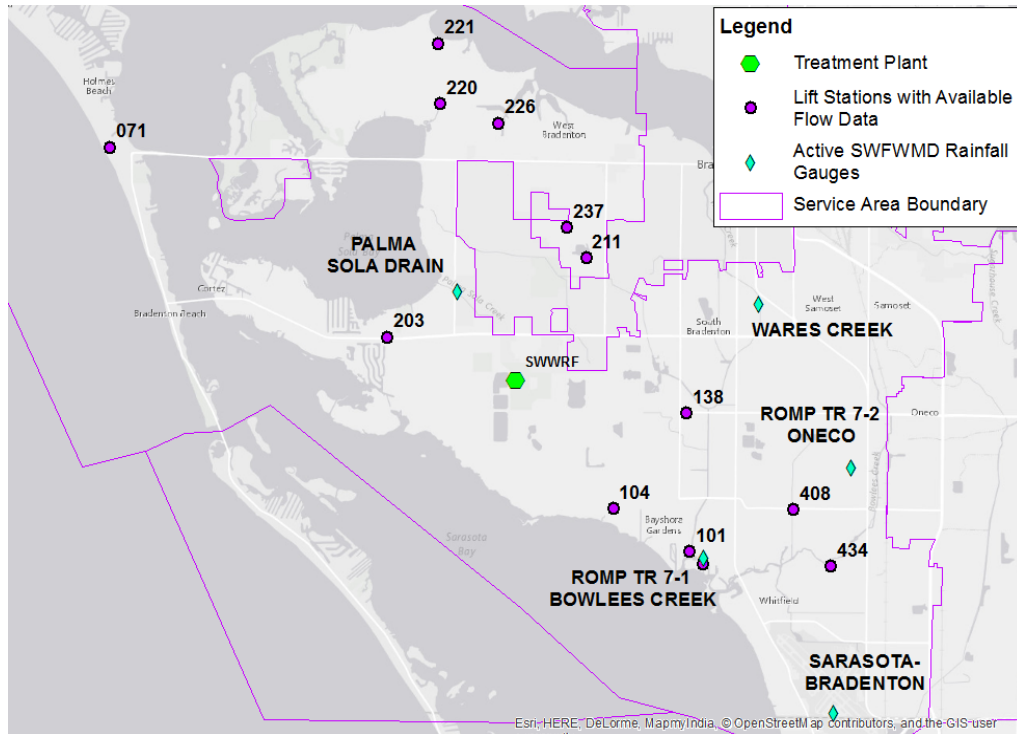

SWFWMD RAIN GAUGES

FIGURE 4.5

SWWRF Influent Calibration

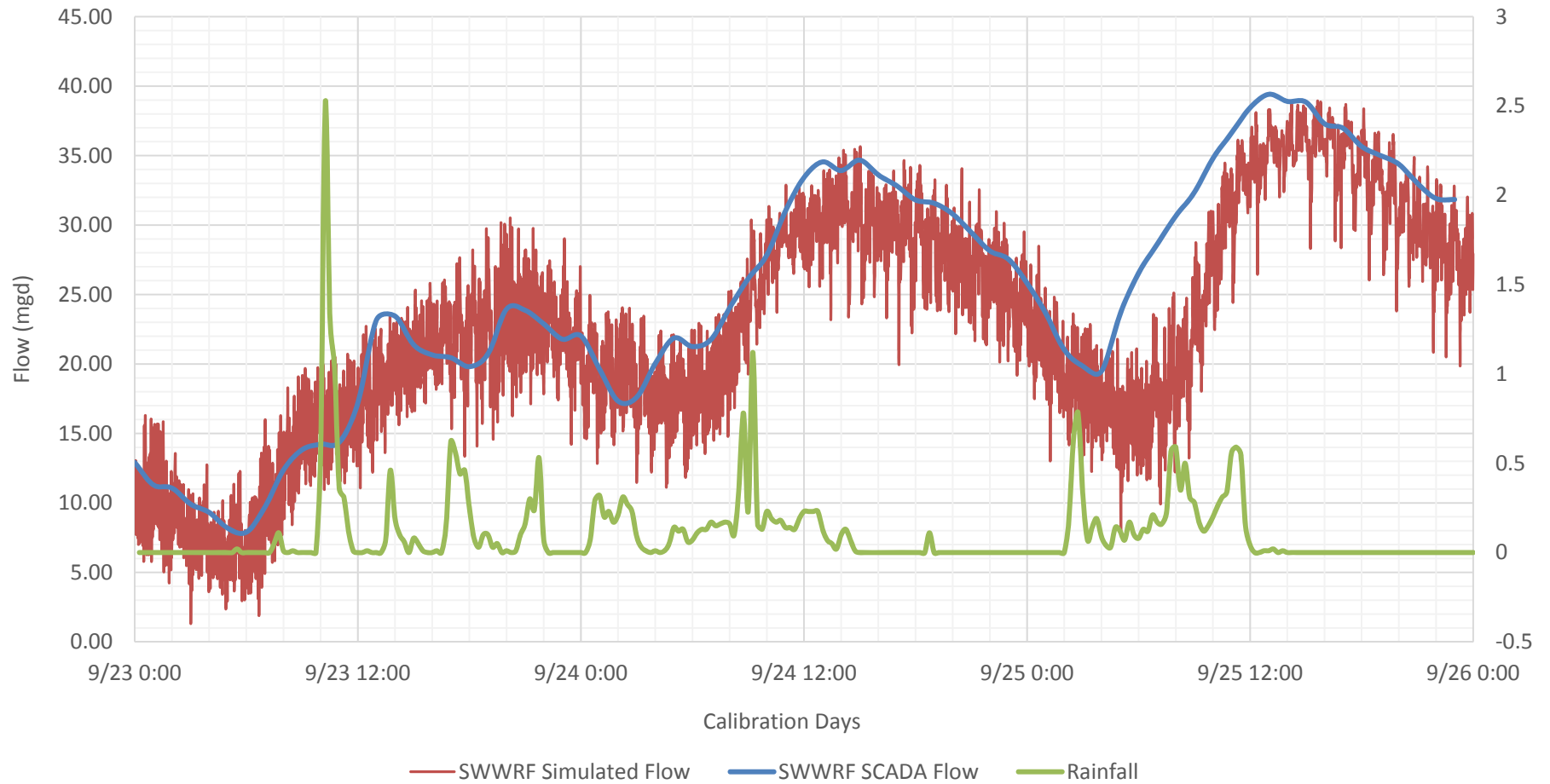

SWWRF WET WEATHER CALIBRATION RESULTS

FIGURE 4.6

MANATEE COUNTY
SOUTHWEST WWCS MASTER PLAN UPDATE

4.5 CALIBRATION SUMMARY

As documented in this section, flow results of the model, after adjustments, were reasonable and match the actual system data relatively closely, under both the base and wet weather conditions. The average daily flow to the SWWRF was within 5 percent in the base and within +/- 4 percent in the wet weather scenarios. Both base and wet weather calibration results meet the generally accepted standards used to determine the adequacy of model calibration, according to the WaPUG. Care should be taken when modifying the model parameters, as changes may affect the overall results and reliability of the model.

4.5.1 Recommendations for Future Modeling Efforts

Several modifications listed below should be considered to increase the robustness of the model during future model updates. It is not anticipated that these modifications would significantly impact the current overall calibration results.

- Install flowmeters at key locations throughout the collection system, including all master lift stations. A flowmeter is also recommended at the Bayshore Yacht Basin lift station (RTU 101). Calibrate flow meters annually.
- Calibrate existing flowmeters and pressure transducers.
- Perform field pump tests and update pump curves in the model.
- Maintain records of current pump settings (on/off elevations and wet well levels) when available, for dry and wet weather conditions.
- Start a database where differences in pump operation, maintenance, and controls during dry and wet weather are kept and continually maintained.
- Reconcile all infrastructure differences between model and GIS.
- Wastewater generation factors (LOS gallons per capita) should be reviewed on an on-going basis to reflect up to date wastewater loading/input.

EXISTING (2015) SCENARIO EVALUATION

5.1 INTRODUCTION

The primary objective of the wastewater collection system (WWCS) evaluation is to verify that the existing infrastructure satisfies the performance criteria set forth in Chapter 3. All evaluations and recommendations presented in this chapter are based on the current pipeline size, material, location, capacity, and other operational data provided by the County. This chapter evaluates the existing (2015) level of service (LOS) and wet weather scenarios, while the future scenarios are evaluated in Chapter 6. Identification of infrastructure improvements due to age or condition is not included in the analysis; however, pipeline replacements recommended in the County's Force Main Asset Management Plan (Carollo, 2014) are included in the overall cost estimate and CIP plan, presented in Chapter 7.

The remaining sections of Chapter 5 include:

- Section 5.2 - Existing Collection System Assumptions: Describes the assumptions used in developing and evaluating the existing collection system.
- Section 5.3 - Existing System Analysis: Describes the performance of the existing system and identifies areas that do not meet the performance criteria.
- Section 5.4 - Summary and Recommendations: Provides a summary of the existing system modeling results and recommended future infrastructure needed to meet selected performance criteria.

5.2 EXISTING COLLECTION SYSTEM ASSUMPTIONS

The analysis of the existing wastewater collection system is based on the following assumptions. Changes in these assumptions will alter model results and could change system recommendations:

1. Only gravity mains that connect force mains to the network are included in the model, regardless of size. Each lift station also has a gravity main connecting a loading manhole to the wet well, although these were not evaluated for performance.
2. 194 of the County's existing lift stations and no private stations within the Southwest Service Area were included in the Southwest WWCS model.
3. Pipeline infrastructure in the County's previous model was updated based on data provided by the County and feedback from County staff. Missing infrastructure was imported from the County's GIS database. Most data was not field verified for this project; however, the data has been checked for reasonableness and consistency by County staff.

4. Existing lift station data, where available, including elevations, pump curves, wet well diameters, and operating setpoints were incorporated into the model (Appendix D). This data was provided by the County but was not field verified by Carollo. When data for lift stations was not available, average or typical operating parameters from known lift stations were used to provide a representative operating protocol, as presented in Chapter 3. If lift station operating parameters change in the future or are different from what was used in the model, the results of the model may vary.
5. Existing force mains were modeled using Hazen-Williams C-factors of 140 for plastic pipes and 120 for metallic pipes. C-factors were selected during model calibration to provide reasonable correlation between model results and field data.
6. Extended period simulation (EPS) scenarios were modeled with both pumps active at each station, controlled by the elevation of wastewater in the wet well over time. The six master lift stations with VFD pumps were controlled by the depth-flow curves. The EPS was run for 72 hours for the LOS scenario and 96 hours for the Wet scenario. Model results from the first 24 hours was eliminated from analysis as this time is used to bring the collection system to equilibrium (allows the system to "fill up").

Initial wet well elevations were set at halfway between the pump on and off elevations; however, some initial wet well elevations may have been changed during the calibration process. A summary of the model wet well information for each lift station is provided in Appendix E.

5.3 EXISTING SYSTEM ANALYSIS

The 2015 LOS and Wet Weather scenarios were used to determine if the existing infrastructure satisfies the performance criteria listed in Chapter 3. The capacity was assessed by evaluating the force main velocity, the depth in the gravity pipelines, and the average pump starts and wet well capacity of the lift stations.

It should be noted that some force mains will have a velocity less than 2 feet per second (FPS) under certain conditions throughout the simulation period, such as: 1) the velocity in some force mains may be zero when one or more lift stations are not pumping, and 2) at peak flow, the head loss in the system is high, which limits the pump capacity and decreases flow, and consequently velocity, during this condition. Alternately, during low flow conditions, few lift stations are pumping simultaneously, which decreases the amount of head loss in the system. During these conditions, many lift stations will pump high flows, resulting in higher velocities. There may also be very brief spikes in force main velocity in response to pumps turning on. These conditions are discussed further in the following sections.

5.3.1 2015 LOS Analysis

The 2015 LOS scenario was analyzed to determine how the existing infrastructure operates under current (2015) conditions at average (LOS) flows.

Figure 5.1 illustrates the maximum force main velocities and maximum gravity pipe flow depth obtained during the 48-hour analysis period for the LOS scenario. It also shows the average pump starts per hour at each lift station. Table 5.1 lists the lift station wet wells with more than five pump start/stop cycles per hour.

| Table 5.1 2015 LOS Lift Stations with more than 5 Pump Cycles per Hour Southwest WWCS Master Plan Update Manatee County | |
|--|--|
| Lift Station ID⁽¹⁾ | Number of Pump Start/Stop Cycles per Hour |
| WW-063 | 8.60 |
| WW-074 | 6.23 |
| WW-101 | 9.46 |
| WW-108 | 6.23 |
| WW-126 | 5.25 |
| WW-210 | 6.44 |
| WW-213 | 8.58 |
| WW-238 | 8.51 |
| WW-303 | 6.69 |
| WW-308 | 7.68 |
| WW-341 | 6.02 |
| WW-407 | 11.82 |
| WW-416 | 8.60 |
| Notes: | |
| (1) Lift Station ID corresponds to its RTU number. | |

As described in Chapter 3, starting and stopping more than five times an hour for any one pump is not recommended based on County utility design criteria. Pump cycles may be reduced by adjusting pump control elevations, subject to wet well volume availability and the invert elevation of the influent pipe. If the pump controls cannot be modified without affecting pumping efficiency, then the large number of cycles can be directly related to insufficient wet well volume for the existing flow conditions.

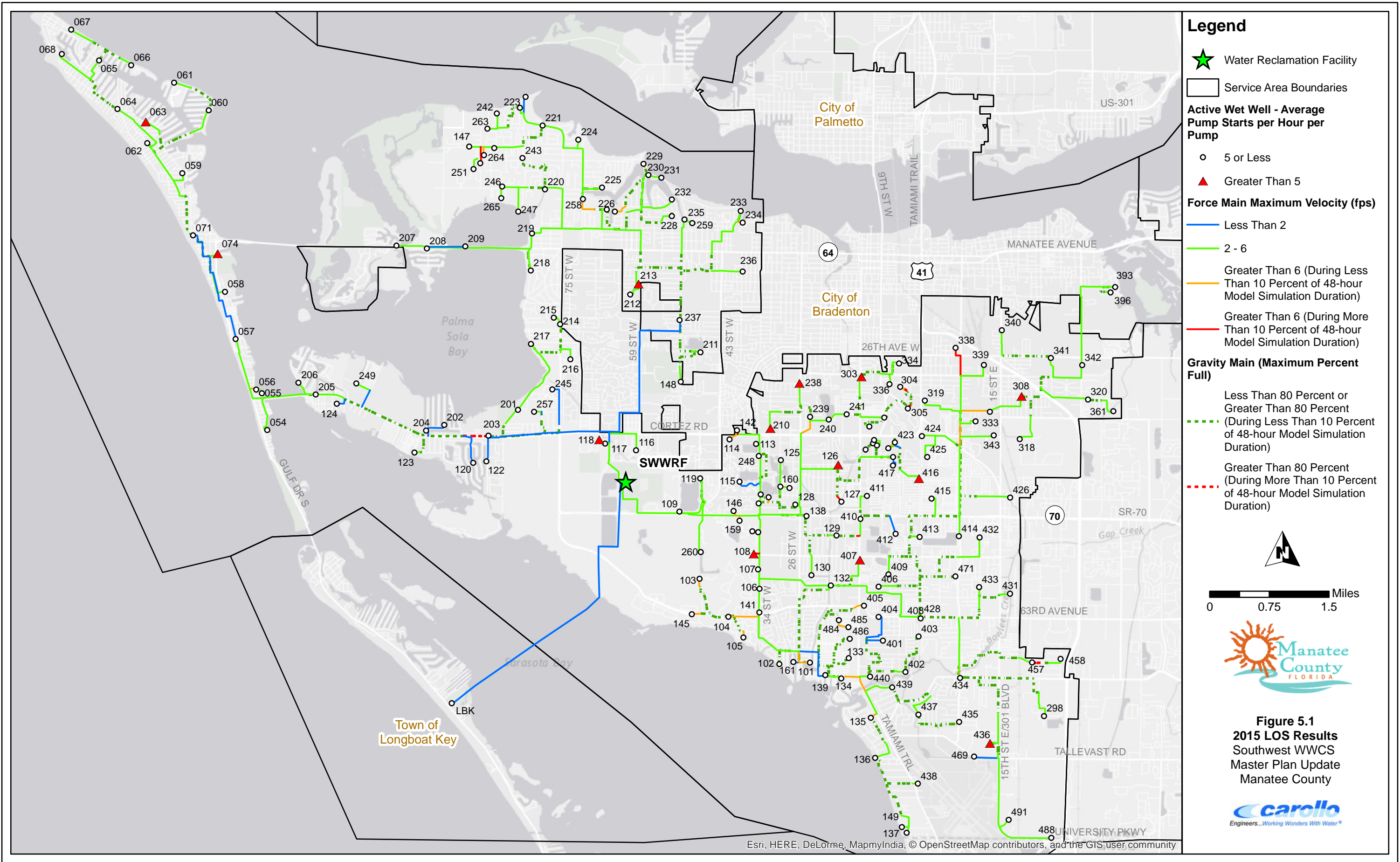

All force mains where the flow never reaches 2 FPS are shown in Figure 5.1. As mentioned previously, it is expected that some force mains may have periods of low velocity; however, there are several areas where the maximum force main velocity never reaches 2 FPS throughout the simulation, including the following major force mains:

- The 24-inch and 30-inch segments of the MLS 1-M (RTU 203) force main (from MLS 1-M to the SWWRF).
- The 20-inch and 24-inch segments of the MLS 1-D (RTU 237) force main (from MLS 1-D to where it ties into the MLS 1-M force main).
- The approximately 3,400-foot, 20-inch first segment of MLS 12-A (RTU 139) force main.
- The 18-inch force main downstream MLS #5 (RTU 071), up to the confluence with Lift Station 2-C (RTU 057).
- The 6-inch force main that serves as confluence for the following lift stations: The Loop (RTU 147), Fiddlers Green (RTU 250), The Nursery (RTU 264), and Colonial Woods (RTU 262).

These low velocity force mains may be subject to deposition of sediment that is not cleared because the velocity in the force main never reaches the minimum scouring velocity of 2 FPS. Force mains operating at such low velocities may need to be pigged or cleaned to clear sediment that has collected in the pipe. Low velocities may also lead to odor issues and possibly corrosion, due to the buildup of hydrogen sulfide. Pigging ports may be installed to help prevent these issues.

Force mains with a maximum velocity greater than 6 FPS were further analyzed in the 2015 Wet Weather scenario and are discussed in more detail in the following section.

5.3.2 2015 Wet Weather Analysis

The existing (2015) system was also evaluated under wet weather conditions to determine the system's ability to operate and meet performance criteria under maximum flow conditions. Figure 5.2 shows the maximum force main velocities, maximum gravity pipe depth, and the average number of pump starts per hour for the 2015 Wet Weather scenario. The following sections describe the force mains, lift stations, and gravity system areas that do not meet the County's WWCS performance criteria.

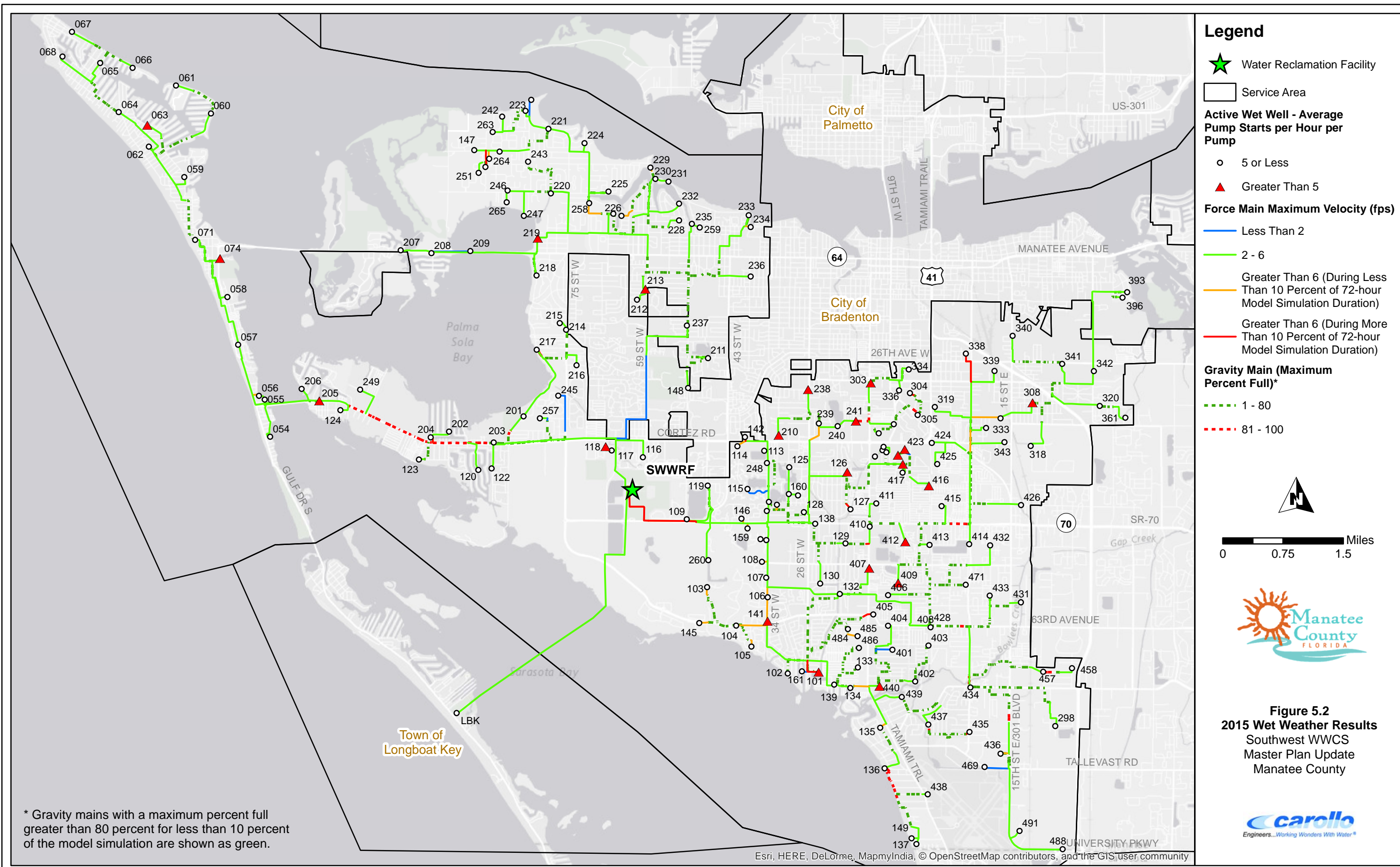

* Gravity mains with a maximum percent full greater than 80 percent for less than 10 percent of the model simulation are shown as green.

5.3.2.1 Force Mains

Force mains with velocities greater than 6 FPS were evaluated to determine the magnitude and duration of the exceedances. All force mains with a maximum velocity greater than 6 FPS for more than 10 percent of the simulation are listed in Table 5.2.

Each of these high velocity force mains was evaluated to determine the potential cause of the high velocity, typically a function of the force main size or the pumps. A simple calculation, using the population served and a peaking factor based on the population, was performed to determine if the cause of the velocity exceedance was a lack of capacity, and therefore if a force main upsize is needed. If the calculation indicates that a force main is sized properly (has not reached capacity based on population), it is suspected that the operating point of the pump may be incorrect for the head condition, causing a flow and velocity spike in the hydraulic modeling software.

Some of these high velocity force mains discharge directly to gravity pipelines or to other force mains that operate at very low pressures. Under these conditions, the pumps operate on the far right side of their curve, resulting in high flows and velocities when the pumps are on. It is also possible that data in the model is not accurate to field conditions (outdated pump curve or imprecise node elevations). For these, it is recommended that the County check the pump curve, impeller size, node elevations, or perform a pump drawdown test to verify the actual force main flow/velocity. Recommendations for each of the high velocity force mains are presented in Table 5.2.

| Table 5.2 2015 Wet Weather Maximum Force Main Velocities Southwest WWCS Master Plan Update Manatee County | | | |
|--|---------------------------------------|--|--|
| Force Main ID⁽¹⁾ or Alignment | Maximum Velocity (FPS) | Duration of Velocity > 6 FPS, hours (Percent Duration)⁽²⁾ | Recommendation |
| FM-139-408-138-6 FM-139-408-138-7 FM-139-408-138-8 FM-139-408-138-9 FM-SWWRF-From East ⁽³⁾ | 7.6 | 13.8 (19%) | Continue with plans to upsized existing 30-inch force main with 42-inch (CIP # 6082980) |
| FM-SWWRF-Outfall ⁽⁴⁾ | 6.5 | 2.2 (3%) | Upsize existing 42-inch force main during headworks replacement project. |
| FM-057-1 | 9.9 | 8.7 (12%) | Verify model input data ⁽⁵⁾ |

| Table 5.2 2015 Wet Weather Maximum Force Main Velocities Southwest WWCS Master Plan Update Manatee County | | | |
|--|---------------------------------------|--|---|
| Force Main ID⁽¹⁾ or Alignment | Maximum Velocity (FPS) | Duration of Velocity > 6 FPS, hours (Percent Duration)⁽²⁾ | Recommendation |
| FM-101-1 FM-101-2 | 8.5 | 26.7 (37%) | Upsize force main to a 16-inch |
| FM-127-1 | 8.0 | 14.6 (20%) | Verify model input data ⁽⁵⁾ |
| FM-142-1 | 6.9 | 8.8 (12%) | Verify model input data ⁽⁵⁾ |
| FM-204-1 FM-204-2 | 7.2 | 9.3 (13%) | Verify model input data ⁽⁵⁾ |
| FM-250-1 | 6.5 | 8.3 (12%) | Verify model input data ⁽⁵⁾ |
| FM-304-1 FM-304-2 | 8.0 | 12.1 (17%) | Verify model input data ⁽⁵⁾ |
| FM-338-1 FM-338-2 | 6.8 | 9.5 (13%) | Verify model input data ⁽⁵⁾ |
| FM-405-1 | 7.8 | 13.4 (19%) | Verify model input data ⁽⁵⁾ |
| FM-410-2 | 8.7 | 16.1 (22%) | Continue with plans to upsize existing 6-inch force main with an 8-inch (CIP # WW01037) |
| FM-435-1 | 9.6 | 10.6 (15%) | Verify model input data ⁽⁵⁾ |
| FM-484-1 | 8.2 | 9.7 (13%) | Verify model input data ⁽⁵⁾ |
| Notes: | | | |
| <p>(1) Force main ID corresponds to lift station RTU number.</p> <p>(2) Duration (hours) that force main velocity is greater than 6 FPS throughout the 72-hour model simulation.</p> <p>(3) This alignment corresponds to the project described in the CIP as "27-A MLS Force Main from 51st Street West to the SWWRF."</p> <p>(4) This is the SWWRF headworks influent pipe and although the maximum velocity (6 FPS) was only exceeded 2.1 hours out of the entire 72-hour simulation (less than 3 percent of the duration) it was included in this table because it is considered a critical pipe. This pipe is expected to be replaced as part of the new SWWRF headworks project (by 2018).</p> <p>(5) This is a small, remote lift station. The County should confirm all model input data, including pump curve, wet well diameter and elevations, downstream node elevations, and wastewater loadings are correct. A pump drawdown test may also be useful to confirm actual pump flow rate. Because there are no recommendations to upsize the force mains, these high velocity pipes will flag in each of the future scenarios.</p> | | | |

The 24-inch segment of the MLS 1-D force main and several lift station discharge force mains still do not reach 2 FPS in the 2015 Wet Weather scenario. These force mains will be

further evaluated under future conditions (discussed in Chapter 6). If deficiencies persist throughout the planning period, recommendations for corrective action will be included to avoid high operation and maintenance costs associated with pigging and cleaning.

5.3.2.2 Lift Stations

Average pump starts, pump utilization, pumping capacity, and wet well storage capacity were evaluated for each lift station. Table 5.3 lists the wet wells that had more than 5 pump starts per hour per pump (on average) in the 2015 Wet Weather scenario. Where possible, pump operating controls were adjusted in future scenarios to bring the average pump starts below 5 per hour. However, this was not possible in some cases, due to the elevation of the wet well influent pipe (County standard requires the pump on elevation to be below the influent pipe invert). For the lift stations where the operational controls were unable to be adjusted, or where adjusting the operational controls did not work, it is recommended the County confirm the actual pump on/off elevations and the pump curves. These locations are identified and further discussed in Chapter 6.

| Table 5.3 High Pump Starts in 2015 Wet Weather Scenario Southwest WWCS Master Plan Update Manatee County | |
|---|--|
| Lift Station RTU | Number of Pump Starts per Hour per Pump |
| WW-063 ⁽¹⁾ | 18.98 |
| WW-074 ⁽¹⁾ | 8.23 |
| WW-101 ⁽¹⁾ | 6.62 |
| WW-126 ⁽¹⁾ | 7.74 |
| WW-141 | 6.04 |
| WW-205 | 8.35 |
| WW-210 ⁽¹⁾ | 5.39 |
| WW-213 ⁽¹⁾ | 6.41 |
| WW-219 | 5.48 |
| WW-238 ⁽¹⁾ | 9.63 |
| WW-241 | 5.18 |
| WW-303 ⁽¹⁾ | 9.92 |
| WW-308 ⁽¹⁾ | 7.60 |
| WW-341 ⁽¹⁾ | 8.08 |
| WW-401 | 5.83 |
| WW-407 ⁽¹⁾ | 8.06 |
| WW-409 | 5.56 |

| Table 5.3 High Pump Starts in 2015 Wet Weather Scenario Southwest WWCS Master Plan Update Manatee County | |
|---|--|
| Lift Station RTU | Number of Pump Starts per Hour per Pump |
| WW-412 | 7.40 |
| WW-416 ⁽¹⁾ | 13.59 |
| WW-418 | 6.30 |
| WW-422 | 5.82 |
| WW-423 | 5.69 |
| WW-440 | 6.84 |
| Notes: | |
| (1) Lift stations with pumps that also experienced more than 5 start/stop cycles per hour in the 2015 LOS scenario. | |

Appendix H also summarizes the results of the evaluation of the performance criteria for pumping capacity (pump capacity equal to or greater than peak hourly flow with largest pump out of service) and wet well storage capacity (wet well volume equivalent to four times the pump capacity in gpm). Only 86 of the 194 existing lift stations met both criteria (pumping capacity and total wet well storage capacity) while 5 lift stations did not meet either criteria. There were 10 lift stations that exceeded their pumping capacity in the 2015 LOS scenario and 24 lift stations that exceeded their pumping capacity in the 2015 Wet Weather scenario (based on comparing the simulated peak hour flow to firm pump capacity). Many of the existing lift stations in the Southwest Service Area were designed and built under different performance criteria than currently used. These lift stations may require further evaluation to determine what, if any, changes are required in order to meet the current performance criteria. Although all future lift stations will be designed to meet both performance criteria, the County may want to consider revising the wet well volume criteria, as many of the County's existing lift stations (82 out of 194 included in the 2015 scenarios) do not meet this criteria. Because this information is highly dependent on the data provided (pump off and influent invert elevations), no improvements will be recommended be made based on the evaluation presented in Appendix H other than to verify actual elevation and pump capacity information as needed.

5.3.2.3 Gravity System

During the 2015 Wet Weather simulation, several manholes experienced overflows and some groups of gravity pipes were surcharged. The manhole ID, overflow duration, and total overflow volume over the 72-hour wet weather simulation are shown in Table 5.4.

| Table 5.4 2015 Wet Weather Manhole Overflow Summary Southwest WWCS Master Plan Update Manatee County | | | |
|---|---|--|--|
| Manhole ID⁽¹⁾ | Duration of Overflow (hours)⁽²⁾ | Total Overflow Volume (gallons) | Recommendation |
| 054MH001 | 9.8 | 57,398 | N/A ⁽³⁾ |
| 136MH004 | 0.8 | 147 | Increase pump capacity at lift station 6-A (RTU 136) |
| 136MH005 | 15.1 | 111,413 | |
| 136MH006 | 8.3 | 23,876 | |
| 137MH001 | 11.9 | 51,931 | N/A ⁽³⁾ |
| 141MH001 | 8.4 | 26,187 | N/A ⁽³⁾ |
| 457MH001 | 17.3 | 43,233 | Increase pump capacity at Whitfield Industrial Park 1 lift station (RTU 457) |
| Notes: | | | |
| (1) First three digits of Manhole ID correspond to downstream lift station RTU number. | | | |
| (2) Includes overflows occurring within the last 72-hours of the 96-hour simulation. | | | |
| (3) The upstream gravity system for this lift station was not modeled and, therefore, not evaluated (as discussed in Chapter 4). Model parameters will be adjusted in future scenarios to prevent simulated overflows and to ensure the entire wastewater flows at these locations are simulated in downstream pipes (and not lost due to overflows). | | | |

Gravity pipes with a maximum depth (d/D) greater than 80 percent for more than 10 percent of the simulation are reported in **Error! Reference source not found.** Table 5.5. Refer to Figure 5.2 for locations. Field verification of invert elevations and manhole/gravity pipe diameters is also recommended at the locations listed in Table 5.4 and Table 5.5.

| Table 5.5 2015 Wet Weather Gravity Main Surge Summary Southwest WWCS Master Plan Update Manatee County | | |
|---|--|---|
| Gravity Pipe IDs⁽¹⁾ | Duration at > 80% Full (hours)⁽²⁾ | Recommendation |
| GM-136-1 to GM-136-13 ⁽³⁾ | 24.1 - 30.2 | Increase pump capacity at lift station 6-A (RTU 136) |
| GM-203-3 to GM-203-25 | 7.3 - 15.4 | Extend MLS #5 force main to MLS 1-M (bypassing 24" gravity main on Cortez Road) |
| GM-203-52 to GM-203-54 | 25.9 - 36.3 | Upsize existing 8-inch gravity main to a 12-inch |
| GM-217-1 to GM-217-3 | 7.8 - 10.9 | Increase pump capacity at lift station 19-D (RTU 217) |

| Table 5.5 2015 Wet Weather Gravity Main Surge Summary Southwest WWCS Master Plan Update Manatee County | | |
|---|--|---|
| Gravity Pipe IDs⁽¹⁾ | Duration at > 80% Full (hours)⁽²⁾ | Recommendation |
| GM-241-1 to GM-241-8 | 9.9 - 60.1 | Upsize existing 15-inch and 18-inch gravity pipes to 20-inch and 24-inch, respectively |
| GM-302-11 to GM-302-12 | 7.6 - 10.8 | Confirm invert elevations and confirm discharge flow rate from the Desoto Mall lift station (RTU 305) force main, which discharges to this gravity system |
| GM-303-1 | 29.4 | Confirm pipe diameter and invert elevations |
| GM-408-35 to GM-408-37, GM-408-97 | 12.9 - 18.2 | Confirm invert elevations; upsize 18-inch segments of gravity main with 24-inch pipe. |
| GM-434-1, GM-434-18 to GM-434-19, and GM-434-35 to GM-434-39 | 11.0 - 38.3 | No action. This surcharging is eliminated once the pumps are replaced at lift station RTU 457. |
| GM-437-1 to GM-437-4 | 8.7 - 11.3 | Increase pump capacity at the MacArthur and Meadowbrook lift station (RTU 437) |
| GM-457-1 to GM-457-3 ⁽³⁾ | 41.4 - 50.6 | Increase pump capacity at Whitfield Industrial Park 1 lift station (RTU 457) |
| Notes: | | |
| 1) Gravity pipe ID corresponds to lift station RTU number. | | |
| 2) Duration (hours) that gravity main depths are above 80 percent of total diameter throughout the last 72-hours of the 96-hour model simulation. | | |
| 3) Associated with a manhole overflow (refer to Table 5.4). | | |

5.3.3 Areas Not Meeting Performance Criteria

Based on the 2015 LOS and Wet Weather modeling results, the most critical areas of the pressurized system not meeting the performance criteria (termed "deficiencies" in this document) have been previously identified in the County CIP (FY 2015-2019) and are either under design or scheduled for construction. The following sections summarize the existing deficiencies.

5.3.3.1 Force Mains

As shown in Figure 5.1 and as described in Section 5.3.1, the major force mains connecting the western basins (MLSs 1-M, 1-D, and #5) to the system are currently operating with a maximum velocity less than the minimum scouring velocity in the 2015 LOS scenario (2 FPS). During wet weather, the 24-inch segment of the MLS 1-D force main still does not reach 2 FPS.

Conversely, the routing of the flow from the eastern basins (MLS 12-A, 13-A, and 27-A) is hydraulically challenged by the limited capacity of the 30-inch force main east of SWWRF, as shown in Figure 5.2. This is expected to be resolved by 2017, as construction is underway to replace the existing 30-inch force main with a 42-inch pipe.

The existing influent force main to the SWWRF headworks is also an important element of the collection system that is not currently meeting the County's performance criteria. Replacement projects for all the mentioned force main trunks are already included in the adopted County FY 2015-2019 CIP. The upsize of the headworks influent pipe is assumed to be included as part of the new headworks project, expected to be completed in 2018.

The only new recommended force main improvement is to upsize the existing 10-inch discharge force main at the Bayshore Yacht Basin lift station (RTU 101). Improvements at this lift station are discussed in Section 5.3.3.4 below.

All force main recommendations are listed in Table 5.2, including locations where it is recommended to confirm model input data. Low velocity force mains are further evaluated under future conditions (see Chapter 6). If deficiencies persist throughout the planning period, recommendations for corrective action will be included to avoid high operation and maintenance costs associated with pigging and cleaning.

5.3.3.2 Major Gravity Mains

Deficiencies in major gravity mains are identified by manhole overflows and/or surcharged gravity mains. Manhole overflows occurred upstream of lift station RTUs 136, 141, and 457 during the wet weather scenario. The gravity main along Cortez Road, connecting Anna Maria Island (MLS #5) and other smaller basins to MLS 1-M (RTU 203) was surcharged during the wet weather scenario. Surcharging was also observed upstream of MLS 13-A (RTU 408) and 36-A (RTU 241). The deficient gravity portions (1,350 and 1,250 linear feet, respectively) connect 54,390 linear feet (10.3 miles) and 6,770 linear feet (1.28 miles) of force main, respectively, to MLS 13-A and Lift Station 36-A. These deficiencies are observed mostly during wet weather conditions. The gravity system deficiencies and recommended improvements are summarized in Table 5.4 (Manhole Overflow Summary) and Table 5.5 (Gravity Main Surge Summary).

5.3.3.3 Wet Wells

Lift stations where one or more of the performance criteria such as pump starts, pump utilization or flow retention time, pumping capacity, and wet well storage capacity are currently not met are summarized in Appendix H. Deficiencies that result in a higher operating cost to the County are considered to be of higher importance. As such, the pump starts criterion (greater than five pump start/stop cycles per hour) is given more relevance, has been represented in maps, and efforts to resolve sustained deficiencies are proposed in Chapter 6. Figure 5.1 and Figure 5.2 show areas where this deficiency occurs. While some may be fixed by adjusting operational controls and set points as described in

Section 5.3.2.2 and per recommendations in Appendix H, others may require evaluation under future flow conditions to assess the need of upgrading the pumps.

5.3.3.4 Bayshore Yacht Club Lift Station (RTU 101) Deficiencies

The Bayshore Yacht Club lift station (RTU 101) was specifically identified by the County as a lift station that experiences capacity issues during wet weather events. During a recent storm event (September 2016), it was noted by County staff that the three pumps at this lift station operated continuously for several days and vac trucks were used to help pump down the wet well to prevent overflows. Evaluation of the 2015 scenarios indicate that this lift station and force main do not have sufficient capacity. During the wet weather scenario, this force main had a maximum velocity of 8.5 FPS and exceeded 6 FPS for 26.7 hours (37 percent of the model simulation duration).

The County has plans to relocate this lift station and convert it to a master lift station with VFD pumps. As part of this future project, the County also intends to increase the wet well size, pump capacity, and force main diameter. Based on County input and evaluation of the 2015 scenarios, it is recommended that the County proceed with this project. Because the SCADA derived flow was deemed unreliable during calibration, it is recommended the County install a temporary or permanent flowmeter at this location to more accurately measure average and wet weather flows so the new lift station can be sized appropriately.

5.3.4 Recommended Improvements

As mentioned above, the deficiencies noted in large force main trunks discharging to the SWWRF are expected to be resolved once County projects already in the planning or design phase are completed, such as:

- The 30-inch 27-A MLS force main from 51st Street West to the SWWRF, that will be replaced with a 42-inch pipe (CIP project ID 6082980), and
- Several MLS force mains that will be replaced and/or rehabilitated (CIP project IDs WW00975, WW00976, 6035781, 6085780, WW00978, and WW00974) (see Table 5.6).

Replacement of the headworks influent pipe is recommended to be completed as part of the headworks project scheduled to be completed in 2018.

Table 5.6 summarizes the recommendations to correct existing deficiencies based on evaluation of the 2015 scenarios. The pipe diameters shown in Table 5.6 reflect sizing that will achieve the County's performance criteria through 2035. Projects already in the planning or design phase (current CIP projects) were evaluated under future conditions to determine if any changes to the CIP were recommended. Changes to existing CIP projects are discussed in Chapter 6.

| Table 5.6 Summary of Recommended Improvements Southwest WWCS Master Plan Update Manatee County | |
|---|--|
| Description | Recommendation |
| Projects Already in the Planning or Design Phase⁽¹⁾ | |
| 27-A MLS (RTU 138) force main from 51 st Street West to the SWWRF ⁽²⁾ | No changes to the current CIP project are recommended. |
| Force main downstream of Lift Station 23-A (RTU 410) ⁽²⁾ | Recommended change to the current CIP project is discussed in Chapter 6. |
| MLS 12-A (RTU 139) force main | Part of CIP ID WW00975. Recommended change to the current CIP project is discussed in Chapter 6. |
| MLS 1-D (RTU 237) force main | Complete CIP ID 6035781 and part of CIP ID 6085780. Recommended change to CIP is discussed in Chapter 6. |
| MLS 1-M (RTU 203) force main | Part of CIP ID 6085780. Recommended change to the current CIP project is discussed in Chapter 6. |
| MLS #5 (RTU 071) force main | Part of CIP ID WW00974. Recommended change to CIP is discussed in Chapter 6. |
| Headworks influent force main | Upsize force main as part of the headworks replacement project scheduled for 2018. |
| New Projects Identified Based on Master Plan 2015 Evaluation⁽³⁾⁽⁴⁾⁽⁵⁾ | |
| Bayshore Yacht Basin lift station (RTU 101) | Upsize force main to 16-inch diameter; upsize wet well and pumps. ⁽⁶⁾ |
| Manhole overflows and surcharged gravity mains upstream of lift station RTUs 136 and 457 | Increase pump capacity at lift station RTUs 136 and 457 |
| Surcharged gravity main on Cortez Road and manhole overflow upstream of lift station RTU 141 | Extend new MLS #5 (RTU 071) force main along Cortez Road to the MLS 1-M wet well (bypassing the 24-inch gravity main on Cortez Road). The County has indicated that this will be completed at the same time the force main for the new Peninsula Bay development is constructed (by 2020). |
| Surcharged gravity main upstream of MLS 13-A (RTU 408) | Upsize existing 18-inch gravity main with 24-inch |
| Surcharged gravity main upstream of MLS 1-M (RTU 203), from the north | Upsize existing 8-inch gravity main with 12-inch (this is recommended to be completed by 2035) |
| Surcharged gravity main upstream of lift station RTU 241 | Upsize existing 15-inch and 18-inch diameter gravity pipe with 21-inch and 24-inch, respectively |

| Table 5.6 Summary of Recommended Improvements Southwest WWCS Master Plan Update Manatee County | |
|---|---|
| Description | Recommendation |
| Surcharged gravity mains upstream of lift station RTUs 217 and 437 | Increase pump capacity at lift station RTUs 217 and 439 |
| <p><u>Notes:</u></p> <p>(1) Existing CIP projects are recommended to be completed within the timeline shown in the CIP, unless otherwise noted.</p> <p>(2) Expenditures committed by FY 2015 in the adopted CIP.</p> <p>(3) Does not include locations where it is recommended to verify model input data. Refer to Table 5.2, Table 5.4, and Table 5.5 for complete list of recommendations based on 2015 Wet Weather results.</p> <p>(4) Recommended pipe diameters are based on sizing requirements needed to serve through the 2035 population.</p> <p>(5) Due to the amount of time it takes to complete a new CIP project through planning, design, and construction, new recommendations are assumed to be completed by 2025, unless otherwise noted. Because these improvements will not be included until the 2025 scenarios, they will also show as deficient in the 2020 scenarios.</p> <p>(6) County should install temporary flowmeter to determine actual flows (average and wet weather) to confirm appropriate sizing. Diameters used in future scenarios were based on information provided by County.</p> | |

5.4 SUMMARY AND RECOMMENDATIONS

Based on the 2015 LOS and Wet Weather evaluations, the majority of modeled assets in the Southwest Service Area meet the performance requirements set forth in Chapter 3. However, deficiencies have been identified at major transmission force main trunks, major connecting gravity mains, smaller gravity collectors, and at some lift stations. Fortunately, improvement projects for the most critical of these deficiencies have been previously identified and programmed into the County CIP (FY 2015-2019), and these projects are currently under design or scheduled for construction. Given that all other major deficiencies have the potential to either be carried through to future planning years or be resolved under future flow conditions, further evaluations are required in order to propose the most suitable corrective actions. These evaluations and resulting recommendations are described in Chapter 6.

6.1 INTRODUCTION

An evaluation of the future scenarios using the calibrated model was completed in order to assess the performance of the existing and future infrastructure under increased wastewater loads. Performance criteria, described in Chapter 3, were selected based on industry standards, regulatory requirements, and the County's utility design standards. The result of this analysis is a set of recommendations that identifies the improvements in each planning period (2020, 2025, 2035, planned development, and build-out). A CIP with timing and costs of improvements within the 20-year planning period was also developed as part of the Southwest WWCS Master Plan Update and is presented in Chapter 7.

The primary wastewater collection system issues the County will need to address in the Southwest Service Area in the near future include: 1) replacement of the discharge force mains of all master lift stations; 2) upsizing the 30-inch force main along 53rd Avenue West to a 42-inch pipe; and 3) extending the 20-inch MLS #5 (RTU 071) force main along Cortez Road all the way to MLS 1-M (RTU 203) to alleviate capacity limitations in the 24-inch gravity pipe along Cortez Road, upstream of MLS 1-M. There are several existing CIP projects underway to address the first two issues, and the County has indicated that the MLS #5 force main extension will be completed at the same time as the force main for the new Peninsula Bay development. As discussed in Chapter 5, additional existing hydraulic challenges have been identified throughout the service area. Since they are not considered as critical as the projects described above and because of the time it takes for a project to go through planning, design, and construction, all other CIP projects are assumed to be completed by 2025.

Chapter 6 presents the County's Southwest WWCS Master Plan. The remainder of the chapter is divided into the following sections:

- Section 6.2 - Future Collection System Assumptions: Outlines the assumptions used in adding future infrastructure to the model.
- Section 6.3 - 5-Year (2020) Scenario: Describes the infrastructure needed to correct deficiencies in the existing system and for new growth through the 2020 timeframe.
- Section 6.4 - 10-Year (2025) Scenario: Describes the infrastructure needed to correct deficiencies in the existing system, which were not already programmed into the current CIP, and for new growth through the 2025 timeframe.
- Section 6.5 - 20-Year (2035) Scenario: Describes the infrastructure needed to correct deficiencies in the existing system and for new growth through the 2035 timeframe.

- Section 6.6 - Planned Development Scenario: Describes the infrastructure required if all planned developments are fully developed and connected to the County's infrastructure.
- Section 6.7 - Build-Out Scenario: Describes the infrastructure required at build-out if all undeveloped lands and septic parcels are connected to the County's wastewater infrastructure.
- Section 6.8 - Water Reclamation Facility Capacity: Evaluates the capacity at the SWWRF and the necessary timing of future expansions.
- Section 6.9 - Summary: Summarizes future infrastructure needed to meet selected performance criteria and serve future growth.

6.2 FUTURE COLLECTION SYSTEM ASSUMPTIONS

The County has several CIP projects in progress, which are planned to be completed within the next 5 years. The County's Wastewater 2015-2019 CIP is provided in Appendix I. The 2015-2019 CIP projects have been incorporated into the 2020 scenario of the model.

For the 2020, 2025, and 2035 scenarios, new lift stations, piping, and corresponding sewer sheds were added to the model to serve the planned developments, which were discussed in Chapter 3 (Table 3.2 and shown in Figure 3.4). For the build-out scenario, lift stations envisioned by the County along with their corresponding sewer sheds were included in the model.

The following assumptions were made for planning and sizing future infrastructure:

1. Populations were assigned to future sewer sheds based on the methodology outlined in Chapter 3. All future population through 2035 was assumed to occur only within the planned developments. The projected TAZ populations (through 2035) were distributed among the planned developments. The population in the planned development scenario assumes that all planned developments are fully constructed. The County build-out population includes the existing population, future growth among the planned developments (through the planned development scenario), connection of all other undeveloped parcels, and the parcels on septic tanks within the Southwest Service Area.
2. If a force main is undersized or needs additional capacity after 2035, a parallel pipe was added to meet capacity needs. County preference was to show new pipelines as parallel instead of upsizing existing force mains for clarity on the planned development and build-out maps. However, the projects should be further evaluated in the future to determine whether a parallel pipeline or an upsized single pipeline would be most beneficial. Some of the existing pipelines may be nearing the end of their useful life after 2035 and therefore upsizing may be the preferred option.

3. All evaluations and recommendations for lift stations and force mains are based on size and capacity of the infrastructure only. Identification of infrastructure replacement needed due to age or condition was not considered in the Master Plan Update.
4. The assumptions outlined in Chapter 4 regarding new infrastructure were applied to future lift stations and piping, unless detailed construction plans were provided.
5. Future lift stations were located at the approximate center of each future sewer shed. Actual locations should be evaluated during the design of each individual lift station. Built-out areas were assumed to have one lift station for hydraulic modeling purposes. Once these areas are developed, multiple lift stations will most likely be required, depending on the rate and location of development.
6. The placement of future force mains was aligned with existing roadways or future thoroughfares (provided by the County as a GIS shapefile), when possible. This will allow pipeline construction to occur within road right-of-way and utility easements, when possible. The exact alignment of each force main and location of each lift station should be evaluated based on planned development needs and as actual development occurs. Slight changes in force main alignment should not significantly impact model results or master planning recommendations.
7. New pipes less than 30 inches in diameter were assumed to be PVC and new pipes with diameter 30 inches and greater were assumed to be DIP, unless scheduled differently in the current County CIP. New force mains were assumed to have a C-factor of 120 for master planning purposes. For existing force mains, the C-factors determined during model calibration were used throughout all future scenarios, for as long as the pipe remains active.
8. Velocity in force mains in exceedance of the performance criteria of 6 fps for a duration shorter than 10 percent of the total EPS timeframe in the Wet Weather scenarios was not considered problematic and therefore was not addressed as a deficiency.

The following sections discuss the analysis of the 2020, 2025, 2035, planned development, and build-out scenarios.

6.3 2020 SCENARIO

The 2020 scenario was developed using the methodology discussed in Chapters 3 and 4. Estimated growth was based on planned developments and the County's TAZ population projections. Although new infrastructure will be constructed to serve the planned developments within the next 5 years, the future infrastructure needed for 2020 was sized to meet 2035 flow projections.

6.3.1 2020 Wastewater Infrastructure

The infrastructure and new planned developments included in the 2020 scenario are shown in Figure 6.1. Figure 6.2 shows the model infrastructure included in the 2020 scenario, color coded by diameter. Completed CIP projects (from the 2015-2019 CIP), and new pipes serving planned developments are identified in Figure 6.1 and Figure 6.2. Pipes that were inactivated (placed out of service) in the 2020 scenario are also shown in Figure 6.1.

CIP projects scheduled for design and construction between 2016 and 2019 were evaluated for hydraulic performance under 2020 and Build-Out LOS and Wet Weather conditions. When the planned CIP did not meet performance criteria for more than 10 percent of the simulation duration, recommendations for modifications to the CIP were presented to the County and included in the model by 2020. When the planned CIP project met the performance criteria, they were assumed to be complete and were included in the 2020 scenario. CIP infrastructure added in the 2020 scenarios includes:

- MLS #5 (RTU 071) Force Main Rehabilitation: Replacement of the existing 18-inch DIP force main with approximately 8,800 linear feet of 16-inch diameter HDPE pipe and approximately 4,800 linear feet of 18-inch diameter HDPE pipe.
- MLS 1-M (RTU 203) Force Main Rehabilitation: Replacement and reroute of approximately 8,700 linear feet of 24-inch and 3,200 linear feet of 30-inch DIP force main with approximately 12,900 linear feet of 27-inch HDPE¹, 800 linear feet of 20-inch HDPE, 1,350 linear feet of 24-inch HDPE, and 1,050 linear feet of 36-inch HDPE force main. Because of the reroute, the 800 and 1,350 linear feet segments (2,150 linear feet total) would no longer belong to the MLS 1-M discharge force main and will rather become the continuation of the MLS 1-D discharge force main. The 1,050 linear foot segment, the last in the alignment, would be part of the discharge of both the MLS 1-M and MLS 1-D force mains into the SWWRF.
- MLS 1-D (RTU 273) Force Main Rehabilitation: Replacement of up to 12,000 linear feet of 20-inch ductile iron pipe force main with 20-inch HDPE force main.
- MLS 12-A (RTU 139) Force Main Rehabilitation: Replacement of approximately 10,300 linear feet of 20-inch DIP with approximately 3,400 linear feet of 20-inch and approximately 6,900 linear feet of 24-inch HDPE force main.
- MLS 13-A (RTU 408) Force Main Rehabilitation: Replacement of approximately 13,000 linear feet of 24-inch DIP force main with 27-inch HDPE force main.
- MLS 27-A (RTU 138) Force Main Rehabilitation: Replacement of approximately 3,200 linear feet of 20-inch DIP force main with 24-inch HDPE force main¹.

¹ As planned in the County CIP

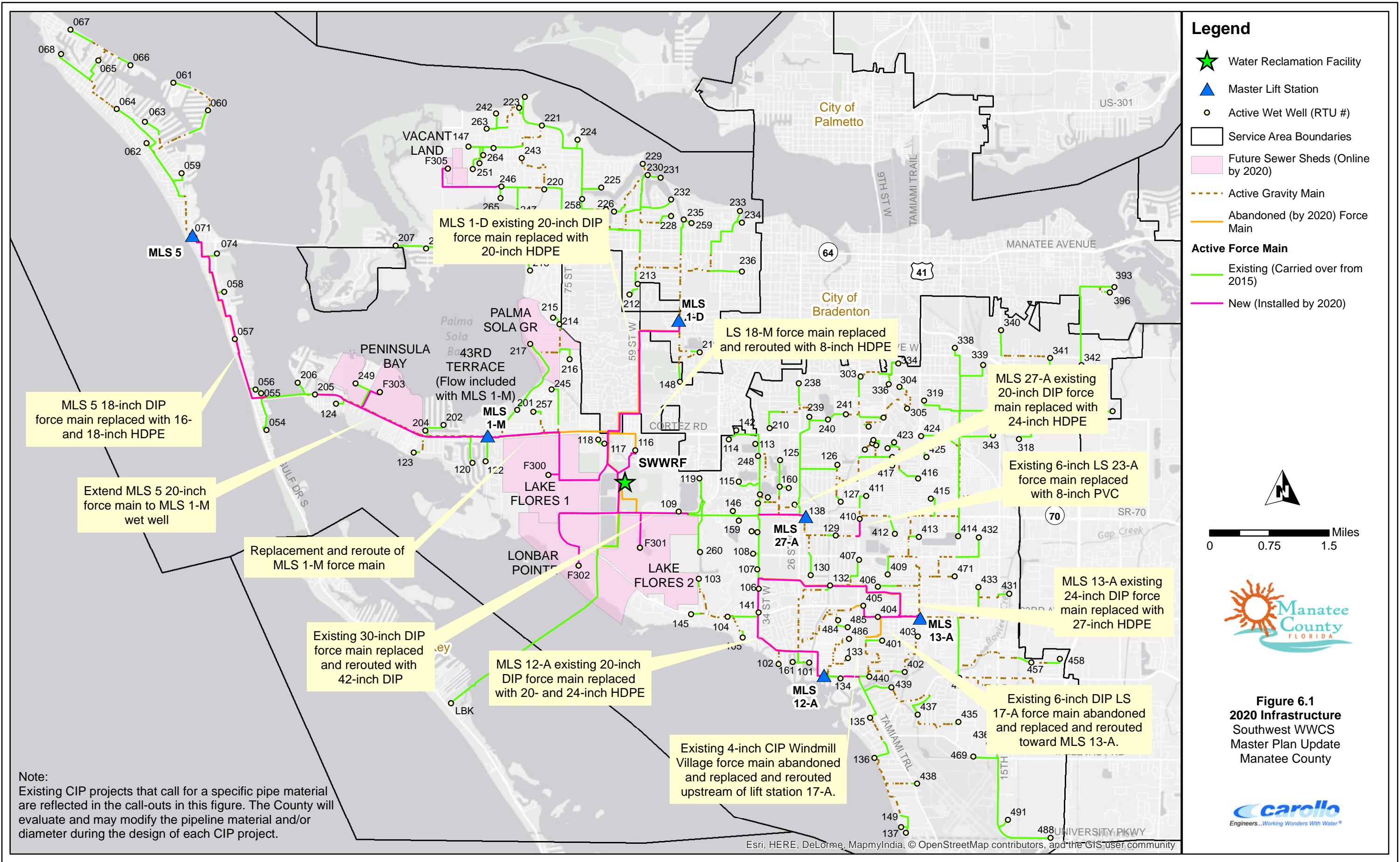

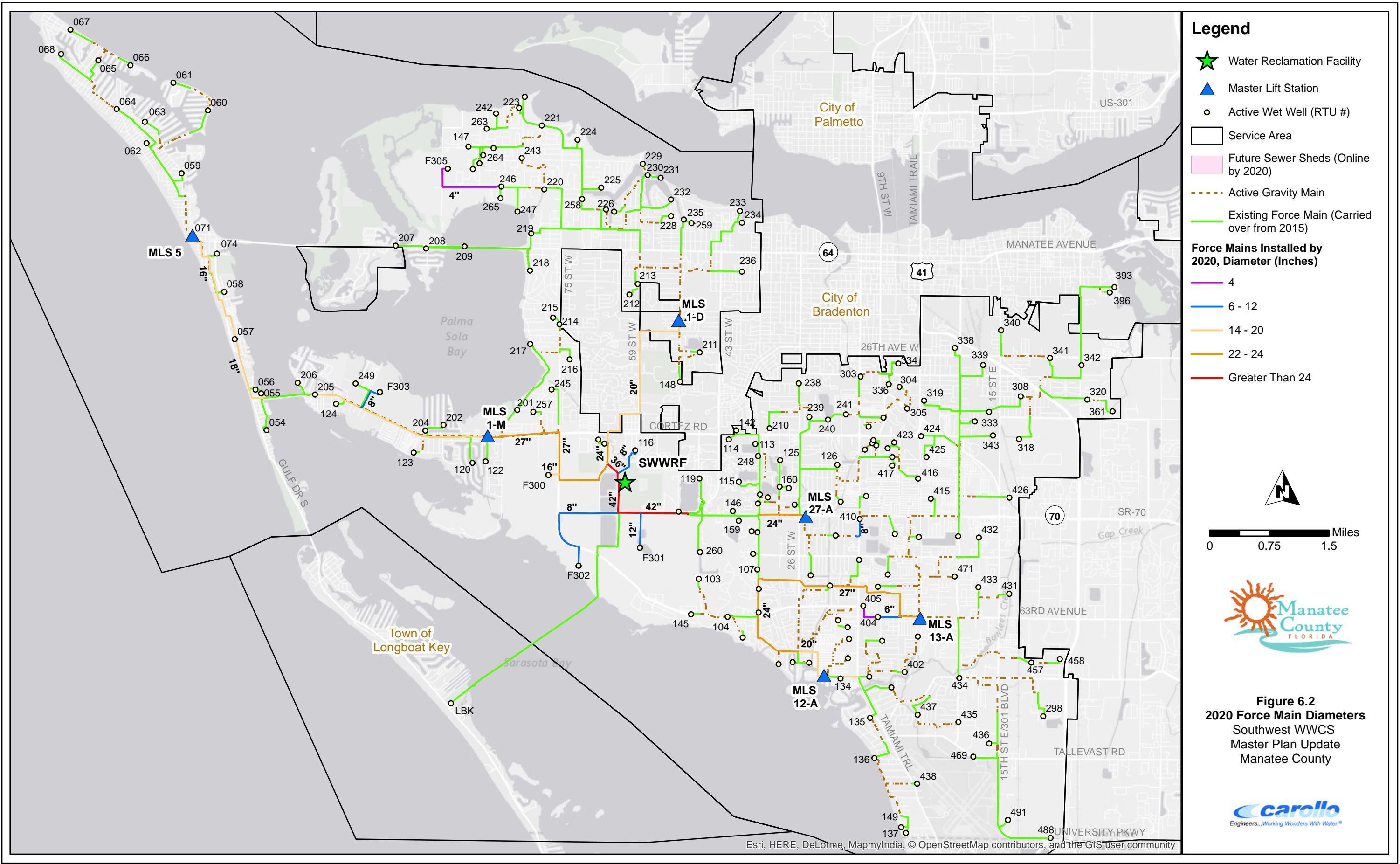

- Legend**
- Water Reclamation Facility
 - Master Lift Station
 - Active Wet Well (RTU #)
 - Service Area
 - Future Sewer Sheds (Online by 2020)
 - Active Gravity Main
 - Existing Force Main (Carried over from 2015)
- Force Mains Installed by 2020, Diameter (Inches)**
- 4
 - 6 - 12
 - 14 - 20
 - 22 - 24
 - Greater Than 24

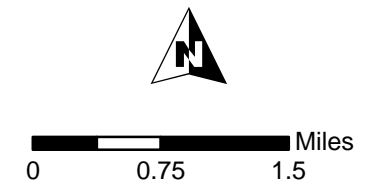

Figure 6.2
2020 Force Main Diameters
 Southwest WWCS
 Master Plan Update
 Manatee County



Esri, HERE, DeLorme, MapmyIndia, © OpenStreetMap contributors, and the GIS user community

- Force Main 27A - 53rd Avenue West from 43rd Street West to 75th Street West: Replacement of 30-inch DIP with 42-inch DIP.
- Lift Station 18-M (RTU 116) Rehabilitation: Replacement and reroute of approximately 3,000 linear feet of 6-inch DIP force main with approximately 2,140 linear feet of 8-inch HDPE force main.
- Lift Station 17-A (RTU 404) Force Main Reroute and Rehabilitation: Abandonment of 3,500 linear feet of 6-inch DIP and reroute of the lift station discharge towards the gravity tributary of MLS 13-A (RTU 408) using 1,600 linear feet of 6-inch PVC.
- Fiddler's Green Lift Station (RTU 250) Pumps Replacement: Pump replacement and force main reconnection¹.
- Lift Station 23-A (RTU 410) Force Main Rehabilitation: Replacement of approximately 1,300 linear feet of 6-inch DIP with 8-inch HDPE and PVC. While the existing County CIP project calls for this project to be replaced with 6-inch pipe (in-kind replacement), modeling analyses show that the force main experiences high velocities in future scenarios. Therefore, an upsize to 8-inch force main is recommended. The County has recently stated that while the CIP project description calls for 6-inch pipe, the project has been revised to be comprised of 8-inch pipe.
- 51st Street Gravity Main Sewer Replacement: In-kind replacement of approximately 3,300 linear feet of existing 30-inch gravity force main with 30-inch PVC. Replace 11 manhole locations along the route from 8th Avenue to MLS 1-D, including reconnecting all laterals and associated appurtenances within the collection system.
- Lift Station 31-A (RTU 126) Force Main Renewal: In-kind replacement up to 2,750 linear feet of 14-inch cast iron pipe with PVC.
- Spanish Park Lift Station (RTU 213) Force Main Renewal: In-kind replacement of 900 linear feet of 6-inch DIP with PVC.
- Windmill Village Lift Station (RTU 405) Force Main Renewal: Abandonment of the existing 4-inch force main and reroute to discharge upstream of the Lift Station 17-A (RTU 404).

Evaluation of the CIP projects as planned by the County and the resulting recommendations reflected in the model are included in Appendix K.

In addition to the CIP projects listed above, the following new developments and associated infrastructure were brought online in 2020:

- Lake Flores (split into two new lift stations: F300 and F301)
- Longbar Pointe (Lift Station F302)
- Peninsula Bay (Lift Station F303)

- Three vacant lots (served by Lift Station F305)
- Palma Sola Grande (included with Lift Station 19-D (RTU 217))
- 43rd Terrace (included with MLS 1-M (RTU 203))

It also was assumed that the MLS #5 (RTU 071) force main extension to MLS 1-M (RTU 203) is completed at the same time as the Peninsula Bay (F303) force main. It is anticipated that a portion of the MLS #5 force main extension to MLS 1-M will be funded by developers and therefore this project was included with the 2020 scenarios. Once the MLS #5 force main extension is complete, the existing 24-inch gravity main on Cortez Road will have sufficient capacity for the Peninsula Bay development. Because it is unknown how this development will tie into the existing infrastructure, it was modeled as a single lift station and force main that connects to the existing 24-inch gravity main on Cortez Road. Alternatively, a new gravity main may be installed to connect the development to the existing gravity main.

Table 6.1 shows the force mains and lift stations added in the 2020 scenario (as shown in Figure 6.1 and Figure 6.2).

| Table 6.1 Wastewater Infrastructure Added in 2020 Scenario Southwest WWCS Master Plan Update Manatee County | | | | |
|--|--------------------------------|---------------------------------|--------------------------------|---------------------------------|
| Force Main Diameter (inches) | Planned Developments | | CIP Projects | |
| | Length Added (Feet) | Length Added (Miles) | Length Added (Feet) | Length Added (Miles) |
| 4 | 5,523 | 1.05 | | |
| 6 | | | 1,598 | 0.30 |
| 8 | 8,225 | 1.56 | 3,762 | 0.71 |
| 12 | 845 | 0.16 | | |
| 16 | 721 | 0.14 | 8,781 | 1.66 |
| 18 | | | 4,776 | 0.90 |
| 20 | | | 26,555 | 3.11 |
| 24 | | | 11,447 | 2.17 |
| 27 | | | 25,360 | 4.80 |
| 42 | | | 6,870 | 1.30 |
| Total Length | 15,314 | 2.90 | 89,149 | 14.97 |
| New Lift Stations | 5 | | | |
| Existing Lift Stations with New Pumps | 1 (RTU 250) | | | |

6.3.2 2020 LOS Analysis

An EPS LOS scenario was completed for the 2020 planning period. Figure 6.3 shows the force main velocity, gravity main flow depth, and pump cycles per hour. As shown, several force mains do not reach 2 fps at LOS flow conditions.

Of the 200 modeled lift stations in 2020, eight exceeded their rated capacity under LOS conditions. During peak rainfall events, it is possible to operate lift stations manually, or override the controls so that both pumps operate at all times. However, the minimum expectation for a lift station is that the pumps are capable of performing under average LOS conditions. The lift stations where the peak hour flow exceeded the firm pump capacity for more than 10 percent of the simulation are listed in Table 6.2. The County is planning to upsize the pumps at the Bayshore Yacht Basin Lift Station (RTU 101). The pumps at the Whitfield Industrial Park 1 Lift Station (RTU 457) were previously identified in Chapter 5 as needing to be upsized to prevent surcharging and overflows in the upstream gravity system. It is recommended that the County verify the actual pump curves and influent flows at the remaining lift stations identified in Table 6.2 to determine if pump replacements are needed. To be conservative, a CIP project to replace these pumps has been included in Chapter 7 so that the County has funds set aside in case pump replacements are necessary.

| Table 6.2 Lift Station Firm Capacity Exceedances in 2020 LOS Scenario Southwest WWCS Master Plan Update Manatee County | | |
|---|---|--|
| Wet Well ID⁽¹⁾ | Capacity Exceeded by (%)⁽²⁾ | Duration of Capacity Exceedance (hours)⁽³⁾ |
| WW-101 | 134% | 14 |
| WW-108 ⁽⁴⁾ | 7% | 41 |
| WW-116 | 30% | 10 |
| WW-141 | 27% | 14 |
| WW-258 ⁽⁵⁾ | 14% | 30 |
| WW-319 ⁽⁵⁾ | 11% | 34 |
| WW-342 | 282% | 36 |
| WW-457 | 4% | 45 |
| Notes: | | |
| (1) Wet well ID corresponds to lift station RTU number. | | |
| (2) Compares the peak hour flow simulated in the 2020 LOS scenario to the firm capacity (with largest pump out of service). | | |
| (3) Duration (hours) that the firm capacity of the lift station is exceeded throughout the 48-hour LOS model simulation. | | |
| (4) It is suspected that the pump rated capacity provided by the County is incorrect because it is not consistent with the provided pump curve. This pump change recommendation should be reassessed upon confirmation of rated capacity. | | |
| (5) Only the design operating point was provided for this lift station. No pump curve was available. | | |

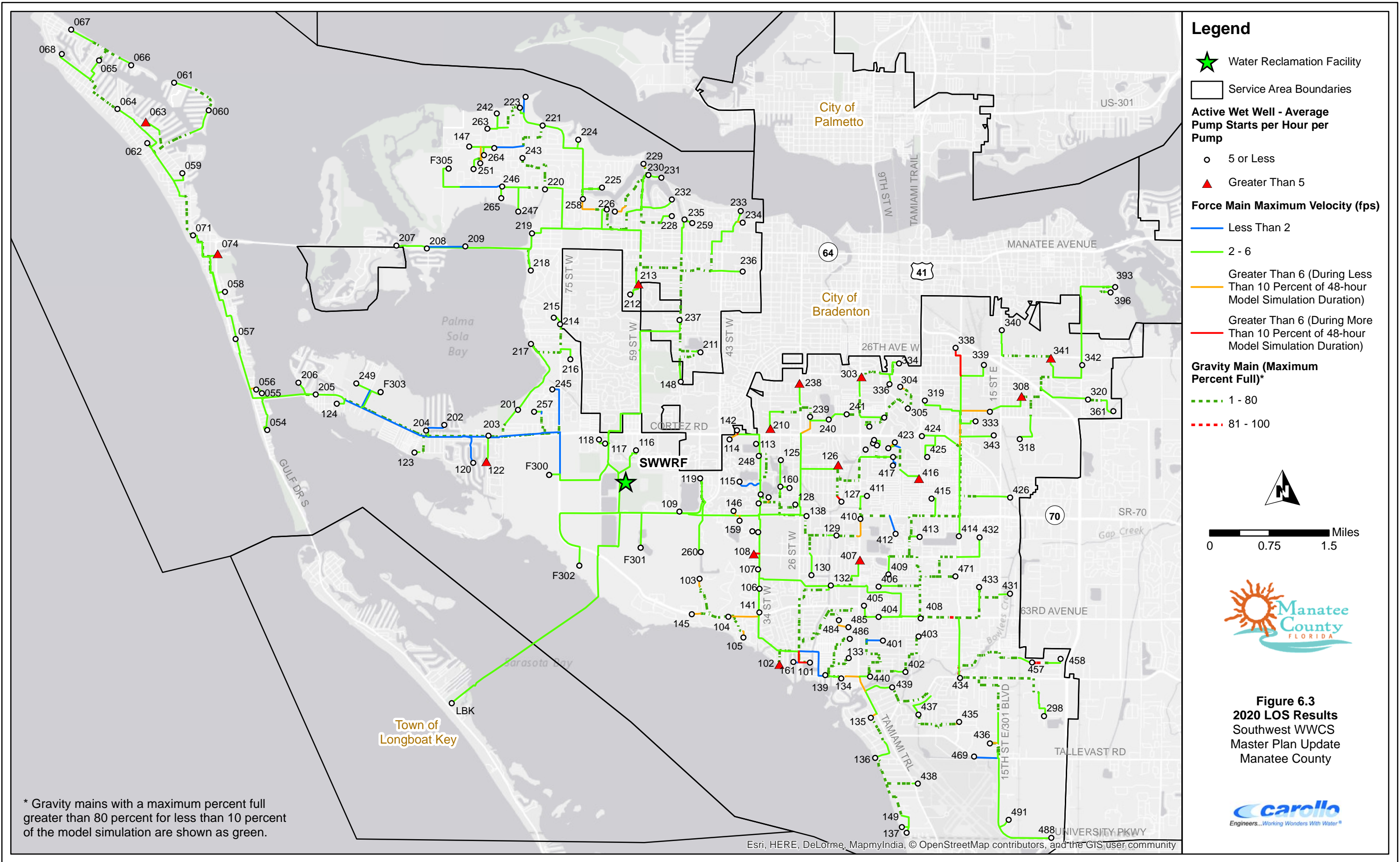

- Legend**
- Water Reclamation Facility
 - Service Area Boundaries
 - Active Wet Well - Average Pump Starts per Hour per Pump**
 - 5 or Less
 - Greater Than 5
 - Force Main Maximum Velocity (fps)**
 - Less Than 2
 - 2 - 6
 - Greater Than 6 (During Less Than 10 Percent of 48-hour Model Simulation Duration)
 - Greater Than 6 (During More Than 10 Percent of 48-hour Model Simulation Duration)
 - Gravity Main (Maximum Percent Full)***
 - 1 - 80
 - 81 - 100

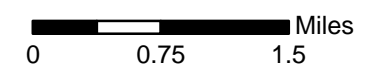

Figure 6.3
2020 LOS Results
 Southwest WWCS
 Master Plan Update
 Manatee County



* Gravity mains with a maximum percent full greater than 80 percent for less than 10 percent of the model simulation are shown as green.

6.3.3 2020 Wet Weather Analysis

The 2020 Wet Weather scenario, based on flows seen during the 3-day storm event in September 2013, was evaluated to determine the system's ability to operate and meet performance criteria under maximum flow conditions. Figure 6.4 shows the results from the 2020 Wet Weather simulation.

Important observations from the results are described in the following sections.

6.3.3.1 Force Mains

With the completion of the current CIP projects listed in Section 6.3.1, the velocity in the 12-A force main and SWWRF influent pipe now falls between 2 and 6 fps. The rest of the high velocity force mains identified in Chapter 5 (see Table 5.2) still have high velocities in the 2020 Wet Weather scenario. The high velocity in the Bayshore Yacht Basin (RTU 101) force main is expected to be corrected once the existing 10-inch force main is upsized to a 16-inch. Because the recommended action was to verify model input data for the remaining force mains, they will continue to be high in the rest of the future scenarios. Refer to Table 5.2 for recommended actions for these force mains.

Two new high velocity force mains were identified in the 2020 Wet Weather scenario: the discharge force mains at the Lake Bridge Lift Station (RTU 108) and IMG/Bollettieri Village Lift Station (RTU 150). It is suspected that these new deficiencies are related to changes in pressure due to the completed CIP projects. Model input data (existing pump curve, operational controls, and node elevations) should be verified at these locations to determine if new pumps are required.

In 2020, there were also force mains identified with peak velocities lower than the minimum scouring velocity of 2 fps, as shown in Figure 6.4. The 4-inch force main that conveys wastewater from the future lift station F305 to the existing Azalea Park Lift Station (RTU 246), also shows a velocity lower than 2 fps in the 2020 Wet Weather scenario after construction of the new development. This velocity does not meet performance criteria. But since the pipe diameter is the minimum listed under the performance criteria in Chapter 3, no change to the currently planned diameter is proposed.

Low velocity force mains in the existing scenario were evaluated under future conditions to determine if the deficiency persisted or would be corrected in the future. The discharge force mains for the following lift stations were shown to never reach the minimum velocity (2 fps) through the Build-out Wet Weather scenario:

- Wildwood Springs 2 (RTU 115)
- Coral Shores East 4 (RTU 122)
- Desoto Memorial Park (RTU 222)
- Broome Park (RTU 245)

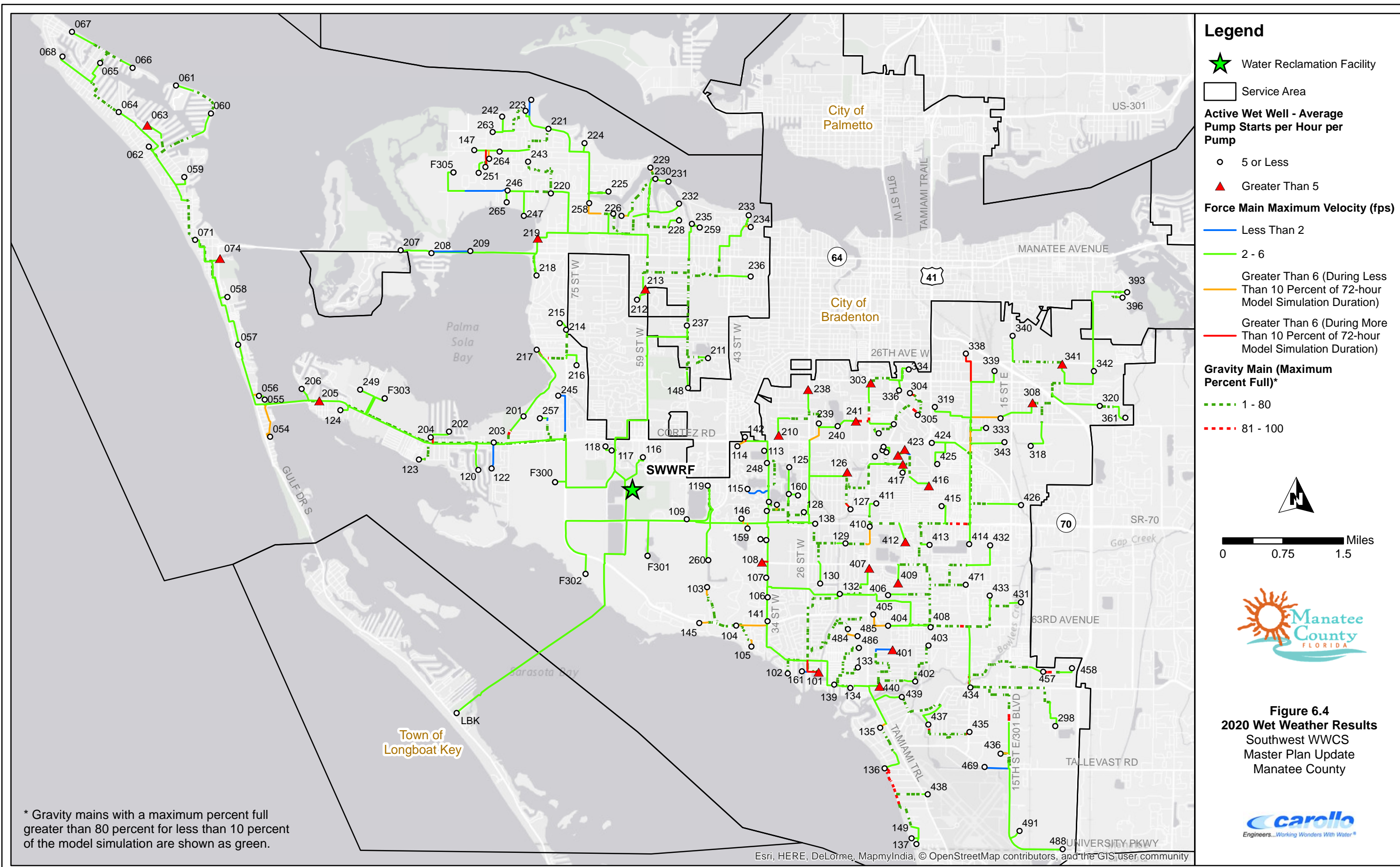

- Legend**
- Water Reclamation Facility
 - Service Area
 - Active Wet Well - Average Pump Starts per Hour per Pump**
 - 5 or Less
 - Greater Than 5
 - Force Main Maximum Velocity (fps)**
 - Less Than 2
 - 2 - 6
 - Greater Than 6 (During Less Than 10 Percent of 72-hour Model Simulation Duration)
 - Greater Than 6 (During More Than 10 Percent of 72-hour Model Simulation Duration)
 - Gravity Main (Maximum Percent Full)***
 - 1 - 80
 - 81 - 100

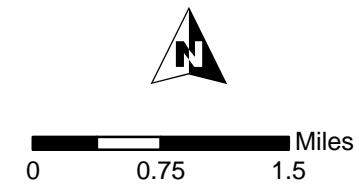

Figure 6.4
2020 Wet Weather Results
 Southwest WWC
 Master Plan Update
 Manatee County



* Gravity mains with a maximum percent full greater than 80 percent for less than 10 percent of the model simulation are shown as green.

While the low velocity force mains can cause sediment build-up and more intensive maintenance, these are considered not as critical as high velocity force mains. There are no recommended improvements for low velocity force mains, however, the County should evaluate these force mains at the end of their useful life to determine if they should be downsized. The County should also verify the influent and force main flows at these locations and implement a maintenance program (pigging/cleaning) if the actual velocity is less than 2 fps.

6.3.3.2 Lift Stations

As shown in Figure 6.4, there are 23 lift stations with more than 5 pump starts per hour per pump. Because the pump starts are highly dependent on pump curve and operational control data, no recommendations were made for high pump starts. Where possible, pump operating controls were adjusted to bring the average pump starts below 5 per hour. However, this was not possible in some cases, due to the elevation of the wet well influent pipe (County standard requires the pump on elevation to be below the influent pipe invert). For the lift stations where the operational controls were unable to be adjusted, or where adjusting the operational controls did not work, it is recommended the County confirm the actual pump on/off elevations and the pump curves. Because there are no recommended improvements for high pump starts, some of these are likely to be high in each of the future scenarios. The peak hour flow exceeded the firm pump capacity at 26 lift stations during the 2020 Wet Weather scenario (shown in Appendix H). The pump capacity at these 26 lift stations is exceeded in each of the future wet weather scenarios.

6.3.3.3 Gravity System

Table 6.3 summarizes the manhole overflows in the 2020 Wet Weather scenario and includes location, overflow duration, total overflow volume, and recommended action. Each of the manholes listed in Table 6.3 also experienced overflows in the 2015 Wet Weather scenario. These deficiencies are expected to be resolved once the recommended improvements listed in Table 6.3 are completed (by 2025).

With the extension of the MLS #5 (RTU 071) force main all the way to MLS 1-M (RTU 203), the 24-inch gravity pipe on Cortez Road is no longer surcharged. All other surcharged gravity mains identified in Chapter 5 (see Table 5.5) are still surcharged in the 2020 Wet Weather scenario.

Several lift station influent pipes (immediately upstream of wet wells) also experienced a d/D of over 80 percent; however, it is possible that the invert elevations and therefore slopes of the gravity mains in the model are not exactly correct. Because the upstream gravity system was not modeled at these locations and there were no overflows, no upgrades are recommended.

| Table 6.3 2020 Wet Weather Manhole Overflow Summary Southwest WWCS Master Plan Update Manatee County | | | |
|---|---|--|---|
| Manhole ID⁽¹⁾ | Duration of Overflow (hours)⁽²⁾ | Total Overflow Volume (gallons) | Recommendation |
| 136MH004 | 4.2 | 12,483 | Increase pump capacity at Lift Station RTU 136 |
| 136MH005 | 14.7 | 135,478 | |
| 136MH006 | 9.1 | 47,151 | |
| 457MH001 | 17.0 | 43,345 | Increase pump capacity at Lift Station RTU 457 |
| Notes: | | | |
| (1) First three digits of Manhole ID correspond to downstream lift station RTU number. | | | |
| (2) Includes overflows occurring within the last 72-hours of the 96-hour simulation. | | | |

6.3.4 Planned and Recommended Improvements

The new projects identified based on the 2015 evaluations (presented in Table 5.6) are recommended to be completed by 2025 (and are included in the 2025 scenarios), unless otherwise noted.

In addition, it is strongly recommended that the lift stations identified in Table 6.2 are assessed as soon as possible, and any inconsistencies found in the simulated pump curves or model setpoints be addressed in the model. Since the pump curves provided by the County were carefully input into the model and the model was reviewed by the County in its development stage, many inconsistencies are not expected. If no inconsistencies are found, it is recommended that new pumps that are capable of matching the simulated flow and head conditions of the 2035 Wet Weather scenario are installed.

It is also recommended that the rated capacity of Lake Bridge Lift Station (RTU 108) as provided by County (see Appendix D) is confirmed, and reassess the recommended pump change if the rated capacity of the existing pumps is different than the information provided.

6.4 2025 SCENARIO

Figure 6.5 shows the infrastructure included in the 2025 scenarios. There are no new planned developments coming online between 2020 and 2025, and growth is assumed to only occur within the planned developments that came online by the 2020 scenario. Sizing of the new force mains added in 2025 is shown in Figure 6.6.

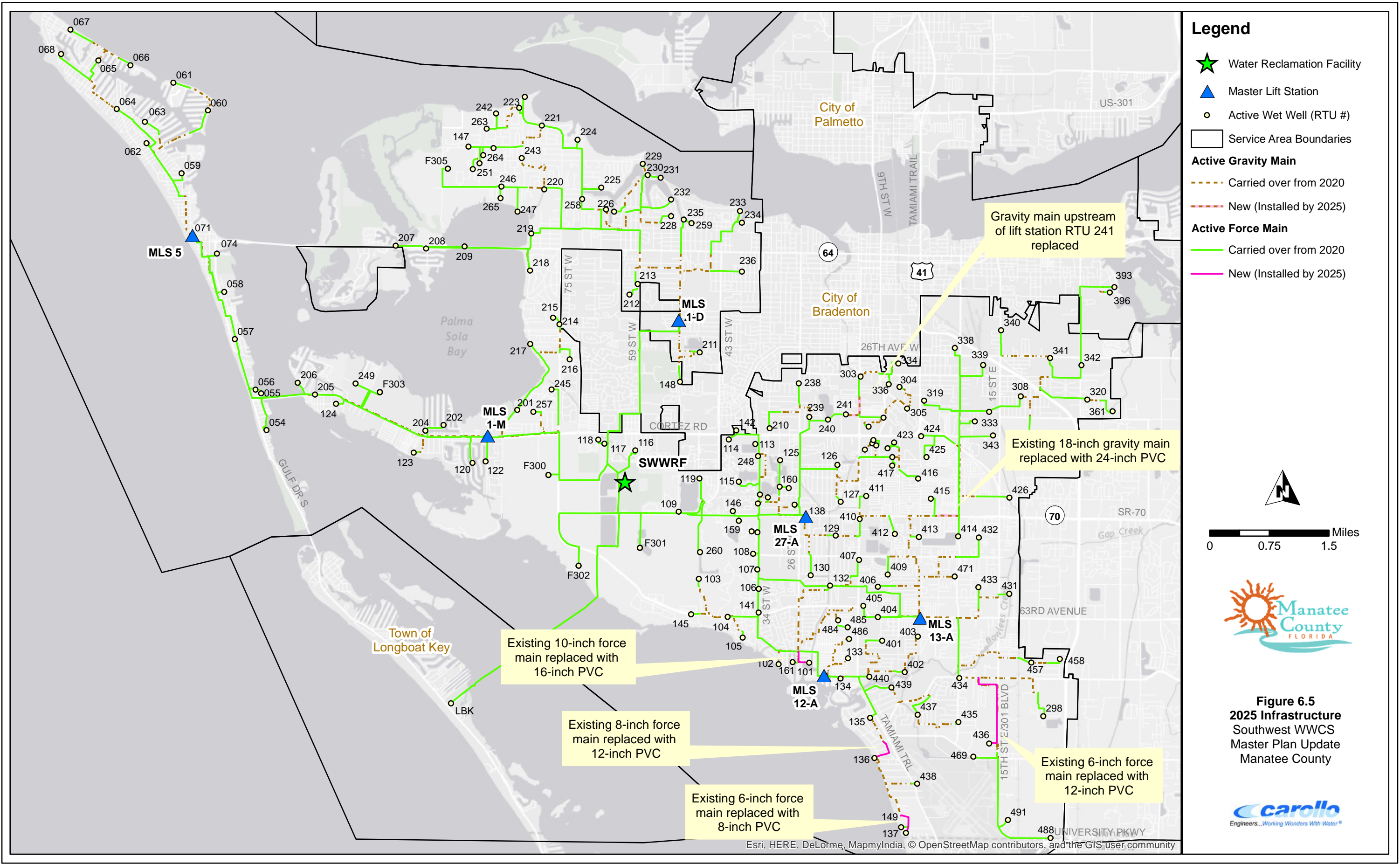

- Legend**
- Water Reclamation Facility
 - Master Lift Station
 - Active Wet Well (RTU #)
 - Service Area Boundaries
 - Active Gravity Main**
 - Carried over from 2020
 - New (Installed by 2025)
 - Active Force Main**
 - Carried over from 2020
 - New (Installed by 2025)

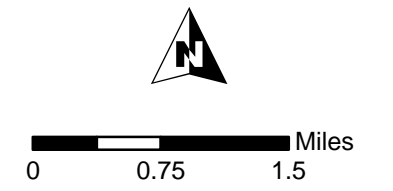

Figure 6.5
2025 Infrastructure
 Southwest WWCS
 Master Plan Update
 Manatee County



Esri, HERE, DeLorme, MapmyIndia, © OpenStreetMap contributors, and the GIS user community

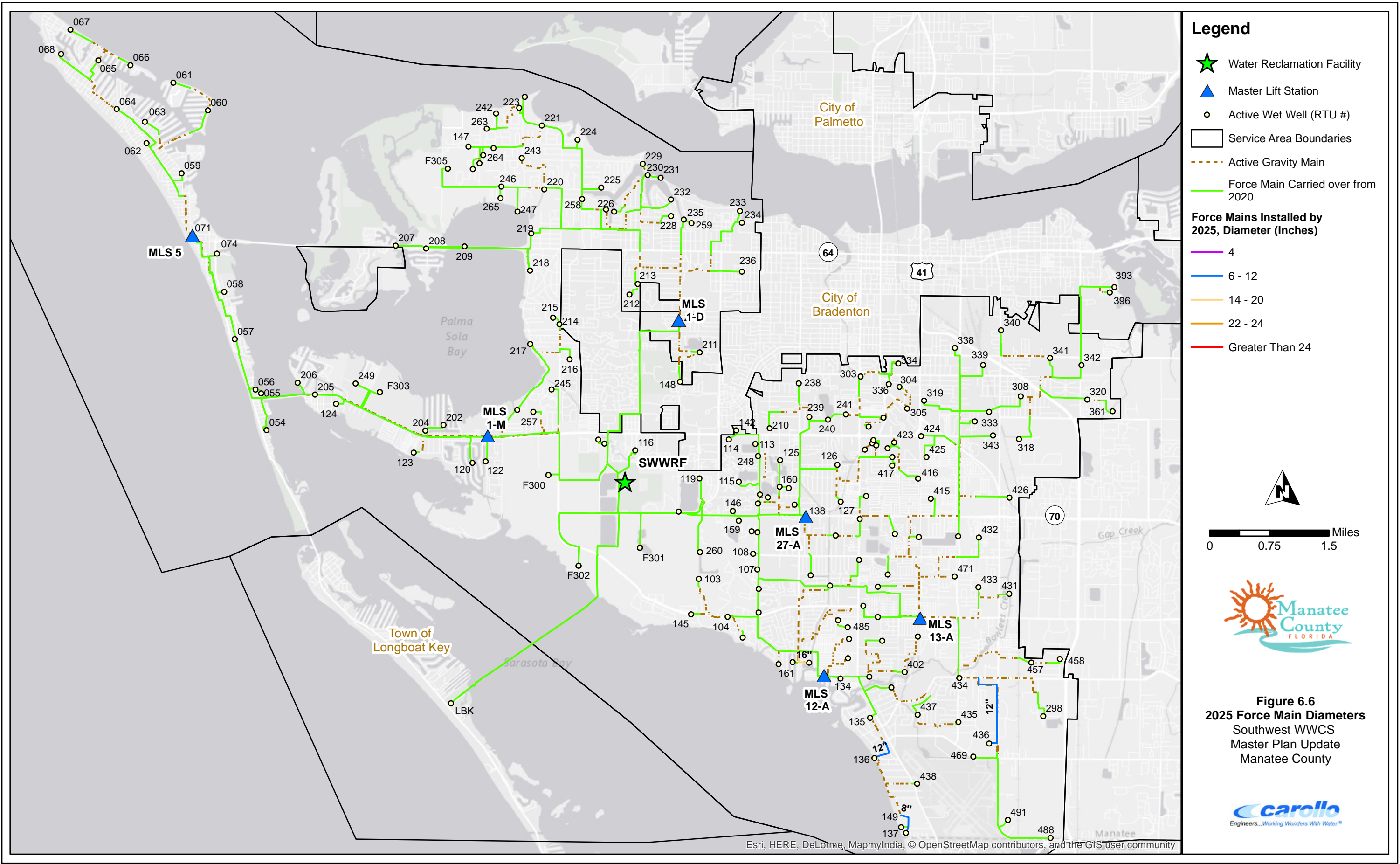

Figure 6.6
2025 Force Main Diameters
 Southwest WWCS
 Master Plan Update
 Manatee County

6.4.1 2025 Wastewater Infrastructure

The following infrastructure updates are included in the 2025 scenarios:

- The Bayshore Yacht Basin Lift Station (RTU 101) force main is upsized from 10-inch to 16-inch. The pumps are converted to VFD and the wet well capacity is increased. A 16-foot square wet well is used in the 2025 and beyond scenarios. Infrastructure sizing was based on detailed calculations provided by the County as the available calibration data for this lift station was not reliable. The County should install a temporary flowmeter to determine actual flows (average and wet weather) to confirm appropriate sizing of future infrastructure.

For simplicity, the future lift station was modeled in the same location as the existing lift station. The future 16-inch force main is approximately 800 linear feet based on the new location (at the southeast corner of 26th Street West and South Radcliffe Place).

- The pumps at lift station RTUs 136, 457, 217, and 437 were upsized to prevent manhole overflows and/or surcharged gravity upstream of the lift stations.
- Approximately 1,250 linear feet of 15-inch and 850 linear feet of 18-inch gravity main that connect 6,770 linear feet of force main to Lift Station 36-A (RTU 241) was upsized to 21-inch and 24-inch, respectively. This segment experiences a significant bottleneck when routing flow from other lift stations.

In addition to the improvements identified based on the 2105 and 2020 scenario evaluations, the following improvements are needed by 2025 due to the additional flows from the USF/Airport areas:

- A new pump design point was assigned at Lift Station 7-A (RTU 137), and the discharge force main was upsized from a 6-inch to an 8-inch diameter pipe.
- A new pump design point was assigned at the Crosley Estate Lift Station (RTU 149). This is required due to the new pumps at Lift Station 7-A (RTU 137)
- Upsize Lift Station 6-A (RTU 136) force main from an 8-inch to a 12-inch diameter pipe.
- A new pump design point was assigned at Lift Station 9-A (RTU 436) and the force main was upsized from a 6-inch to a 12-inch diameter pipe. The new force main was also extended to a manhole at the corner of Whitfield Avenue and Persimmon Place because the existing gravity main on 15th Street East and Idelwild Court does not have sufficient capacity for the additional flows. The wet well for this lift station was also shown to have limited storage capacity. Due to the additional flows expected from the USF/Airport areas, the County has identified this lift station wet well to be upsized. For the 2025 and beyond scenarios, a 12 foot diameter wet well was used.

It is recommended that the County verify the actual influent flows (average and wet weather) at this lift station to confirm the appropriate size needed.

Table 6.4 summarizes the force mains and gravity mains added in the 2025 scenario.

| Table 6.4 Wastewater Infrastructure Added in 2025 Scenarios Southwest WWCS Master Plan Update Manatee County | | | |
|---|--------------|--------------------------------|---------------------------------|
| Diameter | Type | Length Added (Feet) | Length Added (Miles) |
| 8 | Force Main | 1,615 | 0.31 |
| 12 | Force Main | 7,962 | 1.51 |
| 16 | Force Main | 800 | 0.15 |
| Force Main Subtotal | | 10,377 | 1.97 |
| 21 | Gravity Main | 1,247 | 0.24 |
| 24 | Gravity Main | 2,328 | 0.44 |
| Gravity Main Subtotal | | 3,575 | 0.68 |
| New Lift Stations | | | 1 ⁽¹⁾ |
| Existing Lift Stations with New Pumps | | | 9 |
| <u>Notes:</u> | | | |
| (1) For simplicity, the future Bayshore Yacht Basin Lift Station (RTU 101) was modeled in the same location as the existing lift station. The future force main is estimated to be 800 linear feet based on the new location (at the southeast corner of 26th Street West and South Radcliffe Place). | | | |

6.4.2 2025 LOS Analysis

A EPS LOS scenario was completed for the 2025 planning period. Figure 6.7 shows the force main velocity results, gravity main flow depth, and pump cycles per hour. The results shown in Figure 6.7 include all new infrastructure listed in Table 6.4. As shown, there are a few force mains that do not reach 2 fps in LOS conditions.

6.4.3 2025 Wet Weather Analysis

A wet weather EPS was also created for the 2025 planning period. The 2025 Wet Weather scenario, based on flows seen during on the 3-day storm event in September 2013, was evaluated to determine the system's ability to operate and meet performance criteria under maximum flow conditions. Figure 6.8 shows the results from the 2025 Wet Weather simulation.

Important observations from the results are discussed in the following sections.

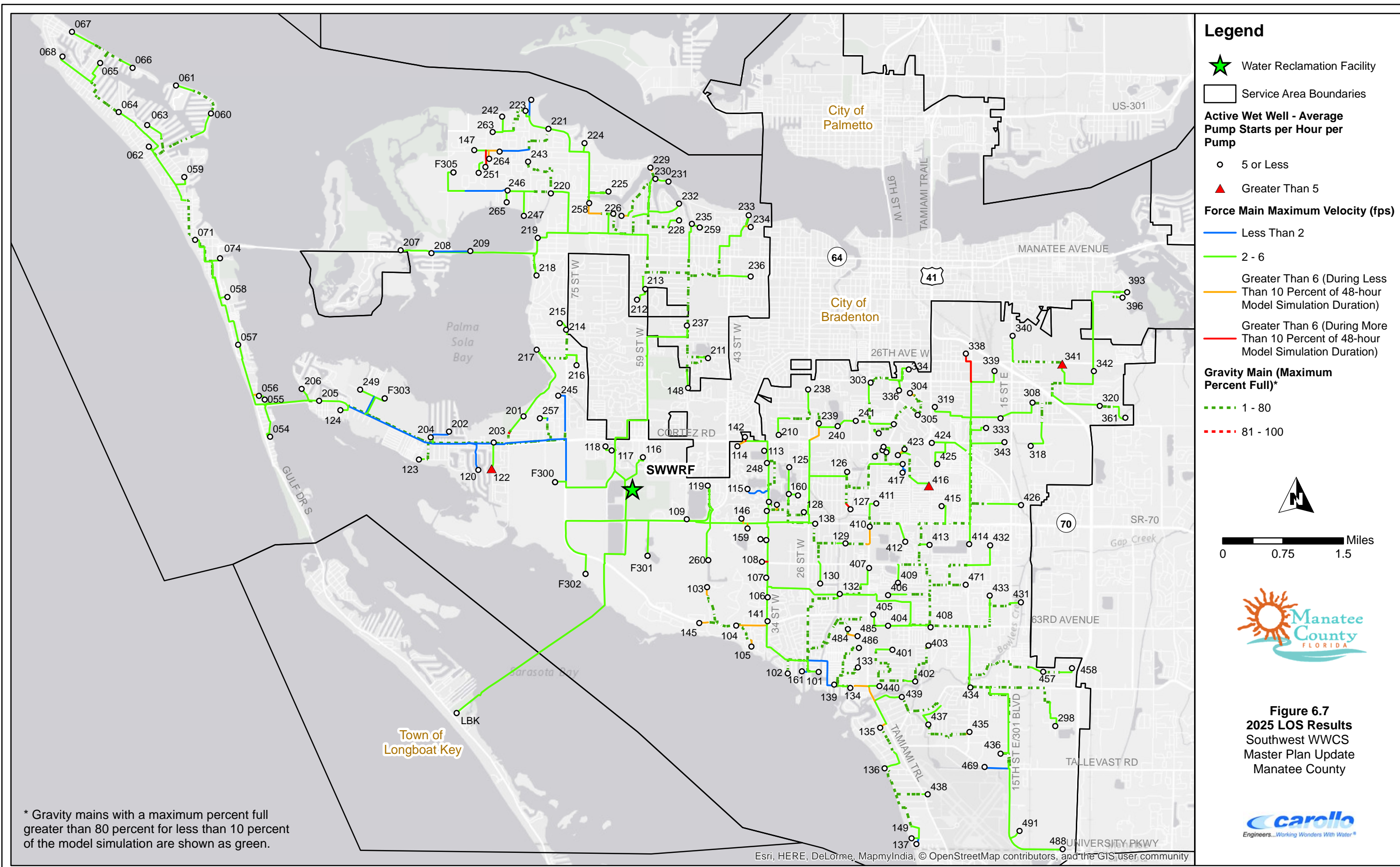

- Legend**
- Water Reclamation Facility
 - Service Area Boundaries
 - Active Wet Well - Average Pump Starts per Hour per Pump**
 - 5 or Less
 - Greater Than 5
 - Force Main Maximum Velocity (fps)**
 - Less Than 2
 - 2 - 6
 - Greater Than 6 (During Less Than 10 Percent of 48-hour Model Simulation Duration)
 - Greater Than 6 (During More Than 10 Percent of 48-hour Model Simulation Duration)
 - Gravity Main (Maximum Percent Full)***
 - 1 - 80
 - 81 - 100

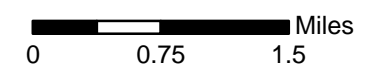
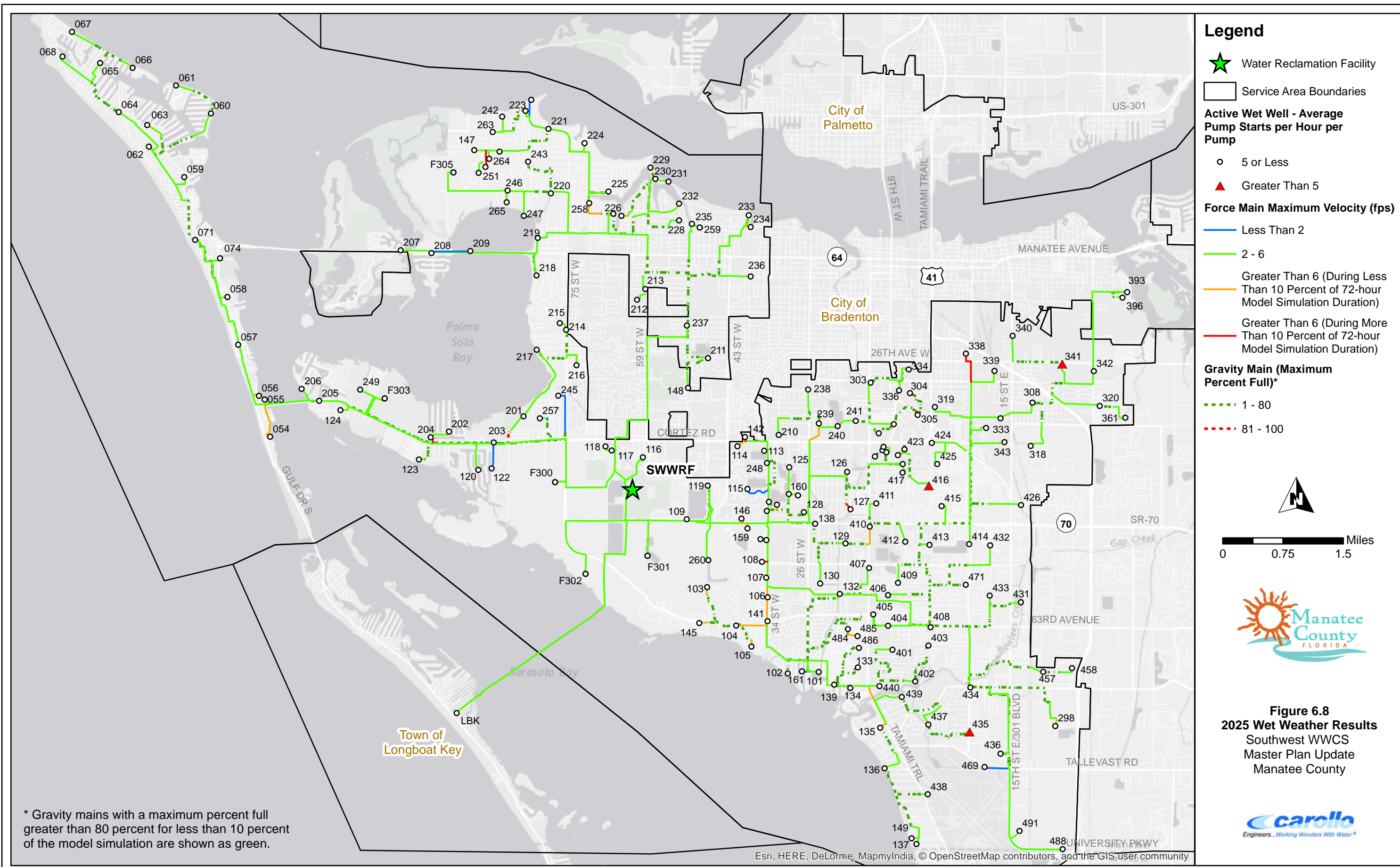

Figure 6.7
2025 LOS Results
 Southwest WWCS
 Master Plan Update
 Manatee County



* Gravity mains with a maximum percent full greater than 80 percent for less than 10 percent of the model simulation are shown as green.



- Legend**
- Water Reclamation Facility
 - Service Area Boundaries
 - Active Wet Well - Average Pump Starts per Hour per Pump**
 - 5 or Less
 - Greater Than 5
 - Force Main Maximum Velocity (fps)**
 - Less Than 2
 - 2 - 6
 - Greater Than 6 (During Less Than 10 Percent of 72-hour Model Simulation Duration)
 - Greater Than 6 (During More Than 10 Percent of 72-hour Model Simulation Duration)
 - Gravity Main (Maximum Percent Full)***
 - 1 - 80
 - 81 - 100

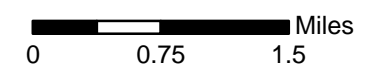

Figure 6.8
2025 Wet Weather Results
 Southwest WWCS
 Master Plan Update
 Manatee County



* Gravity mains with a maximum percent full greater than 80 percent for less than 10 percent of the model simulation are shown as green.

6.4.3.1 Force Mains

There are no new force main deficiencies identified in the 2025 Wet Weather scenario. The 4-inch force main connecting future Lift Station F305 to Azalea Park (RTU 246) now has a maximum velocity above 2 fps (was below 2 fps in the 2020 scenarios). High velocity force mains were previously identified in the 2015 (see Table 5.2) and 2020 (see Section 6.3.4.1) scenarios. Because the recommended action for these pipes was to verify model input data, they will continue to be high in the remainder of the future scenarios.

6.4.3.2 Lift Stations

As shown in Figure 6.8, only three lift stations had an average of more than 5 pump starts per hour (Lift Station RTUs 314, 416, and 435). These three lift stations have high pump starts in each of the remaining future wet weather scenarios. A majority of the high pump starts identified in the previous scenarios have been resolved, most likely due to increased flows causing the pumps to run longer, adjusted pump operational controls, new pumps, and/or a change in hydraulic conditions.

The pump capacity was exceeded at the same 26 lift stations identified in 2020 Wet Weather scenario. There were no overflows associated with these lift stations.

6.4.3.3 Gravity System

The most critical issues in the gravity system were addressed between 2020 and 2025. The previous overflows upstream of Lift Station RTUs 136 and 457 were corrected with new pumps. However, one new manhole overflow was identified upstream of the El Conquistador 1 Lift Station (RTU 104). The overflow at MH ID 104MH008 had a total duration of less than one hour and a total overflow volume of approximately 6,800 gallons. The force main from the Palm Court Lift Station (RTU 145) discharges at this manhole. No improvement project is included for this deficiency. This overflow did not occur in previous scenarios. Because this manhole receives flow from a force main, it is recommended the County verify the lift station discharge flow and gravity invert elevations.

Surcharging upstream of Lift Station RTUs 136, 217, 434, 437, and 457 were eliminated with the pump replacements in 2025. The gravity main upstream of MLS 13-A (on Whitfield Avenue) was not surcharged in the 2025 scenarios. This is attributed to new pumps at Lift Station RTU 457, causing a change in the flow pattern. However, with the increased flows from the USF/Airport area, this gravity main surcharges under 2035 Wet Weather conditions. Therefore, it is still recommended that this 18-inch gravity main be upsized to 24 inches by 2035. Table 6.5 summarizes the remaining surcharged gravity pipes in the 2025 Wet Weather scenario and recommended actions. Surcharging upstream of MLS 1-M (RTU 203) is expected to be corrected by upsizing the 8-inch gravity main on Palma Sola Boulevard to a 12-inch diameter.

| Table 6.5 2025 Wet Weather Gravity Main Surge Summary Southwest WWCS Master Plan Update Manatee County | | |
|--|--|---|
| Gravity Pipe IDs⁽¹⁾ | Duration at > 80% Full (hours)⁽²⁾ | Recommendation |
| GM-203-52 to GM-203-54 | 31.1 - 38.9 | Upsize existing 8-inch gravity main to 12-inch |
| GM-302-12 | 13.3 | Confirm invert elevations and confirm discharge flow rate from the Desoto Mall Lift Station (RTU 305) force main, which discharges to this gravity system |
| GM-303-1 | 29.2 | Confirm pipe diameter and invert elevations |
| Notes: (1) Gravity pipe ID corresponds to lift station RTU number. (2) Duration (hours) that gravity main depths are above 80 percent of total diameter throughout the last 72-hours of the 96-hour model simulation. | | |

Several lift station influent pipes (right upstream of wet wells) also experienced a d/D of over 80 percent; however, it is possible that the invert elevations and therefore slopes of the gravity mains in the model are not exact. Because the upstream gravity system was not modeled at these locations and there were no overflows, no upgrades are recommended.

6.4.4 Recommended Improvements

The following improvements are recommended to be completed by 2035:

- Upsize the 8-inch gravity main on Palma Sola Boulevard (upstream of MLS 1-M, RTU 203) to a 12-inch diameter pipe.
- Upsize the 18-inch gravity main (upstream of MLS 13-A (RTU 408)) on 63rd Avenue East (from Pennsylvania Avenue to 5th Street Circle) to a 24-inch diameter pipe.

6.5 2035 SCENARIO

No new planned developments are expected to come online between 2025 and 2035 in the Southwest Service Area, although further growth is expected among the planned developments that came online in 2020. Figure 6.9 shows the new infrastructure added in the 2035 scenarios.

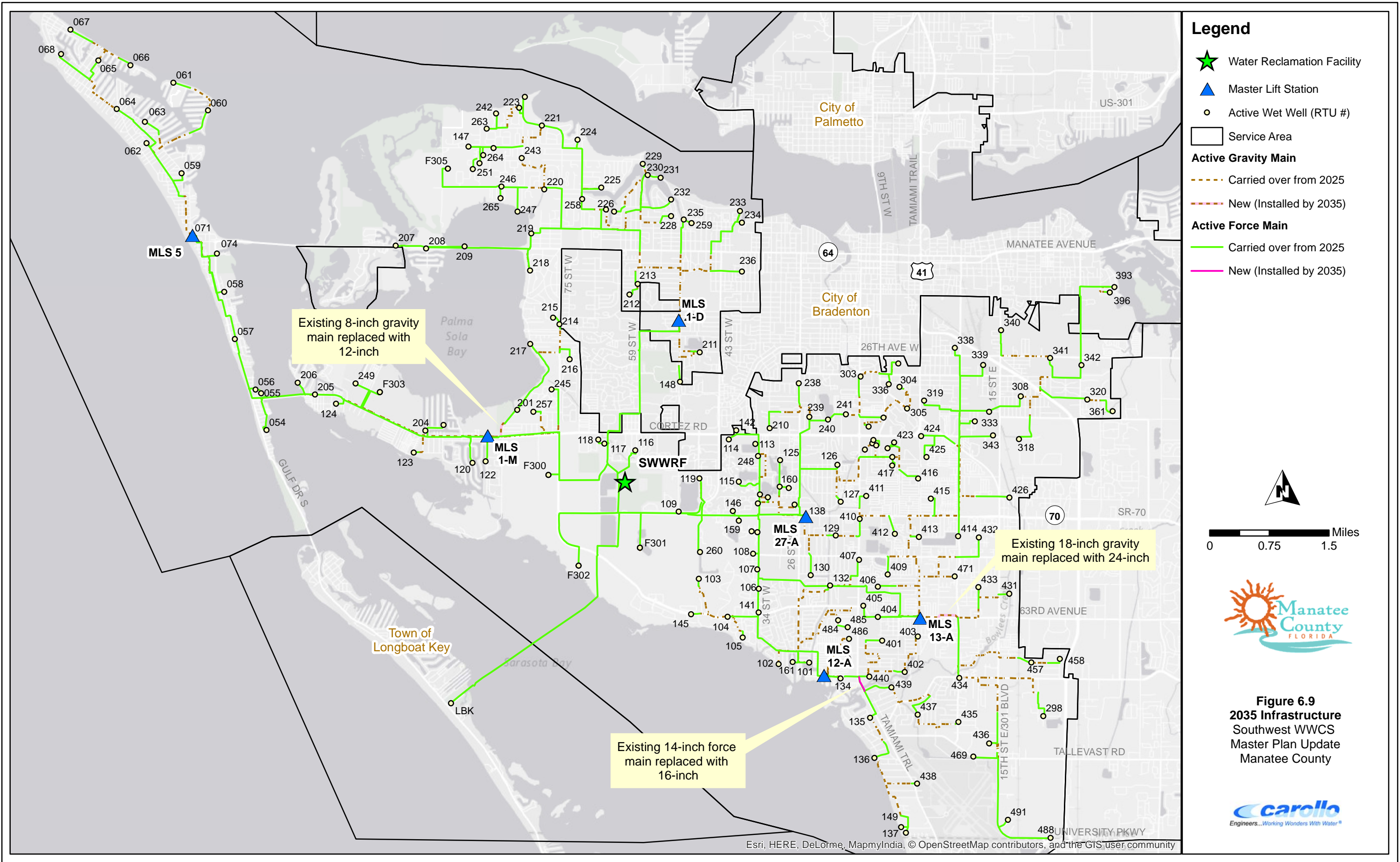

6.5.1 2035 Wastewater Infrastructure

The following infrastructure improvements are included in the 2035 scenarios:

- Upsize existing 8-inch gravity main upstream of MLS 1-M (RTU 203) with a 12-inch diameter pipe.
- Upsize existing 18-inch gravity main upstream of MLS 13-A (RTU 408) along 63rd Avenue East (from Pennsylvania Avenue to 5th Street Circle) with 24-inch diameter pipe.

The following improvements are required to meet additional flows from the USF/Airport areas:

- New pumps at the Airport Industrial Park Lift Station (RTU 469)
- Upsize the existing 14-inch force main along US 41 (from Magellan Drive to 69th Avenue West) with a 16-inch diameter.

Table 6.6 summarizes the force mains and lift stations added or modified in the 2035 scenario.

| Table 6.6 Wastewater Infrastructure Added in 2035 Scenarios Southwest WWCS Master Plan Update Manatee County | | | |
|---|--------------|----------------------------|-----------------------------|
| Diameter | Type | Length Added (Feet) | Length Added (Miles) |
| 16 | Force Main | 1,027 | 0.19 |
| Force Main Subtotal | | 1,027 | 0.19 |
| 12 | Gravity Main | 1,061 | 0.20 |
| 24 | Gravity Main | 1,430 | 0.27 |
| Gravity Main Subtotal | | 2,491 | 0.47 |
| New Lift Stations | 0 | | |
| Existing Lift Stations with New Pumps | 1 (RTU 469) | | |

6.5.2 2035 LOS Analysis

A LOS EPS scenario was completed for the 2035 planning period. Figure 6.10 shows the force main velocity results, gravity main flow depth, and pump cycles per hour. The results shown in Figure 6.10 include all new infrastructure listed in Table 6.6. As shown, there are a few force mains that do not reach 2 fps.

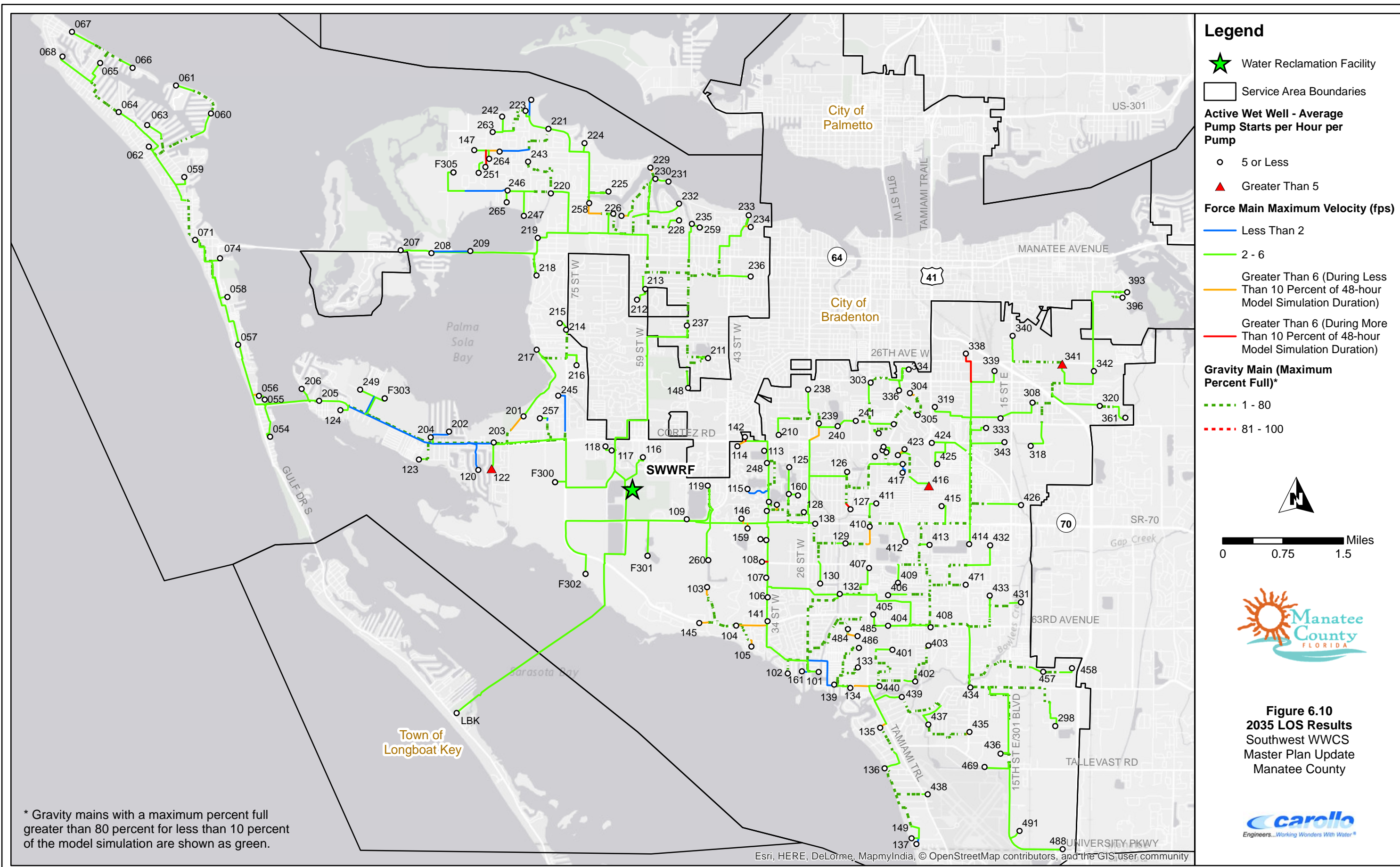

Legend

- Water Reclamation Facility
- Service Area Boundaries
- Active Wet Well - Average Pump Starts per Hour per Pump**
 - 5 or Less
 - Greater Than 5
- Force Main Maximum Velocity (fps)**
 - Less Than 2
 - 2 - 6
 - Greater Than 6 (During Less Than 10 Percent of 48-hour Model Simulation Duration)
 - Greater Than 6 (During More Than 10 Percent of 48-hour Model Simulation Duration)
- Gravity Main (Maximum Percent Full)***
 - 1 - 80
 - 81 - 100

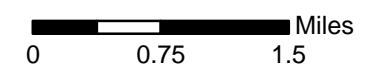

Figure 6.10
2035 LOS Results
 Southwest WWCS
 Master Plan Update
 Manatee County



* Gravity mains with a maximum percent full greater than 80 percent for less than 10 percent of the model simulation are shown as green.

6.5.3 2035 Wet Weather Analysis

A wet weather EPS was also created for the 2035 planning period. The 2035 Wet Weather scenario, based flows resulting from the 3-day storm event in September 2013, was evaluated to determine the system's ability to operate and meet performance criteria under maximum flow conditions. Figure 6.11 shows the results from the 2035 Wet Weather simulation. Because there were no major changes in the infrastructure and only a moderate increase in flow, the 2035 results are similar to 2025 results.

Important observations from the results are discussed in the following sections.

6.5.3.1 Force Mains

There were no changes in the force main velocity results between the 2025 and 2035 Wet Weather scenarios.

6.5.3.2 Lift Stations

There were no major changes in lift station results between the 2025 and 2035 Wet Weather scenarios. As shown in Figure 6.11, the same three lift stations identified in 2025 with high pump starts (RTUs 341, 416, and 435) were also identified in 2035. The pump capacity was exceeded at 26 lift stations during the 2035 Wet Weather scenario (the same lift stations as the 2025 Wet Weather scenario). Although the pump capacity was exceeded, there were no overflows associated with these lift stations.

6.5.3.3 Gravity System

The only overflow identified in the 2035 Wet Weather scenario was upstream of Lift Station RTU 104 (104MH008). This was the same location identified in the 2025 Wet Weather scenario and has a similar overflow duration (less than one hour) and total volume (less than 10,000 gallons). The surcharged gravity main upstream of MLS 1-M (RTU 203) has been resolved by upsizing the gravity main. Because there were no recommended improvements for the surcharging upstream of Lift Station RTUs 302 and 303, they are still flagging in the 2035 Wet Weather scenario.

Several lift station influent pipes (right upstream of wet wells) also experienced a d/D of over 80 percent; however, it is possible that the invert elevations and therefore slopes of the gravity mains in the model are not exact. Because the upstream gravity system was not modeled at these locations and there were no overflows, no upgrades are recommended.

6.5.4 Recommended Improvements

There are no new recommended improvements based on the evaluation of the 2035 scenarios. As mentioned previously, this is because all recommended improvements made were sized to meet the 2035 population.

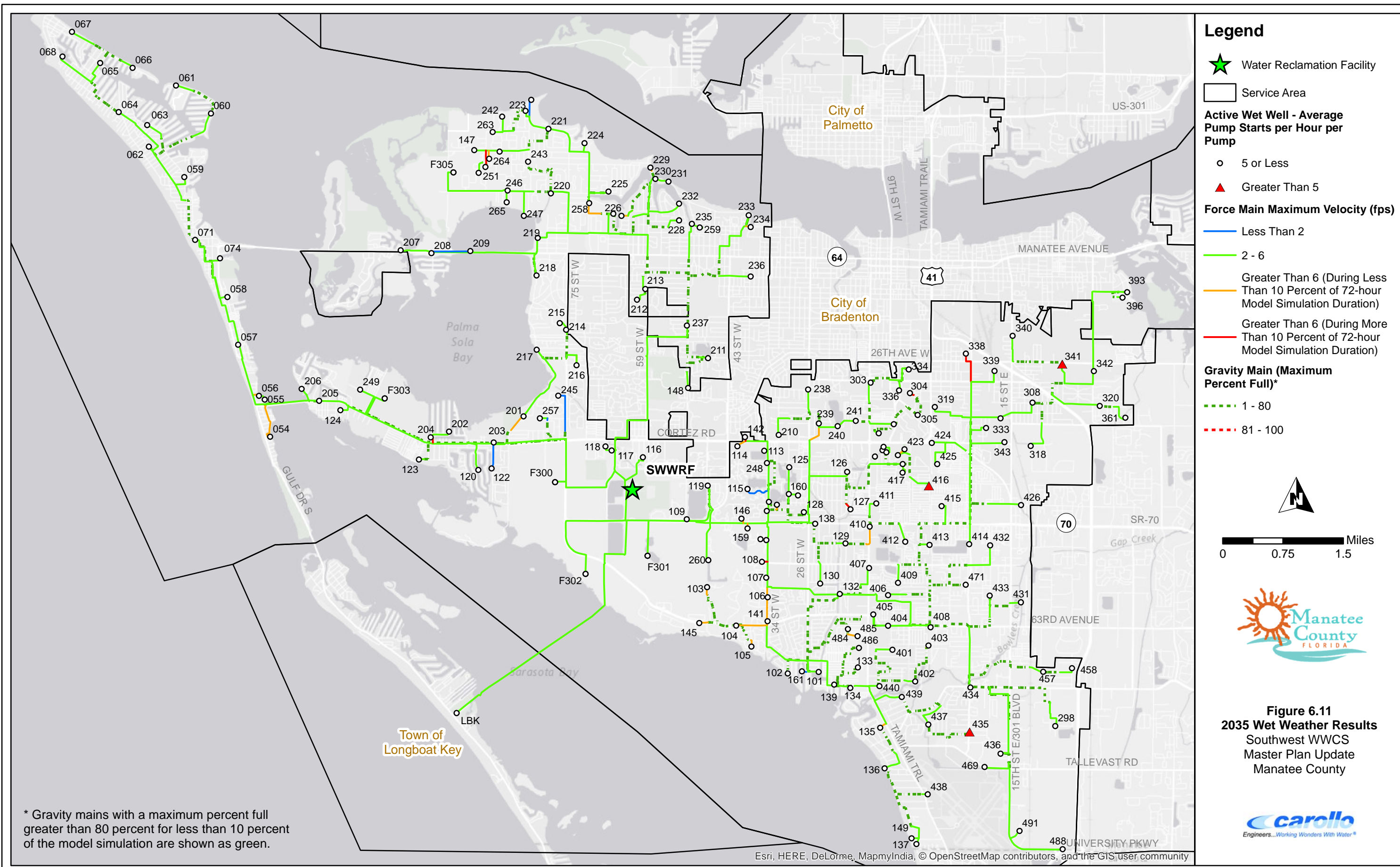

- Legend**
- Water Reclamation Facility
 - Service Area
 - Active Wet Well - Average Pump Starts per Hour per Pump**
 - 5 or Less
 - Greater Than 5
 - Force Main Maximum Velocity (fps)**
 - Less Than 2
 - 2 - 6
 - Greater Than 6 (During Less Than 10 Percent of 72-hour Model Simulation Duration)
 - Greater Than 6 (During More Than 10 Percent of 72-hour Model Simulation Duration)
 - Gravity Main (Maximum Percent Full)***
 - 1 - 80
 - 81 - 100

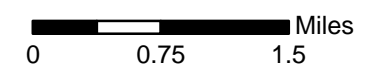

Figure 6.11
2035 Wet Weather Results
 Southwest WWCS
 Master Plan Update
 Manatee County



* Gravity mains with a maximum percent full greater than 80 percent for less than 10 percent of the model simulation are shown as green.

6.6 PLANNED DEVELOPMENT SCENARIO

Figure 6.12 shows the infrastructure coming online between the 2035 and planned development scenarios. Although other pipelines and valves may exist for backup and other operational strategies, Figure 6.12 represents the strategy used in the planned development scenario modeling analyses.

6.6.1 Planned Development Wastewater Infrastructure

Evaluation of the Planned Development scenario indicated that the only development that would need a force main with additional capacity by the Planned Development scenario was Longbar Pointe (F302). Since the County plans to use the existing 8-inch force main that runs along El Conquistador Parkway for reclaimed water in the future, a new 12-inch line along the same route was proposed (to be installed by developer). Other flow routing alternatives (for example, connecting to the Longboat Key force main) were evaluated during the Master Plan project and were kept inactive in the model for future County use.

As a result, maps developed for 2035 scenarios are not different from the Planned Development scenarios, except for the new force main serving Longbar Pointe. The increased capacity requirement of the Longbar Pointe development also requires either:

- A wet well expansion and addition of a third pump by Planned Development, or
- The addition of a second lift station.

Although the County may choose either option listed above, for simplicity, the new Longbar Point lift station was modeled as a single wet well.

Table 6.7 reflects the new infrastructure recommended to come online by the Planned Development scenario.

| Table 6.7 Wastewater Infrastructure Added in Planned Development Southwest WWCS Master Plan Update Manatee County | | |
|--|----------------------------|-----------------------------|
| Force Main Diameter (inches) | Total | |
| | Length Added (Feet) | Length Added (Miles) |
| 12 | 8,296 | 1.57 |
| Total Length | 8,296 | 1.57 |
| New Lift Stations ⁽¹⁾ | 1 | |
| New Pumps in Existing Lift Stations | 0 | |
| Notes: | | |
| (1) New lift station brought online to serve additional growth within Longbar Pointe development. | | |

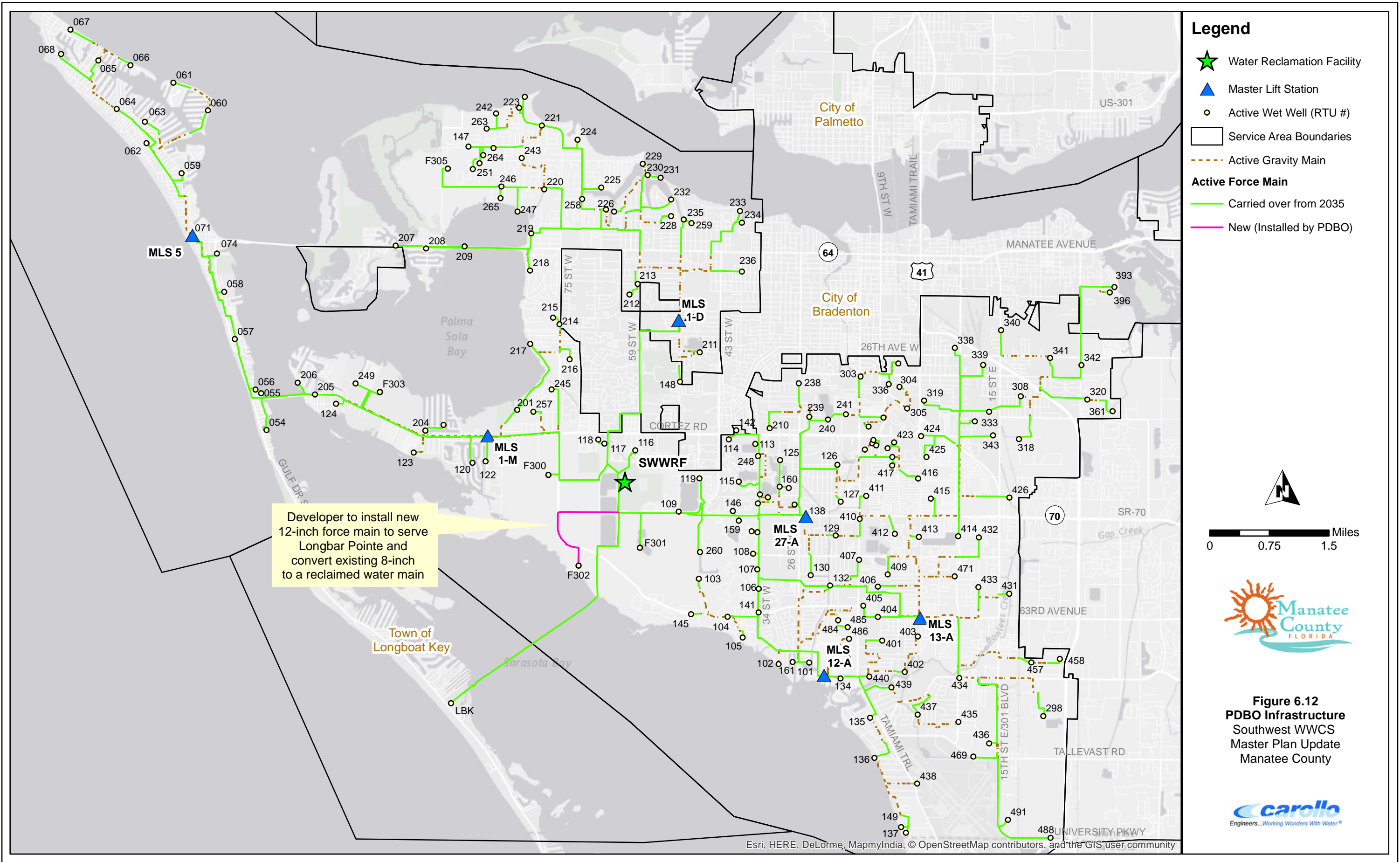

Developer to install new 12-inch force main to serve Longbar Pointe and convert existing 8-inch to a reclaimed water main

- Legend**
- Water Reclamation Facility
 - Master Lift Station
 - Active Wet Well (RTU #)
 - Service Area Boundaries
 - Active Gravity Main
 - Active Force Main**
 - Carried over from 2035
 - New (Installed by PDBO)

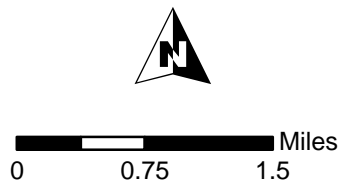

Figure 6.12
PDBO Infrastructure
 Southwest WWCS
 Master Plan Update
 Manatee County



Esri, HERE, DeLorme, MapmyIndia, © OpenStreetMap contributors, and the GIS user community

6.6.2 Planned Development LOS Analysis

A EPS LOS scenario was completed for the planned development scenario planning period. Figure 6.13 shows the force main velocity results, gravity main flow depth, and pump cycles per hour.

6.6.3 Planned Development Wet Weather Analysis

A wet weather EPS was also created for the planned development planning period. The Planned Development Wet Weather scenario, based on flows resulting from the 3-day storm event in September 2013, was evaluated to determine the system's ability to operate and meet performance criteria under maximum flow conditions. Figure 6.14 shows the results from the Planned Development Wet Weather simulation.

6.6.3.1 Force Mains

There were no changes in the force main velocity results from the 2035 to the Planned Development Wet Weather scenarios.

6.6.3.2 Lift Stations

There were no major changes in lift station results between the 2035 and Planned Development Wet Weather scenarios. As shown in Figure 6.14, the same three lift stations identified in the 2025 and 2035 Wet Weather scenarios with high pump starts (RTUs 341, 416, and 435) are still flagging as high. The pump capacity was also exceeded at 26 lift stations (the same lift stations as the 2025 and 2035 Wet Weather scenarios). Although the pump capacity was exceeded, there were no overflows associated with these lift stations.

6.6.3.3 Gravity System

There were no new overflows or surcharged gravity mains identified in the Planned Development Wet Weather scenario. Several lift station influent pipes (right upstream of wet wells) experienced a d/D of over 80 percent; however, it is possible that the invert elevations and therefore slopes of the gravity mains in the model are not exact. Because the upstream gravity system was not modeled at these locations and there were no overflows, no upgrades are recommended.

6.6.4 Recommended Improvements

There are no new recommendations based on the evaluation of the Planned Development scenarios.

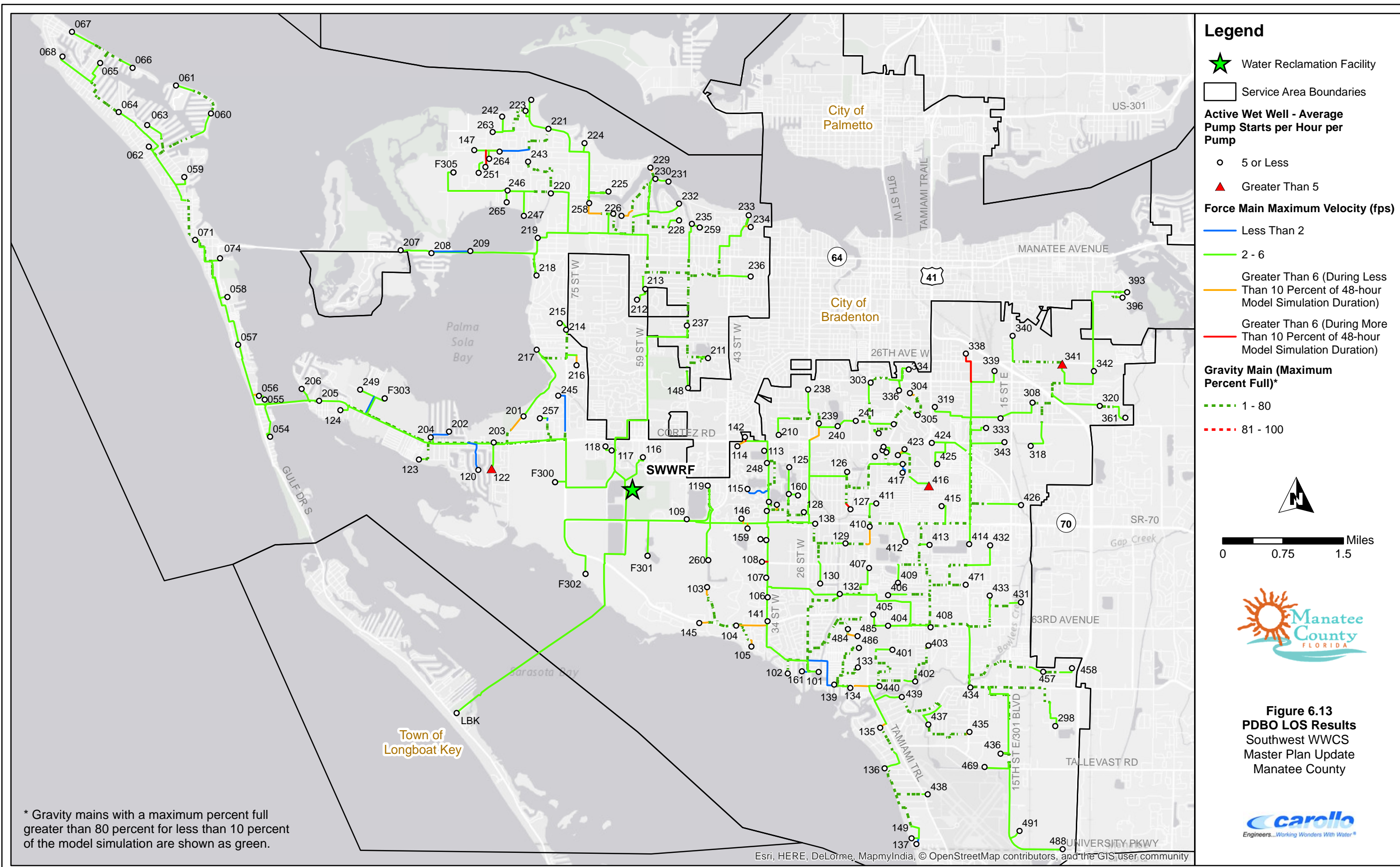

Legend

- Water Reclamation Facility
- Service Area Boundaries
- Active Wet Well - Average Pump Starts per Hour per Pump**
 - 5 or Less
 - Greater Than 5
- Force Main Maximum Velocity (fps)**
 - Less Than 2
 - 2 - 6
 - Greater Than 6 (During Less Than 10 Percent of 48-hour Model Simulation Duration)
 - Greater Than 6 (During More Than 10 Percent of 48-hour Model Simulation Duration)
- Gravity Main (Maximum Percent Full)***
 - 1 - 80
 - 81 - 100

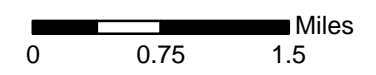
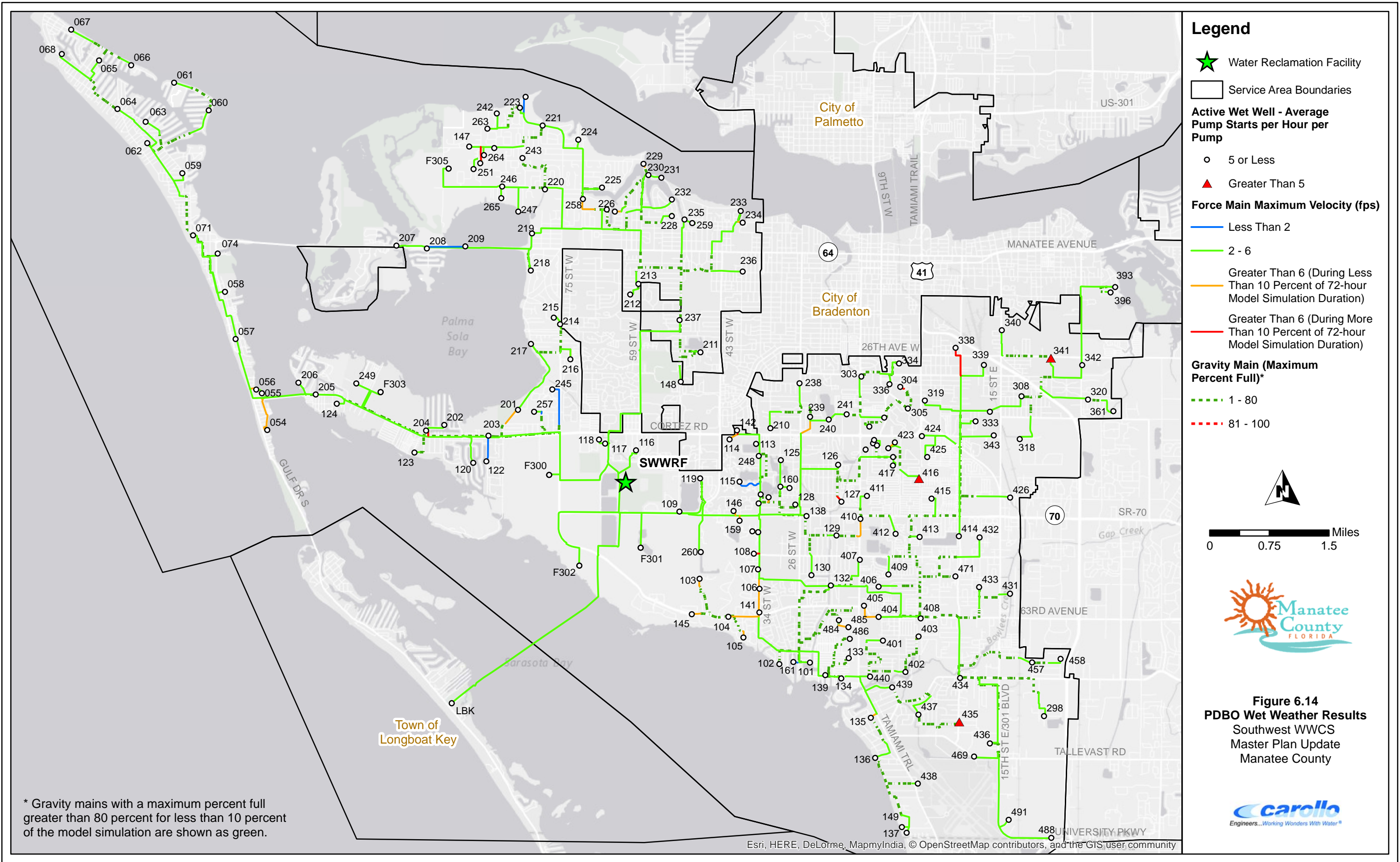

Figure 6.13
PDBO LOS Results
 Southwest WWCS
 Master Plan Update
 Manatee County



* Gravity mains with a maximum percent full greater than 80 percent for less than 10 percent of the model simulation are shown as green.



- Legend**
- Water Reclamation Facility
 - Service Area Boundaries
 - Active Wet Well - Average Pump Starts per Hour per Pump**
 - 5 or Less
 - Greater Than 5
 - Force Main Maximum Velocity (fps)**
 - Less Than 2
 - 2 - 6
 - Greater Than 6 (During Less Than 10 Percent of 72-hour Model Simulation Duration)
 - Greater Than 6 (During More Than 10 Percent of 72-hour Model Simulation Duration)
 - Gravity Main (Maximum Percent Full)***
 - 1 - 80
 - 81 - 100



0 0.75 1.5 Miles



Figure 6.14
PDBO Wet Weather Results
 Southwest WWCS
 Master Plan Update
 Manatee County



* Gravity mains with a maximum percent full greater than 80 percent for less than 10 percent of the model simulation are shown as green.

6.7 BUILD-OUT SCENARIO

Figure 6.15 shows the infrastructure coming online between the planned development and build-out scenarios. Although other pipelines and valves may exist for backup and other operational strategies, Figure 6.15 represents the strategy used in the build-out modeling analyses. Figure 6.16 shows sizing of the infrastructure added at build-out.

Figure 6.17 shows all of the infrastructure added through build-out, including lift stations, force mains, and sewer sheds. The build-out parcels (all undeveloped lands and septic parcels) are also shown. The force mains in Figure 6.17 are color coded based on when they come online: existing (black), future (green), or build-out (red). It is important to note that the green future force mains represent all new force mains added between the 2020 and planned development scenarios. The red build-out force mains represent the force mains added between planned development and build-out.

6.7.1 Build-Out Wastewater Infrastructure

Table 6.8 summarizes the force mains and lift stations added in the build-out scenario.

| Table 6.8 Wastewater Infrastructure Added in Build-Out Scenario Southwest WWCS Master Plan Update Manatee County | | |
|---|----------------------------|-----------------------------|
| Force Main Diameter (inches) | Total | |
| | Length Added (Feet) | Length Added (Miles) |
| 4 | 21,944 | 4.16 |
| 6 | 1,492 | 0.28 |
| 12 | 2,171 | 0.41 |
| Total Length | 25,607 | 4.85 |
| New Lift Stations ⁽¹⁾ | 11 | |
| Existing Stations with New Pumps | 1 (RTU 135) | |
| <u>Notes:</u> | | |
| (1) New lift stations brought on line to serve areas of undeveloped land and septic parcels by build-out. | | |

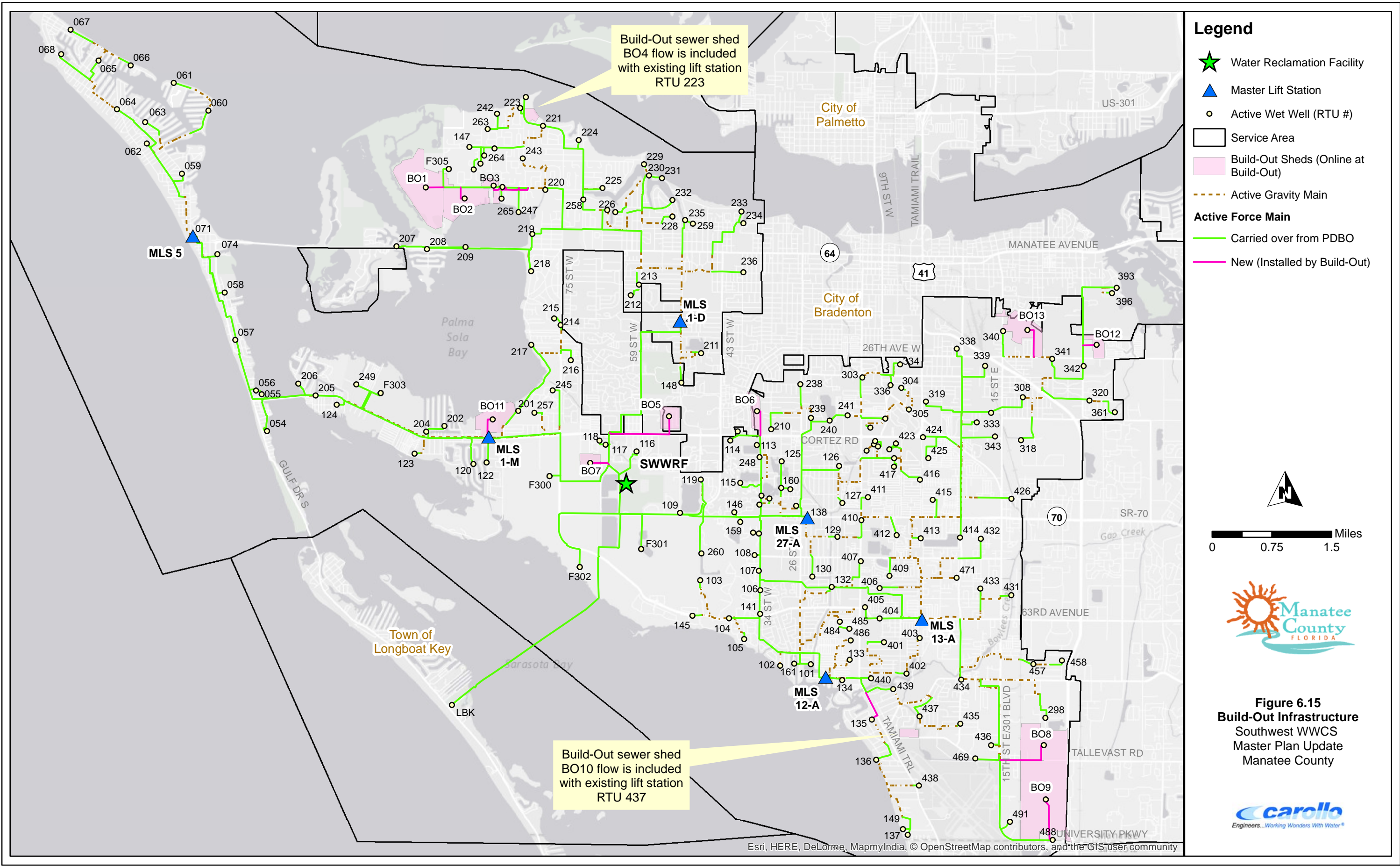

- Legend**
- Water Reclamation Facility
 - Master Lift Station
 - Active Wet Well (RTU #)
 - Service Area
 - Build-Out Sheds (Online at Build-Out)
 - Active Gravity Main
 - Active Force Main**
 - Carried over from PDBO
 - New (Installed by Build-Out)

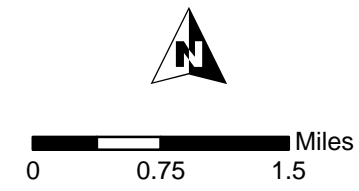

Figure 6.15
Build-Out Infrastructure
 Southwest WWCS
 Master Plan Update
 Manatee County



Esri, HERE, DeLorme, MapmyIndia, © OpenStreetMap contributors, and the GIS user community

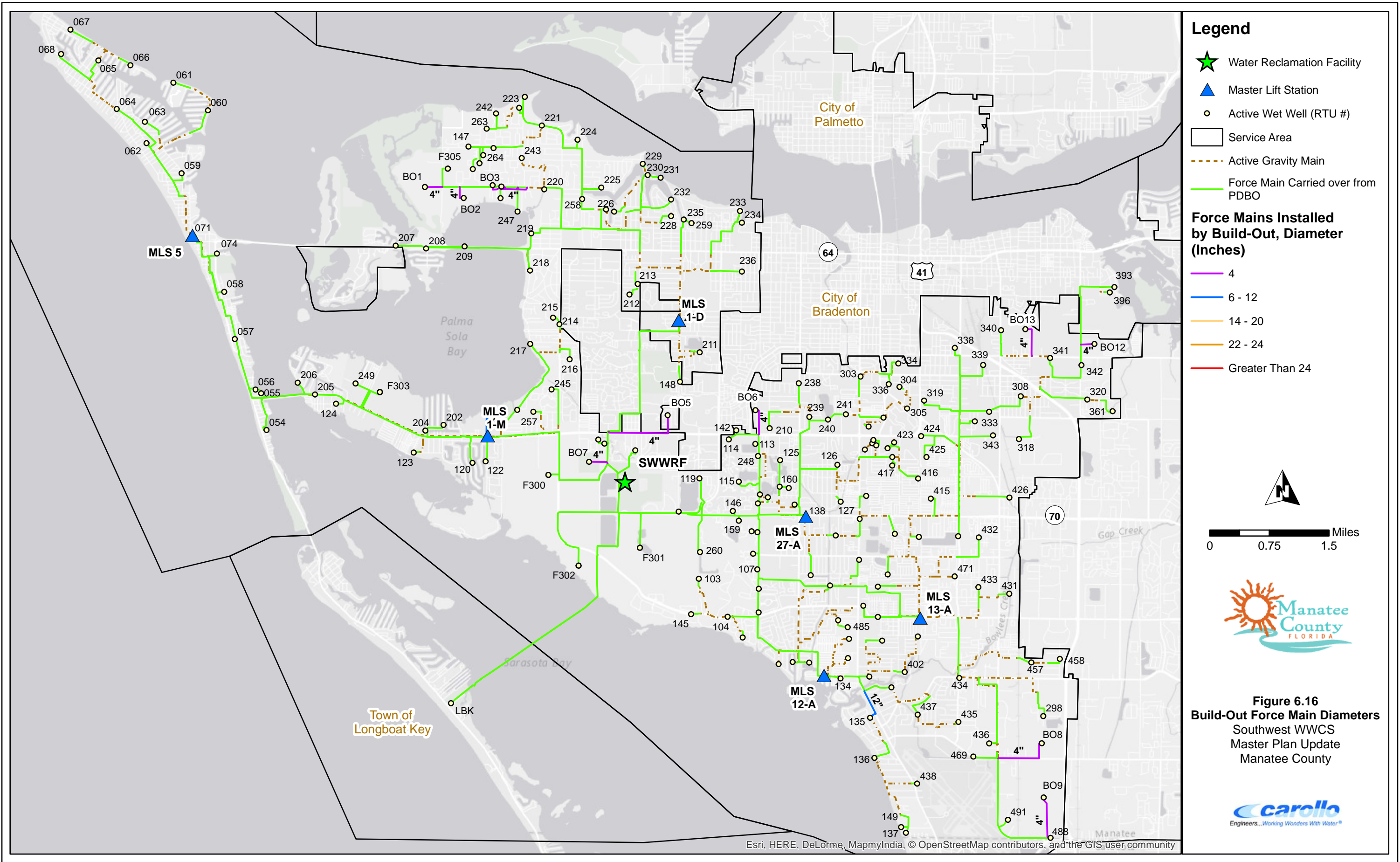

Figure 6.16
Build-Out Force Main Diameters
 Southwest WWCS
 Master Plan Update
 Manatee County

Note: This map accompanies the Southwest WWCS Master Plan Update, a planning level guiding document for how the North Service Area of the County will be developed, based on population projections and land use information provided by the County in 2015. The pipe sizes are based on assumptions (pump operating points, wet well high and low water levels and dimensions) presented in the report and are planning level calculations and results, which should be confirmed during future stages of design (preliminary and detailed design phases) once more conditions are known. The sizes shown on this map and presented in the report are not to replace or minimize the preliminary engineering, and detailed design engineering that will be required with each of the identified projects in the future.

| Build Out Sewer Shed Number | Future Land Use Type ⁽¹⁾ | Acres | Equivalent Dwelling Units |
|-----------------------------|--|-------------|---------------------------|
| BO-1 | RES-1 | 204 | 153 |
| BO-2 | RES-1 | 78 | 59 |
| | RES-3 | 7 | 16 |
| BO-3 | RES-3 | 14 | 31 |
| | Septic parcels < 1 acre ⁽²⁾ | Less Than 1 | 3 |
| BO-4 | RES-3 | 3 | 6 ⁽³⁾ |
| BO-5 | Septic parcels < 1 acre ⁽²⁾ | Less Than 1 | 134 |
| | Septic parcels < 1 acre ⁽²⁾ | Less Than 1 | 86 |
| BO-7 | RES-16 | Less Than 1 | Less Than 1 |
| | RES-9 | 40 | 270 |
| BO-8 | IL | 6 | 5 |
| | RES-6 | 22 | 100 |
| | Septic parcels < 1 acre ⁽²⁾ | Less Than 1 | 17 |
| BO-9 | IL | 256 | 192 |
| | RES-6 | 8 | 34 |
| | Septic parcels < 1 acre ⁽²⁾ | Less Than 1 | 4 |
| BO-10 | IL | 16.5 | 12 ⁽⁴⁾ |
| BO-11 | RES-6 | 86 | 389 |
| | CITY | Less Than 1 | Less Than 1 |
| BO-12 | RES-6 | 28 | 128 |
| | CITY | 61 | 23 |
| BO-13 | RES-6 | 11 | 48 |
| | Septic parcels < 1 acre ⁽²⁾ | Less Than 1 | 3 |

Notes:
 1. Only includes future land use types associated with a residential population.
 2. Septic parcels less than 1 acre in size were assumed to have 1 EDU per parcel.
 3. The flow for BO-4 is included with LS RTU 223.
 4. The flow for BO-10 is included with LS RTU 437.

| Lift Station Number | Planned Development Name | Total EDUs |
|---------------------|--------------------------|------------|
| 203 | 43rd Terrace W | 30 |
| F300 | Lake Flores 1 | 4,324 |
| F301 | Lake Flores 2 | 4,324 |
| F302 | Longbar Pointe | 3,197 |
| F303 | Peninsula Bay | 1,876 |
| F305 | Vacant Lots | 162 |
| 217 | Palma Sola Grande | 16 |

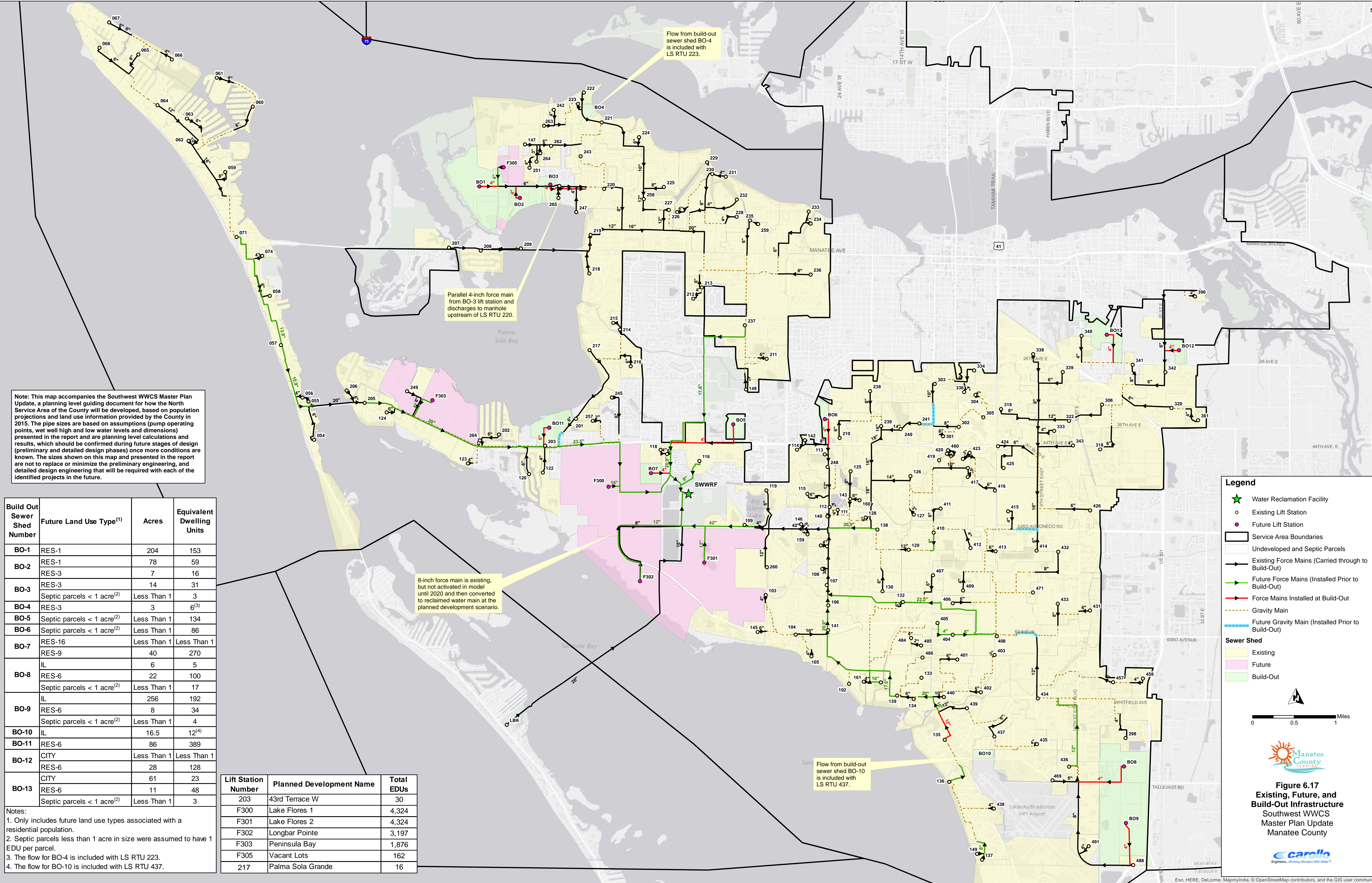

8-inch force main is existing, but not activated in model until 2020 and then converted to reclaimed water main at the planned development scenario.

Flow from build-out sewer shed BO-4 is included with LS RTU 223.

Flow from build-out sewer shed BO-10 is included with LS RTU 437.

Legend

- ★ Water Reclamation Facility
- Existing Lift Station
- Future Lift Station
- ▭ Service Area Boundaries
- ▭ Undeveloped and Septic Parcels
- Existing Force Mains (Carried through to Build-Out)
- Future Force Mains (Installed Prior to Build-Out)
- Force Mains Installed at Build-Out
- Gravity Main
- Future Gravity Main (Installed Prior to Build-Out)

Sewer Shed

- Existing
- Future
- Build-Out

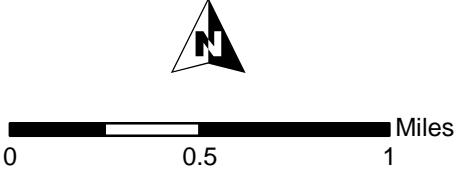

Figure 6.17
 Existing, Future, and Build-Out Infrastructure
 Southwest WWCS
 Master Plan Update
 Manatee County



6.7.2 Build-Out Analysis

Analyses were completed for build-out LOS and wet weather conditions. New force mains were sized to operate within velocities of 2 to 6 fps. As described in previous sections, all future lift stations were designed to meet performance criteria, including force main and wet well diameter. The minimum force main diameter of 4 inches was used for all build-out lift stations. Because some of the build-out lift stations serve a small number of dwelling units, some of these force mains do not reach 2 fps. The County may alternatively choose to install a grinder pump station (with a smaller diameter force main) at these locations. The best option should be determined during the design phase of each lift station.

The discharge force mains for the following existing lift stations were shown to never reach 2 fps throughout the Build-Out Wet Weather scenario:

- Wildwood Springs 2 (RTU 115)
- Coral Shores East 4 (RTU 122)
- Desoto Memorial Park (RTU 222)
- Broome Park (RTU 245)

Although there were no recommended improvements for the low velocity force mains, the County may want to evaluate these pipes at the end of their useful life to determine if they should be downsized.

6.8 WATER RECLAMATION FACILITY CAPACITY

The SWWRF is currently permitted for 15.0 mgd based on three month rolling average daily flow (3MRADF). The average ratio between the County's annual average daily flow (AADF) and the 3MRADF was determined to be essentially one in the LOS Evaluation project (Carollo, 2015). Table 6.9 summarizes the projected flows based on LOS and historical peaking factors, as described in Chapter 3. The model simulated LOS and maximum day wet weather flows are also shown. Both the projected AADF and the simulated LOS flows show that the SWWRF capacity would have been exceeded by 2015 based on the County's LOS flow assumptions.

As shown in Table 6.9, the simulated peaking factor increases from 2015 to 2020 and then steadily decreases from 2020 through build-out. The peaking factor decreases over time because the increase in population is greater in comparison to the amount of land being developed and contributing to I&I. As presented in Table 6.10, the simulated peaking factor has an inverse relationship with the population density (total population divided by the total developed area). The lowest population density occurs in 2020, which corresponds to the highest simulated peaking factor. The highest population density occurs in the build-out scenario, which corresponds to the lowest simulated peaking factor.

| Table 6.9 Summary of Projected and Simulated Flows Southwest WWCS Master Plan Update Manatee County | | | | | | |
|--|--|------------------------------------|----------------------------------|--------------------------------------|--|---|
| Year | Projected Flows (mgd)⁽¹⁾ | | | Average Simulated Flows (mgd) | | Simulated Peaking Factor⁽⁵⁾ |
| | AADF | Maximum Month⁽²⁾ | Maximum Day⁽³⁾ | LOS | Maximum Wet Weather⁽⁴⁾ | |
| 2015 | 15.2 | 19.9 | 39.9 | 15.9 | 40.6 | 2.55 |
| 2020 | 15.8 | 20.7 | 41.3 | 16.5 | 44.9 | 2.72 |
| 2025 | 16.5 | 21.6 | 43.1 | 16.8 | 45.5 | 2.71 |
| 2035 | 17.7 | 23.2 | 46.4 | 18.1 | 47.0 | 2.60 |
| Planned Development | 19.3 | 25.2 | 50.5 | 19.6 | 47.7 | 2.43 |
| Build-Out | 21.9 | 28.7 | -- ⁽⁶⁾ | 22.4 | 51.0 | 2.28 |

Notes:

(1) Based on TAZ populations and LOS per capita for the Southwest Service Area, plus average daily flow from the Town of Longboat Key (which was assumed constant throughout the planning period) and average daily flows from the USF/Airport areas.

(2) Based on the County's Peaking Factor of 1.31 per County Policy 9.1.3.1.

(3) Based on 5-year maximum historical maximum day peaking factor (2.62).

(4) Based on sanitary loads and day of maximum flow from September 2013 3-day storm event.

(5) Calculated by dividing maximum day wet weather flow by the average LOS flow.

(6) Maximum day peaking factor of 2.62 is not anticipated at build-out due to the increased population density (persons/acre) as described below and in Table 6.10.

| Table 6.10 Comparison of Simulated Peaking Factor and Population Density Southwest WWCS Master Plan Update Manatee County | | | | |
|--|---|---|---|---|
| Year | Projected Population⁽¹⁾ | Total Developed Land (acres)⁽²⁾ | Population Density (persons/acres)⁽³⁾ | Simulated Peaking Factor⁽⁴⁾ |
| 2015 | 115,425 | 18,043 | 6.40 | 2.55 |
| 2020 | 120,213 | 20,035 | 6.00 | 2.81 |
| 2025 | 125,044 | 20,035 | 6.24 | 2.75 |
| 2035 | 134,615 | 20,035 | 6.71 | 2.60 |
| Planned Development | 148,003 | 20,035 | 7.39 | 2.43 |
| Build-Out | 167,969 | 21,285 | 7.89 | 2.28 |

Notes:

(1) Based on TAZ population for the inland Southwest Service Area. Projected population from 2015 through planned development scenario does not include parcels served by septic. The build-out population does include parcels served by septic.

(2) Not including the Town of Longboat Key.

(3) Population density is equal to projected population divided by total developed land (acres).

(4) Calculated by dividing maximum wet weather flow by the average LOS flow.

Figure 6.18 shows a comparison of the SWWRF permitted capacity with flows projected using the strict interpretation of the LOS, the simulated LOS flows, and projections using the actual per capita wastewater generation factor (84.75 gpcd, calculated during model calibration). If current and future system loads are calculated using the actual per capita factor, the SWWRF would not be expected to reach capacity until after the end of this Master Plan period (2035). It is recommended that the County continue to monitor the actual per capita factor, perform periodic reviews of the expected LOS, and update projections and wet weather model simulations accordingly.

6.9 SUMMARY

Wastewater collection system infrastructure recommended in Chapters 5 and 6 will allow the existing system to meet the County's selected performance criteria and provide wastewater service to future growth within the County's Southwest Service Area. The primary wastewater collection system issues the County will need to address in the near future are the hydraulic challenges associated with master lift station discharge force mains, the upgrade of the force mains connecting upstream of the SWWRF influent pipe, and the capacity limitation in the 24-inch gravity pipe upstream of MLS 1-M (RTU 203). The County was already aware of the capacity limitations in the force mains stated above and has CIP projects in place to alleviate them (see Appendix I). A new project to extend the MLS #5 (RTU 071) force main all the way to MLS 1-M (RTU 203) to divert a large portion of flow from the 24-inch gravity main on Cortez Road was identified in this Master Plan as a high priority project.

Other issues identified in the Southwest Service Area included force mains with limited capacity (velocities higher than 6 fps for long durations), lift stations with firm capacity exceeded during LOS conditions, and localized surcharges and/or overflows in the gravity system due to capacity constraints. These issues were gradually solved between planning years 2025 and 2035 with several infrastructure improvement projects. Improvements are also required due to the additional flows expected from the USF/Airport areas.

It should be noted that the exact alignment of force mains assumed in this Wastewater Master Plan Update may vary depending on the location and timing of planned developments and other projects such as streets, stormwater, and potable water infrastructure. Minor changes in pipeline alignment or lift station location should not impact overall modeling results.

Not only does the County have the task of correcting existing deficiencies and providing service for future growth, but they also face the task of replacing aging infrastructure. A separate analysis, the Force Main and Valve Asset Management Plan (AMP), was performed by Carollo in 2014. The purpose of the AMP Study was to evaluate the County's existing infrastructure and assign each force main and valve a risk score (based on vulnerability and criticality).

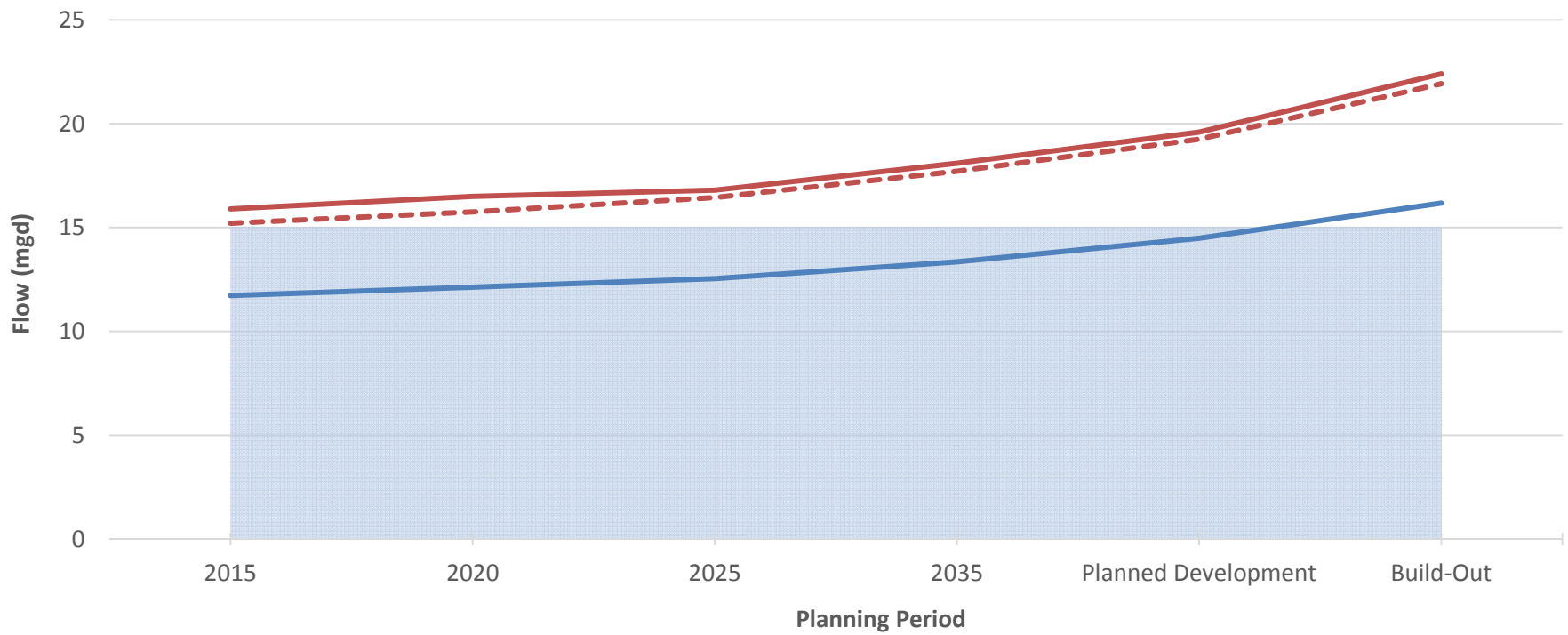

- Current SWWRF Permitted Capacity
- Projected AADF Based on TAZ Population and LOS per Capita (1)
- Average Simulated LOS Flows (1)
- Projected Sanitary Flows Based on TAZ Population and Actual Per Capita Factor (1)

PERMITTED VS. PROJECTED SWWRF CAPACITY

Note:
 1. Includes flow from Longboat Key and USF/Airport area.

FIGURE 6.18
 MANATEE COUNTY
 SOUTHWEST WWCS MASTER PLAN UPDATE



Of the high risk force mains, over 95 percent are located in the Southwest Service Area. The remaining useful life of the County's force mains were estimated (based on age and the average useful life of the material), and the projected expenses associated with replacing force mains at the end of their useful life were established. Although the replacement of aging infrastructure is not included in the recommendations shown in this Chapter 6, the results of the AMP study are incorporated into the CIP tables presented in Chapter 7.

Table 6.11 provides a summary of the infrastructure added in each of the future scenarios. The majority of new infrastructure is added in 2020 due to the projects in the current FY 2015-2019 CIP and all future developments coming online in 2020. The infrastructure added in 2025 includes the bulk of the new projects recommended as part of this Master Plan, based on the existing (2015) and future scenario evaluations. A few projects are included by planning year 2035. The amount of infrastructure added in the planned development and build-out scenarios is not considered significant and is much smaller than in the Southeast and North Service Areas.

The pipe lengths listed throughout this chapter include force mains connecting the future planned developments to the network. Developers will be expected to pay to install force mains up to the point where it ties into a common (major) transmission force main.

Chapter 7 provides a 20-year CIP and a detailed description of the recommended County projects through 2035. Developer funded projects are not included in the County's CIP.

| Table 6.11 Summary Recommended Future Infrastructure Southwest WWCS Master Plan Update Manatee County | | | | | |
|--|------------------------|------------------------|------------------------|---|-----------------------------|
| | 2020 (Feet) | 2025 (Feet) | 2035 (Feet) | Planned Development (Feet) | Build-Out (Feet) |
| Force Main Diameter | | | | | |
| 4 | 5,523 | | | | 21,944 |
| 6 | 1,598 | | | | 1,492 |
| 8 | 11,987 | 1,615 | | | |
| 10 | | | | | |
| 12 | 845 | 7,962 | | 8,296 | 2,171 |
| 14 | | | | | |
| 16 | 9,502 | 800 | | | |
| 18 | 4,776 | | | | |
| 20 | 26,555 | | 1,027 | | |
| 24 | 11,447 | | | | |

| Table 6.11 Summary Recommended Future Infrastructure Southwest WWCS Master Plan Update Manatee County | | | | | |
|--|------------------------|------------------------|------------------------|---|-----------------------------|
| | 2020 (Feet) | 2025 (Feet) | 2035 (Feet) | Planned Development (Feet) | Build-Out (Feet) |
| 27 | 25,360 | | | | |
| 30 | | | | | |
| 36 | | | | | |
| 42 | 6,870 | | | | |
| Total Force Main Length | 104,463 | 10,377 | 1,027 | 8,296 | 25,607 |
| Gravity Main Diameter | | | | | |
| 12 | | | 1,061 | | |
| 21 | | 1,247 | | | |
| 24 | | 2,328 | 1,430 | | |
| Total Gravity Main Length | 0 | 3,575 | 2,491 | 0 | 0 |
| New Lift Stations | 5 | 1 | 0 | 1 | 11 |
| Existing Lift Stations with New Pumps | 1 | 9 | 1 | 0 | 1 |

Although this Southwest WWCS Master Plan Update and CIP present a planning scenario based on best available information, the County should continue to update the land use plan, collection system hydraulic model, and Master Plan as new developments, land use changes, or additional information becomes available. The County should also continue with efforts to identify and rehabilitate areas vulnerable to I&I.

CAPITAL IMPROVEMENT PROGRAM

7.1 INTRODUCTION

This chapter presents a 5-, 10-, and 20-year capital improvements program (CIP) based on the recommendations in Chapters 5 and 6. The CIP provides an estimate of the planning level costs associated with the improvements recommended through the 20-year (2035) planning period. Cost estimates prepared for the CIP were developed based on information obtained from recent, local bid tabs for similar projects and various unit cost sources. The costs included in the CIP are based on 2016 dollars; therefore, costs for projects in future years must be escalated to account for inflation and other applicable increases. The CIP also includes a detailed schedule for the 5-year period based on relative priority of the recommended projects.

The remainder of Chapter 7 includes the following sections:

Section 7.2 - Cost Estimating Accuracy: Describes the expected level of accuracy for master planning cost estimates.

Section 7.3 - Cost Estimating Methodology and Unit Costs: Summarizes the methods and assumptions used in developing cost estimates.

Section 7.4 - Wastewater Collection System Cost Estimates: Outlines recommended wastewater system improvements and estimated costs for projects needed within the 20-year timeframe. The projects are identified as County funded projects or developer contributed assets.

Section 7.5 - 5-Year CIP: Provides the 5-year wastewater system CIP and a detailed implementation based on relative priority of County projects and benefit to the system.

Section 7.6 - 10-Year CIP: Provides the 10-year wastewater system CIP based on relative priority of County projects and benefit to the system.

Section 7.7 - 20-Year CIP: Provides the 20-year wastewater system CIP based on relative priority of County projects and benefit to the system.

Section 7.8 - CIP Summary: Summarizes the CIP for the wastewater collection system through 2035.

7.2 COST ESTIMATING ACCURACY

Cost estimates have been developed to help the County prepare budgets for the projects identified in this Master Plan Update. The level of accuracy for cost estimates varies depending on the level of detail to which the project has been defined. Planning level estimates usually represent a Class 4 or Class 5 level of accuracy, while final plans and specifications present the highest level of accuracy, or Class 1. The Association for the Advancement of Cost Engineering (AACE) International has developed the following guidelines for anticipated cost estimate accuracy based on the type of estimate:

| <u>Type of Cost Estimate</u> | <u>Anticipated Accuracy</u> |
|---------------------------------------|-----------------------------|
| Class 5 (Conceptual) | +100% to -50% |
| Class 4 (Planning Level) | +50% to -30% |
| Class 3 (Preliminary Design) | +30% to -15% |
| Class 2 (50 to 70% Design Completion) | +20% to -10% |
| Class 1 (Pre-Bid) | +15% to -5% |

The cost estimates presented in this Master Plan Update are considered Class 4 accuracy level unless otherwise noted.

7.3 COST ESTIMATING METHODOLOGY AND UNIT COSTS

Cost estimates were calculated for the recommended improvements based on the length and diameter of pipes, and based on power consumption (horsepower) for pumps. In the Southwest Service Area, pipe improvements are required in both force main and gravity pipelines and therefore cost estimates include both. Manholes are not included in cost estimates when the deficiency relies on the gravity lines around and not on the manhole itself. Proposed lift station upgrades such as pump replacements are also included in the cost estimates. Costs are presented in 2016 dollars and must be escalated for future years.

Summaries of the unit pipe costs are provided in Table 7.1. These costs were developed using bid tabulations from twenty recent County pipeline projects. A range of projects were included with segments of open cut and trenchless construction, in rural and urban areas. The construction cost per LF includes mobilization, demobilization, clearing and grubbing, dewatering, maintenance of traffic, special connections, excavation, restoration, and fittings.

A 30 percent factor was applied to the construction cost of force mains for contingency and land acquisition costs. It should be noted that land acquisition costs are highly variable and could exceed this estimate. Contingency accounts for project unknowns at the planning level, such as pipe alignment, pipe material, and site conditions. Since this cost reflects only construction costs, a 25 percent factor for engineering, construction inspection and management, legal fees, and administration was applied to the total unit construction costs. For pump replacements, a 30 percent factor for contingency was applied to the pump cost given that it is assumed that the County would directly procure and install the equipment.

| Table 7.1 Unit Pipe Costs for PVC and DIP Southwest WWCS Master Plan Update Manatee County | | | | |
|---|----------------------------------|---|---|-----------------------------------|
| Diameter | Construction Cost (\$/LF) | 30% Contingency and Land Acquisition (\$/LF) | 25% Legal, Admin, Engineering Services during Construction (\$/LF) | Total Project Cost (\$/LF) |
| 4 | \$61.00 | \$18.30 | \$19.83 | \$99.13 |
| 6 | \$92.00 | \$27.60 | \$29.90 | \$149.50 |
| 8 | \$123.00 | \$36.90 | \$39.98 | \$199.88 |
| 10 | \$154.00 | \$46.20 | \$50.05 | \$250.25 |
| 12 | \$184.00 | \$55.20 | \$59.80 | \$299.00 |
| 14 | \$215.00 | \$64.50 | \$69.88 | \$349.38 |
| 16 | \$246.00 | \$73.80 | \$79.95 | \$399.75 |
| 18 | \$277.00 | \$83.10 | \$90.03 | \$450.13 |
| 20 | \$307.00 | \$92.10 | \$99.78 | \$498.88 |
| 21 | \$323.00 | \$96.75 | \$80.63 | \$499.88 |
| 24 | \$369.00 | \$110.70 | \$119.93 | \$599.63 |
| 30 | \$461.00 | \$138.30 | \$149.83 | \$749.13 |
| 36 | \$713.00 | \$213.90 | \$231.73 | \$1,158.63 |
| 48 | \$951.00 | \$285.30 | \$309.08 | \$1,545.38 |
| Notes: | | | | |
| (1) Cost estimates are based on PVC material for pipe sizes 4 to 30 inches and DI for pipes 32 inches and larger. | | | | |

Costs used for submersible pumps by power usage are summarized in Table 7.2. These power-cost relationships follow a statistical regression developed from cost data of previous lift station planning and design projects. The horsepower-cost relationship shown is not scalable to equipment with larger horsepower and therefore is only intended for application at non-master lift stations. It should also be noted that these are costs per each pumping unit, and that design redundancy is necessary since lift stations operate unattended and must be reliable to prevent overflows of the collection system. Therefore, twice the cost shown in Table 7.2 is included per lift station when a pump upgrade was recommended.

| Table 7.2 Pump Replacement Costs by Horsepower⁽¹⁾ Southwest WWCS Master Plan Update Manatee County | | |
|--|---|------------------------|
| Horsepower (hp) | Pump Cost (Per Pump, \$)⁽²⁾ | 30% Contingency |
| 5 | \$12,720 | \$16,535 |
| 15 | \$15,384 | \$19,999 |
| 25 | \$16,556 | \$21,523 |
| 50 | \$20,698 | \$26,907 |
| 60 | \$22,504 | \$29,256 |
| 75 | \$25,082 | \$32,606 |

Notes:
(1) For use at non-master lift stations.
(2) Costs not scalable to equipment with horsepower larger than shown in this table.

7.4 WASTEWATER COLLECTION SYSTEM COST ESTIMATES

Table 7.3 presents a list of recommended wastewater infrastructure improvements to correct system deficiencies (to allow the system to meet the County's performance criteria) and to accommodate future growth. In some cases, several improvements of the same type were grouped into a single project. A detailed description of each project and the conditions in the collection system has been included in Chapter 6. The construction year for projects already in the County FY 2015-2019 CIP remains the same regardless of recommended changes.

Most new projects identified in this Master Plan Update are anticipated to come online by the 2025 planning period based on the amount of time it takes to budget, plan, design, procure, and construct a CIP project. Other projects of less priority based on relative risk to the collection system are proposed to come online by year 2035. The County may choose to construct those projects by 2025 if funds are available.

The locations of the recommended projects listed in Table 7.3 are shown in Figure 7.1 with the corresponding project numbers identified. CIP forms for each of the projects shown in Table 7.3 are included in Appendix J.

| Table 7.3 Master Plan Recommended Infrastructure Improvements Southwest WWCS Master Plan Update Manatee County | | | | | |
|---|--|------------------------|----------------------|--------------------------------|------------------------------------|
| Master Plan Project | | | | | Project Cost Estimate (\$M) |
| Lift Station Evaluation/Replacement Projects | | | | | |
| Project ID | Description | | | Recommended Year Online | Total Project Cost |
| SW-1 | Bayshore Yacht Basin Lift Station relocation and upgrades. Project includes new building, new pumps with variable frequency drives, 16-foot square wet well, and 800 LF of 16-inch force main ⁽¹⁾ | | | 2025 | \$3.50 |
| SW-2 | Upsize Lift Station 9-A (RTU 436) force main (approximately 6,060 feet) to 12-inch pipe, replace the pumps (40 hp), and evaluate and upsize wet well ⁽²⁾ | | | 2025 | \$2.26 |
| Subtotal Lift Stations | | | | | \$5.76 |
| Pipeline Projects | | | | | |
| Project ID | Description | Diameter (inch) | Length (feet) | Recommended Year Online | Total Project Cost |
| SW-3 | Extend MLS #5 (RTU 071) force main along Cortez Road to MLS 1-M (RTU 203) ⁽³⁾ | 20 | 10,113 | 2020 | \$5.05 |
| SW-4 | Upsize force main connecting Lift Stations 2-A, 1-A, and 16-A (RTUs 439, 135, and 440) to MLS 12-A | 20 | 965 | 2025 | \$0.48 |
| SW-5 | Upsize Lift Station 7-A (RTU 137) force main | 8 | 1,615 | 2025 | \$0.32 |
| SW-6 | Upsize Lift Station 6-A (RTU 136) force main | 12 | 1,902 | 2025 | \$0.57 |
| SW-7 | Upsize MLS 36-A (RTU 241) influent gravity main | 21 | 1,247 | 2025 | \$1.11 |
| | | 24 | 850 | | |
| SW-8 | Upsize MLS 13-A (RTU 408) Influent Gravity Main | 24 | 1,350 | 2035 | \$0.81 |

| Table 7.3 Master Plan Recommended Infrastructure Improvements Southwest WWCS Master Plan Update Manatee County | | | | | |
|---|--|------------------------|------------------------|--------------------------------|------------------------------------|
| Master Plan Project | | | | | Project Cost Estimate (\$M) |
| SW-9 | Upsize Force Main on US 41 (from Magellan Drive to 69th Avenue West) | 16 | 1,027 | 2035 | \$0.41 |
| SW-10 | Upsize the existing 8-inch gravity main upstream of MLS 1-M (RTU 203) on Palma Sola Boulevard. | 12 | 1,061 | 2035 | \$0.32 |
| Subtotal Pipeline Projects | | | | | \$9.07 |
| Pump Replacement Projects | | | | | |
| Project ID | Description | Horsepower (hp) | Number of Pumps | Recommended Year Online | Total Project Cost |
| SW-11 | Replace pumps at the following RTUs to prevent manhole overflows and surcharging in upstream gravity system: 136 457 | 15 | 2 (each) | 2025 | \$0.04 |
| | | 10 | | | \$0.04 |
| SW-12 | Replace pumps at the following RTUs to prevent surcharging in upstream gravity system: 217 437 | 15 | 2 (each) | 2025 | \$0.04 |
| | | 5 | | | \$0.03 |
| SW-13 | Replace pumps at the following RTUs to provide additional capacity for USF/Airport flows: 137 149 | 5 | 2 (each) | 2025 | \$0.03 |
| | | 2 | | | \$0.03 |

| Table 7.3 Master Plan Recommended Infrastructure Improvements Southwest WWCS Master Plan Update Manatee County | | | | | |
|---|---|----|----------|------|------------------------------------|
| Master Plan Project | | | | | Project Cost Estimate (\$M) |
| SW-14 | Replace pumps at the following RTUs to meet firm pump capacity under future LOS conditions ⁽⁴⁾ : | | 2 (each) | 2025 | |
| | 108 | 15 | | | \$0.04 |
| | 116 | 20 | | | \$0.04 |
| | 141 | 15 | | | \$0.04 |
| | 258 | 2 | | | \$0.03 |
| | 319 | 15 | | | \$0.04 |
| | 342 | 30 | | | \$0.05 |
| SW-15 | Replace pumps at Airport Industrial Park lift station (RTU 469) | 2 | 2 | 2035 | \$0.03 |
| Subtotal Pump Replacement Projects | | | | | \$0.48 |
| Total | | | | | \$15.31 |
| Notes: | | | | | |
| (1) Carollo completed a cost estimate for this project as part of the County's 2016 CIP planning. | | | | | |
| (2) Cost estimate based on a 12-foot diameter wet well. Actual wet well sizing should be determined by project design engineer. | | | | | |
| (3) Because this is expected to be partially funded by developers, the County anticipates this project coming online by 2020. | | | | | |
| (4) Firm pumping capacity exceeded during LOS scenario based on rated pump capacity provided by County. | | | | | |

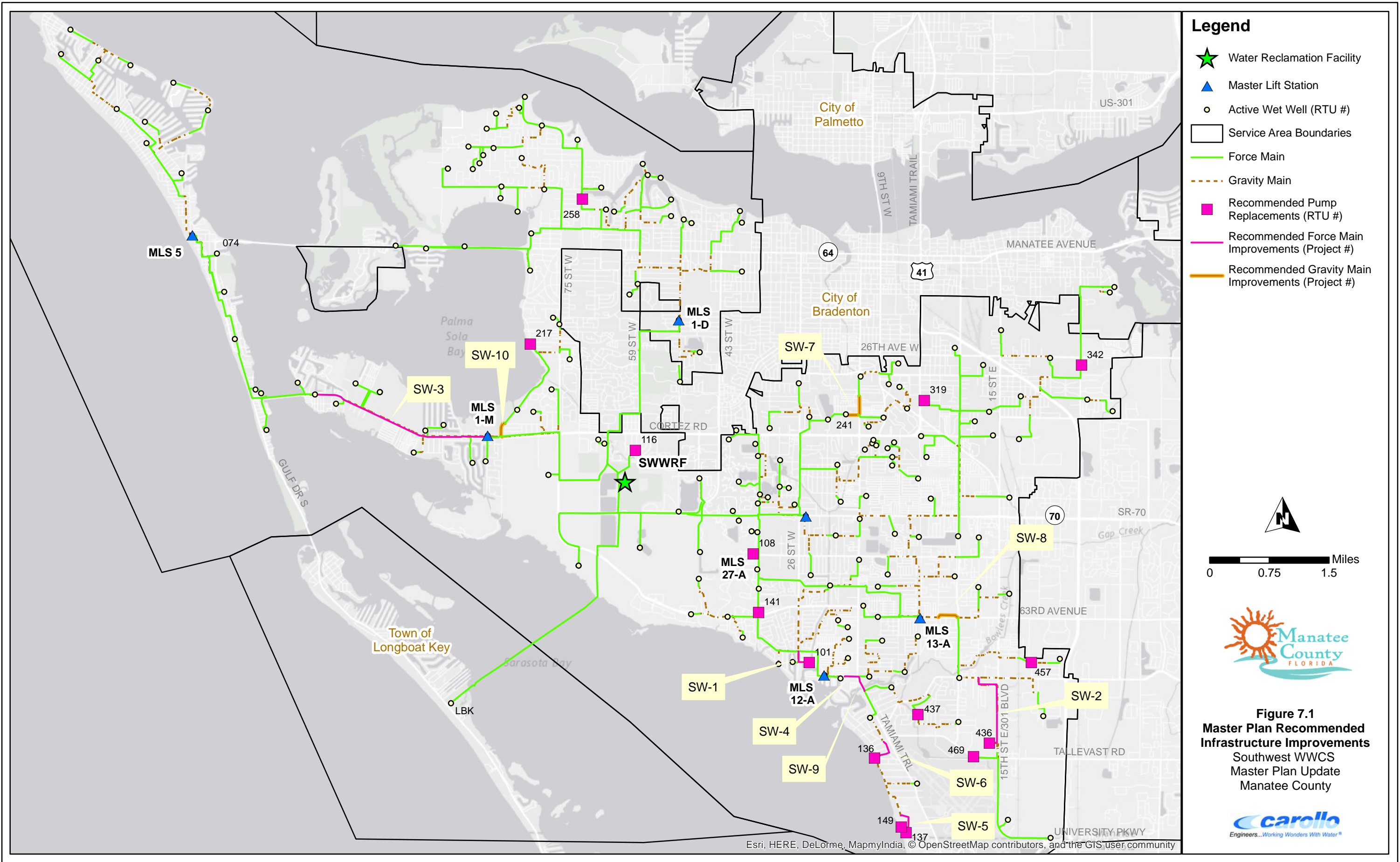

- Legend**
- Water Reclamation Facility
 - Master Lift Station
 - Active Wet Well (RTU #)
 - Service Area Boundaries
 - Force Main
 - Gravity Main
 - Recommended Pump Replacements (RTU #)
 - Recommended Force Main Improvements (Project #)
 - Recommended Gravity Main Improvements (Project #)

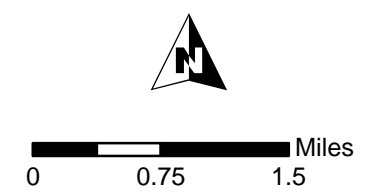

Figure 7.1
Master Plan Recommended
Infrastructure Improvements
 Southwest WWCs
 Master Plan Update
 Manatee County



Esri, HERE, DeLorme, MapmyIndia, © OpenStreetMap contributors, and the GIS user community

Recommended changes to current FY 2015-2019 CIP projects are summarized in Table 7.4. Table 7.4 also shows the estimated cost savings that may be achieved due to the proposed diameter reductions with respect to the diameter in the currently planned CIP project. As explained in Chapter 6, the different force main segments of each CIP were evaluated separately. As a result, the entire length of all projects has not been recommended for change in all cases. Table 7.4 shows the percent savings with respect to the portion of the CIP project proposed for change. It also shows the percent of the project for which changes have been proposed. These two percentages were used to calculate a total estimated savings with respect to the adopted CIP. Total estimated savings are shown in Table 7.4 and reflected in proposed 20-year CIP.

Recommended changes to CIP projects are shown in Figure 7.2 grouped by color per the original description in the County's FY 2015-2019 CIP. Lengths are included so pipe segments can be easily related to segments in the CIP descriptions as presented in Chapter 6 and Table 7.4.

| Table 7.4 Recommended Changes to FY 2015-2019 CIP Projects Southwest WWCS Master Plan Update Manatee County | | | | | | | | |
|--|--|-----------------------------|----------------------------|---------------|--------------------------------------|---|---|---|
| FY 2015-2019 CIP Project | | | As Proposed in Master Plan | | | | | |
| Project ID | Description | FY 2015-2019 CIP Cost (\$M) | Diameter (inch) | Length (feet) | Estimated Savings ⁽¹⁾ (%) | Entire Project Length ⁽²⁾ (feet) | Percent of Project Changed ⁽³⁾ (%) | Savings with Respect to FY 2015-2019 CIP Cost (\$M) |
| WW00974 | MLS #5 Force Main Replacement | \$4.17 | 16 | 8,781 | 30.4% | 13,557 | 100% | \$1.27 |
| | | | 18 | 3,465 | | | | |
| | | | 18 | 1,311 | | | | |
| WW00975 | MLS 12-A Force Main Replacement - First Segment Only | \$4.50 | 20 | 3,393 | 16.7% | 10,297 | 33% | \$0.25 |
| 6035781 | MLS 1-D Force Main Replacement | \$3.00 | 20 | 4,637 | 22.6% | 12,150 | 100% | \$0.68 |
| | | | 20 | 7,513 | | | | |

| Table 7.4 Recommended Changes to FY 2015-2019 CIP Projects Southwest WWCS Master Plan Update Manatee County | | | | | | | | |
|--|---|-----------------------------|----------------------------|---------------|--------------------------------------|---|---|---|
| FY 2015-2019 CIP Project | | | As Proposed in Master Plan | | | | | |
| Project ID | Description | FY 2015-2019 CIP Cost (\$M) | Diameter (inch) | Length (feet) | Estimated Savings ⁽¹⁾ (%) | Entire Project Length ⁽²⁾ (feet) | Percent of Project Changed ⁽³⁾ (%) | Savings with Respect to FY 2015-2019 CIP Cost (\$M) |
| 6085780 | Extension of MLS 1-D Force Main, part of the MLS 1-M Force Main CIP Description | \$2.72 | 20 | 205 | 37.6% | 16,730 | 13.5% | \$0.14 |
| | | | 20 | 694 | | | | |
| | | | 24 | 1,364 | | | | |
| WW00976 | MLS 13-A Force Main Replacement - Second Segment Only | \$5.28 | 27 | 304 | 25.0% | 13,255 | 2.3% | \$0.03 |
| WW01037 | Lift Station 23-A Force Main Replacement | \$0.33 | 8 | 1,385 | -33.7% ⁽⁴⁾ | 1,385 | 100% | (\$0.11) ⁽⁴⁾ |
| Total Savings due to Recommended Changes to FY 2015-2019 CIP Projects (\$M) | | | | | | | | \$2.25 |
| Notes: (1) With respect to the CIP costs for the segment proposed for change. (2) Scaled (from model) length of segments included in the original CIP description. (3) Based on length only. (4) Additional expenditures instead of savings. Proposed change includes upsize of the planned CIP project from 6-inch to 8-inch pipe. | | | | | | | | |

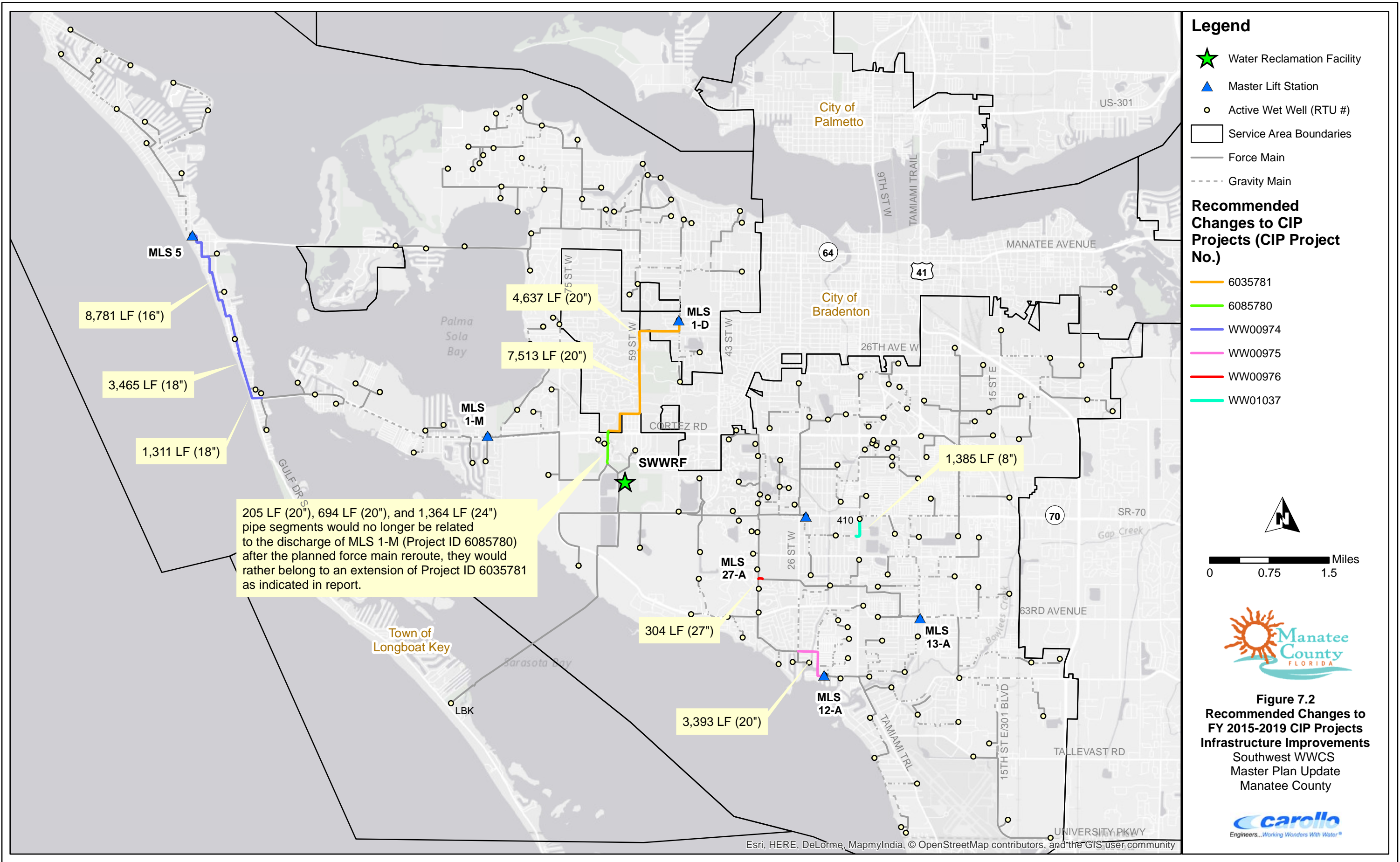

Legend

- Water Reclamation Facility
- Master Lift Station
- Active Wet Well (RTU #)
- Service Area Boundaries
- Force Main
- Gravity Main

Recommended Changes to CIP Projects (CIP Project No.)

- 6035781
- 6085780
- WW00974
- WW00975
- WW00976
- WW01037

205 LF (20\"), 694 LF (20\"), and 1,364 LF (24\") pipe segments would no longer be related to the discharge of MLS 1-M (Project ID 6085780) after the planned force main reroute, they would rather belong to an extension of Project ID 6035781 as indicated in report.

Figure 7.2
Recommended Changes to
FY 2015-2019 CIP Projects
Infrastructure Improvements
 Southwest WWCs
 Master Plan Update
 Manatee County

7.5 5-YEAR CIP

The County has an adopted 5-year CIP (FY 2015-2019) as mentioned above. The projects listed in the CIP, with the proposed changes, are included in the 2020 scenario. Upon County adopting the recommended changes, it is also recommended that planning-level savings presented in Table 7.4 be evaluated at a design phase level, and results be incorporated into the adopted CIP. The only additional pipelines which were included in the 2020 scenario that are not in the County's current CIP are the force mains that will serve planned developments coming online by 2020 and the MLS #5 (RTU 071) force main extension. The estimated cost for the MLS #5 force main extension is \$5,050,000.

7.6 10-YEAR CIP

The 10-year CIP extends through 2025 and includes recommended future CIP projects to alleviate existing capacity restrictions in force mains and gravity pipelines. The total estimated cost of the Southwest Service Area recommended Master Plan projects for FY 2021 through 2025 is \$8,690,000.

7.7 20-YEAR CIP

New infrastructure coming online between 2025 and 2035 is mostly proposed infrastructure to alleviate lower risk deficiencies identified during the 2015 and 2020 scenarios. The total estimated cost of recommended Master Plan projects for the Southwest Service Area for FY 2026 through 2035 is \$1,570,000.

Table 7.5 provides a detailed 20-year CIP, which includes the projects in the County's most recent published CIP (FY 2015-2019), projects recommended in the Force Main and Valve Asset Management Plan (AMP) completed by Carollo in 2014, and the recommended projects developed in this Master Plan Update. Table 7.5 also includes the cost savings based on recommended changes to existing CIP projects.

7.8 SUMMARY

Table 7.6 provides a summary of the total 20-year CIP, including existing CIP projects, recommended master plan projects, and projects recommended in the AMP.

| Table 7.5 Complete 20-Year Wastewater Collection System CIP Southwest WWCS Master Plan Update Manatee County | | | | | | | | | | | | |
|--|--|--------------------|---------------|---------------|---------------|---------------|---------------|---------------|---------------|---------------|---------------|--------------------|
| CIP/ Project Number | Description | Fiscal Year | | | | | | | | | | |
| | | 2016 | 2017 | 2018 | 2019 | 2020 | 2021 | 2022 | 2023 | 2024 | 2025 | 2026 - 2035 |
| Southwest Service Area Existing CIP Projects⁽¹⁾ and Potential Associated Cost Change Identified in this Master Plan (in \$M) | | | | | | | | | | | | |
| WW00975 | Force Main 12A Rehabilitation | \$4.50 | - | - | - | - | - | - | - | - | - | - |
| WW00976 | Force Main 13A Rehabilitation | \$4.40 | \$0.88 | - | - | - | - | - | - | - | - | - |
| WW01036 | Force Main 17A Replacement | \$0.32 | - | - | - | - | - | - | - | - | - | - |
| 6035781 | Force Main 1D Rehabilitation | \$3.00 | - | - | - | - | - | - | - | - | - | - |
| 6085780 | Force Main 1M Rehabilitation | \$2.72 | - | - | - | - | - | - | - | - | - | - |
| WW00978 | Force Main 27A Rehabilitation | \$1.70 | - | - | - | - | - | - | - | - | - | - |
| WW01038 | Force Main 31A Replacement | \$0.52 | - | - | - | - | - | - | - | - | - | - |
| WW00974 | Force Main 5 Rehabilitation | \$3.50 | \$0.67 | - | - | - | - | - | - | - | - | - |
| WW01037 | Lift Station 23-A Force Main Replacement | \$0.33 | - | - | - | - | - | - | - | - | - | - |
| WW01225 | MLS 12A Emergency Generator Replacement | \$0.46 | - | - | - | - | - | - | - | - | - | - |
| WW01226 | MLS 12A Pumps and VFD Replacement | - | - | \$0.52 | - | - | - | - | - | - | - | - |
| WW01229 | MLS 1D Wet Well Rehab and Dimminutor Replacement | \$0.59 | - | - | - | - | - | - | - | - | - | - |
| WW01232 | MLS 27A Pumps & VFD Replacement | - | - | \$0.52 | - | - | - | - | - | - | - | - |
| WW01236 | MLS 5 Wet Well Rehabilitation | \$0.46 | - | - | - | - | - | - | - | - | - | - |
| Southwest CIP Projects - Subtotal | | \$22.49 | \$1.55 | \$1.05 | - | - | - | - | - | - | - | - |
| North County CIP Projects - Subtotal | | \$5.42 | - | \$0.52 | - | - | - | - | - | - | - | - |
| Southeast CIP Projects - Subtotal | | \$1.12 | \$2.62 | \$5.00 | - | - | - | - | - | - | - | - |
| County-Wide Existing CIP Projects⁽¹⁾ (in \$M) | | | | | | | | | | | | |
| WW01258 | Lift Station Repair, Replacement, and Generators | - | - | - | \$1.50 | - | - | - | - | - | - | - |
| WW01259 | End of Service Life Collection Line Replacement ⁽²⁾ | - | \$2.50 | \$3.00 | \$3.50 | \$2.00 | \$2.00 | \$2.00 | \$2.00 | \$2.00 | \$2.00 | \$20.00 |
| Subtotal County-Wide Projects | | - | \$2.50 | \$3.00 | \$5.00 | \$2.00 | \$2.00 | \$2.00 | \$2.00 | \$2.00 | \$2.00 | \$20.00 |
| Existing CIP Total | | \$29.02 | \$6.67 | \$9.57 | \$5.00 | \$2.00 | \$2.00 | \$2.00 | \$2.00 | \$2.00 | \$2.00 | \$20.00 |

| Table 7.5 Complete 20-Year Wastewater Collection System CIP Southwest WWCS Master Plan Update Manatee County | | | | | | | | | | | | |
|---|---|--------------------|-------------|-------------|-------------|---------------|---------------|---------------|---------------|-------------|---------------|------------------------|
| CIP/ Project Number | Description | Fiscal Year | | | | | | | | | | |
| | | 2016 | 2017 | 2018 | 2019 | 2020 | 2021 | 2022 | 2023 | 2024 | 2025 | 2026 - 2035 |
| Savings on CIP Projects due to Evaluation under the Master Plan Updates⁽³⁾ | | | | | | | | | | | | |
| Southeast | | - | (\$0.81) | (\$3.24) | - | - | - | - | - | - | - | - |
| Southwest | | (\$2.25) | - | - | - | - | - | - | - | - | - | - |
| Southwest Recommended Master Plan Projects (in \$M) | | | | | | | | | | | | |
| Lift Station Evaluation/Replacement Projects | | | | | | | | | | | | |
| SW-1 | Bayshore Yacht Basin Lift Station relocation and upgrades. Project includes new building, new pumps with variable frequency drives, 16-foot square wet well, and 800 LF of 16-inch force main | - | - | - | - | - | \$0.50 | \$1.50 | \$1.50 | - | - | \$3.50 |
| SW-2 | Upsize Lift Station 9-A (RTU 436) force main (approximately 6,060 feet) to 12-inch pipe, replace pumps (40 hp) and evaluate and upsize wet well | - | - | - | - | - | \$1.13 | \$1.13 | - | - | - | \$2.26 |
| Recommended Lift Station Projects Subtotals | | - | - | - | - | - | \$1.63 | \$2.63 | \$1.50 | - | - | \$5.76 |
| Pipeline Projects | | | | | | | | | | | | |
| SW-3 | Extend MLS #5 (RTU 071) force main along Cortez Road to MLS 1-M (RTU 203) | - | - | - | - | \$5.05 | - | - | - | - | - | \$5.05 |
| SW-4 | Upsize Force Main Connecting Lift Stations 2-A, 1-A, and 16-A (RTUs 439, 135, and 440) to MLS 12-A | - | - | - | - | - | \$0.48 | - | - | - | - | \$0.48 |
| SW-5 | Upsize Lift Station 7-A (RTU 137) force main | - | - | - | - | - | \$0.16 | \$0.16 | - | - | - | \$0.32 |
| SW-6 | Upsize Lift Station 6-A (RTU 136) force main | - | - | - | - | - | \$0.29 | \$0.28 | - | - | - | \$0.57 |
| SW-7 | Upsize MLS 36-A influent gravity main | - | - | - | - | - | - | - | - | - | \$1.11 | \$1.11 |
| SW-8 | Upsize MLS 13-A influent gravity main | - | - | - | - | - | - | - | - | - | - | \$0.81 |
| SW-9 | Upsize Force Main on US 41 (from Magellan Drive to 69th Avenue West) | - | - | - | - | - | - | - | - | - | - | \$0.41 |
| SW-10 | Upsize the existing 8-inch gravity main upstream of MLS 1-M (RTU 203) on Palma Sola Boulevard | - | - | - | - | - | - | - | - | - | - | \$0.32 |
| Recommended Pipeline Projects Subtotals | | | - | - | - | \$5.05 | \$0.93 | \$0.44 | - | - | \$1.11 | \$9.07 |
| Pump Replacement Projects | | | | | | | | | | | | |
| SW-11 | Replace pumps at lift station RTUs 136 and 457 | - | - | - | - | - | \$0.08 | - | - | - | - | \$0.08 |
| SW-12 | Replace pumps at lift station RTUs 217 and 437 | - | - | - | - | - | \$0.07 | - | - | - | - | \$0.07 |

| Table 7.5 Complete 20-Year Wastewater Collection System CIP Southwest WWCS Master Plan Update Manatee County | | | | | | | | | | | | |
|---|---|--------------------|---------------|---------------|---------------|---------------|---------------|---------------|---------------|---------------|---------------|------------------------|
| CIP/ Project Number | Description | Fiscal Year | | | | | | | | | | |
| | | 2016 | 2017 | 2018 | 2019 | 2020 | 2021 | 2022 | 2023 | 2024 | 2025 | 2026 - 2035 |
| SW-13 | Replace pumps at lift station RTUs 137 and 149 | - | - | - | - | - | \$0.06 | - | - | - | - | - |
| SW-14 | Replace pumps at lift station RTUs 108, 116, 141, 258, 319, 342 | - | - | - | - | - | - | - | - | - | - | \$0.24 |
| SW-15 | Replace pumps at lift station RTU 469 | - | - | - | - | - | - | - | - | - | - | \$0.03 |
| Recommended Pump Replacement Projects Subtotal | | - | - | - | - | - | \$0.21 | - | - | - | - | \$0.24 |
| Recommended Projects - Southwest Subtotal | | - | - | - | - | \$5.05 | \$2.77 | \$3.07 | \$1.50 | - | \$1.35 | \$1.57 |
| Recommended Projects - North Subtotal | | - | - | - | - | \$1.15 | \$1.17 | \$0.95 | \$0.54 | \$0.54 | \$0.64 | - |
| Recommended Projects - Southeast Subtotal | | \$2.01 | \$1.50 | \$1.68 | \$0.14 | - | \$0.29 | \$0.29 | - | - | - | - |
| Existing CIP and Recommended Projects - Total⁽⁴⁾ | | \$28.78 | \$7.36 | \$8.01 | \$5.14 | \$8.20 | \$6.23 | \$6.31 | \$4.04 | \$2.54 | \$3.99 | \$21.57 |

Notes:

(1) Only includes Collections, Restoration & Rehab, and Transportation-related projects from the adopted FY 2015-2019 CIP. Does not include MARS or Treatment projects.

(2) AMP recommended projects are assumed to be completed using funds from this End of Service Life CIP. A budget amount of \$2 M per year was assumed for fiscal years 2021 through 2035.

(3) Based on estimated percent savings due to changes in pipeline diameter. Savings are based on percent changes to existing County CIP budgets as shown in Table 7.4 for the Southwest Service Area. Please refer to the Southeast Master Plan report for the cost savings in the Southeast Service Area.

(4) Includes cost savings for the Southeast and Southwest Service Areas.

**Table 7.6 20-Year CIP Summary
Southwest WWCS Master Plan Update
Manatee County**

| Description | Service Area | Fiscal Year ⁽¹⁾ | | | | | | | | | | |
|--|----------------------------|----------------------------|-----------------|-----------------|---------------|---------------|---------------|---------------|---------------|---------------|----------------|---------------|
| | | 2016 | 2017 | 2018 | 2019 | 2020 | 2021 | 2022 | 2023 | 2024 | 2025 | 2026 - 2035 |
| Existing CIP Projects ⁽²⁾ | North | \$5.42 | - | \$0.52 | - | - | - | - | - | - | - | - |
| | Southeast | \$1.12 | \$2.62 | \$5.00 | - | - | - | - | - | - | - | - |
| | Southwest | \$22.49 | \$1.55 | \$1.05 | - | - | - | - | - | - | - | - |
| | County-wide ⁽³⁾ | - | \$2.50 | \$3.00 | \$5.00 | \$2.00 | \$2.00 | \$2.00 | \$2.00 | \$2.00 | \$2.00 | \$20.00 |
| | Subtotal | \$29.02 | \$6.67 | \$9.57 | \$5.00 | \$2.00 | \$2.00 | \$2.00 | \$2.00 | \$2.00 | \$2.00 | \$2.00 |
| Savings to CIP Projects Due to Evaluations in Master Plan Updates | Southeast | - | \$(0.81) | \$(3.24) | - | - | - | - | - | - | - | - |
| | Southwest | \$(2.25) | - | - | - | - | - | - | - | - | - | - |
| | Subtotal | \$(2.25) | \$(0.81) | \$(3.24) | - | - | - | - | - | - | - | - |
| Recommended Master Plan Projects | North | - | - | - | - | \$1.15 | \$1.17 | \$0.95 | \$0.54 | \$0.54 | \$0.64 | - |
| | Southeast | \$2.01 | \$1.50 | \$1.68 | \$0.14 | - | \$0.29 | \$0.29 | - | - | - | - |
| | Southwest | - | - | - | - | \$5.05 | \$2.77 | \$3.07 | \$1.50 | - | \$1.35 | \$1.57 |
| | Subtotal | \$2.01 | \$1.50 | \$1.68 | \$0.14 | \$6.20 | \$4.23 | \$4.31 | \$2.04 | \$0.54 | \$1.99 | \$1.57 |
| Existing CIP and Recommended Projects - Total⁽⁴⁾ | \$28.78 | \$7.36 | \$8.01 | \$5.14 | \$8.20 | \$6.23 | \$6.31 | \$4.04 | \$2.54 | \$3.99 | \$21.57 | |

Notes:
(1) Costs shown in \$M.
(2) Includes Collections, Restoration & Rehab, and Transportation-related projects from the adopted FY 2015-2019 CIP. Does not include MARS or Treatment projects.
(3) AMP recommended projects are assumed to be completed using funds from the End of Service Life CIP (which is included in the existing County-wide CIP projects). A budget amount of \$2 M per year was assumed for fiscal years 2021 through 2035.
(4) Includes cost savings for the Southeast and Southwest Service Areas.

CONCLUSIONS AND RECOMMENDATIONS

8.1 INTRODUCTION

The primary goals of the Southwest WWCS Master Plan Update were to update the hydraulic wastewater collection system model, evaluate the existing wastewater collection system, identify system improvements to serve planned developments, and recommend future infrastructure to address existing limitations and serve undeveloped areas. The WWCS Master Plan Update identifies force mains and lift stations that should be constructed to provide wastewater services now through build-out conditions. A CIP was developed, based on the model evaluations and master planning tasks, for the 5-, 10-, and 20-year planning periods. The CIP includes improvements necessary to remediate areas in the system that do not currently meet performance criteria, as well as size infrastructure in undeveloped areas to best accommodate future development.

The following sections provide a summary of the Southwest WWCS Master Plan analyses and conclusions. Recommended projects are provided in a 20-year CIP, which can serve as a budgetary and scheduling planning tool for the County.

8.2 SOUTHWEST WWCS MASTER PLAN CONCLUSIONS

The primary wastewater collection system limitations currently in the Southwest Service Area WWCS include hydraulic challenges associated with master lift station discharge force mains and the slipped-lined gravity pipe upstream of Master Lift Station 1-M during wet weather events. In addition, a few new developments are planned in the Southwest Service Area within the 20-year planning period, which will increase wastewater flow.

The current AADF flow in the Southwest Service Area is 12.97 mgd. Based on the population projections and a strict interpretation of the County's current LOS, the AADF is projected to increase to 17.42 mgd by 2035 and to 18.96 mgd by the planned development scenario, which assumes all of the planned developments within the Southwest Service Area are built out to their maximum capacity. The AADF is estimated to reach 21.25 mgd by ultimate build-out of the service area.

The current permitted capacity of the SWWRF is 15 mgd based on three month rolling average daily flow (3MRADF). The average ratio between the County's annual average daily flow (AADF) and the 3MRADF was determined to be essentially one in the LOS Evaluation project (Carollo, 2015). Based on strict interpretation of the LOS, projected flows indicate that the SWWRF capacity would have been exceeded by 2015. However, when current and future system loads are calculated using the actual per capita factor (84.75 gpcd), the SWWRF is not expected to reach capacity until beyond 2035. It is recommended that the County continue to monitor the actual per capita factor, perform

periodical reviews of the expected LOS, and update projections and simulations accordingly to make the best possible informed decisions.

8.3 CIP RECOMMENDATIONS

The Southwest Service Area CIP, described in Chapter 7, was prepared to develop a planning level cost for the wastewater infrastructure needed within the 5-, 10-, and 20-year timeframes. Projects included in the County's CIP are those that allow the system to meet the County's performance criteria in addition to infrastructure needed to serve future growth. The recommendations also include the replacement of force mains when it reaches the end of its useful life as recommended in the County's Force Main AMP (Carollo, 2014).

Table 8.1 provides a summary of the County's 20-year CIP, including existing CIP projects, savings due to proposed modifications to adopted FY 2015-2019 CIP projects, and projects recommended as part of this Master Plan Update. Projects recommended in the AMP are included with the existing CIP projects. All recommended Master Plan projects were assumed to be included after the FY 2015-2019 CIP due to the amount of time required to plan and budget for a new project. Because the MLS #5 (RTU 071) force main extension will be partially funded by developers, it was assumed to be completed by 2020. The estimated cost for this project is \$5,050,000.

The total estimated cost of the recommended Southwest WWCS Master Plan Update projects from FY 2020 through 2035 is \$15,310,000. Approximately 57 percent represents Master Plan projects recommended for FY 2021 through 2025, while 10 percent was allocated for recommended Master Plan projects to be completed between 2026 and 2035.

**Table 8.1 20-Year CIP Summary
Southwest WWCS Master Plan Update
Manatee County**

| Description | Service Area | Fiscal Year ⁽¹⁾ | | | | | | | | | | |
|---|----------------------------|----------------------------|-----------------|-----------------|---------------|---------------|---------------|---------------|---------------|---------------|---------------|----------------|
| | | 2016 | 2017 | 2018 | 2019 | 2020 | 2021 | 2022 | 2023 | 2024 | 2025 | 2026 - 2035 |
| Existing CIP Projects⁽²⁾ | North | \$5.42 | - | \$0.52 | - | - | - | - | - | - | - | - |
| | Southeast | \$1.12 | \$2.62 | \$5.00 | - | - | - | - | - | - | - | - |
| | Southwest | \$22.49 | \$1.55 | \$1.05 | - | - | - | - | - | - | - | - |
| | County-wide ⁽³⁾ | - | \$2.50 | \$3.00 | \$5.00 | \$2.00 | \$2.00 | \$2.00 | \$2.00 | \$2.00 | \$2.00 | \$20.00 |
| | Subtotal | \$29.02 | \$6.67 | \$9.57 | \$5.00 | \$2.00 | \$2.00 | \$2.00 | \$2.00 | \$2.00 | \$2.00 | \$2.00 |
| Savings to CIP Projects Due to Evaluations in this Master Plan | Southeast | - | \$(0.81) | \$(3.24) | - | - | - | - | - | - | - | - |
| | Southwest | \$(2.25) | - | - | - | - | - | - | - | - | - | - |
| | Subtotal | \$(2.25) | \$(0.81) | \$(3.24) | - | - | - | - | - | - | - | - |
| Recommended Master Plan Projects⁽⁴⁾ | North | - | - | - | - | \$1.15 | \$1.17 | \$0.95 | \$0.54 | \$0.54 | \$0.64 | - |
| | Southeast | \$2.0 | \$1.50 | \$1.68 | \$0.14 | - | \$0.29 | \$0.29 | - | - | - | - |
| | Southwest | - | - | - | - | \$5.05 | \$2.77 | \$3.07 | \$1.50 | - | \$1.35 | \$1.57 |
| | Subtotal | \$2.01 | \$1.50 | \$1.68 | \$0.14 | \$6.20 | \$4.23 | \$4.31 | \$2.04 | \$0.54 | \$1.99 | \$1.57 |
| Existing CIP and Recommended Projects - Total⁽⁵⁾ | | \$28.78 | \$7.36 | \$8.01 | \$5.14 | \$8.20 | \$6.23 | \$6.31 | \$4.04 | \$2.54 | \$3.99 | \$21.57 |

- Notes:
- (1) Costs shown in \$M.
 - (2) Includes Collections, Restoration & Rehab, and Transportation-related projects from the adopted FY 2015-2019 CIP. Does not include MARS or Treatment projects.
 - (3) AMP recommended projects are assumed to be completed using funds from the End of Service Life CIP (which is included in the existing County-wide CIP projects). A budget amount of \$2 M per year was assumed for fiscal years 2021 through 2035.
 - (4) CIP Forms for each recommended project is provided in Appendix J.
 - (5) Includes cost savings for the Southeast and Southwest Service Areas.

8.4 FUTURE PLANNING RECOMMENDATIONS

Although the Southwest WWCS Master Plan Update presents planning scenarios based on best available information, the County should continue to update the land use plan, hydraulic model, and Master Plan as new developments, land use changes, or additional information becomes available. In addition, the County should continue their efforts to identify infrastructure prone to I&I and plan for the repair and/or replacement of aging infrastructure.

In addition of adopting all the projects that were included in the model scenarios and in the proposed CIP, the following recommendations may improve collection system operations. Results of the suggested assessments should be included in the model to increase the robustness of the simulations for future use and during future model updates. It is not anticipated that these modifications would significantly impact the current overall calibration, model results, or CIP project recommendations.

- It is recommended that the rated capacity of Lake Bridge Lift Station (RTU 108) as provided by County (see Appendix D) is confirmed, and reassess the recommended pump change if the rated capacity of the existing pumps is different than the information provided.
- This Master Plan Update identified a limiting hydraulic condition at the SWWRF influent force main. It is recommended that upgrades of this influent pipe be a part of the future headworks replacement project (scheduled to be completed in 2018).
- Field verify invert elevations and diameters at manholes where overflows are not associated with identified gravity main surcharges, or where upstream gravity lines have not been included in the model. If field conditions are simulated in the model correctly, then such overflows may be avoided by manual operation of lift stations in a severe storm.
- Install flowmeters at key locations throughout the collection system (including all master lift stations and the Bayshore Yacht Basin (RTU 101) Lift Station), and calibrate them annually.
- Calibrate existing flowmeters and pressure transducers.
- Maintain records of current pump settings (on/off elevations) when available.
- Maintain documentation of any modifications in lift station operation or control for wet weather conditions. Update control settings in the model wet weather scenarios accordingly.
- Reconcile all infrastructure differences between the model and GIS.
- Wastewater generation factors (LOS gallons per capita) should be reviewed on an on-going basis to reflect the up-to-date wastewater loading/input.

Southwest County Wastewater Collection System Master Plan Update

**APPENDIX A –EXCERPT FROM MANATEE COUNTY
COMPREHENSIVE PLAN**

MANATEE COUNTY
COMPREHENSIVE PLAN

COMPLETE AND UP TO DATE THRU

SUPPLEMENT # 21

**TABLE 2-1
SUMMARY OF FUTURE LAND USE CLASSIFICATION SYSTEM**

PART I: FUTURE LAND USE DISTRICTS

Page 1 of 5

| Future Land Use Category | Map Symbol | Maximum Potential Density*(Gross Dwelling Units /Gross Acre) (DU/GA) | Net(Dwelling Units/(Net Acre) | Maximum Potential Intensity* (Floor Area Ratio (FAR) | General Range of Potential Uses (See Policies for Additional Detail) | Commercial Size Limitation |
|---------------------------|------------|---|---|--|---|----------------------------|
| 1) Conservation Lands | CON | 0 | 0 | 0 | Open Space or Passive Nature Parks, Selected Agriculture Activities, Accessory Structures | See 2.2.1.7.3 |
| 2) Agriculture/Rural | AG/R | 0.2 | 2 | 0.23 | Agriculture, Rural Residential Uses, Mining, Agro-Industrial Uses, Commercial Uses Related To Agriculture, Neighborhood Retail Uses, and Professional/Personal Services Office Uses, Recreational Facilities. | Small |
| 3) Estate Rural | ER | 0.2 | 1 | 0.23 | Clustered suburban residential uses, neighborhood retail, agricultural uses, agriculturally compatible residential uses, public or semi-public uses, schools, low intensity recreational uses, and appropriate water-dependent water-related / water-enhanced uses. | Small |
| 4) Residential-1 DU/GA | RES-1 | 1.0 | See 2.2.1.9.3 | 0.23 | Residential Uses, Neighborhood Retail Uses and Professional/Personal Service Office Uses, Recreation Facilities (Generally limited to Neighborhood Retail Uses) | Medium |
| 5) Residential-3.0 DU/GA | RES-3 | 3.0 Min. 2.5 in CRA's and UIRA for residential projects that designate a minimum of 25% of the dwelling units as "Affordable Housing" | 6 9 in CRA's and UIRA for residential projects that designate a minimum of 25% of the dwelling units as "Affordable Housing" | 0.23 1.0 in CRA's and UIRA | Same as for RES-1 Neotraditional development is limited to Small (Neighborhood Retail Uses – wholesale uses not allowed) | Medium |
| 6) Urban Fringe-3.0 DU/GA | UF-3 | 3.0 | 9 | 0.23 | Same as for RES-1 Neotraditional development is limited to Small (Neighborhood Retail Uses – wholesale uses not allowed) • Community –serving commercial | Medium *Large |
| 7) Residential-6 DU/GA | RES-6 | 6.0 Min. 5.0 in CRA's and UIRA for residential projects that designate a minimum of 25% of the dwelling units as "Affordable Housing" | 12 16 in CRA's and UIRA for residential projects that designate a minimum of 25% of the dwelling units as "Affordable Housing" | 0.23 1.0 in CRA's and UIRA | Same as for RES-1 Neotraditional development is limited to Small (Neighborhood Retail Uses – wholesale uses not allowed) | Medium |
| 8) Residential-9 DU/GA | RES-9 | 9.0 Min 7.0 in CRA's and UIRA for residential projects that designate a minimum of 25% of the dwelling units as "Affordable Housing" | 16 20 in CRA's and UIRA for residential projects that designate a minimum of 25% of the dwelling units as "Affordable Housing" | 0.23 1.0 in CRA's and UIRA | Same as for RES-1 Neotraditional development is limited to Small (Neighborhood Retail Uses – wholesale uses not allowed) | Medium |
| 9) Residential-12 DU/GA | RES-12 | 12.0 Min 10.0 in CRA's and UIRA for residential projects that designate a minimum of 25% of the dwelling units as "Affordable Housing" | 16 24 in CRA's and UIRA for residential projects that designate a minimum of 25% of the dwelling units as "Affordable Housing" | 0.23 1.0 in CRA's and UIRA | Same as for RES-1 Neotraditional development is limited to Small (Neighborhood Retail Uses – wholesale uses not allowed) | Medium |

**TABLE 2-1
SUMMARY OF FUTURE LAND USE CLASSIFICATION SYSTEM**

**PART I: FUTURE LAND USE DISTRICTS
Page 2 of 5**

| Future Land Use Category | Map Symbol | Maximum Potential Density*(Gross Dwelling Units /Gross Acre) (DU/GA) | Net(Dwelling Units/(Net Acre) | Maximum Potential Intensity*(Floor Area Ratio (FAR) | General Range of Potential Uses (See Policies for Additional Detail) | Commercial Size Limitation |
|--------------------------------|------------|---|---|---|--|---|
| 10) Residential-16 DU/GA** | RES-16 | 16.0 Min 13.0 in CRA's and UIRA for residential projects that designate a minimum of 25% of the dwelling units as "Affordable Housing" | 20 28 in CRA's and UIRA for residential projects that designate a minimum of 25% of the dwelling units as "Affordable Housing" | 0.25 1.0 in CRA's and UIRA | Same as for RES-1; also, Hotel/Motel Neotraditional development is limited to Small (Neighborhood Retail Uses – wholesale uses not allowed) | Medium |
| 11) Low Intensity Office | OL | 6.0 Min 5.0 in CRA's and UIRA for residential projects that designate a minimum of 25% of the dwelling units as "Affordable Housing" | 12 16 in CRA's and UIRA for residential projects that designate a minimum of 25% of the dwelling units as "Affordable Housing" | 0.23 1.0 in CRA's and UIRA | Professional, Personal Service, Business Service, Financial Service, and Other Offices Uses, Residential Uses, Recreational Facilities | Small (Office Uses Only) |
| 12) Medium Intensity Office | OM | 0 | 0 | .30 (Outside of the Urban Core Area) .50 (Inside the Urban Core Area) 1.0 in CRA's and UIRA | Professional office and/or research / corporate park uses are the primary non-residential uses, neighborhood retail uses, public or semi-public uses, schools, medium intensity recreational uses and appropriate water-dependent/water-related/water-enhanced uses can serve as appropriate secondary uses. | Max. 5,000 sf (Outside of the Urban Core Area) Max. 10,000 sf (Inside the Urban Core Area) |
| 13) Retail/Office/ Residential | ROR | 9.0 Min 7.0 in CRA's and UIRA for residential projects that designate a minimum of 25% of the dwelling units as "Affordable Housing" | 20.0 24 in CRA's and UIRA for residential projects that designate a min. of 25% of the dwelling units as "Affordable Housing" | 0.35 1.0 in CRA's and UIRA 1.0 for Hotels | Neighborhood Retail Uses, Community Serving Retail Uses, and Regional Retail Uses, Office Uses, Residential Uses, Hotel/Motel, Recreational Facilities | Large |
| 14) Industrial-Light | IL | 1 | 1 | 0.75 1.0 in CRA's and UIRA 1.0 for Hotels | Office, Light Industry, Research/Corporate Parks, Warehouse/Distribution, Intensive Commercial Uses, Neighborhood Retail Uses, Hotel/Motel, Selected Single-Family, Residential Uses | Small |
| 15) Industrial-Heavy | IH | 0 | 0 | 0.5 1.0 in CRA's and UIRA | Light Industry, Heavy Industry, Ports, Intensive Commercial Uses, Neighborhood Retail Uses. Phosphate mining is not an allowable use. | Small |
| 16) Urban Industrial | IU | 0 | 0 | 1.25 | Light Industry, Heavy Industry, Warehouse/ Distribution, Neighborhood Retail Uses | Small |

| | | | | | | |
|------------------------------|---------|---|---|------------------------------|---|-------------------------------|
| 17) Mixed Use | MU | 9.0 Min 7.0 in CRA's and UIRA for residential projects that designate a minimum of 25% of the dwelling units as "Affordable Housing" | 20.0 24 in CRA's and UIRA for residential projects that designate a minimum of 25% of the dwelling units as "Affordable Housing" | 1.0 2.0 in CRA's and UIRA | Neighborhood Retail Uses, Community Serving Retail Uses and Regional Retail, Office, Light Industrial, Research/Corporate Parks, Warehouse/ Distribution, Residential Uses, Hotel/Motel | Large |
| 18) Public/Semi-Public(1) | P/SP(1) | See Policies | See Policies | See Policies | Landfills, Permanent Water and Wastewater Treatment Storage/ Disposal Facilities, and Other Major Public Facilities Including But Not Limited To Major Maintenance Facilities, Solid Waste Transfer Stations, Major Utility Transmission Corridors and Permitted Uses Therein | See 2.2.1.22.2 and 2.2.1.23.2 |

**TABLE 2-1
SUMMARY OF FUTURE LAND USE CLASSIFICATION SYSTEM**

PART I: FUTURE LAND USE DISTRICTS

Page 3 of 5

| Future Land Use Category | Map Symbol | Maximum Potential Density*(Gross Dwelling Units /Gross Acre) (DU/GA) | Net(Dwelling Units/(Net Acre) | Maximum Potential Intensity*(Floor Area Ratio (FAR) | General Range of Potential Uses (See Policies for Additional Detail) | Commercial Size Limitation |
|-----------------------------------|------------|--|-------------------------------|---|--|-------------------------------|
| 19) Major Public/ Semi-Public (2) | P/SP(2) | See Policies | See Policies | See Policies | Universities, Colleges, or Groupings Of Other Major Educational Facilities, Hospitals and Complementary or Accessory Health Care Uses Not Designated Under Other Future Land Use Categories, Community Centers | See 2.2.1.22.2 and 2.2.1.23.2 |
| 20) Major Attractors | AT | N/A | N/A | N/A | Mass Seating Facilities, Civic Centers, Convention Facilities and Other Major Attractors | N/A |
| 21) Major Recreation/Open Space | R/OS | 0 | 0 | 0 | Major Parks, Publicly-Owned or Operated Recreational Facilities | N/A |

TABLE 2-1
SUMMARY OF FUTURE LAND USE CLASSIFICATION SYSTEM

PART I: FUTURE LAND USE DISTRICTS
Page 4 of 5

| Future Land Use Category | Map Symbol | Maximum Potential Density*(Gross Dwelling Units /Gross Acre) (DU/GA) | Net(Dwelling Units/(Net Acre) | Maximum Potential Intensity*(Floor Area Ratio (FAR) | General Range of Potential Uses (See Policies for Additional Detail) | Commercial Size Limitation |
|----------------------------|------------|--|-------------------------------|---|--|----------------------------|
| 22) Mixed Use Community | MU-C | MU-C/AC-1 Maximum 9 du/ga Minimum 6 du/ga | Maximum 20 du/net acre | 1.0 | Retail, wholesale or office commercial uses which function in the market place as neighborhood, community or region-serving. Also light industrial uses, research/corporate uses, warehouse/distribution, suburban or urban residential uses, lodging places, recreational uses, public or semi-public uses, schools, hospitals, short-term agricultural uses, and appropriate water-dependent/water-related/water enhanced uses. | Large |
| 22) Mixed Use Community | MU-C | MU-C/AC-2 Maximum 9 du/ga Minimum 6 du/ga | Maximum 20 du/net acre | 0.35 | Retail, wholesale, or office commercial uses which function in the market place as neighborhood, community, or region-serving. Also light industrial uses, research/corporate uses, warehouse/distribution, suburban or urban residential uses, lodging places, recreational uses, public or semi-public uses, schools, short-term agricultural uses, and appropriate water-dependent/water-related/water enhanced uses. | Large |
| 22) Mixed Use Community | MU-C | MU-C/AC-3 Maximum 3 du/ga | Maximum 9 du/net acre | 0.23 | Neighborhood retail/office uses, also light industrial uses, research/corporate uses, warehouse/distribution, suburban or urban density planned residential development with integrated residential support uses as part of such developments, short-term agricultural uses, interim farm worker housing, public or semi-public uses, schools, recreational uses, and appropriate water-dependent/water-related/water-enhanced uses. | Medium |
| 22) Mixed Use Community | MU-C | MU-C/R Maximum 3 du/ga | Maximum 9 du/net acre | 0.23 | Suburban or urban density planned residential development with integrated residential support uses as part of such developments, neighborhood retail uses, short-term agricultural uses, interim farm worker housing, public or semi-public uses, schools, recreational uses, and appropriate water-dependent/water-related/water-enhanced uses. | Medium |
| 22) Mixed Use Community | MU-C | MU-C/RU <u>Maximum 9 du/ga</u> | Maximum 16 du/net acre | 0.23 | Suburban or urban density planned residential development with integrated residential support uses as part of such developments, neighborhood retail uses, interim farm worker housing, public or semi-public uses, schools, recreational uses, and appropriate water-dependent/ water related/ water-enhanced uses | Medium |

Southwest County Wastewater Collection System Master Plan Update

**APPENDIX B – FDOT INTENSITY-DURATION-FREQUENCY
CURVES**

ZONES FOR PRECIPITATION IDF CURVES DEVELOPED BY THE DEPARTMENT

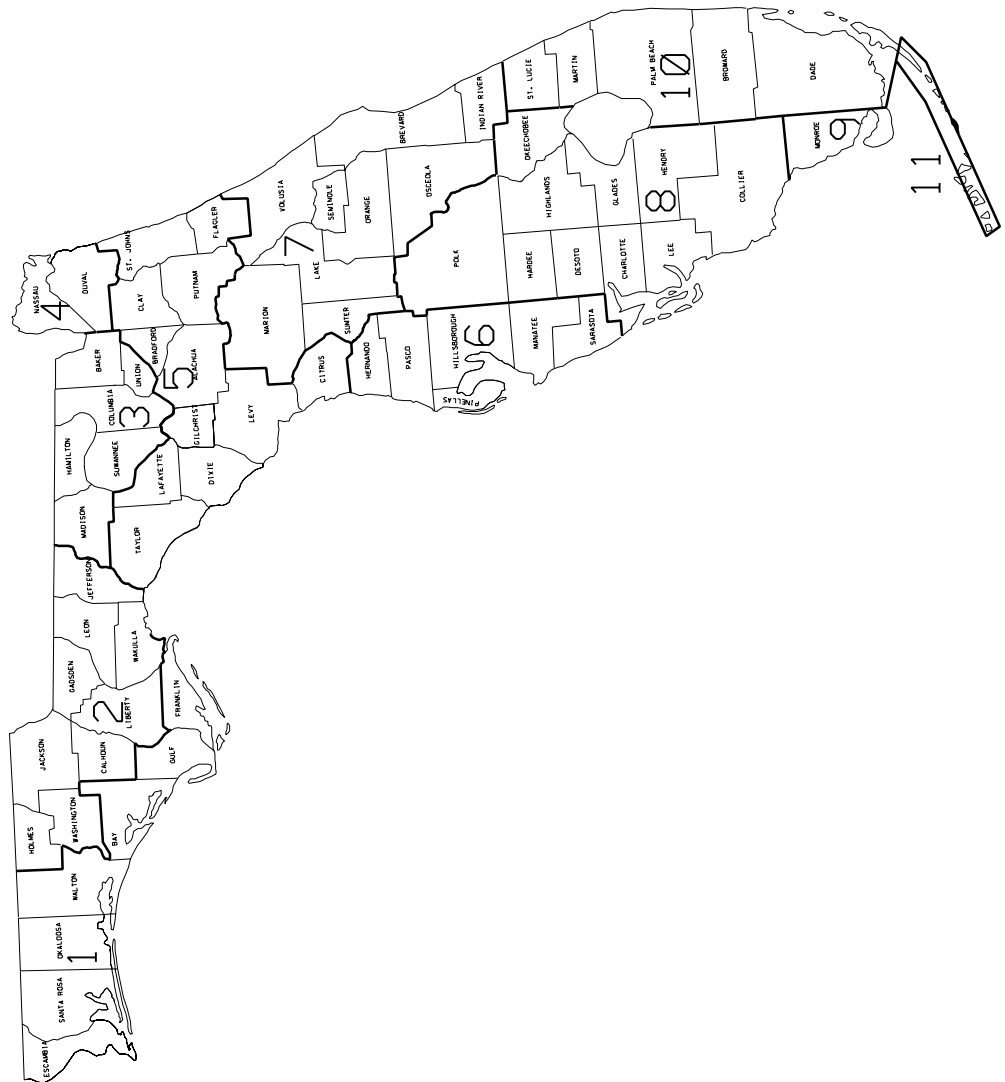

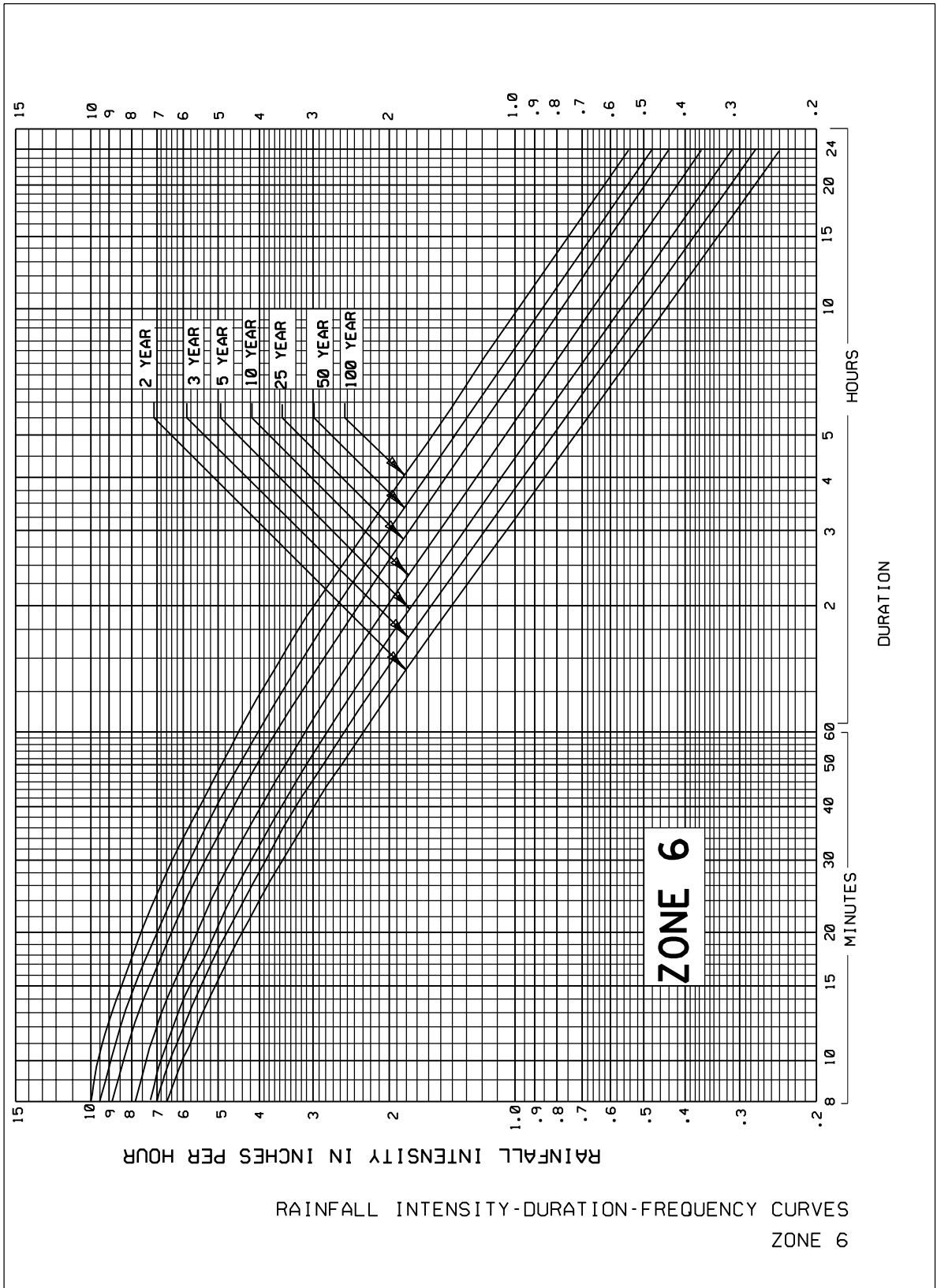

Southwest County Wastewater Collection System Master Plan Update

**APPENDIX C –EXCERPT FROM MANATEE COUNTY UTILITY
DESIGN STANDARDS**



MANATEE COUNTY PUBLIC WORKS UTILITY STANDARDS

MAY 2011

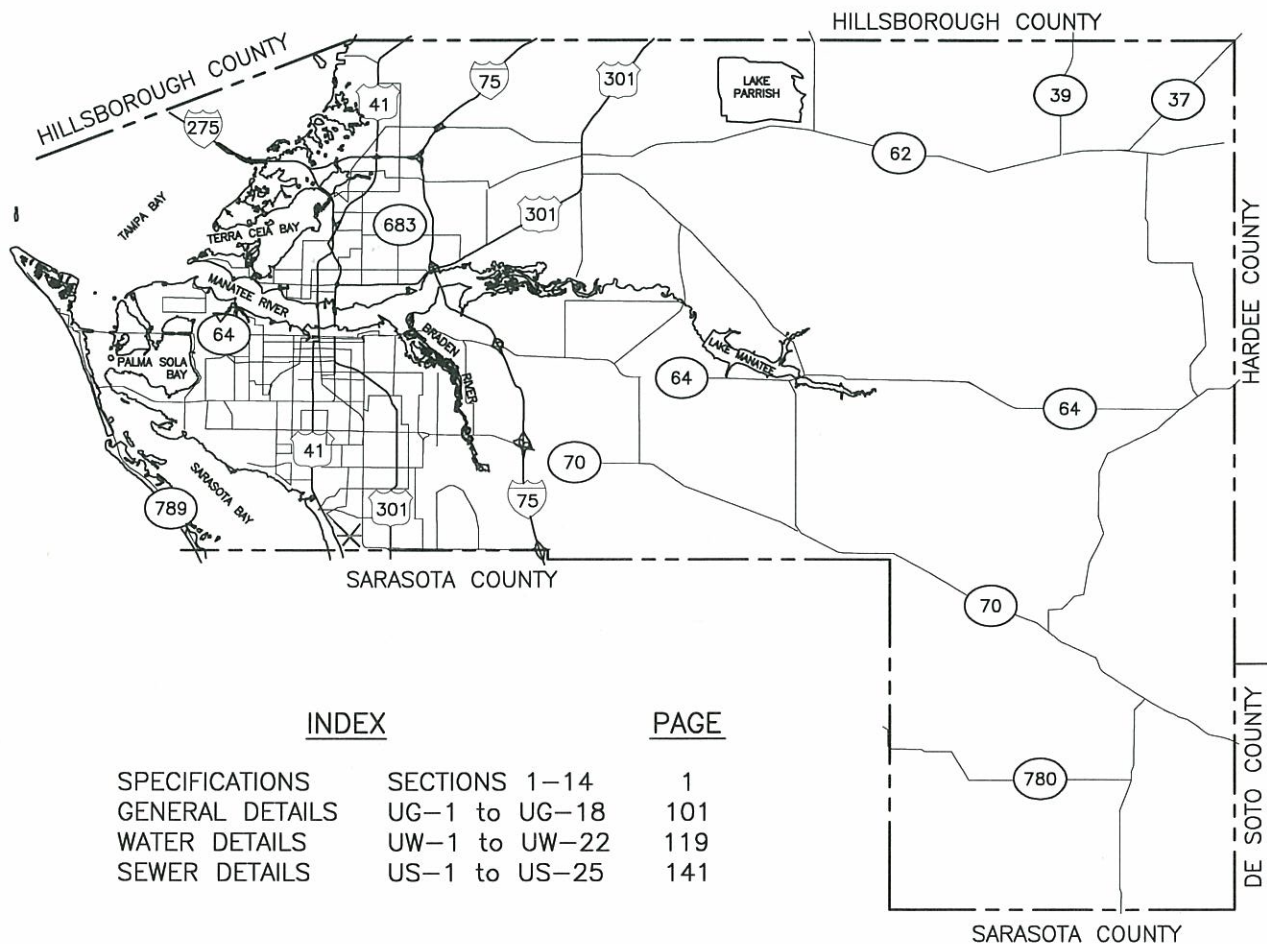

INDEX

PAGE

| | | |
|-----------------|---------------|-----|
| SPECIFICATIONS | SECTIONS 1-14 | 1 |
| GENERAL DETAILS | UG-1 to UG-18 | 101 |
| WATER DETAILS | UW-1 to UW-22 | 119 |
| SEWER DETAILS | US-1 to US-25 | 141 |

- A. In-line potable or reclaimed water valves shall generally be installed at intervals no greater than 1,600 LF on transmission mains where systems serve widely scattered customers and where future development is not expected; and at intervals of no greater than 800 LF on main distribution loops and feeders, and on all primary branches connected to these lines.

In residential, commercial and industrial subdivisions, water valves shall be installed at intervals no greater than 800 feet and at all sides of tees and crosses located at roadway intersections, unless there is another in-line valve on that leg within 200 feet. Additional in-line isolation valves shall be located in the run of the tee at fire hydrant connections.

- B. In-line sewer valves shall be installed at intervals of no greater than 1,200 LF on sewer force mains.
- C. In all instances, for both water and pressure sewer pipes, valves shall be placed to maximize the effectiveness of isolation of the pipelines during maintenance and repairs. Valves shall not be placed in curbs or gutters, blow-off valve assemblies shall not be placed in driveways or sidewalks. In-line sewer valves shall be installed near each side of a canal crossing and/or major road crossing and at all jack and bore crossings. Valves shall be placed at the right-of-way line where a public water distribution or sewer collection system crosses over onto private property and becomes a privately maintained system. All valves shall be noted and depicted on the construction and record drawings. Clearance of 18 inches or one pipe diameter, whichever is greater, shall be maintained between valves and all other fittings and joints (bells, valves, flanges, etc.).
- D. Fire hydrants shall be located no more than 800 feet apart and within 400 feet of the main entrance of all non-residential buildings as measured along normal access routes, typically on the same side of the roadway as the water main. Hydrants shall be placed at the end of a water line unless within 500 feet of another hydrant. Hydrants shall not be located within 40 feet of any building, except within a right of way or within one-story single family residential areas.

9.09 MINIMUM PIPE FLOW DESIGN CRITERIA

- A. Gravity Sewer Design

A minimum design velocity of 2.0 feet per second and a maximum design velocity of 10.0 feet per second shall be used for the design of gravity-flow pipelines. Maximum design flow depths for peak design flow rates shall not exceed 80 percent of the pipe inside diameter. Minimum slopes required to achieve a velocity of at least 2.0 feet per second are provided below:

| Sewer Pipe Diameter in Inches, I.D. | Minimum Slope in Feet per 100 Feet, Manning's $n = 0.013$ |
|-------------------------------------|---|
| 8 | 0.40 |
| 10 | 0.28 |
| 12 | 0.22 |

| | |
|----|-------|
| 14 | 0.17 |
| 15 | 0.15 |
| 16 | 0.14 |
| 18 | 0.12 |
| 21 | 0.10 |
| 24 | 0.08 |
| 27 | 0.067 |
| 30 | 0.058 |
| 36 | 0.046 |

B. Sewer Force Main Design

Sewer force main velocities shall not be less than 2 feet per second, with one/smallest pump running (at minimum flow) and not exceed 6 feet per second at peak-hour flow conditions. Hazen-William's roughness coefficient of a maximum of 120 will be used in the calculations.

C. Gravity Sewer, Sewer Force Main, and Pump (Lift) Station Design

Construction drawings that are submitted to Manatee County for approval shall include engineering calculations, which may include computer hydraulic modeling. Gravity sewer, sewer force main, and pump station design shall be based on peak-hour flow rate. Unless the Engineer of Record provides credible documentation and/or data to support peaking factors used in his or her calculations, peaking factors for peak hour flow rate shall be based on the following equation:

$$\text{Peak-Hour Flow/Average Daily Flow} = (18 + \sqrt{P}) / (4 + \sqrt{P})$$

(where \sqrt{P} = square root of the population in thousands)
(Peak hour factor not to exceed 4)

D. Water Distribution Main Design

Water mains shall be designed with velocities no greater than 5 feet per second at peak-hour flow conditions and no greater than 10 feet per second at maximum-day plus needed fire flow conditions. Hazen-William's roughness coefficient of a maximum of 130 shall be used in the calculations for plastic pipe and lined ductile iron pipe. Delivered flows for pressure water mains shall meet the needed fire flow rate plus a background water demand equivalent to the maximum-day demand with a residual gauge pressure not less than 20 pounds per square inch (psi). A residual gauge pressure not less than 20 psi shall be maintained at the peak-hour water demand. Construction drawings that are submitted to Manatee County for approval shall include engineering calculations, which may include computer hydraulic modeling. Unless the Engineer of Record provides credible documentation and/or data to support peaking factors used in his or her calculations, peaking factors for peak-hour and maximum-day flow rates in potable water main design shall based on the following equations:

$$Q\text{-Peak} = 2.2 \times \text{Average Daily Flow}$$

SECTION 13

PUMP (LIFT) STATIONS

13.01 DESCRIPTION OF WORK

Furnish all labor, materials, equipment and incidentals required to install complete automatic, underground pump stations with all required equipment installed in a concrete wetwell and adjacent concrete valve vault. The principal items of equipment shall include two submersible motor-driven sewage pumps, valves, internal piping, automatic pumping level controls, control panel and telemetry. All materials shall be new, without defects and of the best quality. All materials furnished and all work done shall be in strict accordance with the National Electrical Code and all local requirements and codes.

All pump stations that re-pump sewage (directly or indirectly) from other pump stations shall have an on-site generator equipped with an automatic power transfer switch, transducer level controls with backup float switches, ultrasonic flow meter, and a force main pressure transducer.

13.02 STRUCTURES AND EQUIPMENT

A. Pump Station Wetwell

All wetwells 6 feet diameter and larger, and all pump stations that are owned and maintained by Manatee County, shall be precast concrete with a full protective liner, in accordance with section 12.06, designed to accommodate the peak hour development flow from all contributing areas. The wetwell shall have a minimum of 4 feet from the lowest invert to the wetwell bottom. The pump station wetwell size shall be determined using the following formula to determine the minimum volume between the off-level elevation and the influent invert elevation:

$$\text{MIN. VOLUME (GALS.)} = \text{PUMP CAPACITY (G.P.M.)} \times 4$$

Wetwell diameters shall be 6 feet or larger. 4-foot and 5-foot diameter wetwells shall be used only for special grinder pump applications as approved by the County on a case by case basis. The minimum wall thicknesses for concrete wetwells with liners shall be as follows:

| <u>DIAMETER</u> | <u>WALL THICKNESS</u> | <u>DIAMETER</u> | <u>WALL THICKNESS</u> |
|-----------------|-----------------------|-----------------|-----------------------|
| 4' - 0" | 8" | 8' - 0" | 8" |
| 5' - 0" | 8" | 10' - 0" | 10" |
| 6' - 0" | 8" | 12' - 0" | 12" |

The pump station wetwell size and control equipment shall be designed to limit the pumping cycles of each pump to a maximum of 5 starts per hour for duplex stations and 3 starts per hour for triplex stations. Pump stations discharging through pipes 12 inches or larger shall have more than two variable speed pumps.

The pump cycle off level shall be no lower than the top of the sewage pumps. The lead pump on level shall be no higher than 18 inches below the invert elevation of the influent pipe for duplex stations, and no higher than 24 inches below the invert for triplex stations.

All pump stations shall have a single gravity-flow influent pipe discharging into the wetwell. Multiple gravity pipelines and force mains upstream shall all terminate at a separate manhole before flowing into the pump station wetwell. The influent gravity sewer shall be aligned, so that the inflowing stream drops into the front side of the wet well opposite from the riser side, within an angle of 25 degrees on either side of the centerline passing between both pumps in a duplex station, or between two of the three pumps in a triplex station. As an option to the to the influent gravity sewer main entering the wetwell directly between the pumps, a plastic composite/fiberglass drop bowl and pipe (Reliner/Duran, Inc. or equal) shall be installed, as shown on Detail US-20.

B. Valve Vault

A precast valve vault for three gate valves, two weighted lever swing check valves, and a pump-out connection shall be constructed adjacent to the wetwell. The valve vault shall have a 2-inch PVC drain installed at a 2 percent slope and with a P-trap installed inside the wetwell. The pump-out connection shall be equipped with a gate valve and a male aluminum quick-coupler; 4-inch for 4-inch or smaller valve assemblies, 6-inch for all others. The valve vault shall be of adequate size to allow a minimum clearance of 12 inches from flanges to the valve vault wall, 18 inches from flanges to the valve vault floor and 12 inches from the cross to the valve vault wall at the force main exit point. The depth of the valve vault, as measured from the bottom of the top slab to the valve vault floor, shall not exceed 6.0 feet for duplex lift stations. All valves and fittings shall have factory applied, fusion bonded epoxy coating on interior and exterior. Valve vaults designed with exit pipe turning 90 degrees either way to exit to the side rather than straight through shall have two braces from the elbow to the walls to hold the assembly solidly in place.

C. Entrance Hatches

The lift station wetwell and valve pit shall be equipped with an aluminum access cover of adequate size to permit easy removal and installation of sewage pumps and equipment. The wetwell access cover shall be a minimum 36" x 48" single or double door. The valve pit access cover shall be a minimum 48" x 48" double door. All access covers shall be constructed of aluminum with a minimum load rating of 300 lbs/sq. ft. and equipped with stainless steel hinges, a recessed lifting handle which lies flush with the door surface, and a stainless steel staple which may be used to secure the door with a padlock when closed. The doors shall have a raised diamond thread pattern to provide a skid-resistant surface and shall open to 90 degrees and lock automatically in that position, with a handle to release the doors for closing. The hatch assemblies shall be as manufactured by U.S. Foundry, Halliday, or an approved equal.

D. Sewage Pump Assemblies

**APPENDIX D – LIFT STATION INFORMATION PROVIDED BY
COUNTY**

- **Pump Curves**
- **Wet Well Evaluation Forms**
- **Lift Station Spreadsheet**
- **Collection System Flow Chart**

APPENDIX D – PUMP CURVES

EBARA Submersible Grinder Pumps

DGUI/DGFU

Performance Curves

Project: _____ GPM: _____ TDH: _____ EFF: _____ HP: _____ Chk'd: _____ Date: _____

32DGUI61.5S (2HP) Synchronous Speed: 3600 RPM

1 1/4 inch Discharge

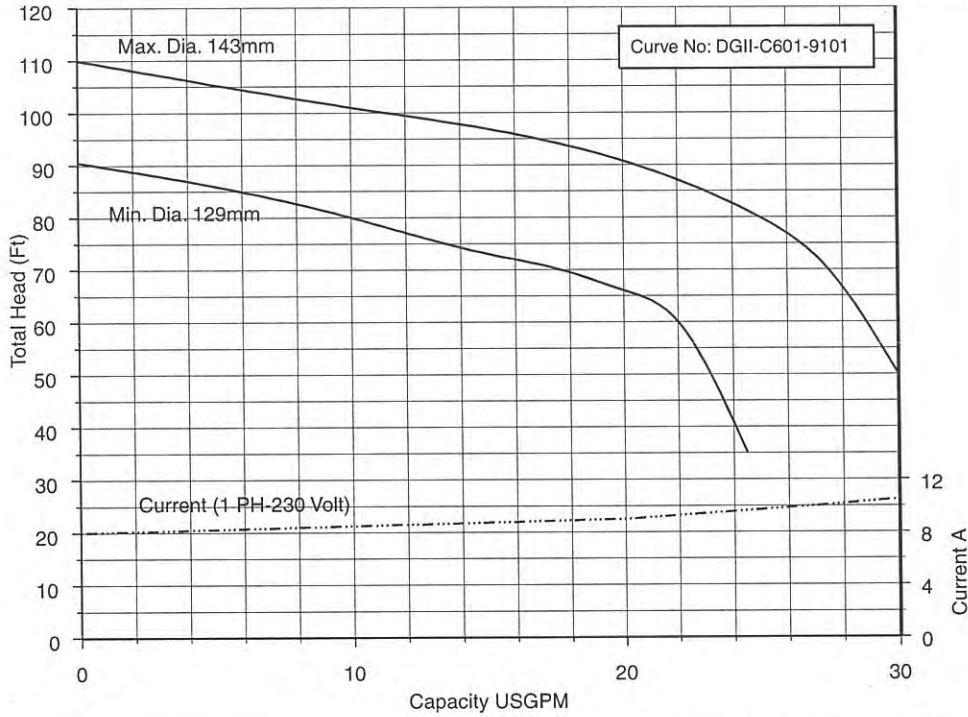

32DGF61.5S 32DGFU61.5 (2HP) Synchronous Speed: 3600 RPM 1 1/4 inch Discharge

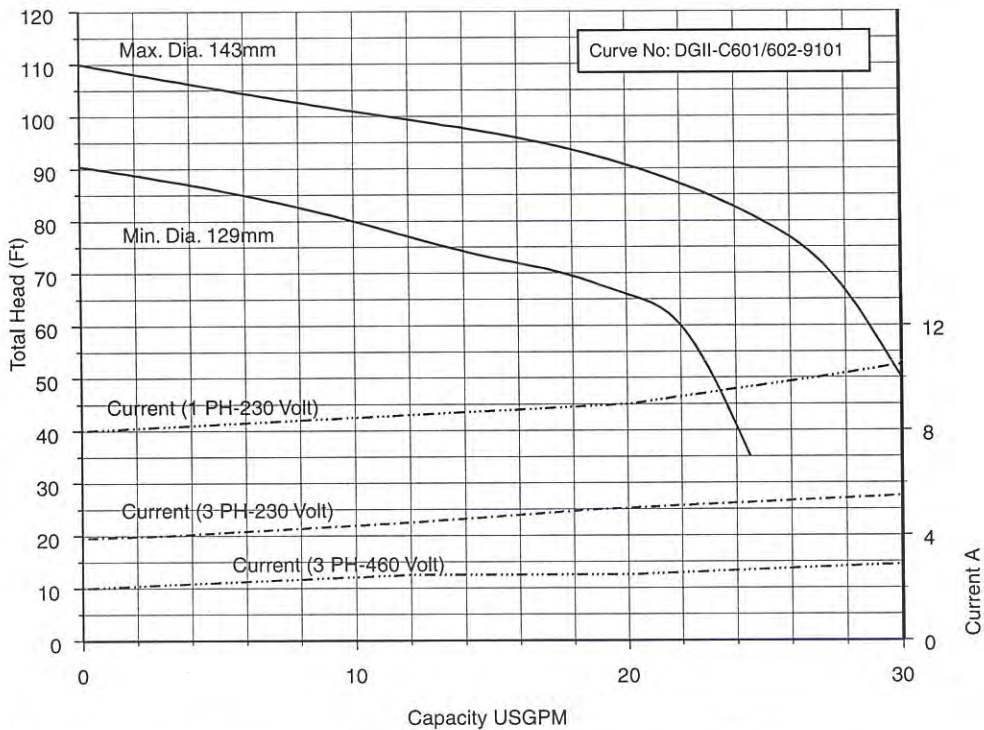

EBARA Submersible Grinder Pumps

DGUI/DGFU

Performance Curves

Project: _____ GPM: _____ TDH: _____ EFF: _____ HP: _____ Chk'd: _____ Date: _____

32DGUI61.5S (2HP) Synchronous Speed: 3600 RPM

1 1/4 inch Discharge

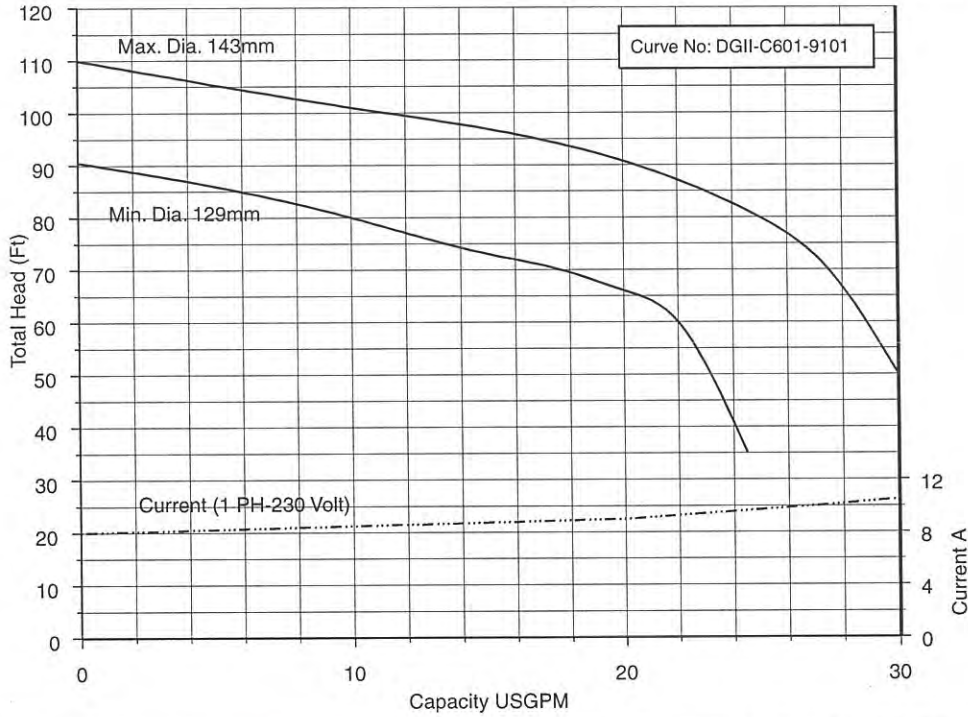

32DGF61.5S 32DGFU61.5 (2HP) Synchronous Speed: 3600 RPM 1 1/4 inch Discharge

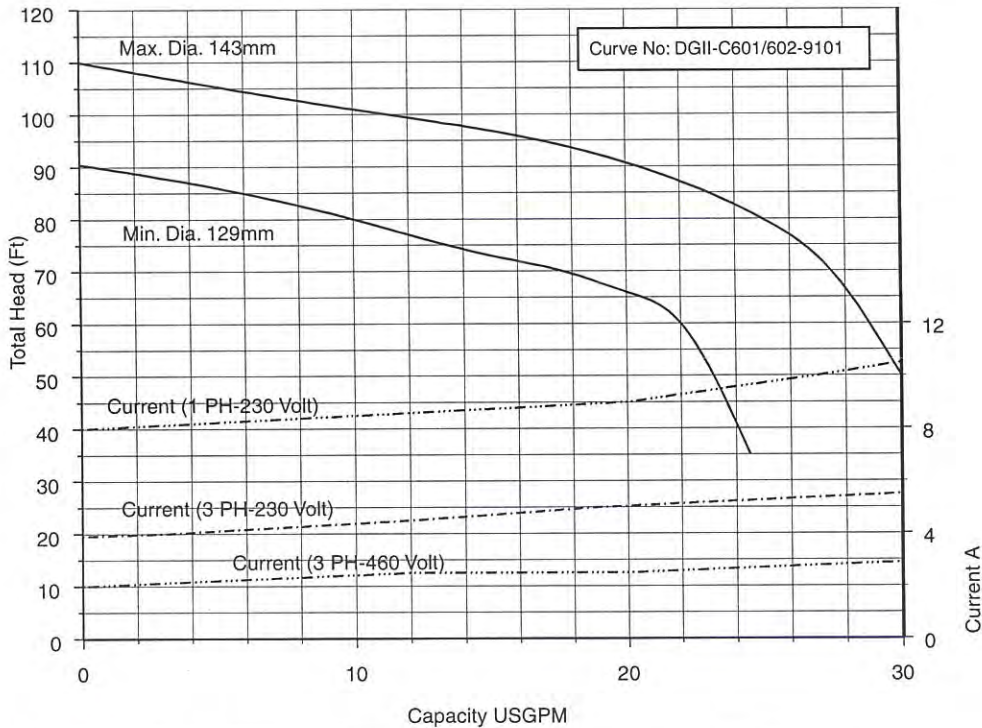



Pump performance curves XFP100E CB1 60HZ

Curve number

Reference curve
XFP100E CB1

| | | | | |
|-------------------------------------|---|---------------------------------|-------------------------------|--------------------|
| # 1 253 Gpm at 62 Tdh 12 Hp | | | Discharge DN100 | Frequency 60 Hz |
| Density 62.43 lb/ft ³ | Viscosity 0.0000169 ft ² /s | Testnorm Hydraulic Institute | Rated speed 1755..1765 rpm | Date 2012-06-13 |
| Flow 258 US g.p.m. | Head 64.3 ft | Rated power 7.92 hp | Hydraulic efficiency 53 % | NPSH 6.8 ft |

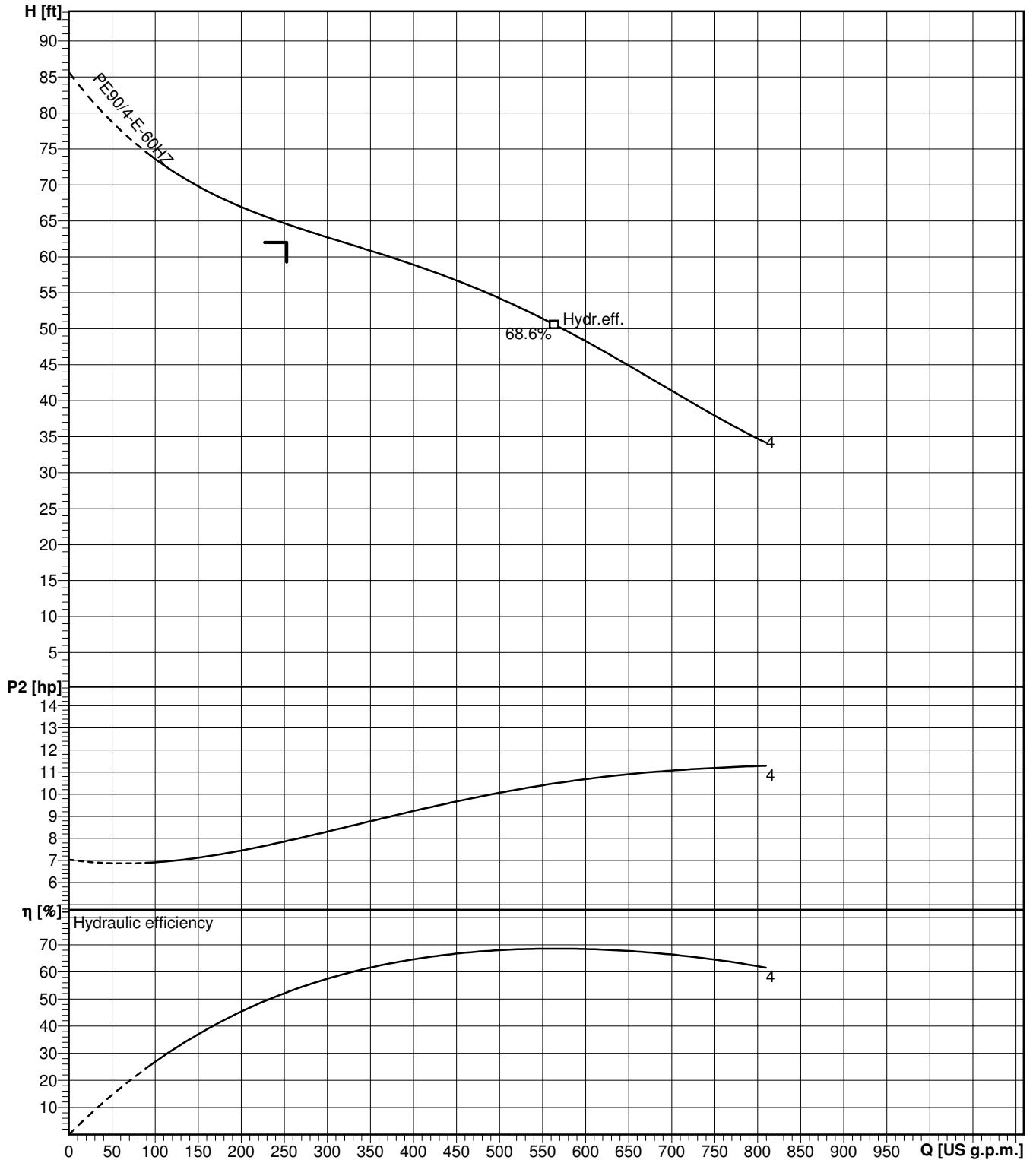

| | | | | |
|----------------------------------|------------------|--|----------------------|------------------------|
| Impeller size 9.84..7.28 inch | N° of vanes 1 | Impeller Contrabloc Plus impeller, 1 vane | Solid size 3 1/8" | Revision 2012-01-23 |
|----------------------------------|------------------|--|----------------------|------------------------|

ABS reserves the right to change any data and dimensions without prior notice and can not be held responsible for the use of information contained in this software.

ABSEL PRO 1.7.2 / 2007-02-08

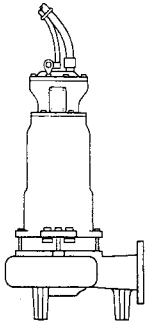

054 #1 Beach

S4M1000 8.25" Imp.

Performance Curve

S4M/S4MX

RPM: **1750**

Discharge: **4"**

Solids: **3"**

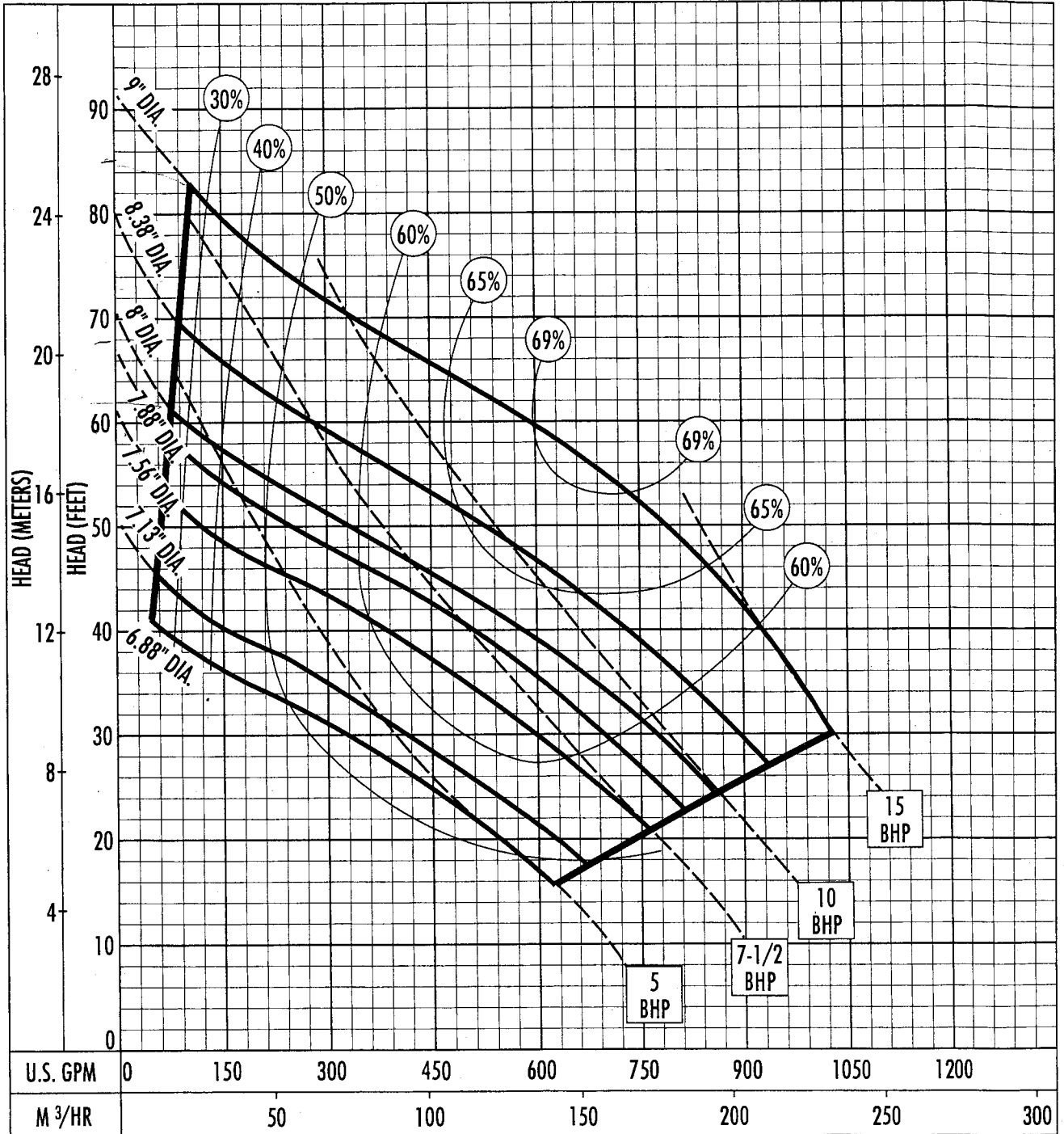

The curves reflect maximum performance characteristics without exceeding full load (Nameplate) horsepower. All pumps have a service factor of 1.2. Operation is recommended in the bounded area with operational point within the curve limit. Performance curves are based on actual tests with clear water at 70° F. and 1280 feet site elevation.

Performance Curve – S4N/S4NX

RPM: 1150 DISCHARGE: 4" SOLIDS: 3"

Lift Station 055

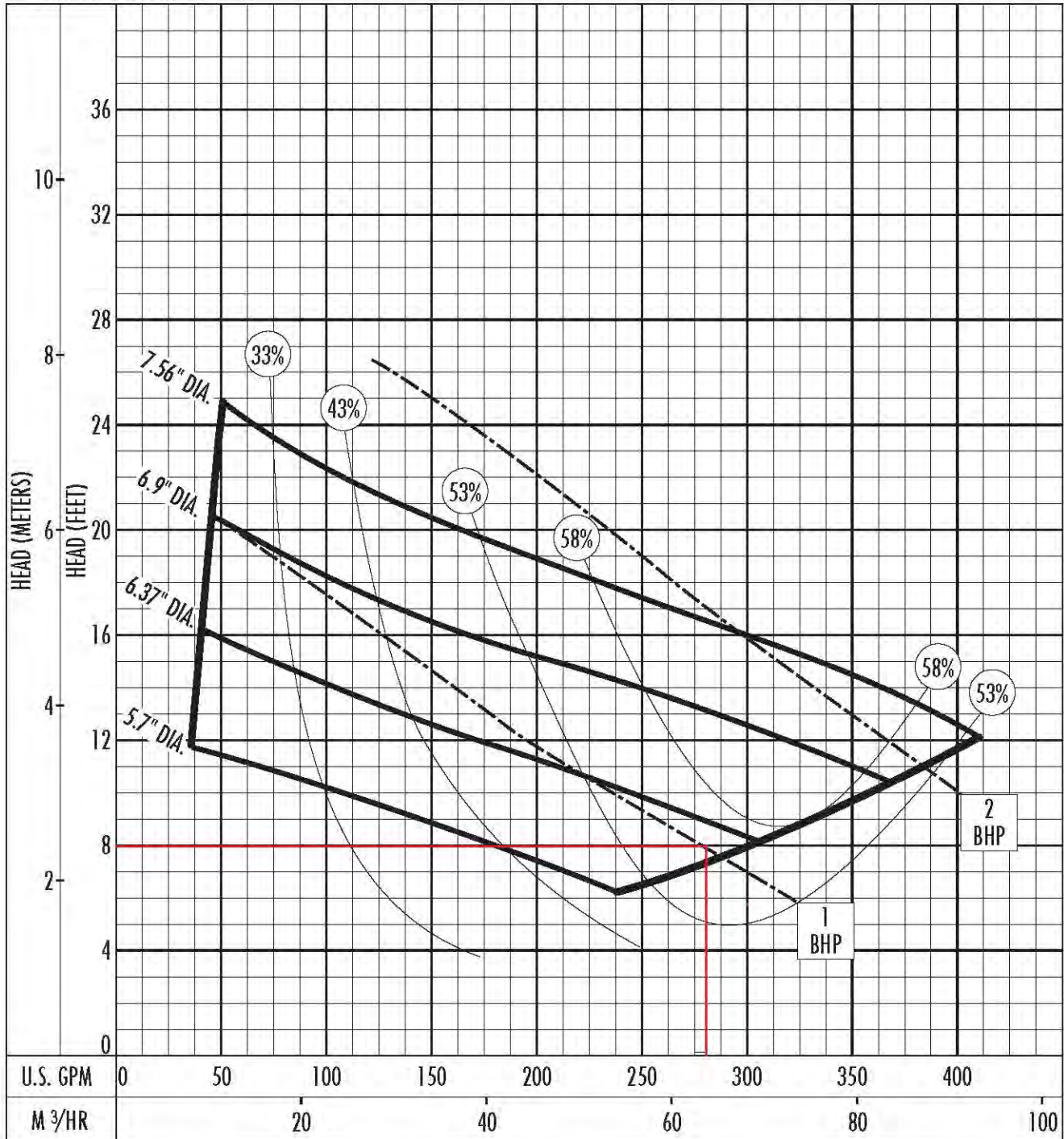

The curves reflect maximum performance characteristics without exceeding full load (Nameplate) horsepower. All pumps have a service factor of 1.2. Operation is recommended in the bounded area with operational point within the curve limit. Performance curves are based on actual tests with clear water at 70° F. and 1280 feet site elevation.

Conditions of Service:



HYDROMATIC

GPM: **280**

TDH: **8**

October © 2014 Pentair Ltd.

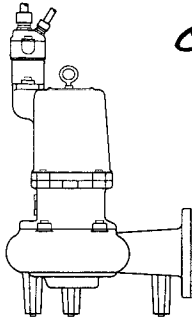

056 **1-C**

S4N/S4O w/ 7.35" Imp.

Performance Curve

S4N/S4NX

RPM: **1750** Discharge: **4"** Solids: **3"**

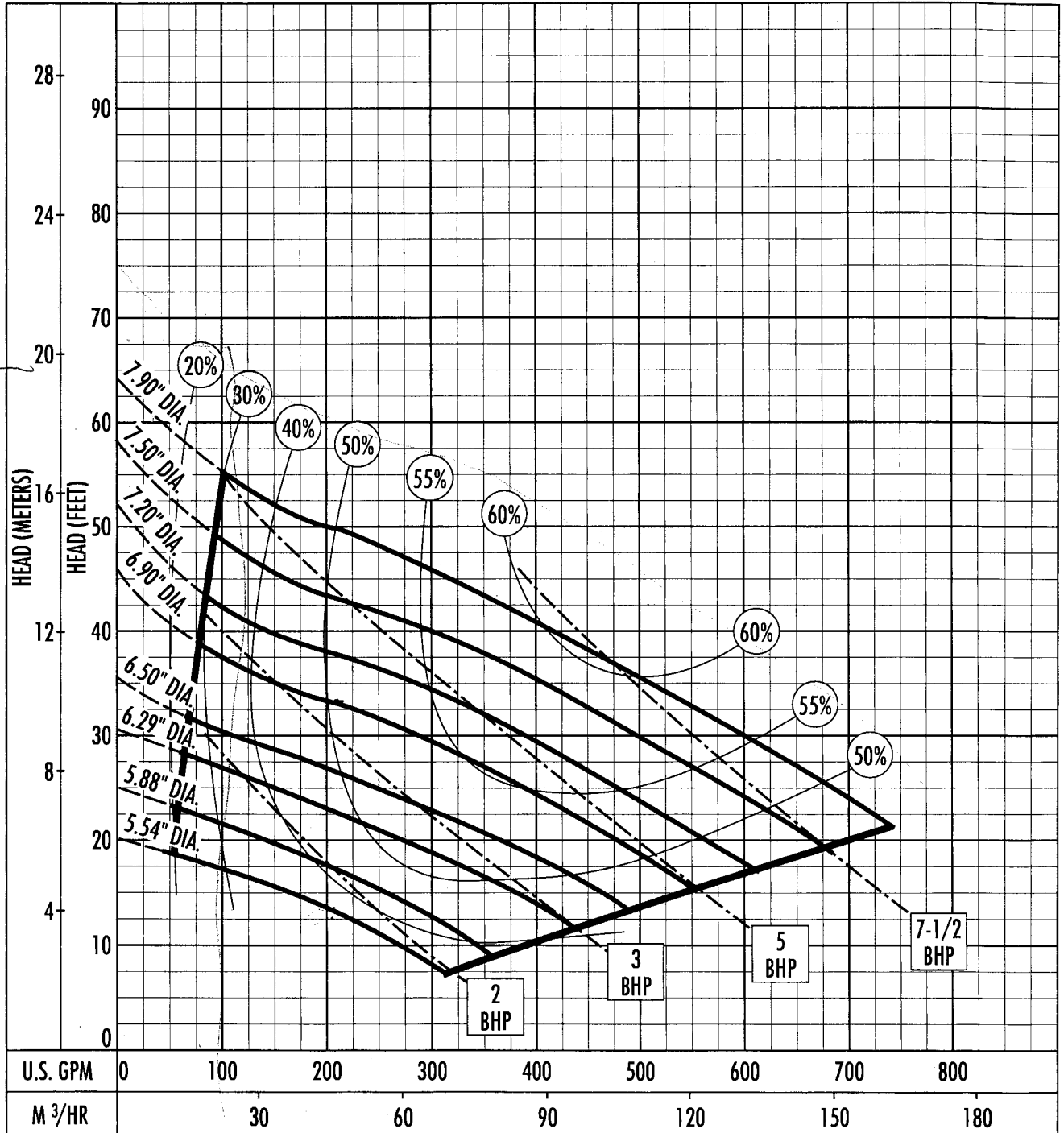

The curves reflect maximum performance characteristics without exceeding full load (Nameplate) horsepower. All pumps have a service factor of 1.2. Operation is recommended in the bounded area with operational point within the curve limit. Performance curves are based on actual tests with clear water at 70° F. and 1280 feet site elevation.

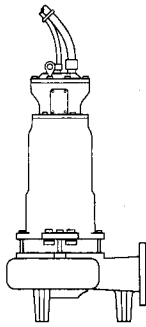

057 2-c

S4M1000 8.25" Imp.

Performance Curve

S4M/S4MX

RPM: **1750** Discharge: **4"** Solids: **3"**

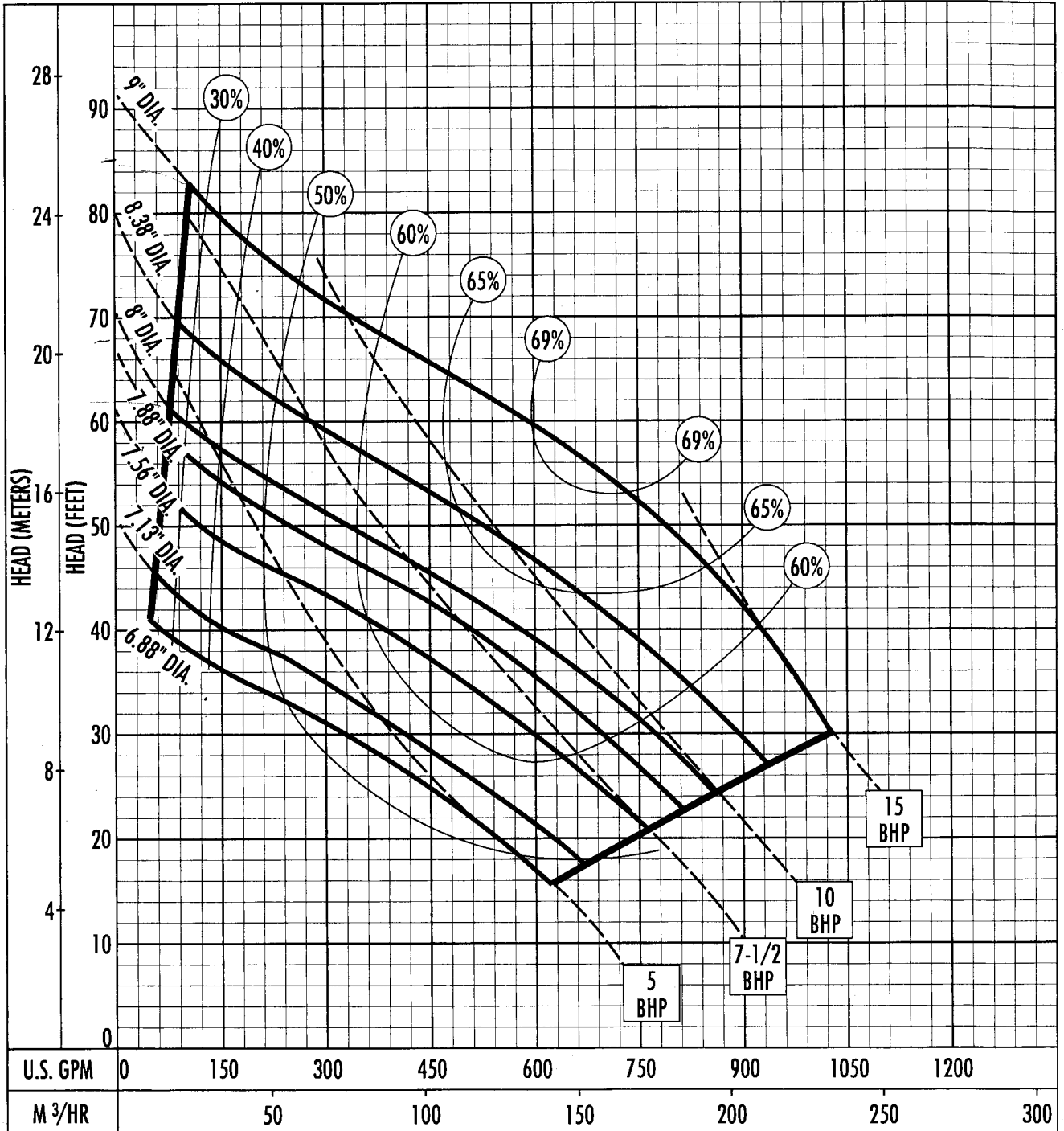

The curves reflect maximum performance characteristics without exceeding full load (Nameplate) horsepower. All pumps have a service factor of 1.2. Operation is recommended in the bounded area with operational point within the curve limit. Performance curves are based on actual tests with clear water at 70° F. and 1280 feet site elevation.

Performance Curve – S4N/S4NX

RPM: **1750** DISCHARGE: **4"** SOLIDS: **3"**

Lift Station 058

Impeller Diameter: 6.29

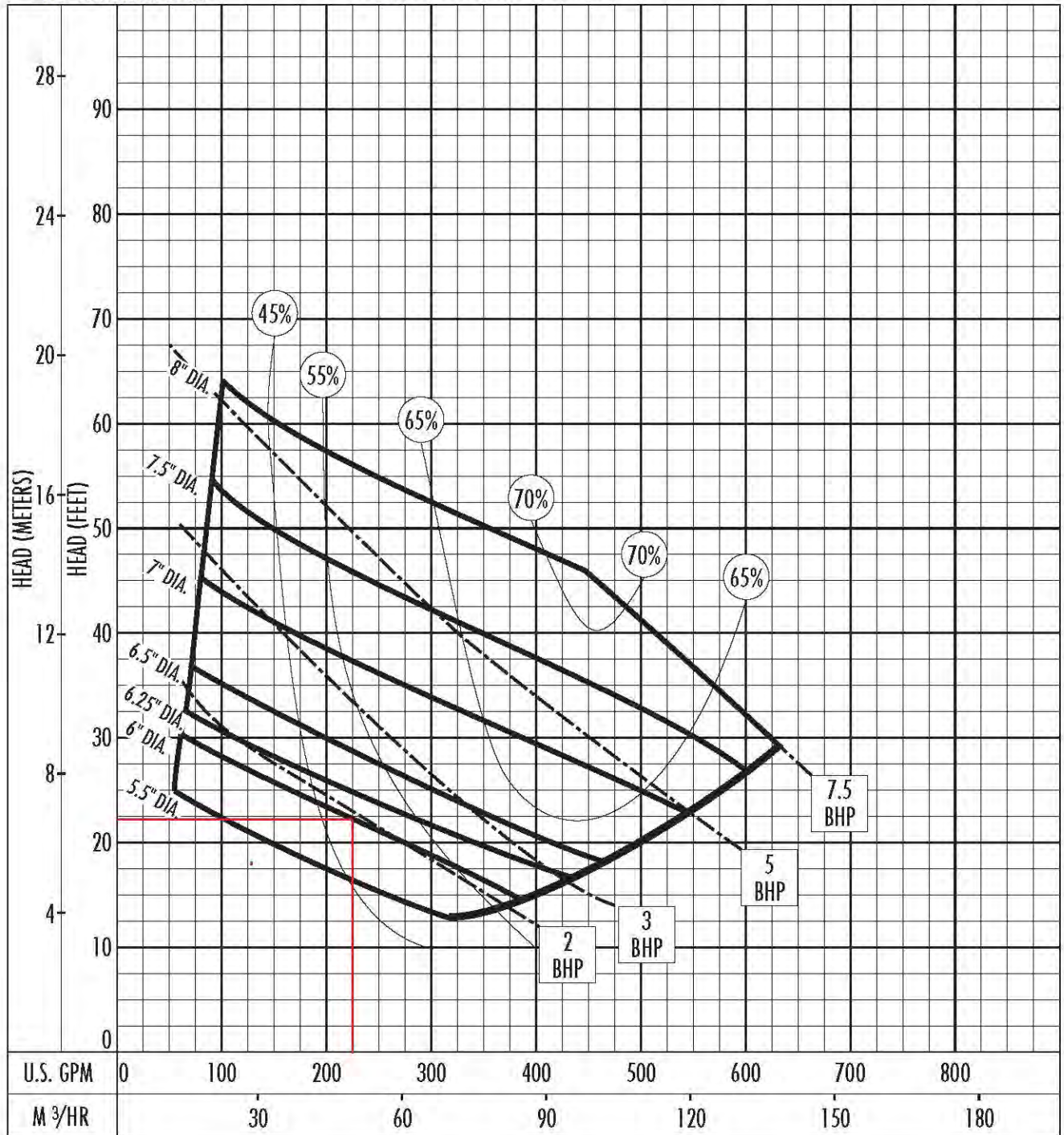

The curves reflect maximum performance characteristics without exceeding full load (Nameplate) horsepower. All pumps have a service factor of 1.2. Operation is recommended in the bounded area with operational point within the curve limit. Performance curves are based on actual tests with clear water at 70° F. and 1280 feet site elevation.

Conditions of Service:



Performance Curve

AMX434-193/5,5T/C

| Impeller | | | | | |
|---|-------------------------------|---|----------------------------------|---------------------------|---------------------------------|
| Impeller type: Single channel impeller | Solid size 3 inch | Ø: | Max. Ø: 8 1/8" | Min. Ø: 5 9/16" | Sel. Ø: 7 5/8" |
| Operating data | | | | | |
| Speed: 1750 rpm | Frequency: 60 Hz | Duty point: Q = 275 US g.p.m. | H = 35 ft | | Suction port: 4" ANSI |
| Power data referred to: Water, pure [100%]; 68°F; 62.322lb/ft³; 1.0818E-5ft²/s | | | | Testnorm: | ISO 9906 |
| Curve number: | | | | | |
| | | | | | |
| | | | | | |
| | | | | | |
| Project Man. Cty IFB #09-0897-OV | Project no.: LS # 6 | | Created by: nyackerman | Page: 2 | Date: 4/1/2009 |

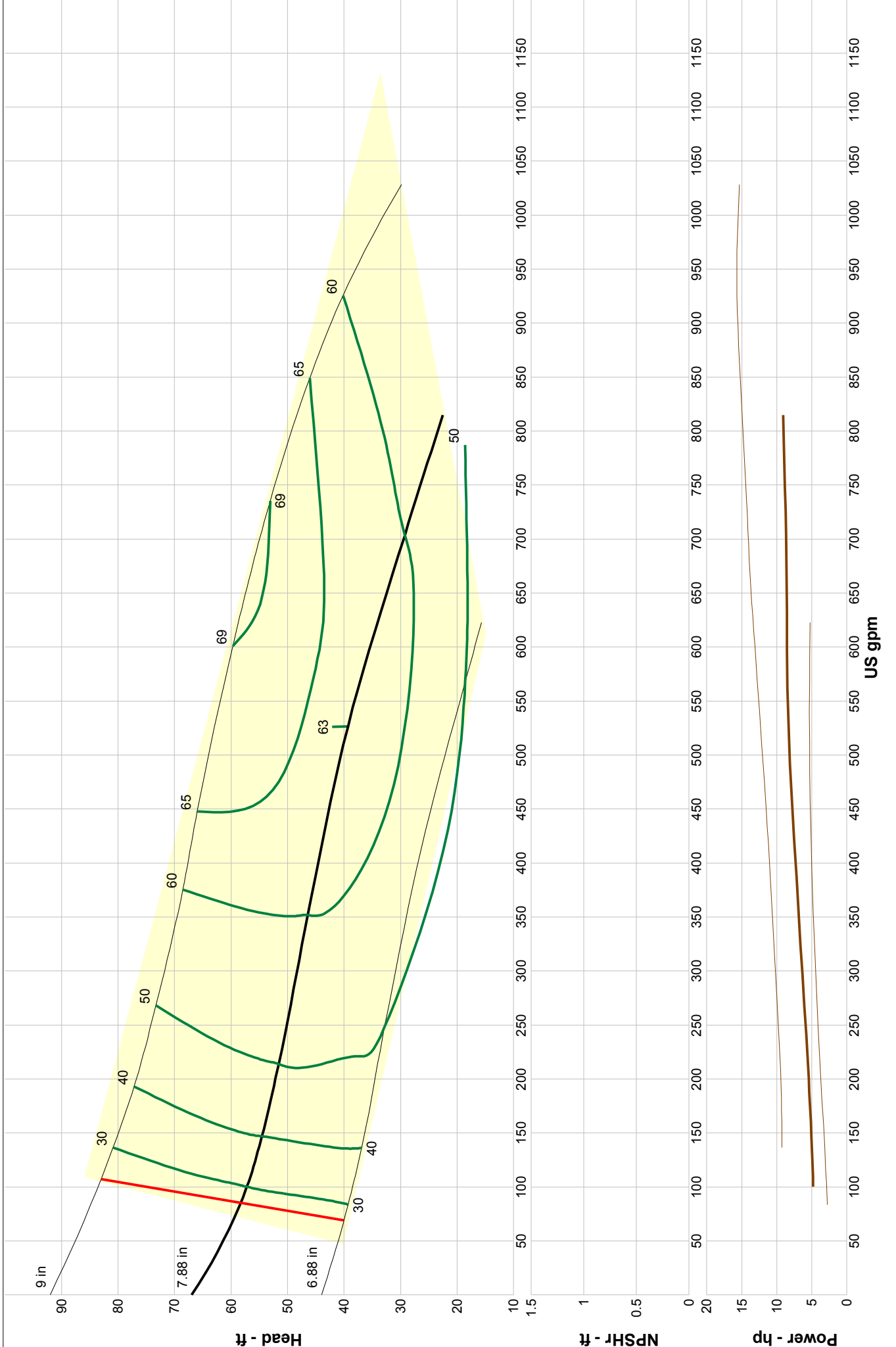

Company: Manatee County Utilities
 Name: #9 - RTU# 060
 4/9/2012

HYDROMATIC
 Catalog: Non-Clog Pumps 60Hz, Vers Feb 2006
 NCLOG-4 - 1800

Size: S4M/S4MX
 Speed: 1750 rpm
 Dia: 7.88 in
 Curve: S4M1750





ITEM # 12

PERFORMANCE CURVES

| | | | |
|----------------------|----------|----------------------|-----------------------------|
| 4-poles ; 1750 rpm | M | Enclosed | ③ Type: AM434-160/4.3N (FM) |
| 4" Nominal discharge | | single-vane impeller | |
| 3" Solid size | | 60 Hz | |

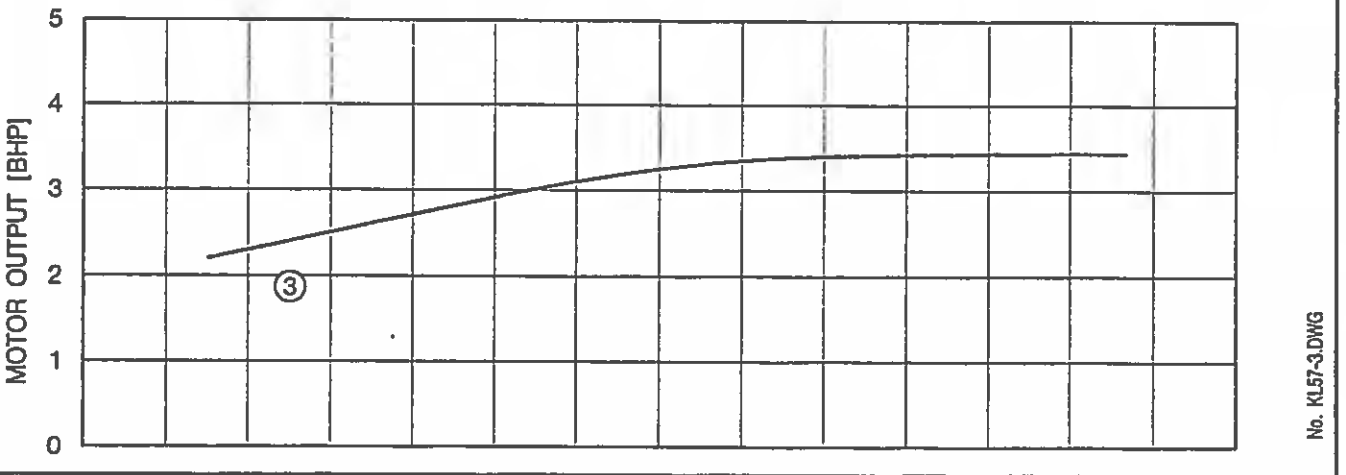
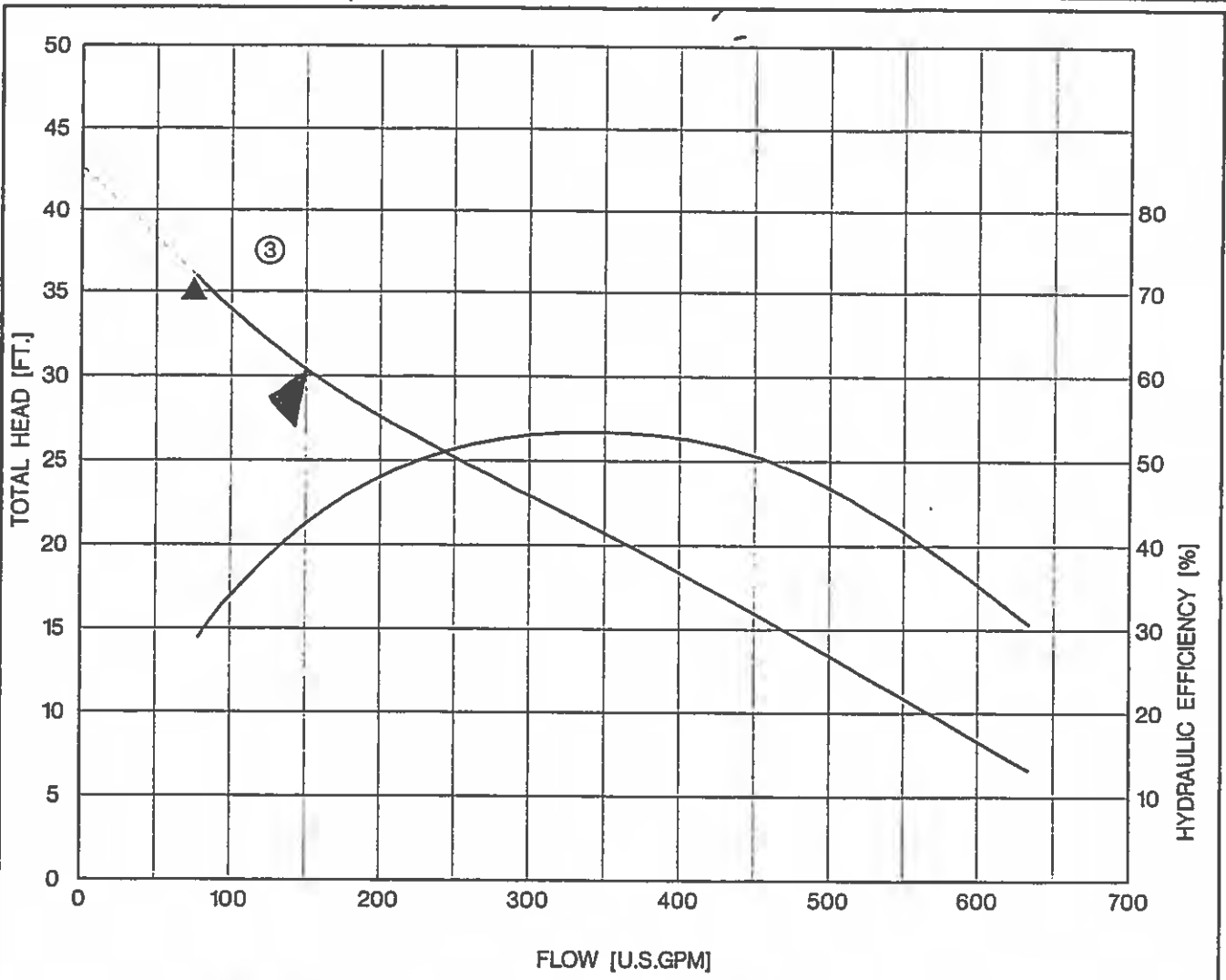

No. KL57-3.DWG



Performance Curve

AMX646-310/15,3P/C

| Impeller | | | | | |
|--|-----------------------------|--|---|--|---|
| Impeller type: Single channel impeller | Solid size 4 inch | Ø: | Max. Ø: 12⁵/₁₆" | Min. Ø: 10³/₈" | Sel. Ø: 12⁵/₁₆" |
| Operating data | | | | | |
| Speed: 1160 rpm | Frequency: 60 Hz | Duty point: Q = 800 US g.p.m. H = 35 ft | | Suction port: | Discharge port: 6" ANSI |
| Power data referred to: Water [100%] ; 68°F; 62.322lb/ft ³ ; 1.0818E-5ft ² /s | | | | Testnorm: | ISO 9906 |

Curve number:

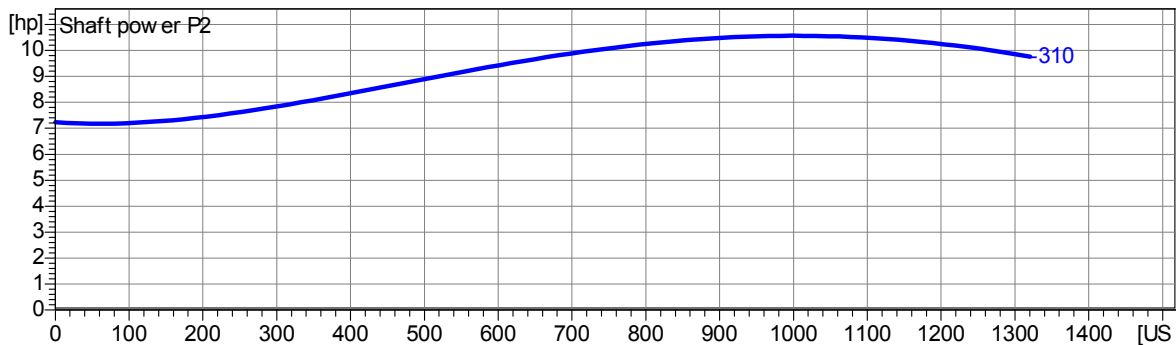
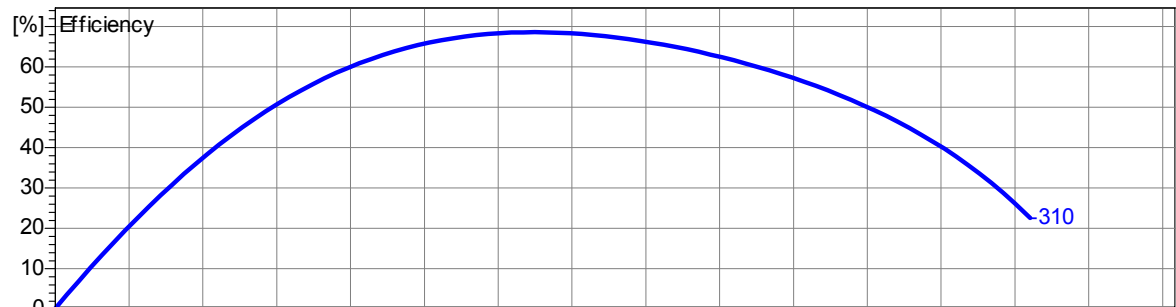
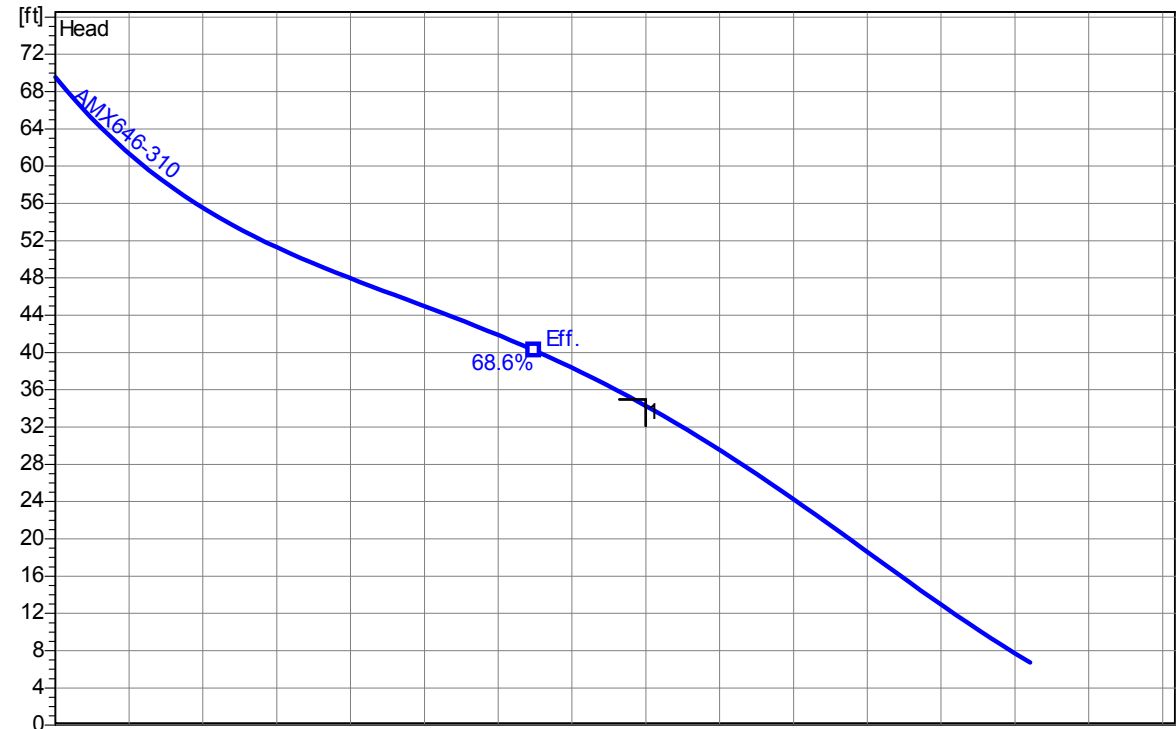

2.0 - 11.01.2008 (Build 137) Homa Pump Technology Inc. (internal)

| | | | | |
|--|-------------------------------|----------------------------------|-------------------|--------------------------|
| Project Man. Cty IFB #09-0897-OV | Project no.: LS # 7 | Created by: nyackerman | Page: 2 | Date: 4/1/2009 |
|--|-------------------------------|----------------------------------|-------------------|--------------------------|

ITEM #24

PERFORMANCE CURVES

| | | | |
|----------------------|----------|----------------------|-----------------------------|
| 4-poles ; 1750 rpm | M | Enclosed | ④ Mod.: AM434-170/5.5N (FM) |
| 4" Nominal discharge | | single-vane impeller | |
| 3" Solid size | | 60 Hz | |

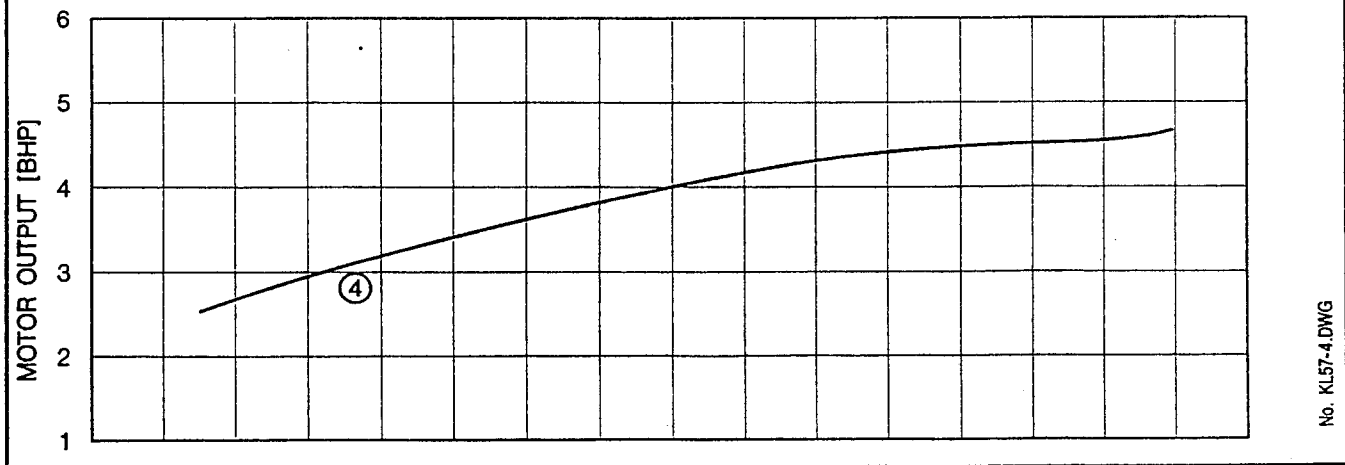
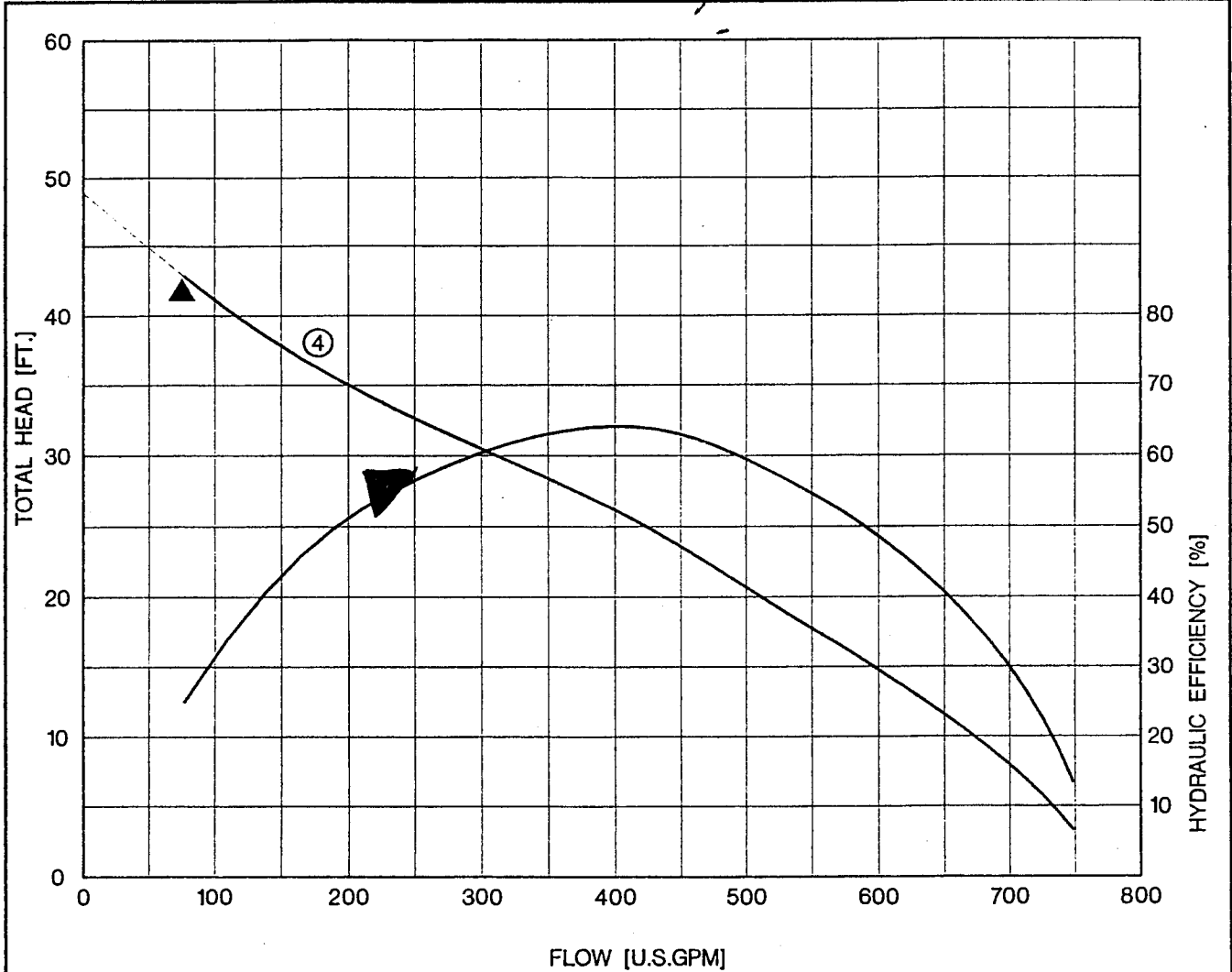

No. KL57-4.DWG

11

HOMA Pumpenfabrik GmbH

Postfach 2263 * D-53814 Neunk.-Seelscheid
 Telefon 02247 / 702-0 * Fax 02247 / 702-44

AMX646-370/21,5P

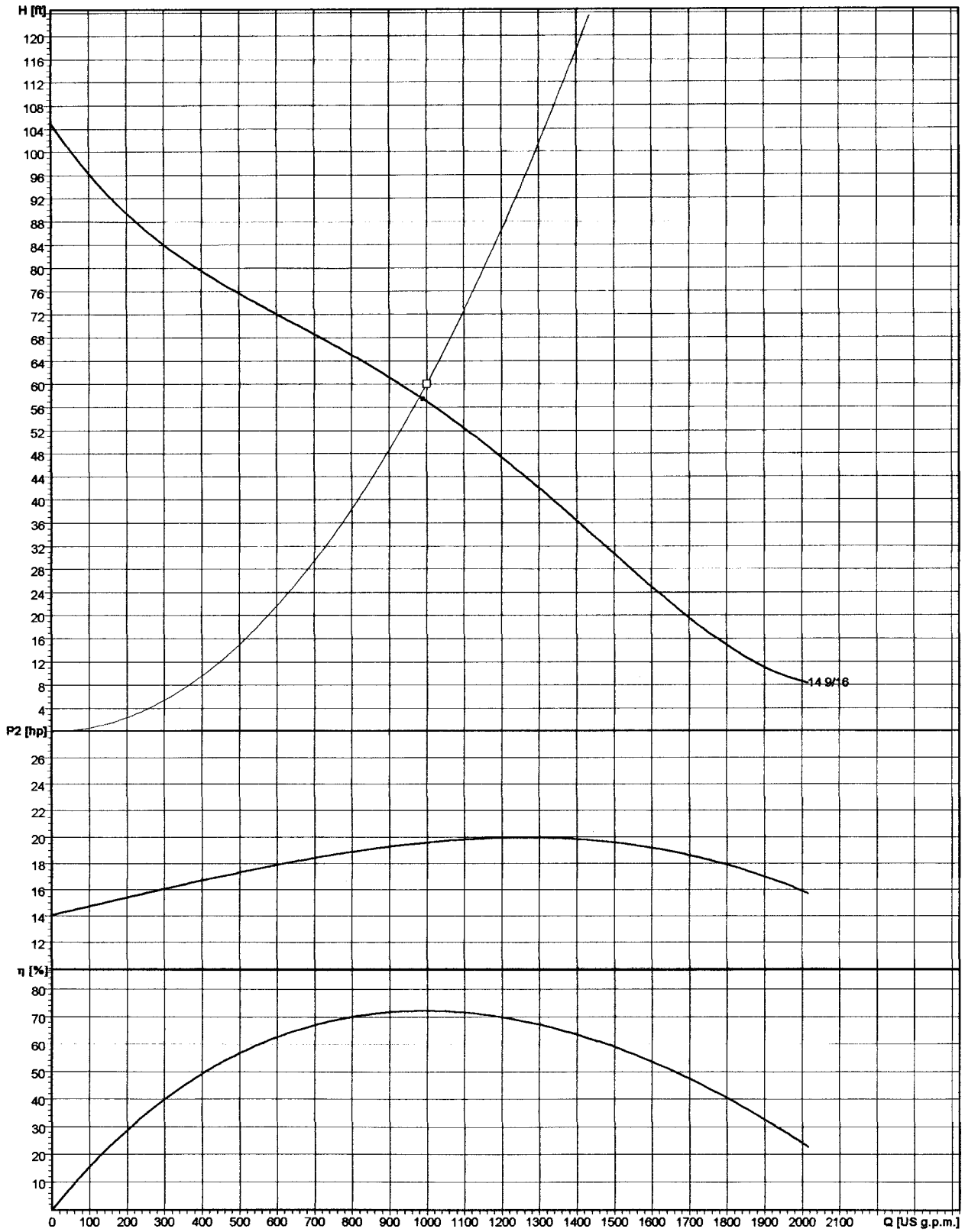

According to ISO 2548/C

| | | | | | |
|------------------------|---------------------------------|----------------|----|---------------|----------|
| Impeller type | Single channel impeller, closed | Discharge port | 6" | Frequency | 60 Hz |
| Impeller size | 14 9/16" | Free passage | 4" | Nominal speed | 1160 rpm |
| Nominal shaft power P2 | 21.5 hp | | | | |

AMX434-218/10,4T/C

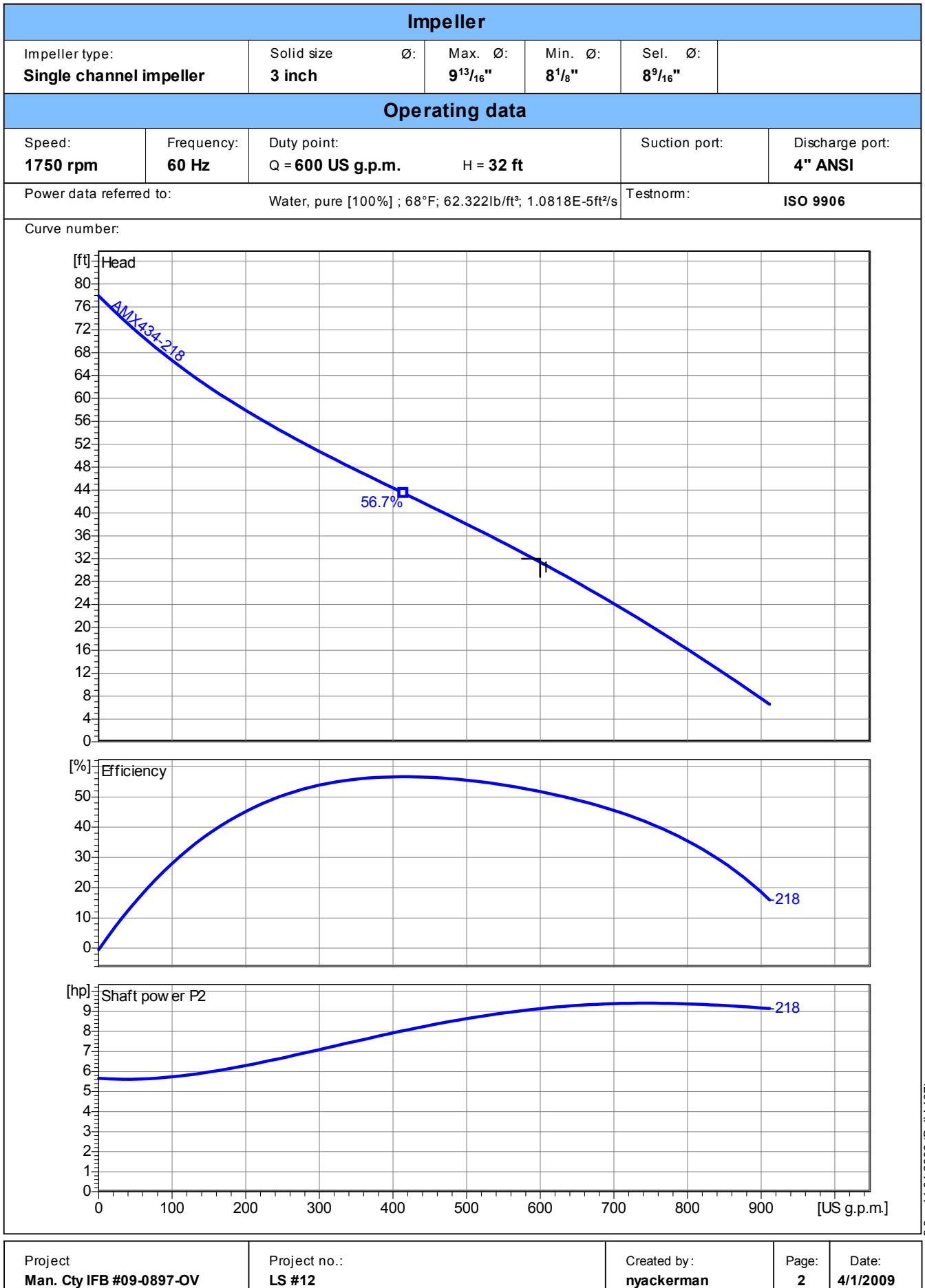

*RTU 425
El Rancho Village
Installed 7-19-11*

| Impeller | | | | | |
|--|-----------------------------|---|--------------------------|---------------------------|---------------------------------|
| Impeller type: Single channel impeller | Solid size 3 inch | Ø: | Max. Ø: 8 1/8" | Min. Ø: 5 9/16" | Sel. Ø: 7 1/4" |
| Operating data | | | | | |
| Speed: 1750 rpm | Frequency: 60 Hz | Duty point: Q = 125 US g.p.m. | H = 37 ft | | Suction port: 4" ANSI |
| Power data referred to: Water, pure [100%] ; 68°F; 62.322lb/ft³; 1.0818E-5ft²/s | | | Testnorm: | ISO 9906 | |

Curve number:

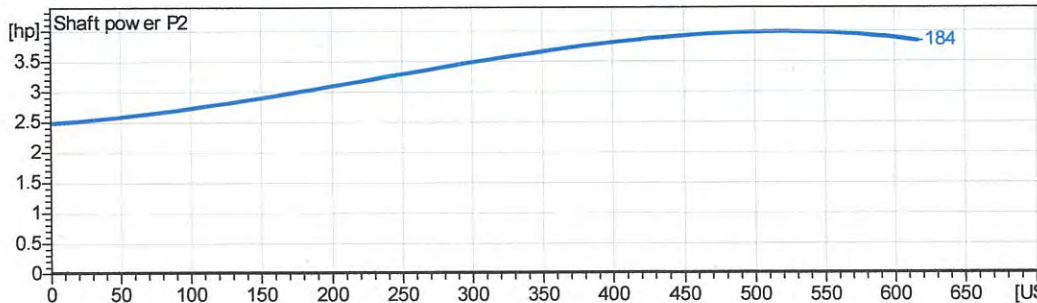
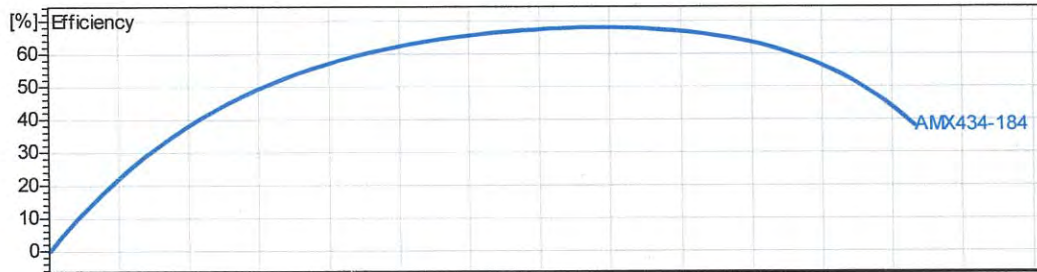
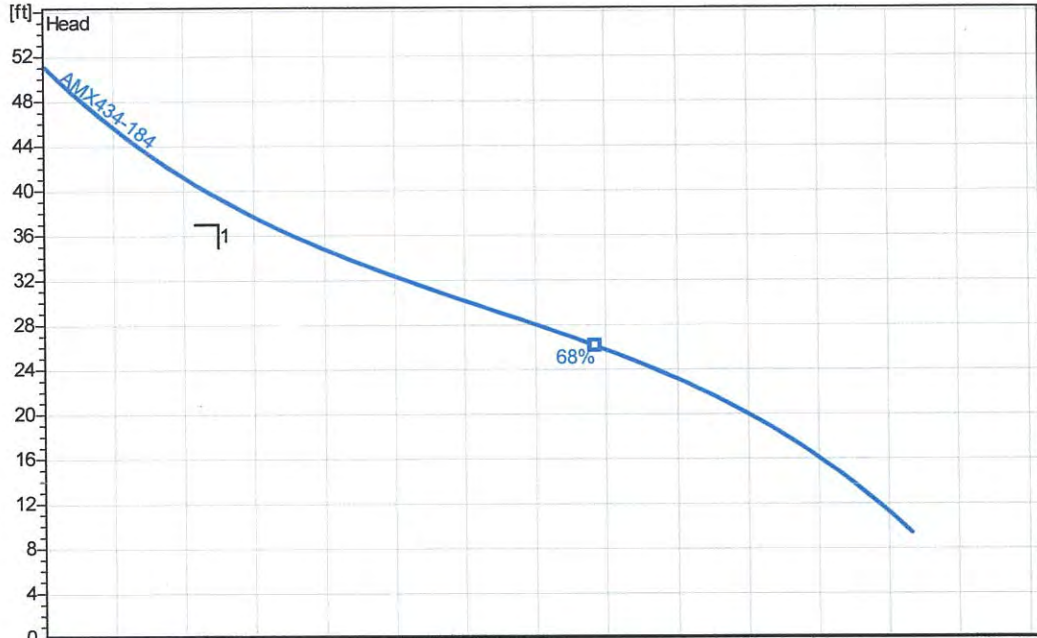

| | | | | |
|----------------------------------|--|----------------------------------|-------------------|----------------------------|
| Project Manatee County | Project no.: El Rancho Village | Created by: nyackerman | Page: 2 | Date: 2010-10-08 |
|----------------------------------|--|----------------------------------|-------------------|----------------------------|

| Impeller | | | | | | |
|---|----------------------------|---|-------------------|-----------------------------------|-----------------------------------|--|
| Impeller type: Single channel impeller | Solid size 3 inch | Ø: | Max. Ø: 8 1/8" | Min. Ø: 7" | Sel. Ø: 7 5/8" | |
| Operating data | | | | | | |
| Speed: 1750 rpm | Frequency: 60 Hz | Duty point: Q = 250 US g.p.m. H = 40 ft | | Shaft power P2: 4.44 hp | Discharge port: 4" ANSI | |

Power data referred to: Water, clean [100%]; 68°F; 62.322lb/ft³; 1.0818E-5ft²/s

Testnorm: ISO 9906/A

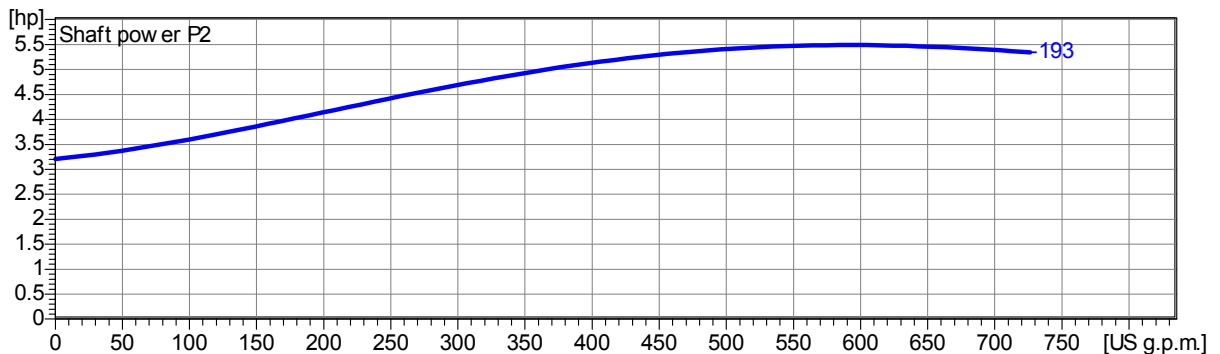
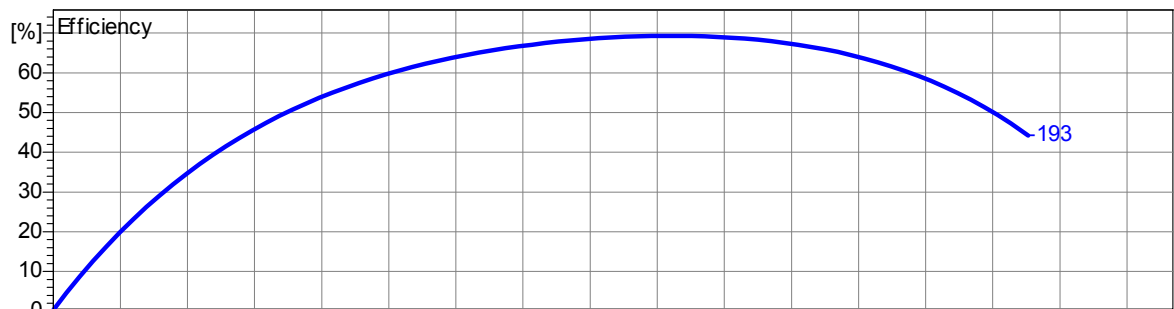
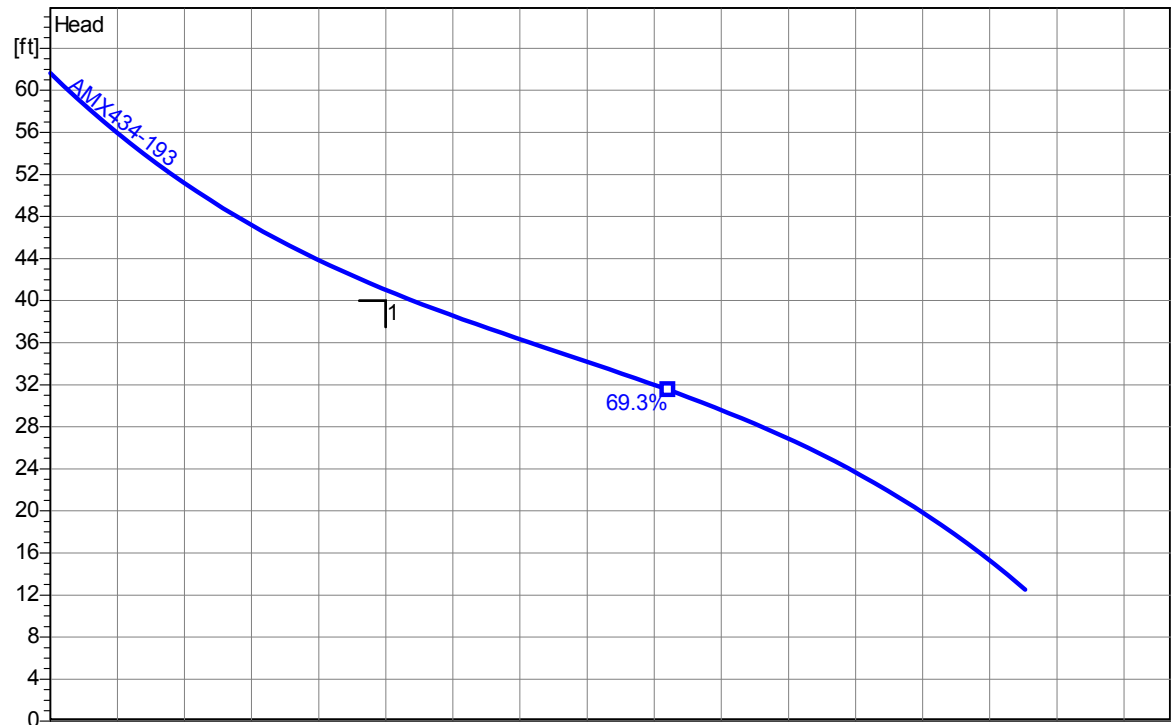

| | | | | |
|---------|---|-------------|-------------------|----------------------------|
| Project | Project no.: LIFT STATION #15 | Created by: | Page: 2 | Date: 2011-11-06 |
|---------|---|-------------|-------------------|----------------------------|

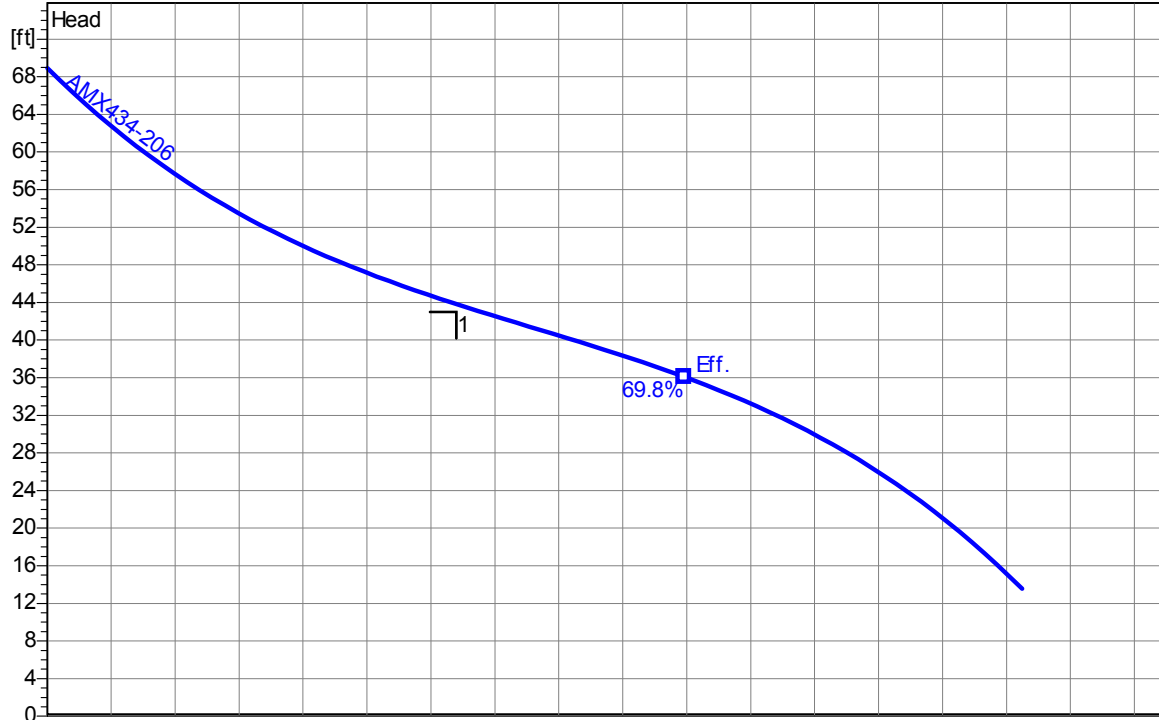
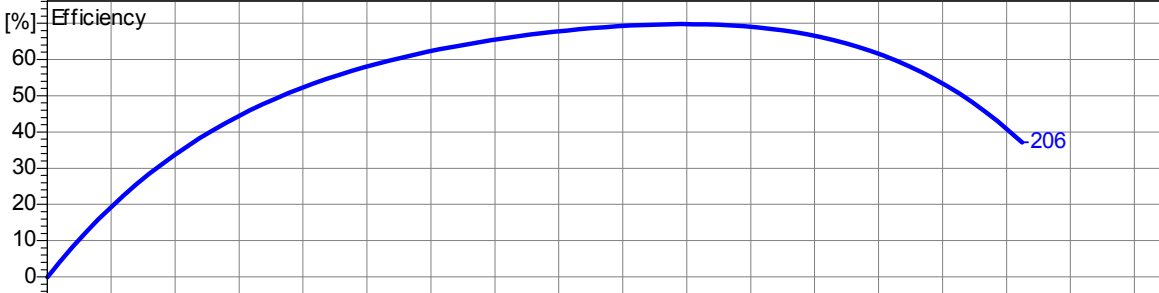
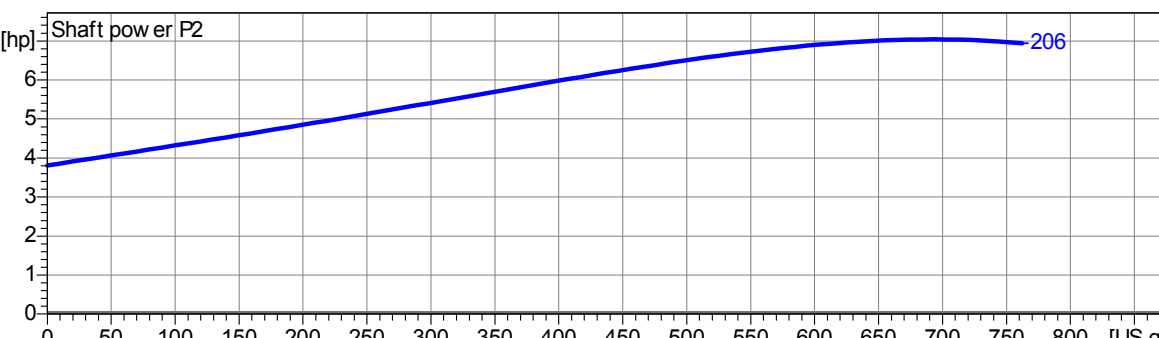
| Impeller | | | | | | |
|--|--------------------------------|--|----------------------------------|---------------------------|-----------------------------------|--------------------------|
| Impeller type: Single channel impeller | Solid size 3 inch | Ø: | Max. Ø: 8 1/8" | Min. Ø: 5 9/16" | Sel. Ø: 8 1/8" | |
| Operating data | | | | | | |
| Speed: 1750 rpm | Frequency: 60 Hz | Duty point: Q = 320 US g.p.m. H = 43 ft | | Suction port: | Discharge port: 4" ANSI | |
| Power data referred to: Water, pure [100%]; 68°F; 62.322lb/ft³; 1.0818E-5ft²/s | | | | Testnorm: | ISO 9906 | |
| Curve number: | | | | | | |
|  | | | | | | |
|  | | | | | | |
|  | | | | | | |
| Project Man. Cty IFB #09-0897-OV | Project no.: LS # 14 | | Created by: nyackerman | | Page: 2 | Date: 4/1/2009 |

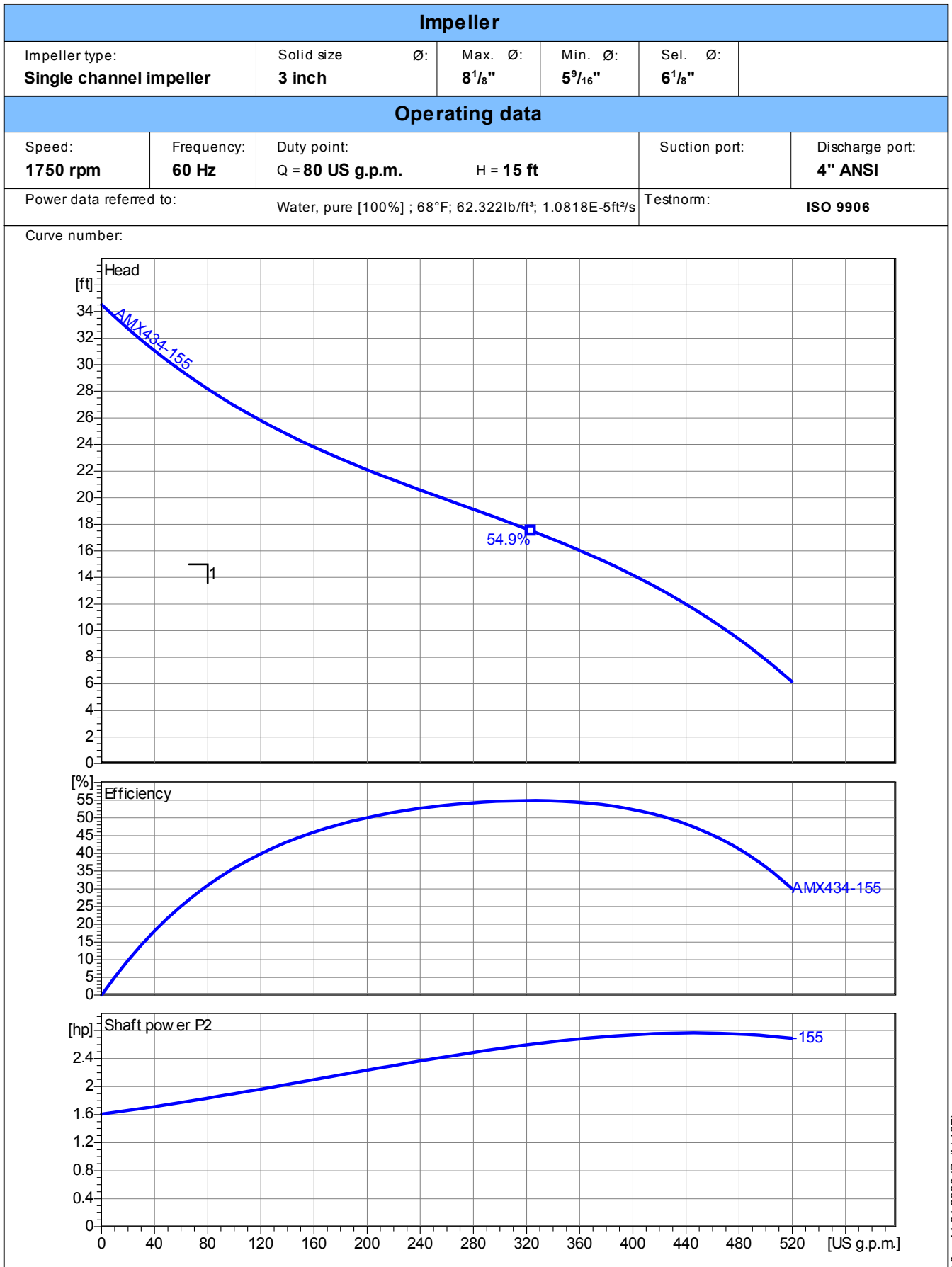

| | | | | |
|--|--|----------------------------------|-------------------|--------------------------|
| Project Man. Cty IFB #09-0897-OV | Project no.: Bayou Condominums | Created by: nyackerman | Page: 2 | Date: 4/1/2009 |
|--|--|----------------------------------|-------------------|--------------------------|

I&O Manual

1½", 2" & 3" Discharge

inches
(mm)

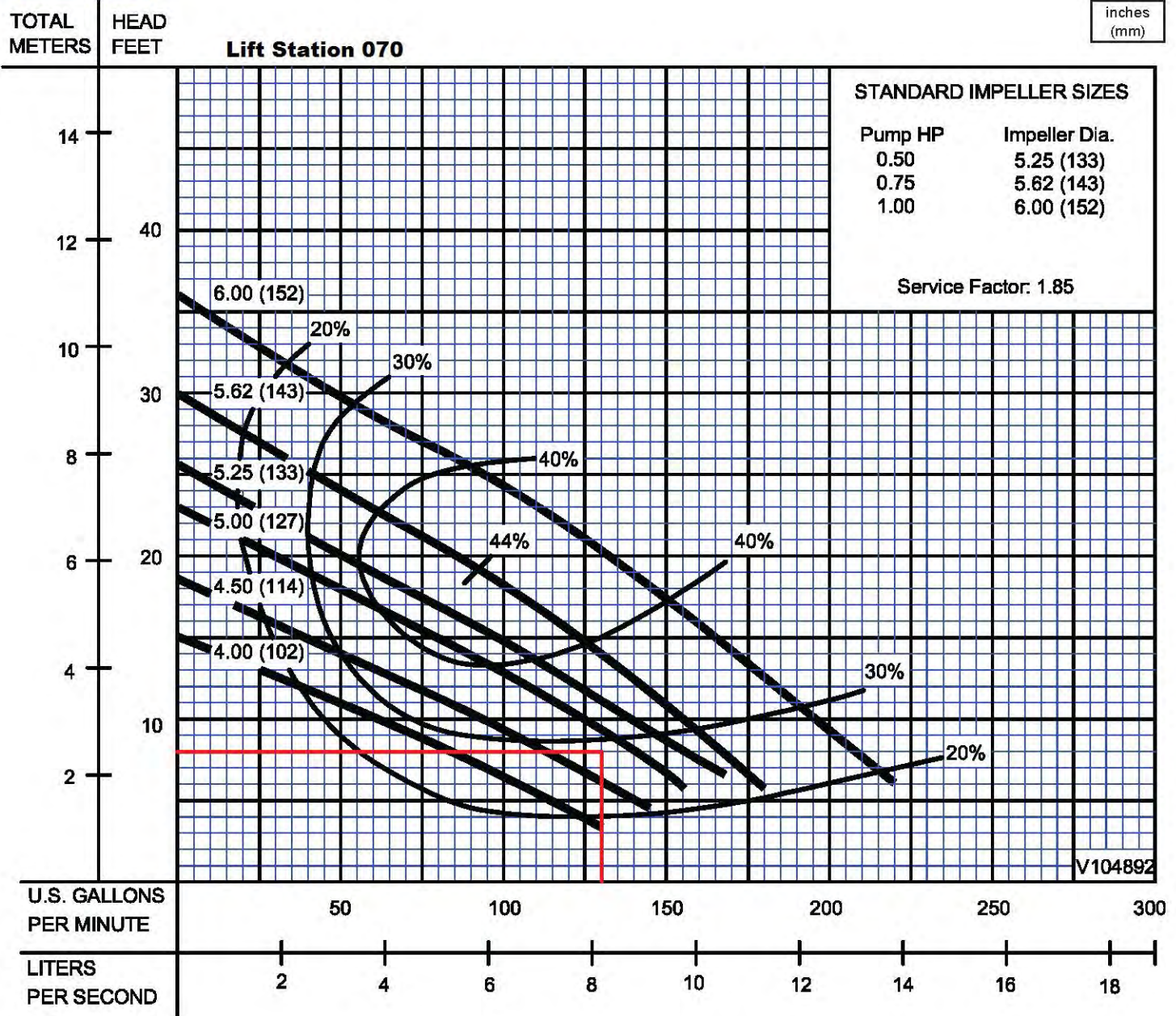

Testing is performed with water, specific gravity 1.0 @ 68° F @ (20°C), other fluids may vary performance

GPM: 130 TDH: 8'



TEST REPORT

DFG °") #

PRODUCT

| | | | | | |
|-------------------------------------|---------------------------|--|------------|-----------------------------|---------------------|
| Serial No. 3301.180 0910047 | | Performance curve No. 63- 634-00-3130 | | Motor module/type 131 | Voltage (V) 460 |
| Base module 032 | Impeller No. 608 69 40 | Gear type | Gear ratio | Imp.diam/Blade angle 404 | Water temp °C 15 |

TEST RESULTS

| Pump total head H (ft) | Volume rate of flow Q (USGpm) | Motor input power P (kW) | Voltage U (V) | Current I (A) | Overall efficiency η (%) |
|---------------------------|----------------------------------|-----------------------------|------------------|------------------|----------------------------------|
| 135.71 | 52.4 | 45.36 | 460 | 76.5 | 2.96 |
| 110.13 | 1011.5 | 46.91 | 460 | 78.4 | 44.79 |
| 96.11 | 1852.2 | 52.55 | 460 | 85.1 | 63.91 |
| 83.79 | 2760.7 | 58.70 | 459 | 92.6 | 74.34 |
| 69.31 | 3740.1 | 65.58 | 458 | 101.5 | 74.57 |
| 52.67 | 4788.9 | 70.95 | 458 | 108.9 | 67.06 |
| 34.04 | 5425.6 | 72.10 | 458 | 110.4 | 48.33 |

| | | | | |
|----------------------|--------------------------------|--------------------------|---------------|----------------------|
| Accepted after HI | Test facility Lindas Sweden | Test date Q1 09-02-09 | Time 13:31 | Chief tester 5579 |
|----------------------|--------------------------------|--------------------------|---------------|----------------------|

ORDERNR 245702 POS 1

PLOTTED TEST RESULTS Measured point : + = Q/H Duty point : \diamond = Q/H Calculated point : \wedge = Q/ETA overall
 X = Q/P \square = Q/P 1
 \triangle = Q/ETA overall

TOTAL HEAD

INPUT POWER

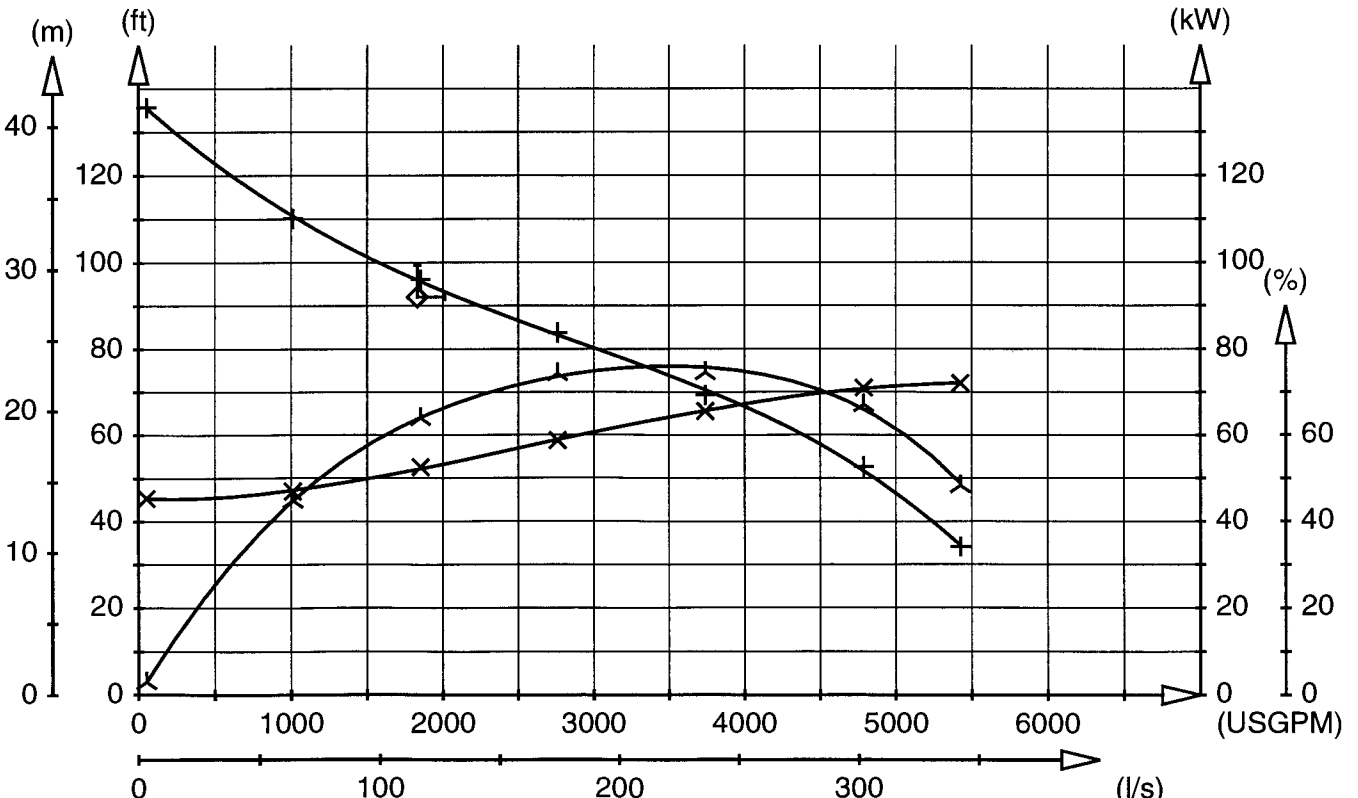



Performance Data

Tortuga Inn RTU 073

Submittal Prepared for: ITT R&CW-SF

Job:

Proposal No: GH11-11-02 04
Manatee 4

Engineer:

Contractor:

Item No: ITEM 001

Submittal Prepared by: Greg Hogan

Company:

Date: November 2, 2011

Submittal Date: November 2, 2011

Approved by:

| Hydraulic Data | | | | | Motor Data | Pump Model |
|----------------|--------------------|-------------|-------------------|-------|---------------|------------|
| Maximum Flow | Flow at Duty Point | Maximum TDH | TDH at Duty Point | NPSHR | Voltage/Phase | |
| 396.2 gpm | 85.0 gpm | 20.4 ft | 15.0 ft | | 230V 1 Phase | WS-D4 |

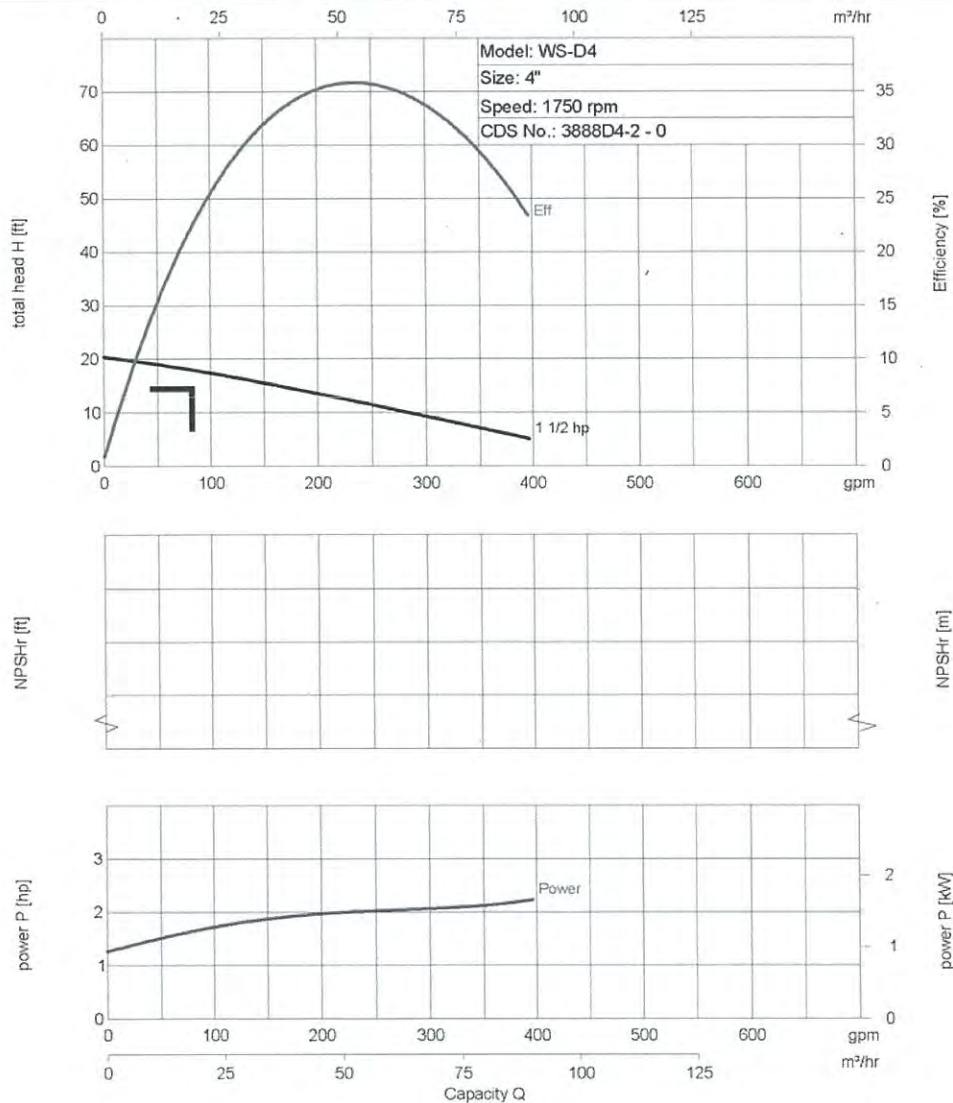

Company: Manatee County Utilities
 Name: Sunbow Bay - RTU 074
 Date: 4/9/2012



Pump:

Size: S4N/S4NX
 Type: NCLOG-4
 Synch speed: 1800 rpm
 Curve: PAGE 109
 Specific Speeds:
 Dimensions:
 Speed: 1750 rpm
 Dia: 5.5 in
 Impeller:
 Ns: ---
 Nss: ---
 Suction: --- in
 Discharge: 4 in

Search Criteria:

Flow: --- US gpm
 Head: --- ft

Fluid:

Water
 Density: 62.37 lb/ft³
 Viscosity: 1.105 cP
 NPSHa: --- ft
 Temperature: 60 °F
 Vapor pressure: 0.2563 psi a
 Atm pressure: 14.7 psi a

Motor:

Consult HYDROMATIC to select a motor for this pump.

Pump Limits:

Temperature: 140 °F
 Pressure: 125 psi g
 Sphere size: 3 in
 Power: --- hp
 Eye area: --- in²

---- Data Point ----

Flow: 450 US gpm
 Head: --- ft
 Eff: --- %
 Power: --- hp
 NPSHr: --- ft

---- Design Curve ----

Shutoff head: 27.1 ft
 Shutoff dP: 11.7 psi
 Min flow: 45 US gpm
 BEP: 50% @ 320 US gpm
 NOL power:
 2.06 hp @ 250 US gpm

-- Max Curve --

Max power:
 9.61 hp @ 677 US gpm

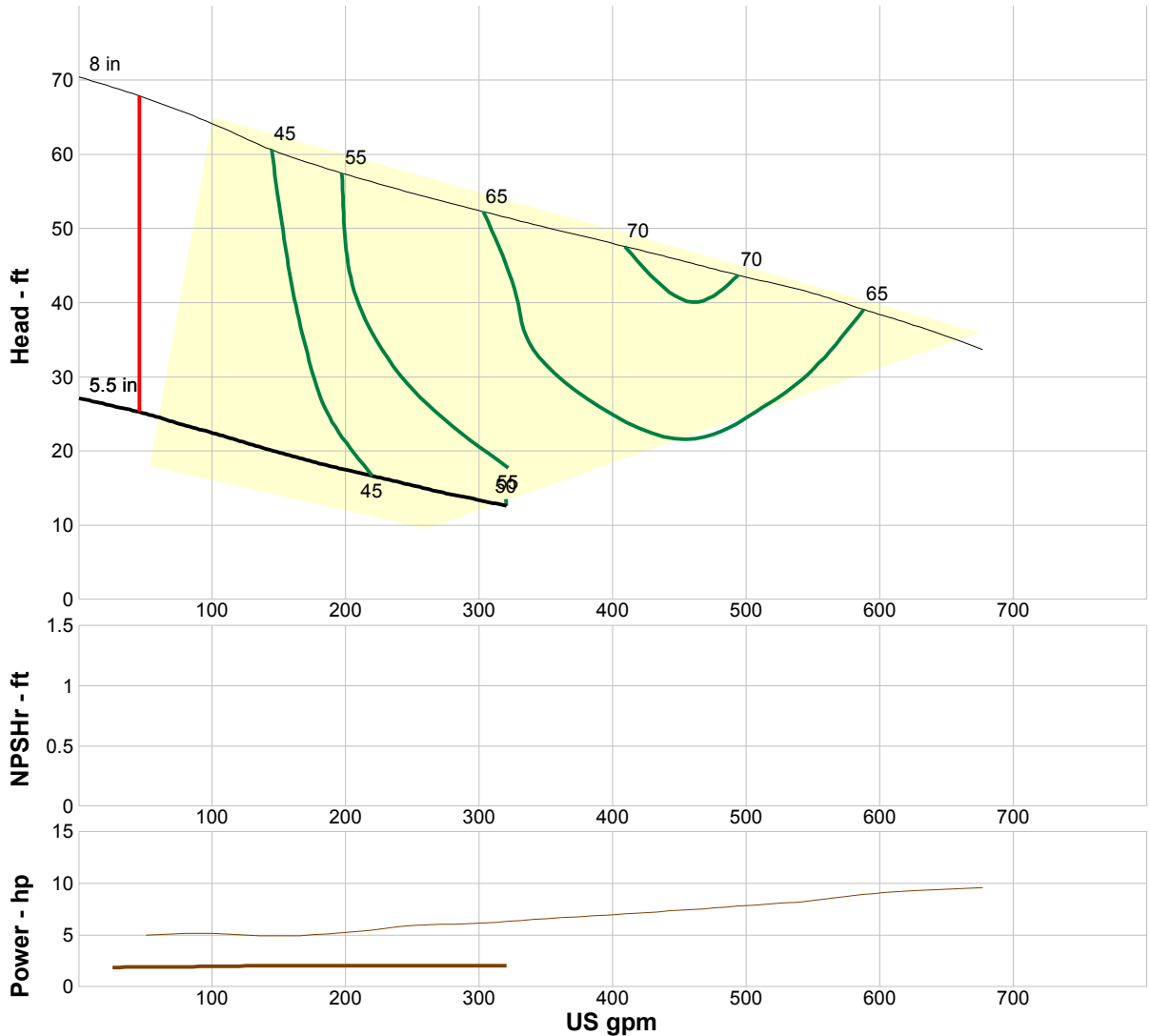

Performance Evaluation:

| Flow US gpm | Speed rpm | Head ft | Efficiency % | Power hp | NPSHr ft |
|----------------|--------------|------------|-----------------|-------------|-------------|
| 307 | 1750 | 13.1 | 50 | 2.05 | --- |
| 256 | 1750 | 15.1 | 47 | 2.06 | --- |
| 205 | 1750 | 17.2 | 44 | 2.05 | --- |
| 154 | 1750 | 19.6 | 38 | 2.02 | --- |
| 102 | 1750 | 22.3 | 29 | 1.96 | --- |

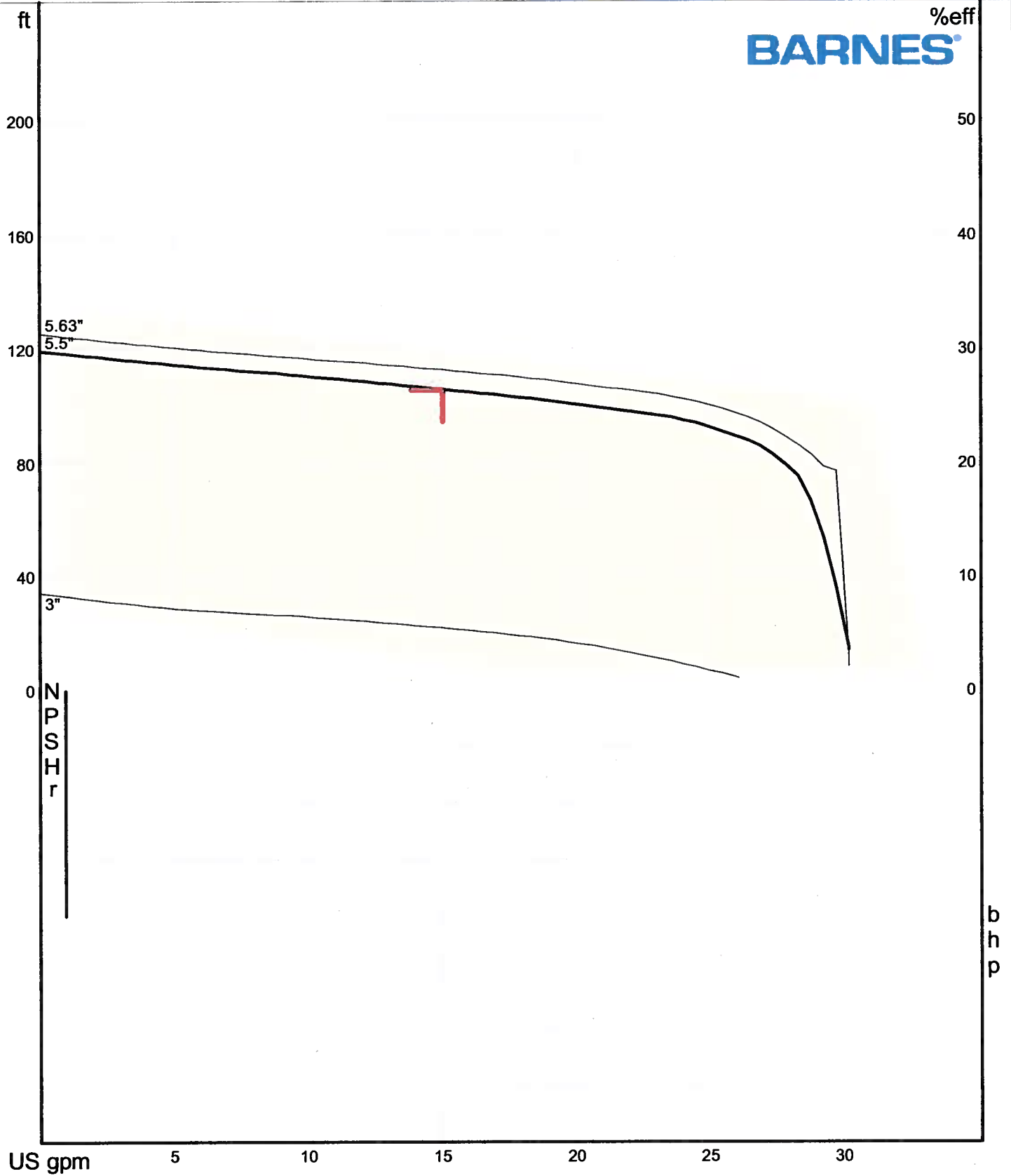

US gpm

Curve No.: v110620

Southeastern Pump

Crane/Barnes

Size: SGVH20*2L

07/07/10

Catalog: Crane Barnes 60Hz, vers 8

Speed: 3450 rpm

.ufs

3BGRINDER - 3600

Dia: 5.5 in

Design Point: 15 US gpm, 105 ft

Marine Rescue RTUO'S

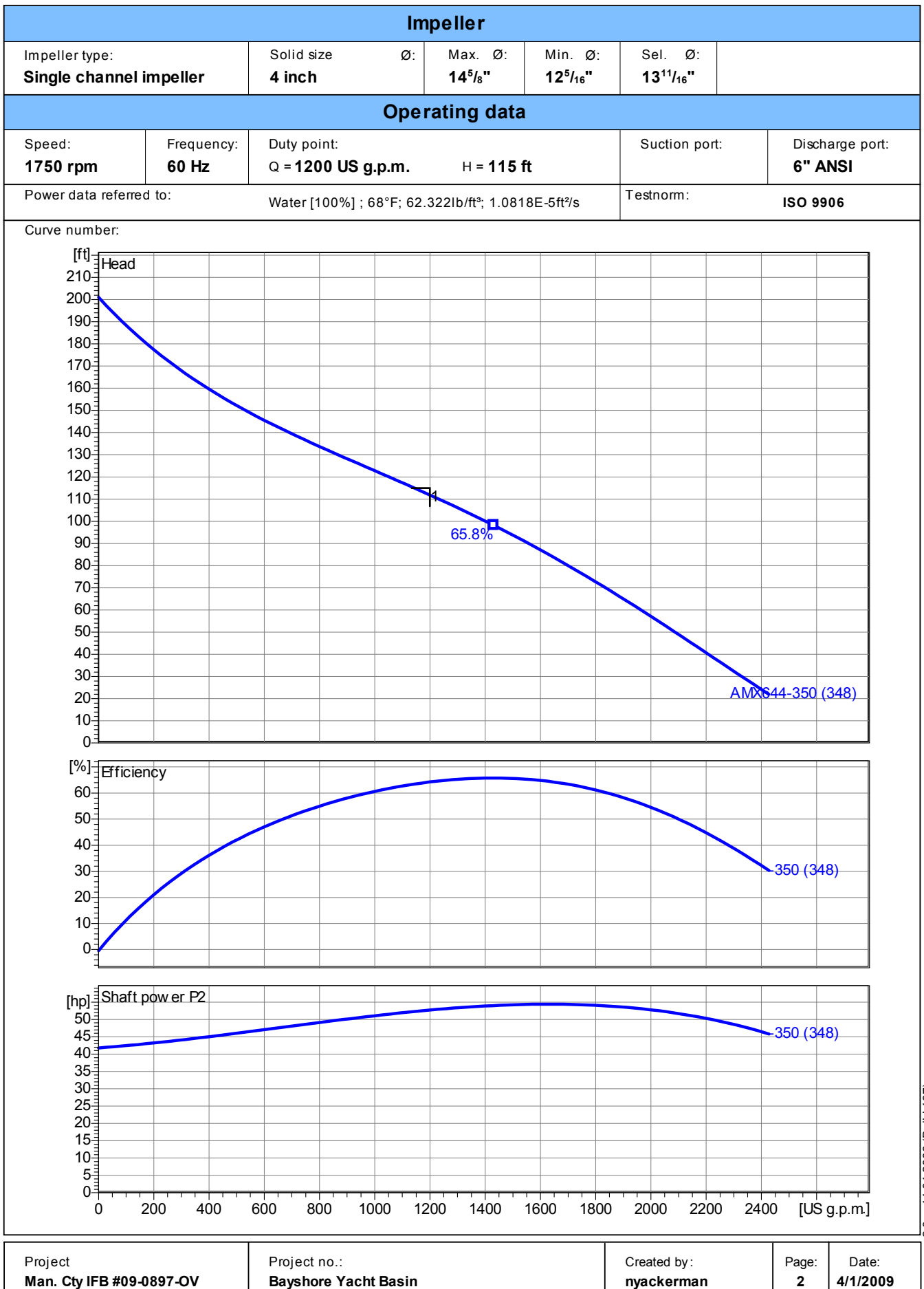

Bay Drive

102

Crane/Barnes

Selection list: ---

Catalog: Crane Barnes 60Hz vers 8

Selection Criteria:

Pump: 4SE2804L

Flow: 100 US gpm
Head: 15 ft
Tolerance: --- % of head

Type: 1D4NONCLOG
Synch speed: 1800 rpm
Speed: 1750 rpm
Dia: 5 in
Curve no.:

Fluid: Water

Temperature: 60 °F
SG: 1
Viscosity: 1.105 cP
Vapor pressure: 0.2563 psi a
Atm pressure: 14.7 psi a

Specific Speeds

Ns: --- Nss: ---

Dimensions:

Suction: --- in Discharge: 4 in

NPSHa: --- ft

Advanced Criteria:

Preferred Operating Area: ---
Secondary Operating Point: ---
Max temperature: --- °F
Max suction pressure: --- psi g
Max sphere size: --- in
Max power: --- bhp
Max suction specific speed: --- (Nss)
Min trim: --- % of max diameter
Min head rise: --- % to shutoff

Pump Limits:

Temperature: --- °F
Pressure: --- psi g
Sphere size: 3 in
Power: --- bhp

Motor: Consult vendor

Curve Corrections: none

--- Data Point ---
Flow: 100 US gpm
Head: 16.4 ft
Eff: 26%
Power: 1.56 bhp
NPSHr: --- ft

-- Design Curve --
Shutoff Head: 21.7 ft
Shutoff dP: 9.39 psi
Min Flow: --- US gpm
BEP: 37% eff
@ 175 US gpm
NOL Pwr: 2.02 bhp
@ 1 US gpm

-- Max Curve --
Max Pwr: 2.92 bhp
@ 180 US gpm

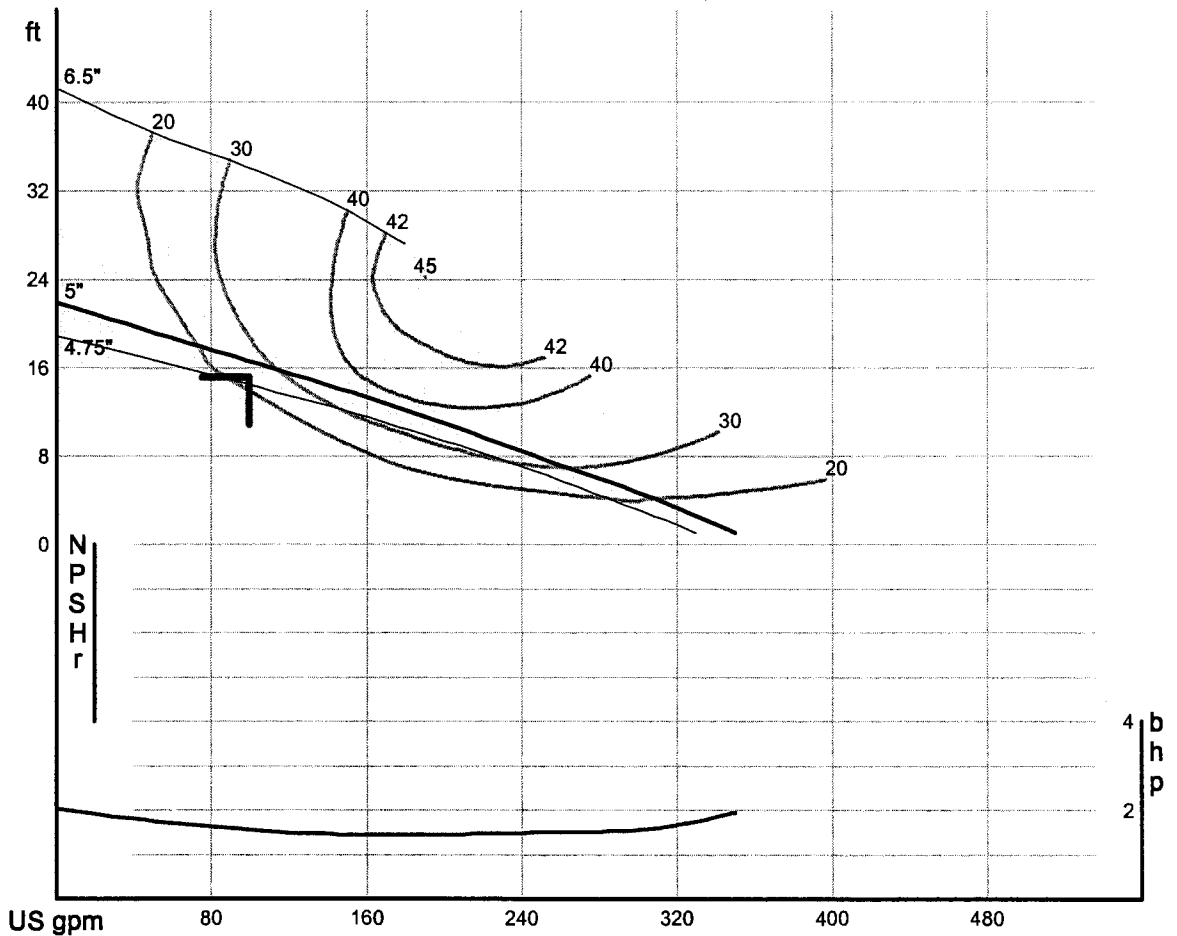

Pump note: Temp. 104°F (40°C) Continuous.



Performance Curve

AMX434-142/2.5D

El Conquistador 2 (103)

Impeller

| | | | | |
|---|--------------------------------|--------------------------|---------------------------|---------------------------|
| Impeller type: Single vane impeller | Solid size Ø: 3 1/8" | Max. Ø: 8 1/8" | Min. Ø: 5 9/16" | Sel. Ø: 5 9/16" |
|---|--------------------------------|--------------------------|---------------------------|---------------------------|

Operating data

| | | | | |
|---------------------------|----------------------------|---|---------------------------------|-----------------------------------|
| Speed: 1700 rpm | Frequency: 60 Hz | Duty point: Q = 75 US g.p.m. H = 10 ft | Suction port: 4" ANSI | Discharge port: 4" ANSI |
|---------------------------|----------------------------|---|---------------------------------|-----------------------------------|

Power data referred to: Water, pure [100%] ; 68°F; 62.322lb/ft³; 1.0818E-5ft²/s Testnorm: **ISO 9906**

Curve number:

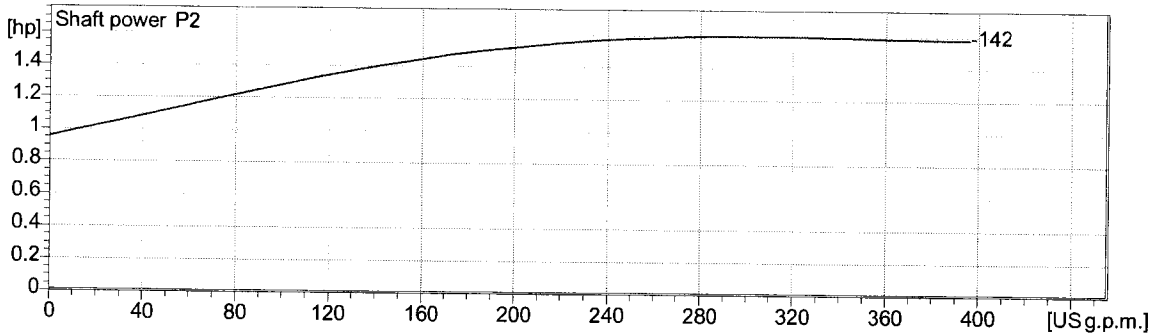
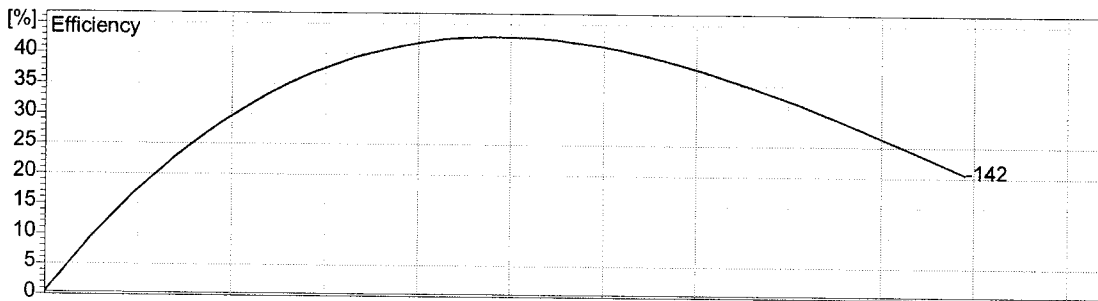
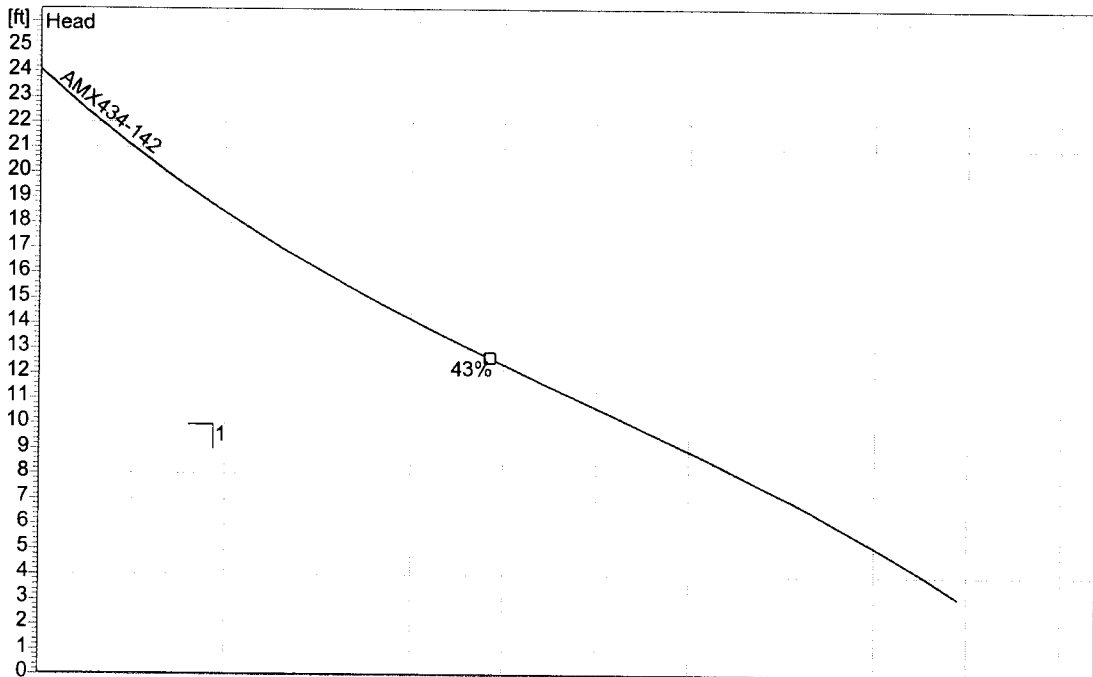

Project
Manatee Cty

Project no.:
Item Number 12

Created by:
nackerman

Page:
2

Date:
2005-09-14



Performance Curve

AMX434-193/5,5T

Wild Oak Bay (105)

Impeller

| | | | | | |
|---|-----------------------------|----|--------------------------|---------------------------|--------------------------|
| Impeller type: Single vane impeller | Solid size 3 1/8" | Ø: | Max. Ø: 8 1/8" | Min. Ø: 5 9/16" | Sel. Ø: 7 5/8" |
|---|-----------------------------|----|--------------------------|---------------------------|--------------------------|

Operating data

| | | | | |
|---------------------------|----------------------------|--|---------------|-----------------------------------|
| Speed: 1700 rpm | Frequency: 60 Hz | Duty point: Q = 125 US g.p.m. H = 45 ft | Suction port: | Discharge port: 4" ANSI |
|---------------------------|----------------------------|--|---------------|-----------------------------------|

Power data referred to: Water, pure [100%] ; 68°F; 62.322lb/ft³; 1.0818E-5ft²/s Testnorm: **ISO 9906**

Curve number:

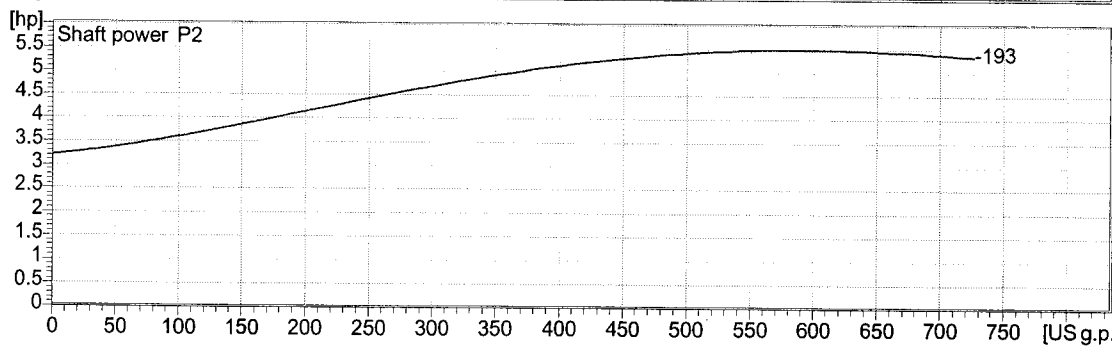
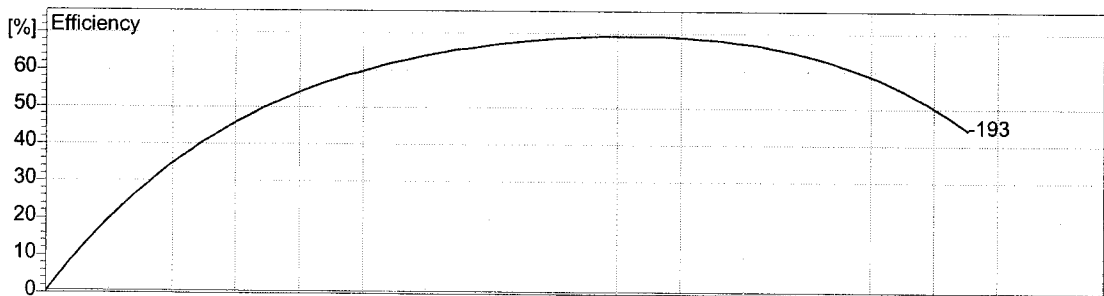
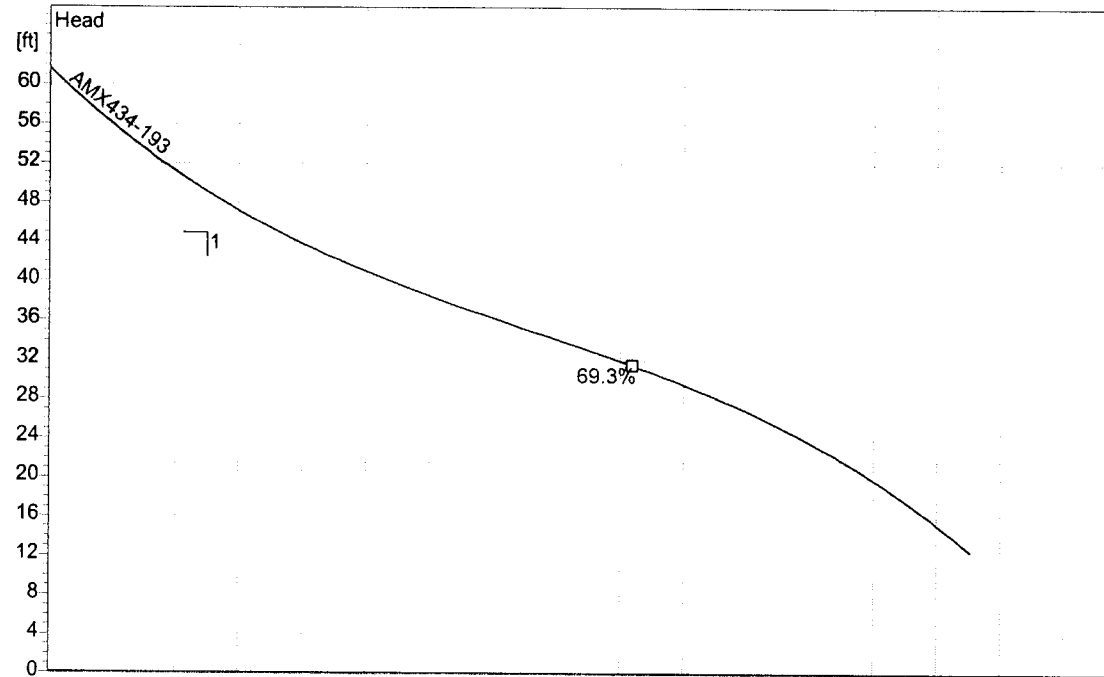

2.0 - 29.09.2004 (Build 60)

7.5 HP - 1750 RPM
 3 ϕ : 200, 230/460, 575V

H.H. C-3126

Wastewater Impeller 462

| SECTION | PAGE |
|--------------------|----------------|
| 3126 | 8E |
| SUPERSEDES 3/79 | ISSUED 6/81 |

Vivenda

106

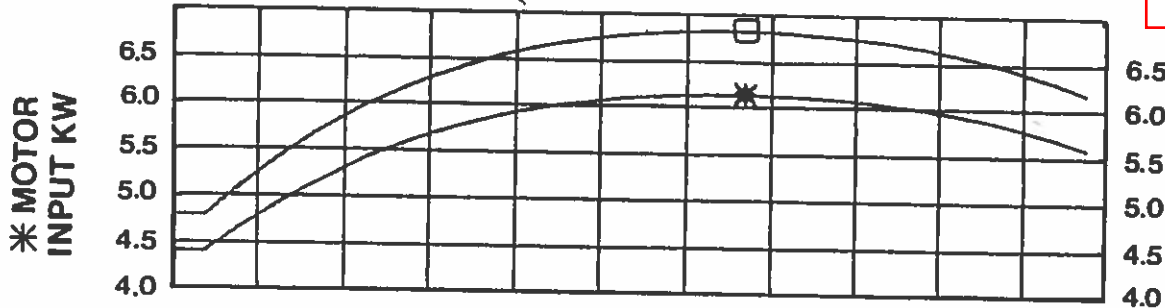

□ BRAKE HP

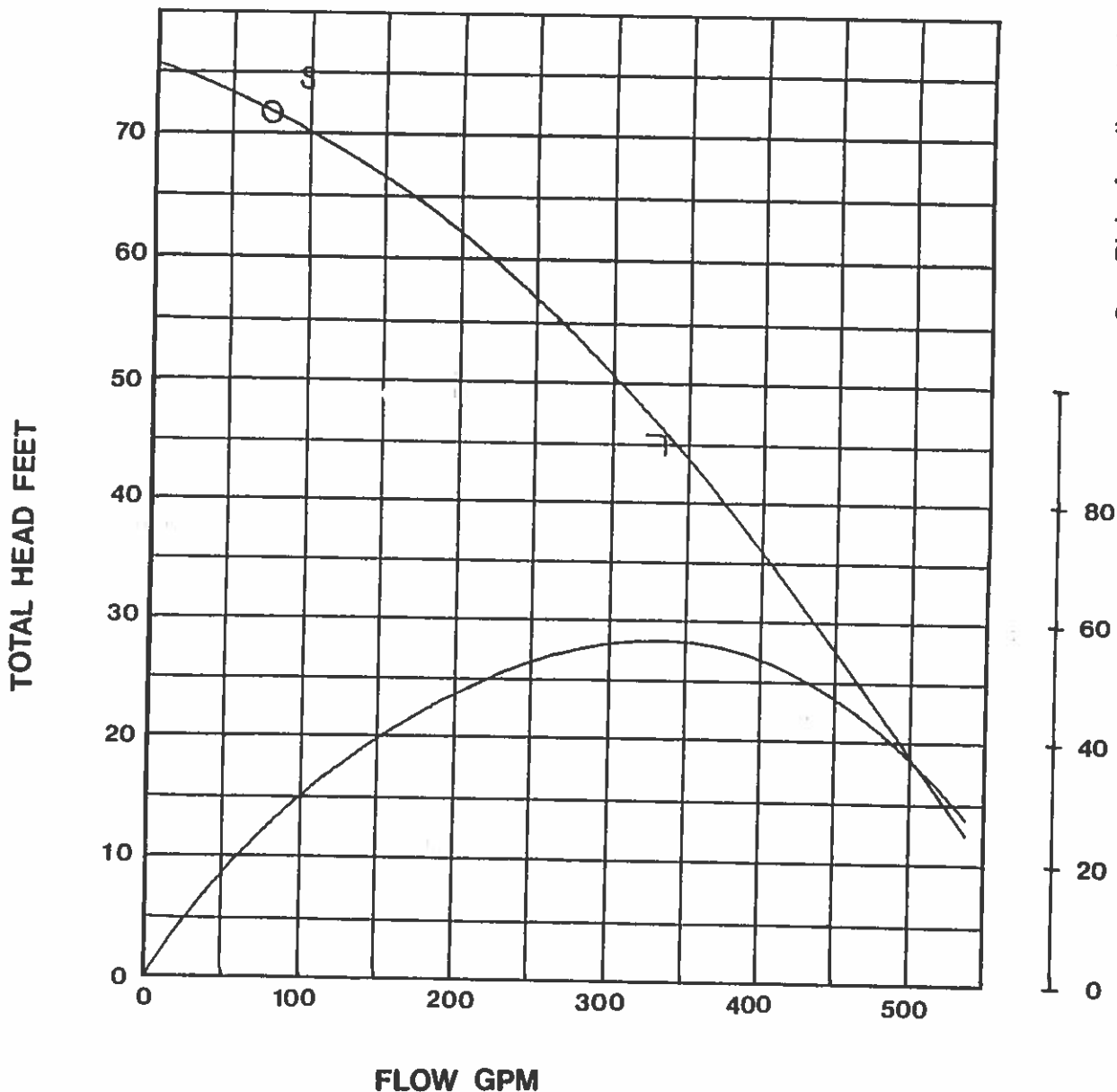

S = Risk of sedimentation at velocity below 2 FT/sec.

HYDRAULIC EFFICIENCY

PERFORMANCE CURVES ARE BASED ON TESTS WITH CLEAR WATER AT AMBIENT TEMPERATURE.



FLYGT CORPORATION
 A SUBSIDIARY OF IIT
 129 GLOVER AVE., NORWALK, CT. 06856

RTU 107



Performance Curve

AMX434-250/13P/C

| Impeller | | | | | |
|---|----------------------|--|--|--|--|
| Impeller type: Single channel impeller | Solid size 3 inch | Ø: 9 ¹³ / ₁₆ " | Max. Ø: 8 ¹ / ₈ " | Min. Ø: 8 ¹ / ₈ " | Sel. Ø: 9 ¹³ / ₁₆ " |
| Operating data | | | | | |
| Speed: 1750 rpm | Frequency: 60 Hz | Duty point: Q = 75 US g.p.m. | H = 78 ft | | Suction port: 4" ANSI |
| Power data referred to: | | Water, pure [100%]; 68°F; 62.322lb/ft ³ ; 1.0818E-5ft ³ /s | | | Testnorm: ISO 9906 |

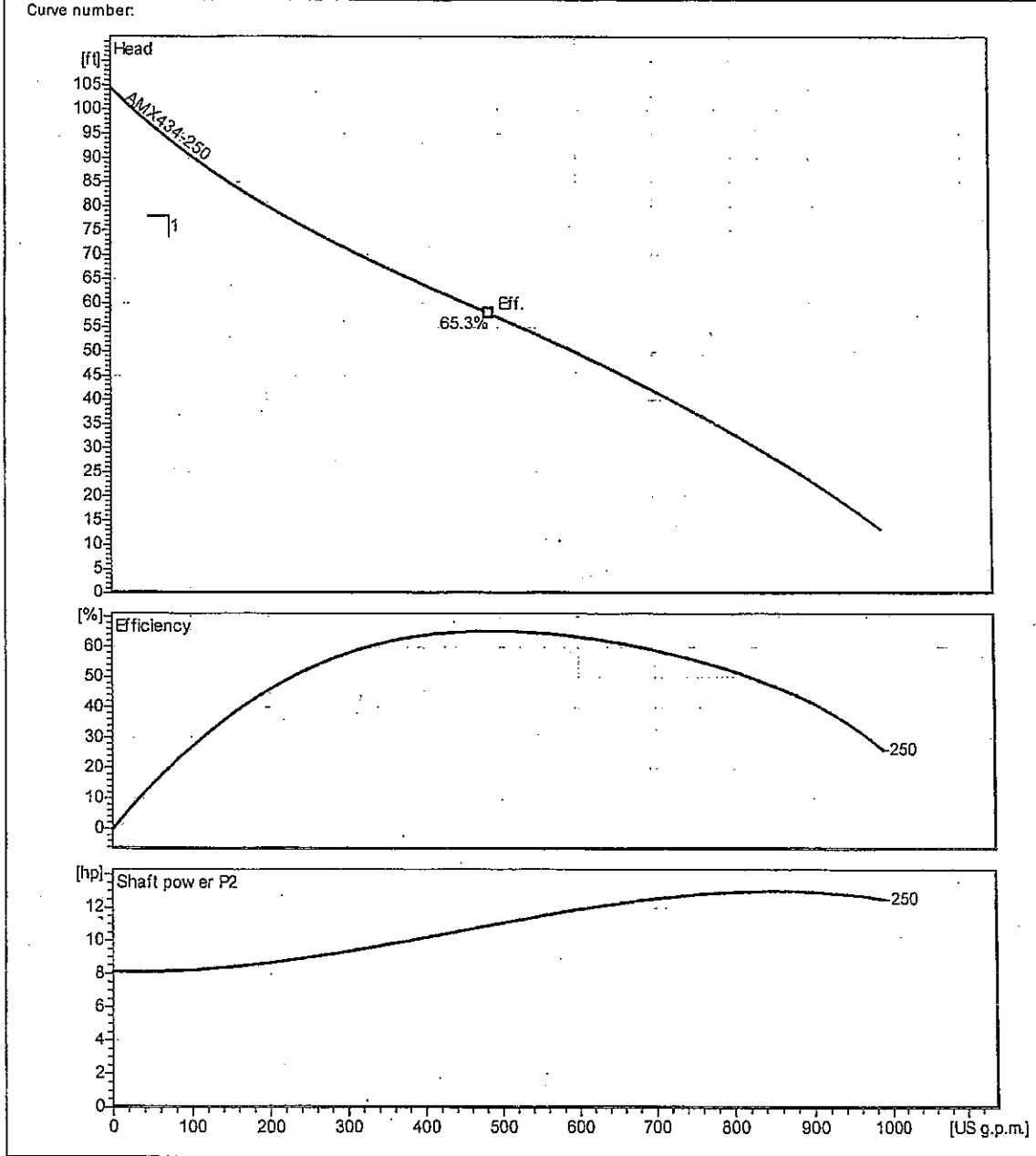

| | | | | |
|---------------------------|-----------------------------|---------------------------|------------|-------------------|
| Project Manatee County | Project no.: Mirror Lake | Created by: nyackerman | Page: 2 | Date: 1/3/2011 |
|---------------------------|-----------------------------|---------------------------|------------|-------------------|

2.0 - 11.01.2008 (Build 137) - Homa Pump Technology Inc. (internal)

MODEL: S4HRC - SUBMERSIBLE SEWAGE PUMPS

Lit. No. 436.2 9309

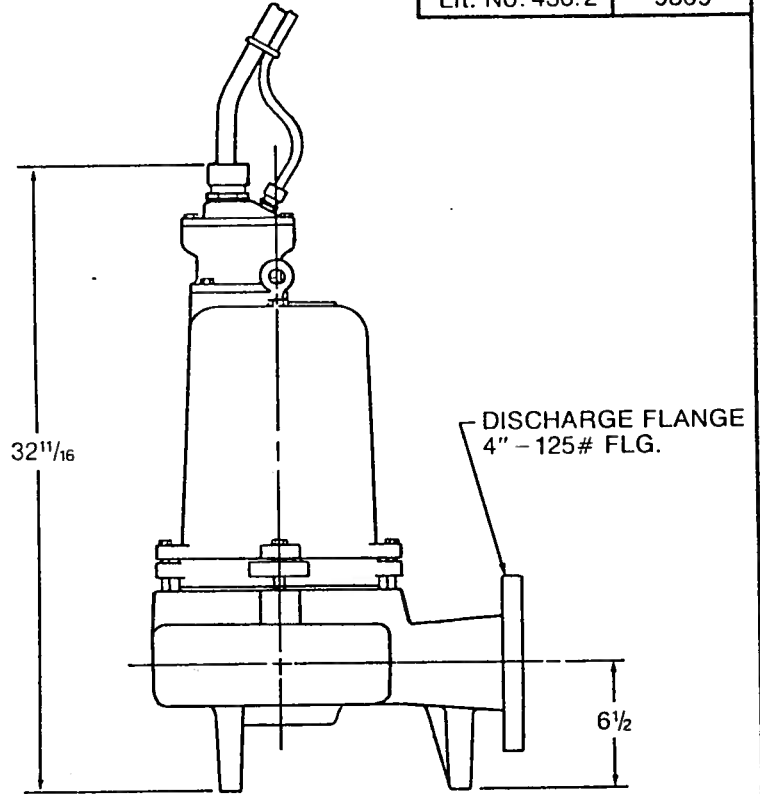
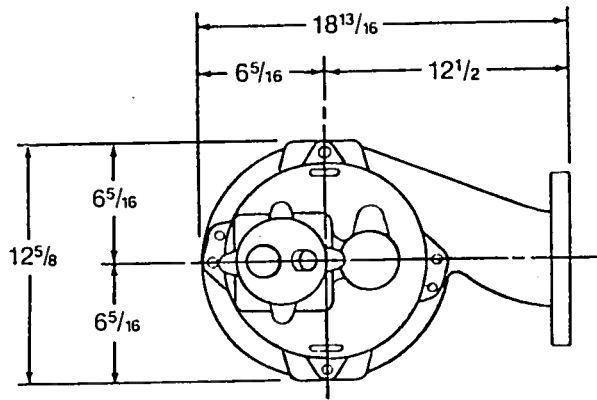

NOTE: CASTING
DIMENSIONS MAY
VARY ± 1/8"

MODEL: S4HRC SUBMERSIBLE SEWAGE PUMP - MAX. SOLIDS: 3" SPHERE - 3500 RPM

Lit. No. 433.2 9332

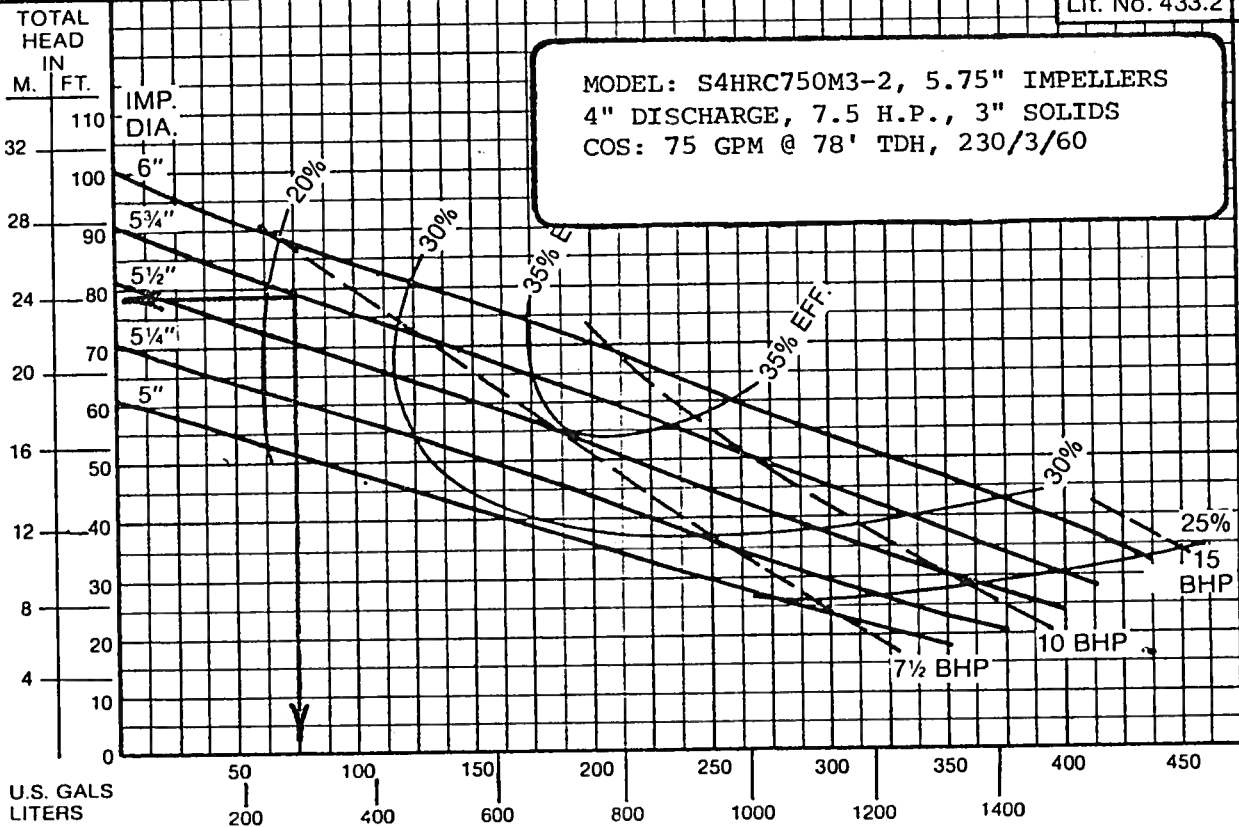

AMX434-178/4D/C

| Impeller | | | | | |
|---|-----------------------------|--|--------------------------|---------------------------|-----------------------------------|
| Impeller type: Single channel impeller | Solid size 3 inch | Ø: | Max. Ø: 8 1/8" | Min. Ø: 5 9/16" | Sel. Ø: 7" |
| Operating data | | | | | |
| Speed: 1750 rpm | Frequency: 60 Hz | Duty point: Q = 105 US g.p.m. H = 31 ft | | Suction port: | Discharge port: 4" ANSI |
| Power data referred to: Water, pure [100%]; 68°F; 62.322lb/ft³; 1.0818E-5ft²/s | | | | Testnorm: | ISO 9906 |

Curve number:

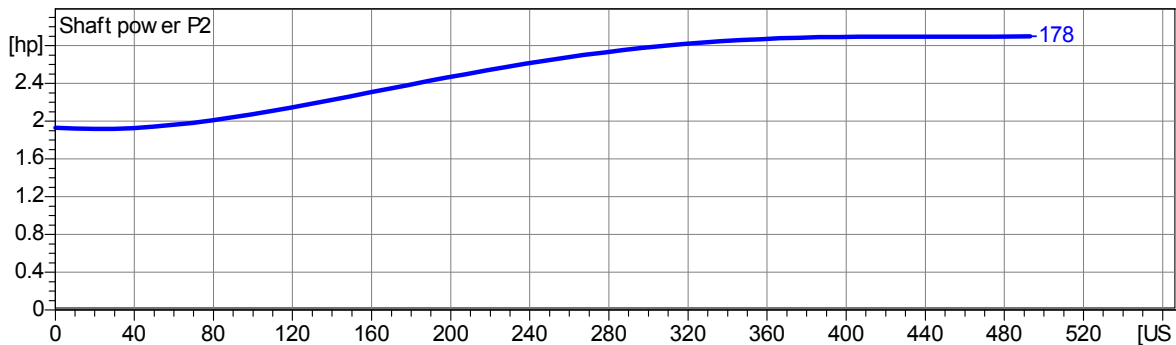
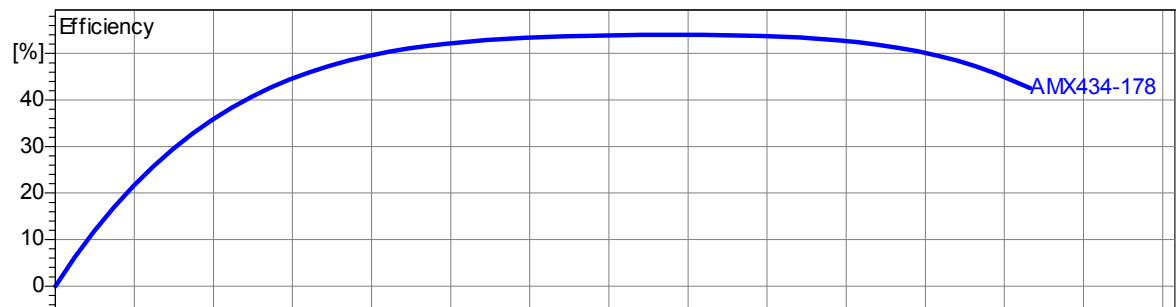
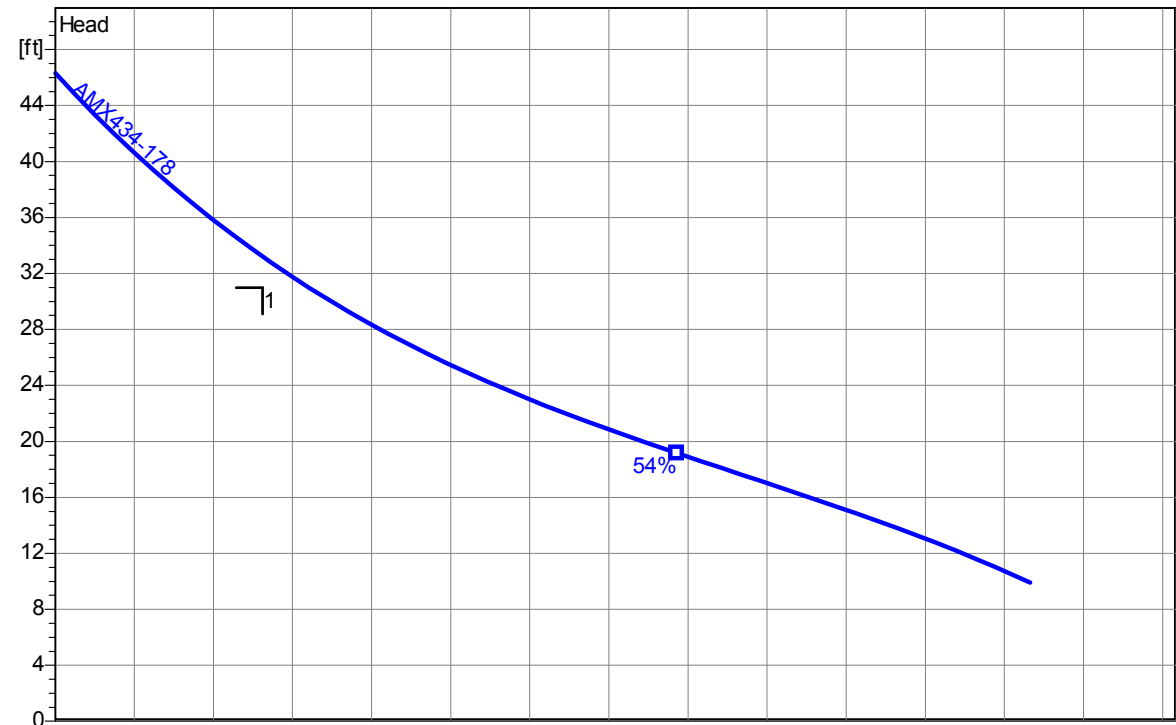

2.0 - 11.01.2008 (Build 137) Homa Pump Technology Inc. (internal)

| | | | | |
|--|--------------------------------------|----------------------------------|-------------------|--------------------------|
| Project Man. Cty IFB #09-0897-OV | Project no.: Glenn Lakes 2 | Created by: nyackerman | Page: 2 | Date: 4/4/2009 |
|--|--------------------------------------|----------------------------------|-------------------|--------------------------|

Performance Curve

H4H/H4HX

RTU 110

RPM: 1750 Discharge: 4" Solids: 3" Spherical

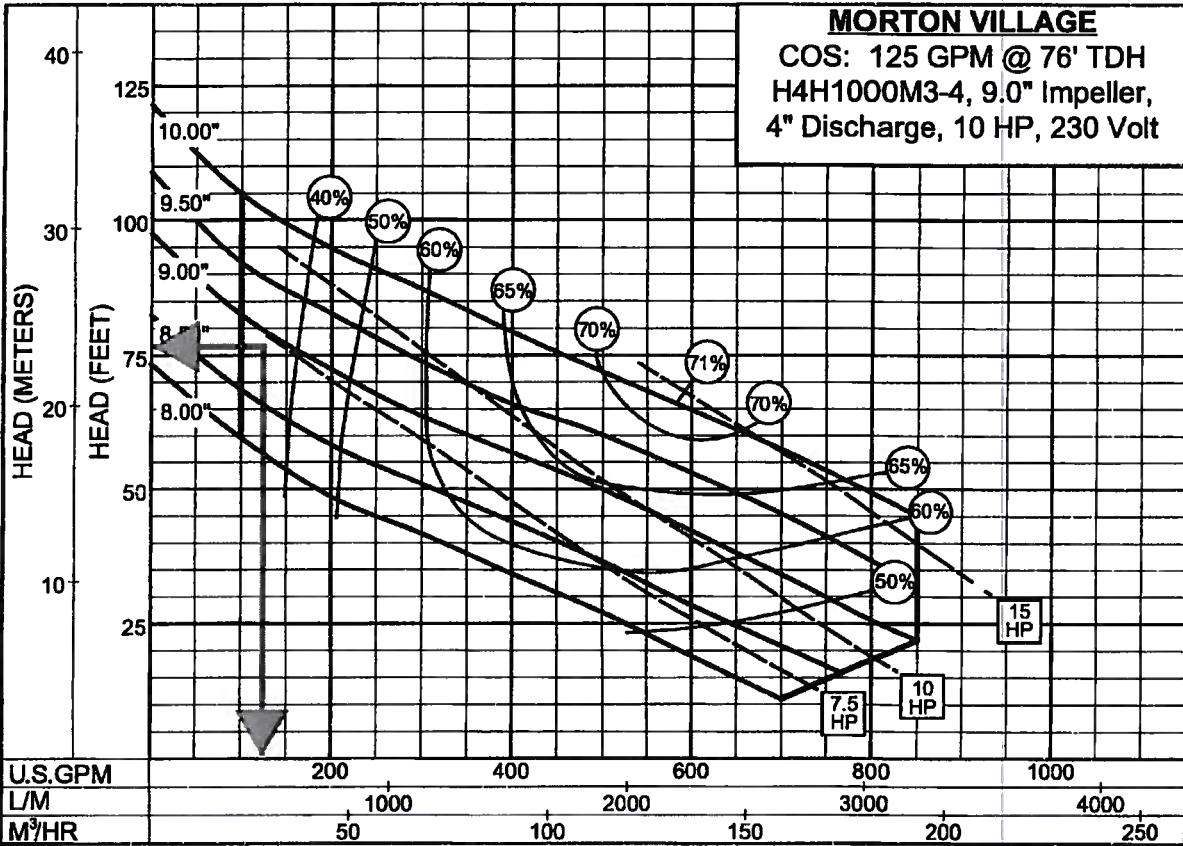

The curves reflect maximum performance characteristics without exceeding full load (Nameplate) horsepower. All pumps have a service factor of 1.2. Operation is recommended in the bounded area with operational point within the curve limit. Performance curves are based on actual tests with clear water at 70° F. and 1280 feet site elevation.

Conditions of Service:

GPM: 125 TDH: 76'

Victoria Square East III

Crane/Barnes

Selection list: ---

Catalog: Crane Barnes 60Hz vers 8

Search Criteria:

Flow: 150 US gpm
 Head: 20 ft
 Tolerance: --- % of head

Pump: 4SE28*4L
 Type: 1D4NONCLOG
 Synch speed: 1800 rpm
 Speed: 1750 rpm
 Dia: 5.75 in
 Curve no.:

Fluid: Water

Temperature: 60 °F
 SG: 1
 Viscosity: 1.105 cP
 Vapor pressure: 0.2563 psi a
 Atm pressure: 14.7 psi a

Specific Speeds

Ns: --- Nss: ---

Dimensions:

Suction: --- in Discharge: 4 in

NPSHa: --- ft

Pump Limits:

Temperature: --- °F
 Pressure: --- psi g
 Sphere size: 3 in
 Power: --- bhp

Advanced Criteria:

Preferred Operating Area: ---
 Secondary Operating Point: ---
 Max temperature: --- °F
 Max suction pressure: --- psi g
 Max sphere size: --- in
 Max power: --- bhp
 Max suction specific speed: --- (Nss)
 Min trim: --- % of max diameter
 Min head rise: --- % to shutoff

Motor: Consult vendor

Curve Corrections: none

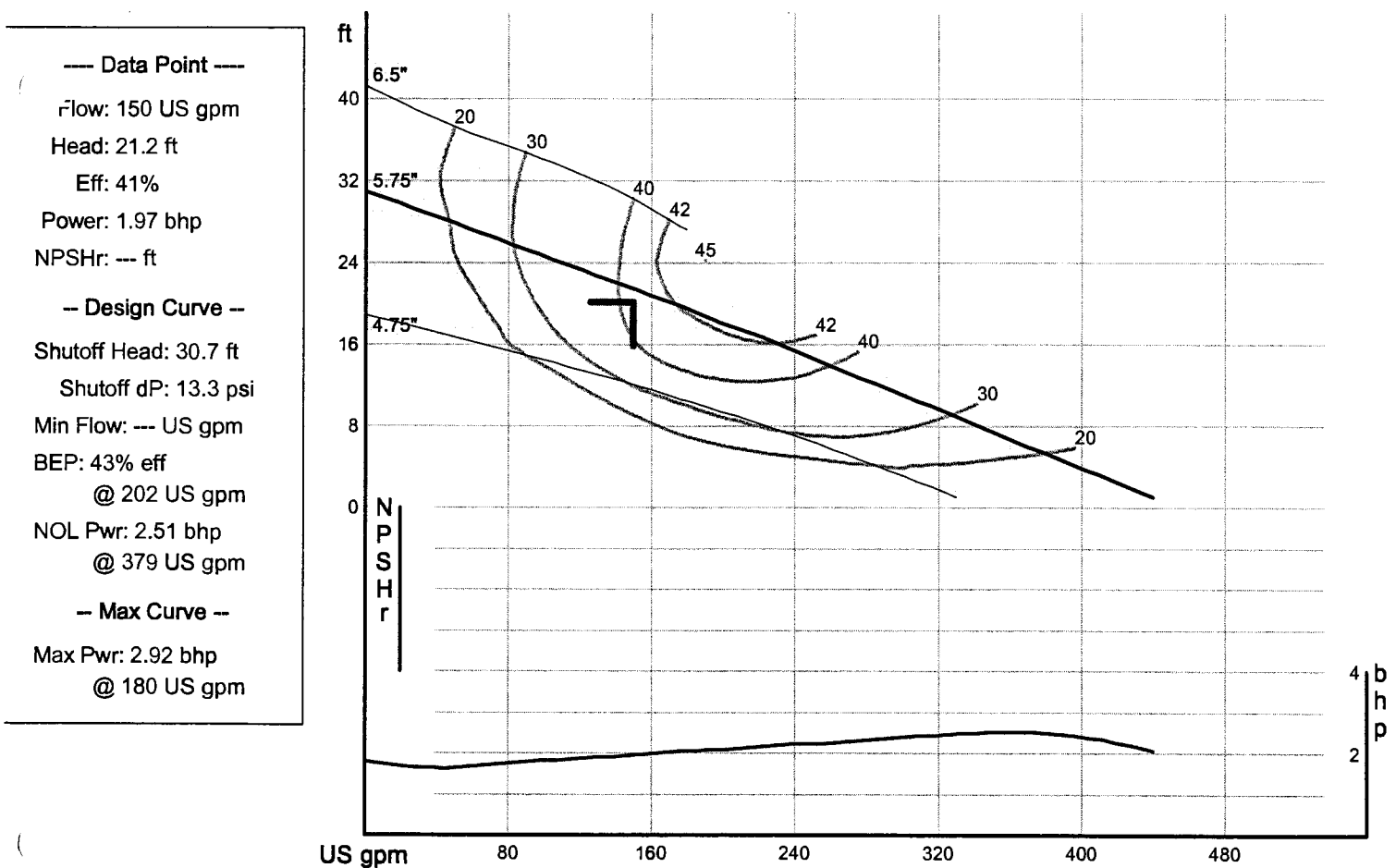

Pump note: Temp. 104°F (40°C) Continuous.

Vict. Sq. W.

DFG ##S

S4N 75M3-4
6.25" Imp.

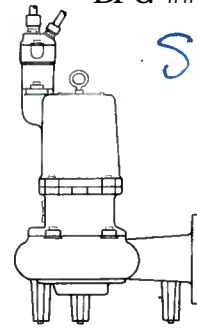

Performance Curve

S4N/S4NX

RPM: **1150** Discharge: **4"** Solids: **3"**

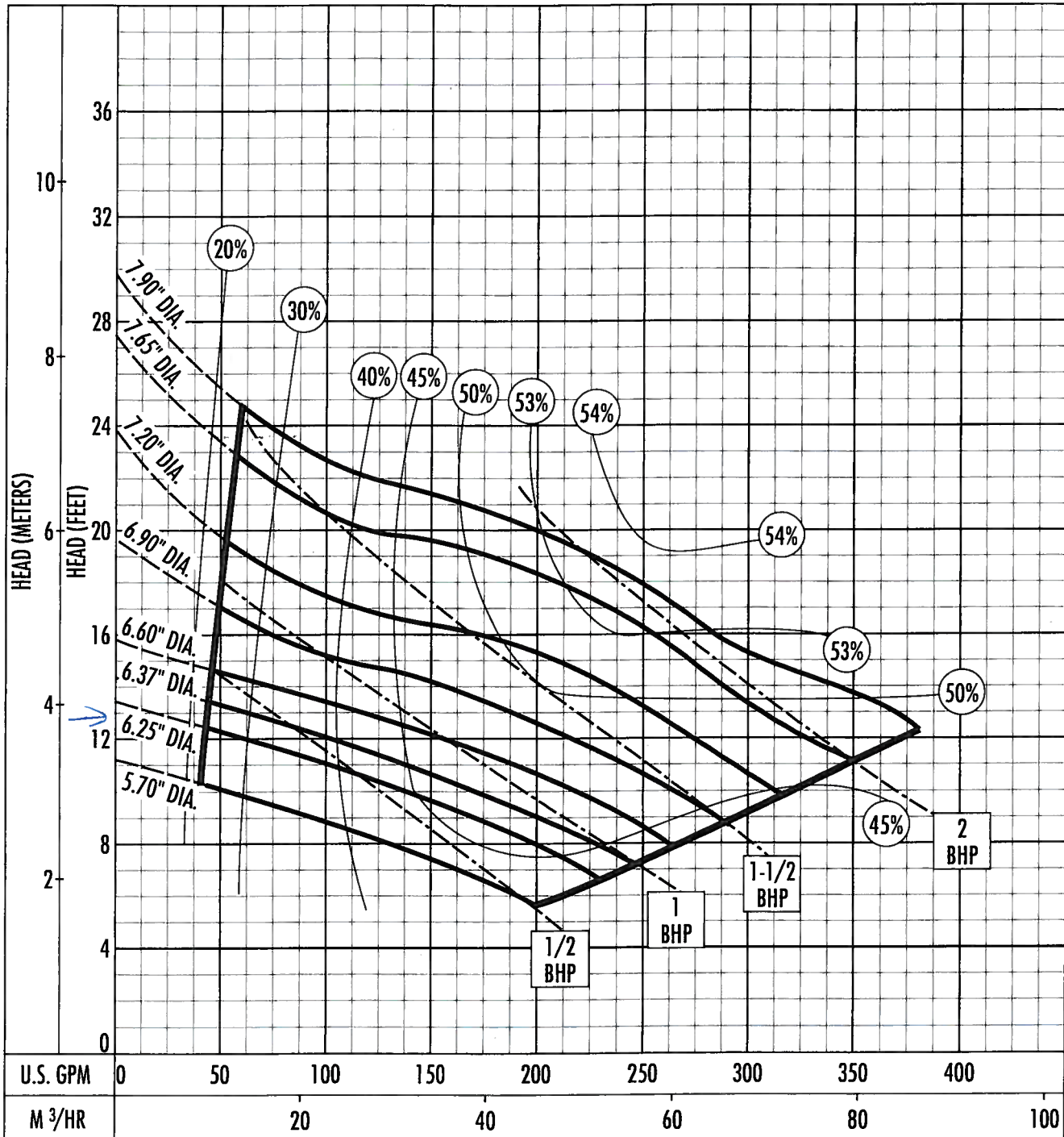

The curves reflect maximum performance characteristics without exceeding full load (Nameplate) horsepower. All pumps have a service factor of 1.2. Operation is recommended in the bounded area with operational point within the curve limit. Performance curves are based on actual tests with clear water at 70° F. and 1280 feet site elevation.

Conditions of Service:

HYDROMATIC™ PUMPS

GPM: _____ TDH: _____

AURORA PUMP **GS**
 A UNIT OF GENERAL SIGNAL



Performance Curve

AMX434-142/2.5D

College Plaza (113)

Impeller

| | | | | | |
|---|-----------------------------|----|--------------------------|---------------------------|---------------------------|
| Impeller type: Single vane impeller | Solid size 3 1/8" | Ø: | Max. Ø: 8 1/8" | Min. Ø: 5 9/16" | Sel. Ø: 5 9/16" |
|---|-----------------------------|----|--------------------------|---------------------------|---------------------------|

Operating data

| | | | | |
|---------------------------|----------------------------|--|---------------------------------|-----------------------------------|
| Speed: 1700 rpm | Frequency: 60 Hz | Duty point: Q = 100 US g.p.m. H = 15 ft | Suction port: 4" ANSI | Discharge port: 4" ANSI |
|---------------------------|----------------------------|--|---------------------------------|-----------------------------------|

Power data referred to: Water, pure [100%] ; 68°F; 62.322lb/ft³; 1.0818E-5ft²/s Testnorm: **ISO 9906**

Curve number:

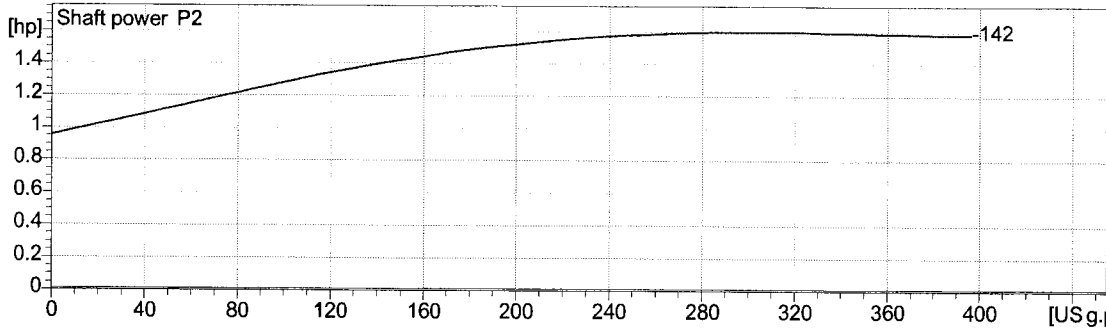
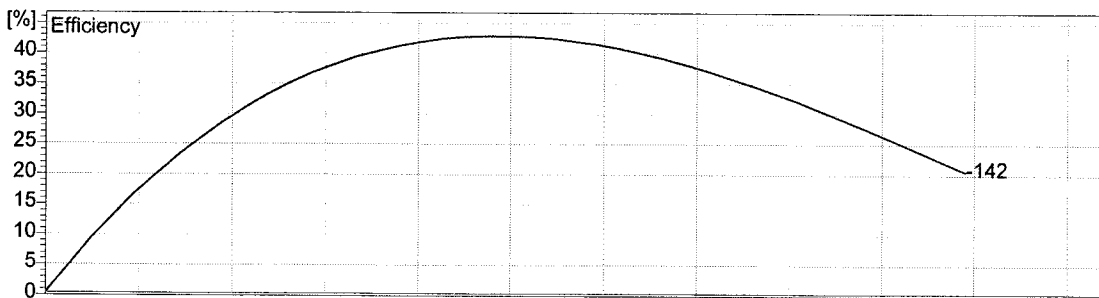
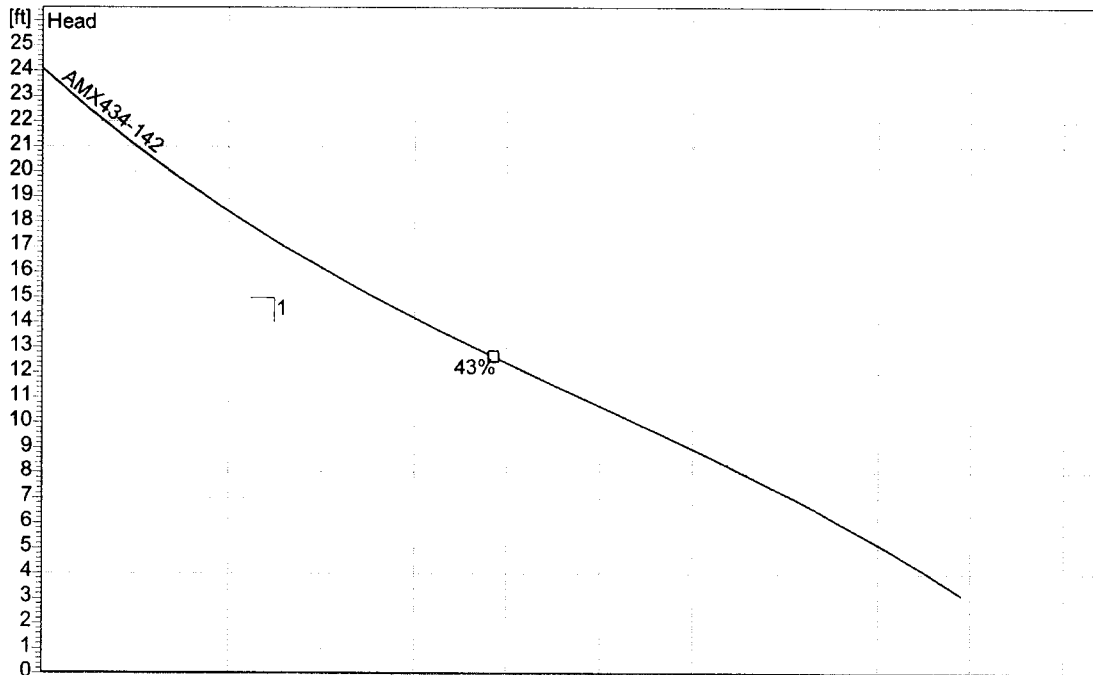

| | | | | |
|-------------------------------|---------------------------------------|---------------------------------|-------------------|----------------------------|
| Project Manatee Cty | Project no.: Item Number 10 | Created by: nackerman | Page: 2 | Date: 2005-09-14 |
|-------------------------------|---------------------------------------|---------------------------------|-------------------|----------------------------|



Performance Curve

AMX434-250/13P

Wildwood Spgs. 1 (114)

Impeller

| | | | | | |
|---|-----------------------------|----|----------------------------|--------------------------|----------------------------|
| Impeller type: Single vane impeller | Solid size 3 1/8" | Ø: | Max. Ø: 9 13/16" | Min. Ø: 8 1/8" | Sel. Ø: 9 13/16" |
|---|-----------------------------|----|----------------------------|--------------------------|----------------------------|

Operating data

| | | | | |
|--|----------------------------|--|---------------------------------|-----------------------------------|
| Speed: 1700 rpm | Frequency: 60 Hz | Duty point: Q = 325 US g.p.m. H = 62.5 ft | Suction port: 4" ANSI | Discharge port: 4" ANSI |
| Power data referred to: Water, pure [100%] ; 68°F; 62.322lb/ft³; 1.0818E-5ft²/s | | | Testnorm: ISO 9906 | |

Curve number:

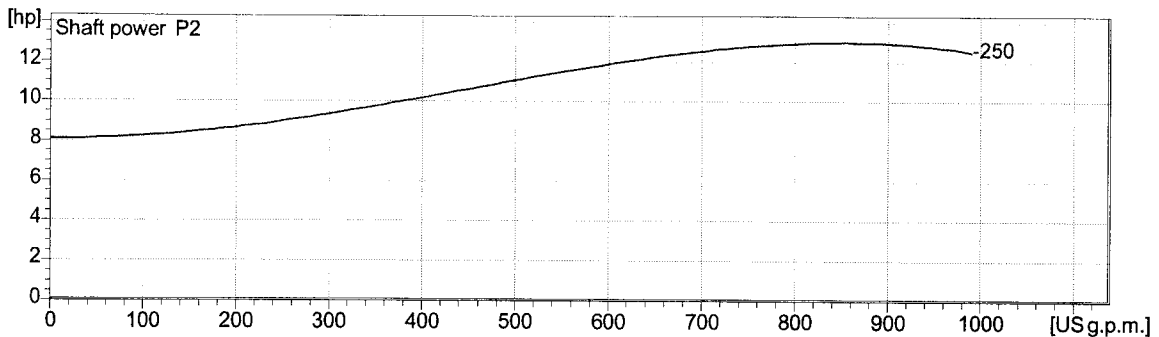
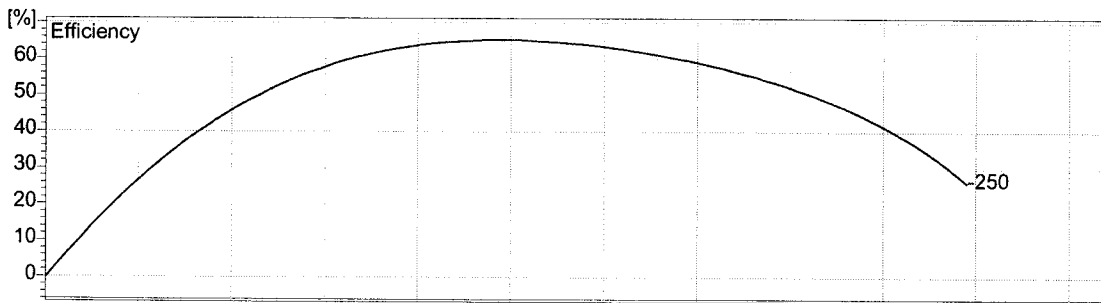
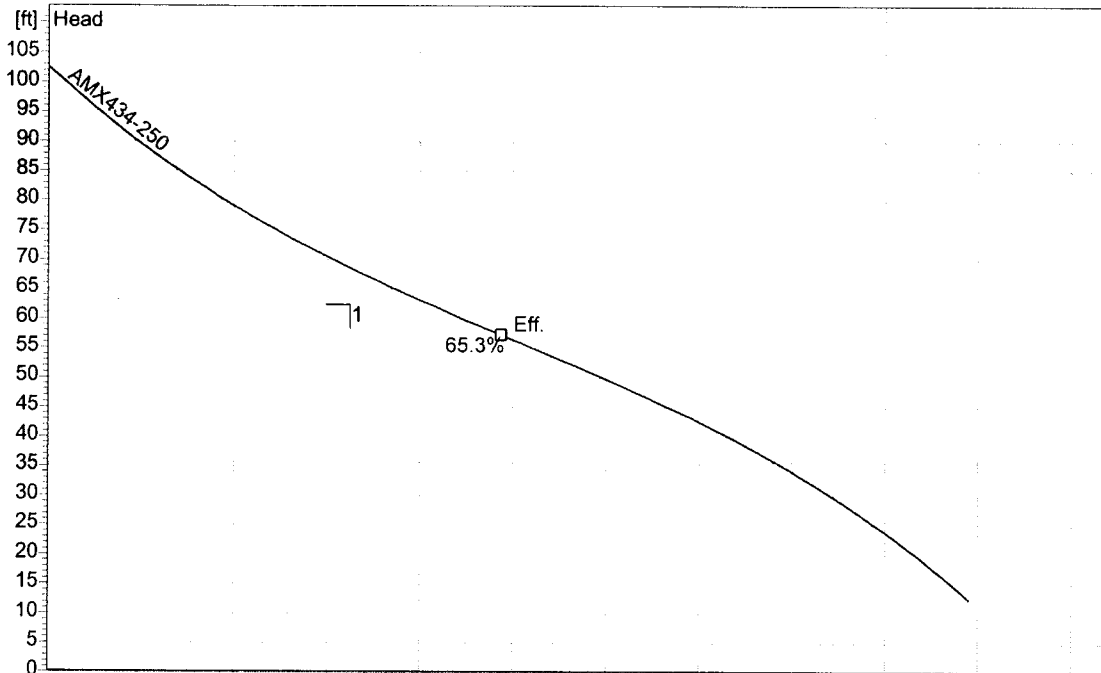

2.0 - 29.09.2004 (Build 60)

| | | | | |
|-------------------------------|---------------------------------------|---------------------------------|-------------------|----------------------------|
| Project Manatee Cty | Project no.: Item Number 30 | Created by: nackerman | Page: 2 | Date: 2005-09-14 |
|-------------------------------|---------------------------------------|---------------------------------|-------------------|----------------------------|

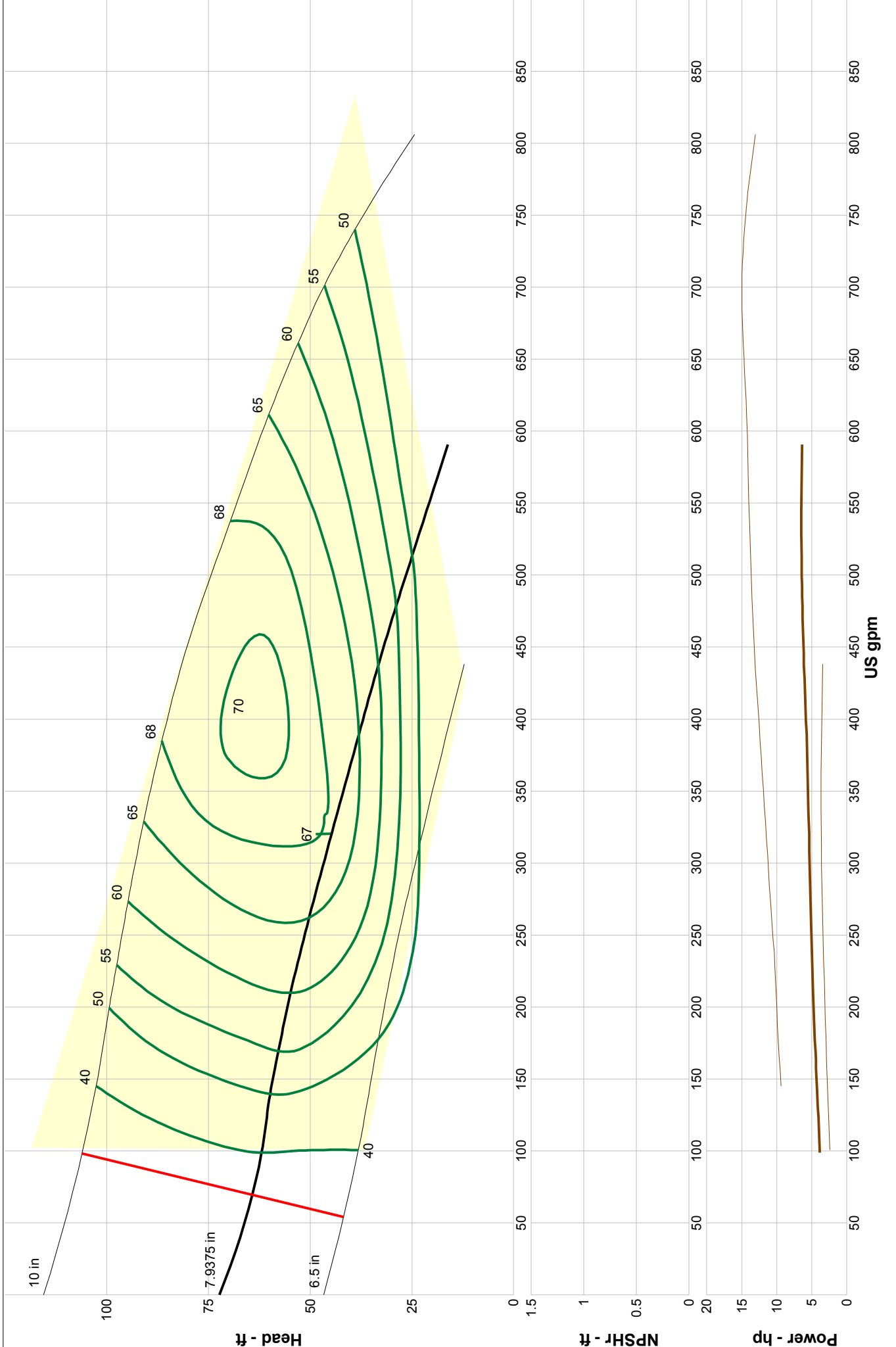

Company: Manatee County Utilities
 Name: Wildwood Springs 2 - RTU 115
 4/9/2012

HYDROMATIC
 Catalog: Non-Clog Pumps 60Hz, Vers Feb 2006
 NCLOG-4 - 1800

Size: S4P/S4PX
 Speed: 1750 rpm
 Dia: 7.9375 in
 Curve: S4P1750



Performance Curve – S4M/S4MX

RPM: **1750** DISCHARGE: **4"** SOLIDS: **3"**

Lift Station 116

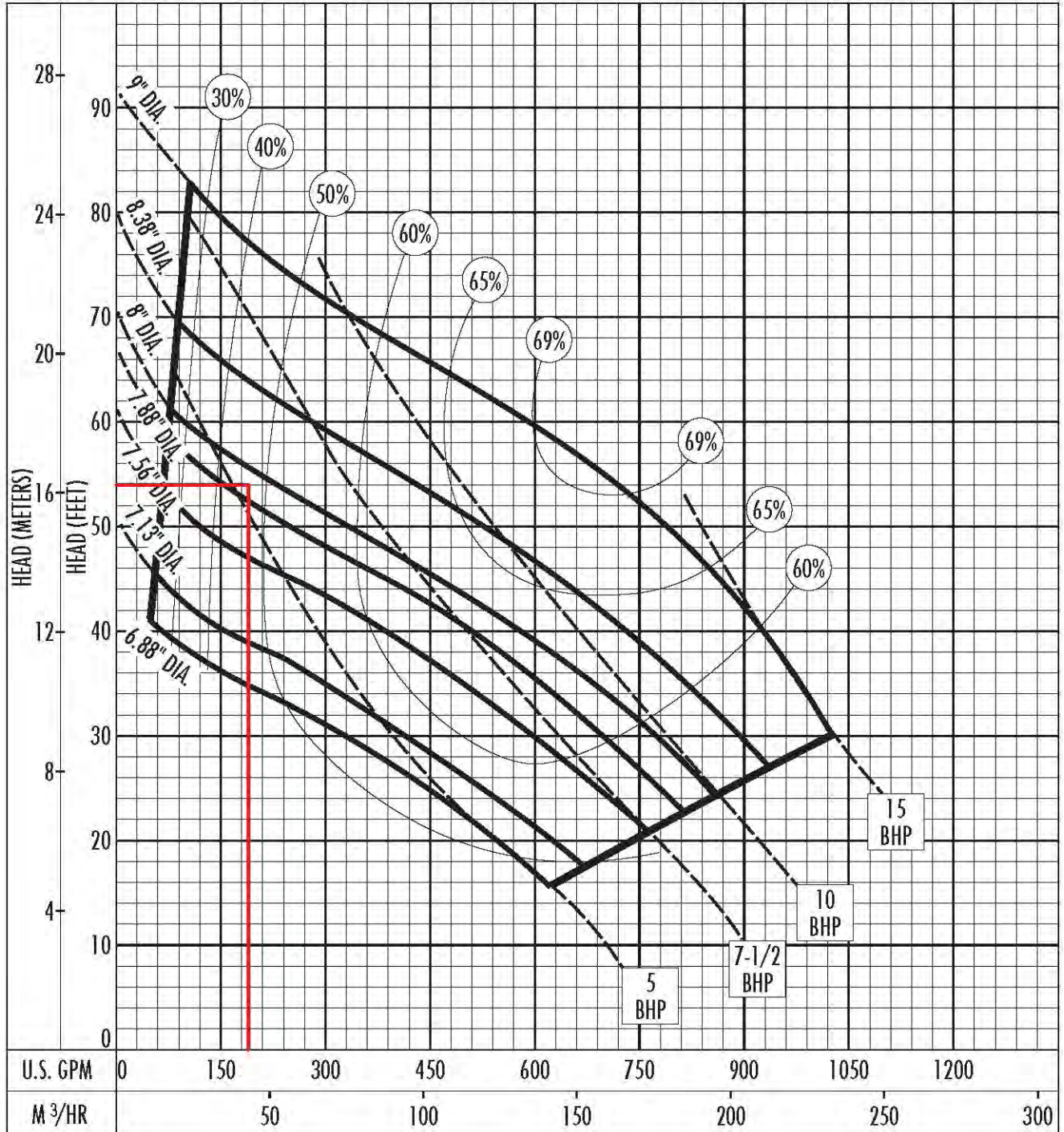

The curves reflect maximum performance characteristics without exceeding full load (Nameplate) horsepower. All pumps have a service factor of 1.2. Operation is recommended in the bounded area with operational point within the curve limit. Performance curves are based on actual tests with clear water at 70° F. and 1280 feet site elevation.

Conditions of Service:

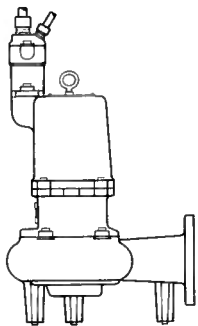

M.C.U.O.D. RTU #117

7.20" Impeller

Performance Curve

S4N/S4NX

RPM: **1750** Discharge: **4"** Solids: **3"**

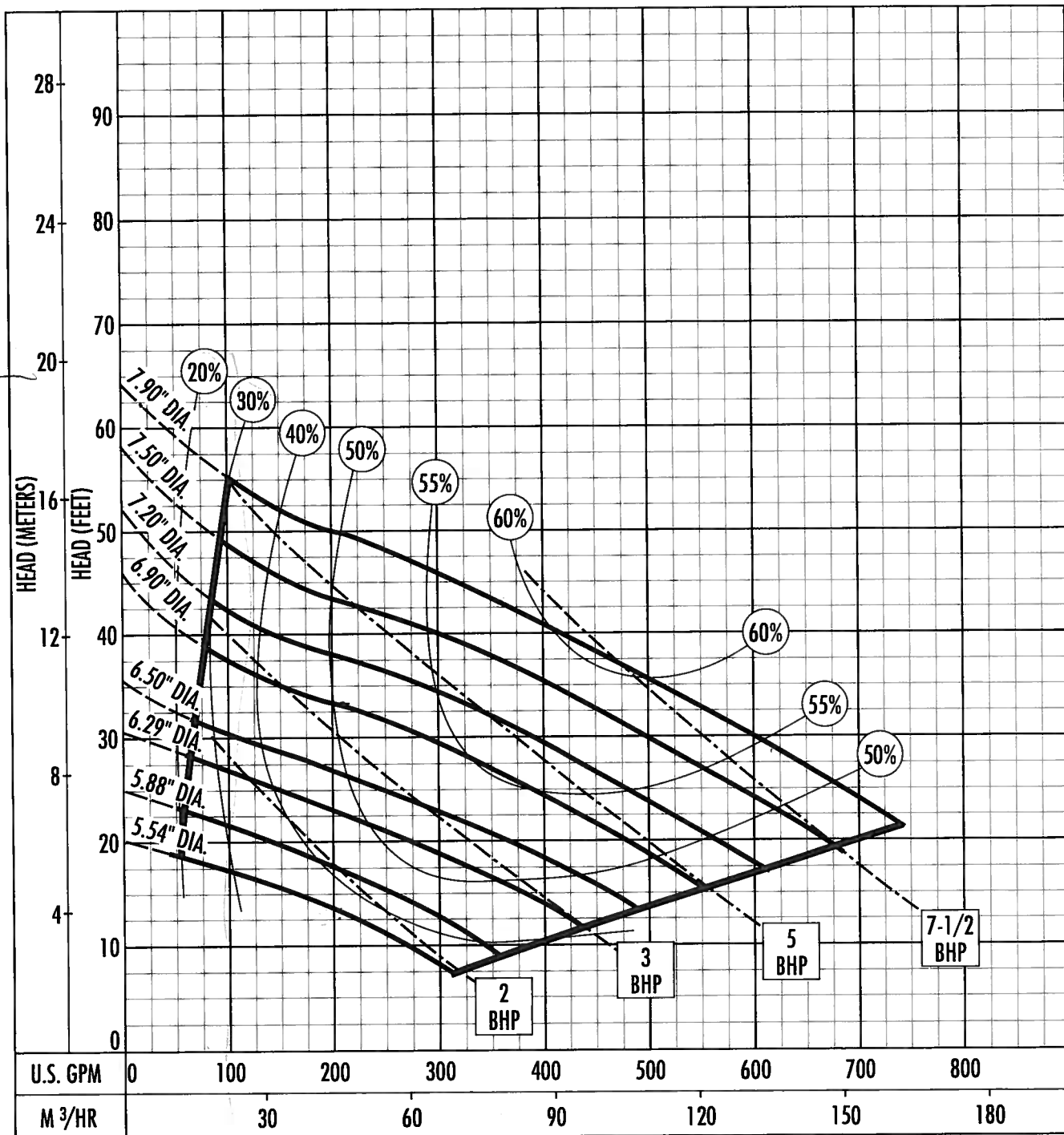

The curves reflect maximum performance characteristics without exceeding full load (Nameplate) horsepower. All pumps have a service factor of 1.2. Operation is recommended in the bounded area with operational point within the curve limit. Performance curves are based on actual tests with clear water at 70° F. and 1280 feet site elevation.

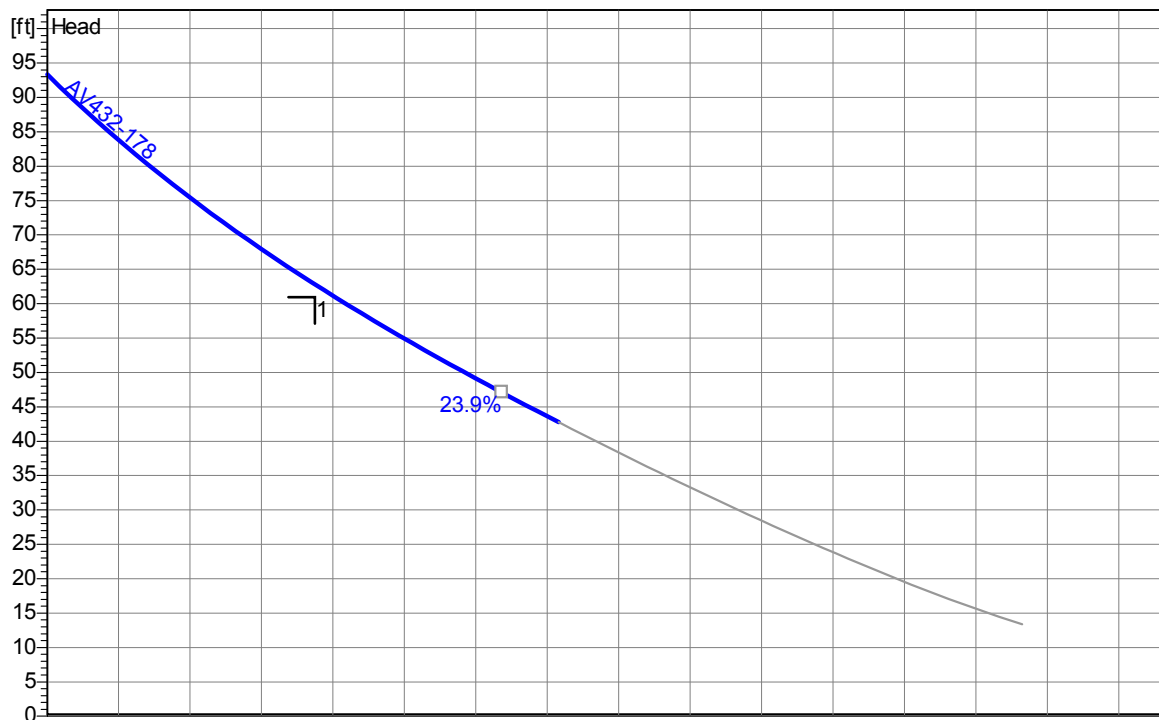
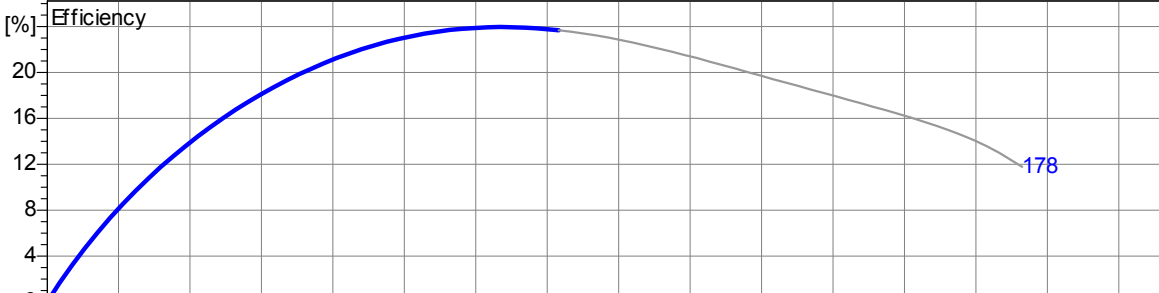
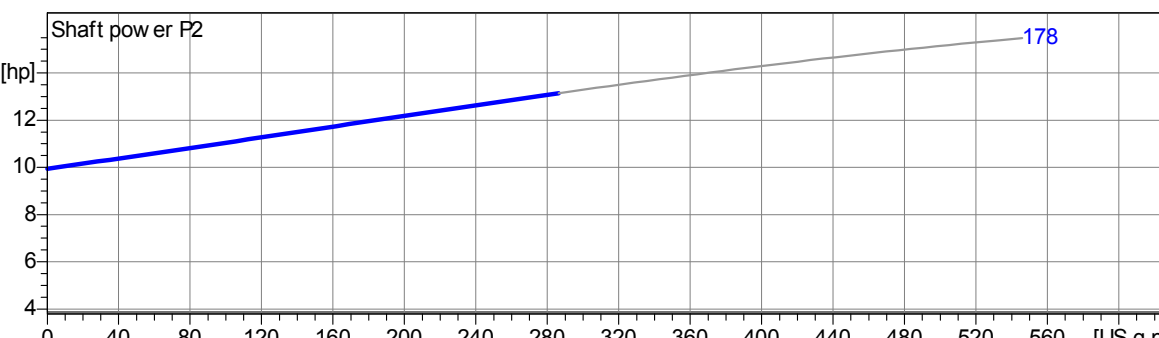
| Impeller | | | | |
|---|--------------------------------------|--|--|--|
| Impeller type: Vortex impeller | Solid size 3 inch | Ø: | Max. Ø: 7¹/₁₆" | Min. Ø: 6⁵/₁₆" |
| | | | Sel. Ø: 7" | |
| Operating data | | | | |
| Speed: 3450 rpm | Frequency: 60 Hz | Duty point: Q = 150 US g.p.m. H = 61 ft | | Suction port: 4" ANSI |
| Power data referred to: Water, pure [100%]; 68°F; 62.322lb/ft ³ ; 1.0818E-5ft ² /s | | | Testnorm: | ISO 9906 |
| Curve number: | | | | |
|  | | | | |
|  | | | | |
|  | | | | |
| Project Man. Cty IFB #09-0897-OV | Project no.: Doraye Villas | | Created by: nyackerman | Page: 2 Date: 4/1/2009 |

AMX444-260/20P/C

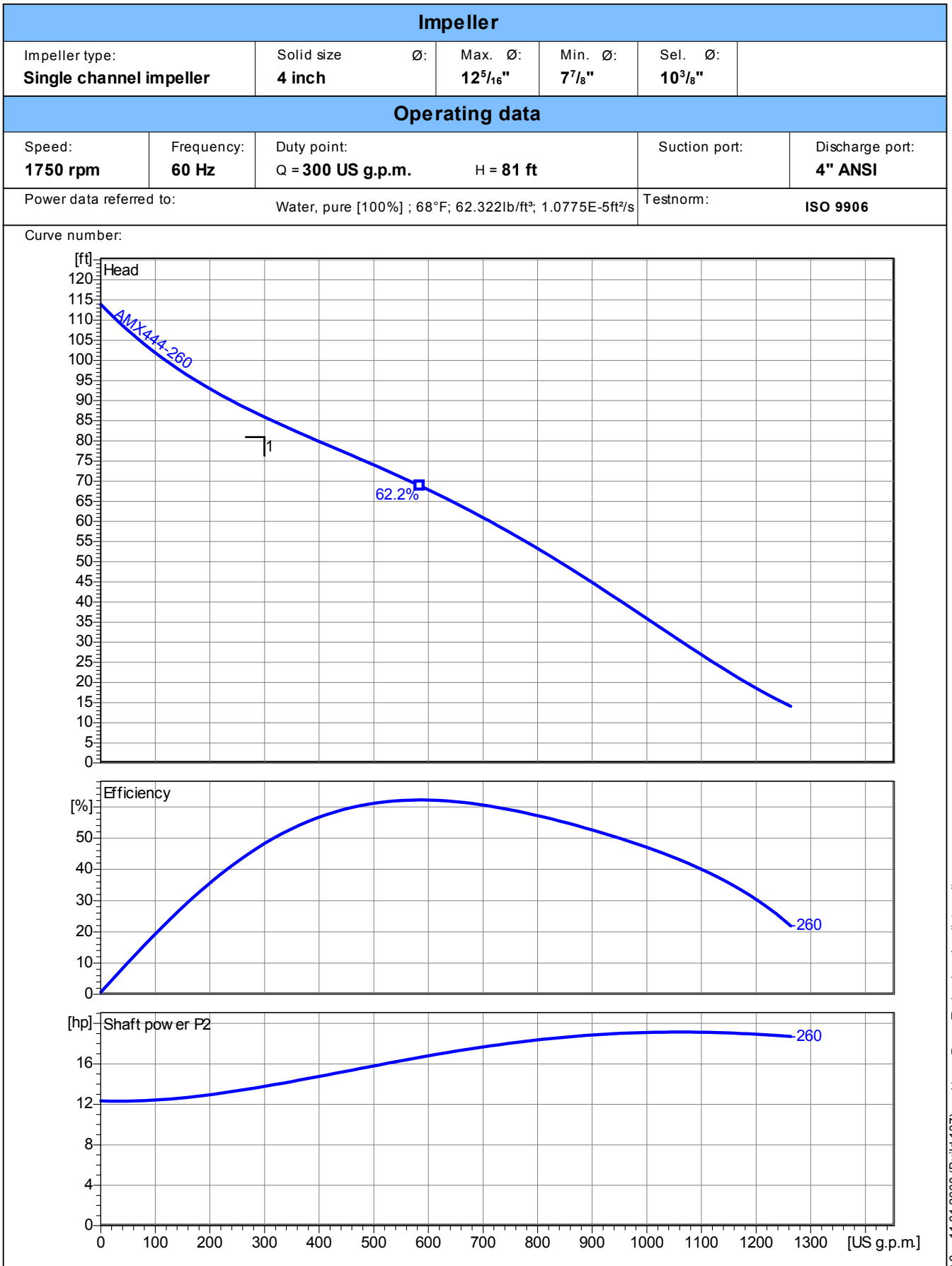

2.0 - 11.01.2008 (Build 137) Homa Pump Technology Inc. (internal)

| | | | | |
|--|--------------------------------------|----------------------------------|-------------------|--------------------------|
| Project Man. Cty IFB #09-0897-OV | Project no.: Glenn Lakes 1 | Created by: nyackerman | Page: 2 | Date: 4/4/2009 |
|--|--------------------------------------|----------------------------------|-------------------|--------------------------|

CP 3102 MT 3~ 434
Duty Analysis

Lift Station 120

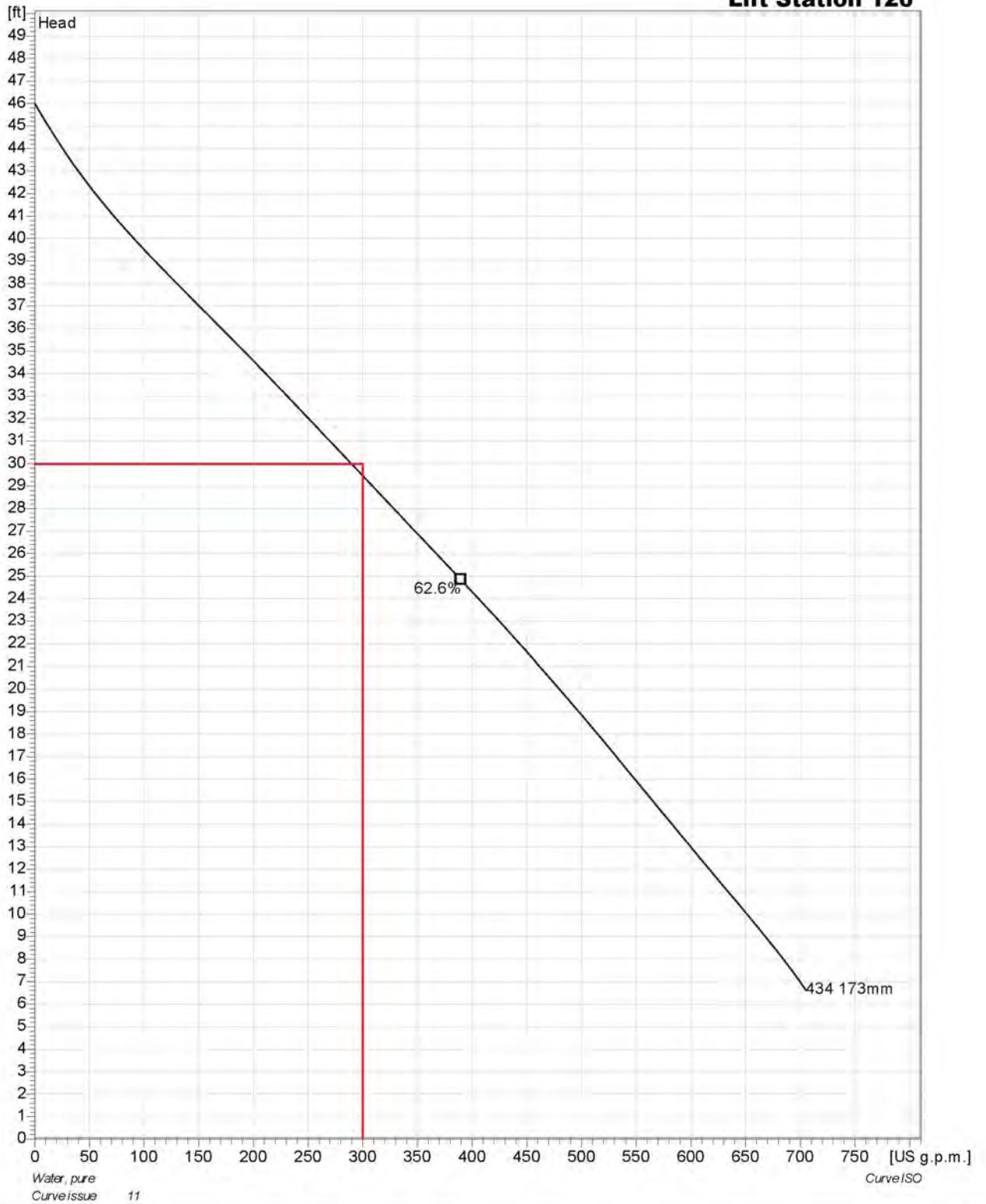

| | | | | |
|---------|------------|----------------------|--------------------------|-------------|
| Project | Project ID | GPM: 300 TDH: 30' | Created on 2015-07-08 | Last update |
|---------|------------|----------------------|--------------------------|-------------|

Coral Shores East 3 **121**

Crane/Barnes

Selection list: ---

Catalog: Crane Barnes 60Hz vers 8

Search Criteria:

Flow: 100 US gpm
 Head: 20 ft
 Tolerance: --- % of head

Pump: 4SE28*4L

Type: 1D4NONCLOG
 Synch speed: 1800 rpm
 Speed: 1750 rpm
 Dia: 5.5 in
 Curve no.:

Fluid: Water

Temperature: 60 °F
 SG: 1
 Viscosity: 1.105 cP
 Vapor pressure: 0.2563 psi a
 Atm pressure: 14.7 psi a

Specific Speeds

Ns: --- Nss: ---

Dimensions:

Suction: --- in Discharge: 4 in

NPSHa: --- ft

Pump Limits:

Temperature: --- °F
 Pressure: --- psi g
 Sphere size: 3 in
 Power: --- bhp

Advanced Criteria:

Preferred Operating Area: ---
 Secondary Operating Point: ---
 Max temperature: --- °F
 Max suction pressure: --- psi g
 Max sphere size: --- in
 Max power: --- bhp
 Max suction specific speed: --- (Nss)
 Min trim: --- % of max diameter
 Min head rise: --- % to shutoff

Motor: Consult vendor

Curve Corrections: none

--- Data Point ---

Flow: 100 US gpm
 Head: 21.3 ft
 Eff: 32%
 Power: 1.65 bhp
 NPSHr: --- ft

-- Design Curve --

Shutoff Head: 27.5 ft
 Shutoff dP: 11.9 psi
 Min Flow: --- US gpm
 BEP: 41% eff
 @ 190 US gpm

NOL Pwr: 2.12 bhp
 @ 354 US gpm

-- Max Curve --

Max Pwr: 2.92 bhp
 @ 180 US gpm

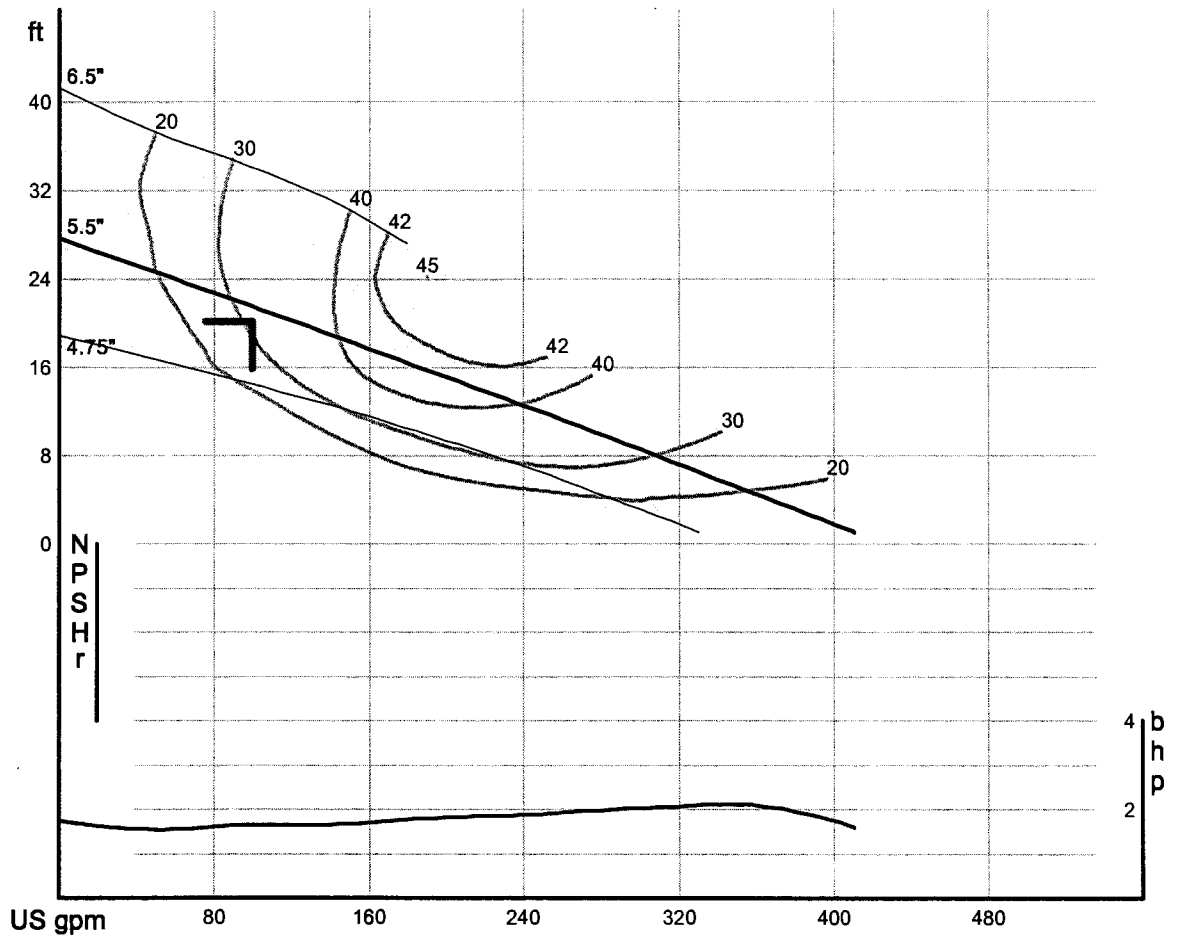

Pump note: Temp. 104°F (40°C) Continuous.

Series 4SE-L

Performance Curve

2.8, 3.7 & 5.0HP, 1750RPM, 60Hz

BARNES®

www.cranepumps.com

4" Horizontal Discharge - Submersible Non-Clog Pumps

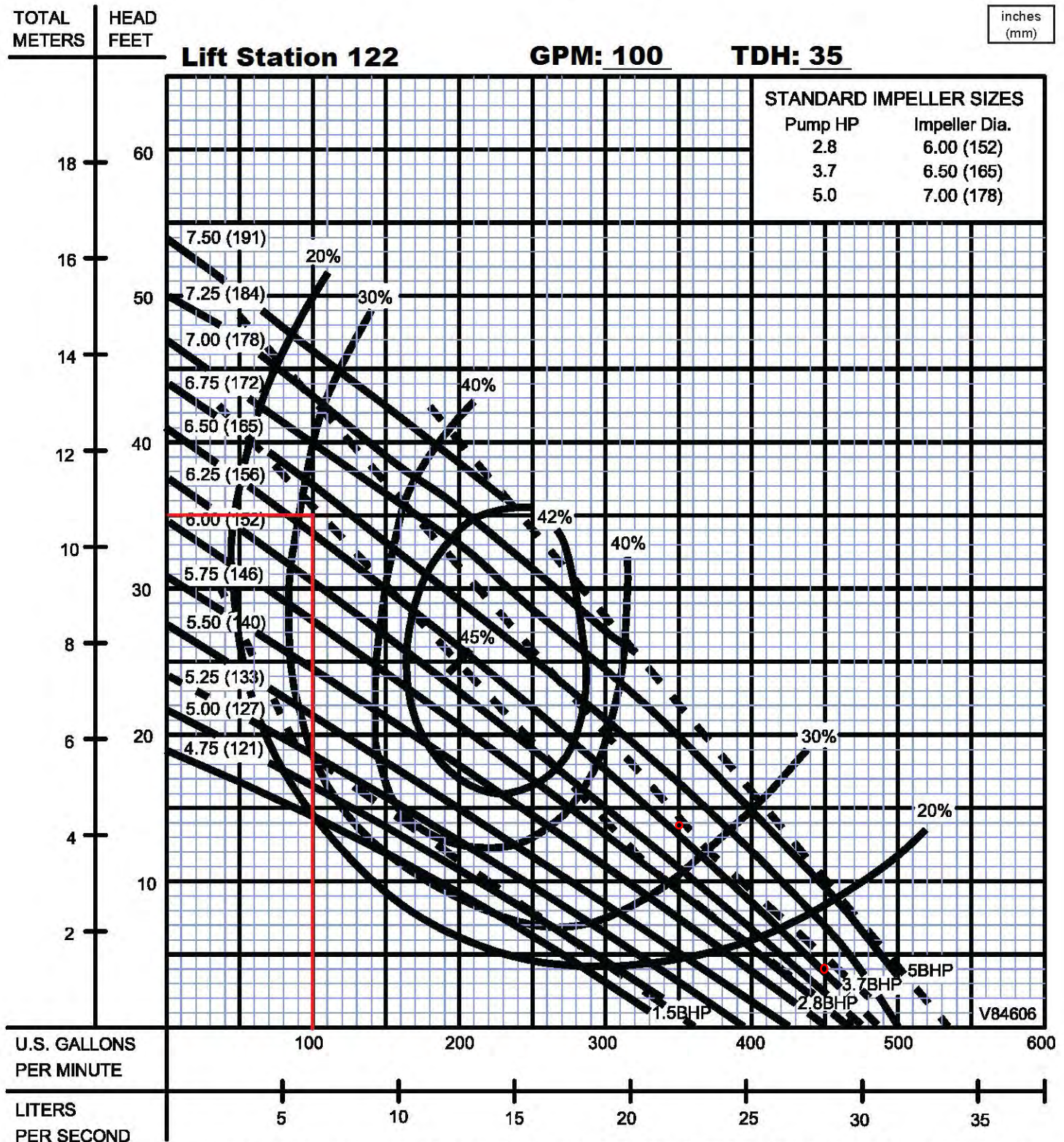

SECTION 1D
PAGE 10
DATE 1/05



PUMPS & SYSTEMS

A Crane Co. Company

USA: (937) 778-8947 • Canada: (905) 457-6223 • International: (937) 615-3598

Performance Curve – S4N/S4NX

RPM: **1750** DISCHARGE: **4"** SOLIDS: **3"**

Lift Station 123

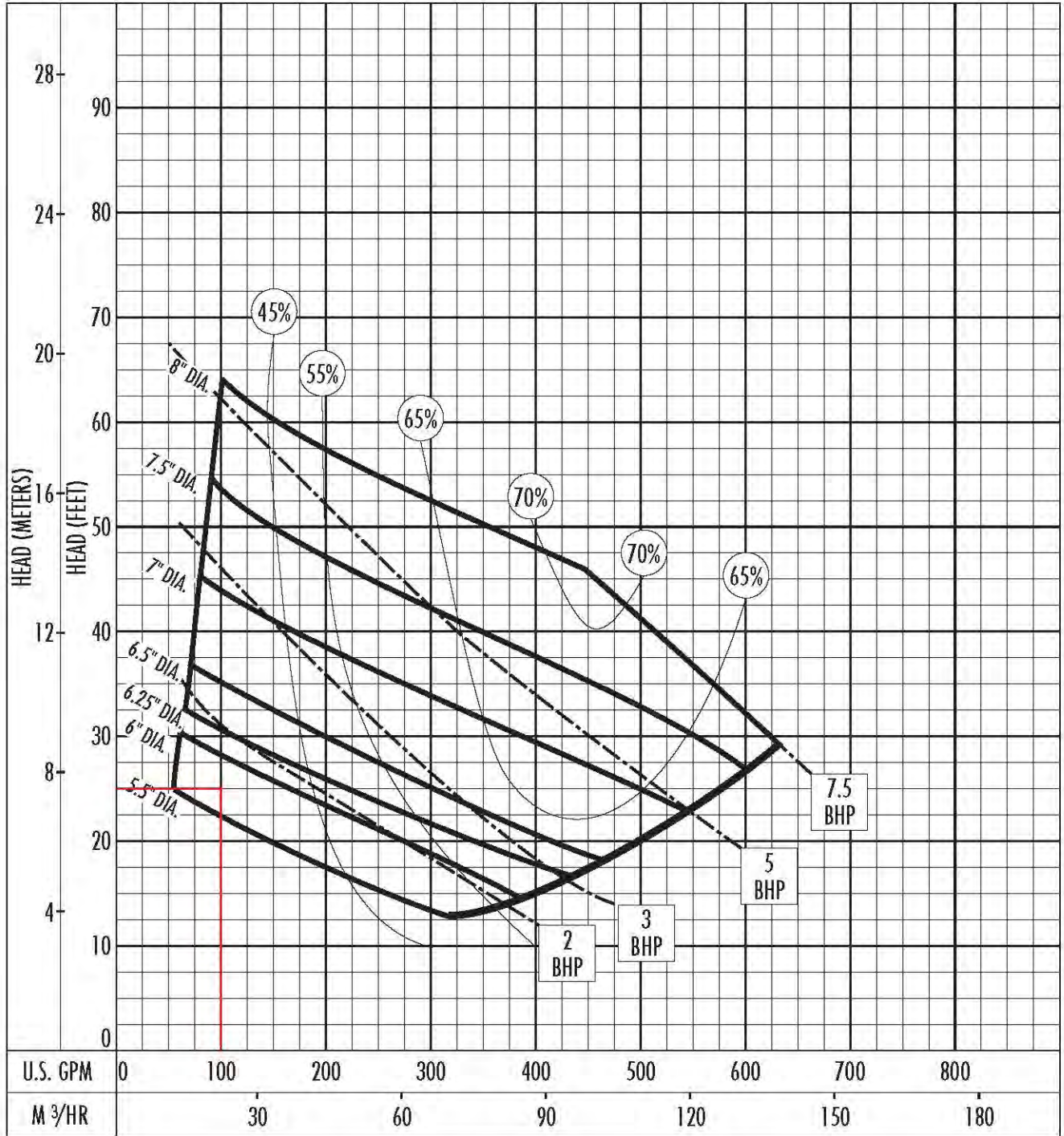

The curves reflect maximum performance characteristics without exceeding full load (Nameplate) horsepower. All pumps have a service factor of 1.2. Operation is recommended in the bounded area with operational point within the curve limit. Performance curves are based on actual tests with clear water at 70° F. and 1280 feet site elevation.

Conditions of Service:

AMX434-184/4D/C

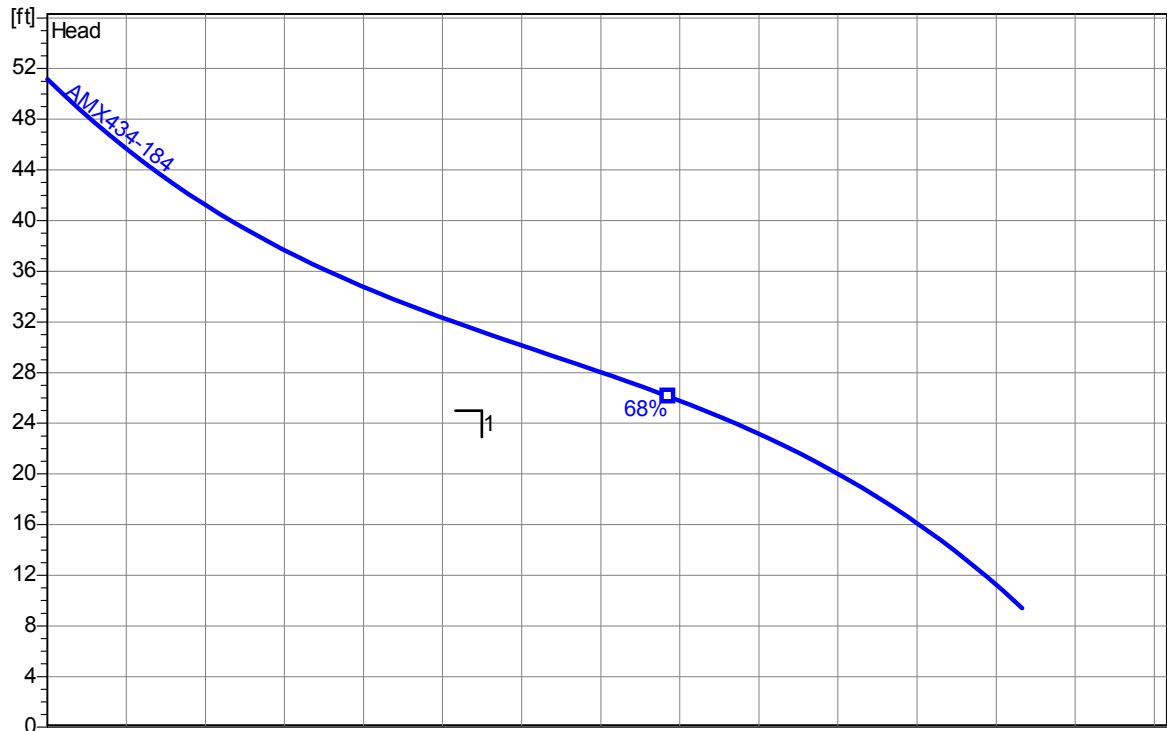
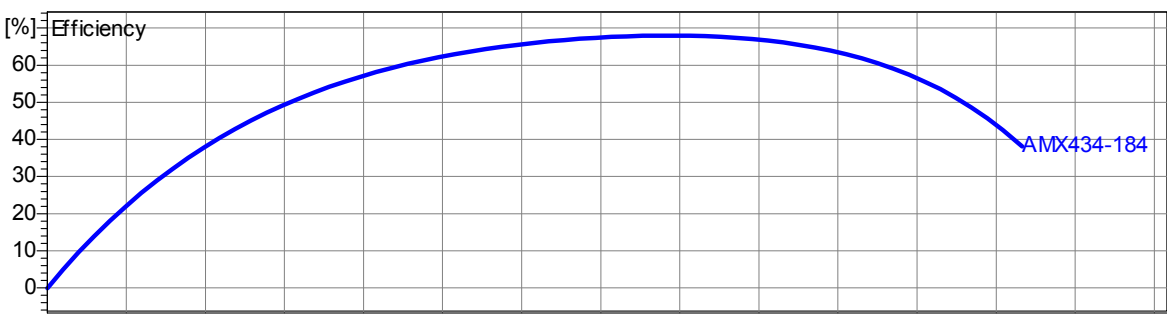
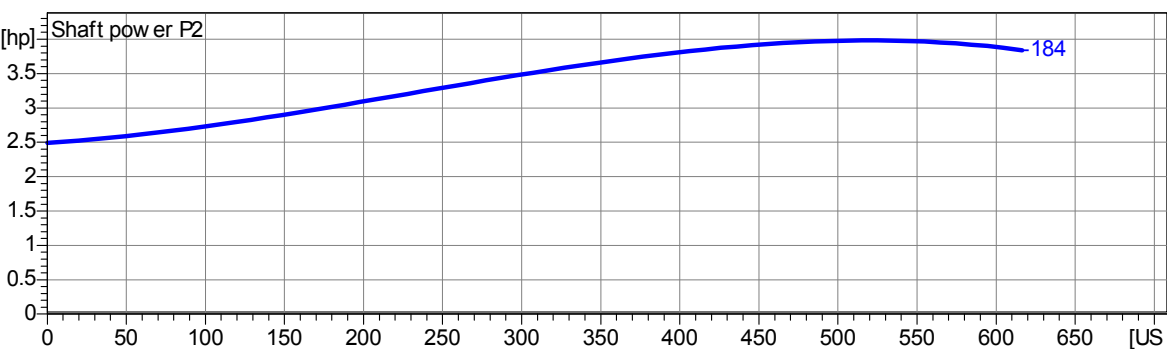
| Impeller | | | | | |
|--|----------------------------------|--|----------------------------------|---------------------------|-----------------------------------|
| Impeller type: Single channel impeller | Solid size 3 inch | Ø: | Max. Ø: 8 1/8" | Min. Ø: 5 9/16" | Sel. Ø: 7 1/4" |
| Operating data | | | | | |
| Speed: 1750 rpm | Frequency: 60 Hz | Duty point: Q = 275 US g.p.m. H = 25 ft | | Suction port: | Discharge port: 4" ANSI |
| Power data referred to: Water, pure [100%]; 68°F; 62.322lb/ft³; 1.0818E-5ft²/s | | | | Testnorm: | ISO 9906 |
| Curve number: | | | | | |
|  | | | | | |
|  | | | | | |
|  | | | | | |
| Project Man. Cty IFB #09-0897-OV | Project no.: LS # 1M-A | | Created by: nyackerman | Page: 2 | Date: 4/1/2009 |



Performance Curve

AMX434-184/3.5D

30-A

(125)

Impeller

| | | | | |
|---|--------------------------------|--------------------------|---------------------------|--------------------------|
| Impeller type: Single vane impeller | Solid size Ø: 3 1/8" | Max. Ø: 8 1/8" | Min. Ø: 5 9/16" | Sel. Ø: 7 1/4" |
|---|--------------------------------|--------------------------|---------------------------|--------------------------|

Operating data

| | | | | |
|---------------------------|----------------------------|--|---------------------------------|-----------------------------------|
| Speed: 1700 rpm | Frequency: 60 Hz | Duty point: Q = 392 US g.p.m. H = 23 ft | Suction port: 4" ANSI | Discharge port: 4" ANSI |
|---------------------------|----------------------------|--|---------------------------------|-----------------------------------|

Power data referred to: Water, pure [100%] ; 68°F; 62.322lb/ft³; 1.0818E-5ft²/s Testnorm: ISO 9906

Curve number:

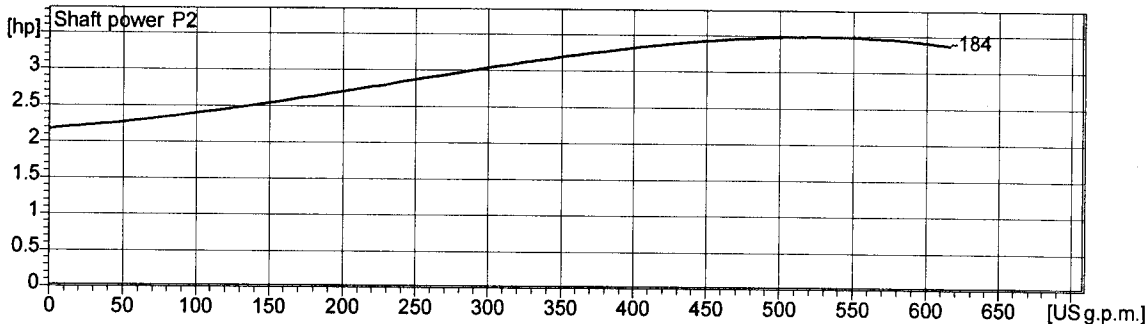
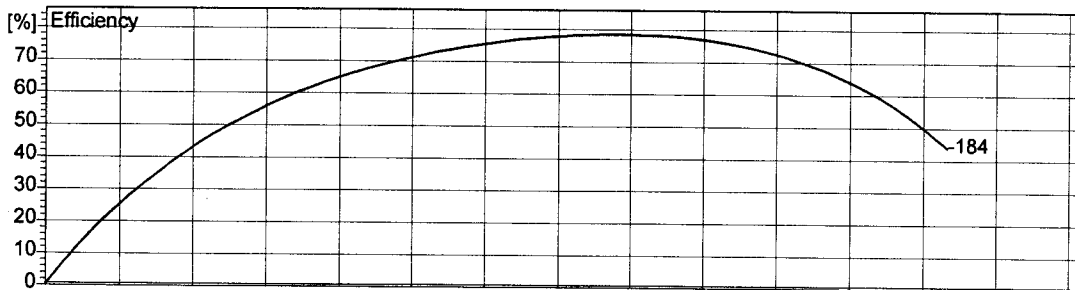
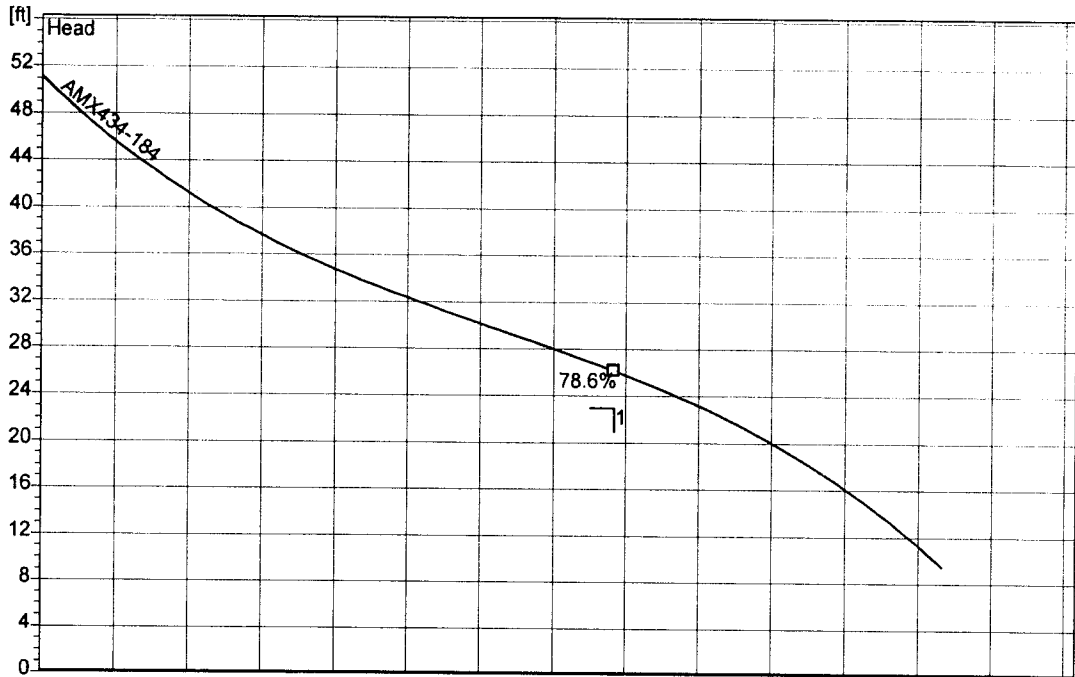

2.0 - 29.09.2004 (Build 60)

| | | | | |
|-------------------------------|--------------------------------------|---------------------------------|-------------------|----------------------------|
| Project Manatee Cty | Project no.: Item Number 5 | Created by: nackerman | Page: 2 | Date: 2005-09-14 |
|-------------------------------|--------------------------------------|---------------------------------|-------------------|----------------------------|

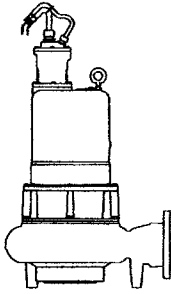

31-A RTU*126

Performance Curve

S6A/S6AX

RPM: **1750** Discharge: **6"** Solids: **3-3/4"**

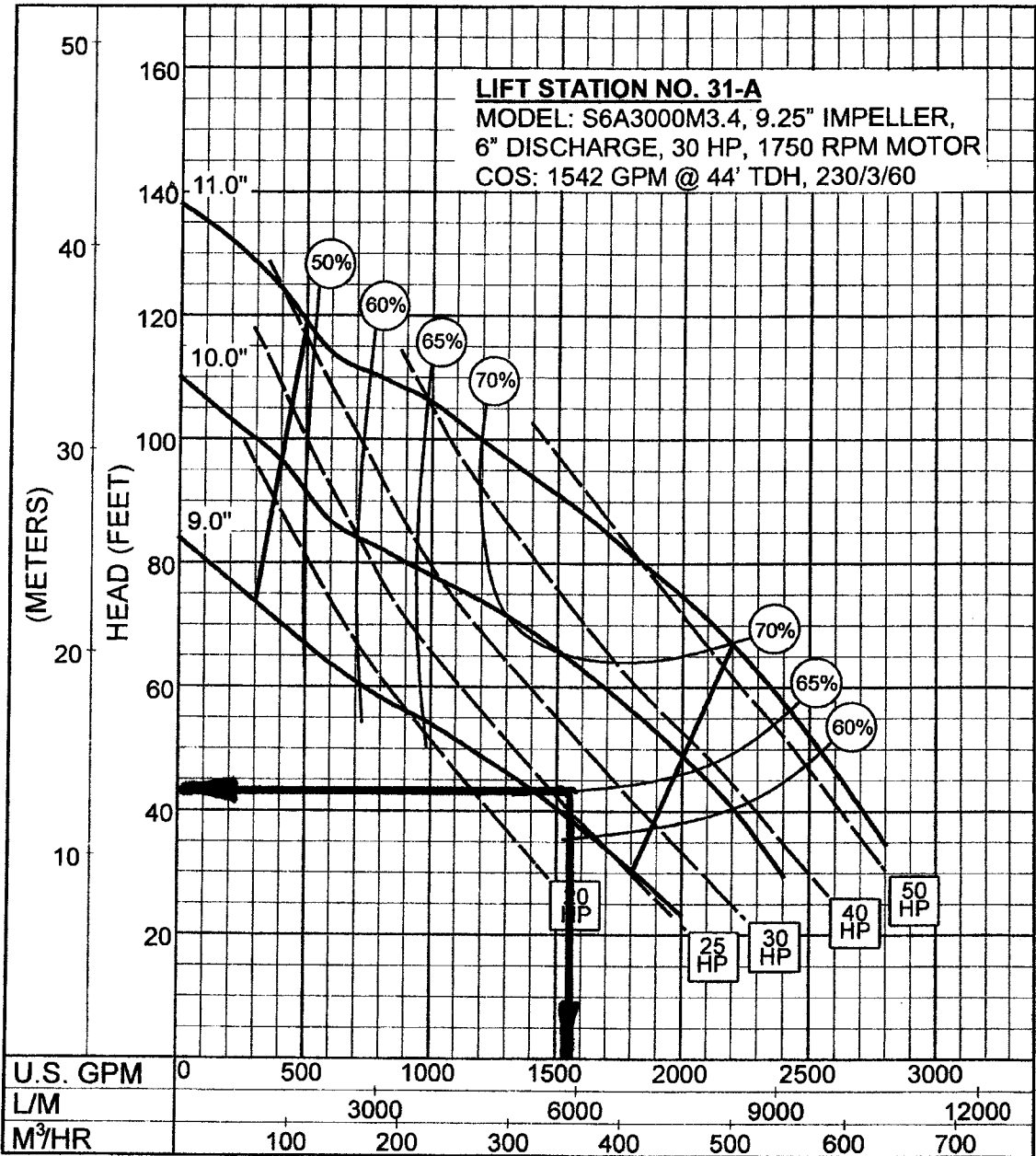

The curves reflect maximum performance characteristics without exceeding full load (Nameplate) horsepower. All pumps have a service factor of 1.2. Operation is recommended in the bounded area with operational point within the curve limit. Performance curves are based on actual tests with clear water at 70° F. and 1280 feet site elevation.

Conditions of Service:

GPM: _____ TDH: _____





ITEM #13

PERFORMANCE CURVES

| | | | |
|----------------------|----------|----------------------|-----------------------------|
| 4-poles ; 1750 rpm | M | Enclosed | ④ Mod.: AM434-170/5.5N (FM) |
| 4" Nominal discharge | | single-vane impeller | |
| 3" Solid size | | 60 Hz | |

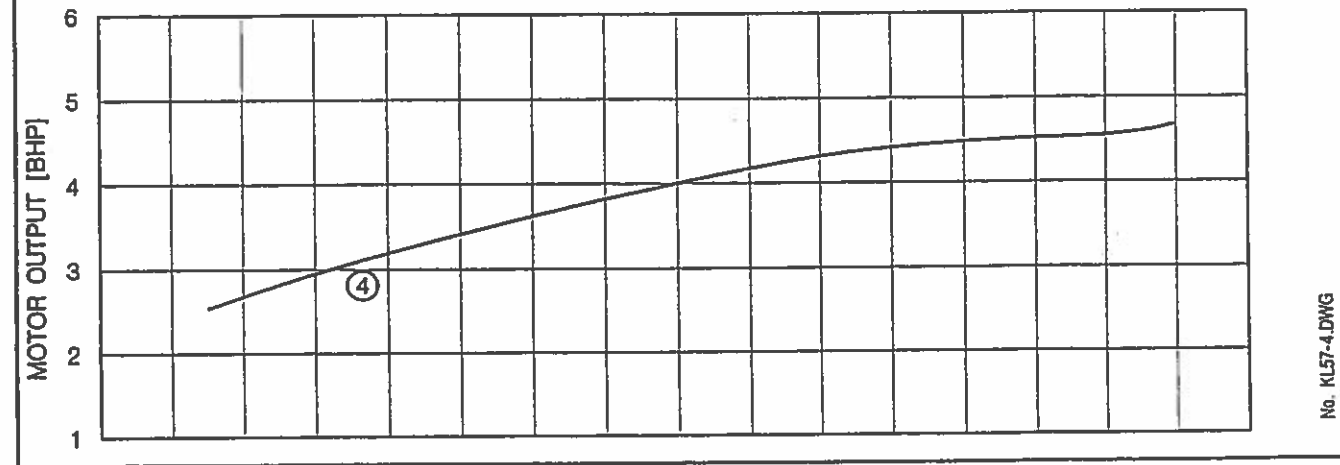
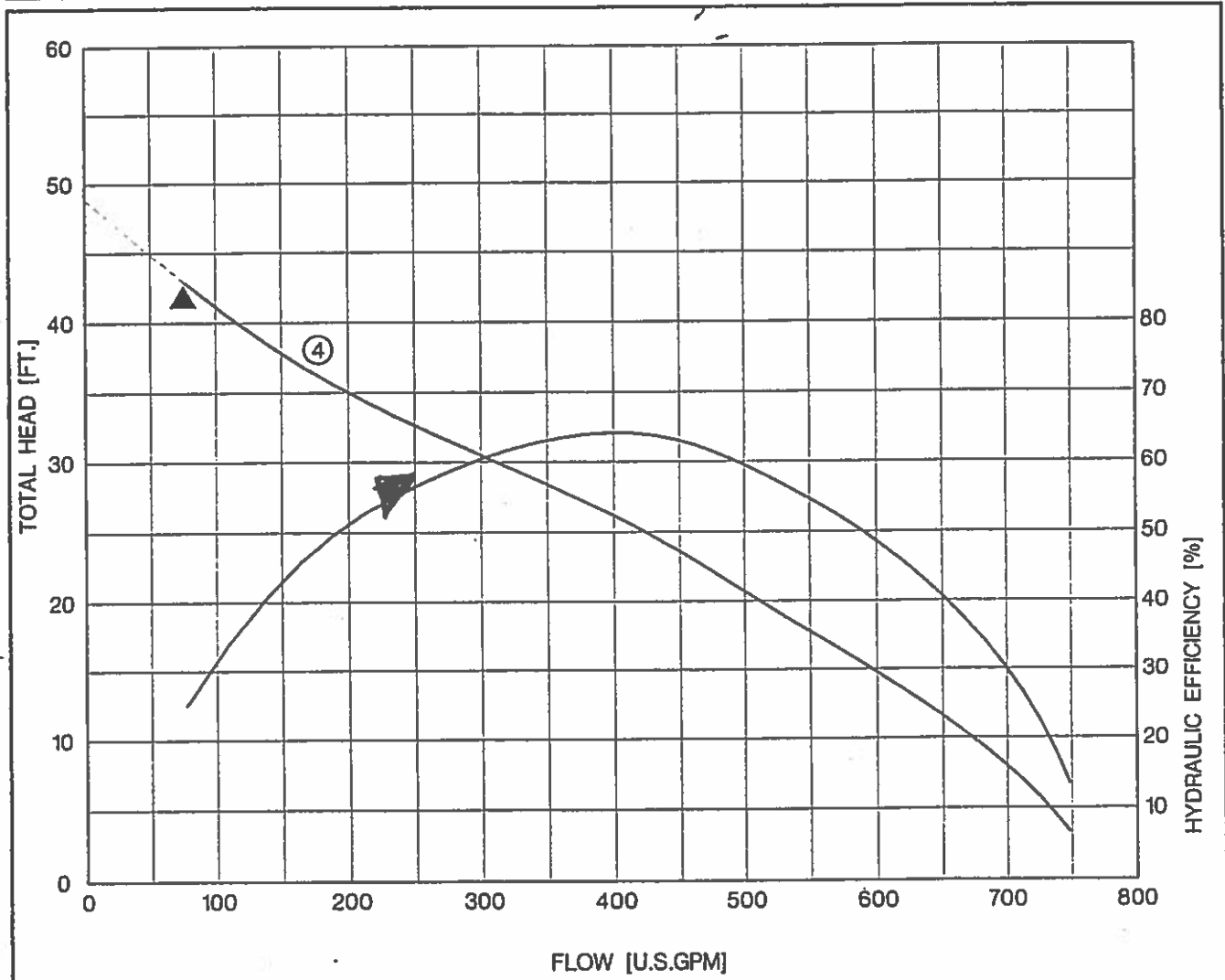

No. KL57-4.DWG

I&O Manual

1½", 2" & 3" Discharge

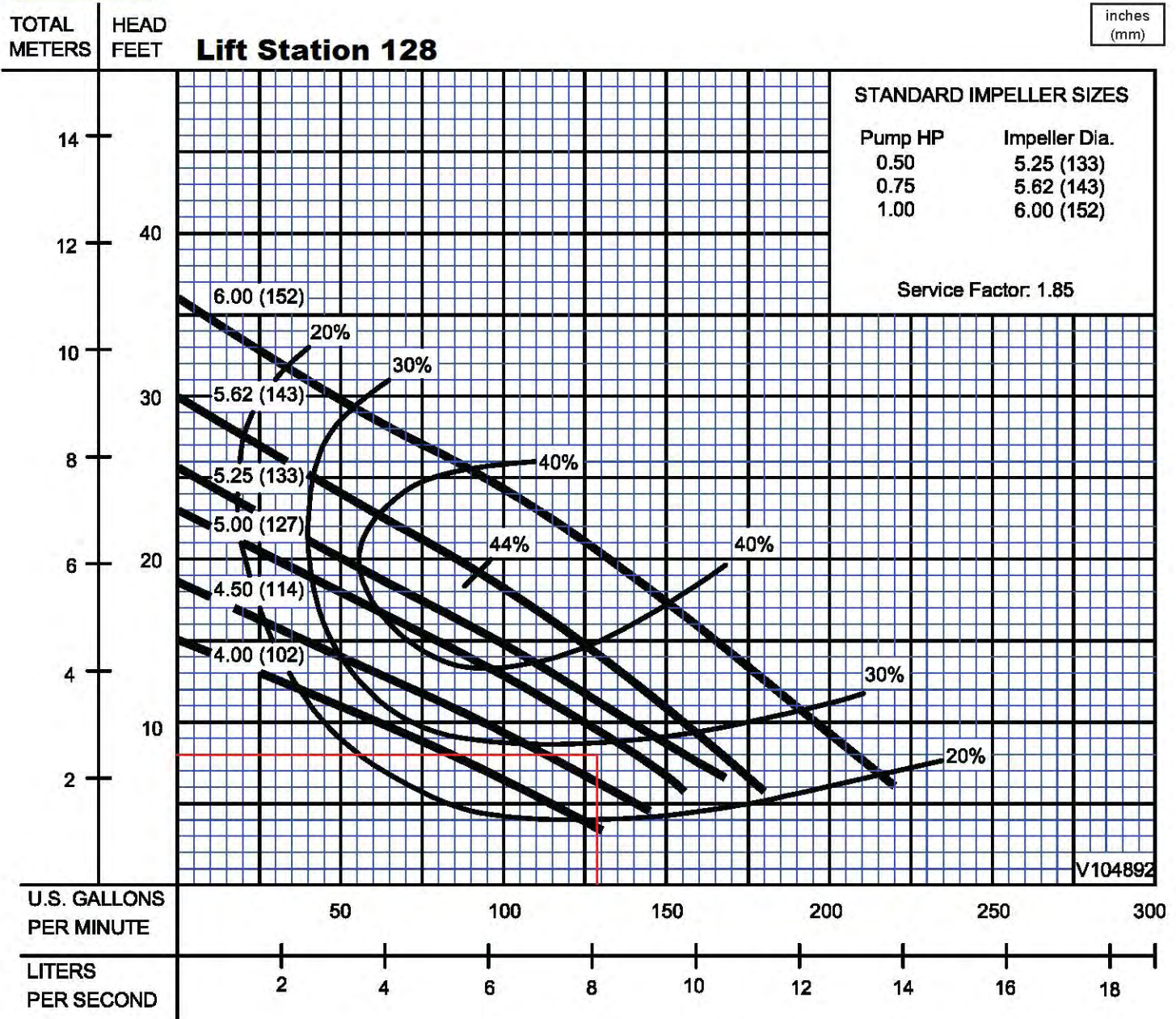

Testing is performed with water, specific gravity 1.0 @ 68° F @ (20°C), other fluids may vary performance

GPM: 128 TDH: 8

29-A

129



SUBMERSIBLE SEWAGE PUMP

Pump Type FA125-628
Motor Type FK20.1-6/22
Rated Motor H.P. 12.9
Rated R.P.M. 1150
Max. Sphere 5.0 inch

APPROVED SUBJECT TO RECEIPT,
OF CERTIFIED PUMP CURVES
PRIOR TO SHIPPING

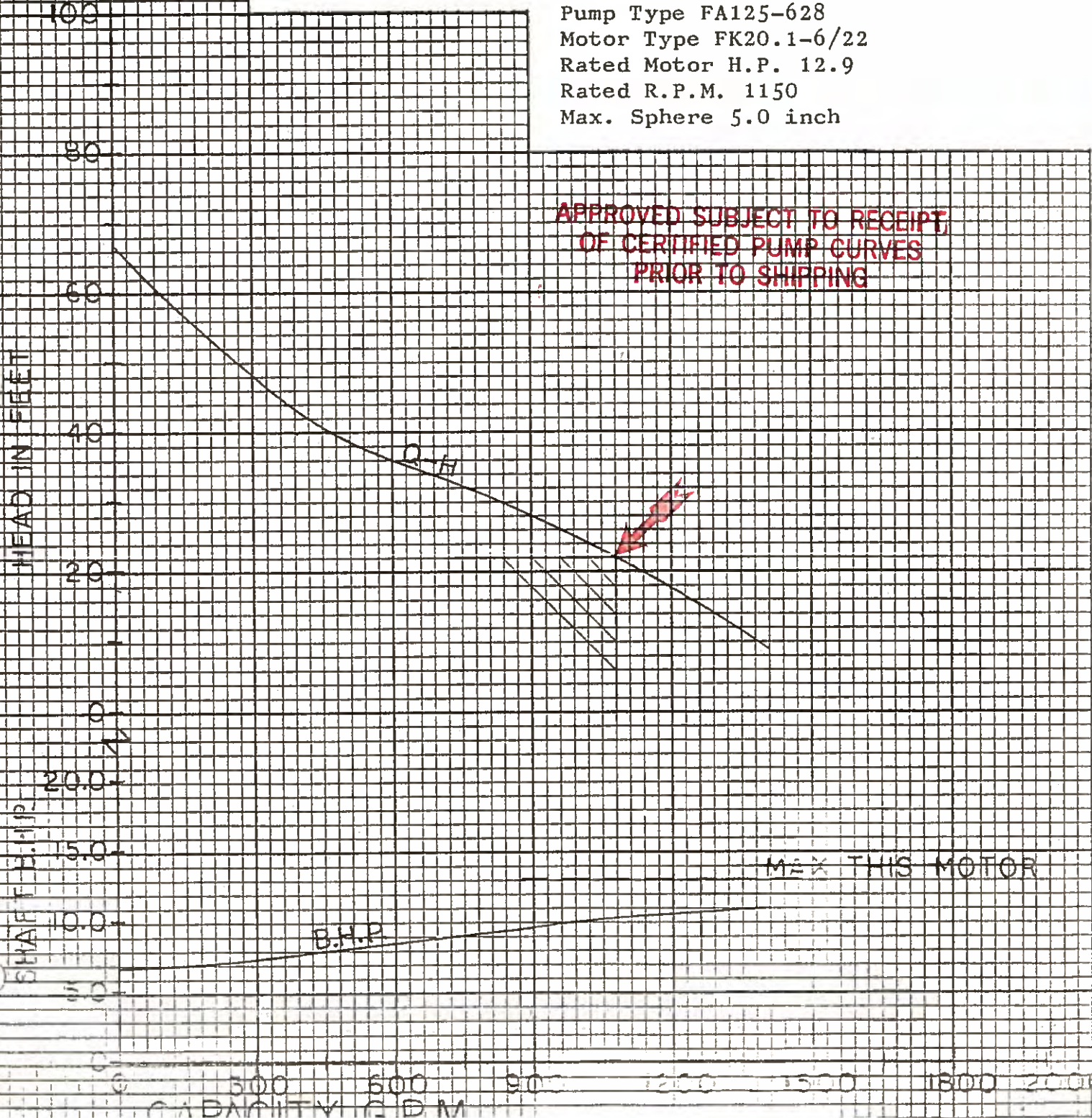

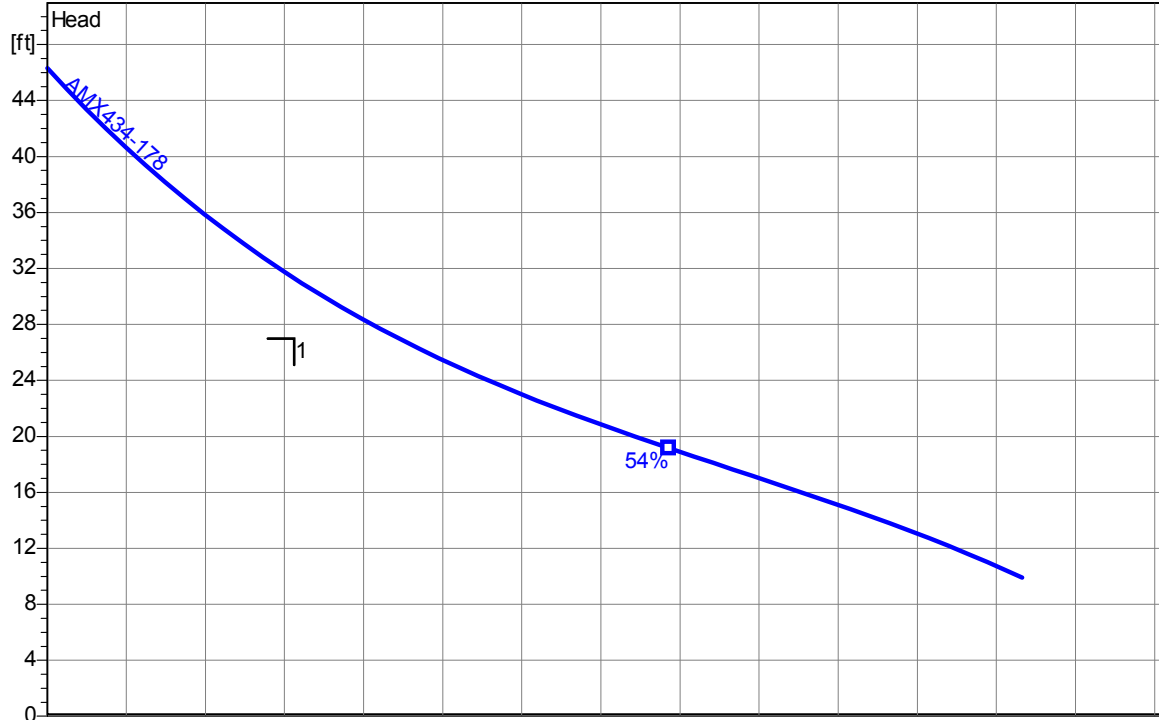
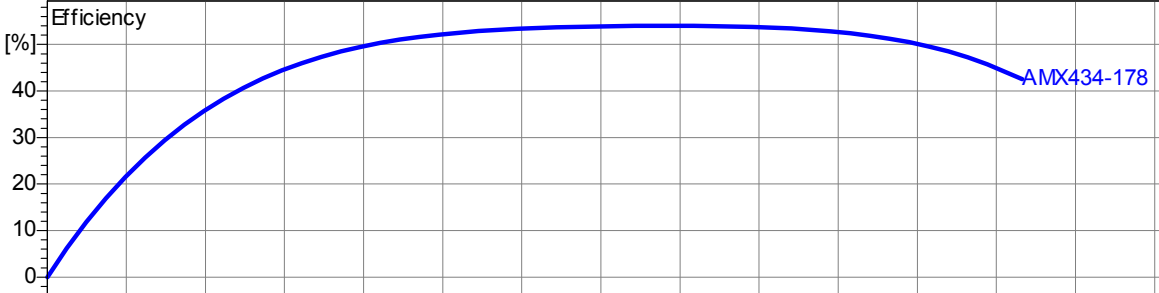
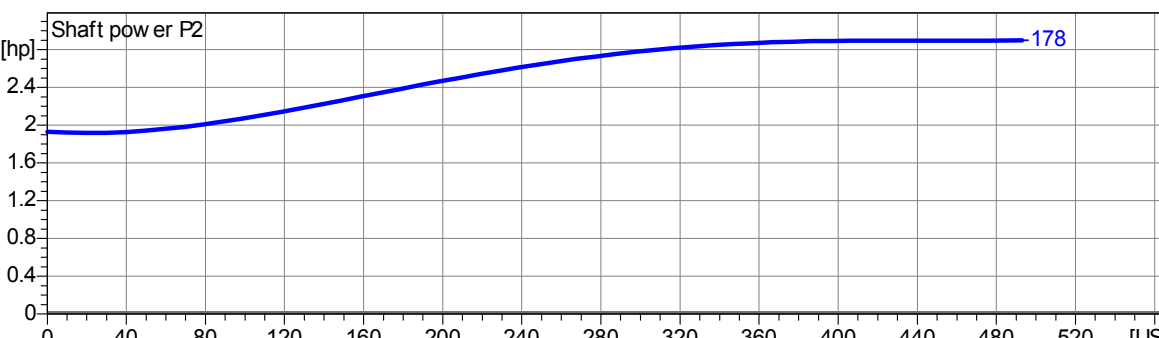
| Impeller | | | | | |
|--|----------------------------------|--|----------------------------------|---------------------------|-----------------------------------|
| Impeller type: Single channel impeller | Solid size 3 inch | Ø: | Max. Ø: 8 1/8" | Min. Ø: 5 9/16" | Sel. Ø: 7" |
| Operating data | | | | | |
| Speed: 1750 rpm | Frequency: 60 Hz | Duty point: Q = 125 US g.p.m. H = 27 ft | | Suction port: | Discharge port: 4" ANSI |
| Power data referred to: Water, pure [100%]; 68°F; 62.322lb/ft³; 1.0818E-5ft²/s | | | | Testnorm: | ISO 9906 |
| Curve number: | | | | | |
|  | | | | | |
|  | | | | | |
|  | | | | | |
| Project Man. Cty IFB #09-0897-OV | Project no.: LS # 28-A | | Created by: nyackerman | Page: 2 | Date: 4/1/2009 |

Series: PF4NC-SS

4" Discharge, Submersible Non-Clog Pumps
 3" Spherical Solids, Single Seal



RTU 131

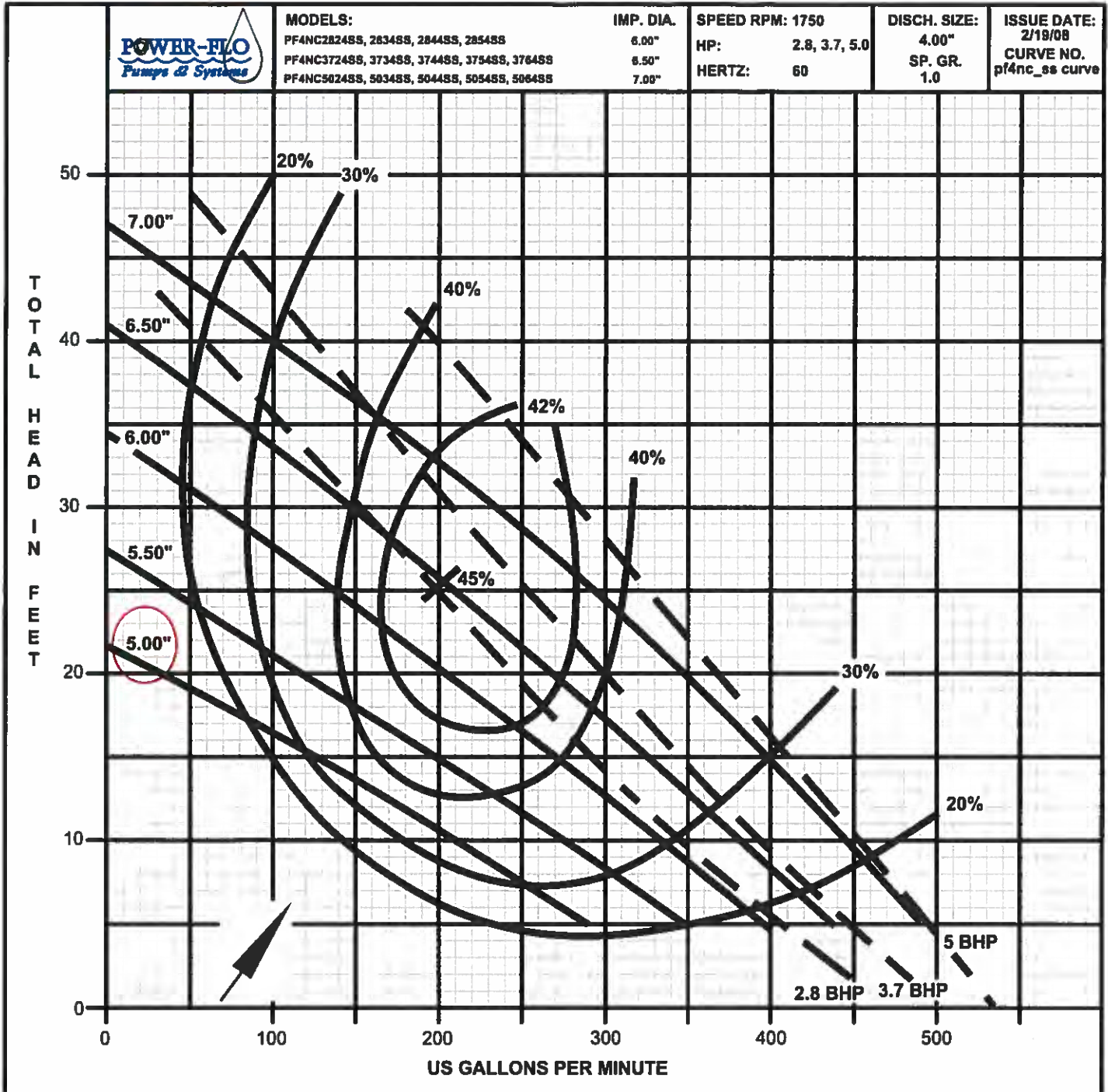

Flamingo Blvd. (132) Ebara 100DFLUG372 172 mm Imp-

100DLF63.7 (5HP) Synchronous Speed: 1800 RPM

4 inch Discharge

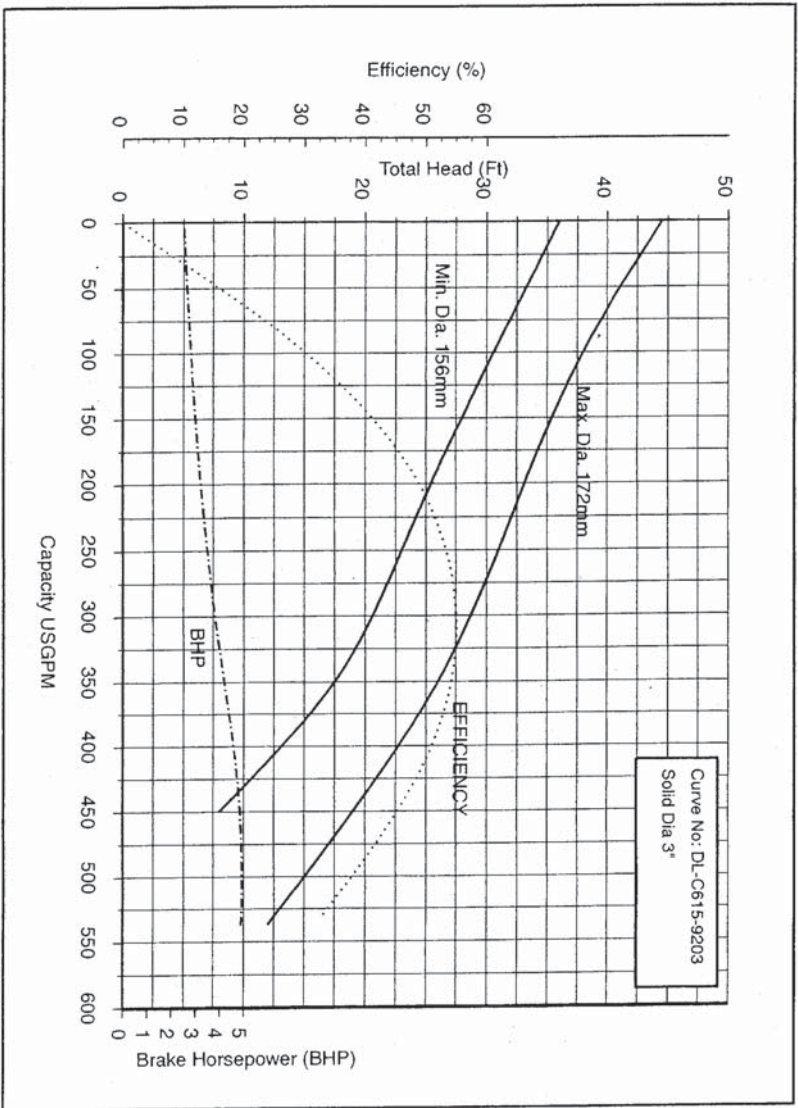

AMX434-184/4D/C

| Impeller | | | | | | |
|---|----------------------------|---|-----------------------------------|---------------|-----------------------------------|--|
| Impeller type: Single channel impeller | Solid size 3 inch | Ø: | Max. Ø: 8 1/8" | Min. Ø: 7" | Sel. Ø: 7 1/4" | |
| Operating data | | | | | | |
| Speed: 1750 rpm | Frequency: 60 Hz | Duty point: Q = 350 US g.p.m. H = 27 ft | Shaft power P2: 3.68 hp | | Discharge port: 4" ANSI | |

Power data referred to: Water, clean [100%]; 68°F; 62.322lb/ft³; 1.0818E-5ft²/s

Testnorm: ISO 9906/A

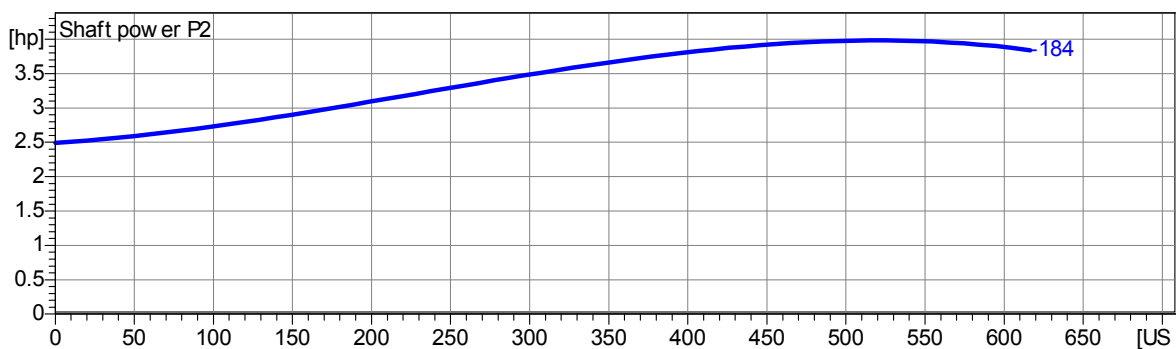
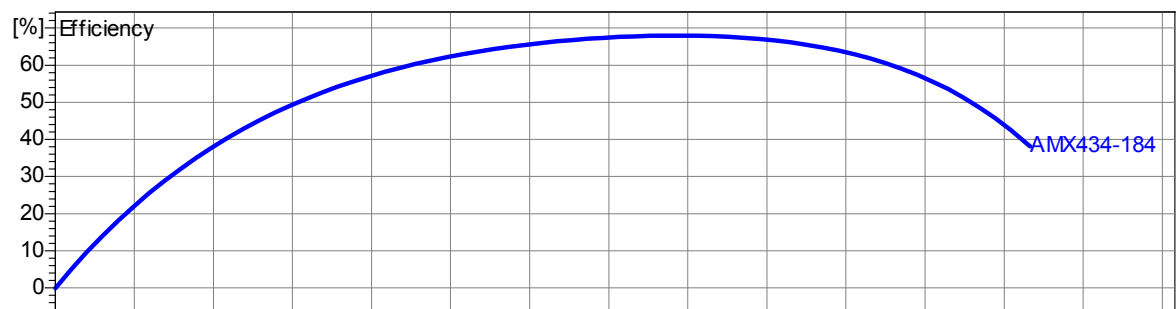

2.0 - 29.01.2009 (Build 168)

| | | | | |
|---------|--------------|-------------|-------------------|----------------------------|
| Project | Project no.: | Created by: | Page: 2 | Date: 2012-02-05 |
|---------|--------------|-------------|-------------------|----------------------------|

Company: Manatee County Utilities
 Name: Elmer's Automotive - RTU 133
 Date: 4/9/2012



Pump:

Size: S4N/S4NX
 Type: NCLOG-4
 Synch speed: 1200 rpm
 Curve: PAGE 110
 Specific Speeds:
 Dimensions:
 Speed: 1150 rpm
 Dia: 5.75 in
 Impeller:
 Ns: ---
 Nss: ---
 Suction: --- in
 Discharge: 4 in

Search Criteria:

Flow: --- US gpm Head: --- ft

Fluid:

Water
 Density: 62.37 lb/ft³
 Viscosity: 1.105 cP
 NPSHa: --- ft
 Temperature: 60 °F
 Vapor pressure: 0.2563 psi a
 Atm pressure: 14.7 psi a

Motor:

Consult HYDROMATIC to select a motor for this pump.

Pump Limits:

Temperature: 140 °F
 Pressure: 125 psi g
 Sphere size: 3 in
 Power: --- hp
 Eye area: --- in²

---- Data Point ----

Flow: 315 US gpm
 Head: --- ft
 Eff: --- %
 Power: --- hp
 NPSHr: --- ft

---- Design Curve ----

Shutoff head: 13.2 ft
 Shutoff dP: 5.7 psi
 Min flow: 20 US gpm
 BEP: 49% @ 241 US gpm
 NOL power:
 0.87 hp @ 183 US gpm

-- Max Curve --

Max power:
 2.88 hp @ 433 US gpm

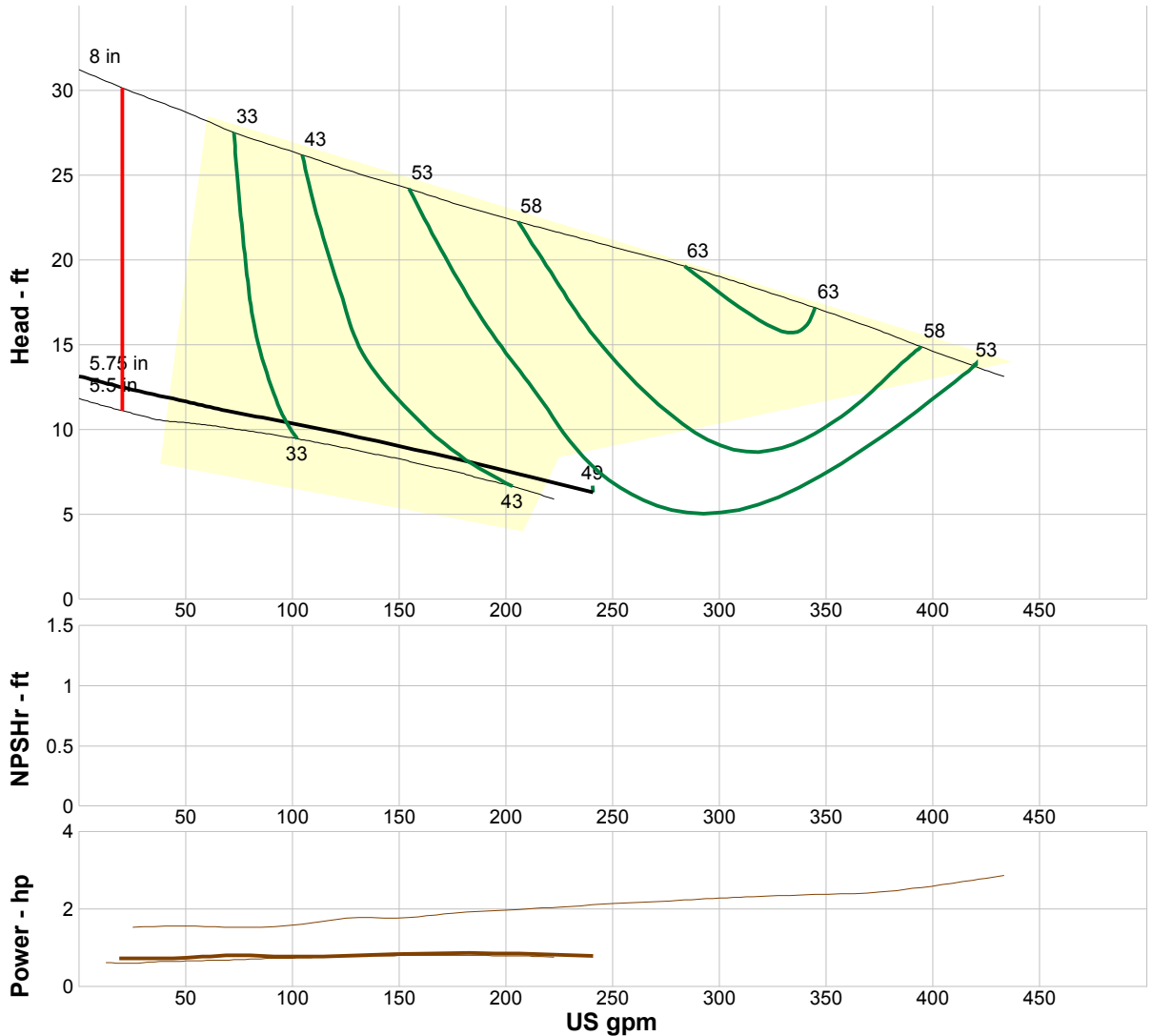

Performance Evaluation:

| Flow US gpm | Speed rpm | Head ft | Efficiency % | Power hp | NPSHr ft |
|----------------|--------------|------------|-----------------|-------------|-------------|
| 232 | 1150 | 6.58 | 48 | 0.804 | --- |
| 193 | 1150 | 7.78 | 44 | 0.856 | --- |
| 154 | 1150 | 8.89 | 40 | 0.839 | --- |
| 116 | 1150 | 9.93 | 35 | 0.798 | --- |
| 77.2 | 1150 | 10.9 | 27 | 0.799 | --- |

RTU 134

| | | | | | | | | | |
|---|------------|--|--|--|------------------------------|---|---------------------------------------|--|---------------------------------------|
| Impeller type: Single channel impeller | | | | | | Solid size \varnothing : 3 1/8" | Max. \varnothing : 8 1/8" | Min. \varnothing : 5 9/16" | Sel. \varnothing : 6 1/8" |
| Speed: 1700 rpm | Frequency: | Duty point: Q = 100 US g.p.m. H = 18 ft | | | Suction port: | Discharge port: 4" ANSI | | | |
| Power data referred to: Water, pure [100%]; 68°F; 62.322lb/ft ³ ; 1.0818E-5ft ² /s | | | | | Testnorm: ISO 9906 | | | | |

Curve number:

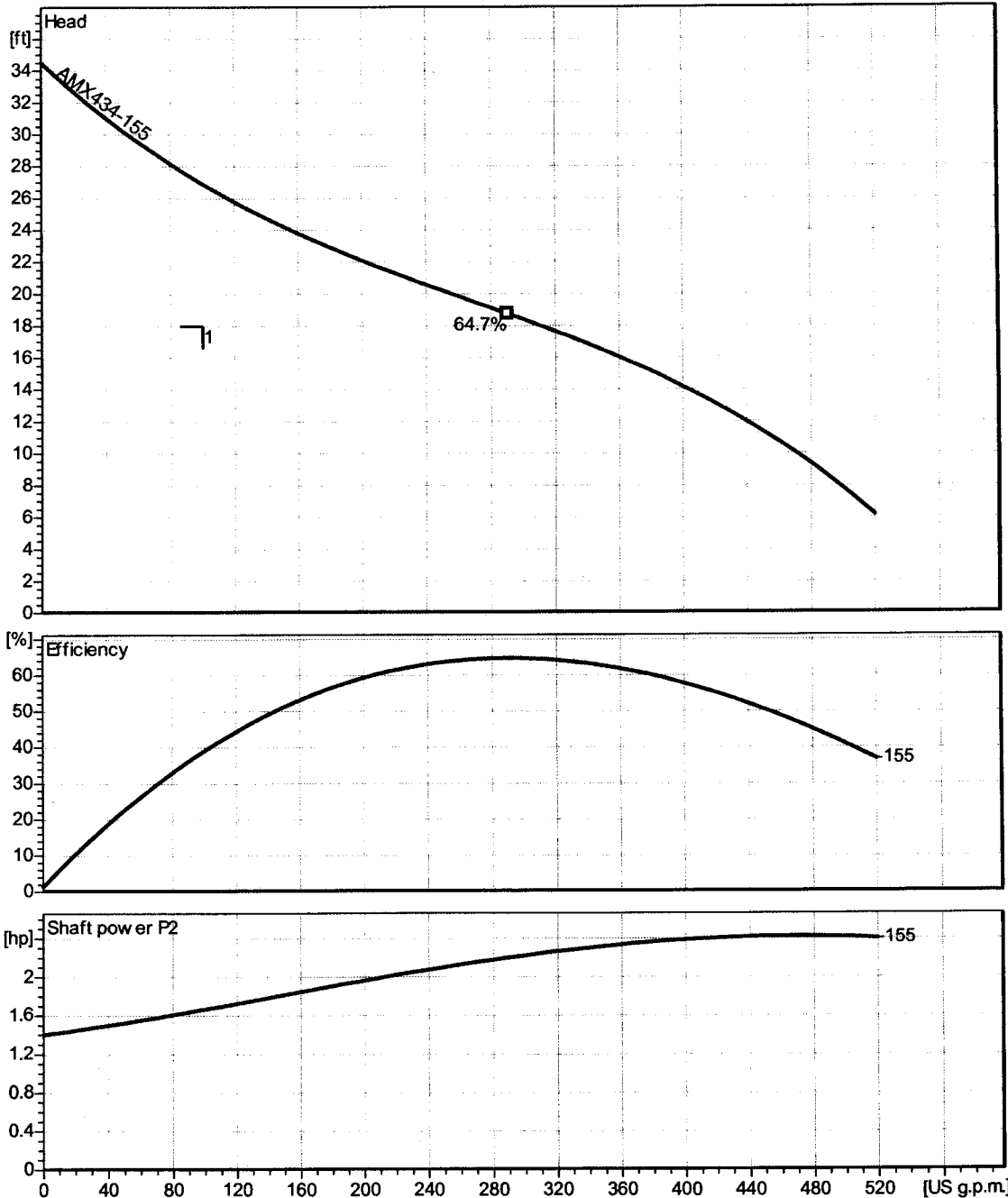

| | | | | |
|----------------------------------|---|----------------------------------|-------------------|----------------------------|
| Project Manatee County | Project no.: Sarabay Apartments | Created by: nyackerman | Page: 2 | Date: 2008-01-15 |
|----------------------------------|---|----------------------------------|-------------------|----------------------------|



Performance Curve

AMX646-330/15,3P

1-A (135)

Impeller

| | | | | | |
|---|--|----|---|---|-----------------------|
| Impeller type: Single vane impeller | Solid size 3¹⁵/₁₆" | Ø: | Max. Ø: 14⁹/₁₆" | Min. Ø: 12³/₁₆" | Sel. Ø: 13" |
|---|--|----|---|---|-----------------------|

Operating data

| | | | | |
|---------------------------|----------------------------|--|---------------------------------|-----------------------------------|
| Speed: 1160 rpm | Frequency: 60 Hz | Duty point: Q = 637 US g.p.m. H = 44 ft | Suction port: 6" ANSI | Discharge port: 6" ANSI |
|---------------------------|----------------------------|--|---------------------------------|-----------------------------------|

| | |
|--|------------------------------|
| Power data referred to: Water [100%] ; 68°F; 62.322lb/ft ³ ; 1.0818E-5ft ² /s | Testnorm: ISO 9906 |
|--|------------------------------|

Curve number:

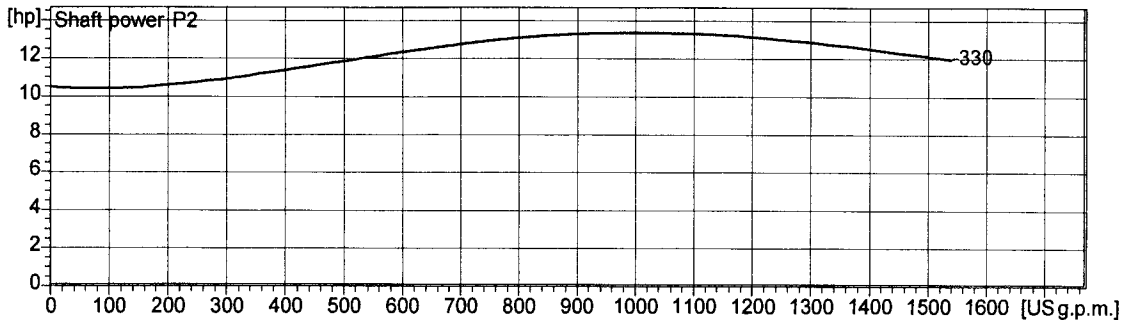
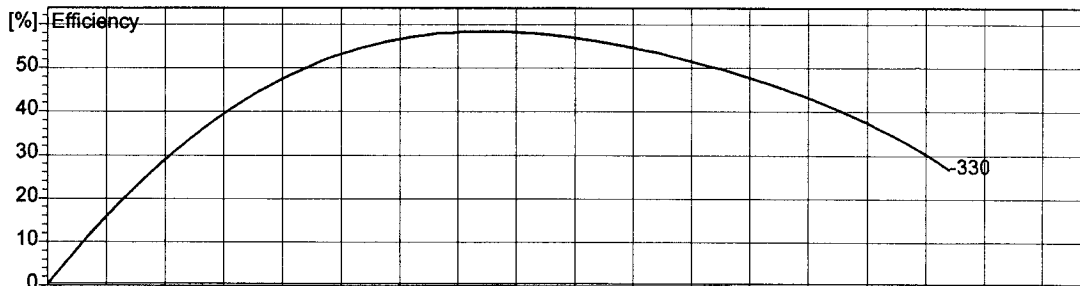
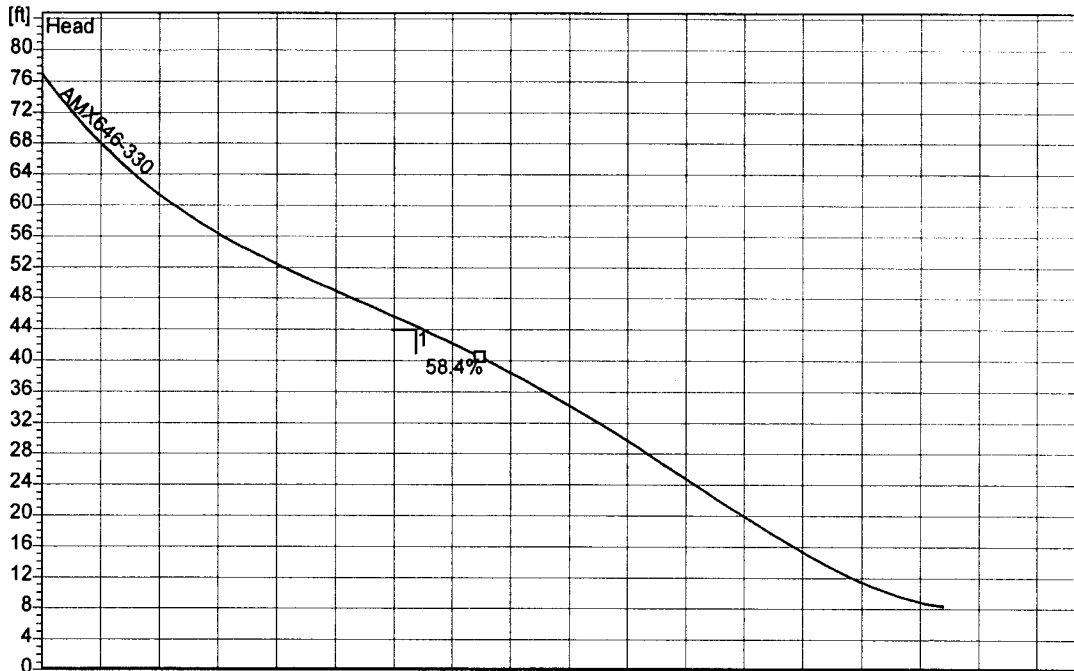

2.0 - 28.09.2004 (Build 60)

| | | | | |
|-------------------------------|--------------------------------------|---------------------------------|-------------------|----------------------------|
| Project Manatee Cty | Project no.: Item number 1 | Created by: nackerman | Page: 2 | Date: 2005-09-14 |
|-------------------------------|--------------------------------------|---------------------------------|-------------------|----------------------------|



Performance Curve

AMX434-193/5,5T

6-A

(136)

Impeller

| | | | | | |
|---|-----------------------------|----|--------------------------|---------------------------|--------------------------|
| Impeller type: Single vane impeller | Solid size 3 1/8" | Ø: | Max. Ø: 8 1/8" | Min. Ø: 5 9/16" | Sel. Ø: 7 5/8" |
|---|-----------------------------|----|--------------------------|---------------------------|--------------------------|

Operating data

| | | | | |
|---------------------------|----------------------------|--|---------------------------------|-----------------------------------|
| Speed: 1700 rpm | Frequency: 60 Hz | Duty point: Q = 453 US g.p.m. H = 33 ft | Suction port: 4" ANSI | Discharge port: 4" ANSI |
|---------------------------|----------------------------|--|---------------------------------|-----------------------------------|

Power data referred to: Water, pure [100%] ; 68°F; 62.322lb/ft³; 1.0818E-5ft²/s Testnorm: **ISO 9906**

Curve number:

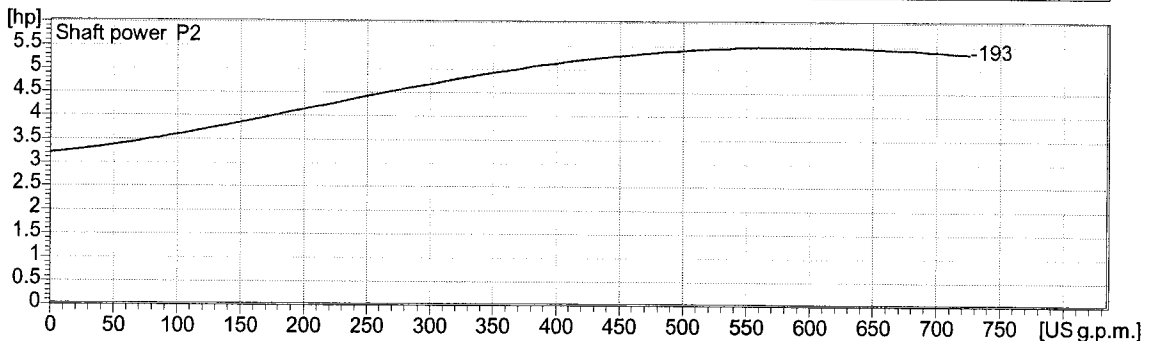
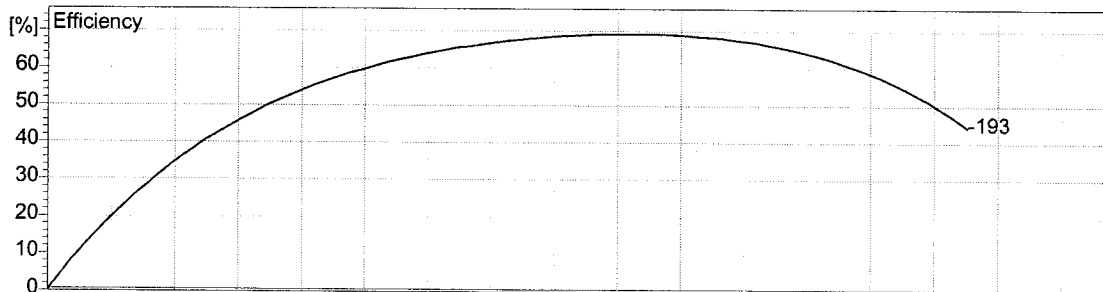
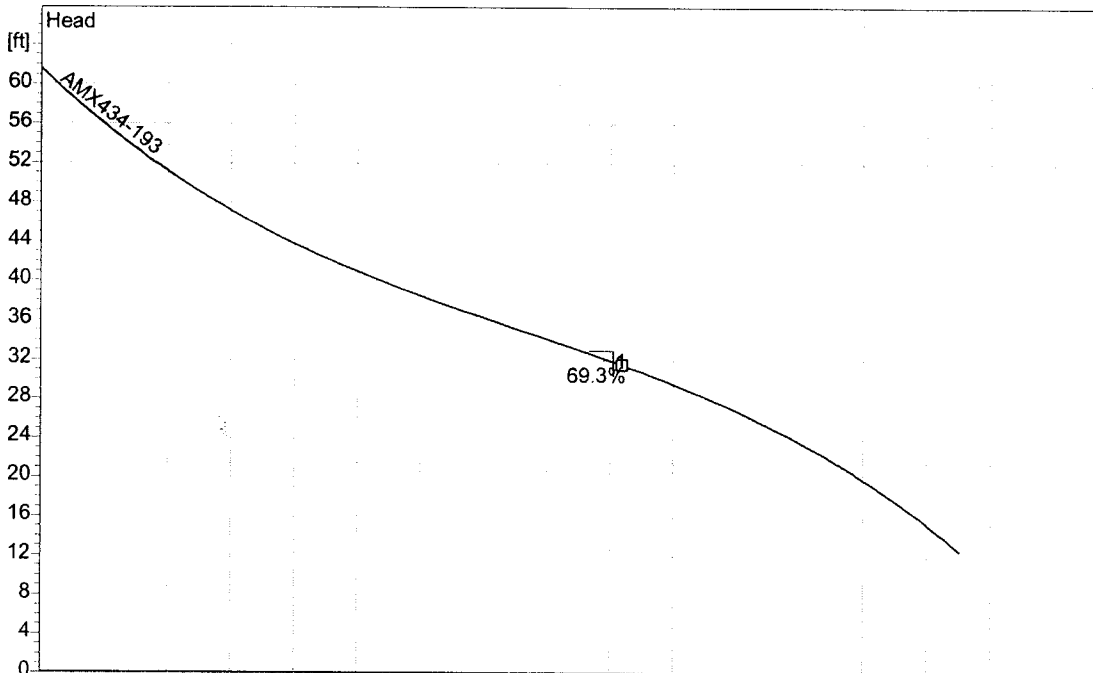

Project
Manatee Cty

Project no.:
Item Number 8

Created by:
nackerman

Page:
2

Date:
2005-09-14

Performance Curve

AMX434-184/4D/C

| Impeller | | | | | |
|---|-----------------------------|--|--------------------------|---------------------------|-----------------------------------|
| Impeller type: Single channel impeller | Solid size 3 inch | Ø: | Max. Ø: 8 1/8" | Min. Ø: 5 9/16" | Sel. Ø: 7 1/4" |
| Operating data | | | | | |
| Speed: 1750 rpm | Frequency: 60 Hz | Duty point: Q = 280 US g.p.m. H = 31 ft | | Suction port: | Discharge port: 4" ANSI |
| Power data referred to: Water, pure [100%]; 68°F; 62.322lb/ft³; 1.0818E-5ft²/s | | | | Testnorm: | ISO 9906 |

Curve number:

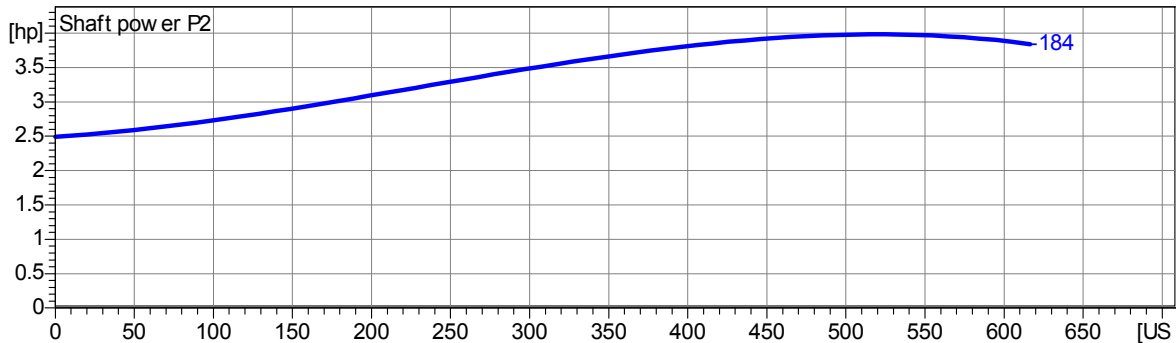
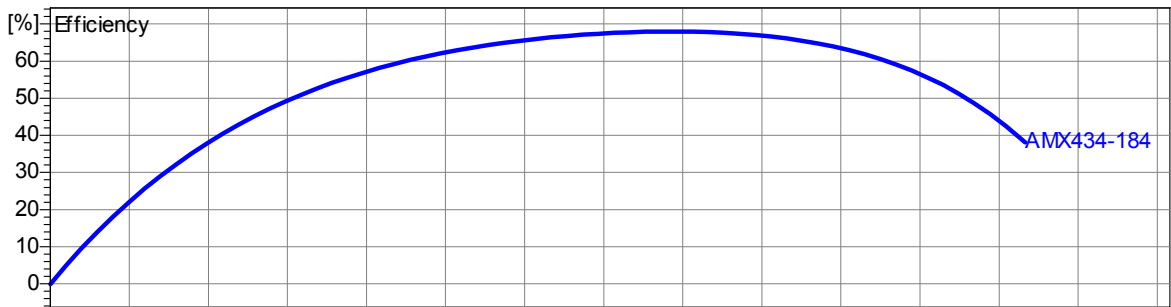
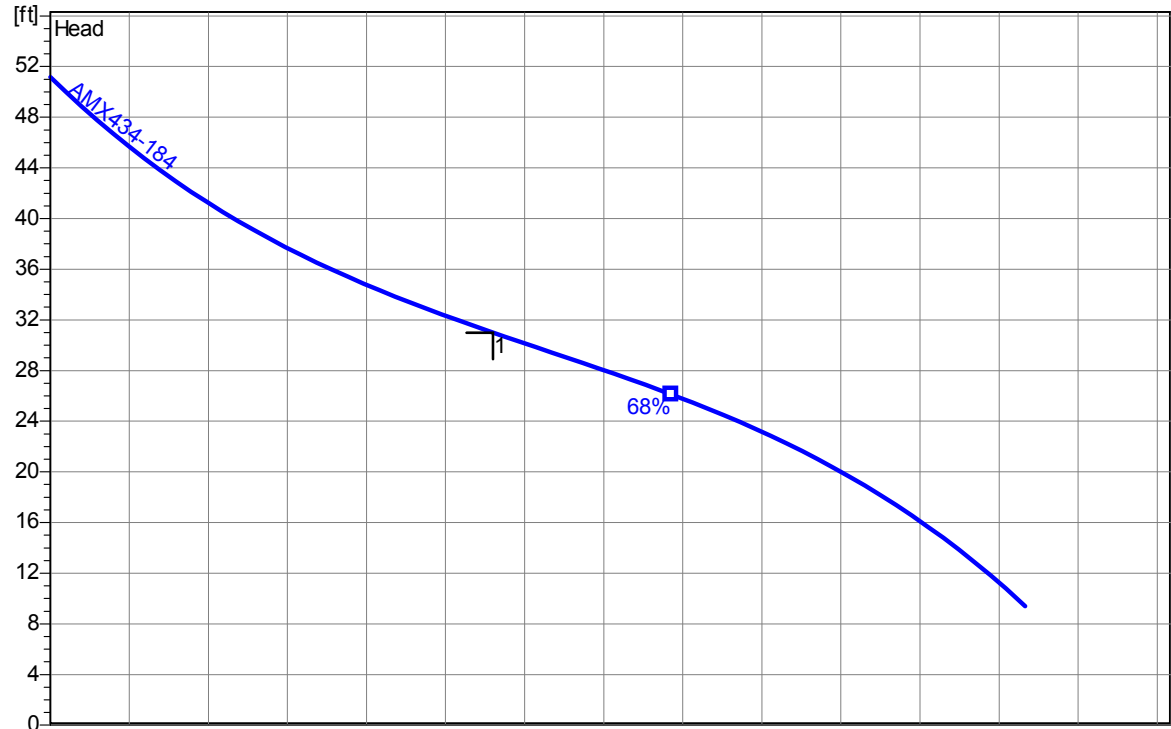

| | | | | |
|--|---------------------------------|----------------------------------|-------------------|--------------------------|
| Project Man. Cty IFB #09-0897-OV | Project no.: LS # 7-A | Created by: nyackerman | Page: 2 | Date: 4/1/2009 |
|--|---------------------------------|----------------------------------|-------------------|--------------------------|

JUN. 23. 2005 8:59AM

ITT FLYGT

No. 2166 P. 3

27A



TEST REPORT

PRODUCT

| | | | | | | | |
|-------------------------------|--|---|--|-------------------------------------|--|------------------------------|--|
| Serial No. 3306.665 | | Performance curve No. 0541126 | | Motor module/type 63-831 | | Voltage (V) 460 | |
| Base module 000 | | Impeller No. 574 18 04 | | Gear type | | Gear ratio | |
| | | | | Imp. diam/Blade angle 460 | | Water temp (°C) 21 | |

TEST RESULTS

| Pump total head H (ft) | Volume rate of flow Q (USGpm) | Motor input power P (kW) | Voltage U (V) | Current I (A) | Overall efficiency η (%) |
|---------------------------|----------------------------------|-----------------------------|------------------|------------------|-----------------------------|
| 90.97 | 33.2 | 36.99 | 463 | 68.0 | 1.54 |
| 71.59 | 2082.4 | 47.32 | 463 | 79.6 | 59.43 |
| 65.84 | 2842.9 | 52.61 | 463 | 86.4 | 69.48 |
| 60.49 | 3518.2 | 55.15 | 463 | 89.9 | 72.70 |
| 53.08 | 4482.8 | 59.77 | 463 | 96.7 | 75.11 |
| 45.33 | 5224.1 | 60.26 | 463 | 96.8 | 74.01 |
| 34.92 | 6186.0 | 59.68 | 463 | 95.9 | 68.28 |

| | | | | |
|-----------------------------|--|------------------------------|----------------------|-----------------------------|
| Accepted after HI | Test facility Lindas Q2 Sweden | Test date 05-06-22 | Time 22:19 | Chief tester 2173 |
|-----------------------------|--|------------------------------|----------------------|-----------------------------|

PLOTTED TEST RESULTS Measured point: + = Q/H, X = Q/P, Δ = Q/ETA overall
 Duty point: ◇ = Q/H, □ = Q/P, Δ = Q/ETA overall
 Calculated point: λ = Q/ETA overall

TOTAL HEAD

INPUT POWER

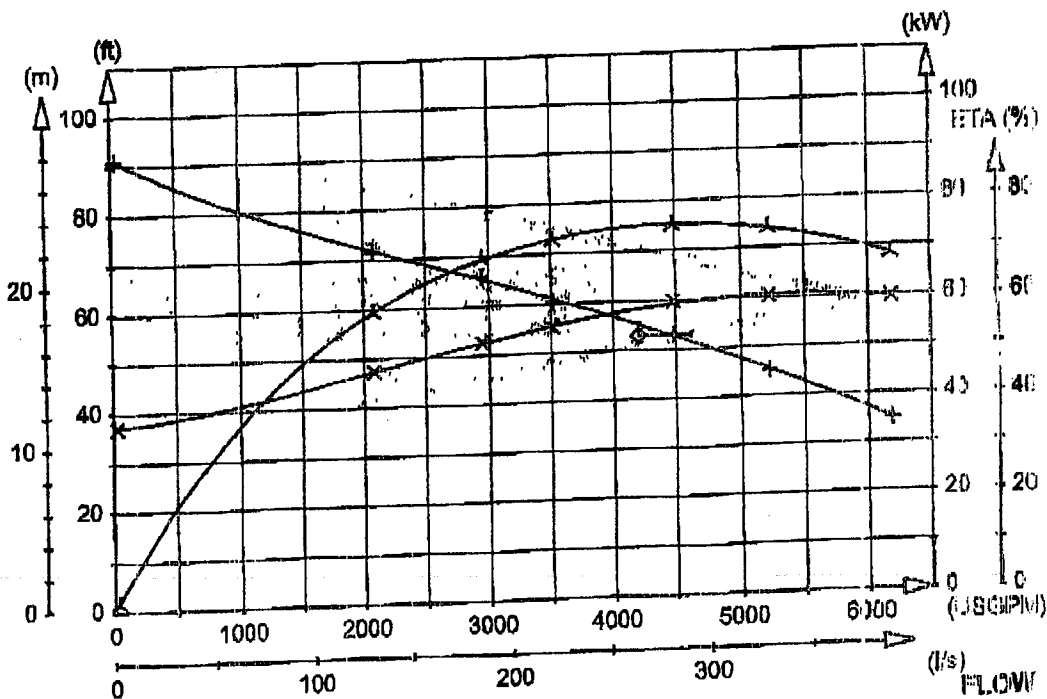

FLYGT

TEST REPORT

PRODUCT

| | | | | |
|-------------------------------|----------------------------------|--|---------------------------------------|--------------------------------------|
| Serial No. 3231.665 | 0541106 | Performance curve No. 63-430 | Motor module/type 35-45-4AA | Voltage (V) 480 |
| Base module 000 | Impeller No. 621 10 23 | Gear type | Gear ratio | Imp. diam./Blade angle 345 |
| | | | | Water temp °C 27 |

TEST RESULTS

| Pump total head H (ft) | Volume rate of flow Q (USGpm) | Motor input power P (kW) | Voltage U (V) | Current I (A) | Overall efficiency η (%) |
|---------------------------|----------------------------------|-----------------------------|------------------|------------------|----------------------------------|
| 213.16 | 31.1 | 49.66 | 482 | 97.9 | 2.51 |
| 162.63 | 1586.4 | 82.16 | 481 | 133.9 | 51.49 |
| 141.76 | 2306.2 | 93.67 | 481 | 148.1 | 65.84 |
| 123.88 | 2867.1 | 99.12 | 480 | 155.0 | 67.34 |
| 109.79 | 3353.2 | 101.85 | 481 | 158.5 | 68.32 |
| 87.67 | 4044.2 | 103.36 | 481 | 160.5 | 64.72 |
| 70.50 | 4588.7 | 101.92 | 450 | 158.7 | 59.88 |

| | | | | |
|-----------------------------|---------------------------------------|------------------------------|----------------------|--------------|
| Accepted after HI | Test facility Lindas Sweden | Test date 05-06-16 | Time 10:44 | Chief tester |
|-----------------------------|---------------------------------------|------------------------------|----------------------|--------------|

PLOTTED TEST RESULTS

Measured point: + = Q/H
 X = Q/P
 Duty point: \diamond = Q/H
 \square = Q/P
 \triangle = Q/ETA overall
 Calculated point: \cdot = Q/ETA overall

TOTAL HEAD

INPUT POWER

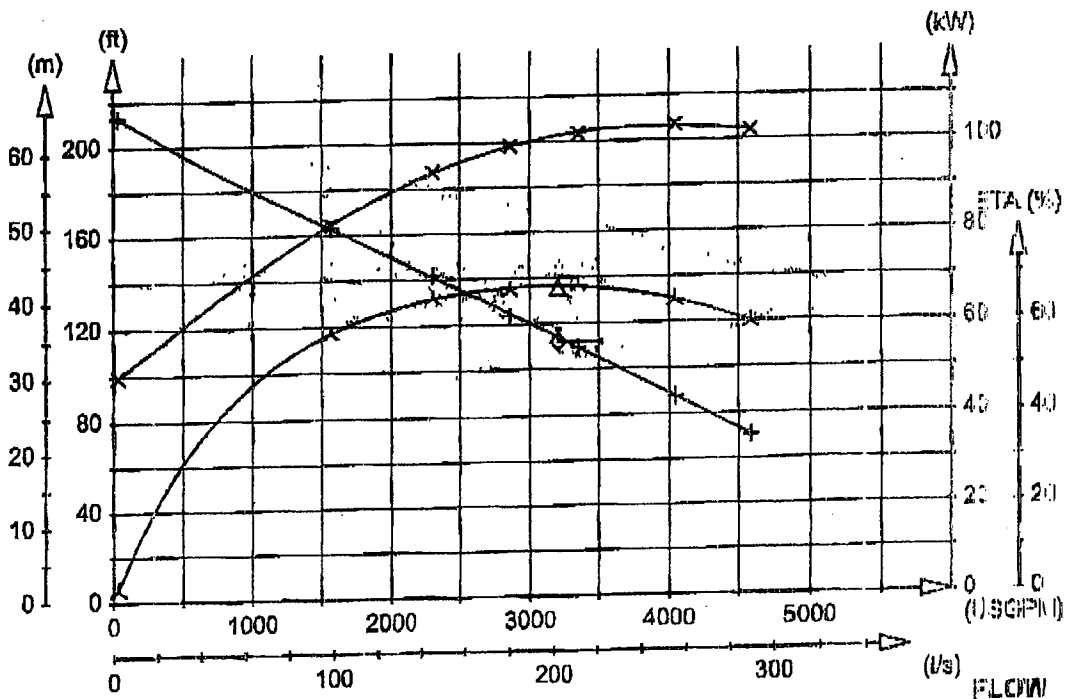

Five Lakes **140**

Crane/Barnes

Selection list: ---

Catalog: Crane Barnes 60Hz vers 8

Criteria:

Pump: 4SE28*4L

Flow: 150 US gpm
Head: 15 ft
Tolerance: --- % of head

Type: 1D4NONCLOG
Synch speed: 1800 rpm
Speed: 1750 rpm
Dia: 5.25 in
Curve no.:

Fluid: Water

Temperature: 60 °F
SG: 1
Viscosity: 1.105 cP
Vapor pressure: 0.2563 psi a
Atm pressure: 14.7 psi a

Specific Speeds

Ns: --- Nss: ---

Dimensions:

Suction: --- in Discharge: 4 in

NPSHa: --- ft

Pump Limits:

Temperature: --- °F
Pressure: --- psi g
Sphere size: 3 in
Power: --- bhp

Advanced Criteria:

Preferred Operating Area: ---
Secondary Operating Point: ---
Max temperature: --- °F
Max suction pressure: --- psi g
Max sphere size: --- in
Max power: --- bhp
Max suction specific speed: --- (Nss)
Min trim: --- % of max diameter
Min head rise: --- % to shutoff

Motor: Consult vendor

Curve Corrections: none

--- Data Point ---

Flow: 150 US gpm
Head: 15.7 ft
Eff: 39%
Power: 1.51 bhp
NPSHr: --- ft

--- Design Curve ---

Shutoff Head: 24 ft
Shutoff dP: 10.4 psi
Min Flow: --- US gpm
BEP: 40% eff
@ 181 US gpm
NOL Pwr: 1.92 bhp
@ 380 US gpm

--- Max Curve ---

Max Pwr: 2.92 bhp
@ 180 US gpm

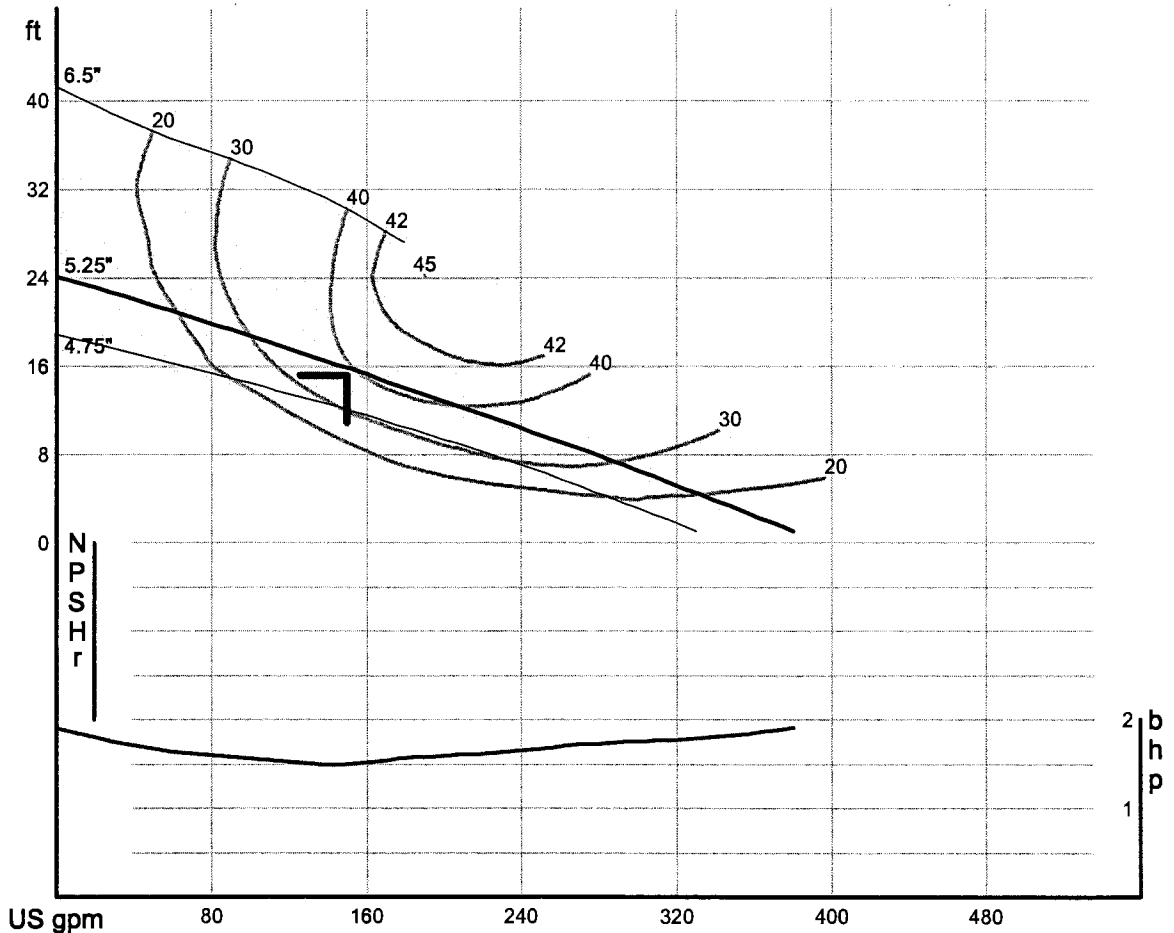

Pump note: Temp. 104°F (40°C) Continuous.

Performance Curve – S4HRC/S4HVX

RPM: 3450 DISCHARGE: 4" SOLIDS: 3"

Lift Station 141

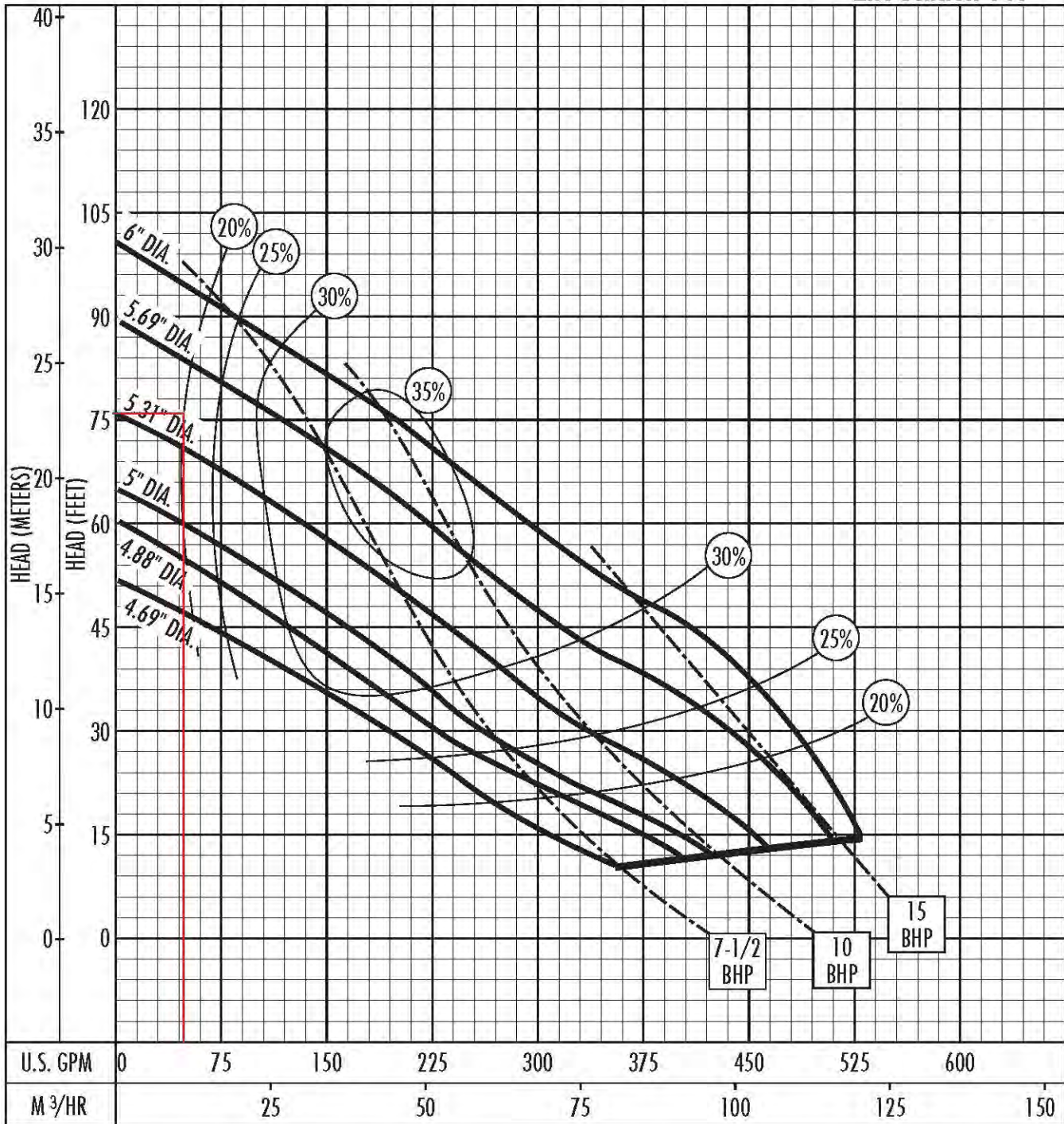

The curves reflect maximum performance characteristics without exceeding full load (Nameplate) horsepower. All pumps have a service factor of 1.2. Operation is recommended in the bounded area with operational point within the curve limit. Performance curves are based on actual tests with clear water at 70° F. and 1280 feet site elevation.

Conditions of Service:



HYDROMATIC

GPM: **48**

TDH: **76**

Vizcaya



MODELS S4HRC (NON-X-PROOF), S4HVX (X-PROOF) SUBMERSIBLE SEWAGE PUMPS

141

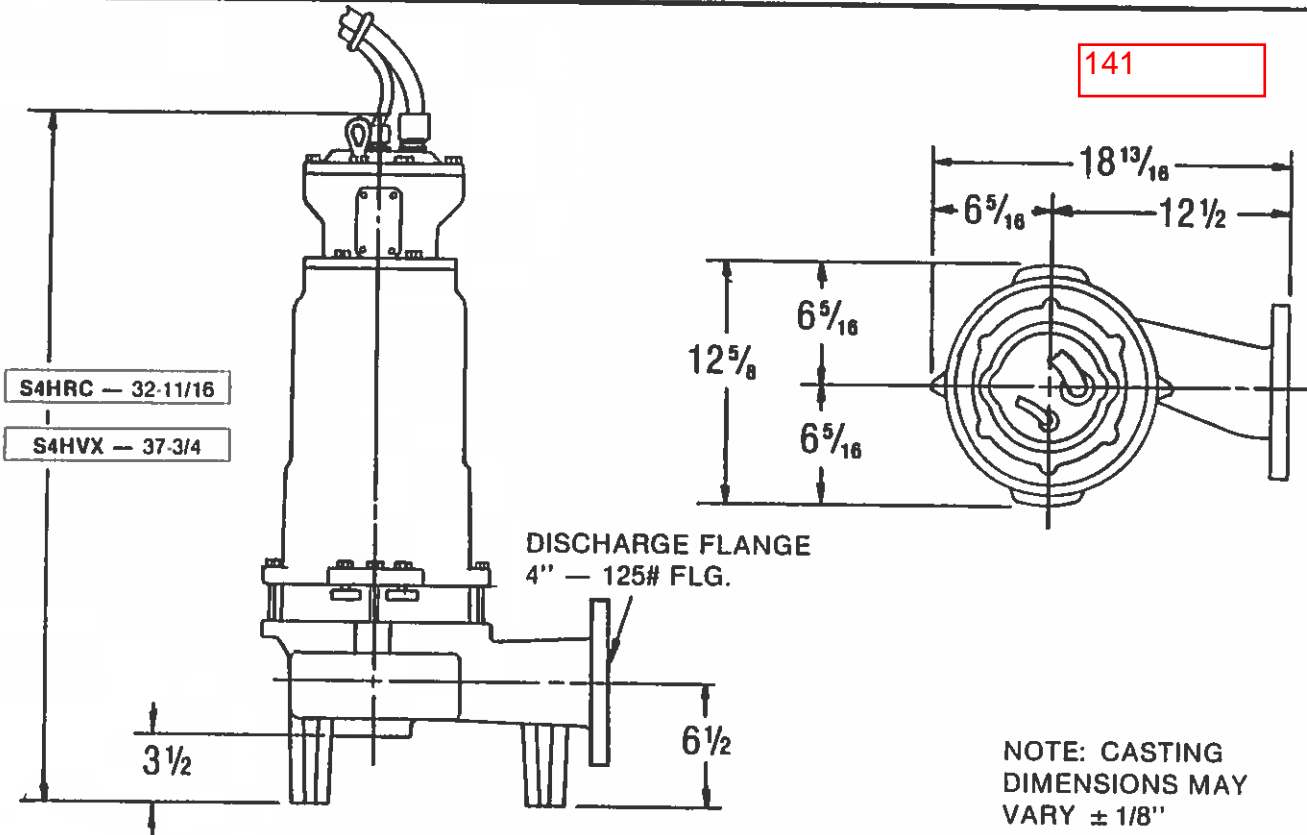

S4HRC/S4HVX—MAX. SOLIDS 3" SPHERE—3450 RPM

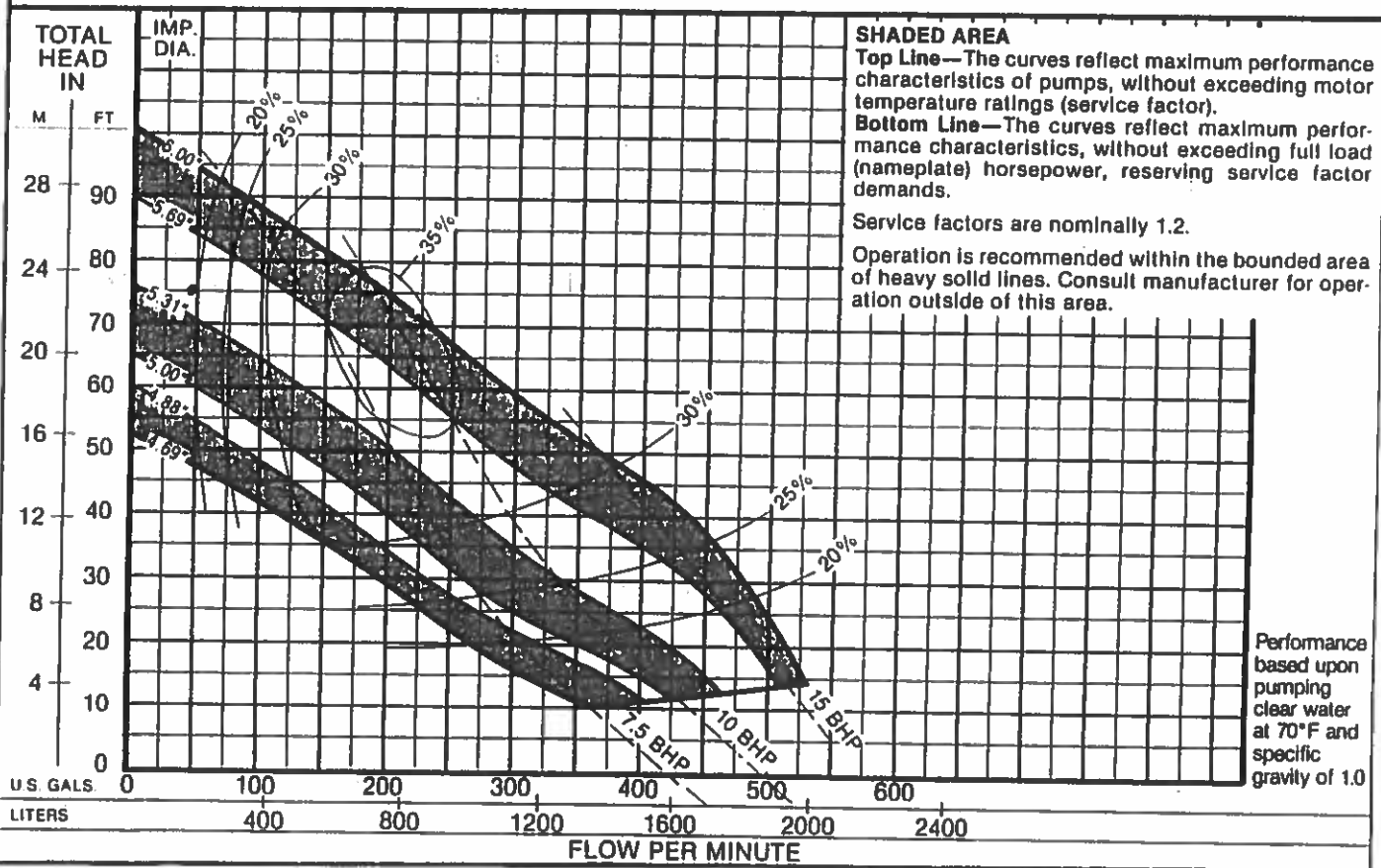

Cortez Commercial Center 142

Crane/Barnes

Selection list: ---

Catalog: Crane Barnes 60Hz vers 8

Selection Criteria:

Pump: 4SE28*4L

Flow: 150 US gpm
Head: 25 ft
Tolerance: --- % of head

Type: 1D4NONCLOG
Synch speed: 1800 rpm
Speed: 1750 rpm
Dia: 6 in
Curve no.:

Fluid: Water

Temperature: 60 °F
SG: 1
Viscosity: 1.105 cP
Vapor pressure: 0.2563 psi a
Atm pressure: 14.7 psi a

Specific Speeds

Ns: --- Nss: ---

Dimensions:

Suction: --- in Discharge: 4 in

NPSHa: --- ft

Pump Limits:

Temperature: --- °F
Pressure: --- psi g
Sphere size: 3 in
Power: --- bhp

Advanced Criteria:

Preferred Operating Area: ---
Secondary Operating Point: ---
Max temperature: --- °F
Max suction pressure: --- psi g
Max sphere size: --- in
Max power: --- bhp
Max suction specific speed: --- (Nss)
Min trim: --- % of max diameter
Min head rise: --- % to shutoff

Motor: Consult vendor

Curve Corrections: none

--- Data Point ---
Flow: 150 US gpm
Head: 24.2 ft
Eff: 41%
Power: 2.24 bhp
NPSHr: --- ft

-- Design Curve --
Shutoff Head: 34.5 ft
Shutoff dP: 14.9 psi
Min Flow: --- US gpm
BEP: 43% eff
@ 211 US gpm
NOL Pwr: 2.9 bhp
@ 342 US gpm

-- Max Curve --
Max Pwr: 2.92 bhp
@ 180 US gpm

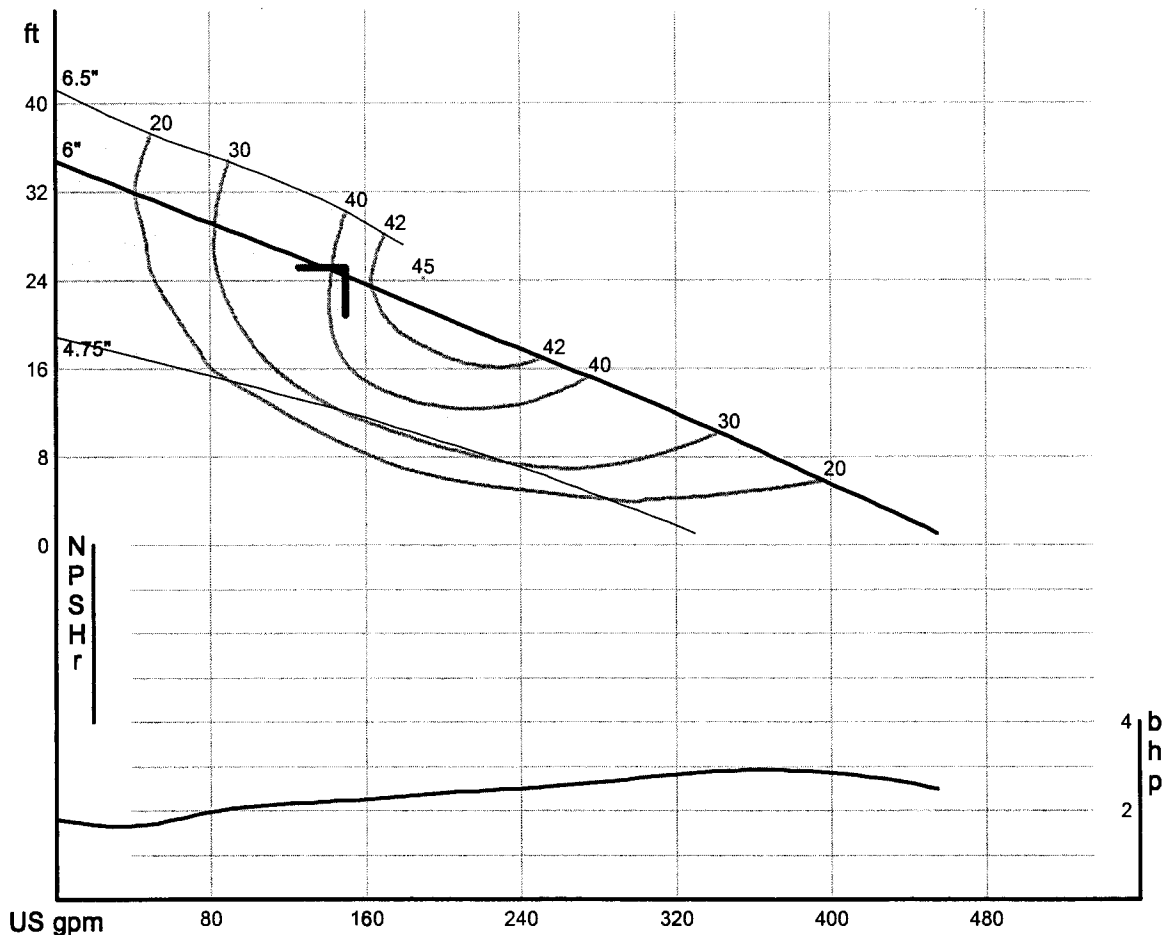

Pump note: Temp. 104°F (40°C) Continuous.



Performance Curve

AMX434-155/4D

Braden Lakes

(143)

Impeller

| | | | | |
|---|--------------------------------|--------------------------|---------------------------|--------------------------|
| Impeller type: Single vane impeller | Solid size Ø: 3 1/8" | Max. Ø: 8 1/8" | Min. Ø: 5 9/16" | Sel. Ø: 6 1/8" |
|---|--------------------------------|--------------------------|---------------------------|--------------------------|

Operating data

| | | | | |
|---------------------------|----------------------------|--|---------------|-----------------------------------|
| Speed: 1700 rpm | Frequency: 60 Hz | Duty point: Q = 180 US g.p.m. H = 18 ft | Suction port: | Discharge port: 4" ANSI |
|---------------------------|----------------------------|--|---------------|-----------------------------------|

| | |
|--|------------------------------|
| Power data referred to: Water, pure [100%] ; 68°F; 62.322lb/ft³; 1.0818E-5ft²/s | Testnorm: ISO 9906 |
|--|------------------------------|

Curve number:

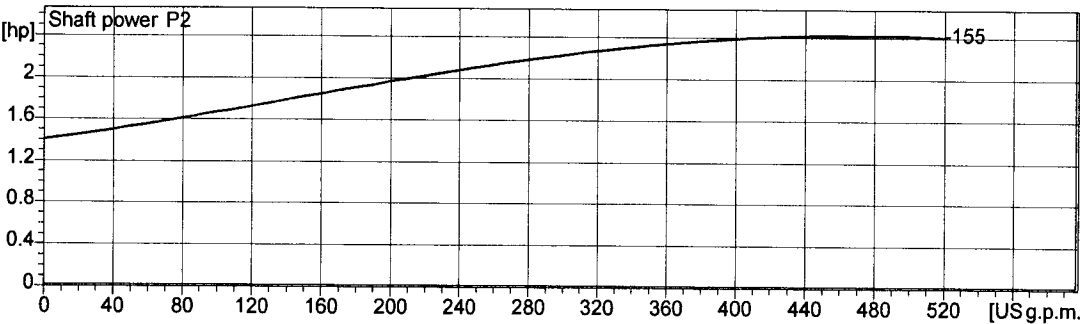
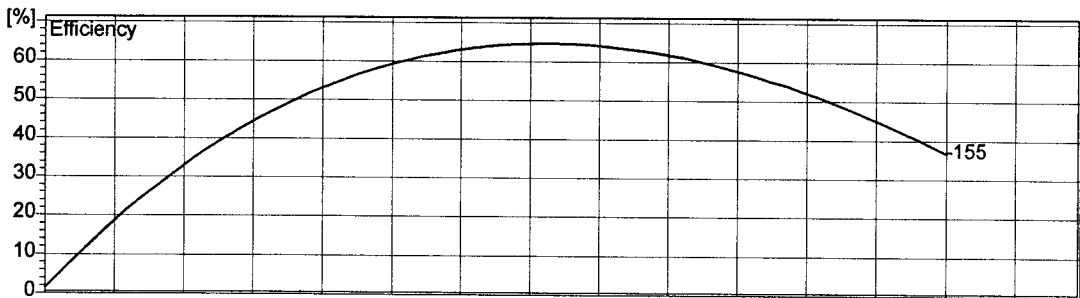
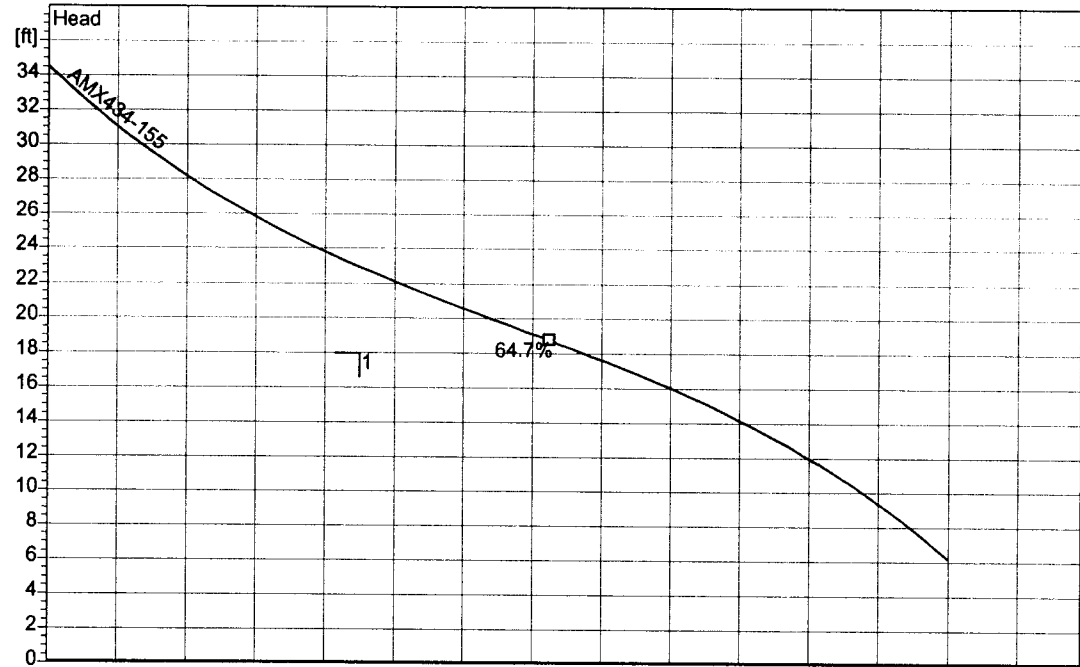

2.0 - 29.09.2004 (Build 60)

| | | | | |
|-------------------------------|--------------------------------------|---------------------------------|-------------------|----------------------------|
| Project Manatee Cty | Project no.: Item Number 9 | Created by: nackerman | Page: 2 | Date: 2005-09-14 |
|-------------------------------|--------------------------------------|---------------------------------|-------------------|----------------------------|

I&O Manual

1½", 2" & 3" Discharge

inches
(mm)

TOTAL METERS HEAD FEET

Lift Station 144

STANDARD IMPELLER SIZES

| Pump HP | Impeller Dia. |
|---------|---------------|
| 0.50 | 5.25 (133) |
| 0.75 | 5.62 (143) |
| 1.00 | 6.00 (152) |

Service Factor: 1.85

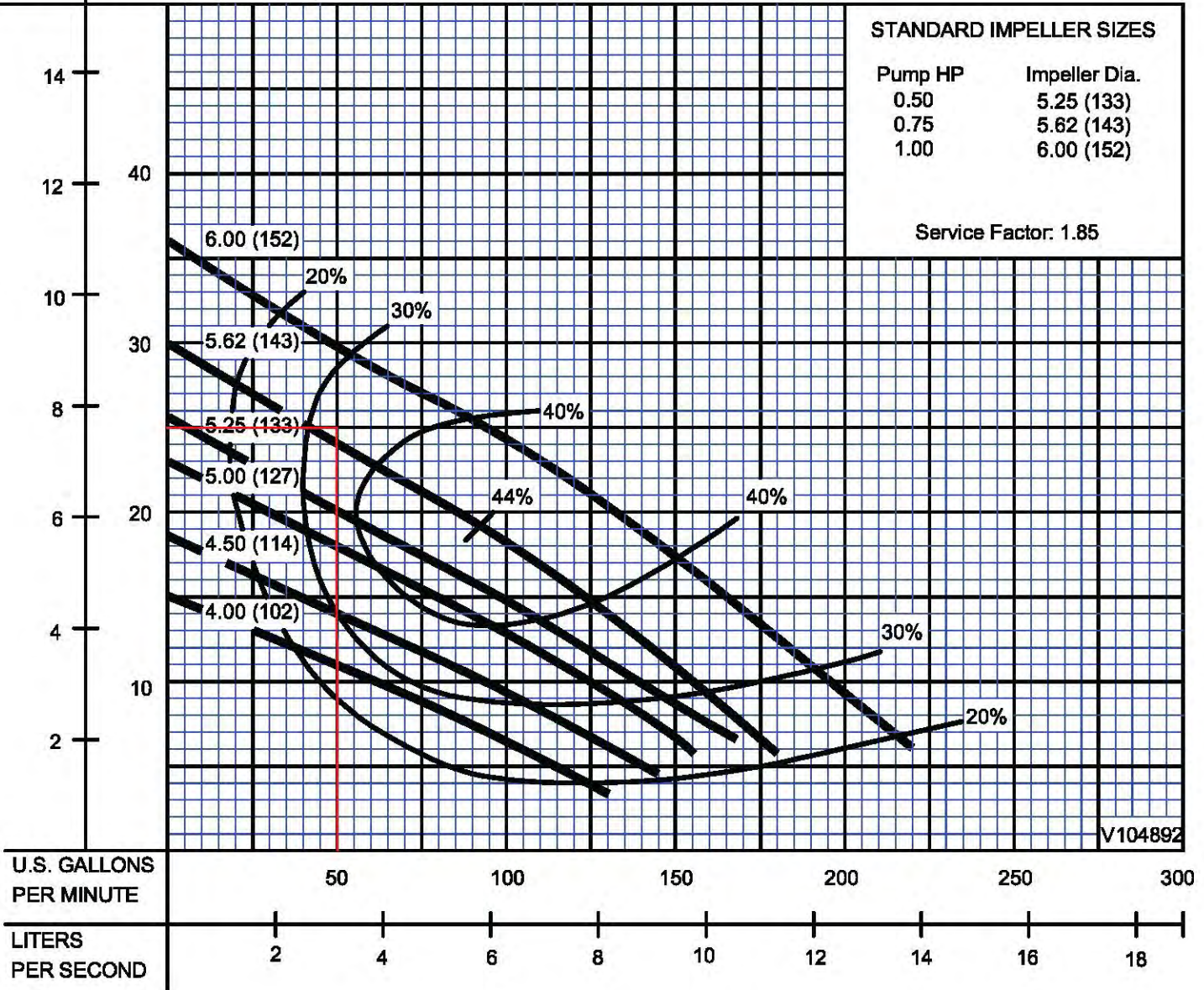

Testing is performed with water, specific gravity 1.0 @ 68° F @ (20°C), other fluids may vary performance

GPM: 50 TDH: 25

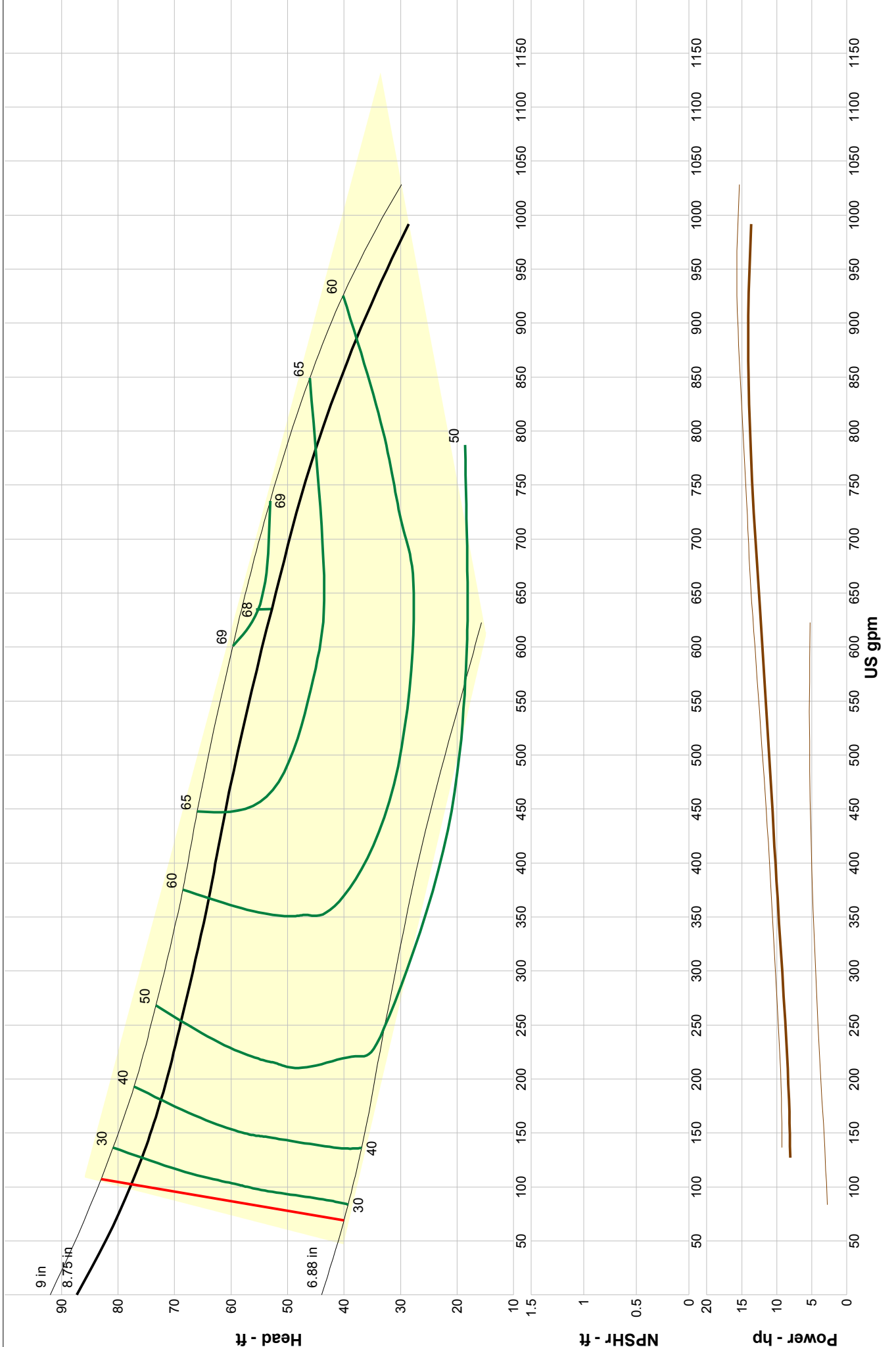

Size: S4M/S4MX
 Speed: 1750 rpm
 Dia: 8.75 in
 Curve: S4M1750

HYDROMATIC
 Catalog: Non-Clog Pumps 60Hz, Vers Feb 2006
 NCLOG-4 - 1800

Company: Manatee County Utilities
 Name: Palm Court - RTU 145
 4/9/2012





Performance Curve

AMX434-250/13P

West Glen (146)

Impeller

| | | | | | |
|---|-----------------------------|----|----------------------------|--------------------------|----------------------------|
| Impeller type: Single vane impeller | Solid size 3 1/8" | Ø: | Max. Ø: 9 13/16" | Min. Ø: 8 1/8" | Sel. Ø: 9 13/16" |
|---|-----------------------------|----|----------------------------|--------------------------|----------------------------|

Operating data

| | | | | |
|---------------------------|----------------------------|--|---------------------------------|-----------------------------------|
| Speed: 1700 rpm | Frequency: 60 Hz | Duty point: Q = 126 US g.p.m. H = 81 ft | Suction port: 4" ANSI | Discharge port: 4" ANSI |
|---------------------------|----------------------------|--|---------------------------------|-----------------------------------|

Power data referred to: Water, pure [100%] ; 68°F; 62.322lb/ft³; 1.0818E-5ft²/s Testnorm: **ISO 9906**

Curve number:

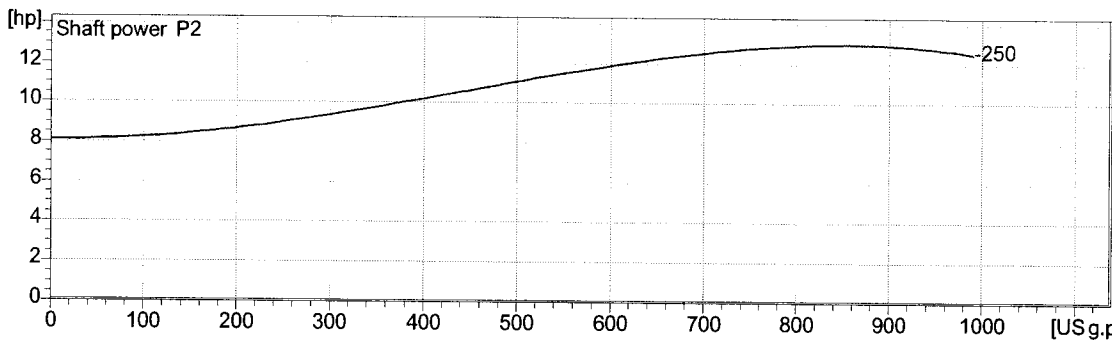
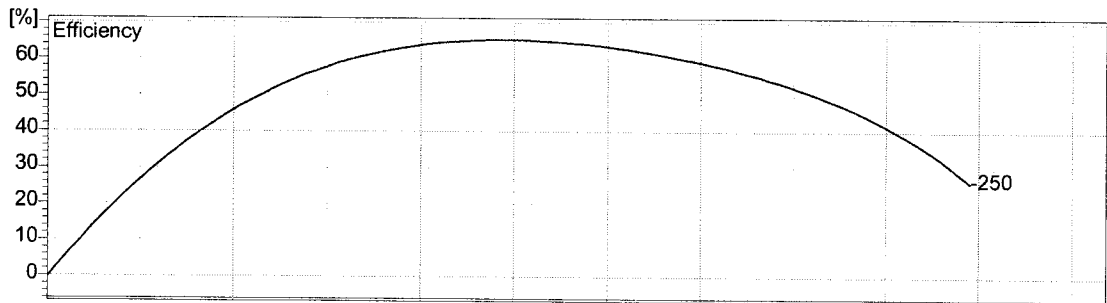
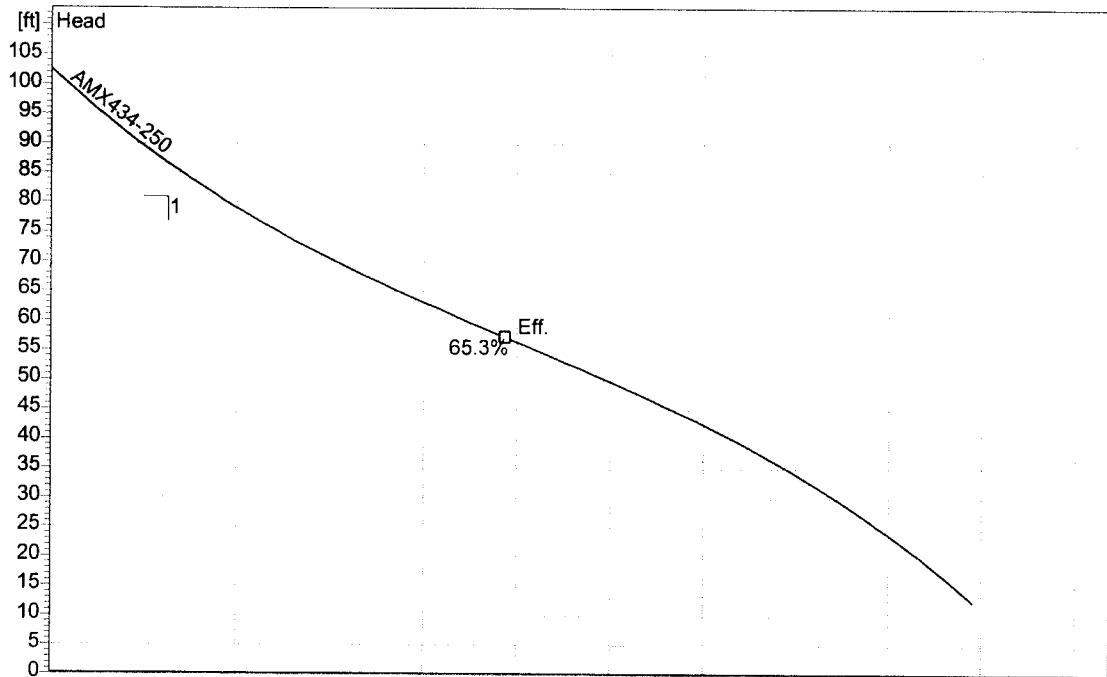

Project
Manatee Cty

Project no.:
Item Number 28

Created by:
nackerman

Page:
2

Date:
2005-09-14

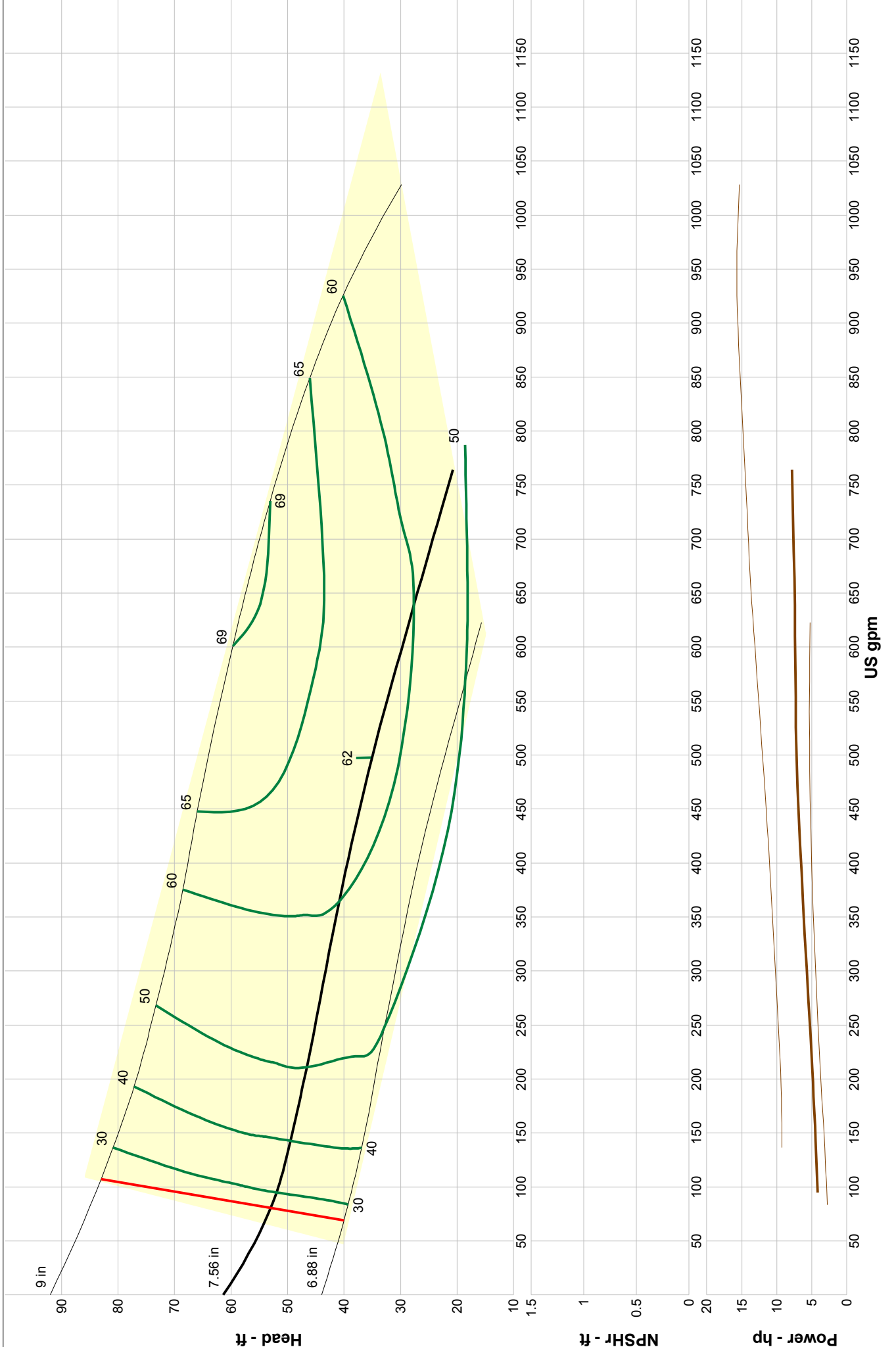

Company: Manatee County Utilities
 Name: The Loop - RTU 147
 4/9/2012

HYDROMATIC
 Catalog: Non-Clog Pumps 60Hz, Vers Feb 2006
 NCLOG-4 - 1800

Size: S4M/S4MX
 Speed: 1750 rpm
 Dia: 7.56 in
 Curve: S4M1750



Series: PF4NC-SS



4" Discharge, Submersible Non-Clog Pumps
 3" Spherical Solids, Single Seal

RTU 148

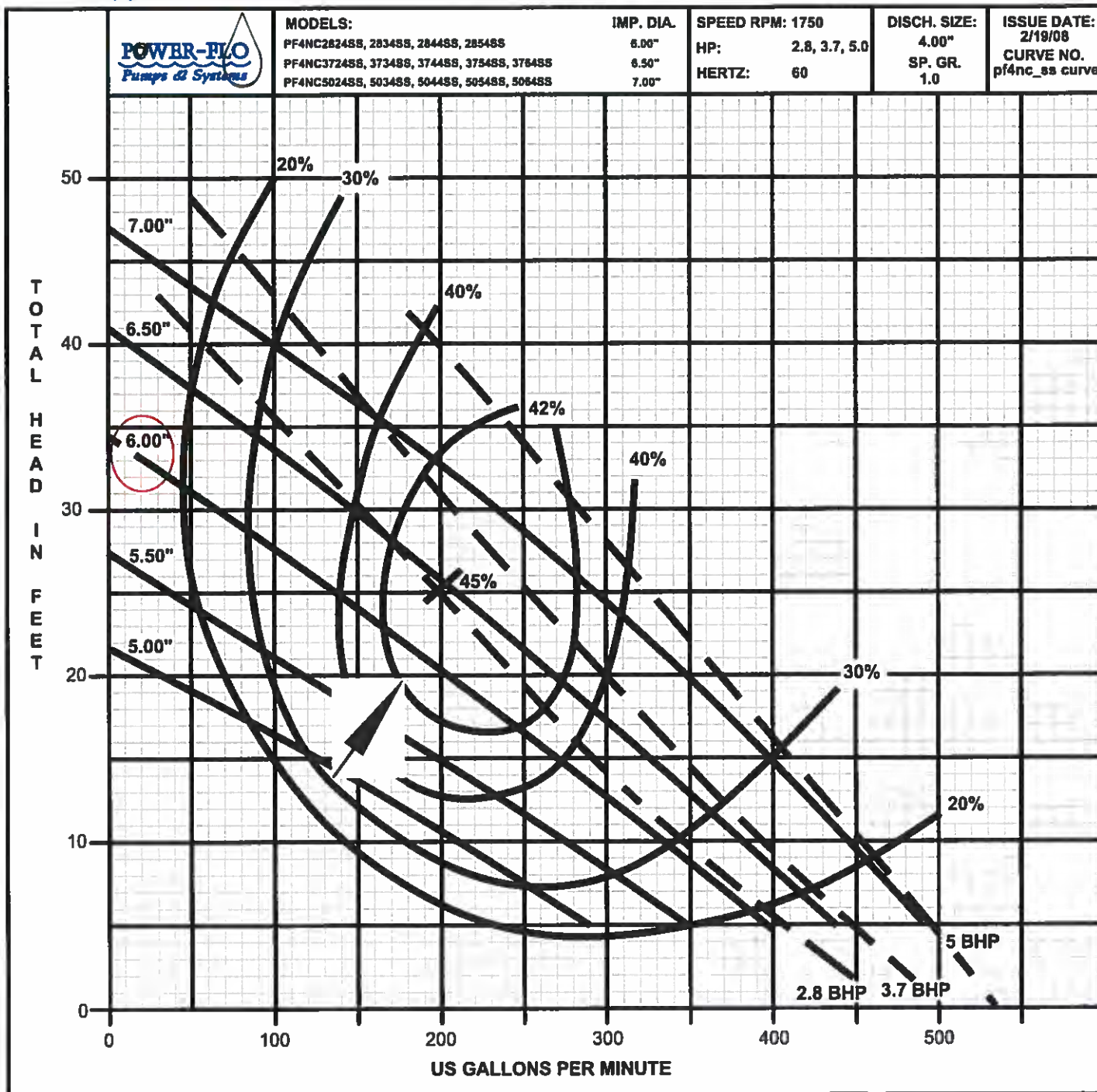

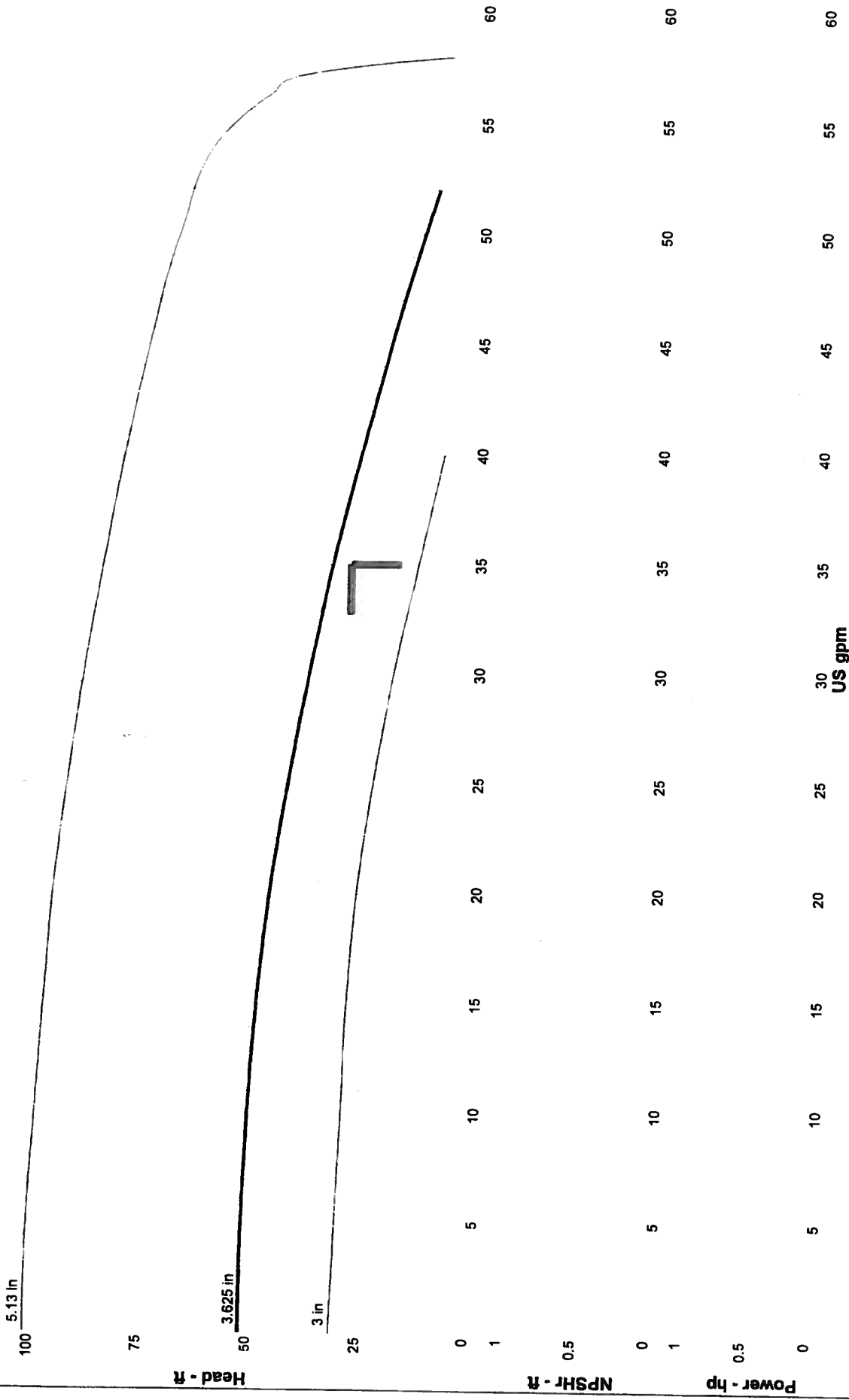

Temp. 160°F (71°C) Intermittent.

Company:
Name:
2/23/2015

Crane/Barnes
Catalog: Crane Barnes.60, Vers 4-14
Grinder - 3B - 3600
Design Point: 35 US gpm, 28 ft

Crosley Est (149)

Size: SGVF20*2L
Speed: 3450 rpm
Dia: 3.625 in
Curve: V110814

BARNES®



Pump performance curves AFP 1049 60 HZ

Curve number

Reference curve
AFP 1049

| | | | | |
|--------------------------------------|---|--------------------------------|-------------------------------|--------------------|
| BOLLETTIERI VILLAS LS (150) | | | Discharge DN100 | Frequency 60 Hz |
| Density 62.428 lb/ft ³ | Viscosity 0.000016813 ft ² /s | Testnom Hydraulic Institute | Rated speed 1735..1700 rpm | Date 2007-07-31 |
| Flow 335 US g.p.m. | Head 72.1 ft | Rated power 10 hp | Hydraulic efficiency 61 % | NPSH 4.5 ft |

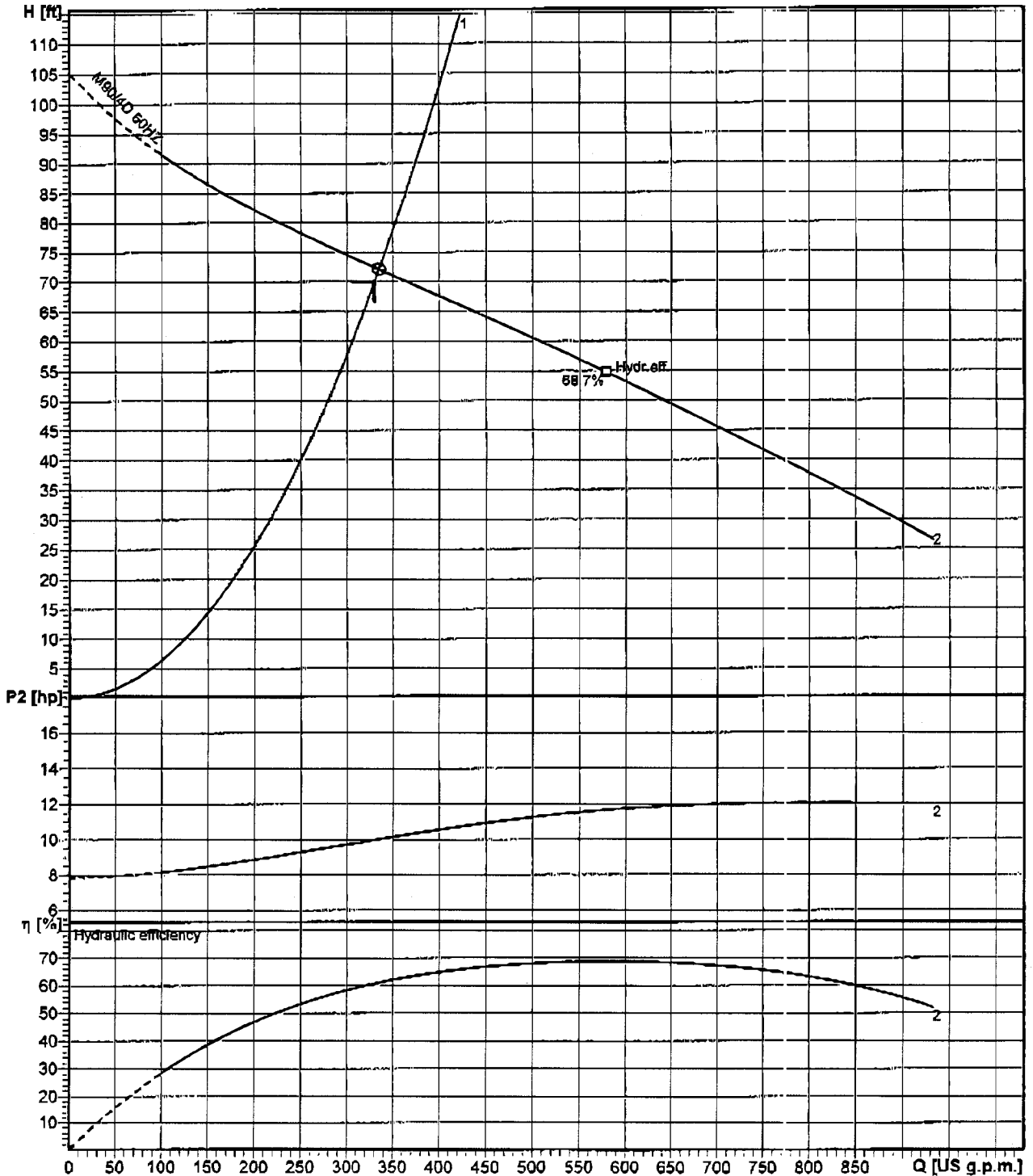

| | | | | |
|----------------------------------|------------------|--|----------------------|------------------------|
| Impeller size 9.96..8.82 inch | N° of vanes 1 | Impeller ContraBlock impeller, 1 vane | Solid size 3 1/8" | Revision 2006-01-24 |
|----------------------------------|------------------|--|----------------------|------------------------|

ABS reserves the right to change any data and dimensions without prior notice and can not be held responsible for the use of information contained in this software.

ABSEL PRO 1.7.1 / 2005-03-17

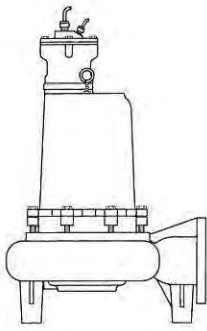

Lift Station 159

Performance Curve

S4P/S4PX

RPM: **1750** Discharge: **4"** Solids: **3"**

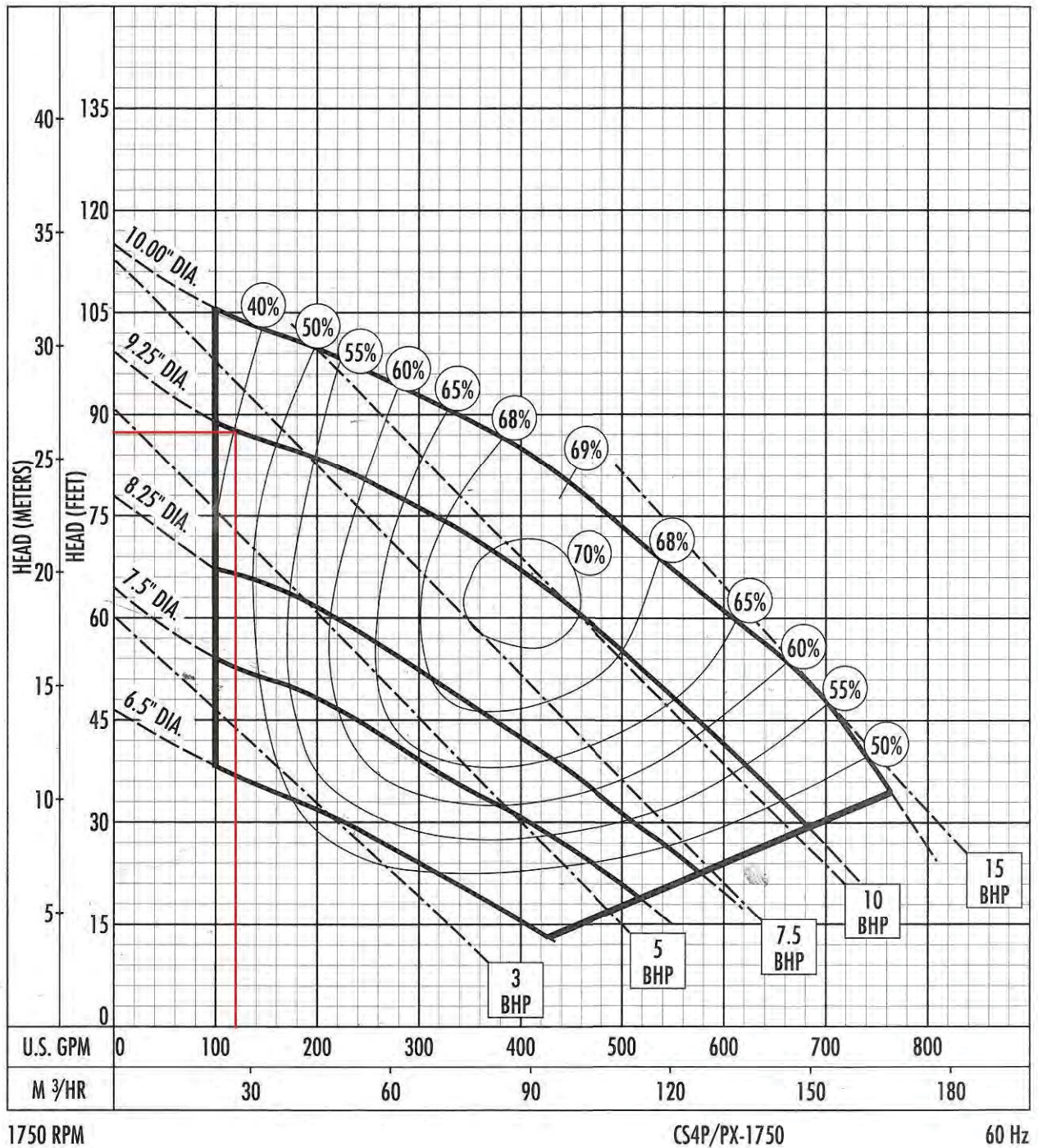

The curves reflect maximum performance characteristics without exceeding full load (Nameplate) horsepower. All pumps have a service factor of 1.2. Operation is recommended in the bounded area with operational point within the curve limit. Performance curves are based on actual tests with clear water at 70° F. and 1280 feet site elevation.

Performance Curve – S4M/S4MX

RPM: 1750 DISCHARGE: 4" SOLIDS: 3"

Lift Station 160 Option A: Hydromatic S4M, no data

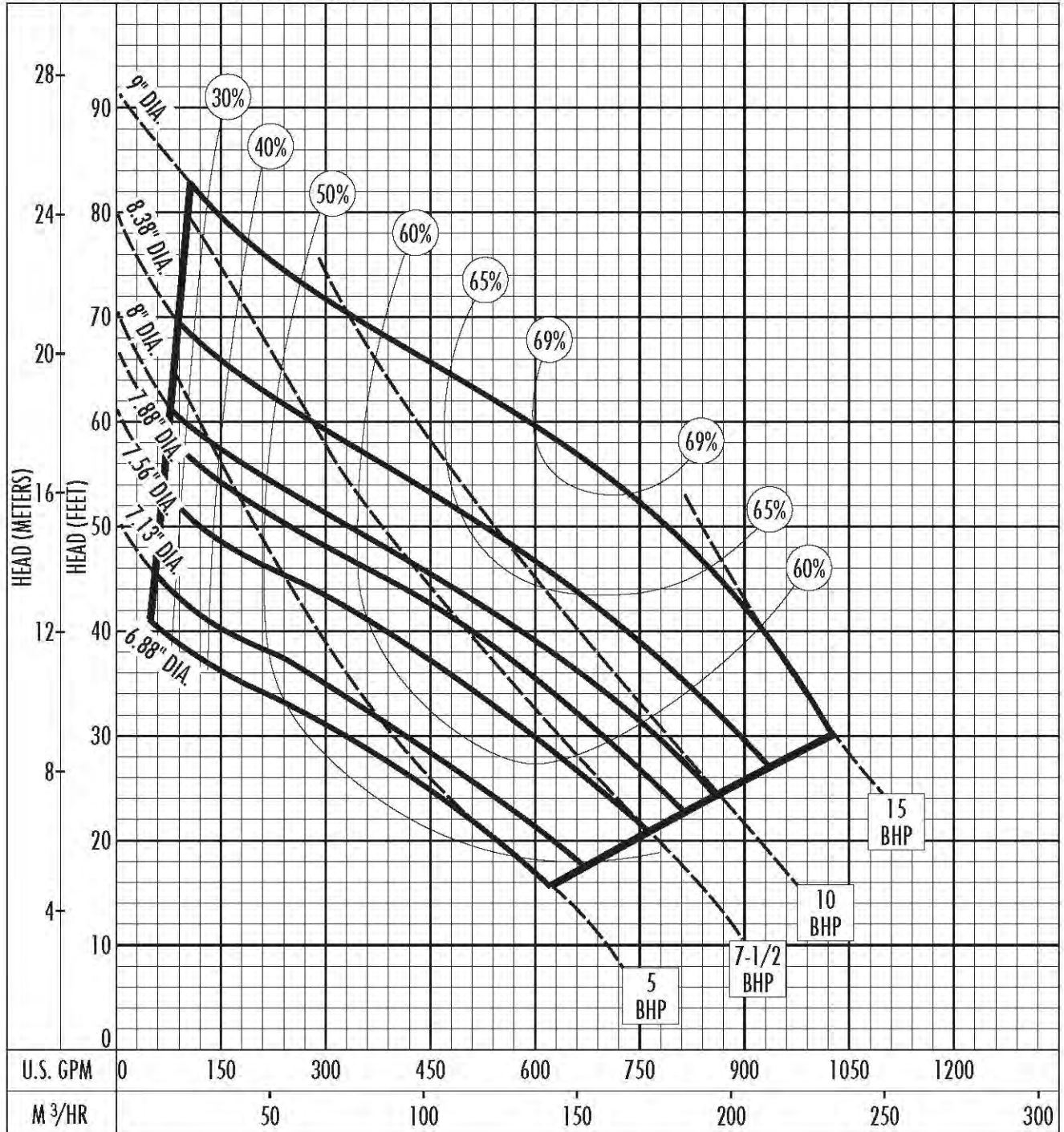

The curves reflect maximum performance characteristics without exceeding full load (Nameplate) horsepower. All pumps have a service factor of 1.2. Operation is recommended in the bounded area with operational point within the curve limit. Performance curves are based on actual tests with clear water at 70° F. and 1280 feet site elevation.

Conditions of Service:

Lift Station 160 Possibility B: Hydromatic SP50

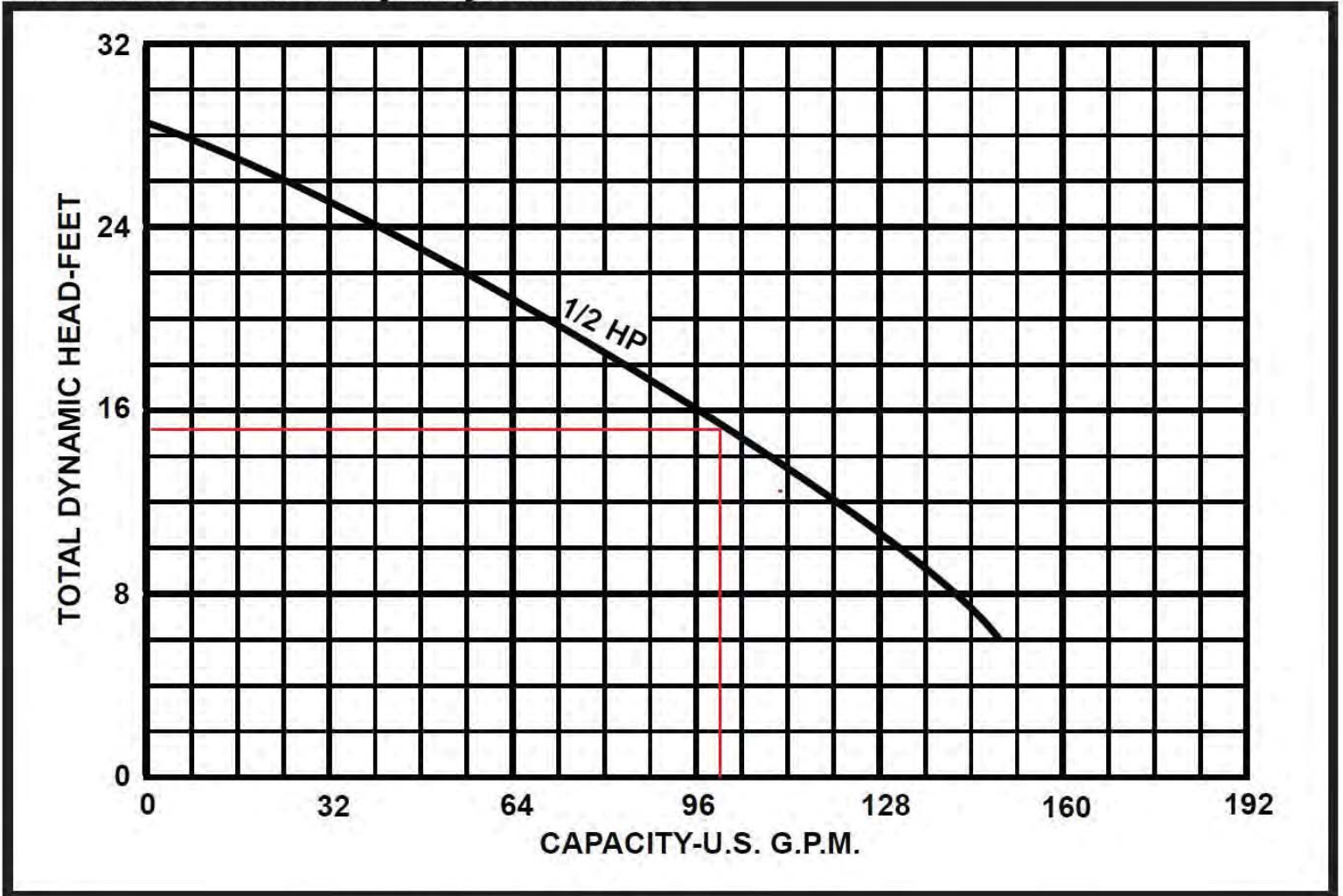

GPM: 104

TDH: 15'

Performance Curves

Project: **Lift Station 161** GPM: **31** TDH: **29** EFF: HP: Chk'd: Date:

32DGUII61.5S (2HP) Synchronous Speed: 3600 RPM

1 1/4 inch Discharge

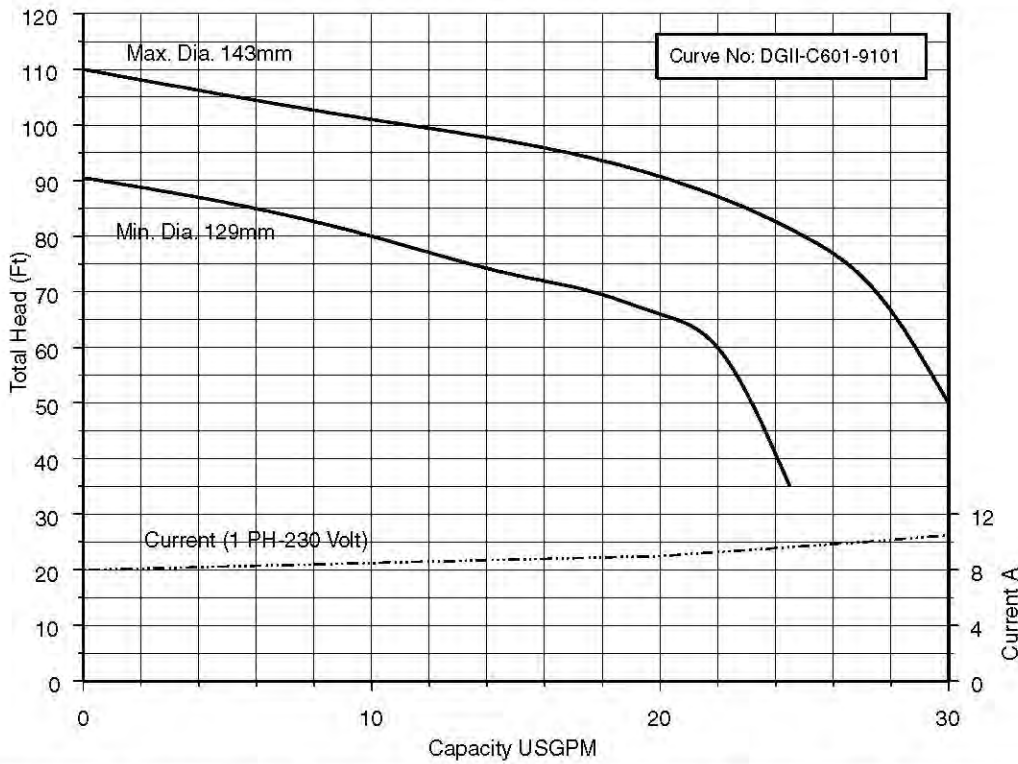

32DGF61.5S 32DGFU61.5 (2HP) Synchronous Speed: 3600 RPM 1 1/4 inch Discharge

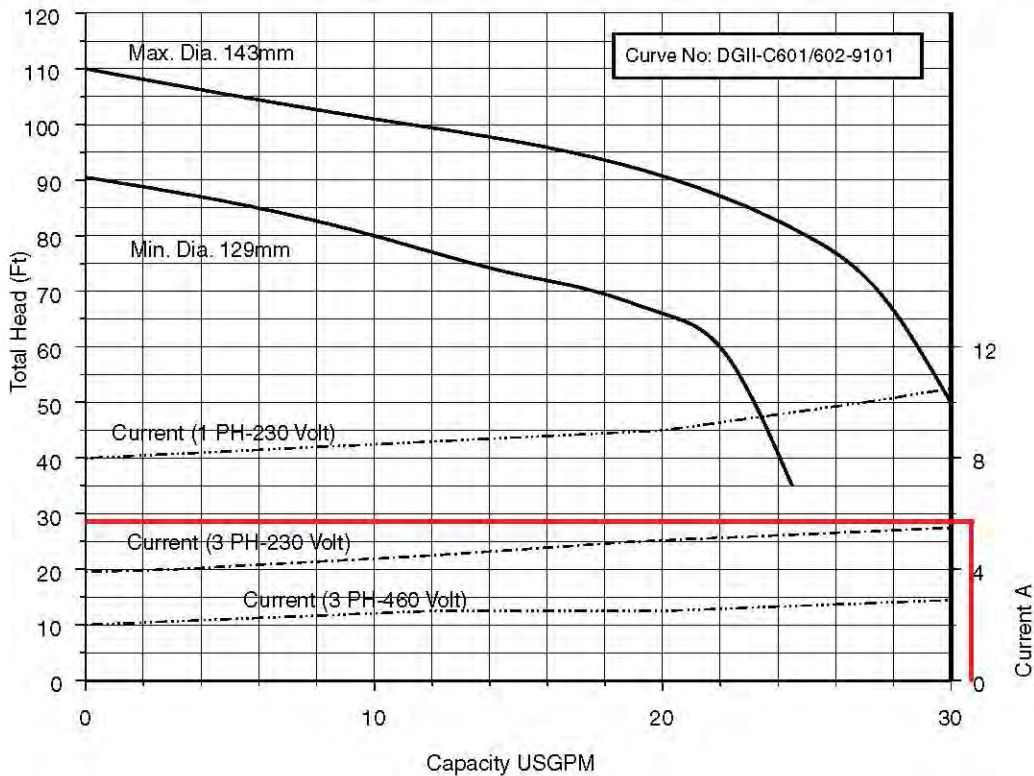

Lift Station 162

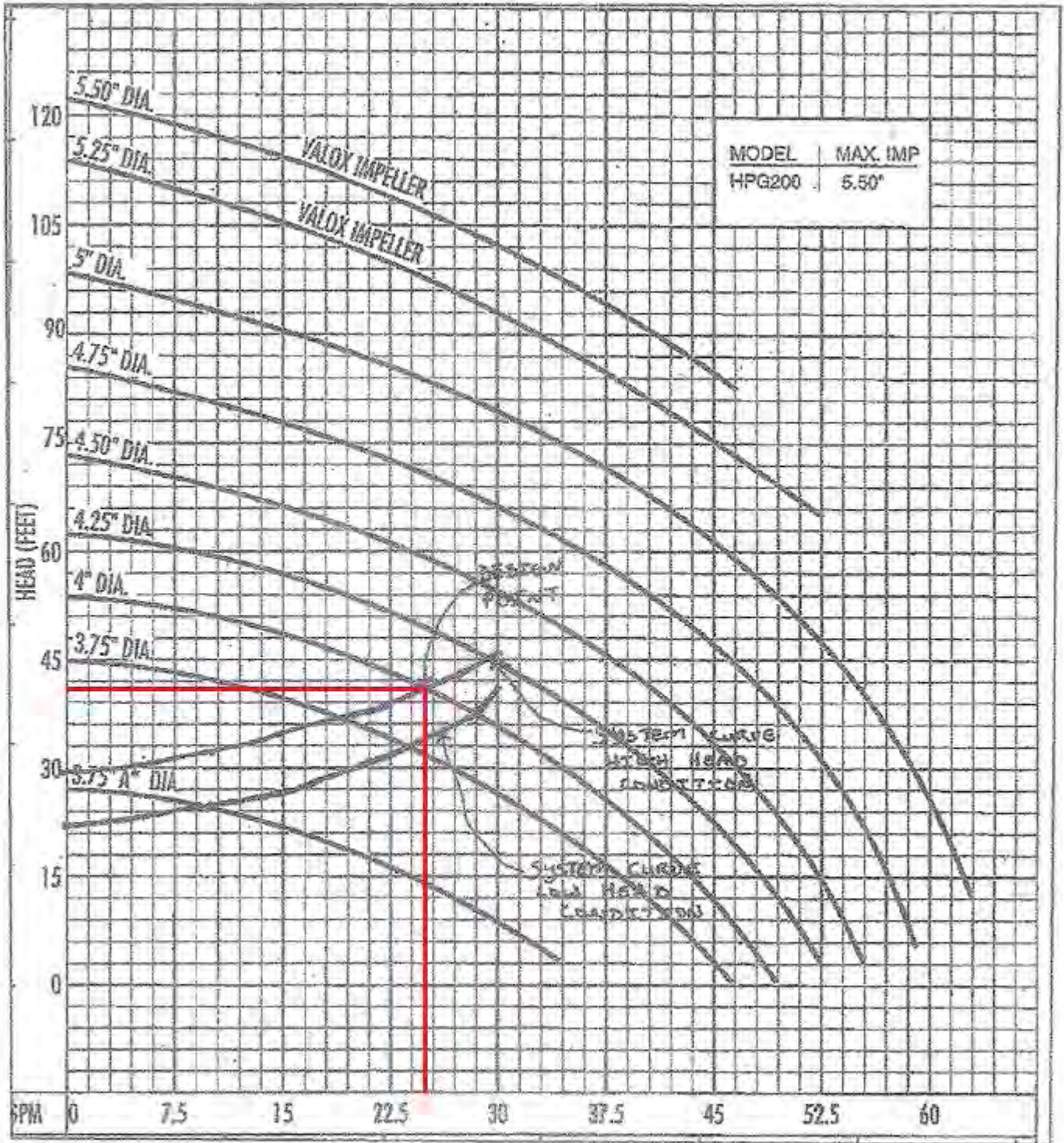

GPM: 25 TDH: 41

PUMP PERFORMANCE CURVE DATA (BUILDOUT)
N.T.S.

163

Performance Curve

HPGF/HPGFH

RPM: 1750

Discharge: 2"

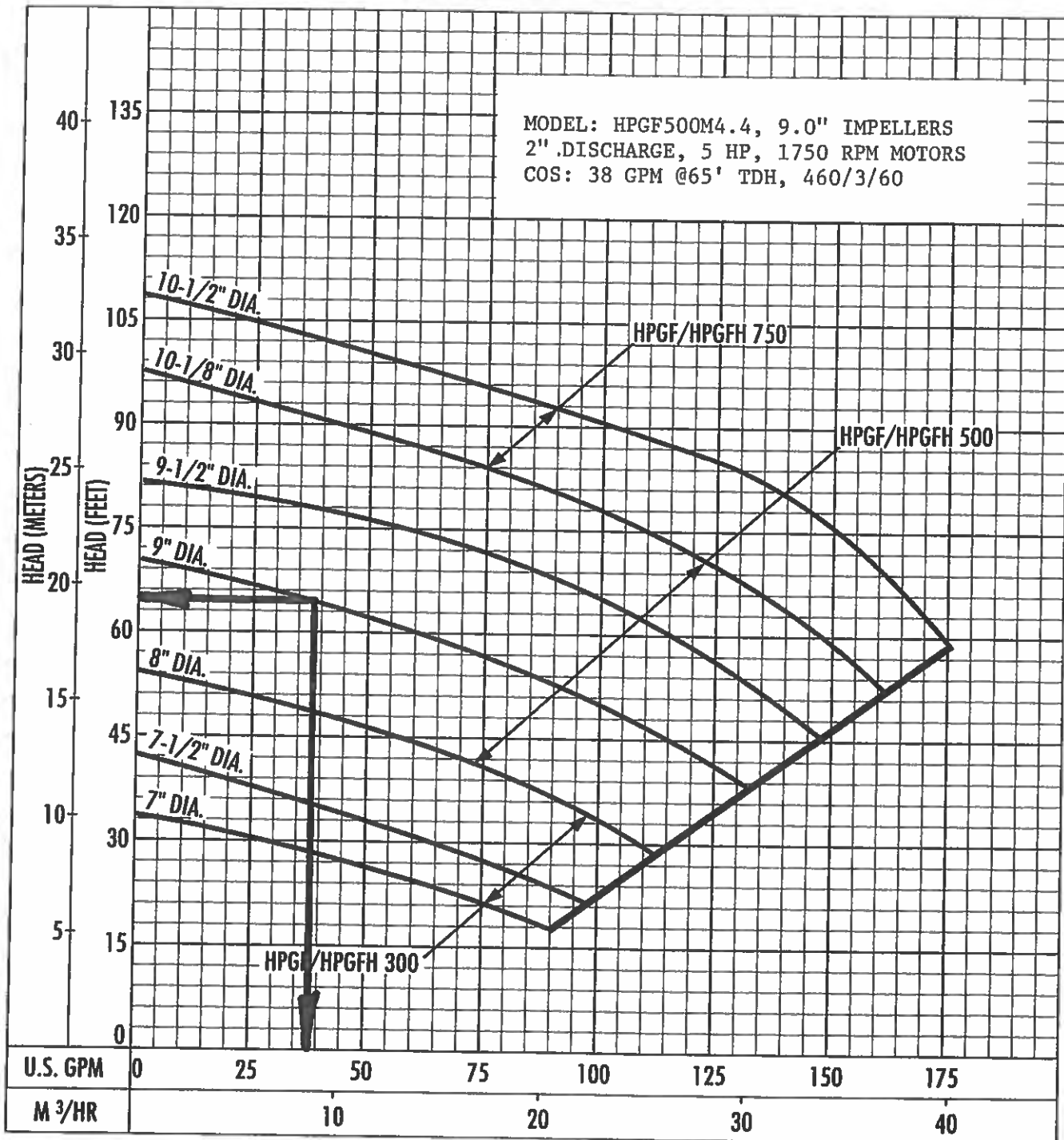
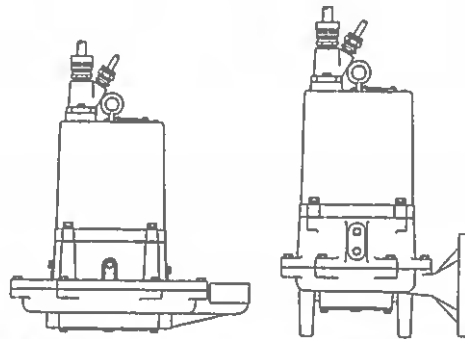

The curves reflect maximum performance characteristics without exceeding full load (Nameplate) horsepower. All pumps have a service factor of 1.2. Operation is recommended in the bounded area with operational point within the curve limit. Performance curves are based on actual tests with clear water at 70° F. and 1280 feet site elevation.



Conditions of Service:
 GPM: _____ TDH: _____

Performance Curve – S4N/S4NX

RPM: **1750** DISCHARGE: **4"** SOLIDS: **3"**

Lift Station 201

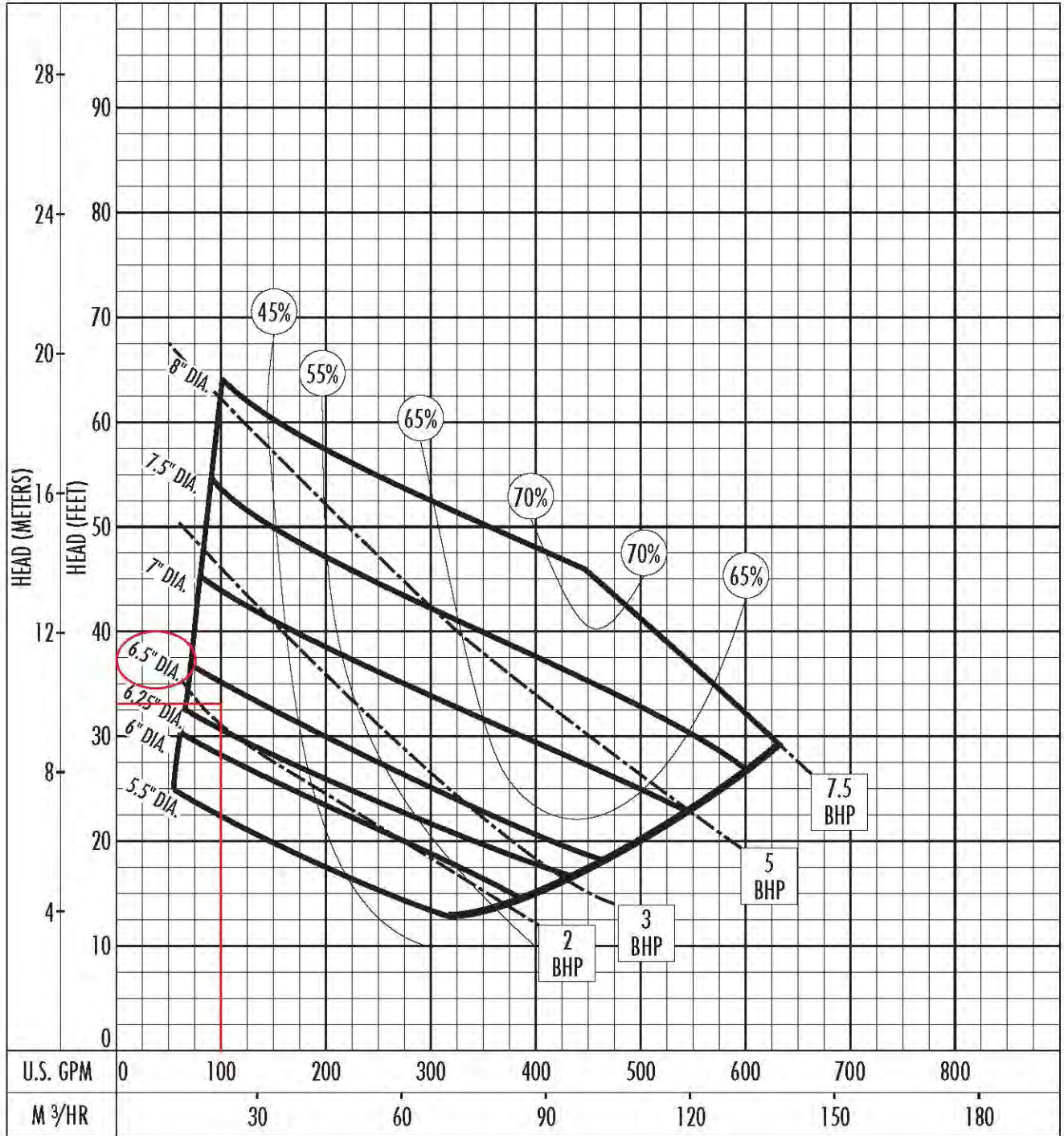

The curves reflect maximum performance characteristics without exceeding full load (Nameplate) horsepower. All pumps have a service factor of 1.2. Operation is recommended in the bounded area with operational point within the curve limit. Performance curves are based on actual tests with clear water at 70° F. and 1280 feet site elevation.

Conditions of Service:

Performance Curve – S4N/S4NX

RPM: **1750** DISCHARGE: **4"** SOLIDS: **3"**

Lift Station 202

Impeller 5.88"

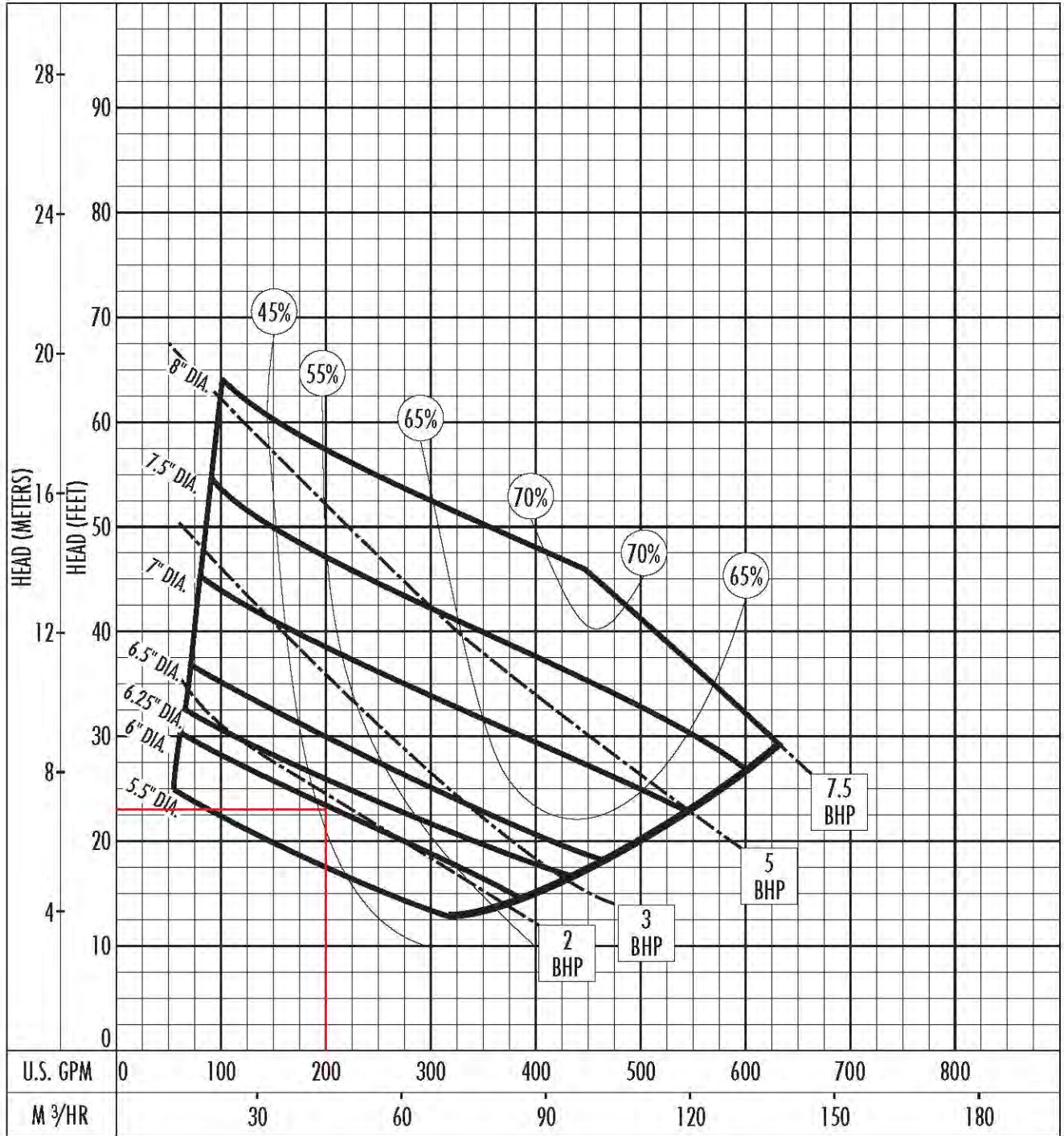

The curves reflect maximum performance characteristics without exceeding full load (Nameplate) horsepower. All pumps have a service factor of 1.2. Operation is recommended in the bounded area with operational point within the curve limit. Performance curves are based on actual tests with clear water at 70° F. and 1280 feet site elevation.

Conditions of Service:

1-M

S.O. 251423
UNIT No. 2
SANITARY SEWERAGE PROJECT
MANATEE COUNTY, FLORIDA

SECTION III - SEWAGE LIFT STATIONS
STATION IM - MECH SECTIONS
PART A



METROSE PARK, ILLINOIS

CHARACTERISTIC CURVE No. 8967

PUMP: 18 SOLIDS: 6" IMPELLER V-1831-C

RATING 5100 U. S. GALLONS PER MIN.

TOTAL DYN. HEAD: 67 FEET

SPEED: 885 RPM DATE: 5-6-74 APP

Guardians: Proves Specified Rating Only as recommended by the Hydraulic Institute. Standards: With handling capacity, cold fresh water at a temperature of not over 89° F. and not over 15 ft. suction lift.

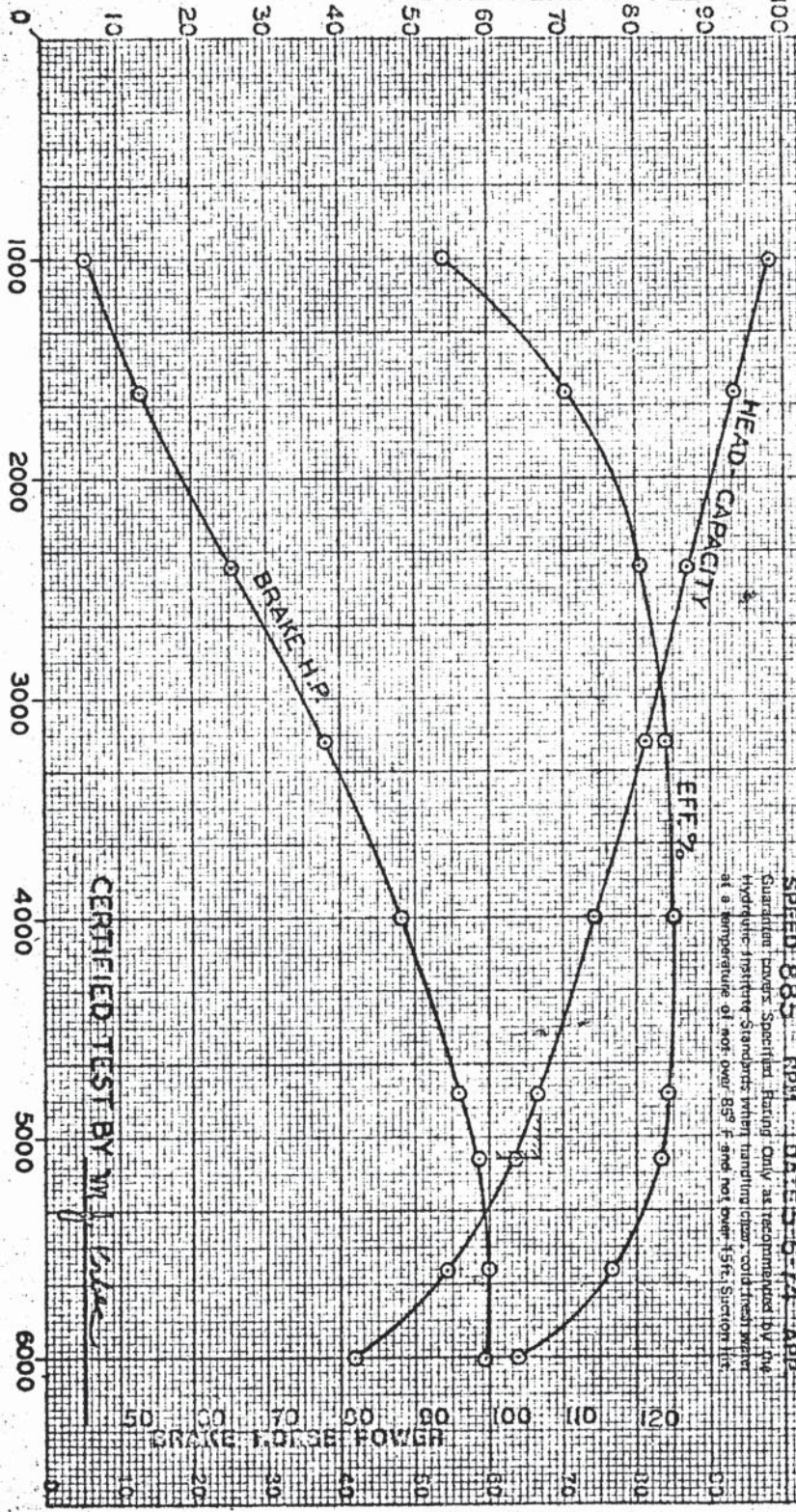

CERTIFIED TEST BY *MM*

FOR 18 8188 9-73 WATER

CAPACITY IN U. S. GALLONS PER MINUTE

V. B. FORM 518

FORM - 1012

Performance Curve

AMX434-178/4D/C

| Impeller | | | | | | |
|---|-----------------------------|--|--------------------------|---------------------------|----------------------|-----------------------------------|
| Impeller type: Single channel impeller | Solid size 3 inch | Ø: | Max. Ø: 8 1/8" | Min. Ø: 5 9/16" | Sel. Ø: 7" | |
| Operating data | | | | | | |
| Speed: 1750 rpm | Frequency: 60 Hz | Duty point: Q = 240 US g.p.m. H = 22 ft | | | Suction port: | Discharge port: 4" ANSI |
| Power data referred to: Water, pure [100%]; 68°F; 62.322lb/ft³; 1.0818E-5ft²/s | | | | | Testnorm: | ISO 9906 |

Curve number:

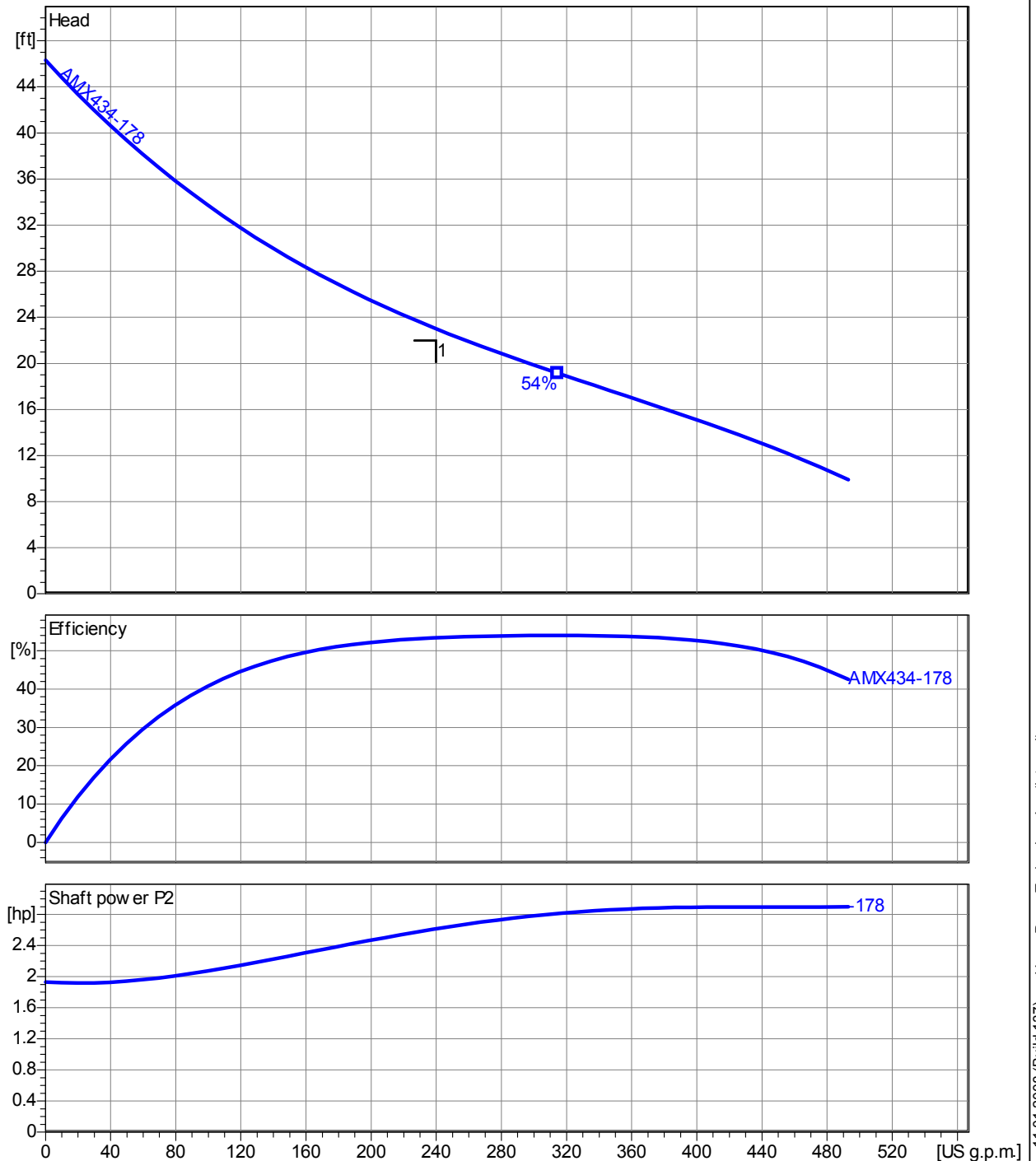

2.0 - 11.01.2008 (Build 137) Homa Pump Technology Inc. (internal)

| | | | | |
|--|---------------------------------|----------------------------------|-------------------|--------------------------|
| Project Man. Cty IFB #09-0897-OV | Project no.: San Remo | Created by: nyackerman | Page: 2 | Date: 4/4/2009 |
|--|---------------------------------|----------------------------------|-------------------|--------------------------|

Performance Curve

AMX434-178/4D/C

| Impeller | | | | | | |
|---|-----------------------------|--|--------------------------|---------------------------|----------------------|-----------------------------------|
| Impeller type: Single channel impeller | Solid size 3 inch | Ø: | Max. Ø: 8 1/8" | Min. Ø: 5 9/16" | Sel. Ø: 7" | |
| Operating data | | | | | | |
| Speed: 1750 rpm | Frequency: 60 Hz | Duty point: Q = 240 US g.p.m. H = 22 ft | | | Suction port: | Discharge port: 4" ANSI |
| Power data referred to: Water, pure [100%]; 68°F; 62.322lb/ft³; 1.0818E-5ft²/s | | | | | Testnorm: | ISO 9906 |

Curve number:

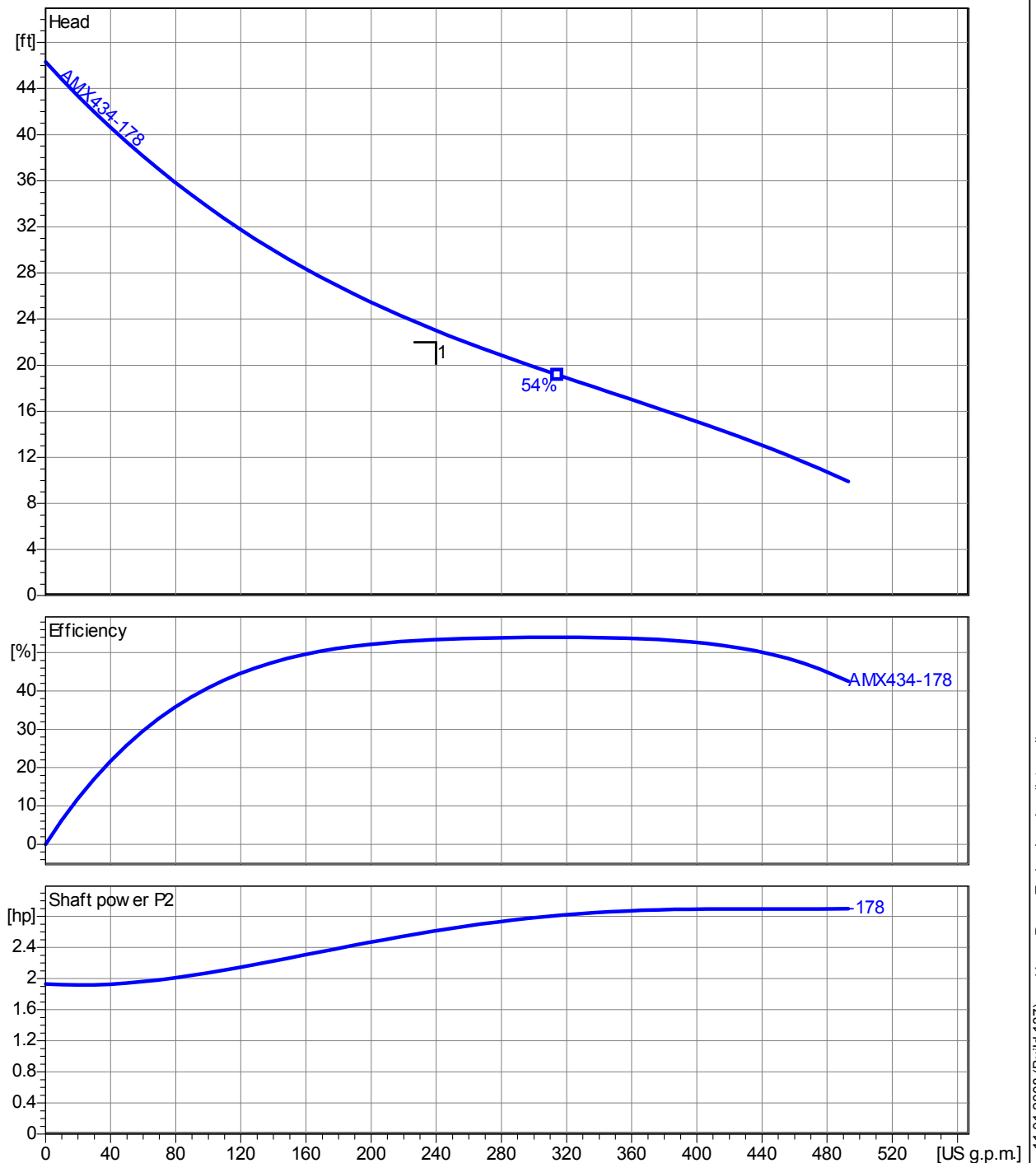

2.0 - 11.01.2008 (Build 137) Homa Pump Technology Inc. (internal)

| | | | | |
|--|---------------------------------|----------------------------------|-------------------|--------------------------|
| Project Man. Cty IFB #09-0897-OV | Project no.: San Remo | Created by: nyackerman | Page: 2 | Date: 4/4/2009 |
|--|---------------------------------|----------------------------------|-------------------|--------------------------|

Performance Curve

AMX434-184/4D/C

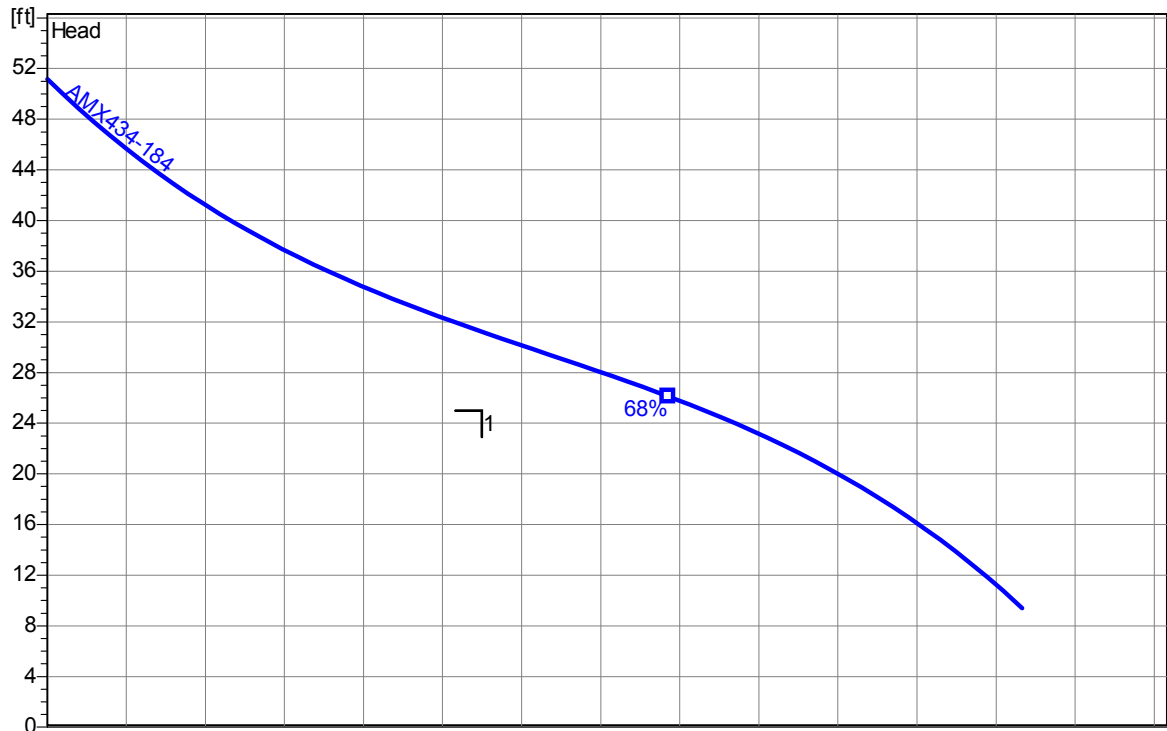
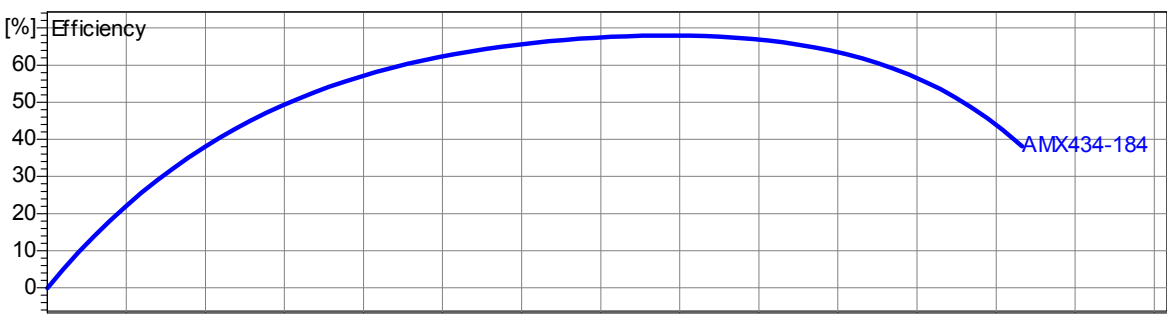
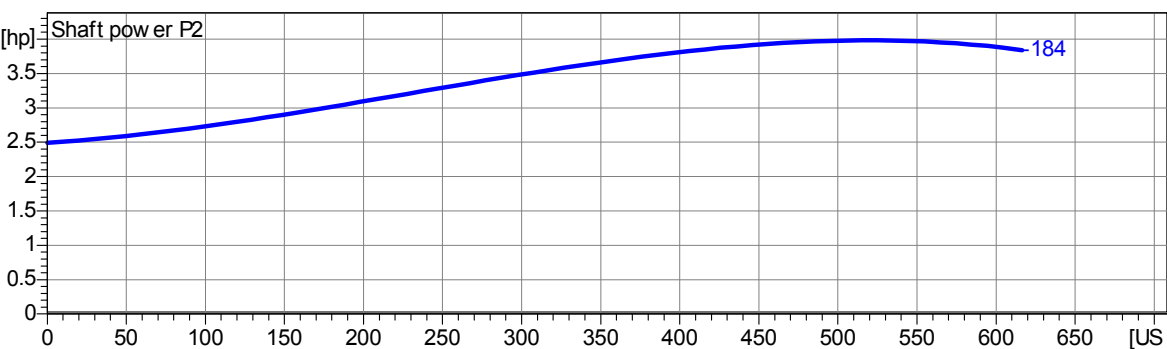
| Impeller | | | | | |
|---|---------------------------------|--|---|--|---|
| Impeller type: Single channel impeller | Solid size 3 inch | Ø: | Max. Ø: 8¹/₈" | Min. Ø: 5⁹/₁₆" | Sel. Ø: 7¹/₄" |
| Operating data | | | | | |
| Speed: 1750 rpm | Frequency: 60 Hz | Duty point: Q = 275 US g.p.m. H = 25 ft | | Suction port: | Discharge port: 4" ANSI |
| Power data referred to: Water, pure [100%]; 68°F; 62.322lb/ft ³ ; 1.0818E-5ft ² /s | | | | Testnorm: | ISO 9906 |
| Curve number: | | | | | |
|  | | | | | |
|  | | | | | |
|  | | | | | |
| Project Man. Cty IFB #09-0897-OV | Project no.: LS # 2-M | | Created by: nyackerman | Page: 2 | Date: 4/1/2009 |

Performance Curve

AMX434-155/4D/C

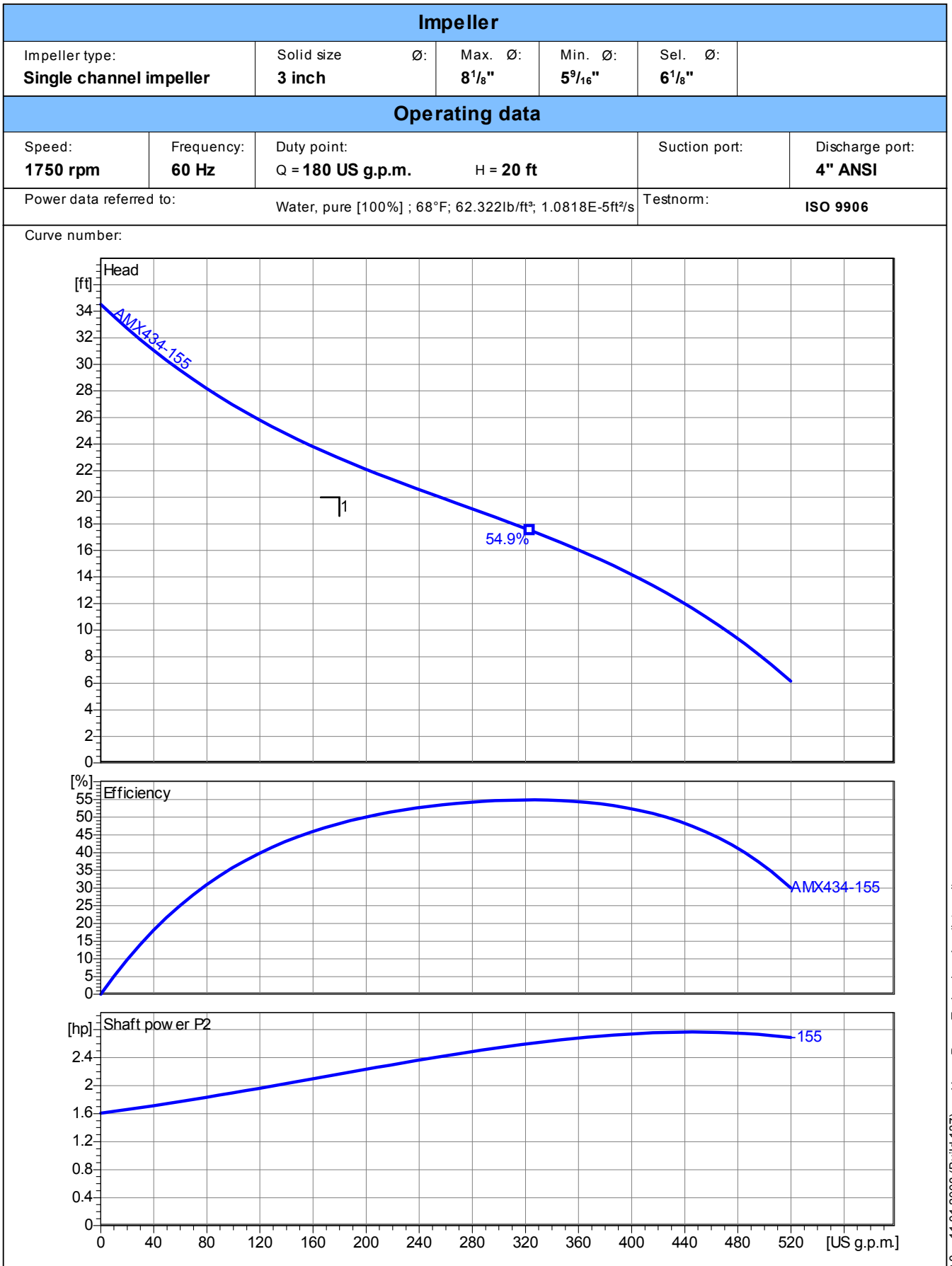

2.0 - 11.01.2008 (Build 137) Homa Pump Technology Inc. (internal)

| | | | | |
|--|---------------------------------|----------------------------------|-------------------|--------------------------|
| Project Man. Cty IFB #09-0897-OV | Project no.: LS # 3-M | Created by: nyackerman | Page: 2 | Date: 4/1/2009 |
|--|---------------------------------|----------------------------------|-------------------|--------------------------|

Performance Curve – S4M/S4MX

RPM: **1750** DISCHARGE: **4"** SOLIDS: **3"**

Lift Station 207

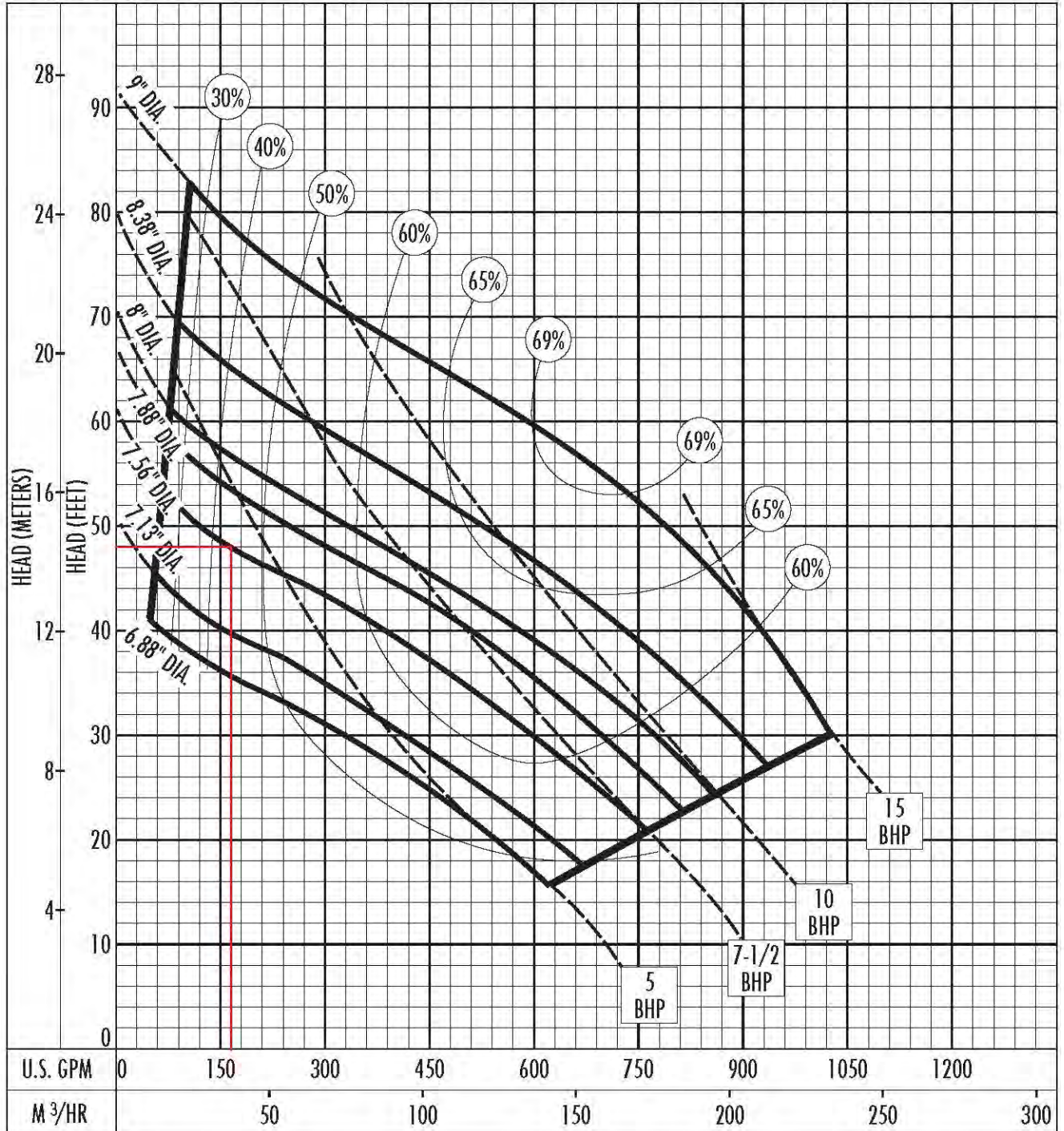

The curves reflect maximum performance characteristics without exceeding full load (Nameplate) horsepower. All pumps have a service factor of 1.2. Operation is recommended in the bounded area with operational point within the curve limit. Performance curves are based on actual tests with clear water at 70° F. and 1280 feet site elevation.

Conditions of Service:

Performance Curve – S4N/S4NX

RPM: **1750** DISCHARGE: **4"** SOLIDS: **3"**

Lift Station 208

Impeller 8.25"

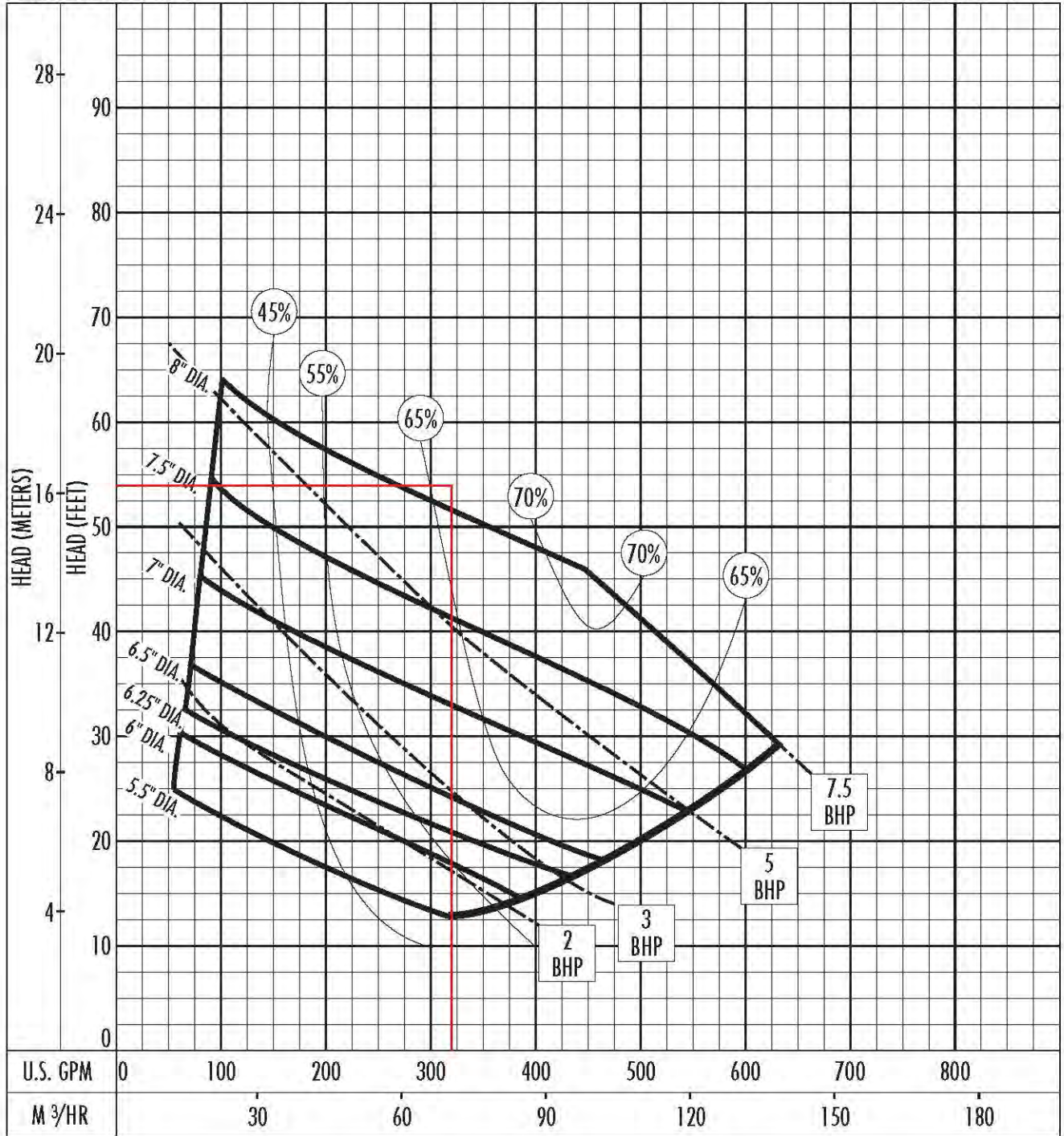

The curves reflect maximum performance characteristics without exceeding full load (Nameplate) horsepower. All pumps have a service factor of 1.2. Operation is recommended in the bounded area with operational point within the curve limit. Performance curves are based on actual tests with clear water at 70° F. and 1280 feet site elevation.

Conditions of Service:

Performance Curve – S4N/S4NX

RPM: **1750** DISCHARGE: **4"** SOLIDS: **3"**

Lift Station 210

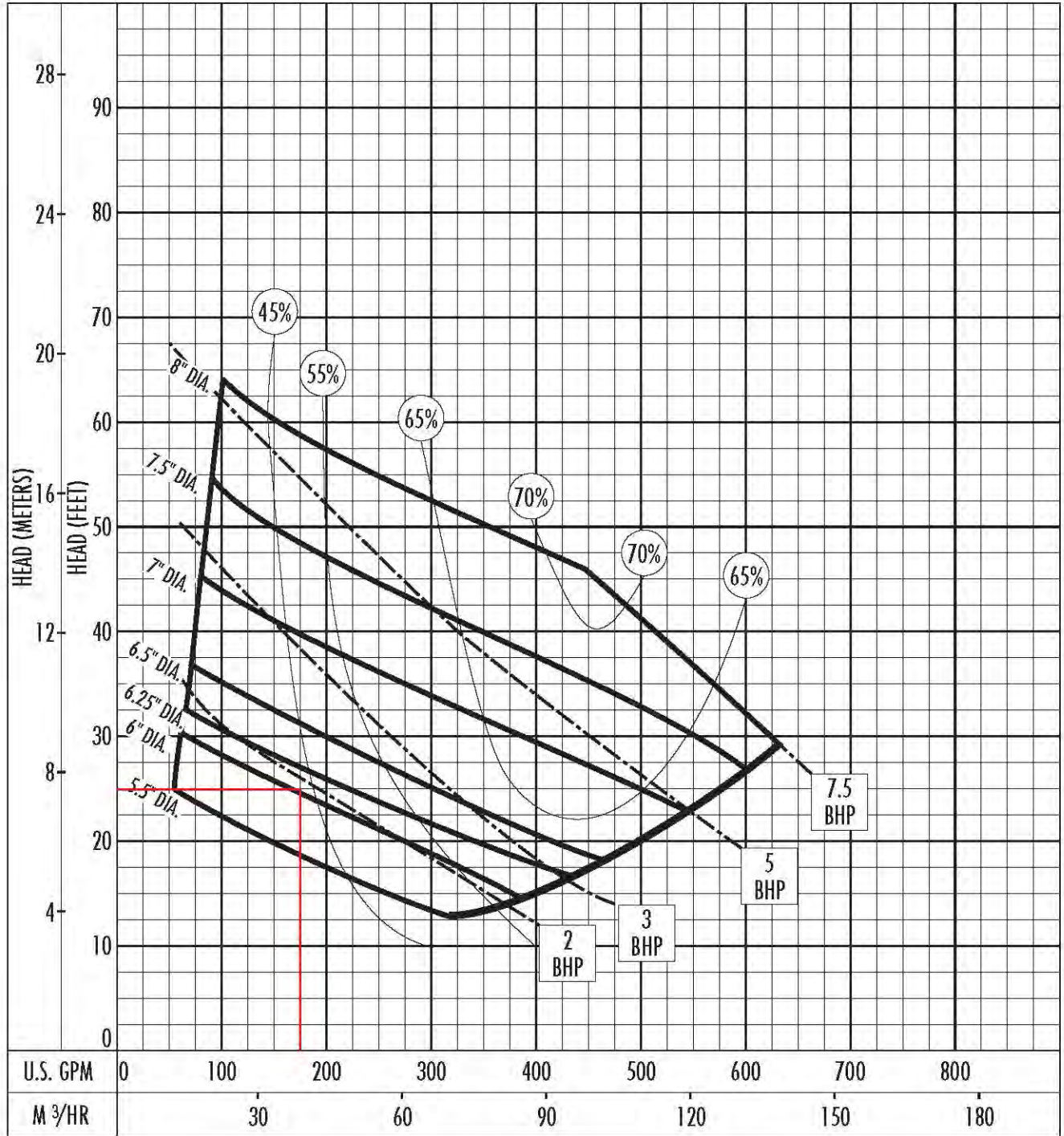

The curves reflect maximum performance characteristics without exceeding full load (Nameplate) horsepower. All pumps have a service factor of 1.2. Operation is recommended in the bounded area with operational point within the curve limit. Performance curves are based on actual tests with clear water at 70° F. and 1280 feet site elevation.

Conditions of Service:

Performance Curve

AMX434-178/4D/C

| Impeller | | | | | | |
|---|-----------------------------|--|--------------------------|---------------------------|----------------------|-----------------------------------|
| Impeller type: Single channel impeller | Solid size 3 inch | Ø: | Max. Ø: 8 1/8" | Min. Ø: 5 9/16" | Sel. Ø: 7" | |
| Operating data | | | | | | |
| Speed: 1750 rpm | Frequency: 60 Hz | Duty point: Q = 200 US g.p.m. H = 25 ft | | | Suction port: | Discharge port: 4" ANSI |
| Power data referred to: Water, pure [100%]; 68°F; 62.322lb/ft³; 1.0818E-5ft²/s | | | | | Testnorm: | ISO 9906 |

Curve number:

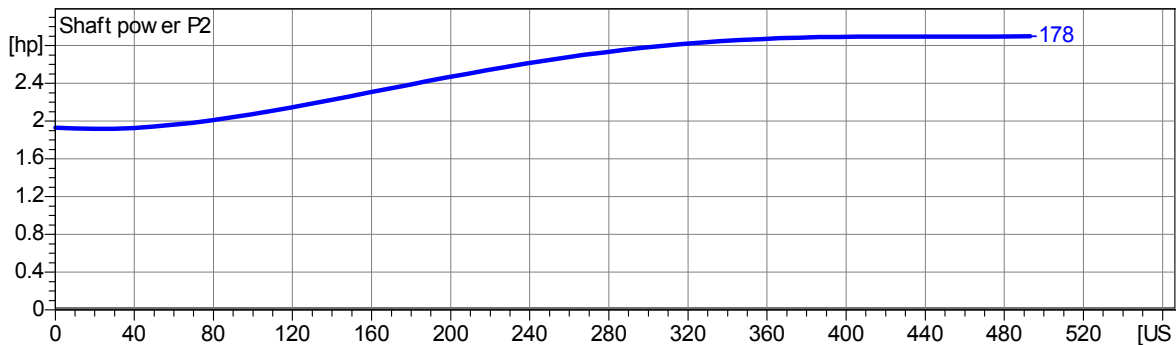
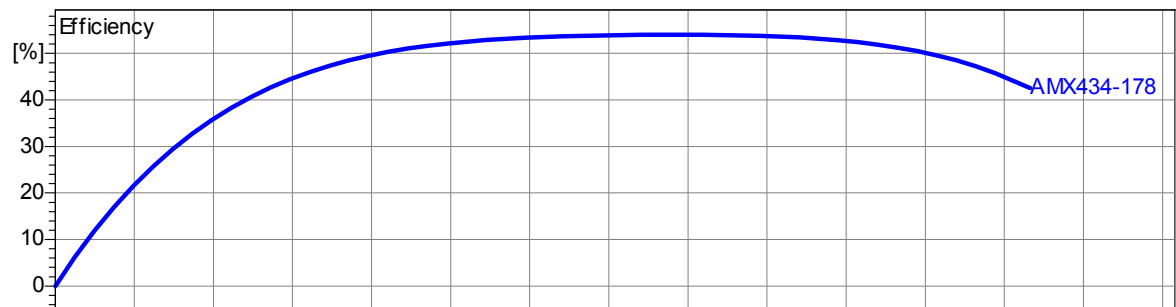
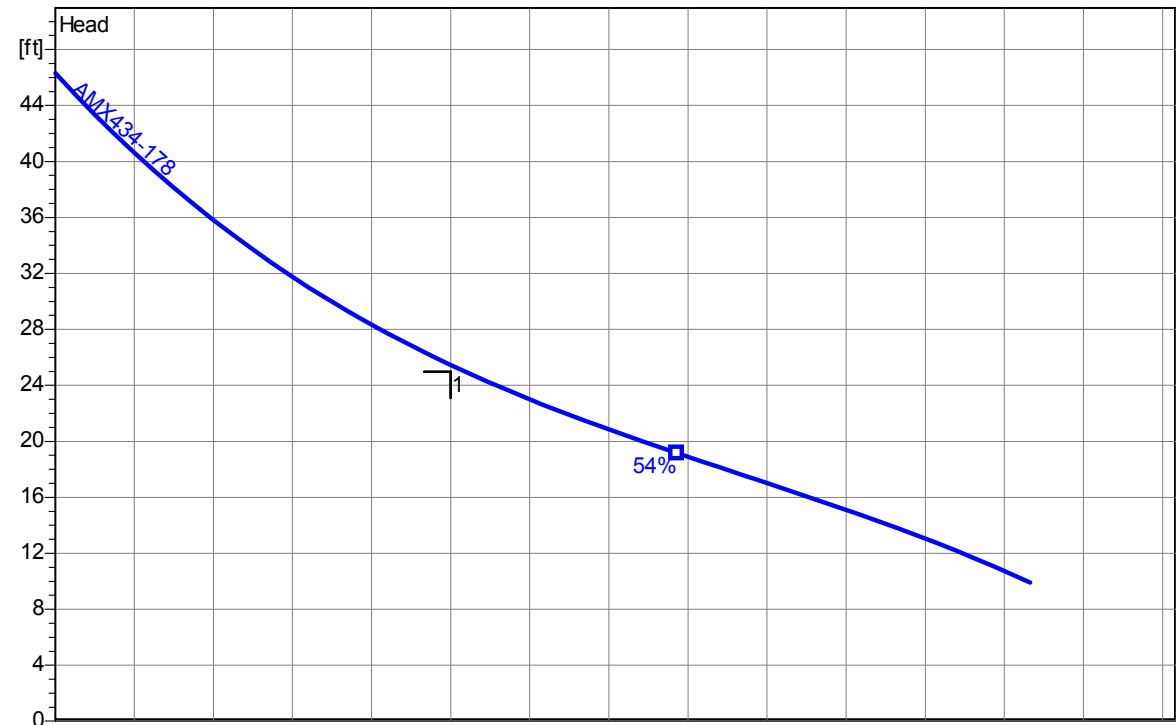

| | | | | |
|--|----------------------------------|----------------------------------|-------------------|--------------------------|
| Project Man. Cty IFB #09-0897-OV | Project no.: LS # 16-D | Created by: nyackerman | Page: 2 | Date: 4/1/2009 |
|--|----------------------------------|----------------------------------|-------------------|--------------------------|

CP 3085 MT 3~ 434
VFD Curve

GPM: 100 TDH: 26.1

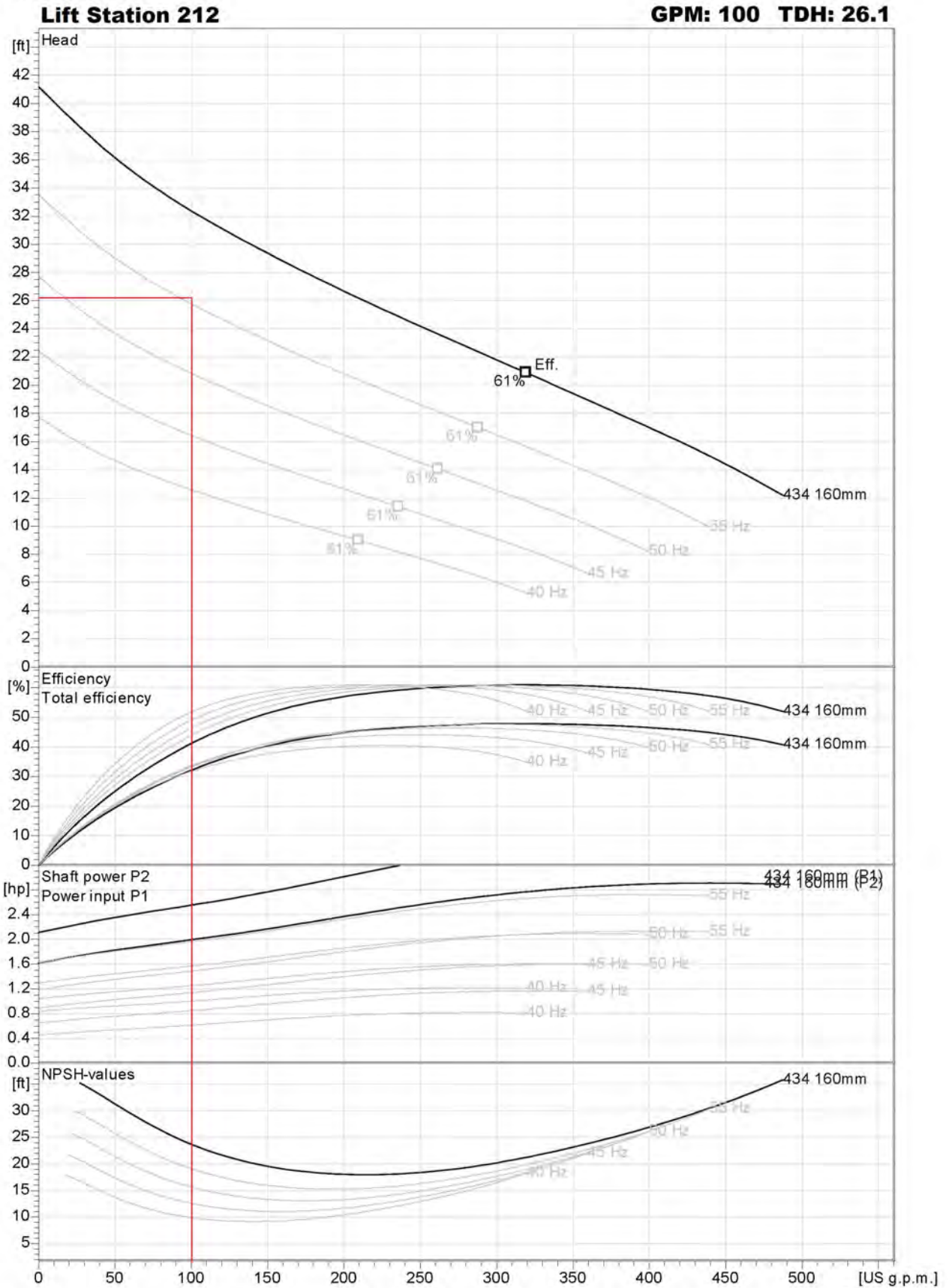

| Project | Project ID | Created by | Created on | Last update |
|---------|------------|------------|------------|-------------|
| | | | 2015-07-13 | |

Performance Curve

AMX434-178/4D/C

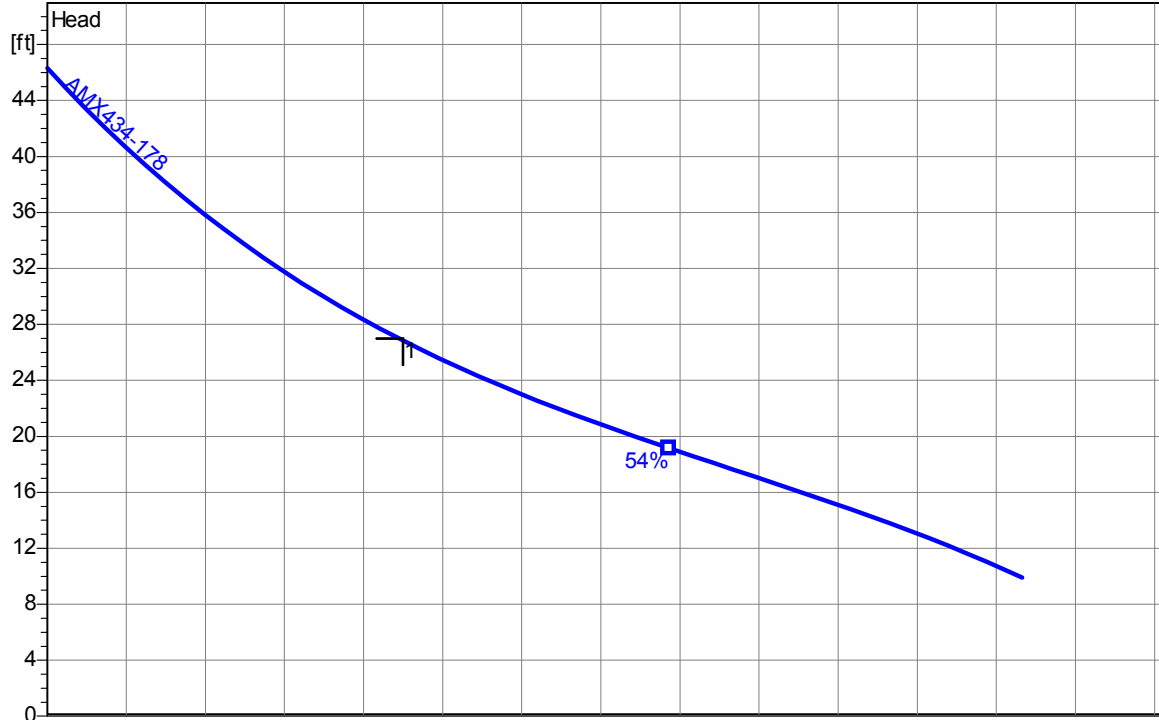
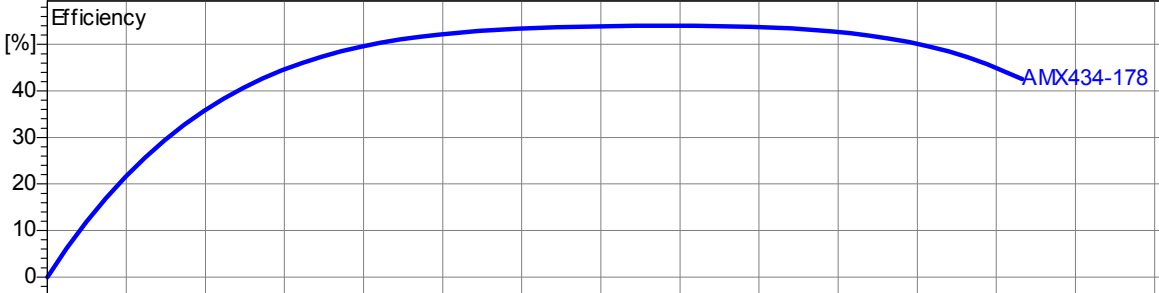
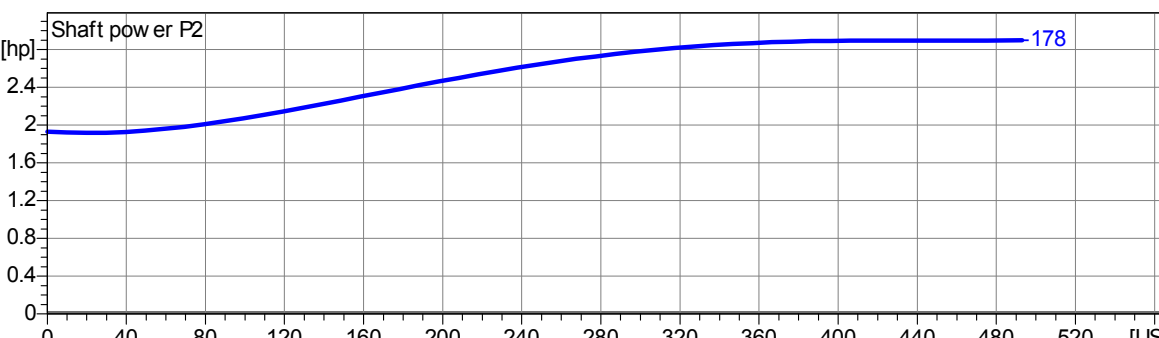
| Impeller | | | | | |
|--|-------------------------------------|--|----------------------------------|---------------------------|-----------------------------------|
| Impeller type: Single channel impeller | Solid size 3 inch | Ø: | Max. Ø: 8 1/8" | Min. Ø: 5 9/16" | Sel. Ø: 7" |
| Operating data | | | | | |
| Speed: 1750 rpm | Frequency: 60 Hz | Duty point: Q = 180 US g.p.m. H = 27 ft | | Suction port: | Discharge port: 4" ANSI |
| Power data referred to: Water, pure [100%]; 68°F; 62.322lb/ft³; 1.0818E-5ft²/s | | | | Testnorm: | ISO 9906 |
| Curve number: | | | | | |
|  | | | | | |
|  | | | | | |
|  | | | | | |
| Project Man. Cty IFB #09-0897-OV | Project no.: Spanish Park | | Created by: nyackerman | Page: 2 | Date: 4/4/2009 |

Submersible Grinder Pumps

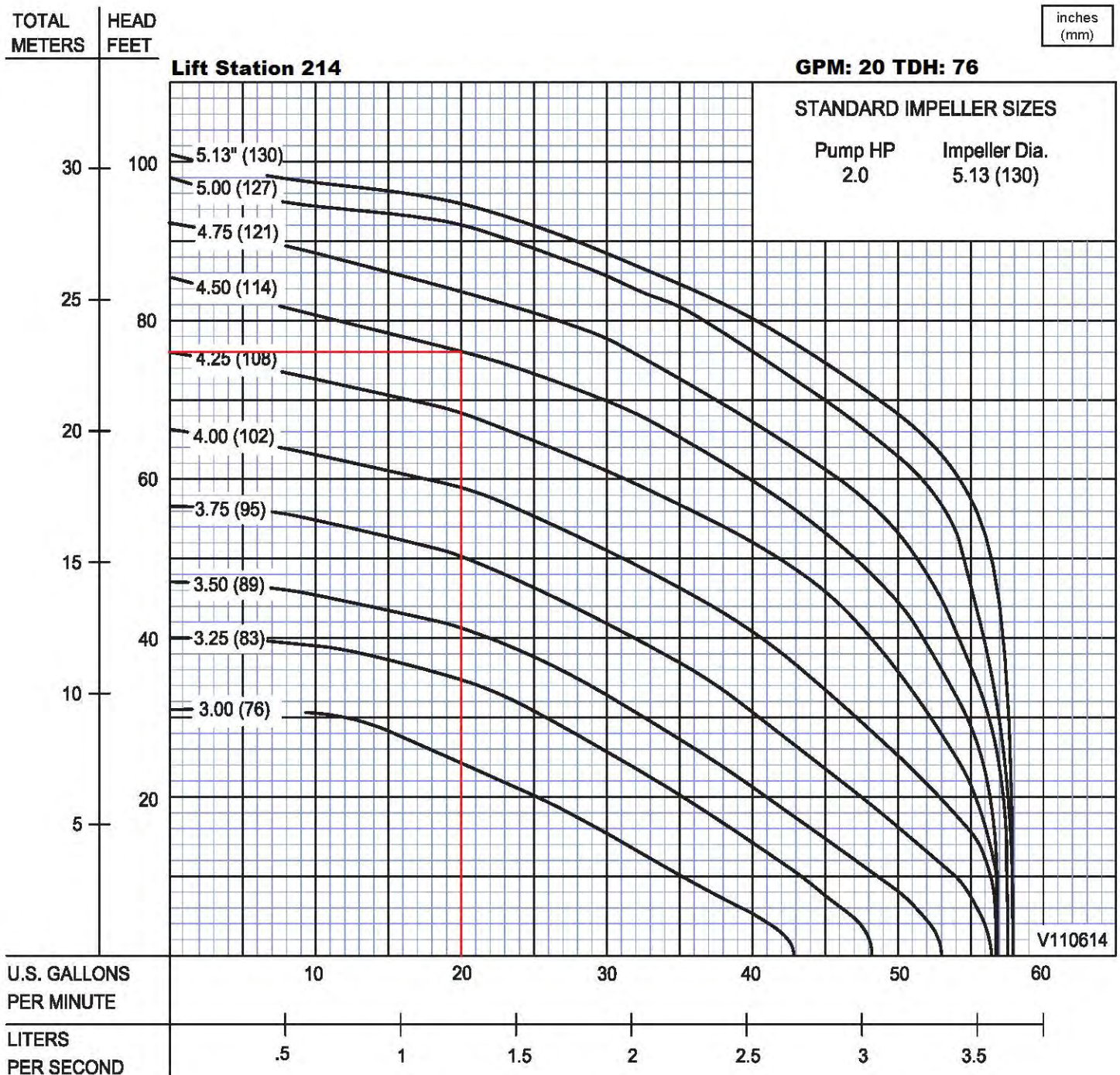

Testing is performed with water, specific gravity 1.0 @ 68° F @ (20°C), other fluids may vary performance

LIFT STATION 215

GPM: 26

TDH: 17 FT

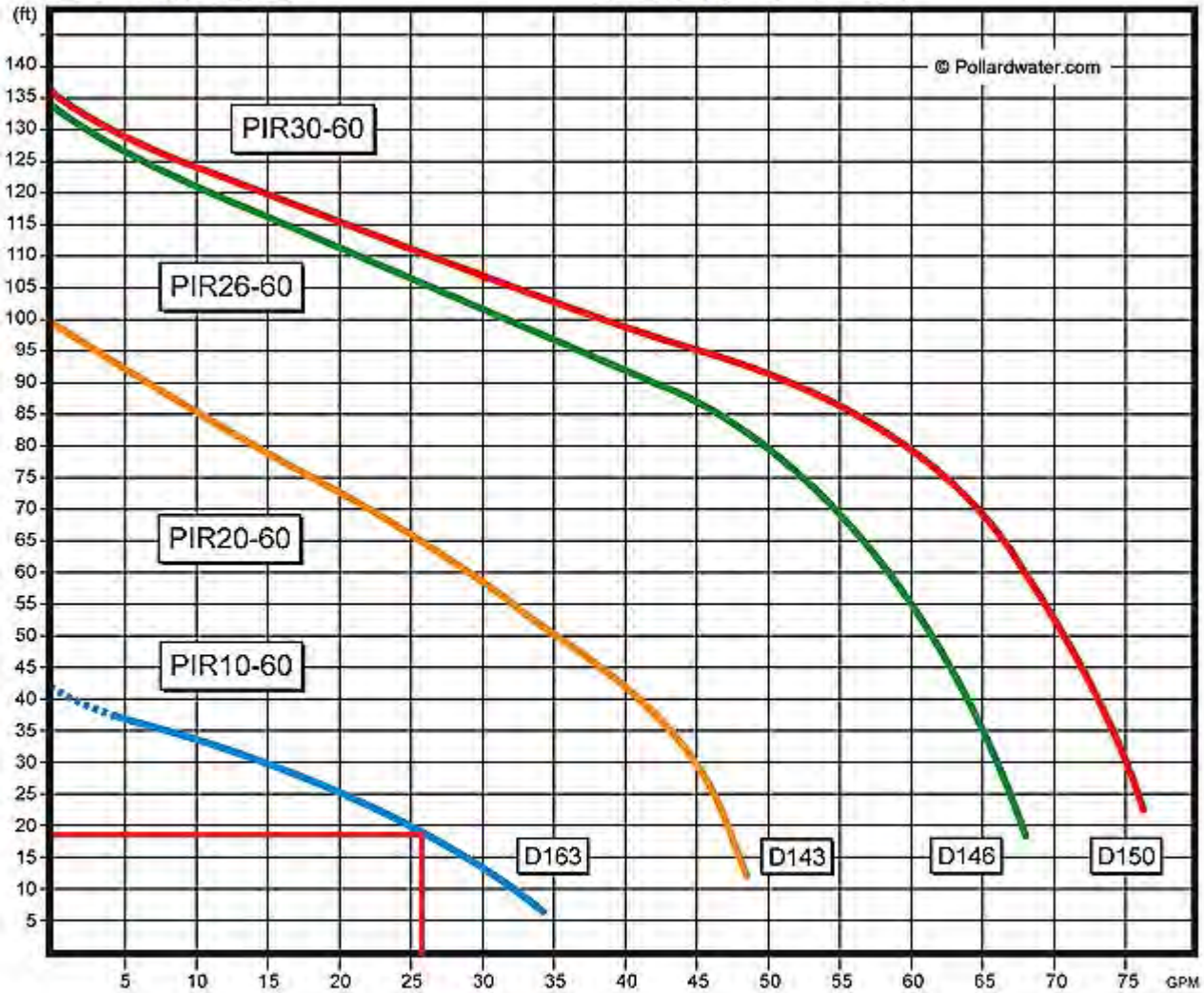

| Impeller | | | | | |
|--|-----------------------------|--|--------------------------|-----------------------------------|--------------------------|
| Impeller type: Single channel impeller | Solid size 3 1/8" | Ø: | Max. Ø: 8 1/8" | Min. Ø: 5 9/16" | Sel. Ø: 7 1/4" |
| Operating data | | | | | |
| Speed: 1700 rpm | Frequency: | Duty point: Q = 200 US g.p.m. H = 33 ft | Suction port: | Discharge port: 4" ANSI | |
| Power data referred to: Water, pure [100%] ; 68°F; 62.322lb/ft³; 1.0818E-5ft²/s | | | Testnorm: | ISO 9906 | |

Curve number:

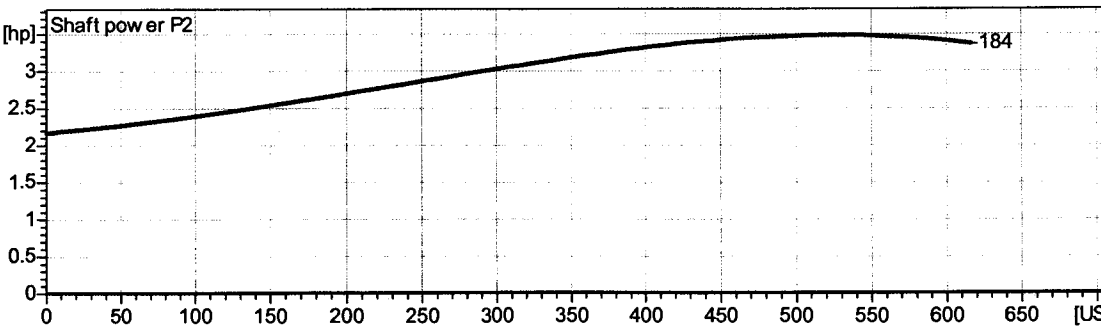
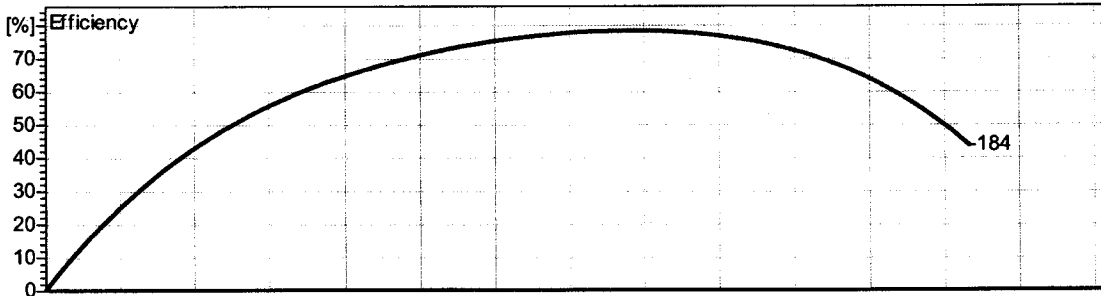
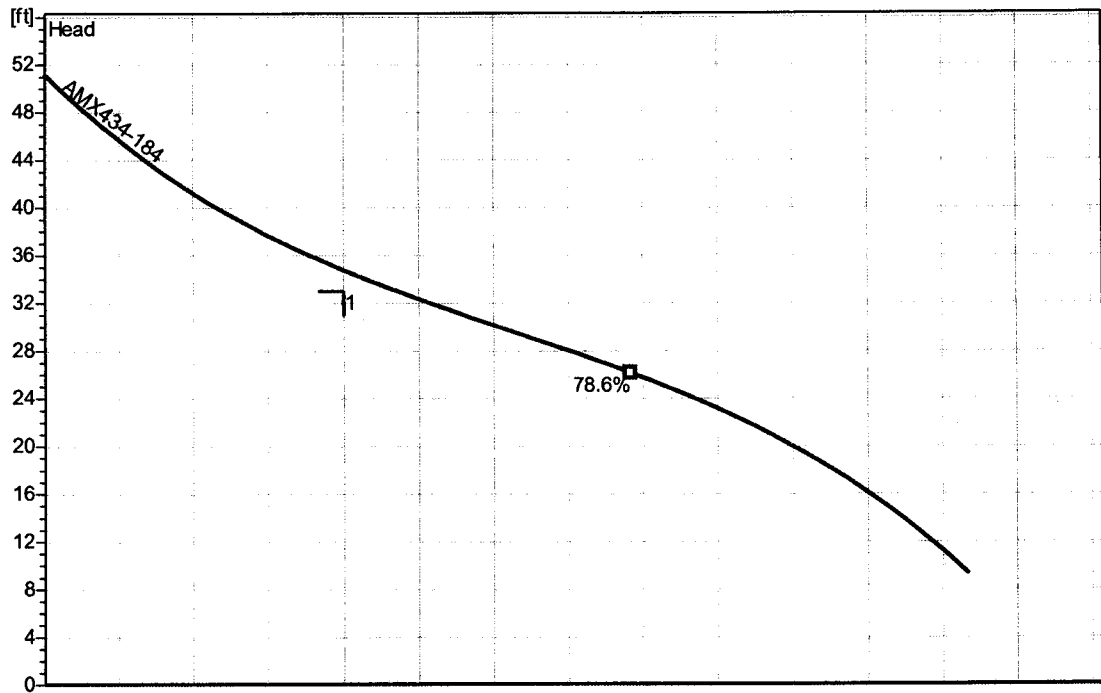

| | | | | |
|----------------------------------|------------------------------------|----------------------------------|-------------------|----------------------------|
| Project Manatee County | Project no.: Sabal Palms | Created by: nyackerman | Page: 2 | Date: 2008-01-15 |
|----------------------------------|------------------------------------|----------------------------------|-------------------|----------------------------|

2

ITEM # 4 19-D RTU 217

PERFORMANCE CURVES

| | | |
|----------------------|---|----------------------------|
| 4-poles ; 1750 rpm | M Enclosed single-vane impeller | ⑫ Type: AM434-230/13P (FM) |
| 4" Nominal discharge | 60 Hz | |
| 3" Solid size | | |

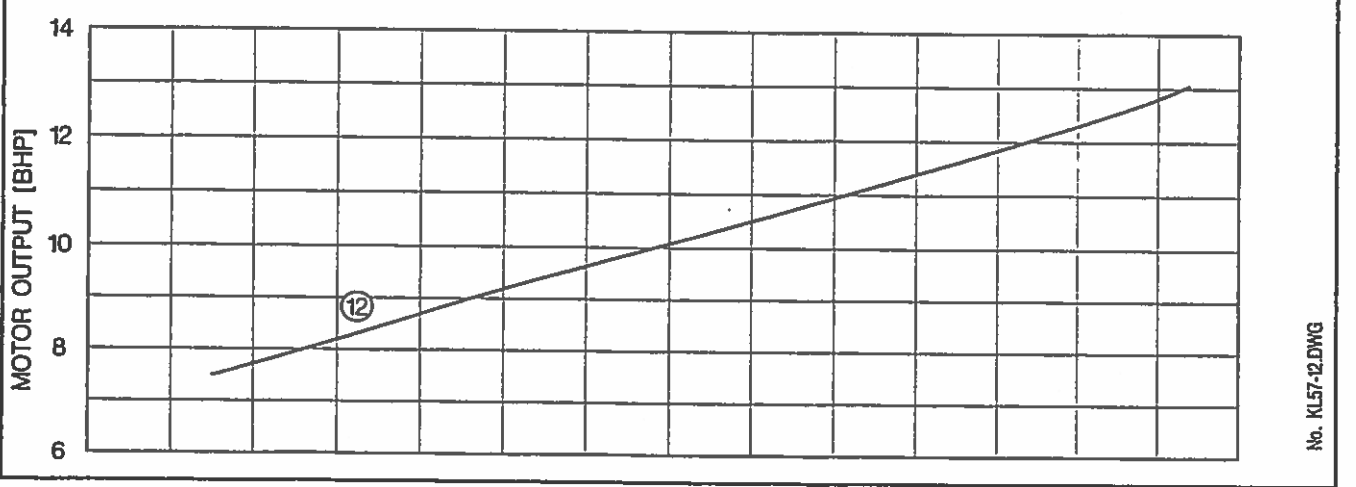
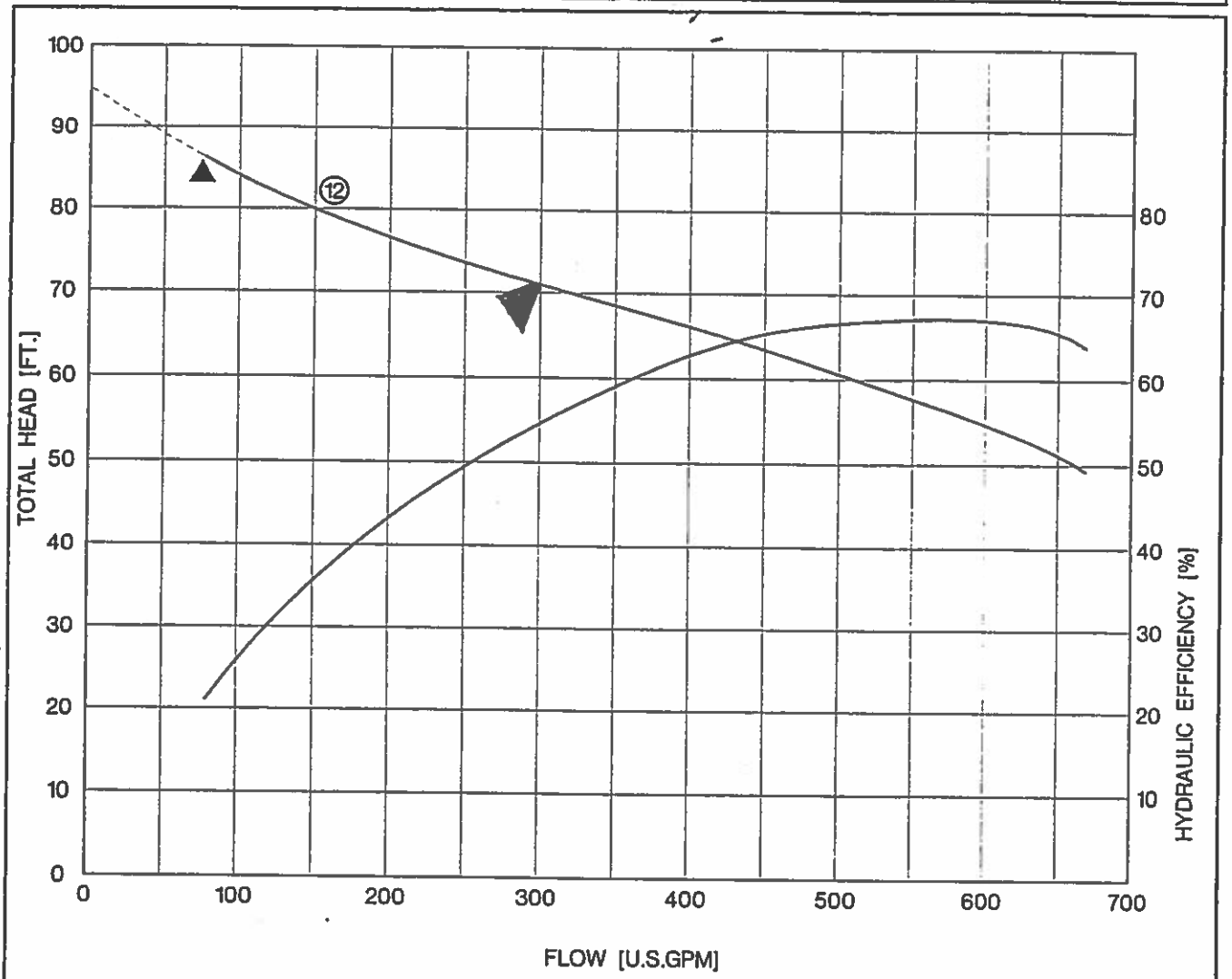

No. KL57-12.DWG

Performance Curve

AMX444-230/20P/C

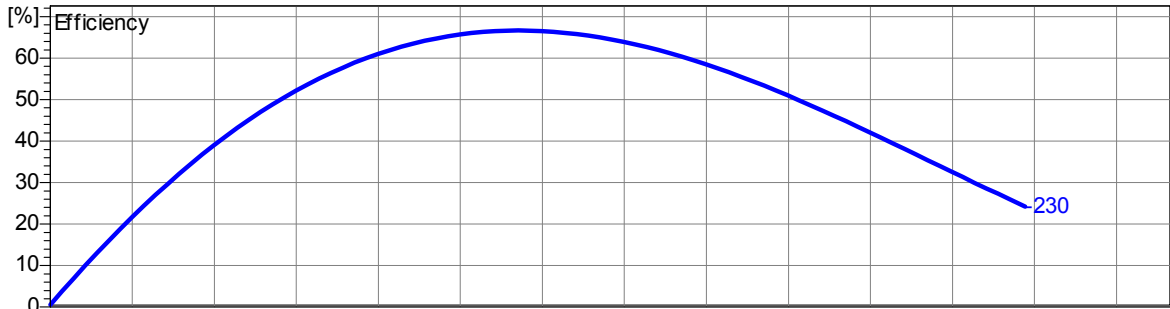
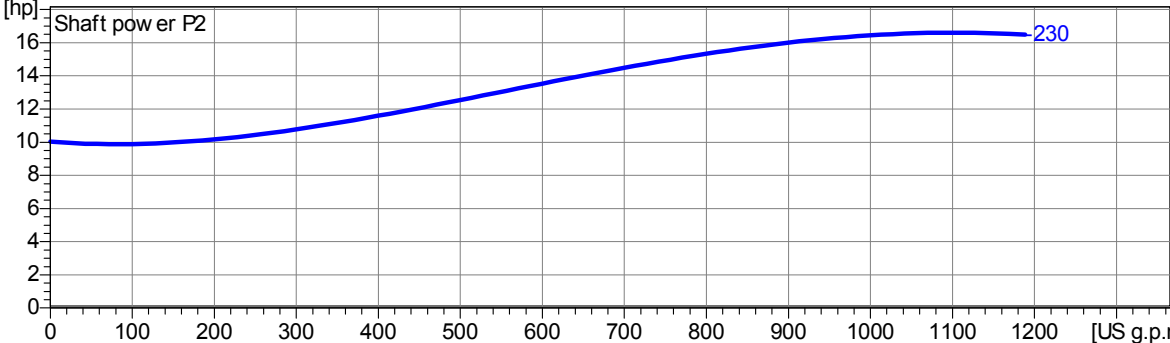
| Impeller | | | | | |
|---|----------------------------------|--|---|---|---|
| Impeller type: Single channel impeller | Solid size 4 inch | Ø: | Max. Ø: 9¹¹/₁₆" | Min. Ø: 7¹/₂" | Sel. Ø: 9³/₈" |
| Operating data | | | | | |
| Speed: 1750 rpm | Frequency: 60 Hz | Duty point: Q = 600 US g.p.m. H = 60 ft | | Suction port: | Discharge port: 4" ANSI |
| Power data referred to: Water, pure [100%]; 68°F; 62.322lb/ft ³ ; 1.0775E-5ft ² /s | | | | Testnorm: | ISO 9906 |
| Curve number: | | | | | |
|  | | | | | |
|  | | | | | |
|  | | | | | |
| Project Man. Cty IFB #09-0897-OV | Project no.: LS # 15-D | | Created by: nyackerman | Page: 2 | Date: 4/1/2009 |

Performance Curve

AMX434-206/7,5T/C

| Impeller | | | | | |
|---|-----------------------------|--|--------------------------|---------------------------|-----------------------------------|
| Impeller type: Single channel impeller | Solid size 3 inch | Ø: | Max. Ø: 8 1/8" | Min. Ø: 5 9/16" | Sel. Ø: 8 1/8" |
| Operating data | | | | | |
| Speed: 1750 rpm | Frequency: 60 Hz | Duty point: Q = 250 US g.p.m. H = 48 ft | | Suction port: | Discharge port: 4" ANSI |
| Power data referred to: Water, pure [100%]; 68°F; 62.322lb/ft³; 1.0818E-5ft²/s | | | | Testnorm: | ISO 9906 |

Curve number:

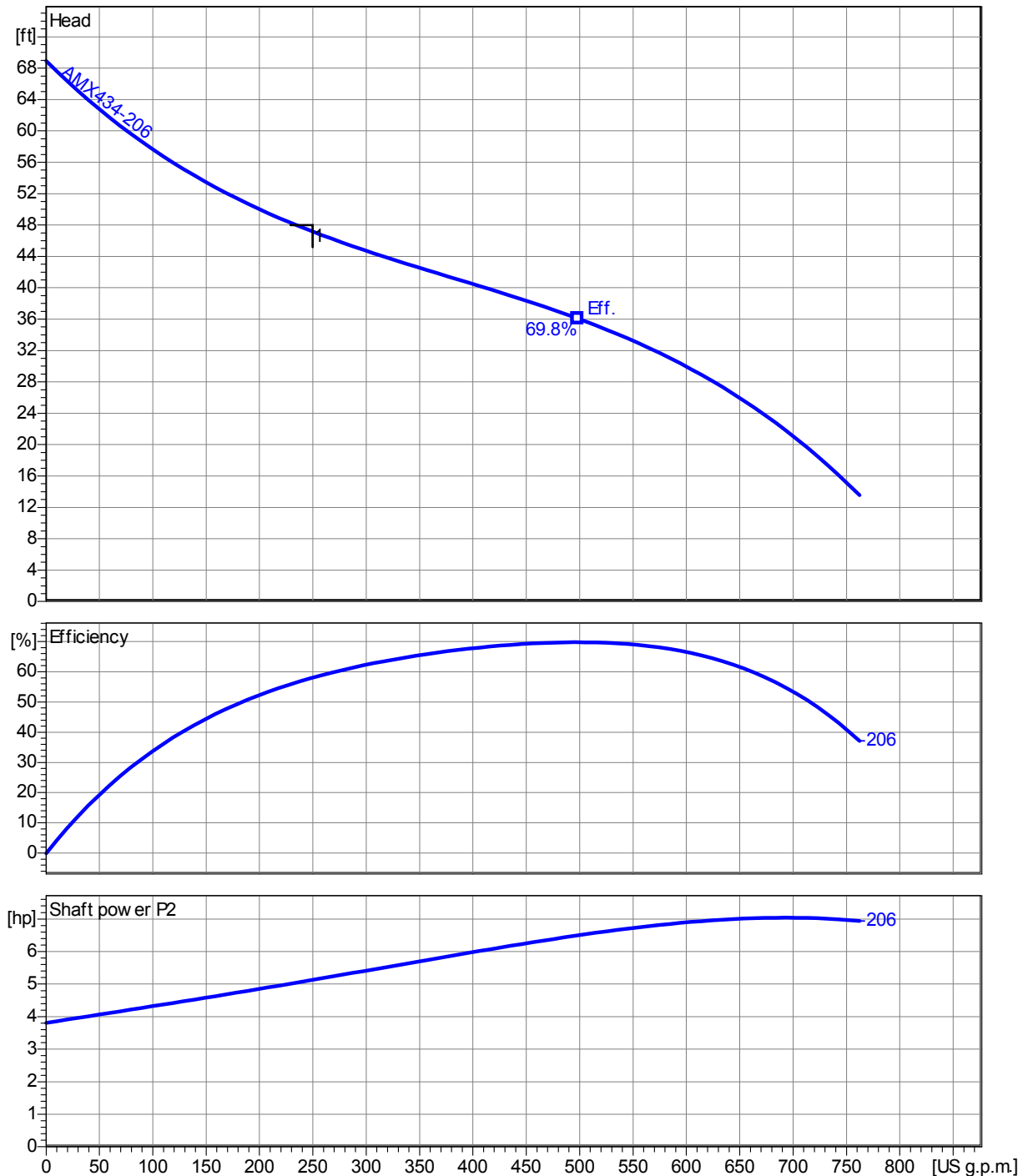

| | | | | |
|--|----------------------------------|----------------------------------|-------------------|--------------------------|
| Project Man. Cty IFB #09-0897-OV | Project no.: LS # 14-D | Created by: nyackerman | Page: 2 | Date: 4/1/2009 |
|--|----------------------------------|----------------------------------|-------------------|--------------------------|

Performance Curve – S4M/S4MX

RPM: **1750** DISCHARGE: **4"** SOLIDS: **3"**

Lift Station 220

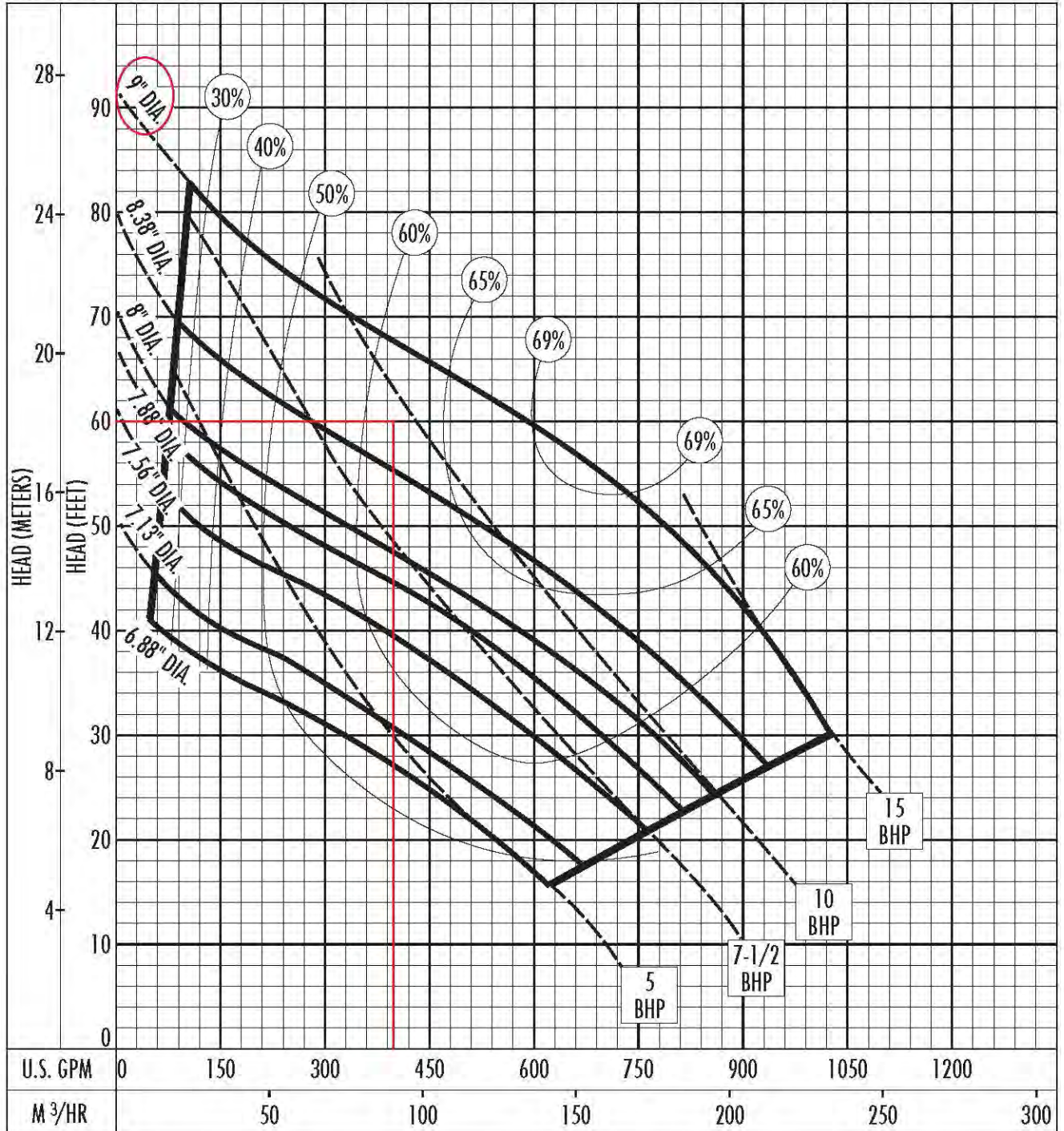

The curves reflect maximum performance characteristics without exceeding full load (Nameplate) horsepower. All pumps have a service factor of 1.2. Operation is recommended in the bounded area with operational point within the curve limit. Performance curves are based on actual tests with clear water at 70° F. and 1280 feet site elevation.

Conditions of Service:

Performance Curve

AMX434-228/10,4T/C

KTU 221

| Impeller | | | | | |
|--|--------------------------------|--|--------------------------|-----------------------------------|--|
| Impeller type: Single channel impeller | Solid size Ø: 3 1/8" | Max. Ø: 9 13/16" | Min. Ø: 8 1/8" | Sel. Ø: 9" | |
| Operating point | | | | | |
| Speed: 1700 rpm | Frequency: | Duty point: Q = 500 US g.p.m. H = 40 ft | Suction port: | Discharge port: 4" ANSI | |
| Power data referred to: Water, pure [100%] ; 68°F; 62.322lb/ft³; 1.0818E-5ft²/s | | | Testnom: | ISO 9906 | |

Curve number:

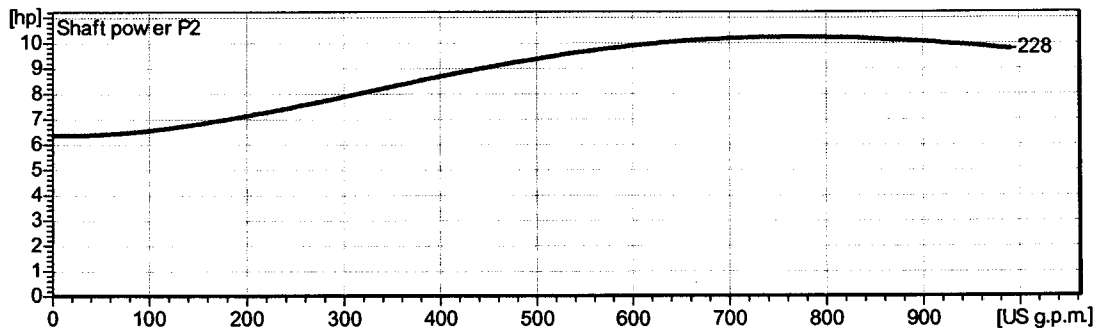
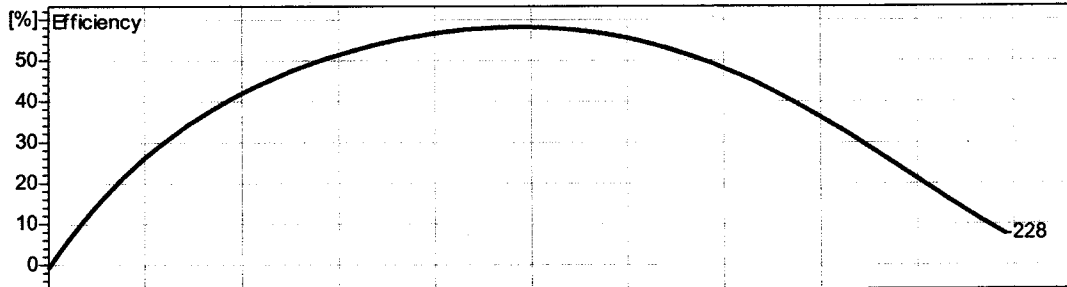
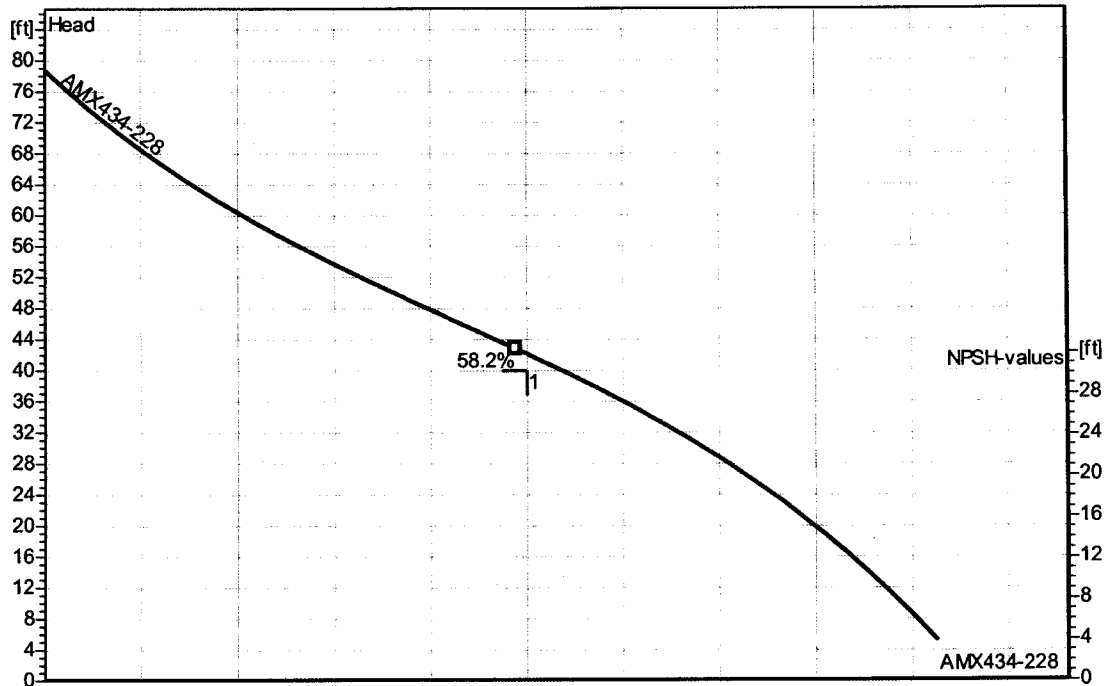

| | | | | |
|----------------------------------|--------------------------------|----------------------------------|-------------------|----------------------------|
| Project Manatee County | Project no.: LS 12-D | Created by: nyackerman | Page: 2 | Date: 2008-01-15 |
|----------------------------------|--------------------------------|----------------------------------|-------------------|----------------------------|

Series 4SE-L

Performance Curve
2.8, 3.7 & 5.0HP, 1750RPM, 60Hz

BARNES®

www.cranepumps.com

4" Horizontal Discharge - Submersible Non-Clog Pumps

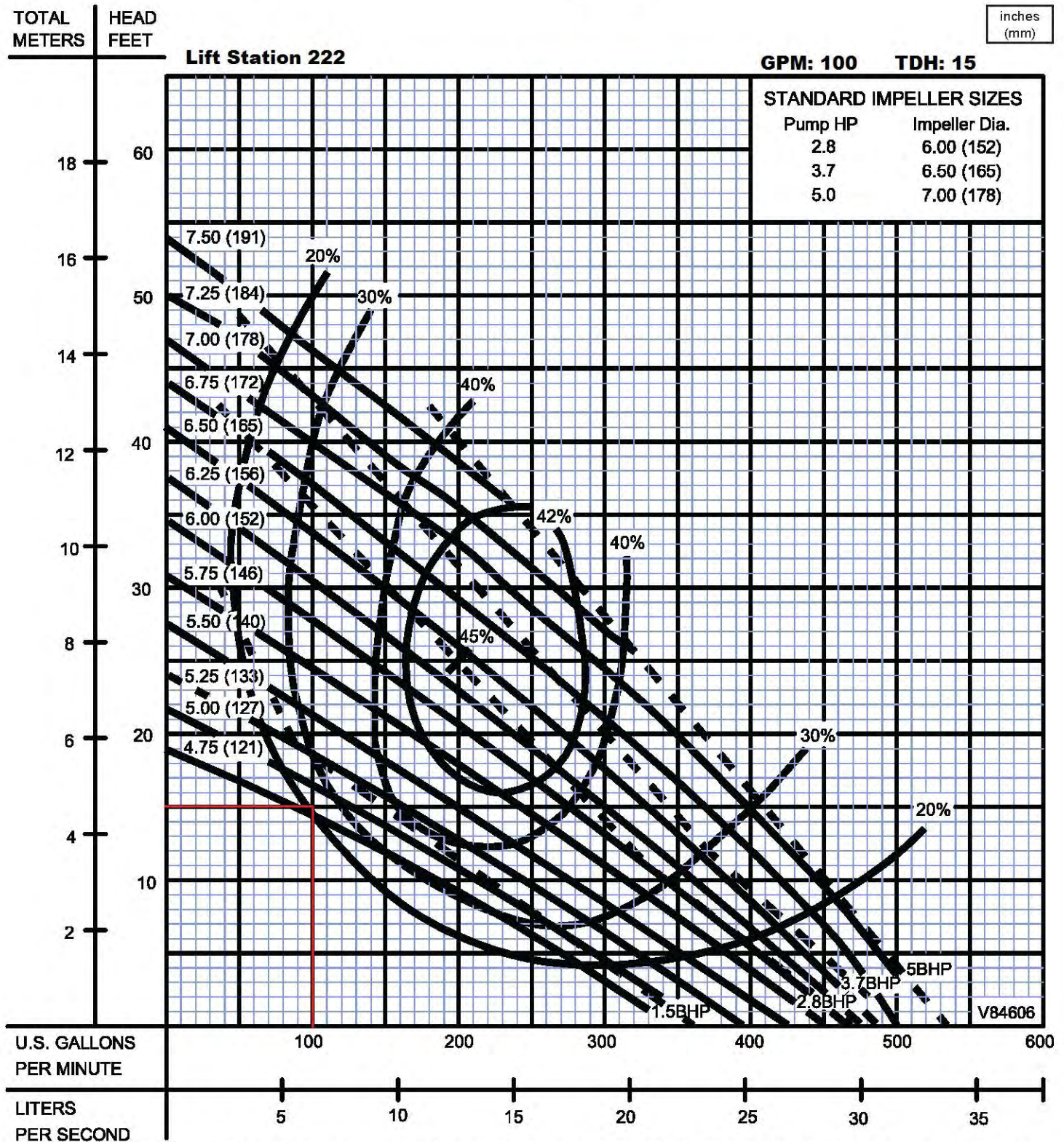

Testing is performed with water, specific gravity 1.0 @ 68° F @ (20°C), other fluids may vary performance

SECTION 1D
PAGE 10
DATE 1/05

CRANE®

A Crane Co. Company

PUMPS & SYSTEMS

USA: (937) 778-8947 • Canada: (905) 457-6223 • International: (937) 615-3598

| Impeller | | | | |
|---|-----------------------------|--|---------------------------|-----------------------------------|
| Impeller type: Single channel impeller | Solid size 3 inch | Ø: 8 1/8" | Max. Ø: 5 9/16" | Min. Ø: 7 1/4" |
| Operating data | | | | |
| Speed: 1750 rpm | Frequency: 60 Hz | Duty point: Q = 120 US g.p.m. H = 37 ft | Suction port: | Discharge port: 4" ANSI |
| Power data referred to: Water, pure [100%] ; 68°F; 62.322lb/ft³; 1.0818E-5ft²/s | | | Testnom: | ISO 9906 |

Curve number:

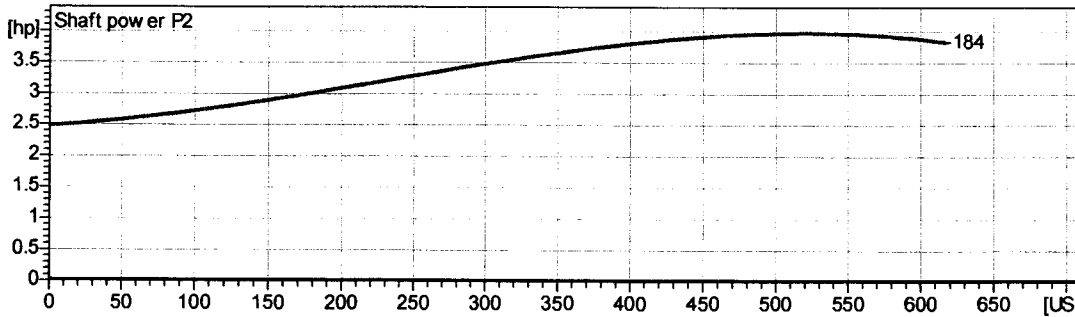
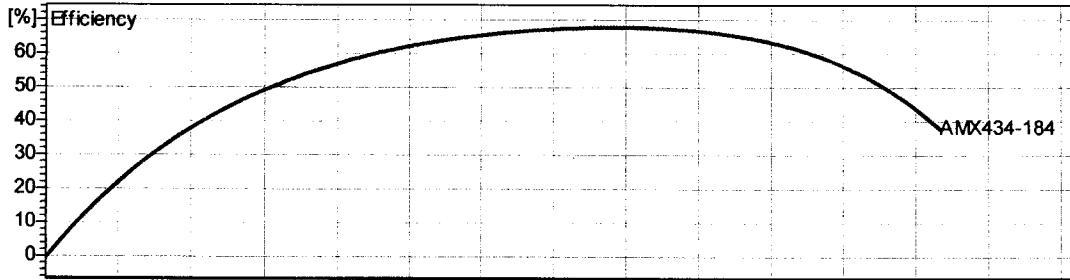
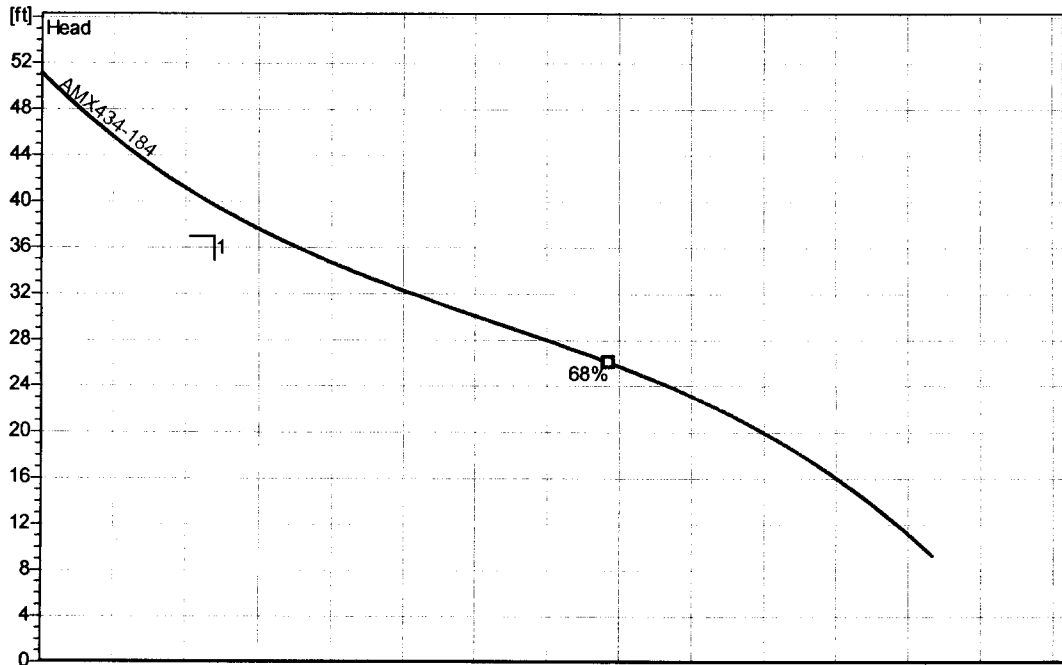

2.0 - 11.01.2008 (Build 137) Homa Pump Technology Inc. (internal)

| | | | | |
|--|---|----------------------------------|-------------------|--------------------------|
| Project Man. Cty IFB #09-0897-OV | Project no.: Riverview Landings | Created by: nyackerman | Page: 2 | Date: 4/4/2009 |
|--|---|----------------------------------|-------------------|--------------------------|

RTU 224

| Impeller | | | | | |
|---|-----------------------------|--|--------------------------|---------------------------|---------------------------------|
| Impeller type: Single channel impeller | Solid size 3 1/8" | Ø: | Max. Ø: 8 1/8" | Min. Ø: 5 1/16" | Sel. Ø: 7" |
| Operating data | | | | | |
| Speed: 1700 rpm | Frequency: | Duty point: Q = 80 US g.p.m. | H = 30 ft | | Suction port: 4" ANSI |
| Power data referred to: Water, pure [100%]; 68°F; 62.322lb/ft³; 1.0818E-5ft²/s | | | | | Testnom: ISO 9906 |

Curve number:

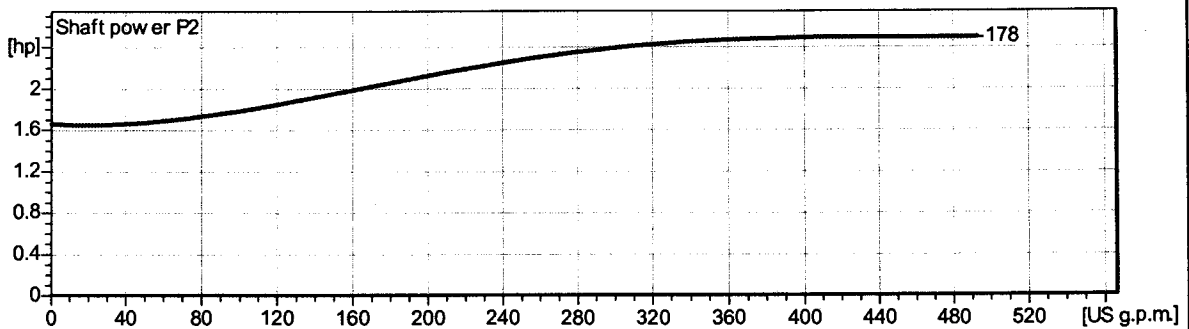
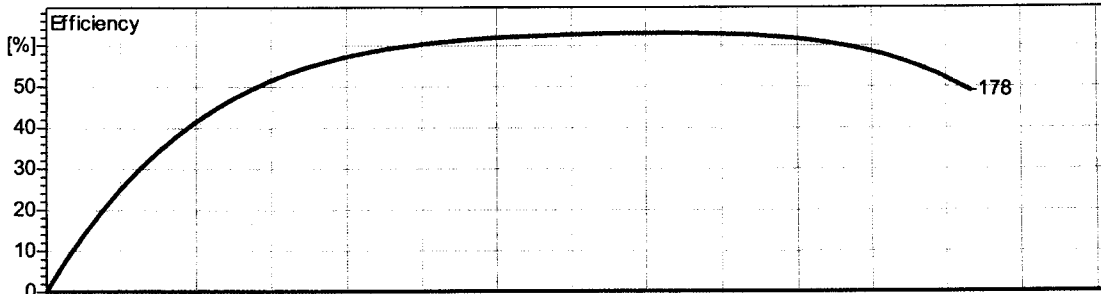
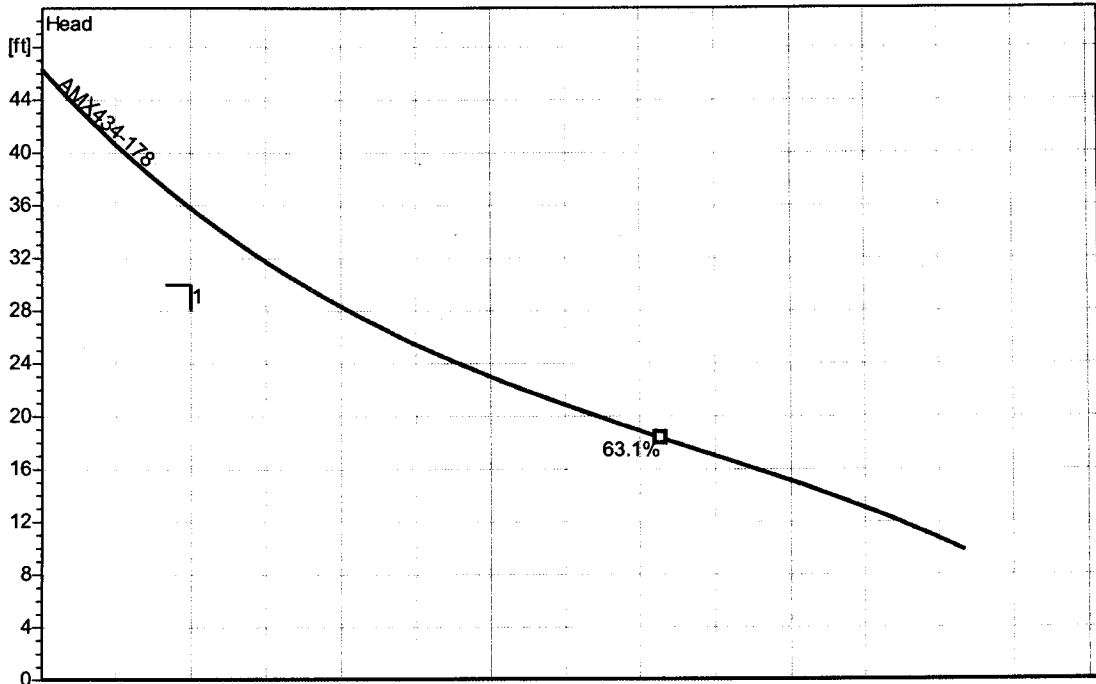

| | | | | |
|----------------------------------|--------------------------------|----------------------------------|-------------------|----------------------------|
| Project Manatee County | Project no.: LS 22-D | Created by: nyackerman | Page: 2 | Date: 2008-01-15 |
|----------------------------------|--------------------------------|----------------------------------|-------------------|----------------------------|

| Impeller | | | | |
|---|--|--|--|--|
| Impeller type: Single channel impeller | Solid size Ø: 3⁵/₁₆" | Max. Ø: 12³/₁₆" | Min. Ø: 7⁷/₁₆" | Sel. Ø: 10¹/₄" |
| Operating data | | | | |
| Speed: 1750 rpm | Frequency: | Duty point: Q = 750 US g.p.m. H = 60 ft | Suction port: 4" ANSI | Discharge port: 4" ANSI |
| Power data referred to: Water, pure [100%] ; 68°F; 62.322lb/ft³; 1.0775E-5ft²/s | | | Testnom.: ISO 9906 | |

Curve number:

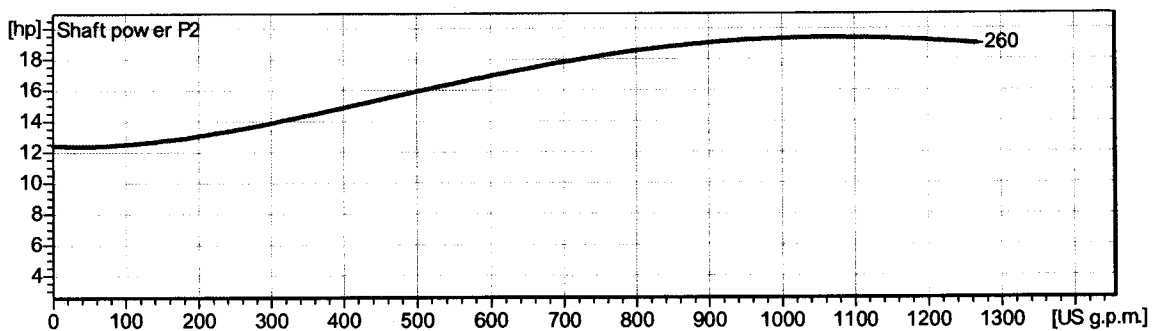
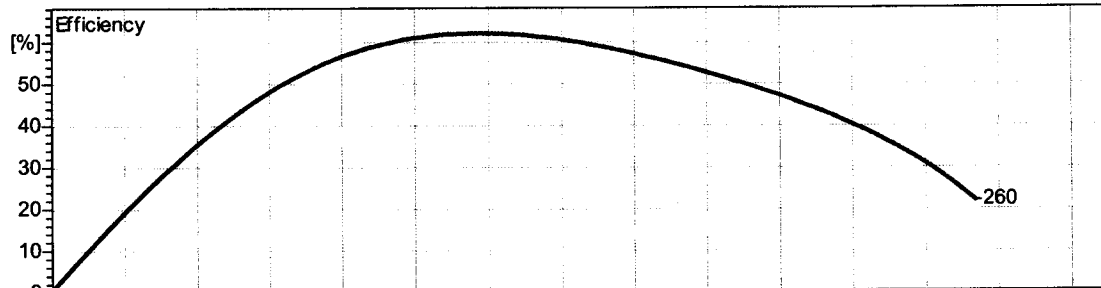
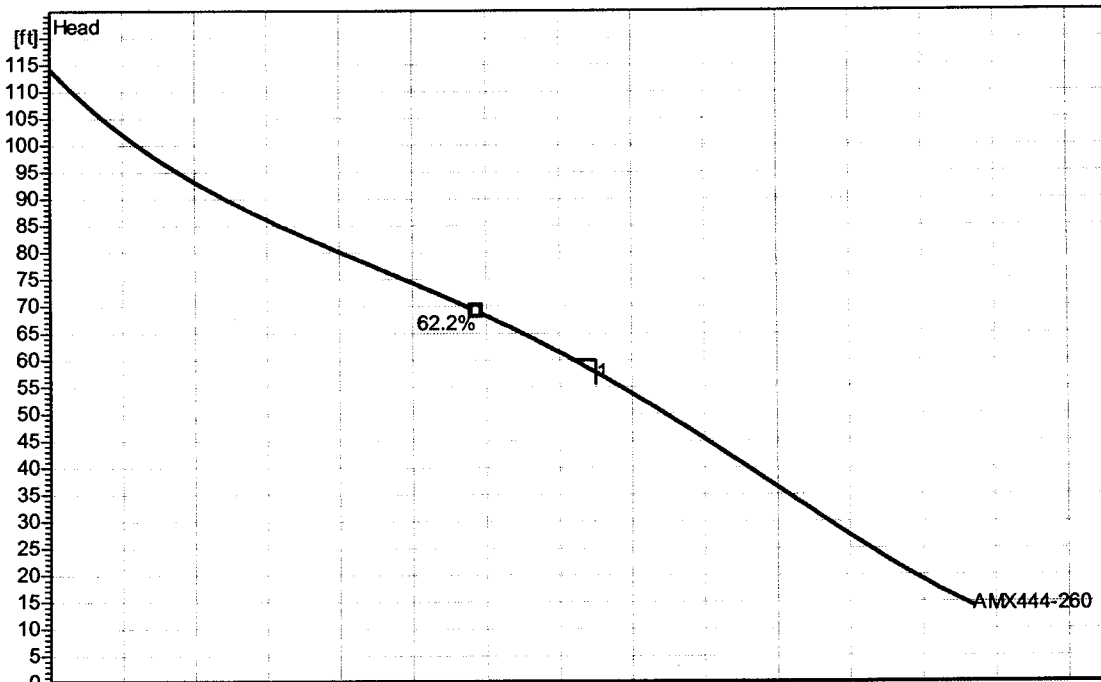

| | | | | |
|----------------------------------|-------------------------------|----------------------------------|-------------------|----------------------------|
| Project Manatee County | Project no.: LS 8-D | Created by: nyackerman | Page: 2 | Date: 2008-01-15 |
|----------------------------------|-------------------------------|----------------------------------|-------------------|----------------------------|

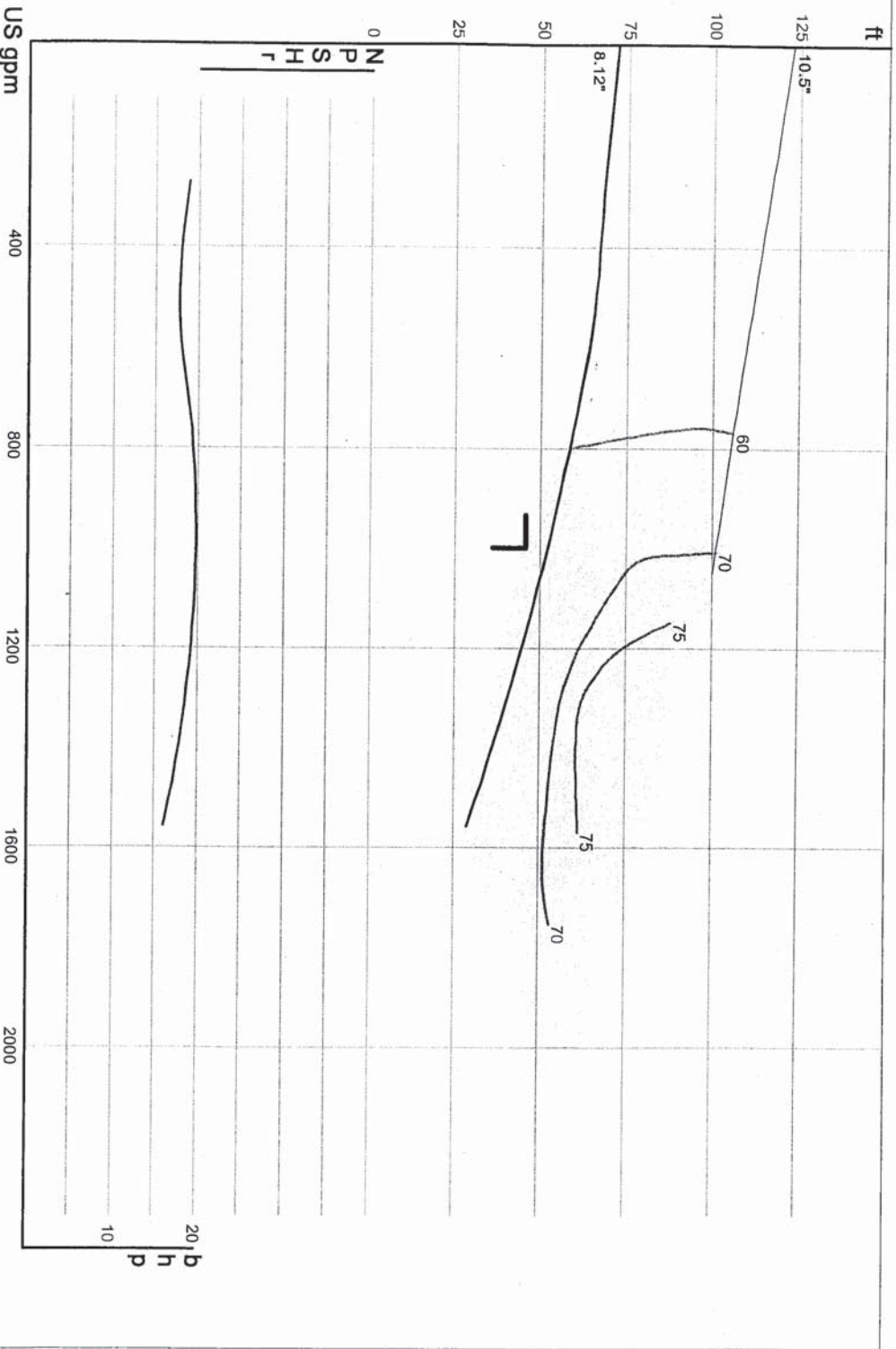

Curve No.:

Size: 6SE360*4HL

Speed: 1750 rpm

Dia: 8.12 in

Crane/Barnes

Catalog: Crane Barnes 60Hz, vers 8

1F6NONCLOG - 1800

Design Point: 1000 US gpm, 45 ft

Southeastern Pump

9-D

2/09/06

-(226)

BARNES



Performance Data

3888 WS Cast Iron Impeller
Sewage Pumps

MODEL : WS1512D4U

RTU 227

| Hydraulic Data | | | | Motor Data | | WS D4 Series 3888D4 | Qty. |
|----------------|--------------------|-------------|-------------------|-------------------|-----------------------------|---------------------|------|
| Maximum Flow | Flow at Duty Point | Maximum TDH | TDH at Duty Point | NPSH _r | Voltage / Phase / Enclosure | Model | |
| 395 US g.p.m. | 100 US g.p.m. | 31 ft | 22 ft | | 230V 1 Phase | WS1512D4U | 1 |

Submittal Prepared for: _____ Job: Manatee County - Belaire Bayou
 Engineer: _____ Contractor: _____
 Submittal Prepared by: John Donholt _____ Company: _____
 Submittal Date: 2011-11-02 _____ Approved by: _____ Date: _____

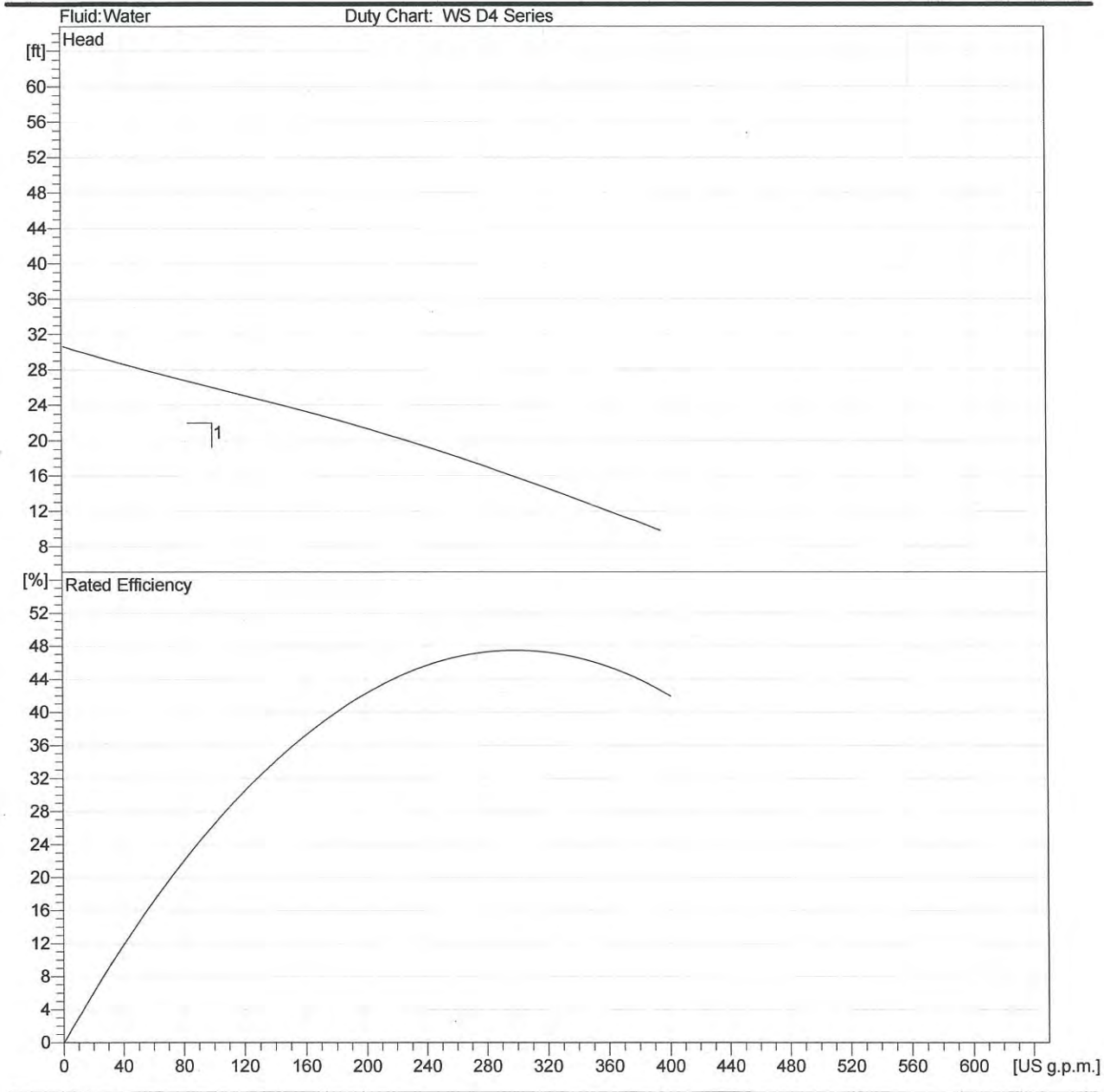

| Impeller | | | | | |
|---|-----------------------------|--|---------------------------|-----------------------------------|--------------------------|
| Impeller type: Single channel impeller | Solid size 3 inch | Ø: 8 1/8" | Max. Ø: 5 3/16" | Min. Ø: 7 1/4" | Sel. Ø: 7 1/4" |
| Operating data | | | | | |
| Speed: 1750 rpm | Frequency: 60 Hz | Duty point: Q = 100 US g.p.m. H = 32 ft | Suction port: | Discharge port: 4" ANSI | |
| Power data referred to: Water, pure [100%]; 68°F; 62.322lb/ft³; 1.0818E-5ft²/s | | | Testnorm: | ISO 9906 | |

Curve number:

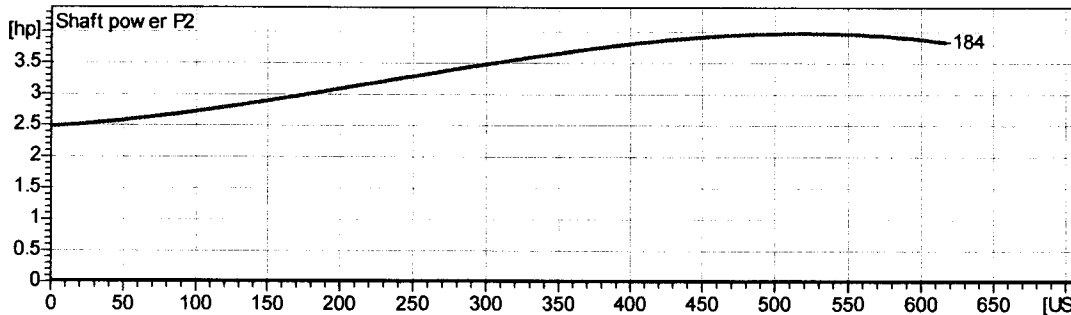
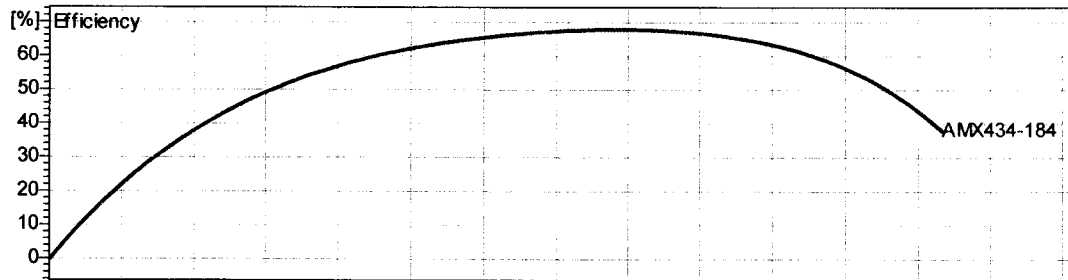
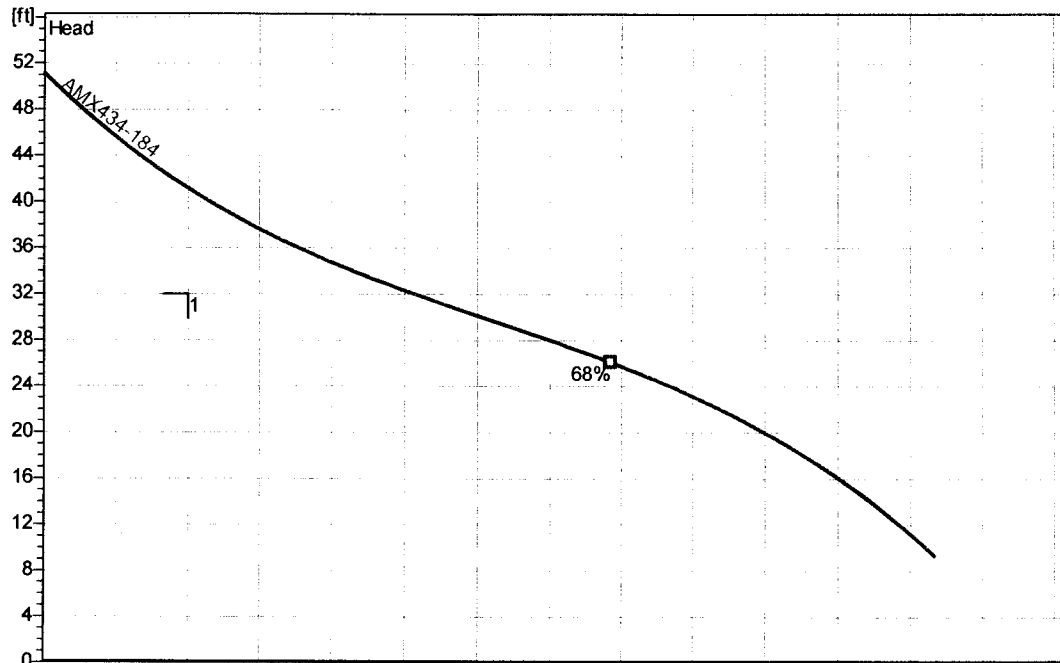

| | | | | |
|-------------------------------------|------------------------------|---------------------------|------------|-------------------|
| Project Man. Cty IFB #09-0897-OV | Project no.: Harbor Woods | Created by: myackerman | Page: 2 | Date: 4/4/2009 |
|-------------------------------------|------------------------------|---------------------------|------------|-------------------|

Performance Curve

AMX434-155/4D/C

| Impeller | | | | | | |
|---|----------------------------|---|-----------------------------------|--------------------|-----------------------------------|--|
| Impeller type: Single channel impeller | Solid size 3 inch | Ø: | Max. Ø: 6 1/8" | Min. Ø: 5 9/16" | Sel. Ø: 6 1/8" | |
| Operating data | | | | | | |
| Speed: 1750 rpm | Frequency: 60 Hz | Duty point: Q = 100 US g.p.m. H = 23 ft | Shaft power P2: 1.92 hp | | Discharge port: 4" ANSI | |

Power data referred to: Water, clean [100%]; 68°F; 62.322lb/ft³; 1.0818E-5ft²/s

Testnorm: ISO 9906/A

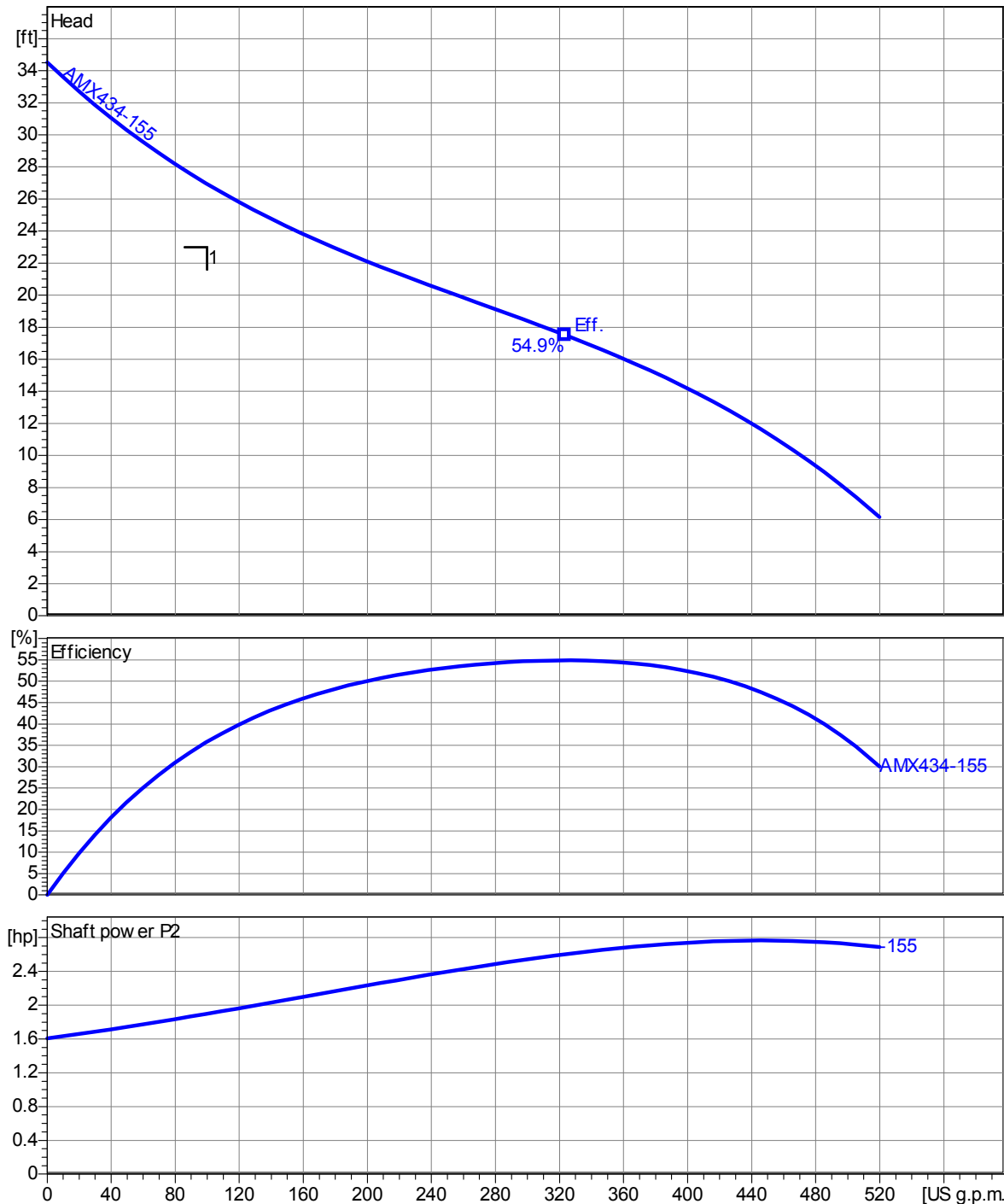

2.0 - 29.01.2009 (Build 168)

| | | | | |
|---------|--|-------------|-------------------|----------------------------|
| Project | Project no.: MANATEE COUNTY LS #21-D | Created by: | Page: 2 | Date: 2011-11-06 |
|---------|--|-------------|-------------------|----------------------------|

Performance Curve

AMX646-300/9,8P/C

| Impeller | | | | | |
|--|-----------------------------|--|---|--|--|
| Impeller type: Single channel impeller | Solid size 4 inch | Ø: | Max. Ø: 12⁵/₁₆" | Min. Ø: 10³/₈" | Sel. Ø: 11³/₄" |
| Operating data | | | | | |
| Speed: 1160 rpm | Frequency: 60 Hz | Duty point: Q = 465 US g.p.m. H = 42 ft | | Suction port: | Discharge port: 6" ANSI |
| Power data referred to: Water [100%] ; 68°F; 62.322lb/ft ³ ; 1.0818E-5ft ² /s | | | | Testnorm: | ISO 9906 |

Curve number:

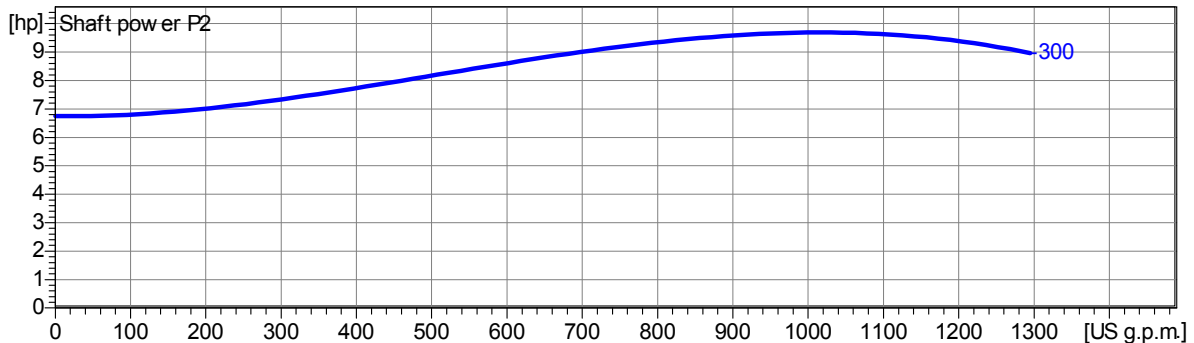
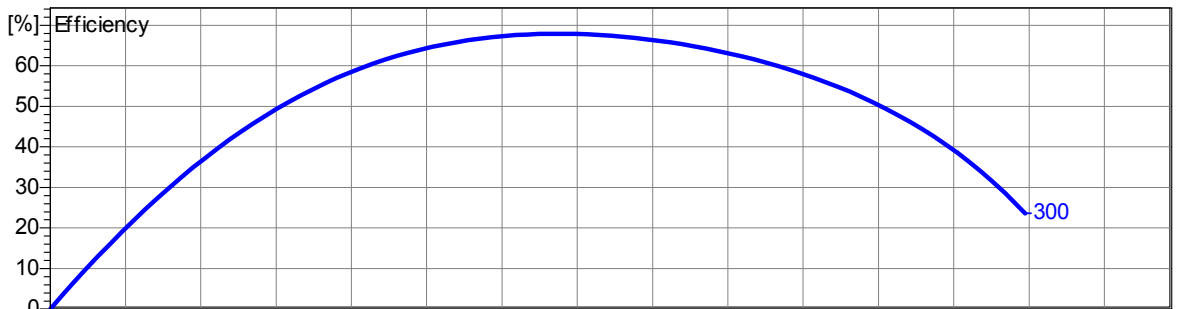
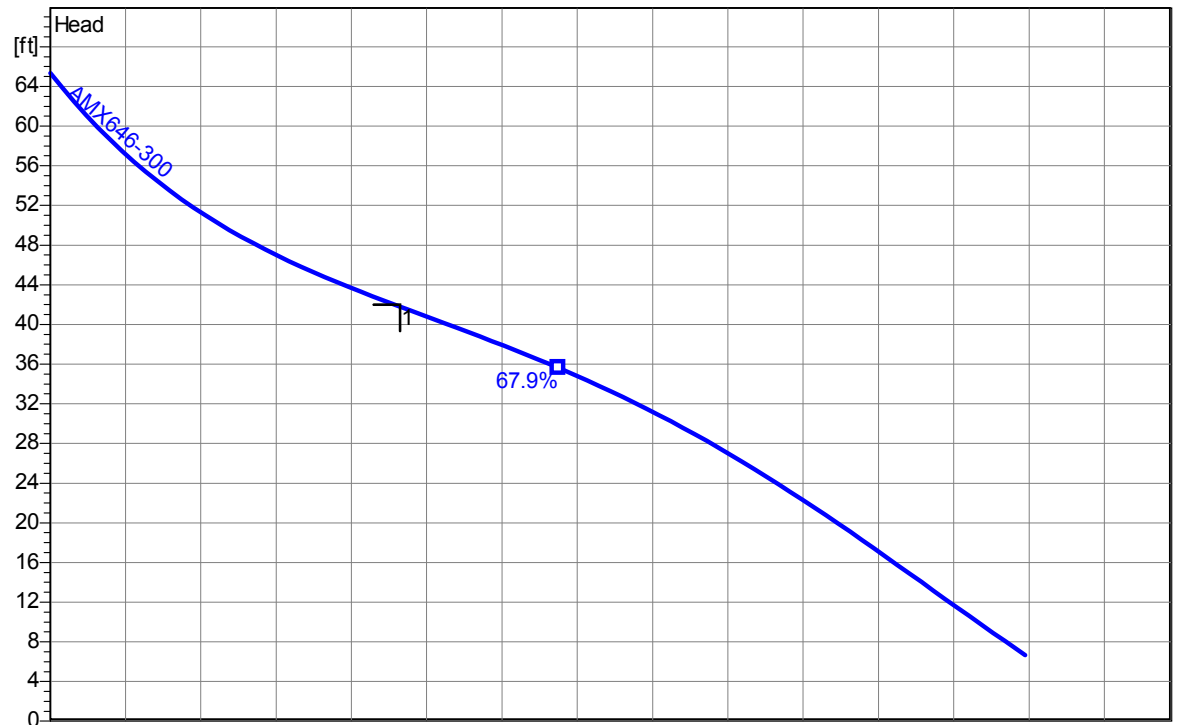

| | | | | |
|--|---------------------------------|----------------------------------|-------------------|--------------------------|
| Project Man. Cty IFB #09-0897-OV | Project no.: LS # 7-D | Created by: nyackerman | Page: 2 | Date: 4/1/2009 |
|--|---------------------------------|----------------------------------|-------------------|--------------------------|

Performance Curve

AMX434-155/4D/C

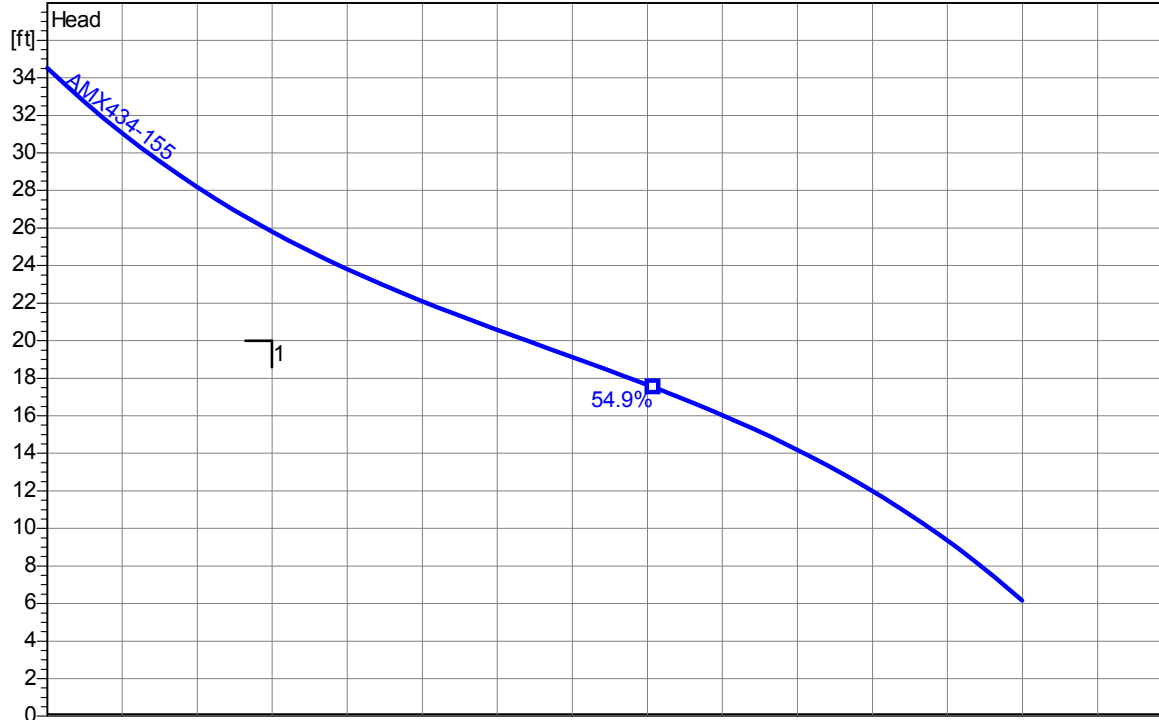
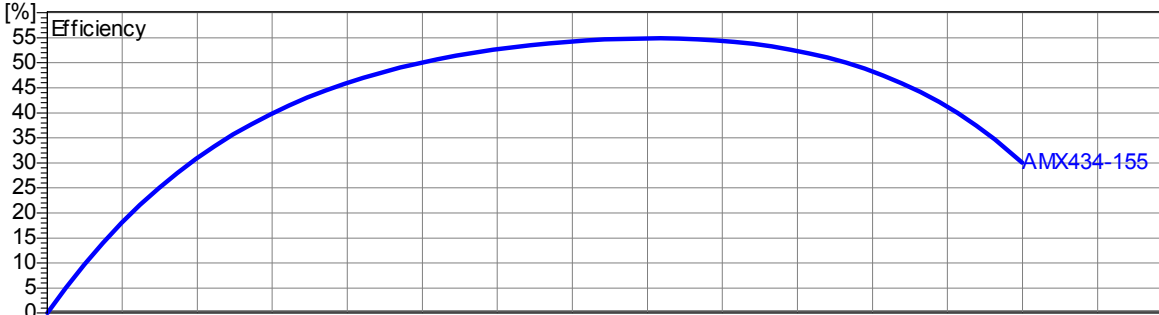
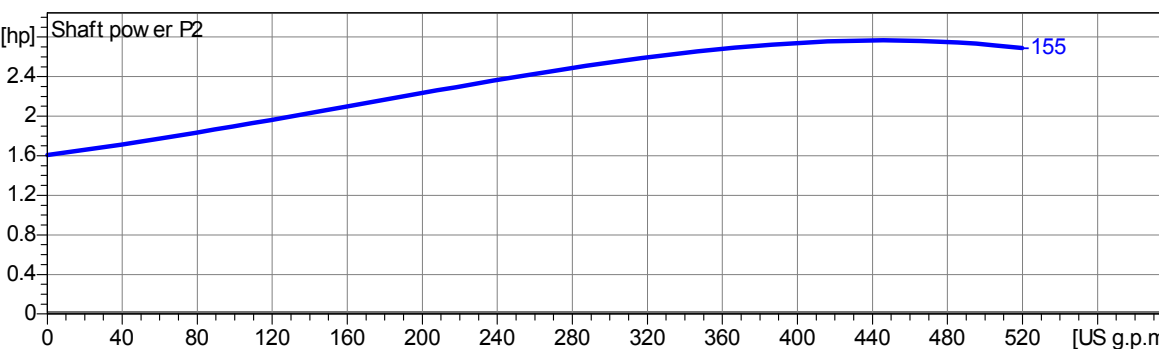
| Impeller | | | | | |
|--|---------------------------------|--|---|--|---|
| Impeller type: Single channel impeller | Solid size 3 inch | Ø: | Max. Ø: 8¹/₈" | Min. Ø: 5⁹/₁₆" | Sel. Ø: 6¹/₈" |
| Operating data | | | | | |
| Speed: 1750 rpm | Frequency: 60 Hz | Duty point: Q = 120 US g.p.m. H = 20 ft | | Suction port: | Discharge port: 4" ANSI |
| Power data referred to: Water, pure [100%] ; 68°F; 62.322lb/ft ³ ; 1.0818E-5ft ² /s | | | | Testnorm: | ISO 9906 |
| Curve number: | | | | | |
|  | | | | | |
|  | | | | | |
|  | | | | | |
| Project Man. Cty IFB #09-0897-OV | Project no.: LS # 4-D | | Created by: nyackerman | Page: 2 | Date: 4/1/2009 |

| | | | | | | | | | | | | | |
|--|--|-------------------|--|--|--|-----------------------------|--|-----------------------------|--|-----------------------------------|--|------------------------|--|
| Impeller type: Single channel impeller | | | | | | Solid size Ø: 3 1/8" | | Max. Ø: 9 13/16" | | Min. Ø: 8 1/8" | | Sel. Ø: 9 1/16" | |
| Speed: 1700 rpm | | Frequency: | | Duty point: Q = 128 US g.p.m. H = 69 ft | | | | Suction port: | | Discharge port: 4" ANSI | | | |
| Power data referred to: Water, pure [100%]; 68°F; 62.322lb/ft³; 1.0818E-5ft²/s | | | | | | | | Testnom: ISO 9906 | | | | | |

Curve number:

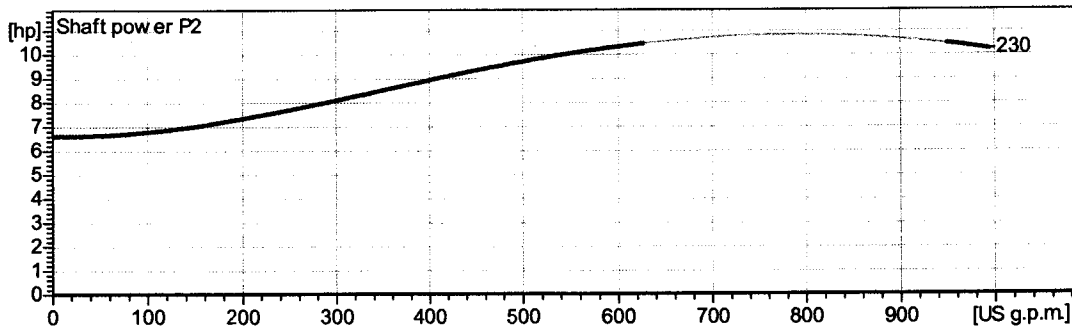
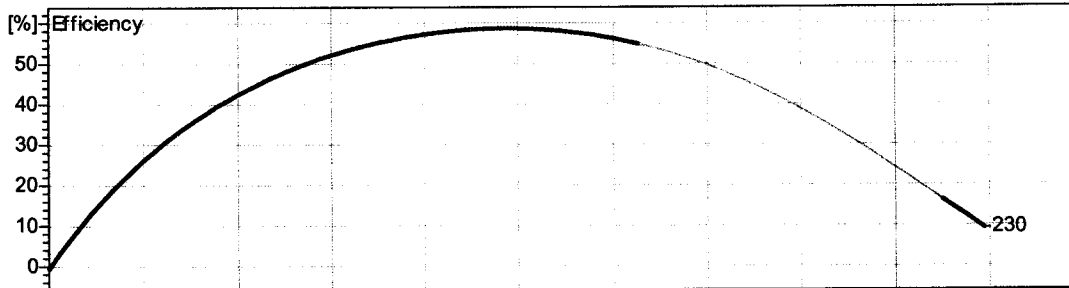
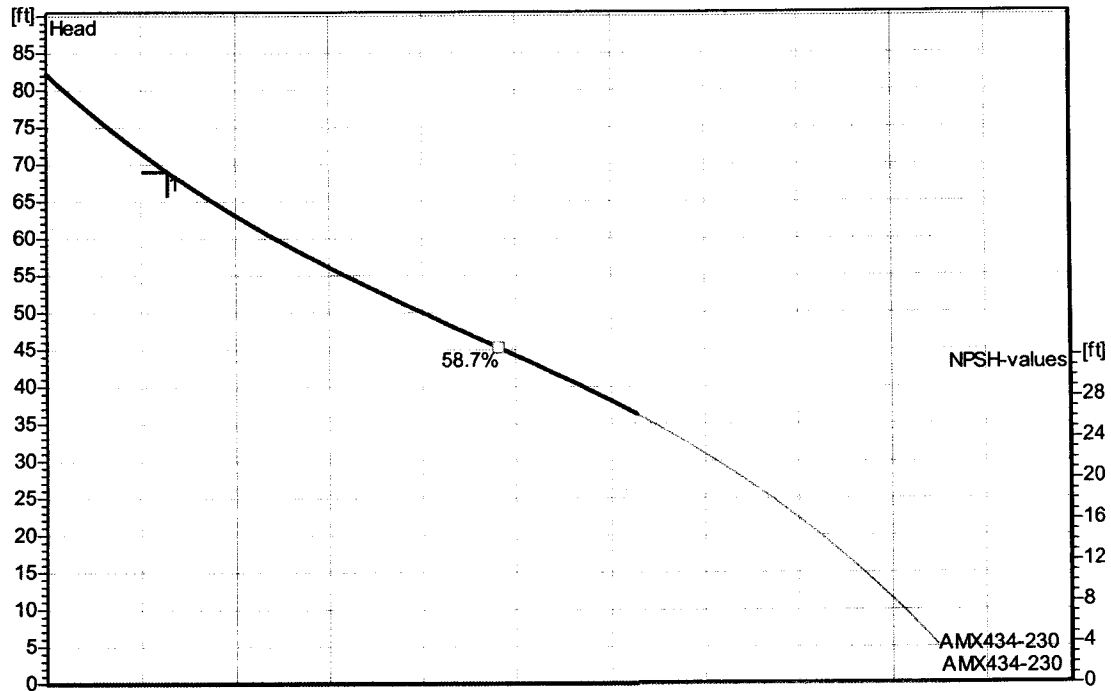

| | | | | |
|----------------------------------|-------------------------------|----------------------------------|-------------------|----------------------------|
| Project Manatee County | Project no.: LS 6-D | Created by: nyackerman | Page: 2 | Date: 2008-01-15 |
|----------------------------------|-------------------------------|----------------------------------|-------------------|----------------------------|

Company: Manatee County Utilities

Name: 3-D RTU 233

Date: 4/9/2012



Pump:

Size: S4M/S4MX
 Type: NCLOG-4
 Synch speed: 1800 rpm
 Curve: S4M1750
 Specific Speeds:
 Dimensions:
 Speed: 1750 rpm
 Dia: 8.5625 in
 Impeller:
 Ns: ---
 Nss: ---
 Suction: --- in
 Discharge: 4 in

Search Criteria:

Flow: --- US gpm Head: --- ft

Fluid:

Water
 Density: 62.37 lb/ft³
 Viscosity: 1.105 cP
 NPSHa: --- ft
 Temperature: 60 °F
 Vapor pressure: 0.2563 psi a
 Atm pressure: 14.7 psi a

Motor:

Consult HYDROMATIC to select a motor for this pump.

Pump Limits:

Temperature: 140 °F
 Pressure: 125 psi g
 Sphere size: 3 in
 Power: --- hp
 Eye area: --- in²

| ---- Data Point ---- | |
|------------------------|----------------------|
| Flow: | 0 US gpm |
| Head: | 83.8 ft |
| Eff: | --- % |
| Power: | --- hp |
| NPSHr: | --- ft |
| ---- Design Curve ---- | |
| Shutoff head: | 83.8 ft |
| Shutoff dP: | 36.3 psi |
| Min flow: | 97.6 US gpm |
| BEP: | 67% @ 610 US gpm |
| NOL power: | 13 hp @ 855 US gpm |
| -- Max Curve -- | |
| Max power: | 15.7 hp @ 925 US gpm |

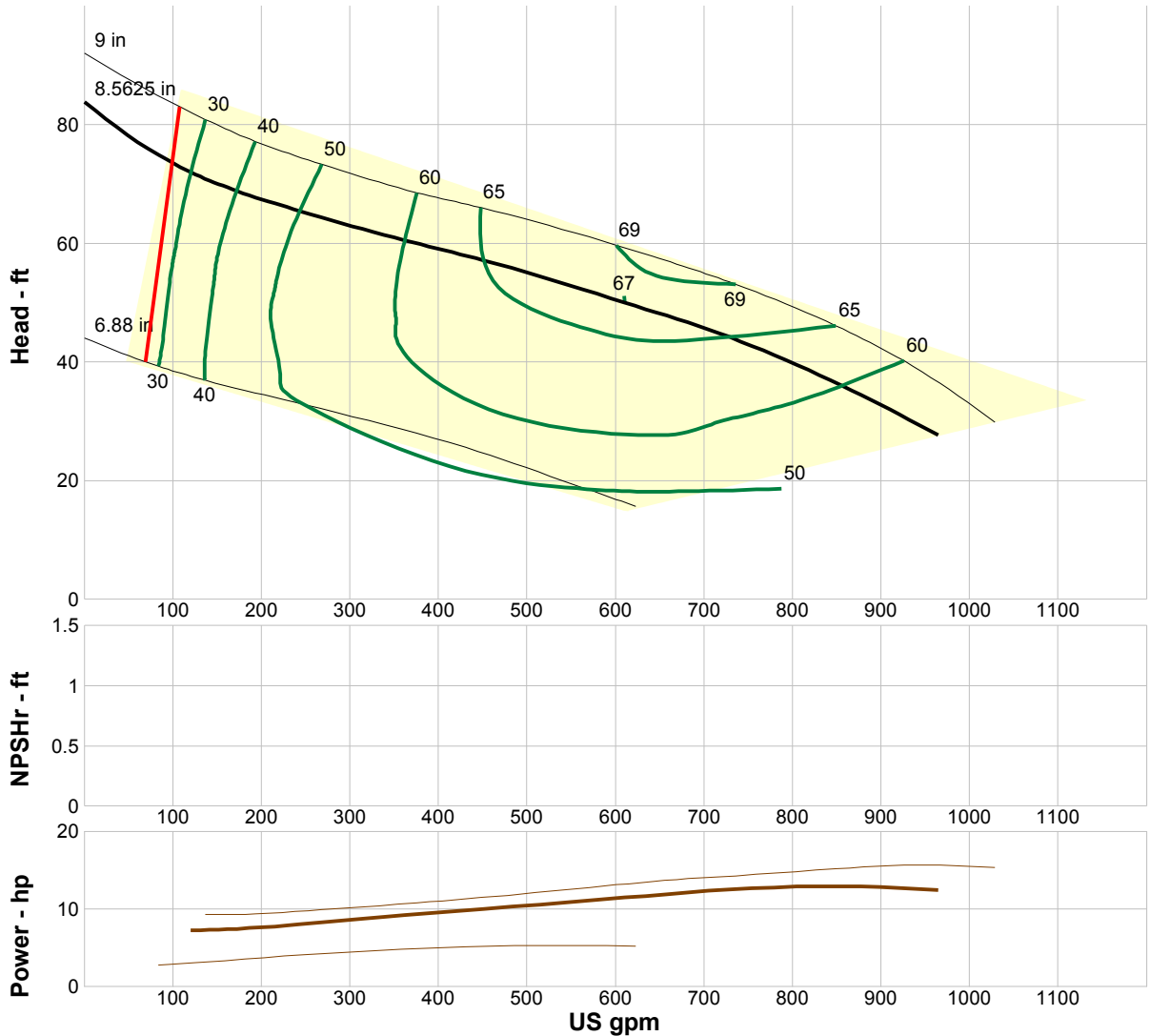

Performance Evaluation:

| Flow US gpm | Speed rpm | Head ft | Efficiency % | Power hp | NPSHr ft |
|----------------|--------------|------------|-----------------|-------------|-------------|
| 925 | 1750 | 30.6 | 56 | 12.7 | --- |
| 771 | 1750 | 41.4 | 63 | 12.7 | --- |
| 617 | 1750 | 49.6 | 67 | 11.6 | --- |
| 463 | 1750 | 56.6 | 65 | 10.1 | --- |
| 308 | 1750 | 62.7 | 55 | 8.69 | --- |

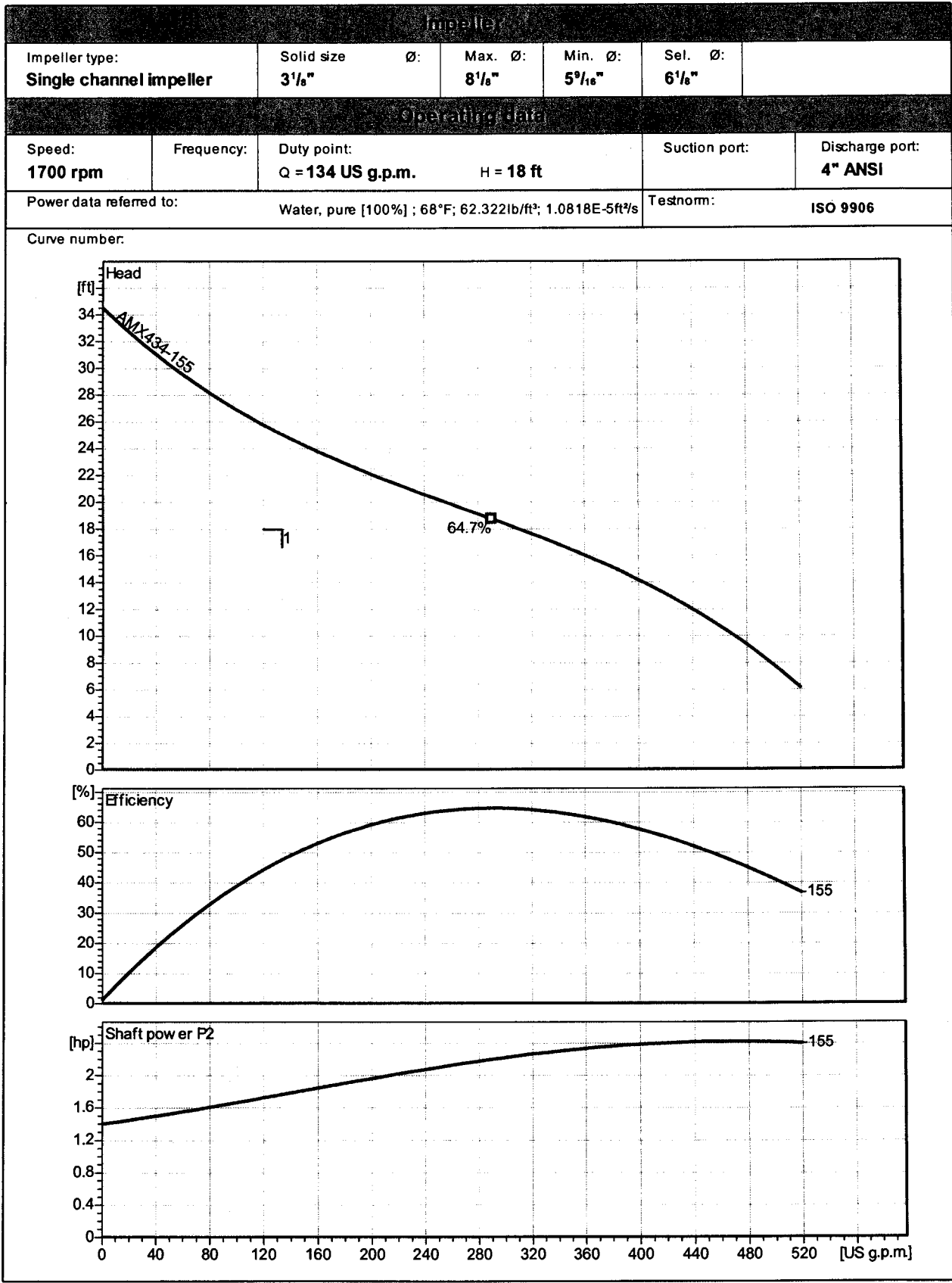

2.0 - 21.02.2006 (Build 105)

Performance Curve

AMX434-193/5,5T/C

| Impeller | | | | | |
|---|-----------------------------|--|--------------------------|---------------------------|-----------------------------------|
| Impeller type: Single channel impeller | Solid size 3 inch | Ø: | Max. Ø: 8 1/8" | Min. Ø: 5 9/16" | Sel. Ø: 7 5/8" |
| Operating data | | | | | |
| Speed: 1750 rpm | Frequency: 60 Hz | Duty point: Q = 184 US g.p.m. H = 46 ft | | Suction port: | Discharge port: 4" ANSI |
| Power data referred to: Water, pure [100%]; 68°F; 62.322lb/ft³; 1.0818E-5ft²/s | | | | Testnorm: | ISO 9906 |

Curve number:

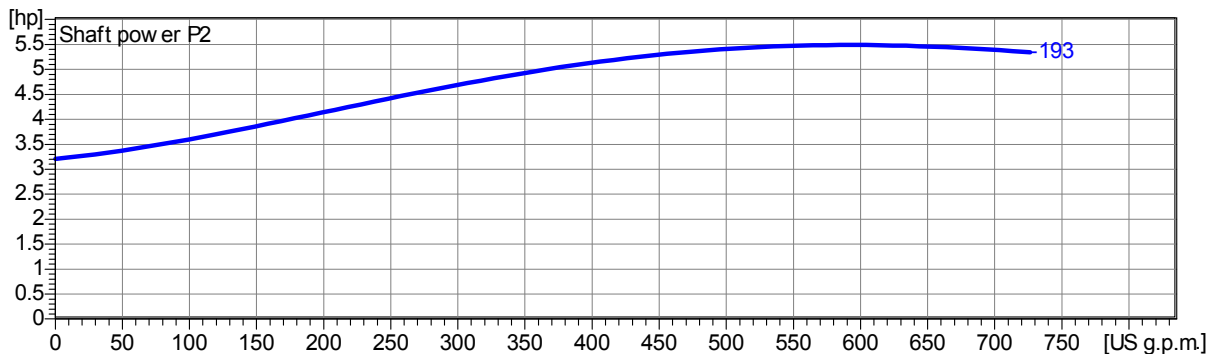
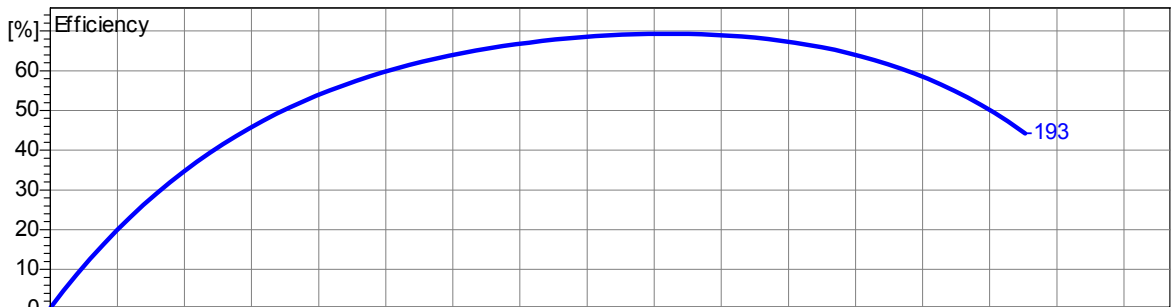
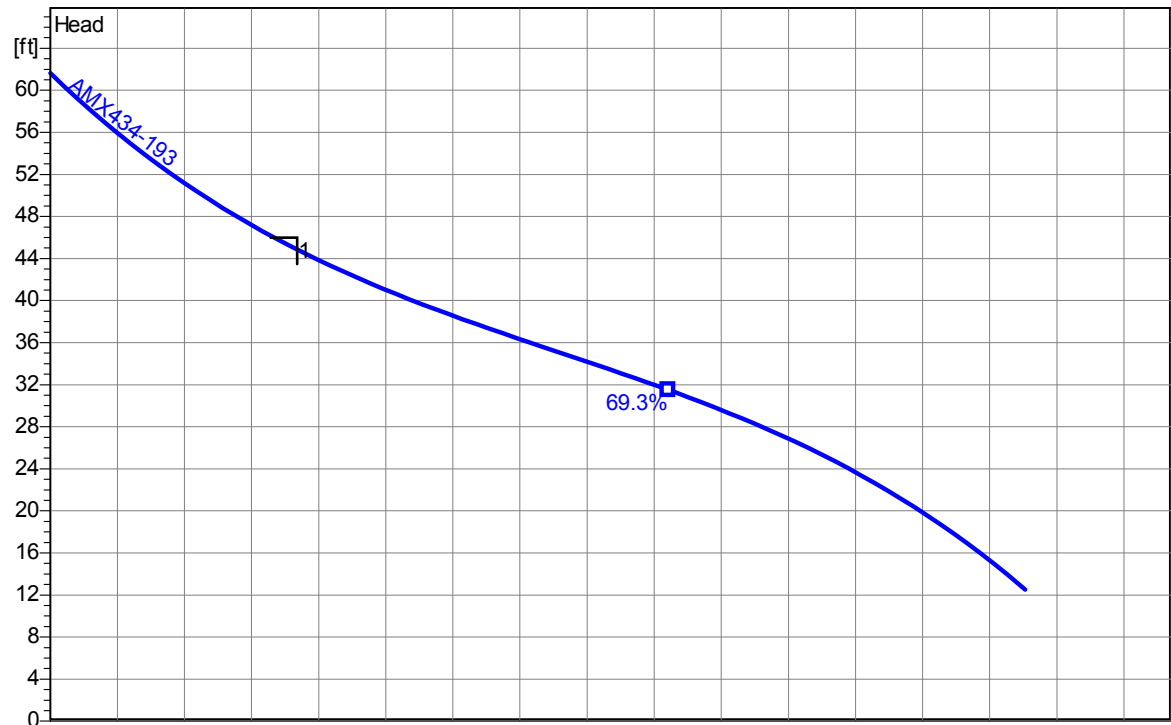

| | | | | |
|--|-------------------------------|----------------------------------|-------------------|--------------------------|
| Project Man. Cty IFB #09-0897-OV | Project no.: LS 5-D | Created by: nyackerman | Page: 2 | Date: 4/1/2009 |
|--|-------------------------------|----------------------------------|-------------------|--------------------------|

Performance Curve

AMX434-228/10,4T/C

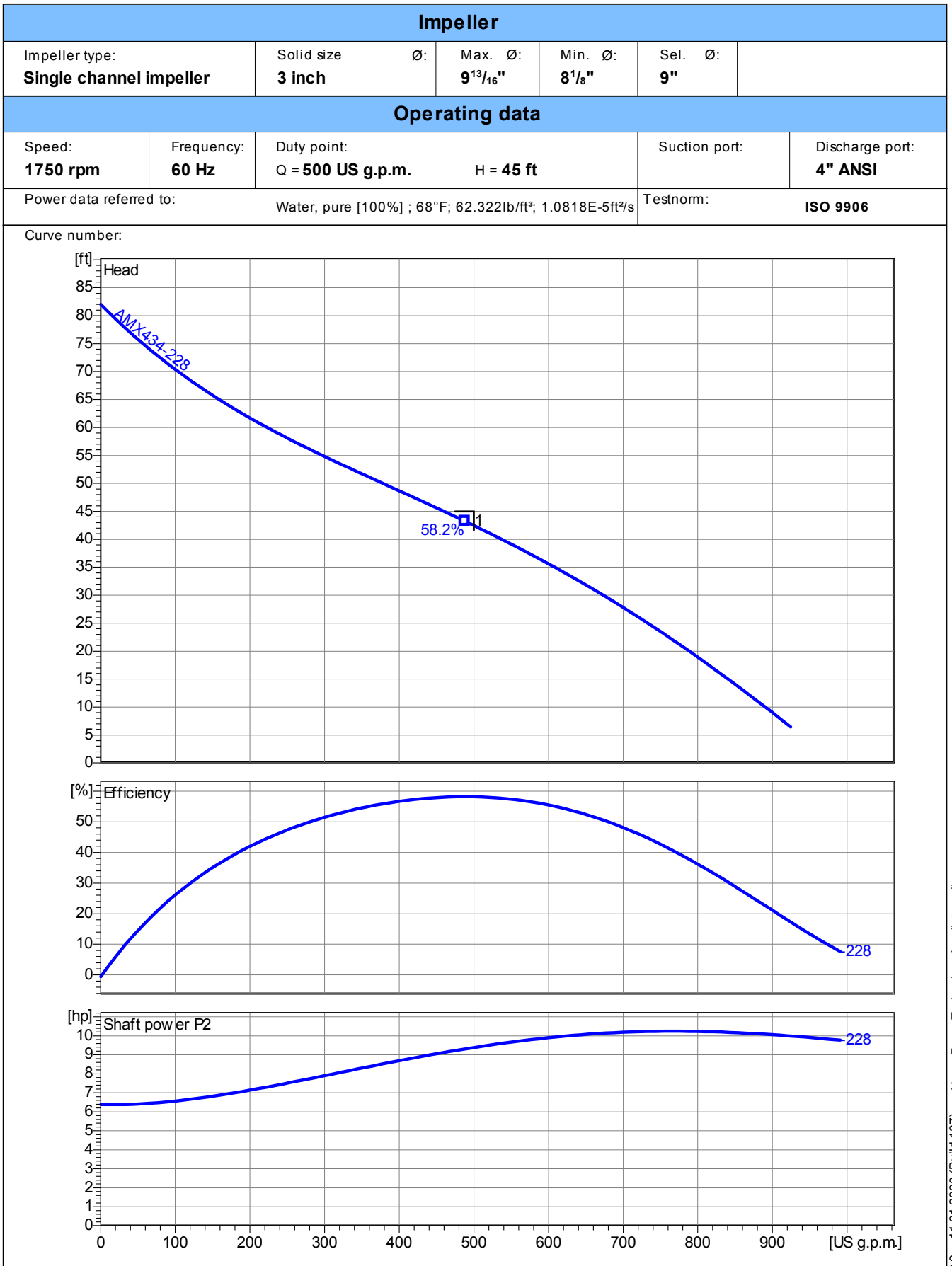

| | | | | |
|--|---------------------------------|----------------------------------|-------------------|--------------------------|
| Project Man. Cty IFB #09-0897-OV | Project no.: LS # 2-D | Created by: nyackerman | Page: 2 | Date: 4/1/2009 |
|--|---------------------------------|----------------------------------|-------------------|--------------------------|



PERFORMANCE CURVE

| | | | | | | | | |
|--|--|--|--|---------------------------------------|-------------------|---|--------------------------|--|
| DATE 2007-10-05 | | PROJECT: MLS 1-D | | | ISSUE 8 | | PROD C3231/665 | |
| NO. OF BLADES..... 2 | | TOT.MOM.OF INERTIA..... 1.55 KGM² | | POLES 4 FREQ. 60 HZ | | CURVE NO 63-430 | | |
| IMPELLER THROUGHLET... 88*88 Circular | | RATED SPEED..... 1780 RPM | | VOLTAGE..... 460 V | | IMPELLER DIAMETER 340 MM | | |
| MOTOR COS PHI 0.83 | | 3/4-LOAD 0.80 | | 1/2-LOAD 0.70 | | MOTOR TYPE 35-45-4AA /01 (12) | | |
| MOTOR EFFICIENCY 94.0% | | GEAR EFFICIENCY | | MAX TORQUE..... 1510 NM | | GEAR TYPE RATIO | | |
| MOTOR EFFICIENCY | | GEAR EFFICIENCY | | STARTING CURRENT..... 190 A | | | | |
| GEAR EFFICIENCY | | | | STARTING CURRENT..... 950 A | | | | |

POWER

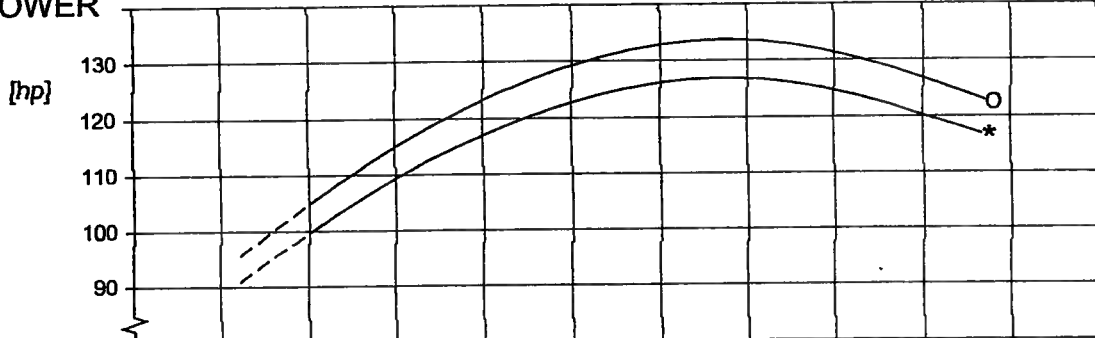

DUTY POINTS:

| | | | | |
|--------------|-----------|-------------|--------------|------------|
| FLOW [USgpm] | HEAD [ft] | EFF. [%] | (NPSHR) [ft] | GUARANTEE |
| 2609 | 126 | 66.8 (70.4) | 22.8 | HI level A |

HEAD

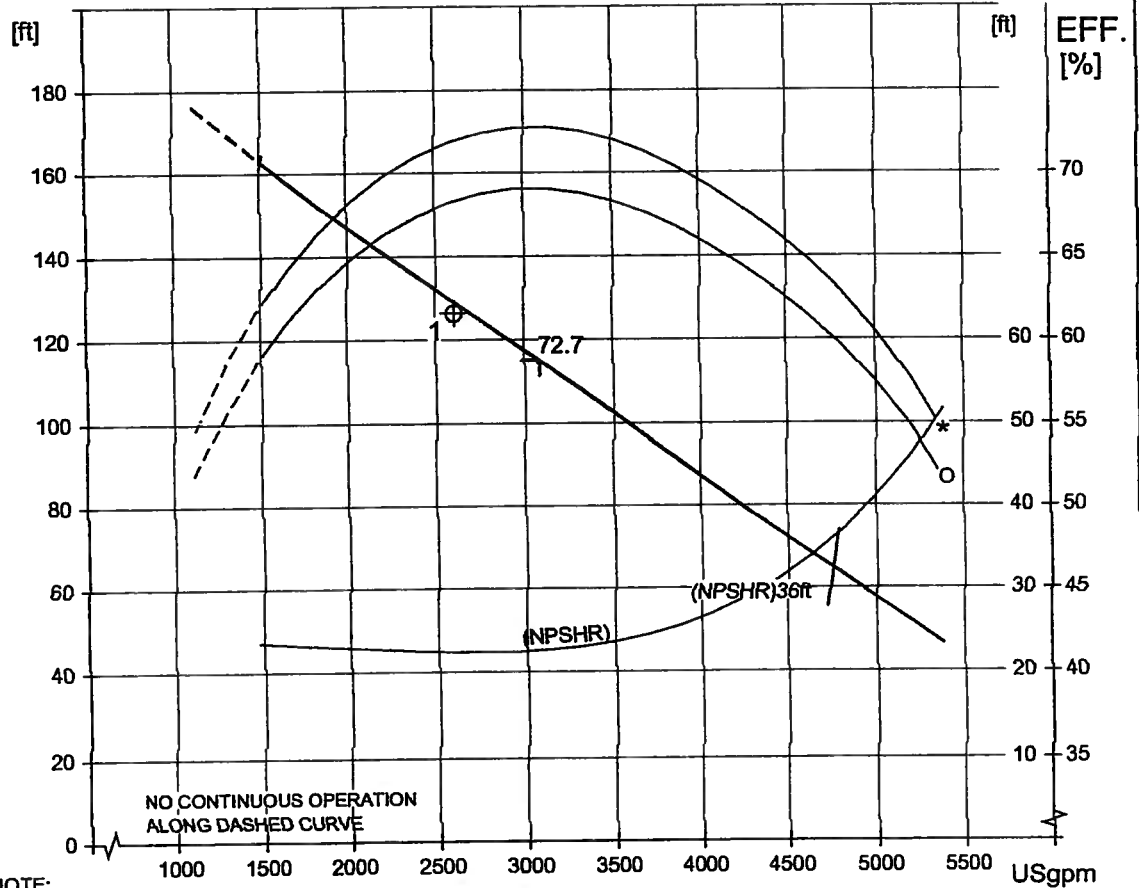

UNIX AUTHOR: JRODRIGU CUPF (rev:7.98)

NOTE:
CURVES SHOW PERFORMANCE WITH CLEAR COLD WATER.

* : PUMP EFFICIENCY / SHAFT POWER
O : OVERALL EFFICIENCY / INPUT POWER
(NPSHR) = (NPSH3) + margins

FLOW



Performance Curve

AMX434-193/5,5T

33-A (238)

Impeller

| | | | | |
|---|--------------------------------|--------------------------|---------------------------|--------------------------|
| Impeller type: Single vane impeller | Solid size Ø: 3 1/8" | Max. Ø: 8 1/8" | Min. Ø: 5 9/16" | Sel. Ø: 7 5/8" |
|---|--------------------------------|--------------------------|---------------------------|--------------------------|

Operating data

| | | | |
|---------------------------|----------------------------|--|---------------------------------|
| Speed: 1700 rpm | Frequency: 60 Hz | Duty point: Q = 400 US g.p.m. H = 33.9 ft | Suction port: 4" ANSI |
|---------------------------|----------------------------|--|---------------------------------|

Power data referred to: Water, pure [100%] ; 68°F; 62.322lb/R³; 1.0818E-5ft³/s Testnorm: ISO 9906

Curve number:

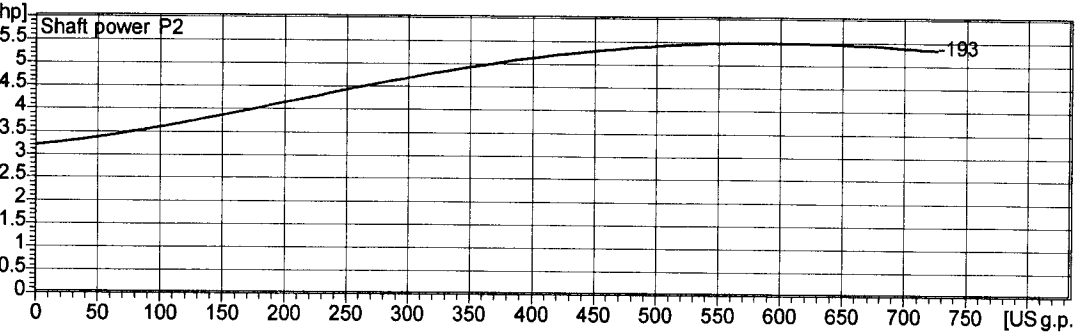
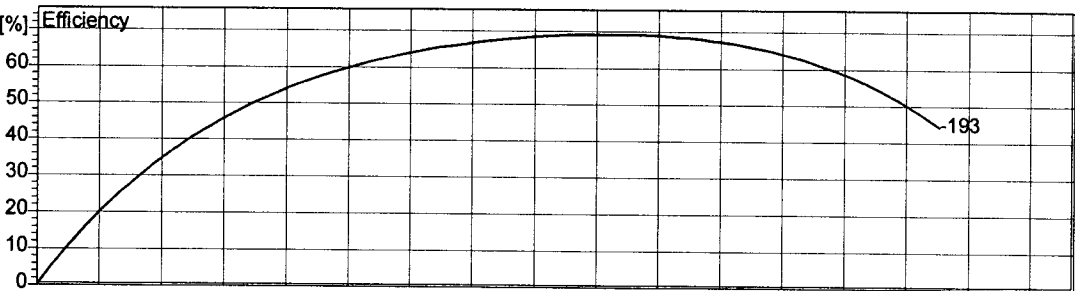
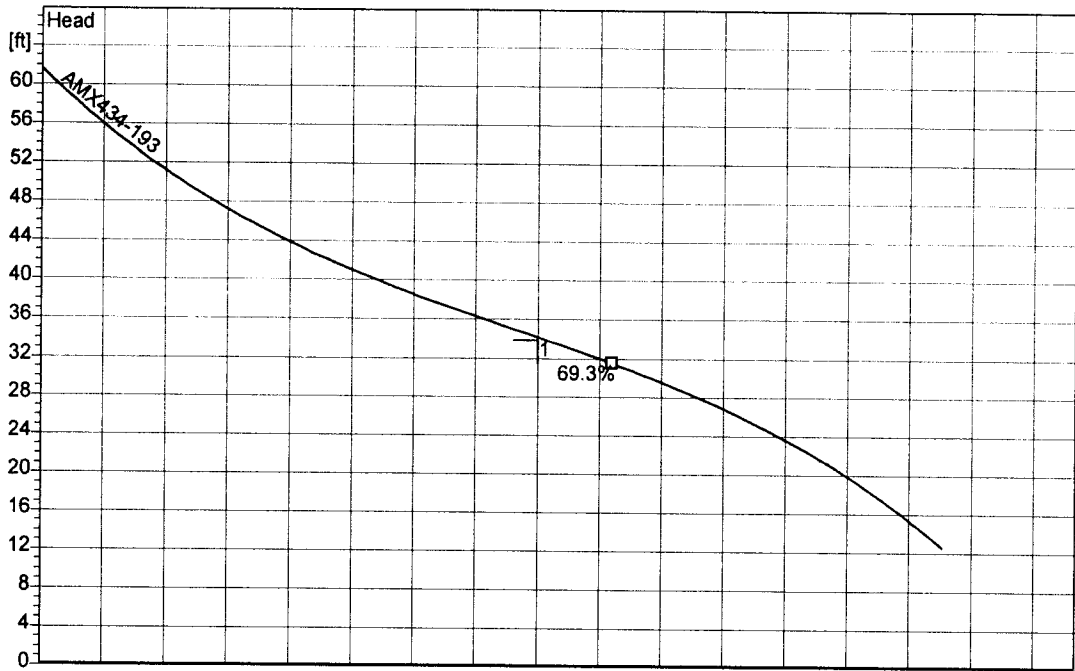

2.0 - 29.09.2004 (Build 60)

239 34-A

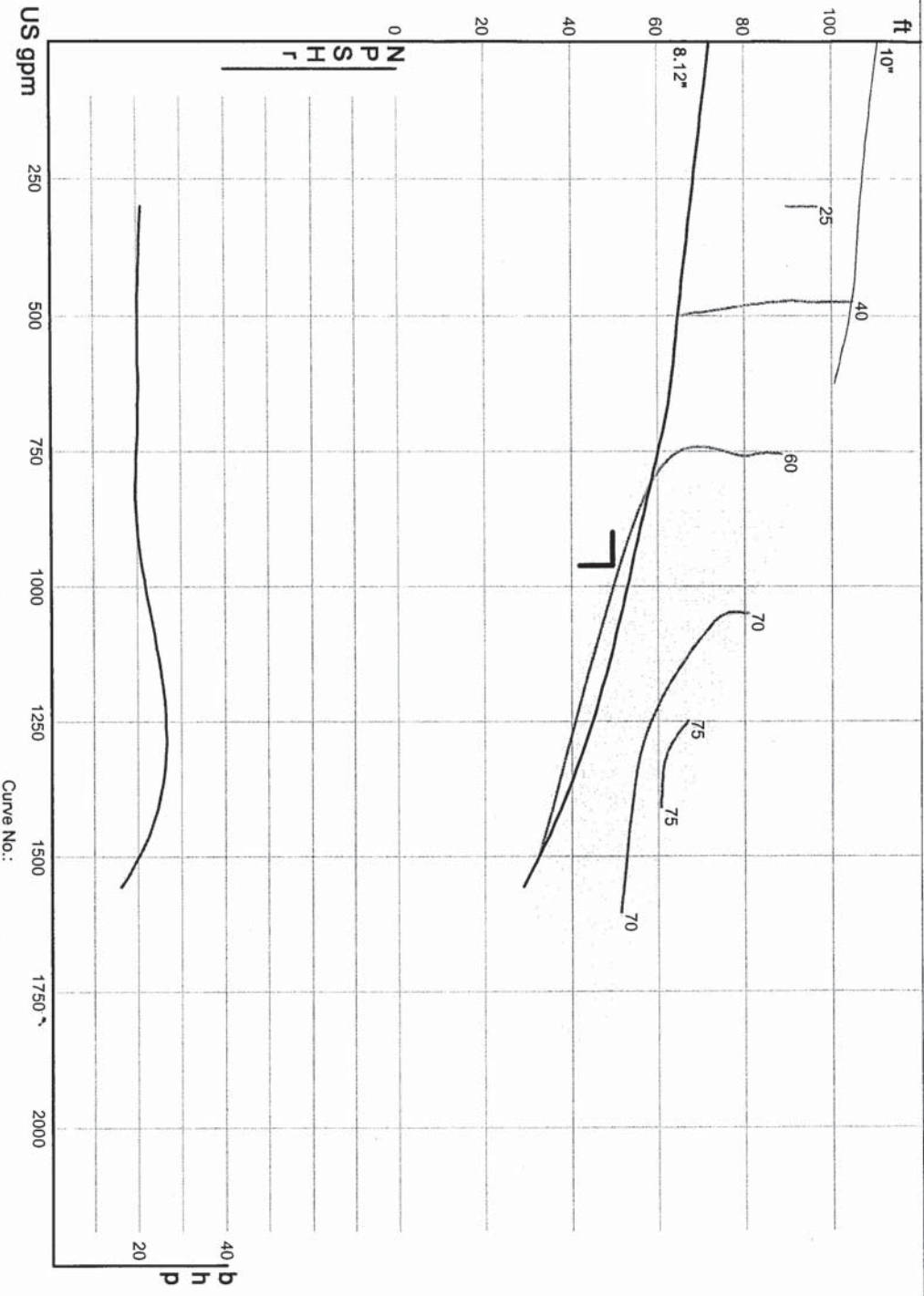

Curve No.:

Southeastern Pump

Crane/Barnes

Size: 6SE300*4HL

34-A

Catalog: Crane Barnes 60Hz, vers 8

Speed: 1750 rpm

02/09/06

1F6NONCLOG - 1800

Dia: 8.12 in

Design Point: 963 US gpm, 49 ft

BARNES

.ufs

Performance Curve

AMX434-235/13P/C

| Impeller | | | | | | |
|---|-----------------------------|--|---|---|---|-----------------------------------|
| Impeller type: Single channel impeller | Solid size 3 inch | Ø: | Max. Ø: 9¹³/₁₆" | Min. Ø: 8¹/₈" | Sel. Ø: 9¹/₄" | |
| Operating data | | | | | | |
| Speed: 1750 rpm | Frequency: 60 Hz | Duty point: Q = 250 US g.p.m. H = 64 ft | | | Suction port: | Discharge port: 4" ANSI |
| Power data referred to: Water, pure [100%]; 68°F; 62.322lb/ft ³ ; 1.0818E-5ft ² /s | | | | | Testnorm: | ISO 9906 |

Curve number:

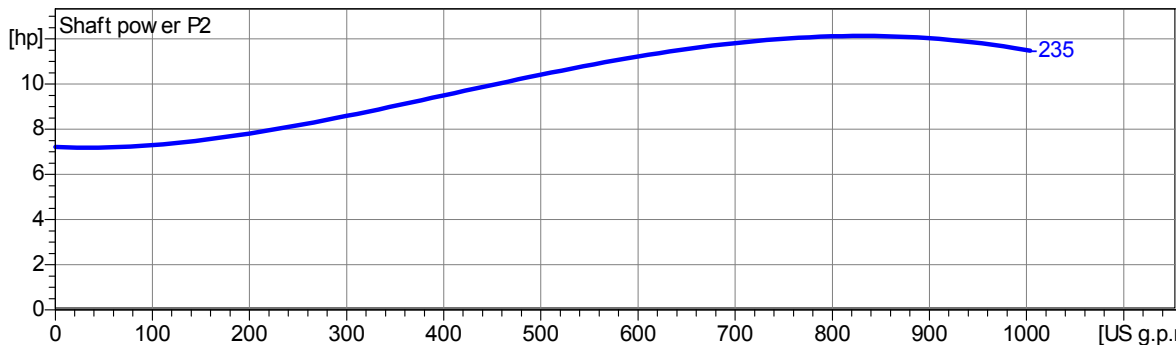
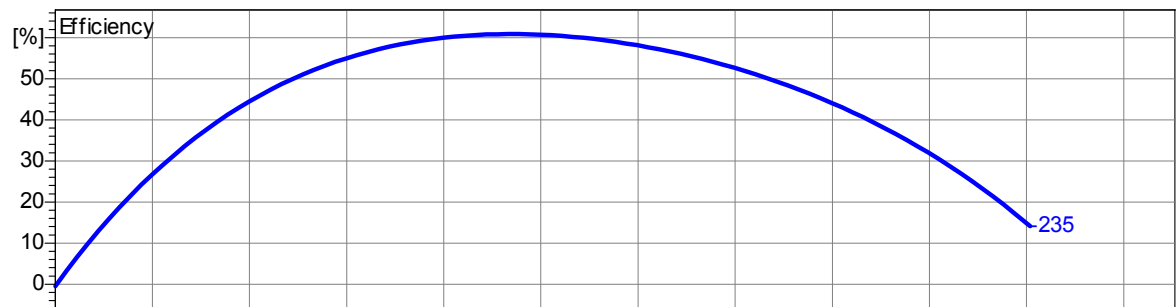
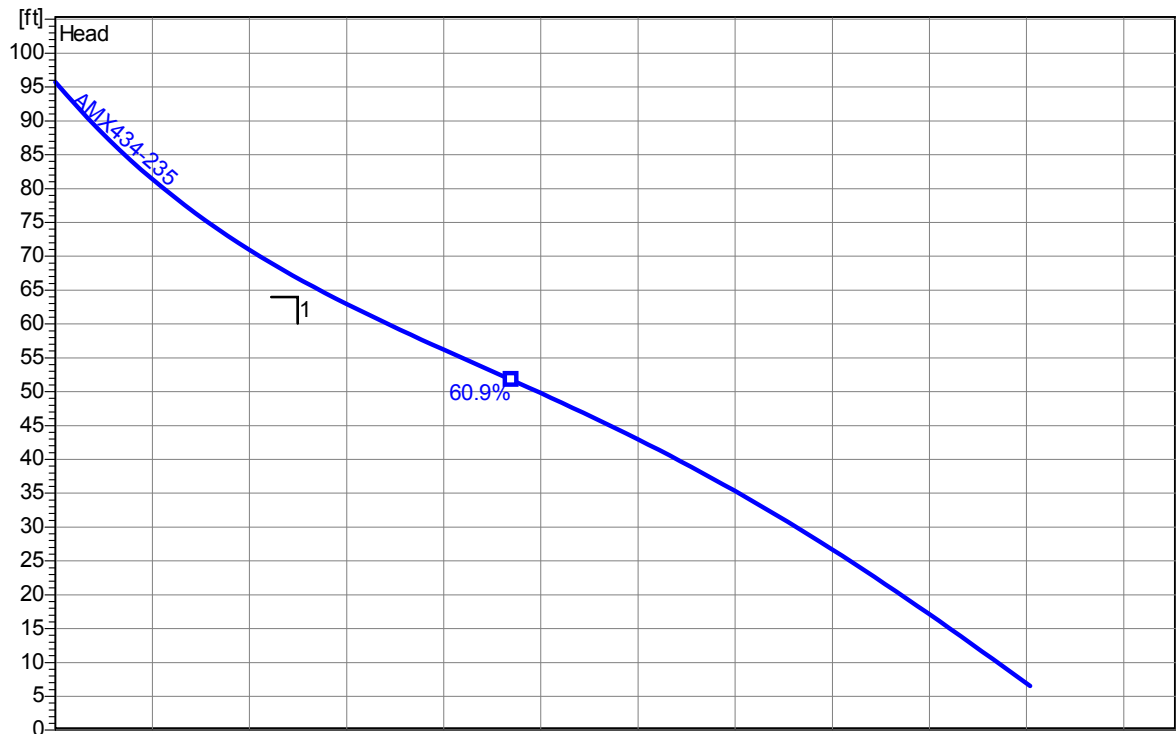

| | | | | |
|--|---|----------------------------------|-------------------|--------------------------|
| Project Man. Cty IFB #09-0897-OV | Project no.: Bayshore on the Lake | Created by: nyackerman | Page: 2 | Date: 4/1/2009 |
|--|---|----------------------------------|-------------------|--------------------------|

241 36-A

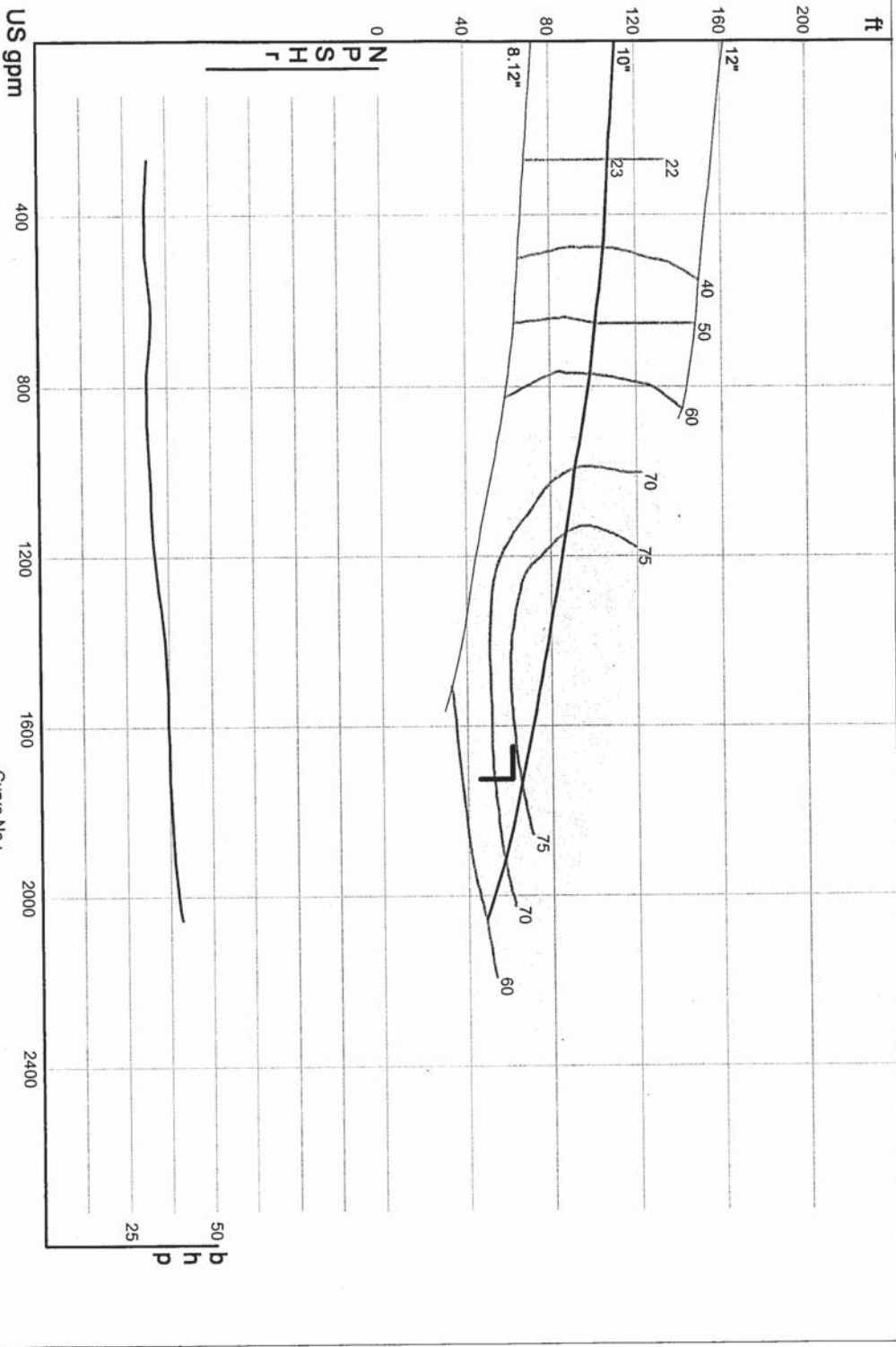

Curve No.:

Southeastern Pump

36-A

02/09/06

Crane/Barnes

Catalog: Crane Barnes 60Hz, vers 8

1F6NONCLOG - 1800

Design Point: 1719 US gpm, 60 ft

Size: 6SE480*4-HL

Speed: 1750 rpm

Dia: 10 in

BARNES

US

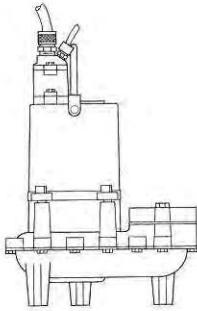

Lift Station 242

Performance Curve



RPM: **1750** Discharge: **3"** Solids: **2-1/2"**

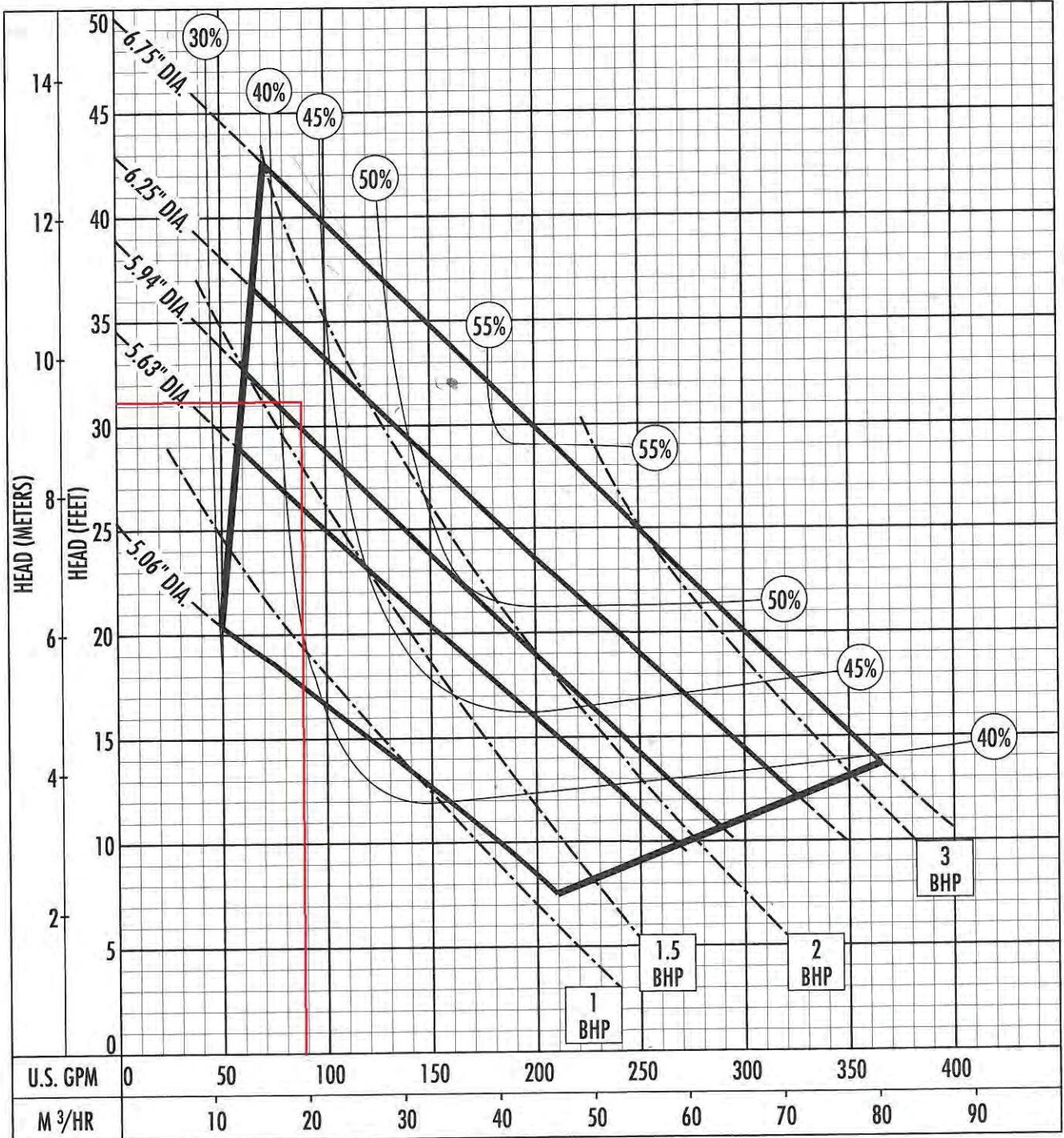

The curves reflect maximum performance characteristics without exceeding full load (Nameplate) horsepower. All pumps have a service factor of 1.2. Operation is recommended in the bounded area with operational point within the curve limit. Performance curves are based on actual tests with clear water at 70° F. and 1280 feet site elevation.

Conditions of Service:

Performance Curve – S4N/S4NX

RPM: 1150 DISCHARGE: 4" SOLIDS: 3"

Lift Station 243

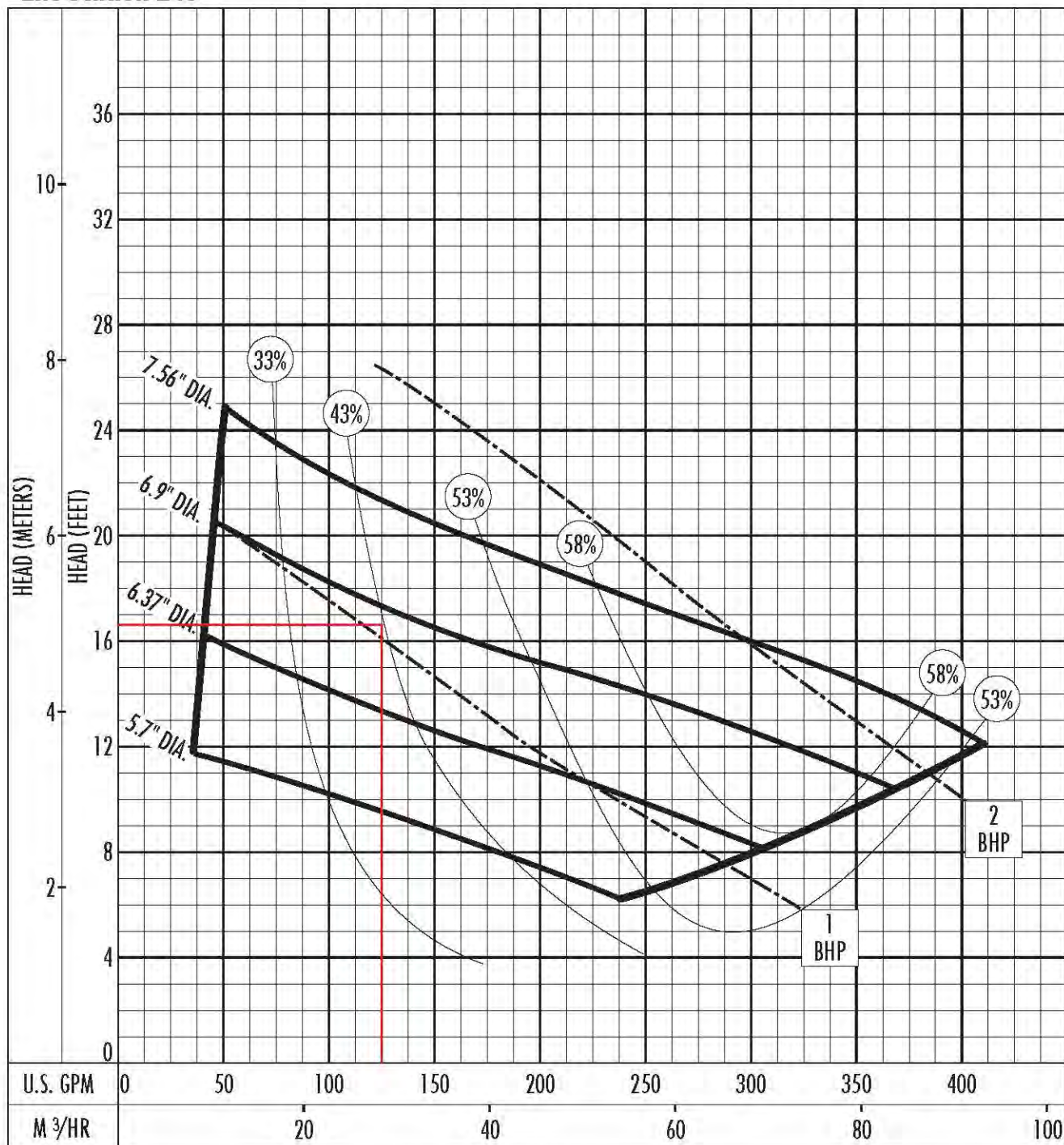

The curves reflect maximum performance characteristics without exceeding full load (Nameplate) horsepower. All pumps have a service factor of 1.2. Operation is recommended in the bounded area with operational point within the curve limit. Performance curves are based on actual tests with clear water at 70° F. and 1280 feet site elevation.

Conditions of Service:



HYDROMATIC

GPM: 125 TDH: 16.6

October © 2014 Pentair Ltd.

Performance Curve – S4N/S4NX

RPM: **1750** DISCHARGE: **4"** SOLIDS: **3"**

Lift Station 245

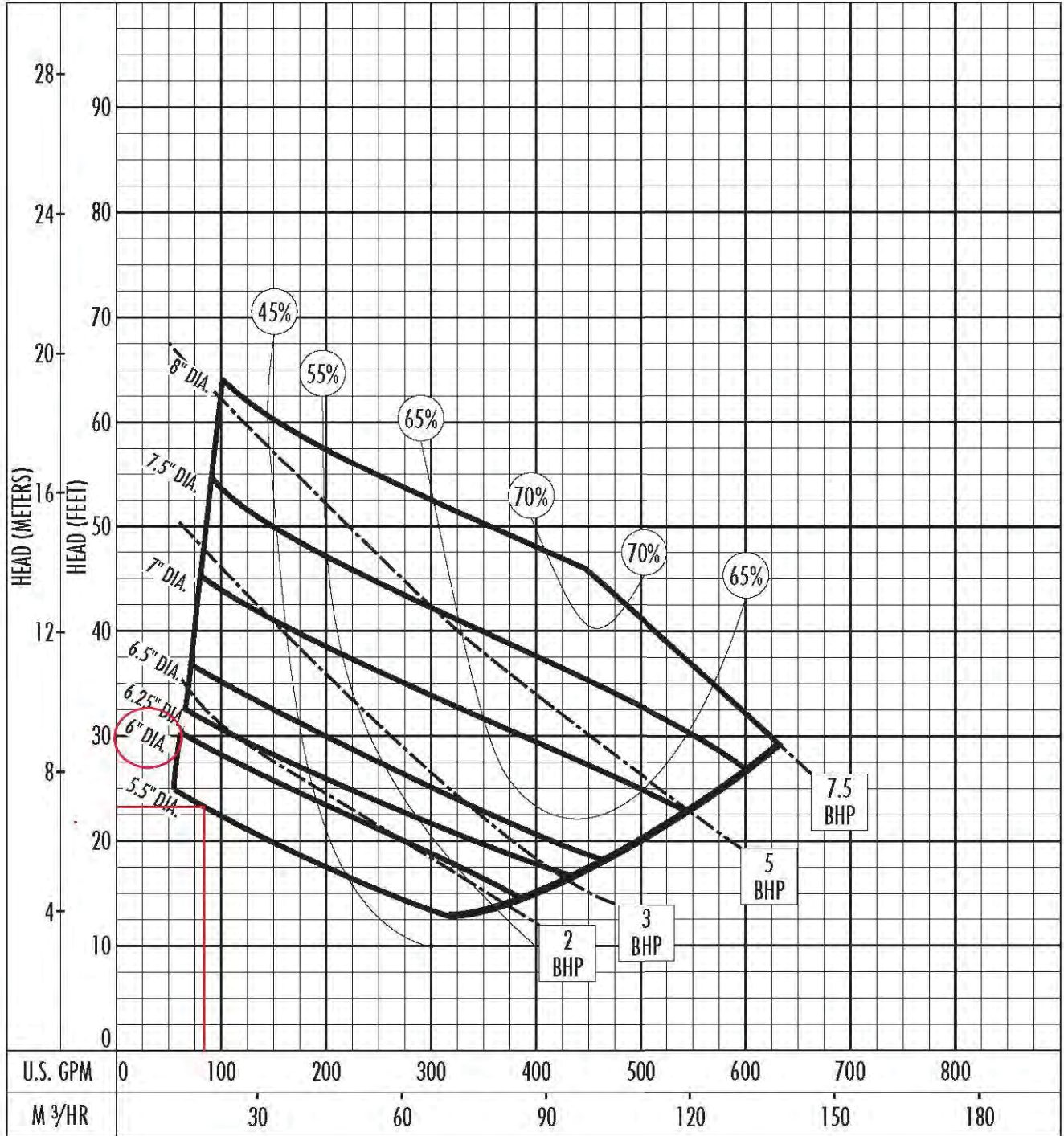

The curves reflect maximum performance characteristics without exceeding full load (Nameplate) horsepower. All pumps have a service factor of 1.2. Operation is recommended in the bounded area with operational point within the curve limit. Performance curves are based on actual tests with clear water at 70° F. and 1280 feet site elevation.

Conditions of Service:

Performance Curve – S4N/S4NX

RPM: **1750** DISCHARGE: **4"** SOLIDS: **3"**

Lift Station 246

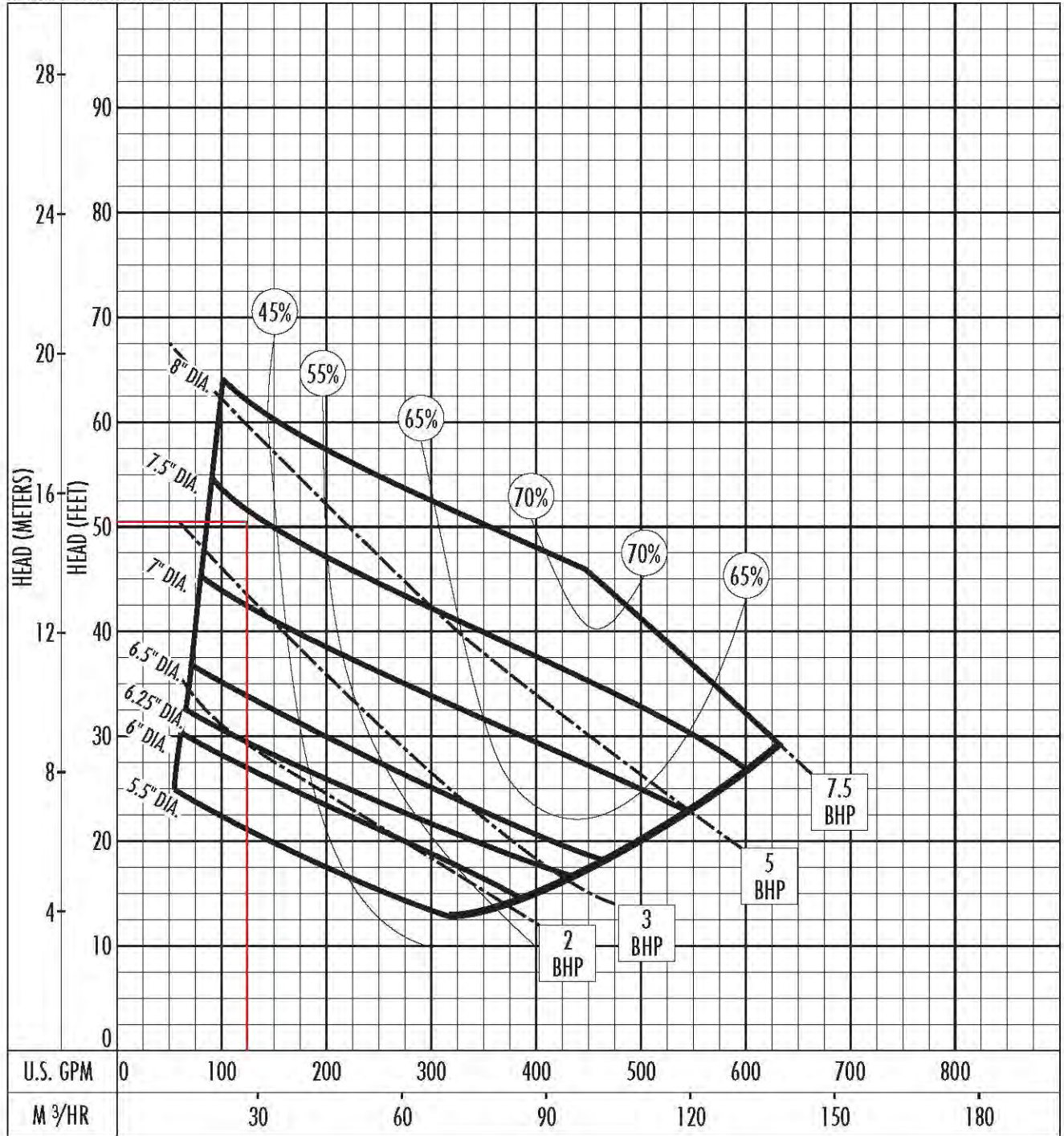

The curves reflect maximum performance characteristics without exceeding full load (Nameplate) horsepower. All pumps have a service factor of 1.2. Operation is recommended in the bounded area with operational point within the curve limit. Performance curves are based on actual tests with clear water at 70° F. and 1280 feet site elevation.

Conditions of Service:

Performance Curve – S3HRC/S3HVX

RPM: 3450 DISCHARGE: 3" SOLIDS: 2"

Lift Station 247

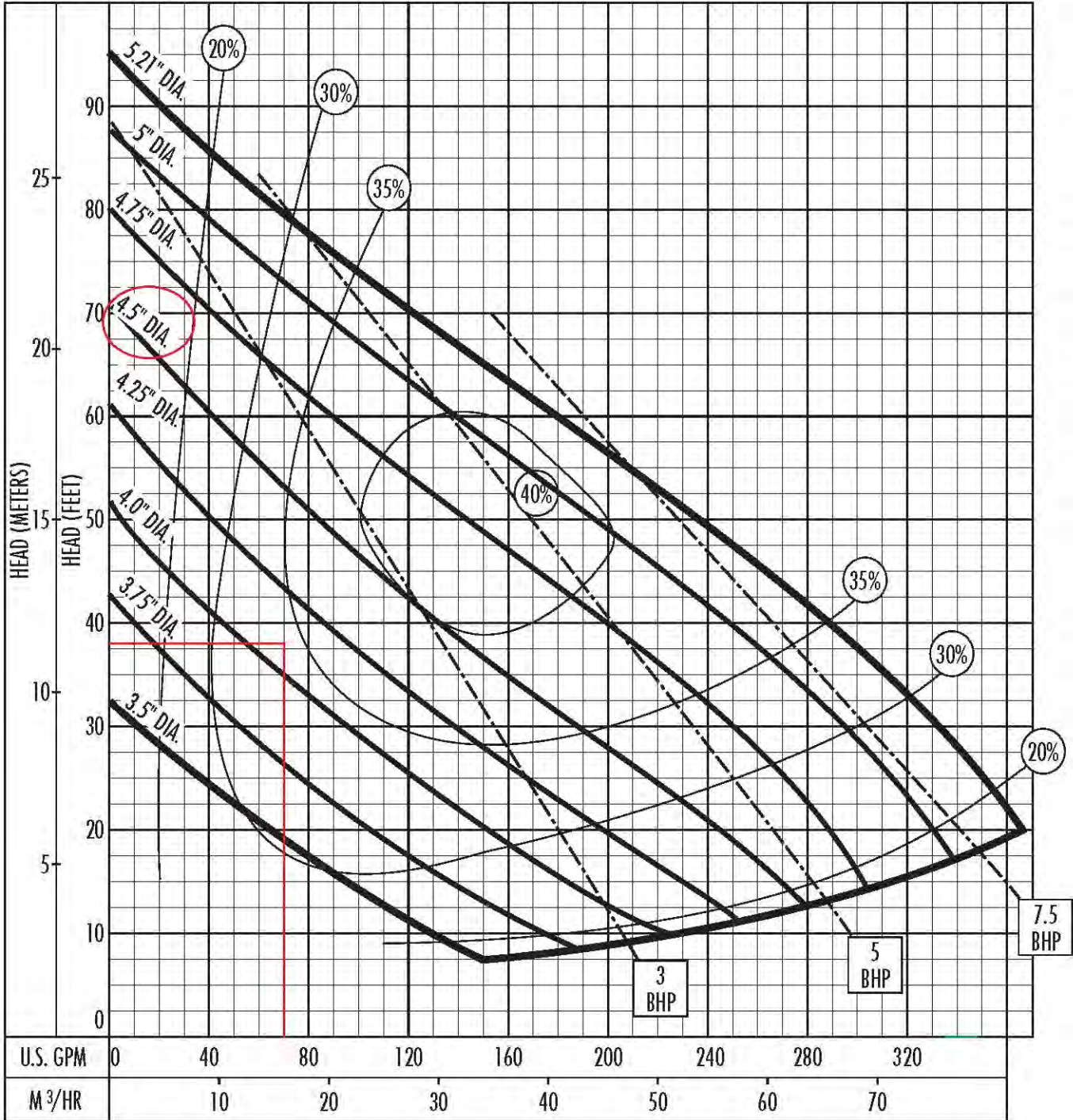

The curves reflect maximum performance characteristics without exceeding full load (Nameplate) horsepower. All pumps have a service factor of 1.2. Operation is recommended in the bounded area with operational point within the curve limit. Performance curves are based on actual tests with clear water at 70° F. and 1280 feet site elevation.

Conditions of Service:



HYDROMATIC

GPM: 70

TDH: 38

October © 2014 Pentair Ltd.

Pump Performance

30-AA

6VC300 w/ 10.25" Imp.

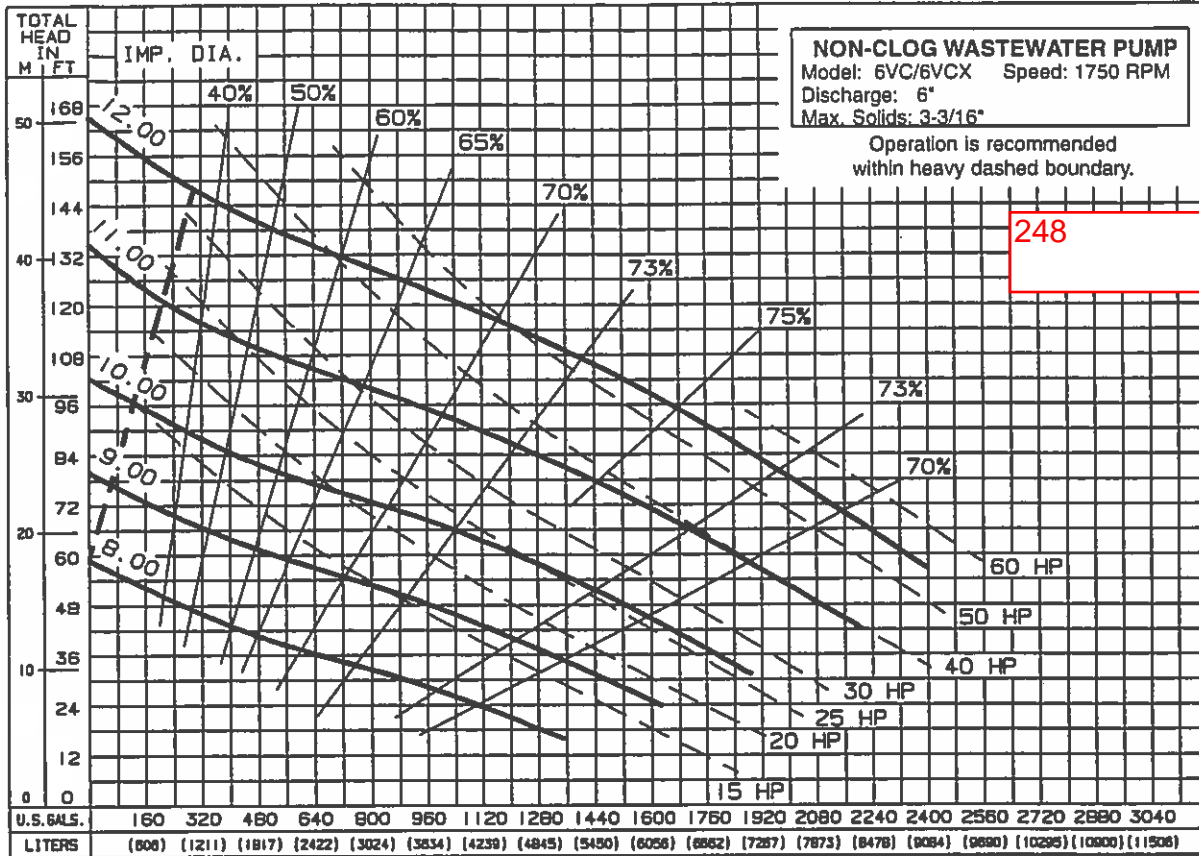

Pump performance is based on clear water (1.0 specific gravity @ 68°F) and pump fluid end (hydraulic) efficiency. Motor data based on 40°C ambient temperature.

| Available Models | | Motor Electrical Data | | | | | | | | | | | |
|------------------|-----------------|-----------------------|-------|-------|------------|----------|---------------------|--------|-------------------|-----------|---------|-----------------|----------------|
| Standard | Explosion Proof | HP | Volts | Phase | Start Amps | Run Amps | Service Factor Amps | Run KW | Service Factor KW | Start KVA | Run KVA | NEC Code Letter | Service Factor |
| 6VC150M4-03 | 6VCX150M4-03 | 15 | 200 | 3 | 215 | 50.6 | 61 | 15.0 | 18.6 | 74.5 | 17.5 | E | 1.2 |
| 6VC150M4-23 | 6VCX150M4-23 | 15 | 230 | 3 | 187 | 44 | 53 | 15.0 | 18.6 | 74.5 | 17.5 | E | 1.2 |
| 6VC150M4-43 | 6VCX150M4-43 | 15 | 460 | 3 | 93.5 | 22 | 26.5 | 15.0 | 18.6 | 74.5 | 17.5 | E | 1.2 |
| 6VC150M4-53 | 6VCX150M4-53 | 15 | 575 | 3 | 74.8 | 17.6 | 21.2 | 15.0 | 18.6 | 74.5 | 17.5 | E | 1.2 |
| 6VC200M4-23 | 6VCX200M4-23 | 20 | 230 | 3 | 290 | 60 | 72 | 21.2 | 26.1 | 115.5 | 23.9 | G | 1.2 |
| 6VC200M4-43 | 6VCX200M4-43 | 20 | 460 | 3 | 145 | 30 | 36 | 21.2 | 26.1 | 115.5 | 23.9 | G | 1.2 |
| 6VC200M4-53 | 6VCX200M4-53 | 20 | 575 | 3 | 116 | 24 | 28.8 | 21.2 | 26.1 | 115.5 | 23.9 | G | 1.2 |
| 6VC250M4-23 | 6VCX250M4-23 | 25 | 230 | 3 | 366 | 76 | 92 | 26.9 | 33.3 | 145.8 | 30.3 | G | 1.2 |
| 6VC250M4-43 | 6VCX250M4-43 | 25 | 460 | 3 | 183 | 38 | 46 | 26.9 | 33.3 | 145.8 | 30.3 | G | 1.2 |
| 6VC250M4-53 | 6VCX250M4-53 | 25 | 575 | 3 | 146 | 30.4 | 36.8 | 26.9 | 33.3 | 145.8 | 30.3 | G | 1.2 |
| 6VC300M4-23 | 6VCX300M4-23 | 30 | 230 | 3 | 452 | 94 | 114 | 33.3 | 41.3 | 180.1 | 37.4 | G | 1.2 |
| 6VC300M4-43 | 6VCX300M4-43 | 30 | 460 | 3 | 226 | 47 | 57 | 33.3 | 41.3 | 180.1 | 37.4 | G | 1.2 |
| 6VC300M4-53 | 6VCX300M4-53 | 30 | 575 | 3 | 181 | 37.6 | 45.6 | 33.3 | 41.3 | 180.1 | 37.4 | G | 1.2 |
| 6VC400M4-23 | 6VCX400M4-23 | 40 | 230 | 3 | 580 | 122 | 148 | 43.2 | 53.0 | 231.1 | 48.6 | G | 1.2 |
| 6VC400M4-43 | 6VCX400M4-43 | 40 | 460 | 3 | 290 | 61 | 74 | 43.2 | 53.0 | 231.1 | 48.6 | G | 1.2 |
| 6VC400M4-53 | 6VCX400M4-53 | 40 | 575 | 3 | 232 | 48.8 | 59.2 | 43.2 | 53.0 | 231.1 | 48.6 | G | 1.2 |
| 6VC500M4-23 | 6VCX500M4-23 | 50 | 230 | 3 | 580 | 134 | 158 | 46.9 | 54.6 | 231.1 | 53.4 | E | 1.2 |
| 6VC500M4-43 | 6VCX500M4-43 | 50 | 460 | 3 | 290 | 67 | 79 | 46.9 | 54.6 | 231.1 | 53.4 | E | 1.2 |
| 6VC500M4-53 | 6VCX500M4-53 | 50 | 575 | 3 | 232 | 54 | 63 | 46.9 | 54.6 | 231.1 | 53.4 | E | 1.2 |
| 6VC600M4-23 | 6VCX600M4-23 | 60 | 230 | 3 | 580 | 158 | 158 | 52.8 | 52.8 | 231.1 | 62.9 | C | 1.0 |
| 6VC600M4-43 | 6VCX600M4-43 | 60 | 460 | 3 | 290 | 79 | 79 | 52.8 | 52.8 | 231.1 | 62.9 | C | 1.0 |
| 6VC600M4-53 | 6VCX600M4-53 | 60 | 575 | 3 | 232 | 63 | 63 | 52.8 | 52.8 | 231.1 | 62.9 | C | 1.0 |

| Motor Efficiencies and Power Factor | | | | | | | | | |
|-------------------------------------|-------|---------------------|-----------|----------|----------------|---------------------|-----------|----------|----------|
| Motor Efficiency % | | | | | Power Factor % | | | | |
| HP | Phase | Service Factor Load | 100% Load | 75% Load | 50% Load | Service Factor Load | 100% Load | 75% Load | 50% Load |
| 15 | 3 | 85 | 84 | 79 | 69 | 88 | 86 | 78 | 68 |
| 20 | 3 | 88 | 87.5 | 81 | 72.5 | 91 | 89 | 79 | 69 |
| 25 | 3 | 87 | 86 | 81 | 73 | 91 | 89 | 80 | 70 |
| 30 | 3 | 87 | 86 | 83 | 79 | 91 | 89 | 82 | 73 |
| 40 | 3 | 86 | 86 | 88 | 87.5 | 90 | 89 | 86 | 80 |
| 50 | 3 | 87 | 86 | 86.5 | 88 | 87 | 88 | 88.5 | 84 |
| 60 | 3 | 87 | 87 | 86 | 88 | 84 | 84 | 89 | 86 |

Company: Manatee County Utilities

Name: 4M - RTU 249

Date: 4/9/2012



Pump:

Size: S4N/S4NX
 Type: NCLOG-4
 Synch speed: 1800 rpm
 Curve: PAGE 109
 Specific Speeds:
 Dimensions:
 Speed: 1750 rpm
 Dia: 6.5 in
 Impeller:
 Ns: ---
 Nss: ---
 Suction: --- in
 Discharge: 4 in

Search Criteria:

Flow: --- US gpm Head: --- ft

Fluid:

Water
 Density: 62.37 lb/ft³
 Viscosity: 1.105 cP
 NPSHa: --- ft
 Temperature: 60 °F
 Vapor pressure: 0.2563 psi a
 Atm pressure: 14.7 psi a

Motor:

Consult HYDROMATIC to select a motor for this pump.

Pump Limits:

Temperature: 140 °F
 Pressure: 125 psi g
 Sphere size: 3 in
 Power: --- hp
 Eye area: --- in²

---- Data Point ----

Flow: 450 US gpm
 Head: 18.5 ft
 Eff: 64%
 Power: 3.3 hp
 NPSHr: --- ft

---- Design Curve ----

Shutoff head: 40.3 ft
 Shutoff dP: 17.5 psi
 Min flow: 45 US gpm
 BEP: 64% @ 425 US gpm
 NOL power:
 3.34 hp @ 463 US gpm

-- Max Curve --

Max power:
 9.61 hp @ 677 US gpm

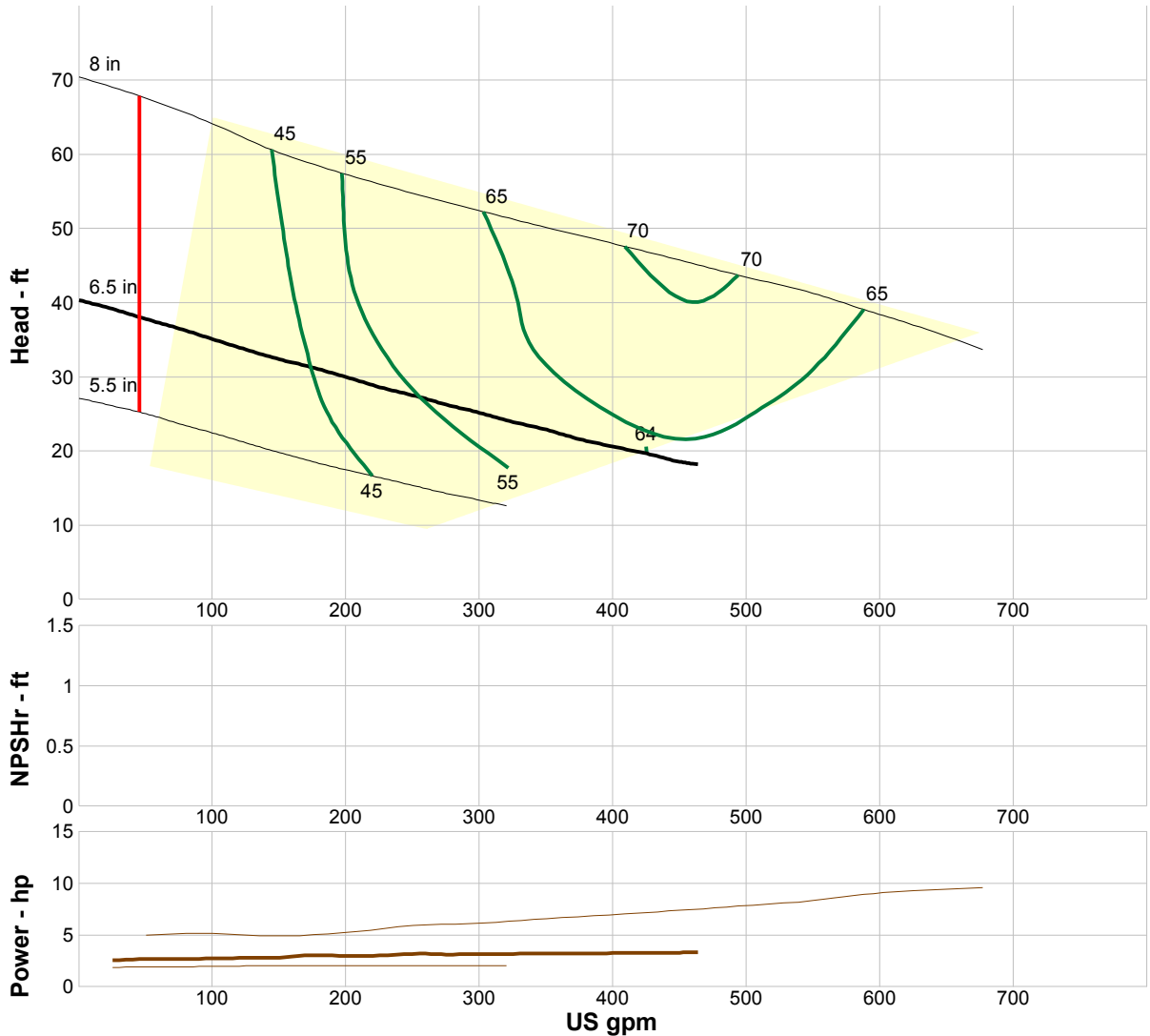

Performance Evaluation:

| Flow US gpm | Speed rpm | Head ft | Efficiency % | Power hp | NPSHr ft |
|----------------|--------------|------------|-----------------|-------------|-------------|
| 445 | 1750 | 18.8 | 64 | 3.3 | --- |
| 371 | 1750 | 21.8 | 64 | 3.21 | --- |
| 297 | 1750 | 25.3 | 60 | 3.16 | --- |
| 223 | 1750 | 28.7 | 54 | 3.01 | --- |
| 148 | 1750 | 32.5 | 43 | 2.83 | --- |

Fiddler's Green (250)

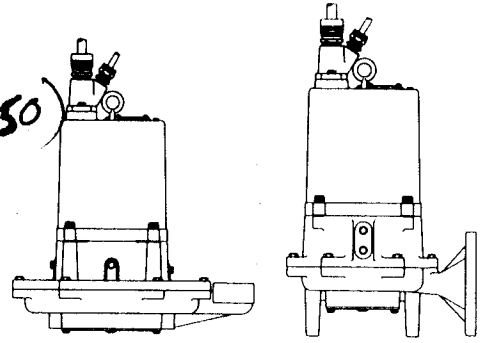

Performance Curve

HPGF/HPGFH

RPM: **1750**

Discharge: **2"**

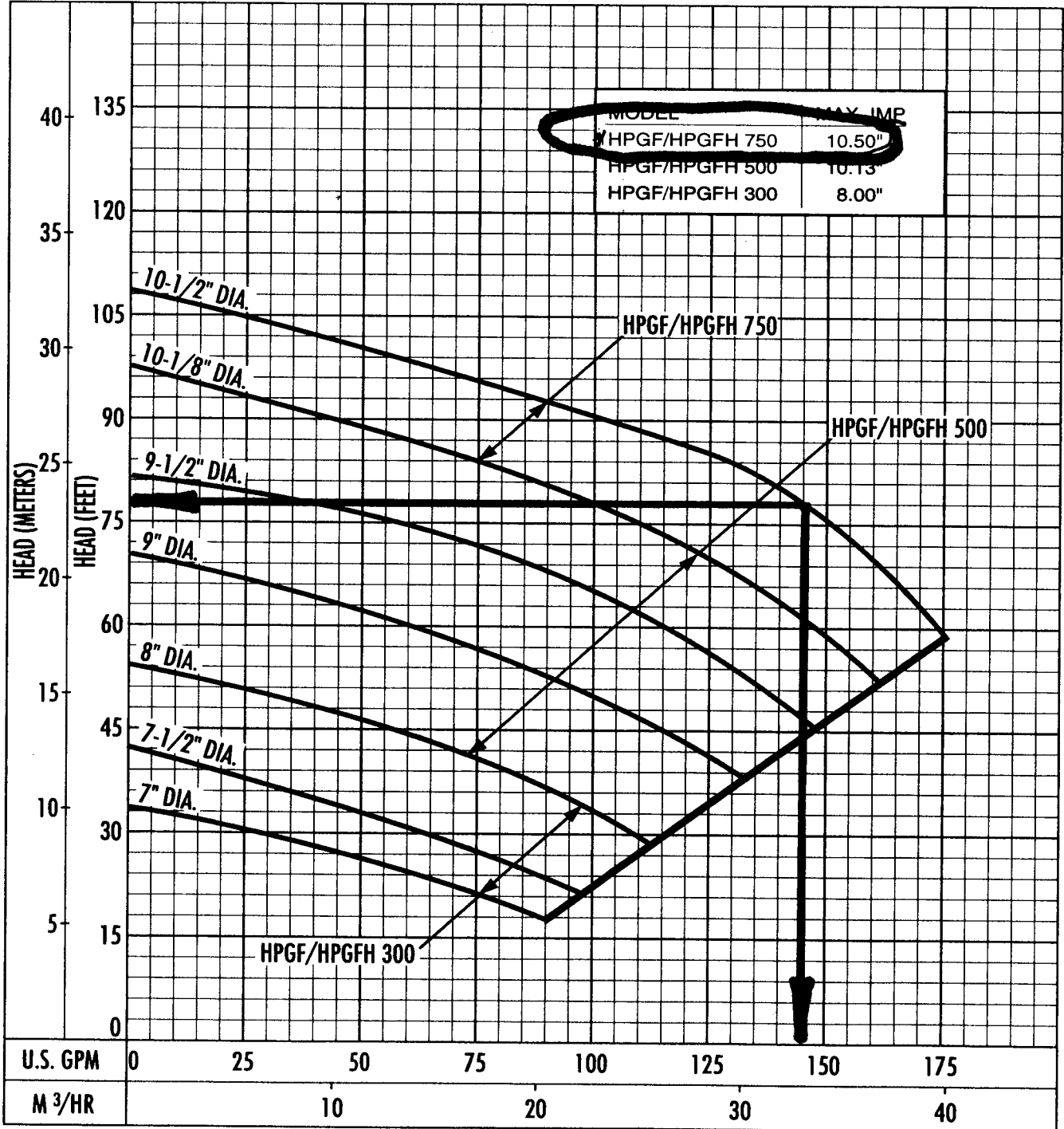

The curves reflect maximum performance characteristics without exceeding full load (Nameplate) horsepower. All pumps have a service factor of 1.2. Operation is recommended in the bounded area with operational point within the curve limit. Performance curves are based on actual tests with clear water at 70° F. and 1280 feet site elevation.

Performance Curve – S4N/S4NX

RPM: **1750** DISCHARGE: **4"** SOLIDS: **3"**

Lift Station 251

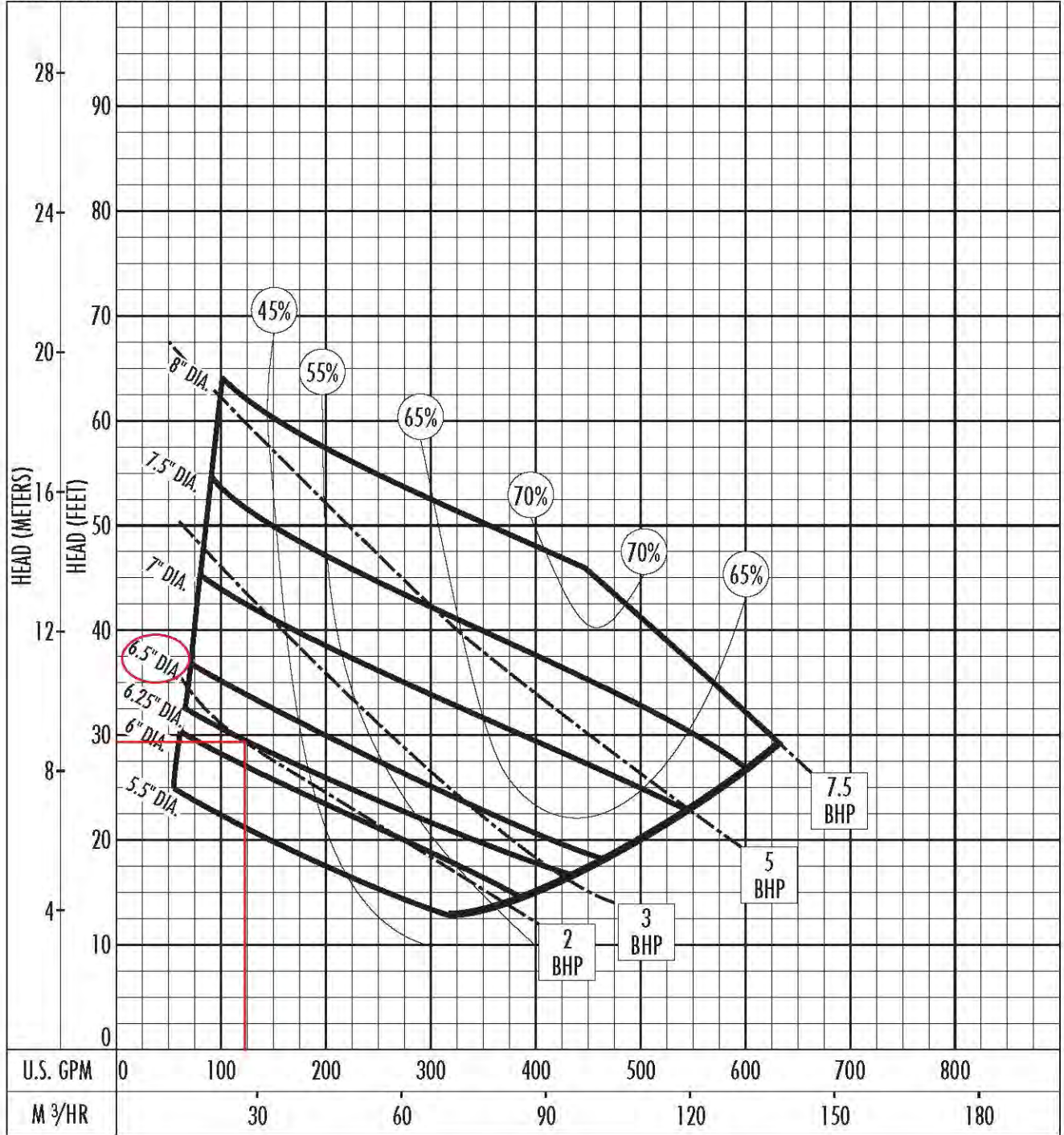

The curves reflect maximum performance characteristics without exceeding full load (Nameplate) horsepower. All pumps have a service factor of 1.2. Operation is recommended in the bounded area with operational point within the curve limit. Performance curves are based on actual tests with clear water at 70° F. and 1280 feet site elevation.

Conditions of Service:

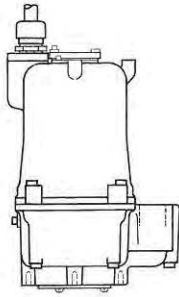

Lift Station 257

Performance Curve

SPG/SPGL

RPM: **3500** Discharge: **1-1/4"**

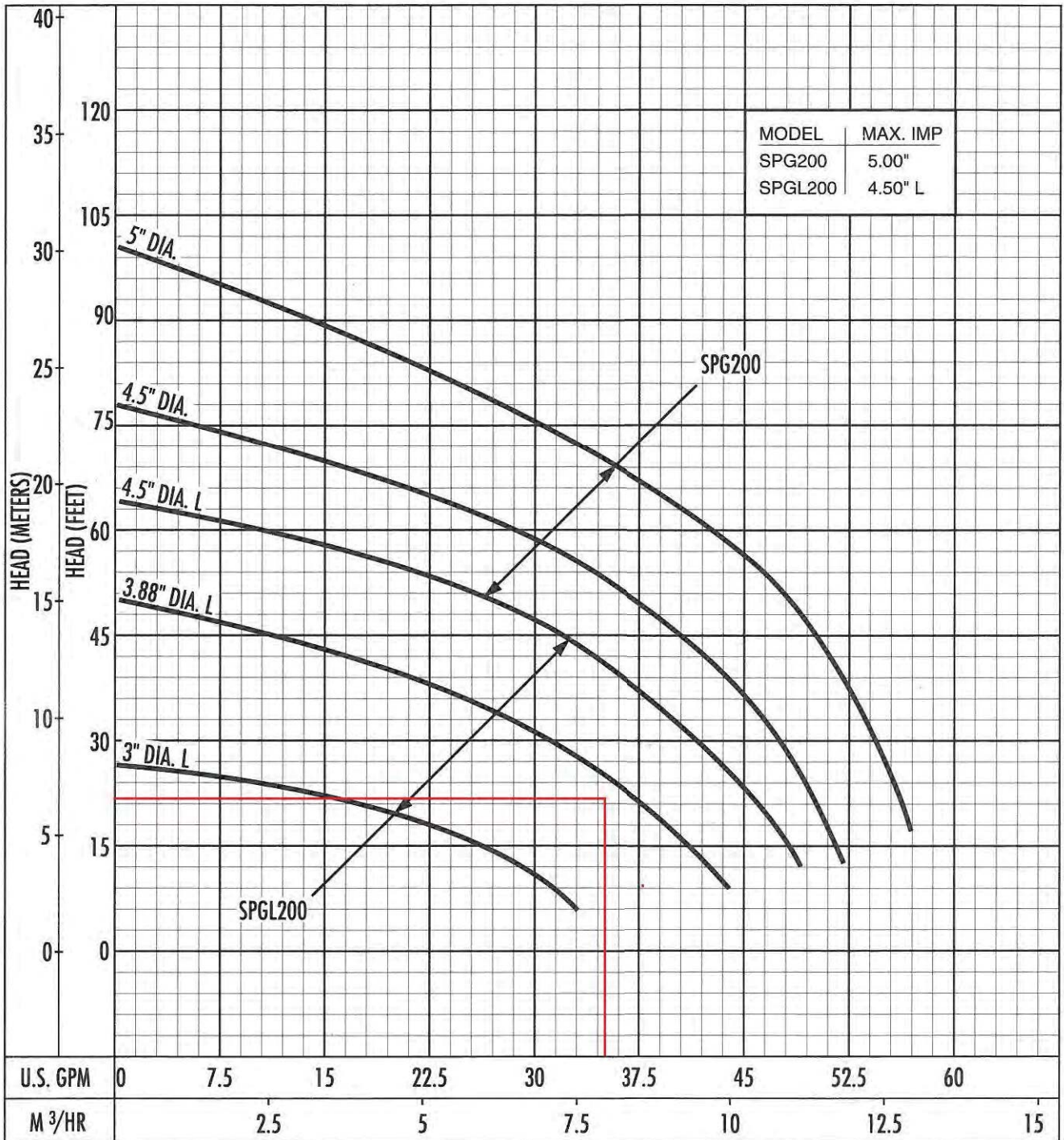

Operating point must fall within curve.

Performance Data and Dimensions (Dimensions in mm)

LIFT STATION 258

3450 RPM

GPM: 8 TDH: 11.1

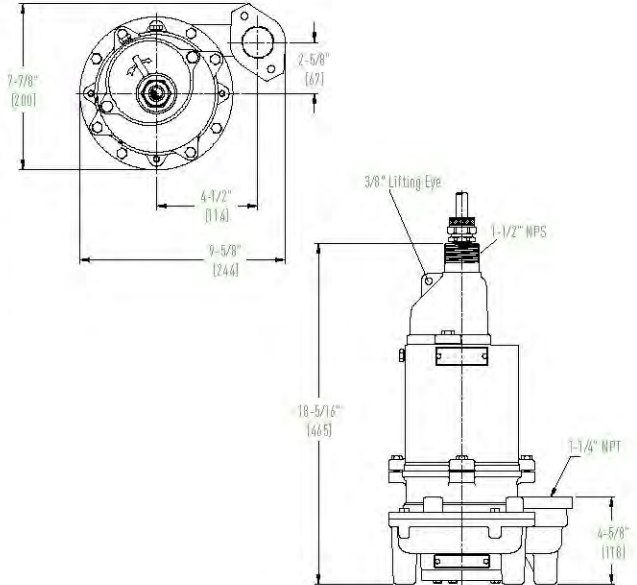
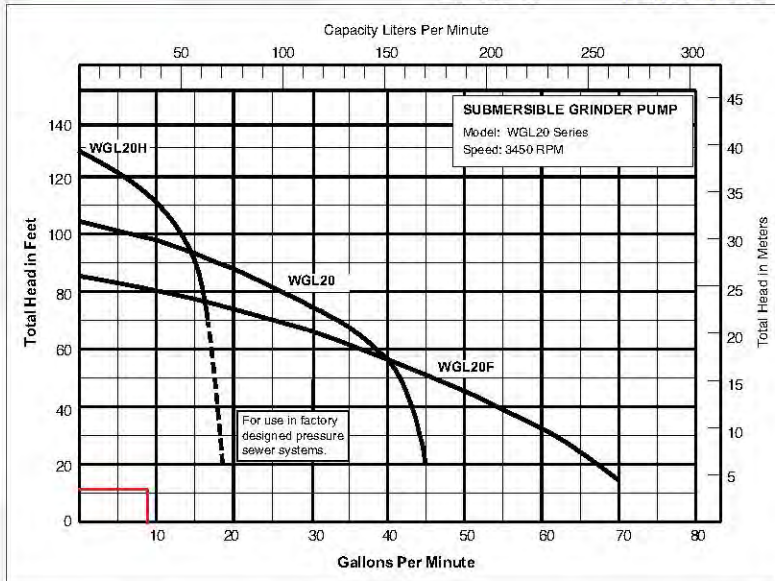

| Available Models | | | | Motor Electrical Data | | | | | | | NEC Code Letter | Service Factor |
|------------------|----|-------|-------|-----------------------|------------|----------|--------|-----------|---------|---|-----------------|----------------|
| Standard | HP | Volts | Phase | Hertz | Start Amps | Run Amps | Run kW | Start KVA | Run KVA | | | |
| WGL20-01 | 2 | 200 | 1 | 60 | 50.0 | 15.0 | 2.8 | 10.0 | 3.0 | F | 1.25 | |
| WGL20-01(LD) | 2 | 200 | 1 | 60 | 50.0 | 15.0 | 2.8 | 10.0 | 3.0 | F | 1.25 | |
| WGL20-03 | 2 | 200 | 3 | 60 | 30.0 | 9.7 | 2.9 | 10.4 | 3.3 | F | 1.25 | |
| WGL20-21 | 2 | 230 | 1 | 60 | 44.0 | 12.0 | 2.8 | 10.1 | 2.8 | F | 1.25 | |
| WGL20-21(LD) | 2 | 230 | 1 | 60 | 44.0 | 12.0 | 2.8 | 10.1 | 2.8 | F | 1.25 | |
| WGL20-23 | 2 | 230 | 3 | 60 | 27.5 | 8.4 | 2.9 | 11.0 | 3.3 | F | 1.25 | |
| WGL20-23(LD) | 2 | 230 | 3 | 60 | 27.5 | 8.4 | 2.9 | 11.0 | 3.3 | F | 1.25 | |
| WGL20-43 | 2 | 460 | 3 | 60 | 13.8 | 4.2 | 2.9 | 11.0 | 3.3 | F | 1.25 | |
| WGL20-43(LD) | 2 | 460 | 3 | 60 | 13.8 | 4.2 | 2.9 | 11.0 | 3.3 | F | 1.25 | |
| WGL20-53 | 2 | 575 | 3 | 60 | 11.0 | 3.4 | 2.9 | 11.0 | 3.3 | F | 1.25 | |
| WGL20H-01 | 2 | 200 | 1 | 60 | 50.0 | 15.0 | 2.8 | 10.0 | 3.0 | F | 1.25 | |
| WGL20H-03 | 2 | 200 | 3 | 60 | 30 | 9.7 | 2.9 | 10.4 | 3.3 | F | 1.25 | |
| WGL20H-21 | 2 | 230 | 1 | 60 | 44.0 | 12.0 | 2.8 | 10.1 | 2.8 | F | 1.25 | |
| WGL20H-01(LD) | 2 | 200 | 1 | 60 | 50.0 | 15.0 | 2.8 | 10.0 | 3.0 | F | 1.25 | |
| WGL20H-21(LD) | 2 | 230 | 1 | 60 | 44.0 | 12.0 | 2.8 | 10.1 | 2.8 | F | 1.25 | |
| WGL20H-23 | 2 | 230 | 3 | 60 | 30.0 | 8.4 | 2.9 | 10.4 | 3.3 | F | 1.25 | |
| WGL20H-23(LD) | 2 | 230 | 3 | 60 | 30.0 | 8.4 | 2.9 | 10.4 | 3.3 | F | 1.25 | |
| WGL20H-43 | 2 | 460 | 3 | 60 | 13.8 | 4.2 | 2.9 | 11.0 | 3.3 | F | 1.25 | |
| WGL20H-43(LD) | 2 | 460 | 3 | 60 | 13.8 | 4.2 | 2.9 | 11.0 | 3.3 | F | 1.25 | |
| WGL20F-01 | 2 | 200 | 1 | 60 | 50.0 | 15.0 | 2.8 | 10.0 | 3.0 | F | 1.25 | |
| WGL20F-03 | 2 | 200 | 3 | 60 | 30 | 9.7 | 2.9 | 10.4 | 3.3 | F | 1.25 | |
| WGL20F-21 | 2 | 230 | 1 | 60 | 44.0 | 12.0 | 2.8 | 10.1 | 2.8 | F | 1.25 | |
| WGL20F-01(LD) | 2 | 200 | 1 | 60 | 50.0 | 15.0 | 2.8 | 10.0 | 3.0 | F | 1.25 | |
| WGL20F-21(LD) | 2 | 230 | 1 | 60 | 44.0 | 12.0 | 2.8 | 10.1 | 2.8 | F | 1.25 | |
| WGL20F-23 | 2 | 230 | 3 | 60 | 30.0 | 8.4 | 2.9 | 10.4 | 3.3 | F | 1.25 | |
| WGL20F-23(LD) | 2 | 230 | 3 | 60 | 30.0 | 8.4 | 2.9 | 10.4 | 3.3 | F | 1.25 | |
| WGL20F-43 | 2 | 460 | 3 | 60 | 13.8 | 4.2 | 2.9 | 11.0 | 3.3 | F | 1.25 | |
| WGL20F-43(LD) | 2 | 460 | 3 | 60 | 13.8 | 4.2 | 2.9 | 11.0 | 3.3 | F | 1.25 | |

NOTE: Minimum impeller diameter available is 3-3/4".



740 EAST 9TH STREET,
ASHLAND, OHIO 44805
WWW.FEMYERS.COM

269 TRILLIUM DRIVE, KITCHENER,
ONTARIO, CANADA N2G 4W5
WWW.FEMYERS.COM

Because we are continuously improving our products and services, Pentair reserves the right to change specifications without prior notice.
K3140 1/15/13 © 2013 Pentair Ltd. All Rights Reserved.

26-D RTU 259

Selection chart

Single Phase

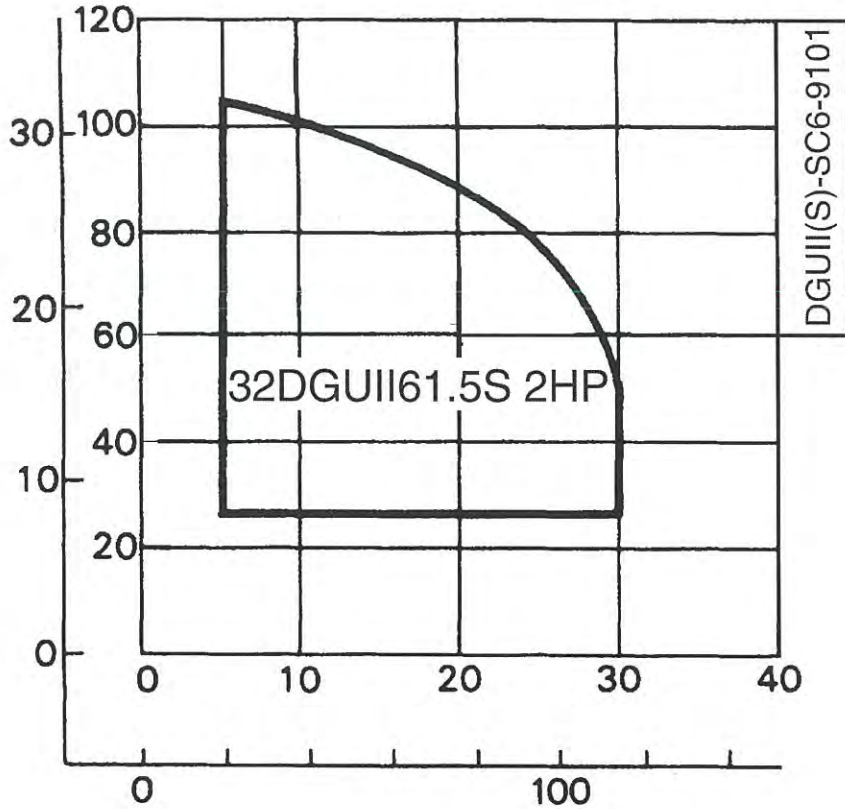

260

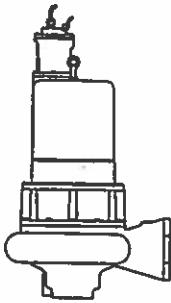

NOTE: FOR USE WITH M-T-M AND PULTRUDED RAIL SYSTEM ONLY.

Performance Curve

S4B

RPM: **1750** Discharge: **4"** Solids: **3"**

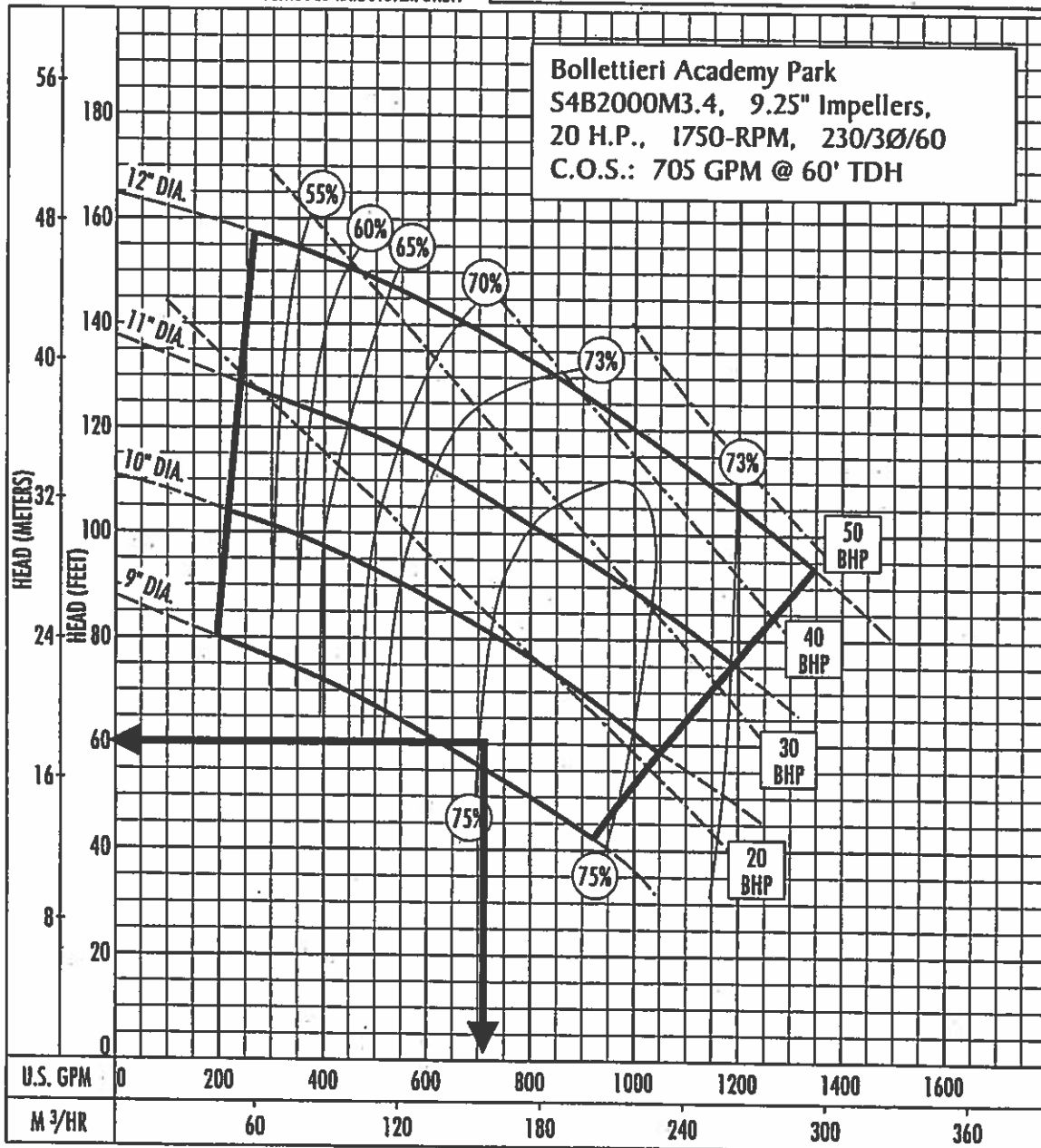

The curves reflect maximum performance characteristics without exceeding full load (Nameplate) horsepower. All pumps have a service factor of 1.2. Operation is recommended in the bounded area with operational point within the curve limit. Performance curves are based on actual tests with clear water at 70° F. and 1280 feet site elevation.

Conditions of Service:

GPM: 705 TDH: 60'



Performance Curves

Project: **Lift Station 261** GPM: **50** TDH: **43** EFF: HP: Chk'd: Date:

32DGUII61.5S (2HP) Synchronous Speed: 3600 RPM

1 1/4 inch Discharge

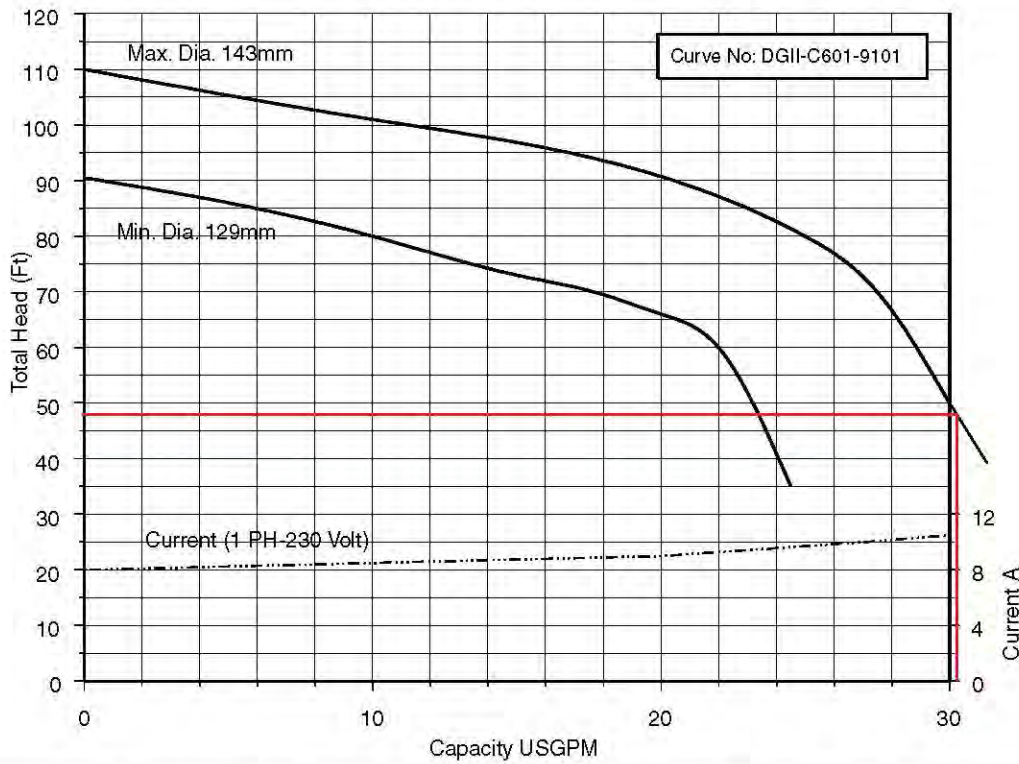

32DGF61.5S 32DGFU61.5 (2HP) Synchronous Speed: 3600 RPM 1 1/4 inch Discharge

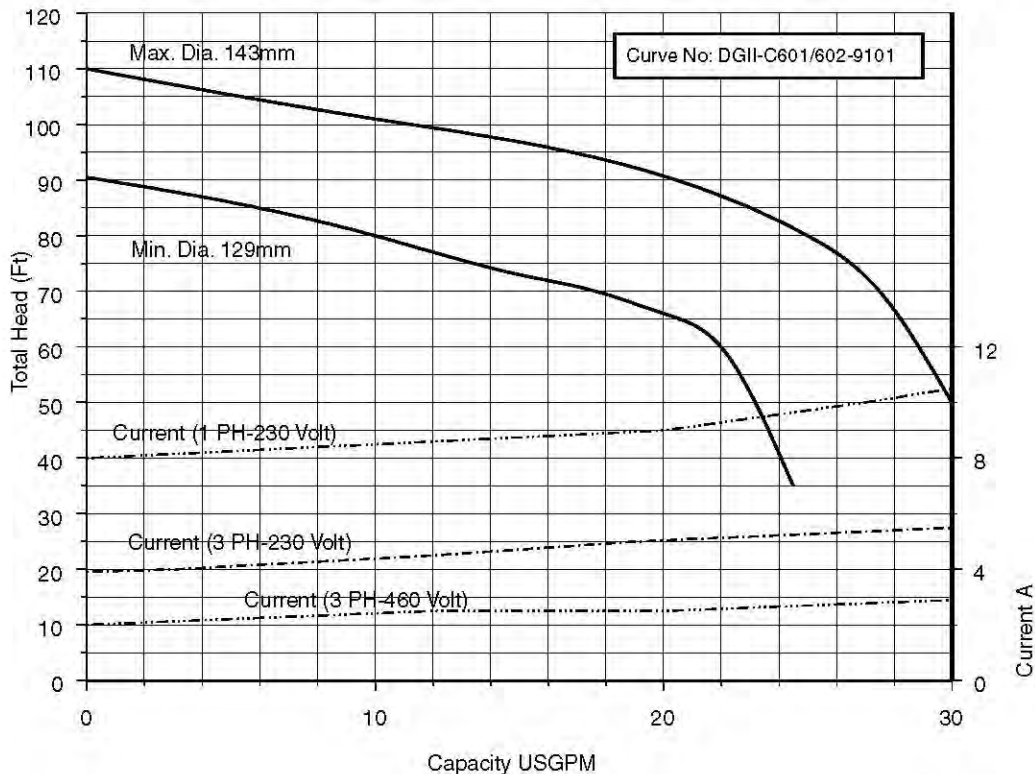

Performance Curve – HPGF(X)/HPGFH(X)

RPM: 1725 DISCHARGE: 2"

Lift Station 262

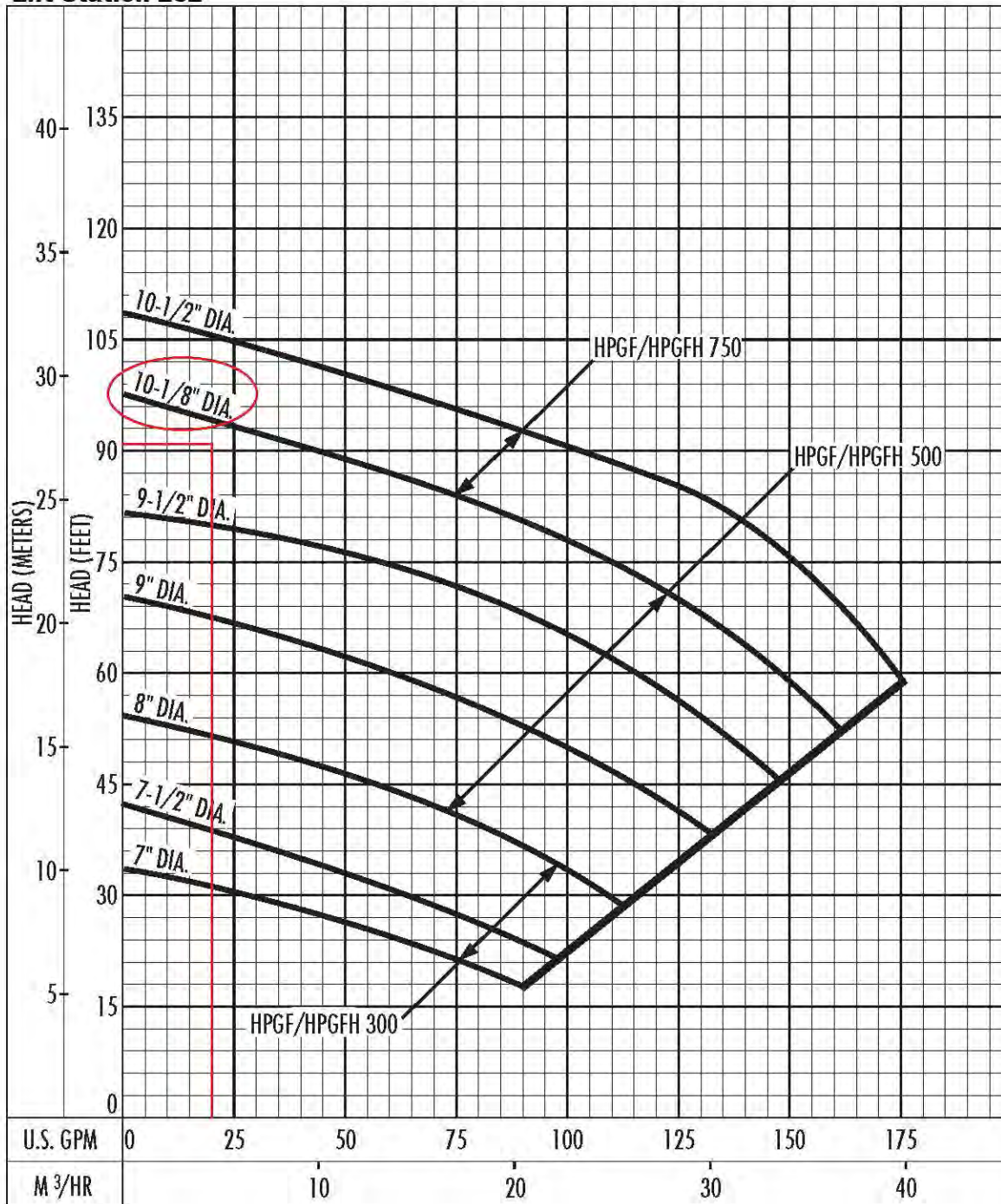

The curves reflect maximum performance characteristics without exceeding full load (Nameplate) horsepower. All pumps have a service factor of 1.2. Operation is recommended in the bounded area with operational point within the curve limit. Performance curves are based on actual tests with clear water at 70° F and 1280 feet site elevation.

Conditions of Service:

Company: Manatee County Utilities
 Name: Wisteria Park - RTU 263
 Date: 4/9/2012



Pump:

Size: S4N/S4NX
 Type: NCLOG-4
 Synch speed: 1800 rpm
 Curve: PAGE 109
 Specific Speeds:
 Dimensions:
 Speed: 1750 rpm
 Dia: 5.8125 in
 Impeller:
 Ns: ---
 Nss: ---
 Suction: --- in
 Discharge: 4 in

Search Criteria:

Flow: --- US gpm
 Head: --- ft

Fluid:

Water
 Density: 62.37 lb/ft³
 Viscosity: 1.105 cP
 NPSHa: --- ft
 Temperature: 60 °F
 Vapor pressure: 0.2563 psi a
 Atm pressure: 14.7 psi a

Motor:

Consult HYDROMATIC to select a motor for this pump.

Pump Limits:

Temperature: 140 °F
 Pressure: 125 psi g
 Sphere size: 3 in
 Power: --- hp
 Eye area: --- in²

---- Data Point ----

Flow: 450 US gpm
 Head: --- ft
 Eff: --- %
 Power: --- hp
 NPSHr: --- ft

---- Design Curve ----

Shutoff head: 30.3 ft
 Shutoff dP: 13.1 psi
 Min flow: 45 US gpm
 BEP: 54% @ 360 US gpm
 NOL power:
 2.38 hp @ 200 US gpm

-- Max Curve --

Max power:
 9.61 hp @ 677 US gpm

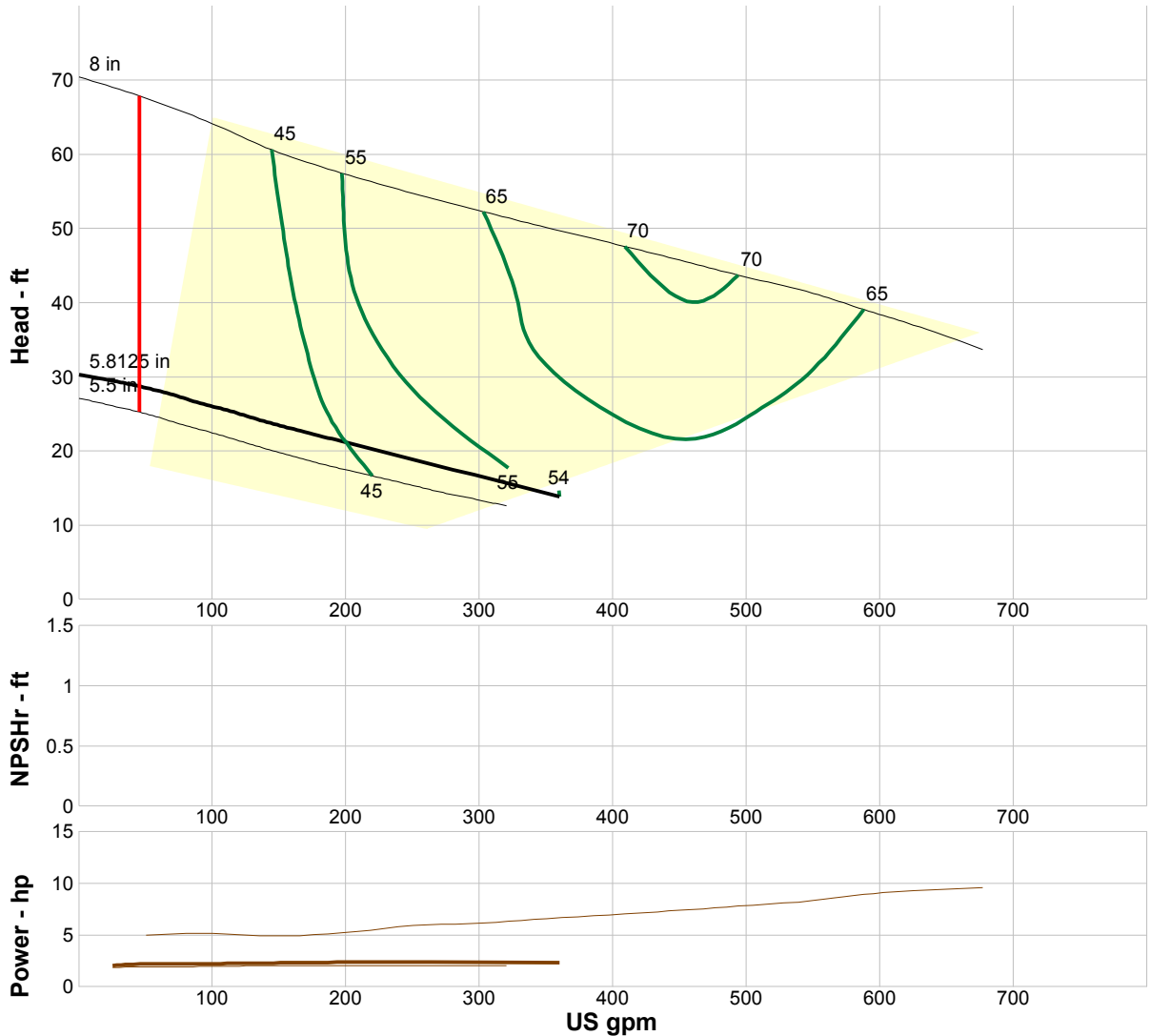

Performance Evaluation:

| Flow US gpm | Speed rpm | Head ft | Efficiency % | Power hp | NPSHr ft |
|----------------|--------------|------------|-----------------|-------------|-------------|
| 346 | 1750 | 14.5 | 53 | 2.34 | --- |
| 288 | 1750 | 17.1 | 50 | 2.35 | --- |
| 230 | 1750 | 19.8 | 47 | 2.37 | --- |
| 173 | 1750 | 22.4 | 42 | 2.34 | --- |
| 115 | 1750 | 25.3 | 33 | 2.25 | --- |

Company: Manatee County Utilities
 Name: Wisteria Park - RTU 263
 Date: 4/9/2012



Pump:

Size: S4N/S4NX
 Type: NCLOG-4
 Synch speed: 1800 rpm
 Curve: PAGE 109
 Specific Speeds:
 Dimensions:
 Speed: 1750 rpm
 Dia: 5.8125 in
 Impeller:
 Ns: ---
 Nss: ---
 Suction: --- in
 Discharge: 4 in

Search Criteria:

Flow: --- US gpm
 Head: --- ft

Fluid:

Water
 Density: 62.37 lb/ft³
 Viscosity: 1.105 cP
 NPSHa: --- ft
 Temperature: 60 °F
 Vapor pressure: 0.2563 psi a
 Atm pressure: 14.7 psi a

Motor:

Consult HYDROMATIC to select a motor for this pump.

Pump Limits:

Temperature: 140 °F
 Pressure: 125 psi g
 Sphere size: 3 in
 Power: --- hp
 Eye area: --- in²

---- Data Point ----

Flow: 450 US gpm
 Head: --- ft
 Eff: --- %
 Power: --- hp
 NPSHr: --- ft

---- Design Curve ----

Shutoff head: 30.3 ft
 Shutoff dP: 13.1 psi
 Min flow: 45 US gpm
 BEP: 54% @ 360 US gpm
 NOL power:
 2.38 hp @ 200 US gpm

-- Max Curve --

Max power:
 9.61 hp @ 677 US gpm

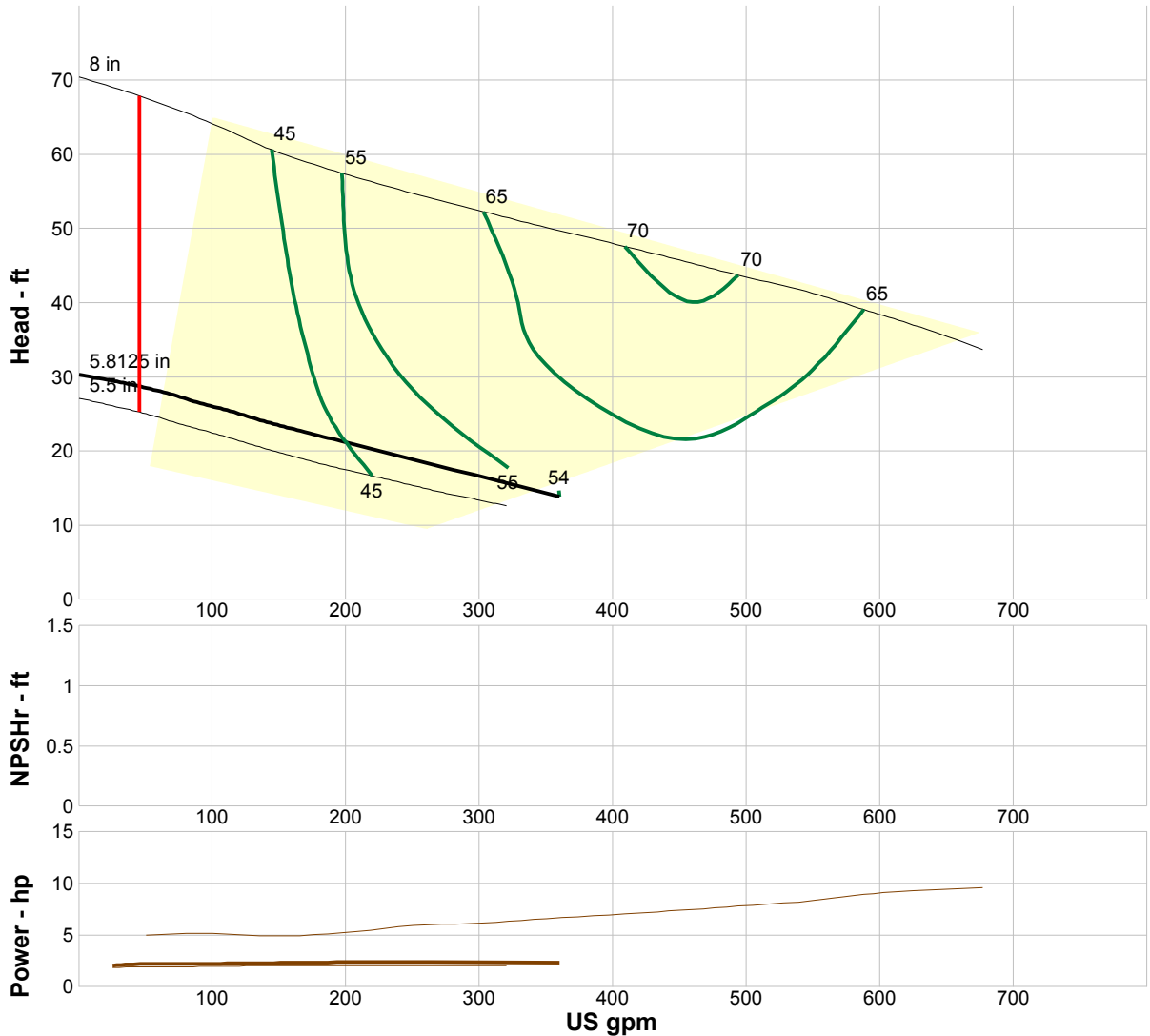

Performance Evaluation:

| Flow US gpm | Speed rpm | Head ft | Efficiency % | Power hp | NPSHr ft |
|----------------|--------------|------------|-----------------|-------------|-------------|
| 346 | 1750 | 14.5 | 53 | 2.34 | --- |
| 288 | 1750 | 17.1 | 50 | 2.35 | --- |
| 230 | 1750 | 19.8 | 47 | 2.37 | --- |
| 173 | 1750 | 22.4 | 42 | 2.34 | --- |
| 115 | 1750 | 25.3 | 33 | 2.25 | --- |

Performance Curve – HPGF(X)/HPGFH(X)

RPM: 1725 DISCHARGE: 2"

Lift Station 264

Impeller: 8.5

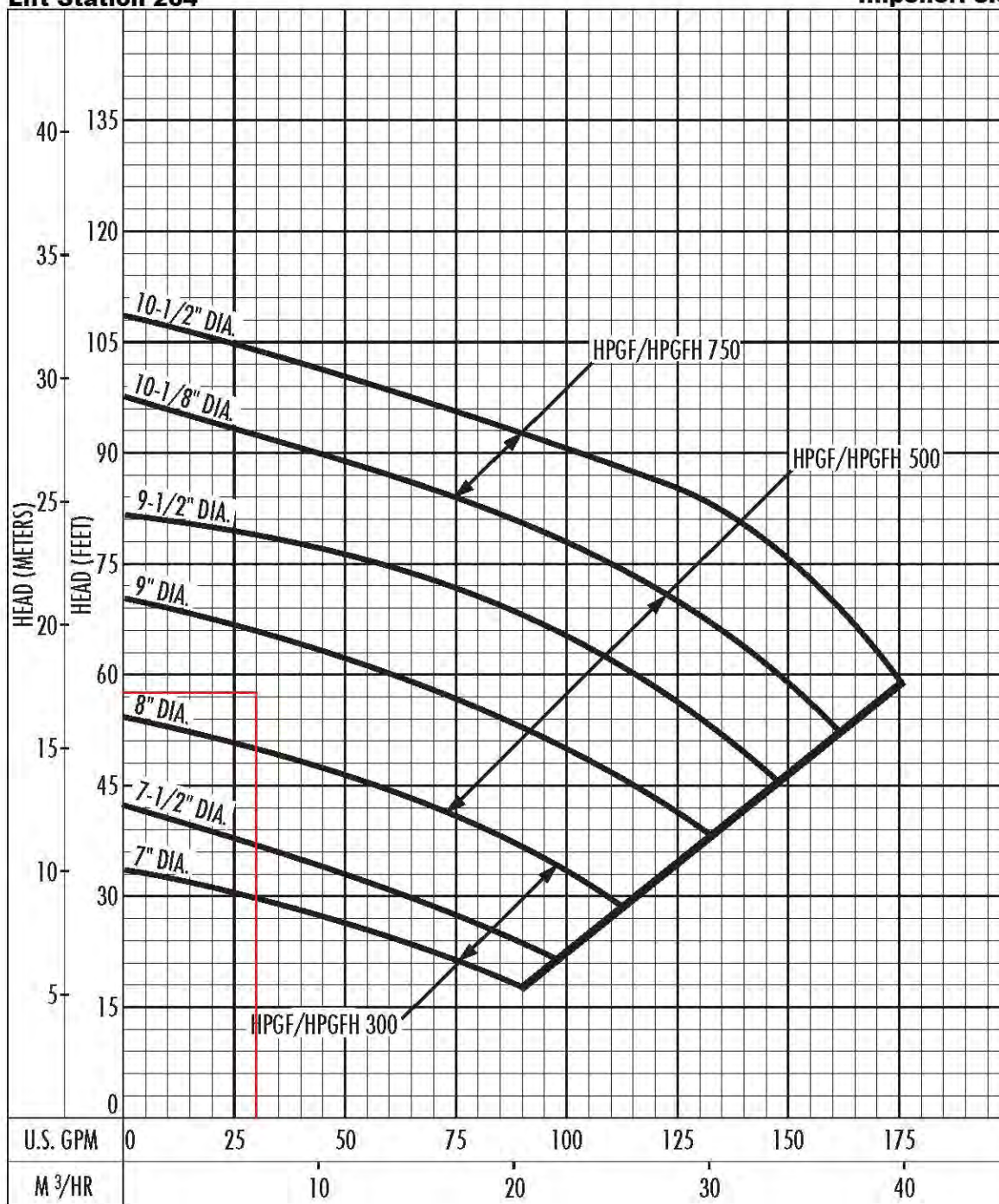

The curves reflect maximum performance characteristics without exceeding full load (Nameplate) horsepower. All pumps have a service factor of 1.2. Operation is recommended in the bounded area with operational point within the curve limit. Performance curves are based on actual tests with clear water at 70° F and 1280 feet site elevation.

Conditions of Service:

Performance Curve – HPG200

RPM: 3450 DISCHARGE: 1-1/4"

Lift Station 265

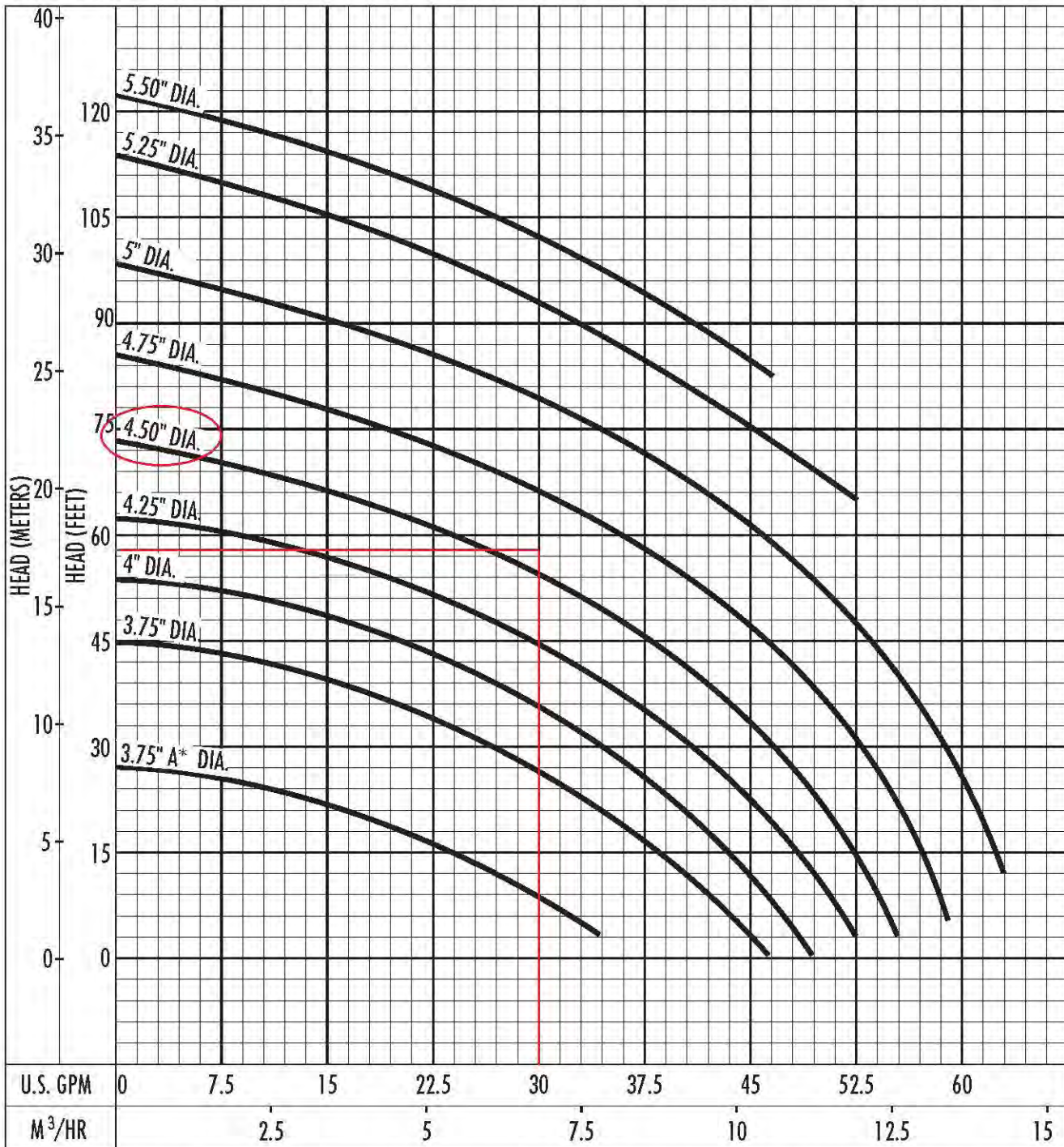

The curves reflect maximum performance characteristics without exceeding full load (Nameplate) horsepower. All pumps have a service factor of 1.2. Operation is recommended in the bounded area with operational point within the curve limit. Performance curves are based on actual tests with clear water at 70° F. and 1280 feet site elevation.

Conditions of Service:



HYDROMATIC

GPM: 30

TDH: 58

October © 2014 Pentair Ltd.

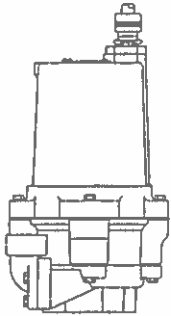

| | |
|--------------------------|--------------------------|
| Performance Curve | HPG200 |
| RPM: 3450 | Discharge: 1-1/4" |

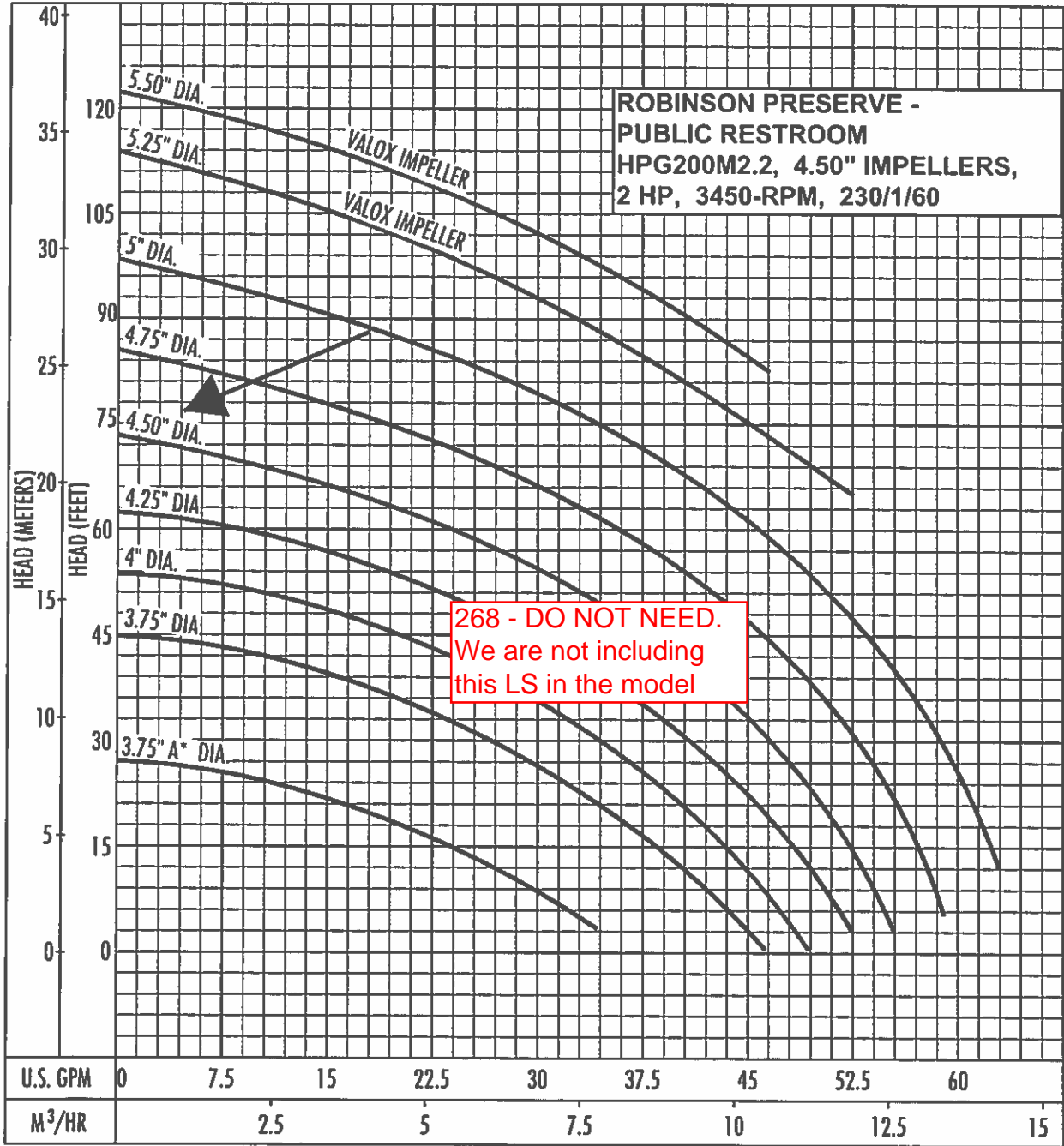

The curves reflect maximum performance characteristics without exceeding full load (Nameplate) horsepower. All pumps have a service factor of 1.2. Operation is recommended in the bounded area with operational point within the curve limit. Performance curves are based on actual tests with clear water at 70° F. and 1280 feet site elevation.

Conditions of Service:
 GPM: _____ TDH: _____



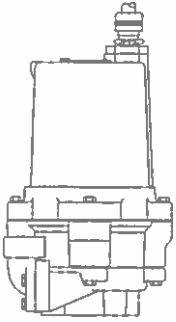

Performance Curve

HPG200

RPM: **3450**

Discharge: **1-1/4"**

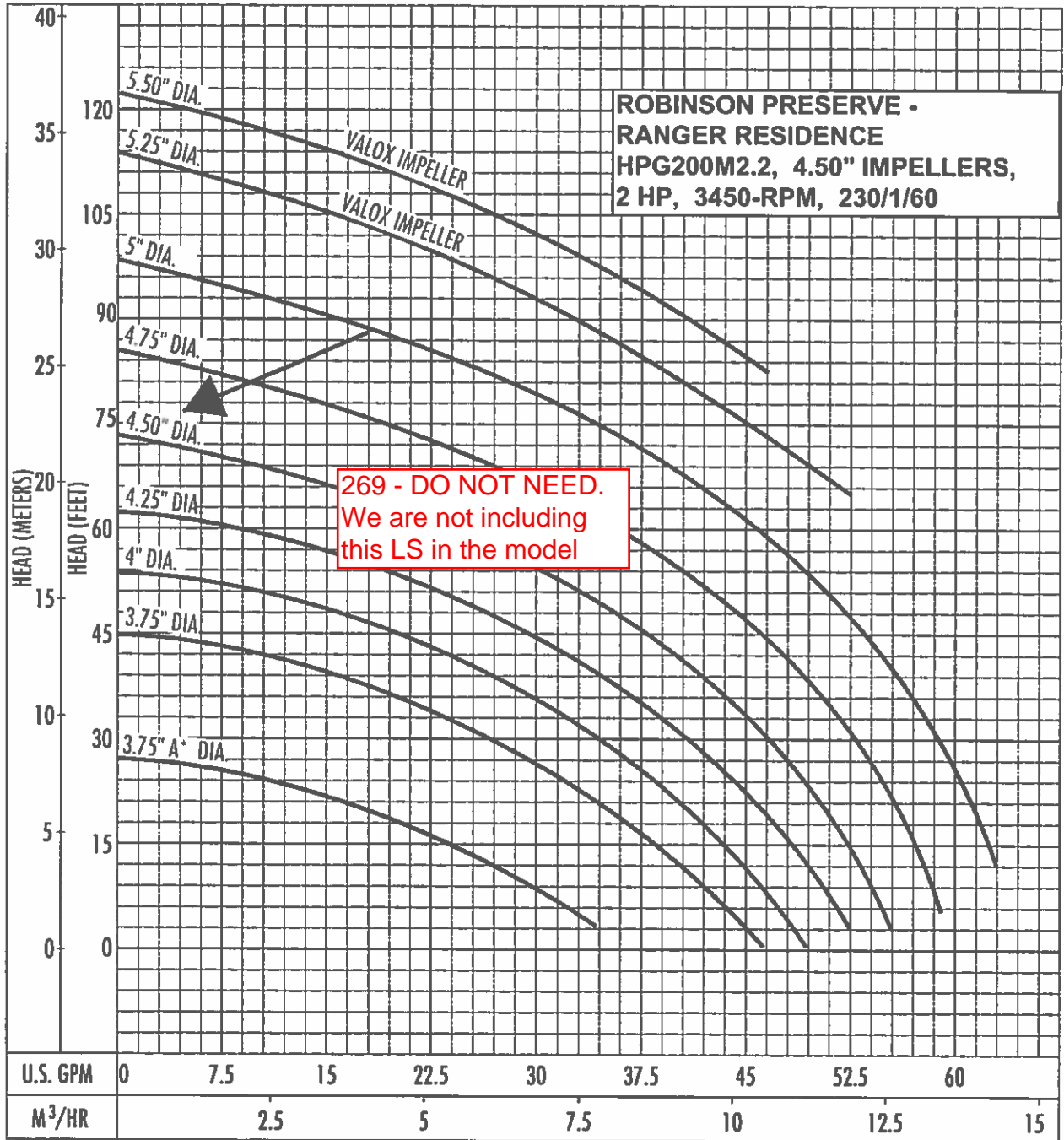

The curves reflect maximum performance characteristics without exceeding full load (Nameplate) horsepower. All pumps have a service factor of 1.2. Operation is recommended in the bounded area with operational point within the curve limit. Performance curves are based on actual tests with clear water at 70° F. and 1280 feet site elevation.

Conditions of Service:

GPM: _____ TDH: _____



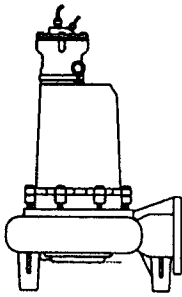

Performance Curve

S4P

RPM: **1750** Discharge: **4"** Solids: **3"**

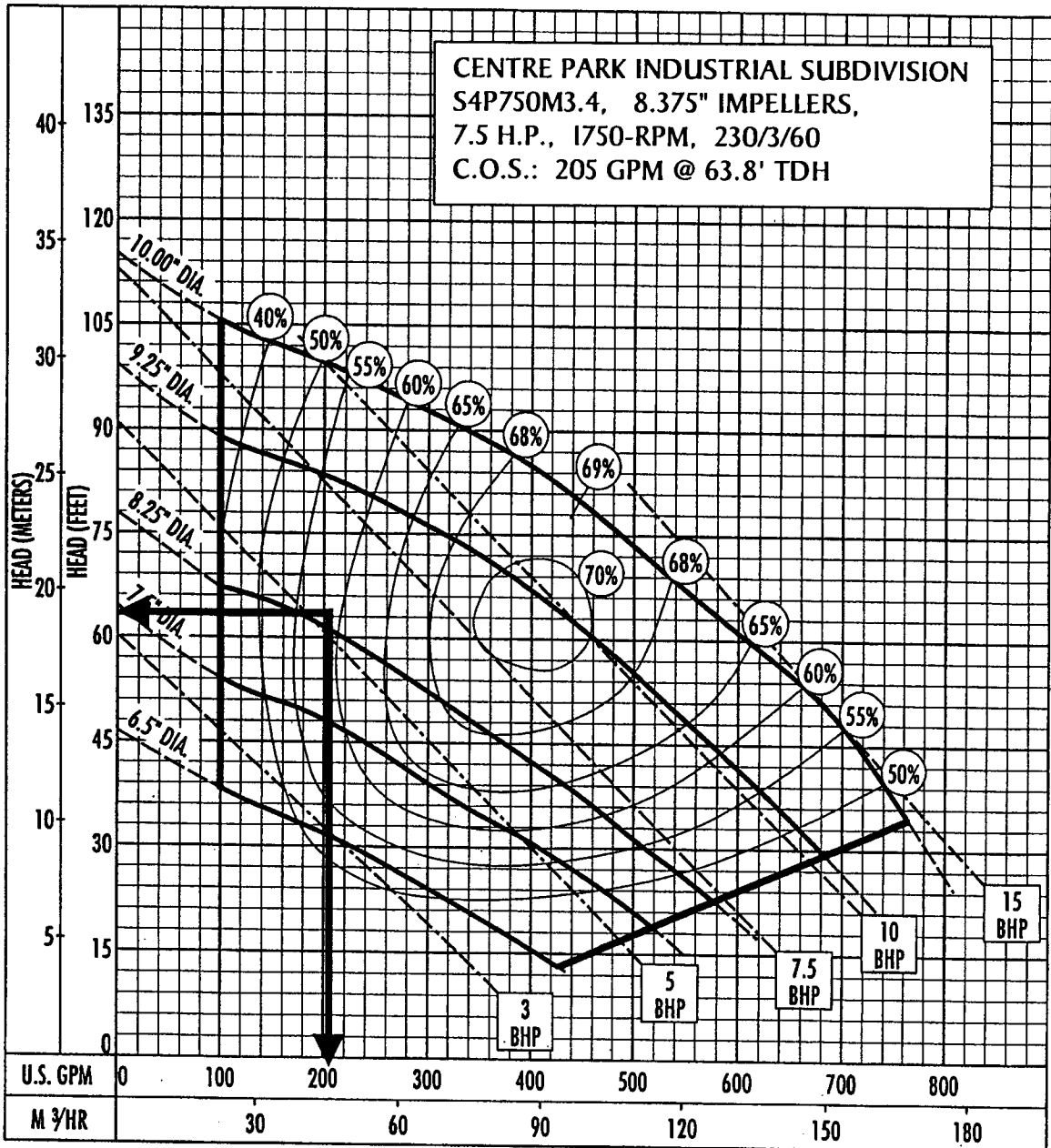

The curves reflect maximum performance characteristics without exceeding full load (Nameplate) horsepower. All pumps have a service factor of 1.2. Operation is recommended in the bounded area with operational point within the curve limit. Performance curves are based on actual tests with clear water at 70° F. and 1280 feet site elevation.

Conditions of Service:

GPM: 205 TDH: 63.8'



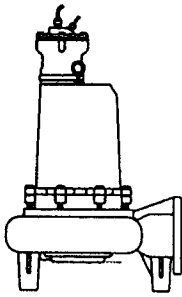

Performance Curve

S4P

RPM: **1750** Discharge: **4"** Solids: **3"**

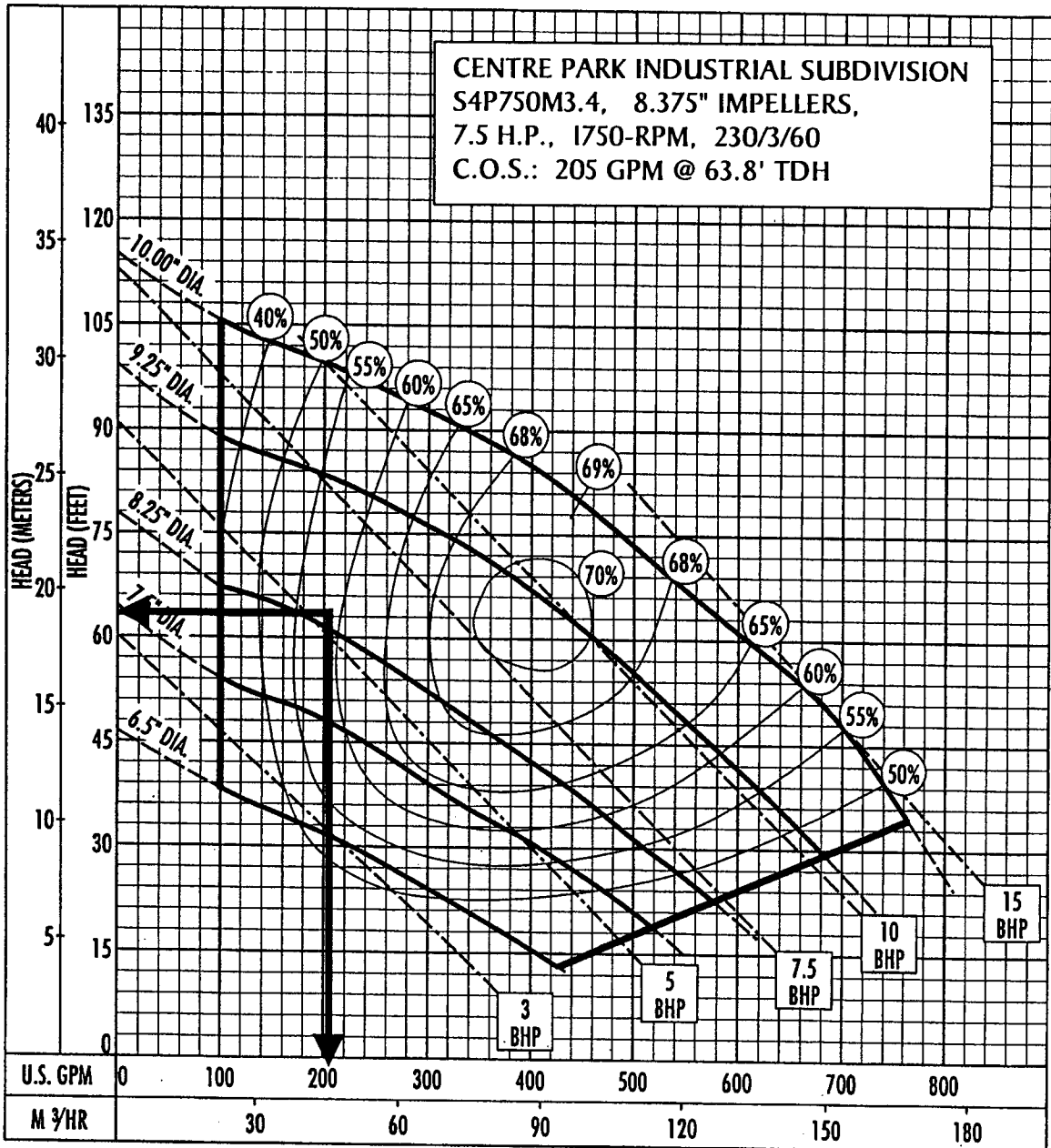

The curves reflect maximum performance characteristics without exceeding full load (Nameplate) horsepower. All pumps have a service factor of 1.2. Operation is recommended in the bounded area with operational point within the curve limit. Performance curves are based on actual tests with clear water at 70° F. and 1280 feet site elevation.

Conditions of Service:

GPM: 205 TDH: 63.8'



Performance Curve – S4N/S4NX

RPM: **1750** DISCHARGE: **4"** SOLIDS: **3"**

Lift Station 301

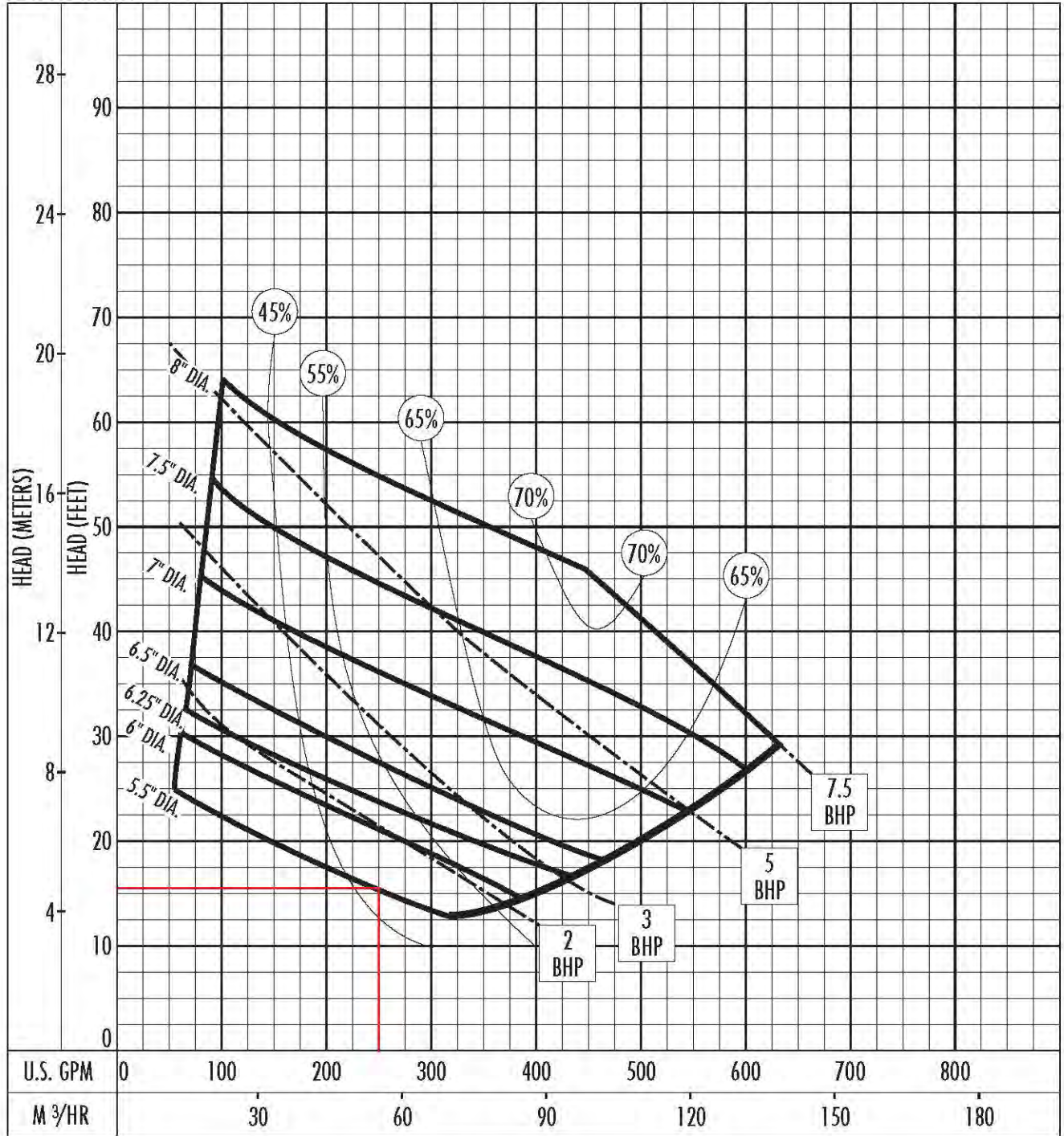

The curves reflect maximum performance characteristics without exceeding full load (Nameplate) horsepower. All pumps have a service factor of 1.2. Operation is recommended in the bounded area with operational point within the curve limit. Performance curves are based on actual tests with clear water at 70° F. and 1280 feet site elevation.

Conditions of Service:



Performance Curve

AMX434-193/5,5T

37-A

(302)

Impeller

| | | | | | |
|---|-----------------------------|----|--------------------------|---------------------------|--------------------------|
| Impeller type: Single vane impeller | Solid size 3 1/8" | Ø: | Max. Ø: 8 1/8" | Min. Ø: 5 9/16" | Sel. Ø: 7 5/8" |
|---|-----------------------------|----|--------------------------|---------------------------|--------------------------|

Operating data

| | | | | |
|---------------------------|----------------------------|--|---------------------------------|-----------------------------------|
| Speed: 1700 rpm | Frequency: 60 Hz | Duty point: Q = 480 US g.p.m. H = 25 ft | Suction port: 4" ANSI | Discharge port: 4" ANSI |
|---------------------------|----------------------------|--|---------------------------------|-----------------------------------|

Power data referred to: Water, pure [100%] ; 68°F; 62.322lb/ft³; 1.0818E-5ft²/s Testnorm: **ISO 9906**

Curve number:

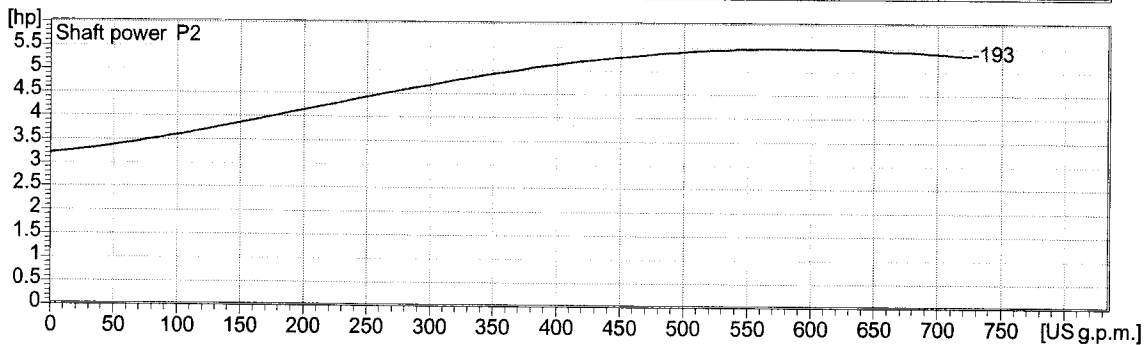
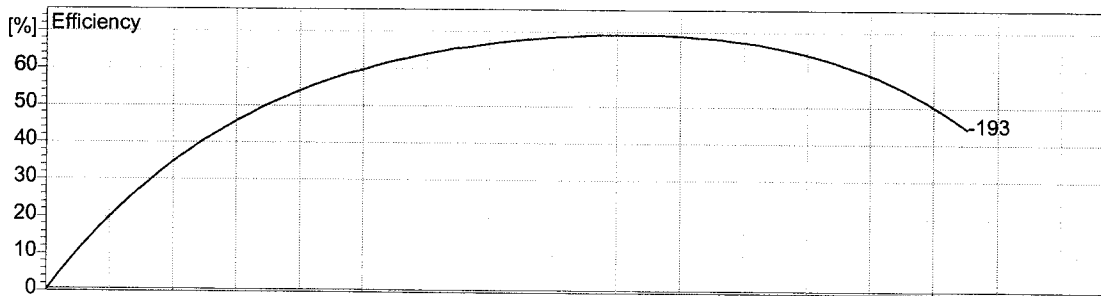
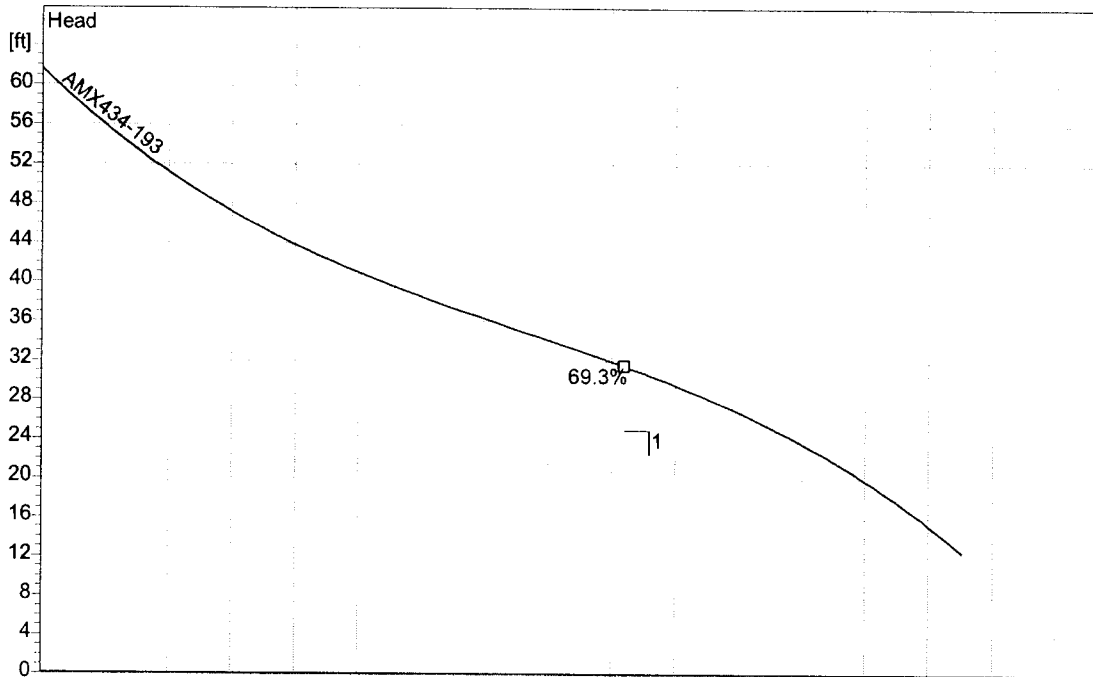

2.0 - 29.09.2004 (Build 60)



PERFORMANCE CURVE

| | |
|----------------|-------|
| PRODUCT | TYPE |
| NP3127.181 | MT |
| CURVE NO | ISSUE |
| 63-438-00-3704 | 5 |

| | |
|------------|--------------|
| DATE | PROJECT |
| 2010-07-26 | Manatee 32-A |

| | | | | | | |
|--------------|-----------------|----------|----------|------------------------|-------|------|
| POWER FACTOR | 1/1-LOAD | 3/4-LOAD | 1/2-LOAD | RATED POWER | 10 | hp |
| EFFICIENCY | 0.87 | 0.84 | 0.77 | STARTING CURRENT ... | 143 | A |
| MOTOR DATA | --- | --- | --- | RATED CURRENT ... | 25 | A |
| COMMENTS | INLET/OUTLET | | | RATED SPEED | 1740 | rpm |
| | -/ 4 inch | | | TOT.MOM.OF INERTIA ... | 0.048 | kgm2 |
| | IMP. THROUGHLET | | | NO. OF BLADES | 2 | |
| | --- | | | | | |

| | | | |
|-------------------|--------|---------|-------|
| IMPELLER DIAMETER | | | |
| 202 mm | | | |
| MOTOR # | STATOR | REV | |
| 21-12-4AL | 29D | 11 | |
| FREQ. | PHASES | VOLTAGE | POLES |
| 60 Hz | 3 | 230 V | 4 |
| GEARTYPE | | RATIO | |
| --- | | --- | |

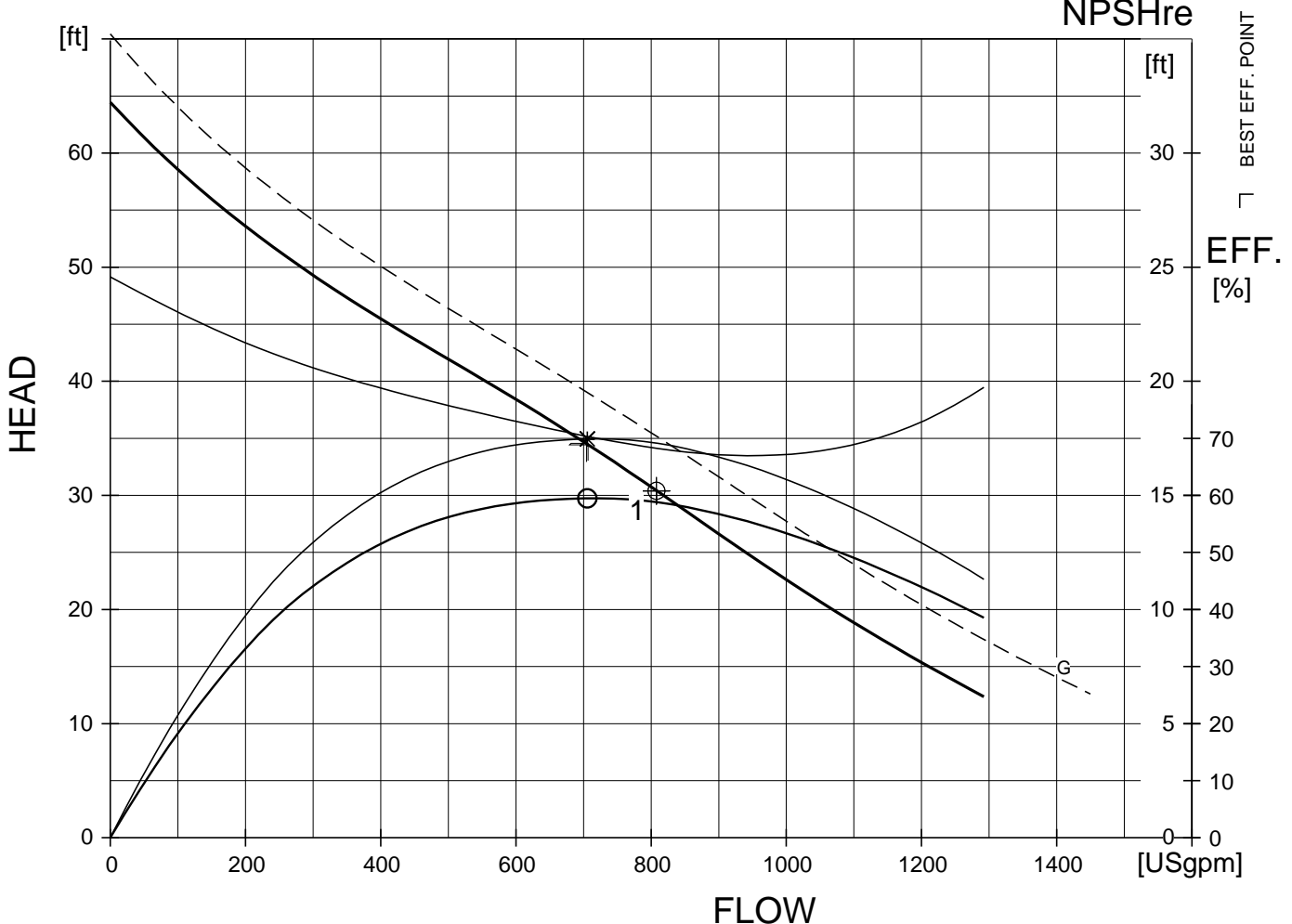
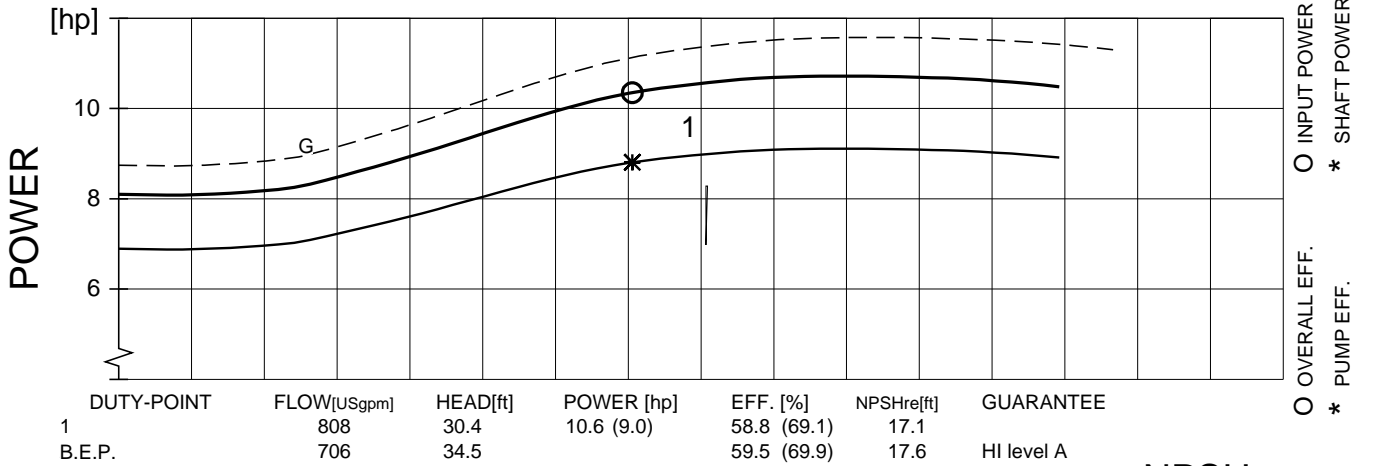

FLYPS3.1.6.2 (20060531)

NPSHre = NPSH3% + min. operational margin
 Performance with clear water and ambient temp 40 °C

GUARANTEE BETWEEN LIMITS (G) ACC. TO
HI level A

CP 3102 MT 1~ 434
VFD Analysis



Lift Station 304

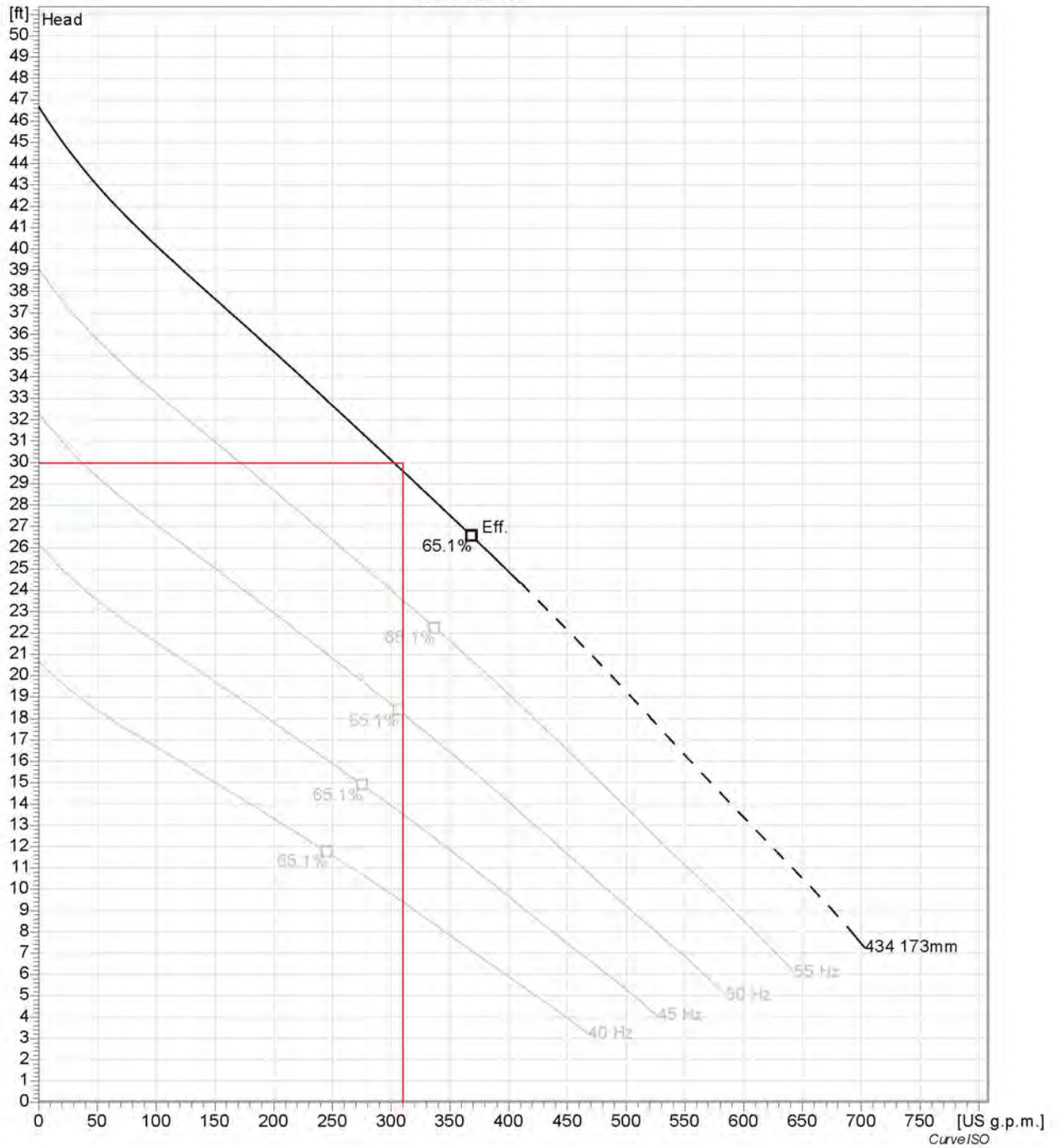

| | | | | |
|---------|------------|-----------------------------------|---------------------------------|-------------|
| Project | Project ID | GPM: 310 TDH: 30 | Created on 2015-07-07 | Last update |
|---------|------------|-----------------------------------|---------------------------------|-------------|

DeSoto Mall

305

305

SOLIDS HANDLING PUMP PERFORMANCE DATA

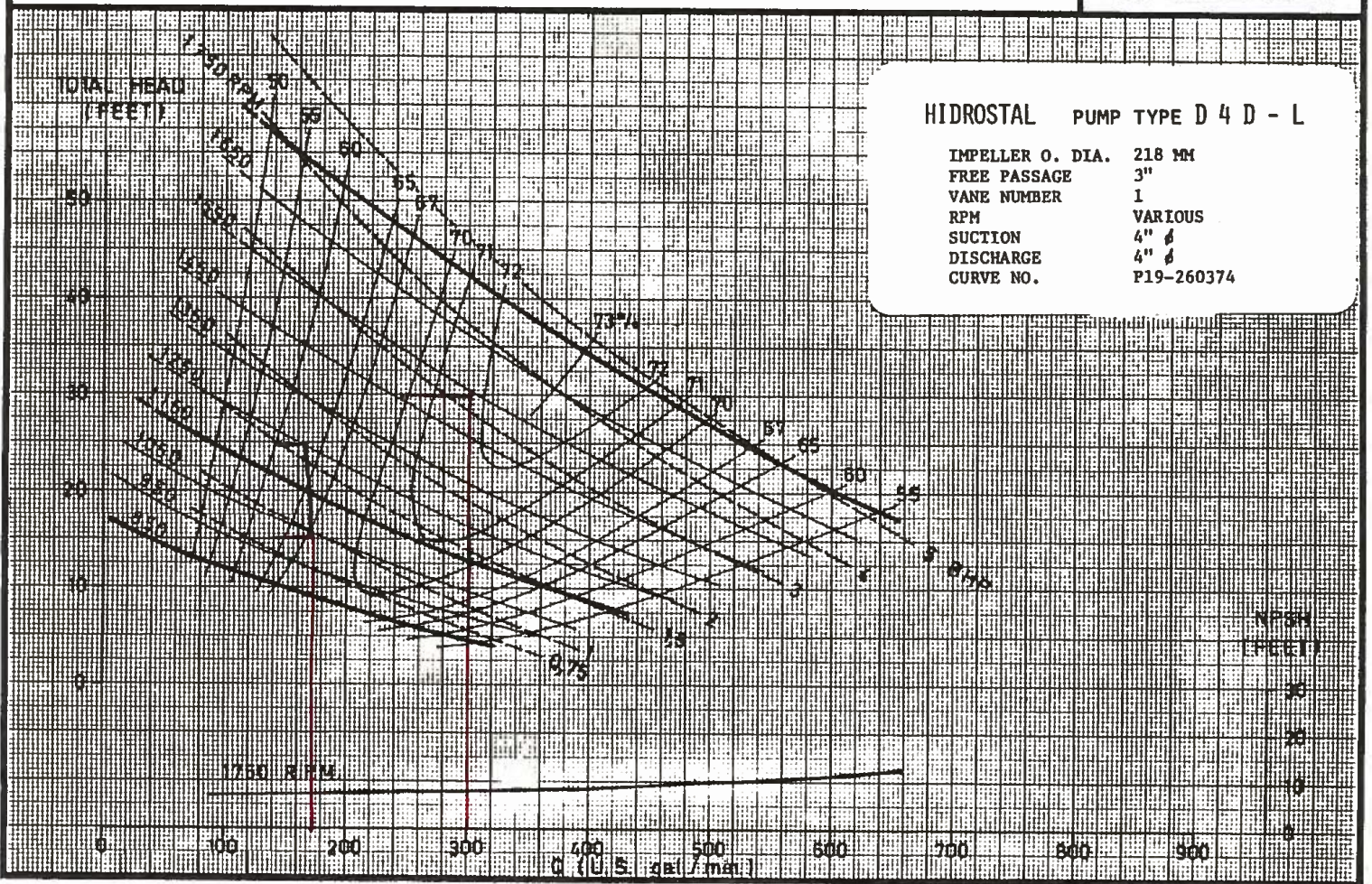

| Impeller | | | | | |
|--|--|--|---|--|-----------------------|
| Impeller type: Single channel impeller | Solid size 3¹⁵/₁₆" | Ø: | Max. Ø: 12³/₁₆" | Min. Ø: 10¹/₄" | Sel. Ø: 11" |
| Operating data | | | | | |
| Speed: 1750 rpm | Frequency: | Duty point: Q = 1150 US g.p.m. H = 60 ft | Suction port: | Discharge port: 6" ANSI | |
| Power data referred to: Water [100%] ; 68°F; 62.322lb/ft ³ ; 1.0818E-5ft ² /s | | | Testnom: ISO 9906 | | |

Curve number:

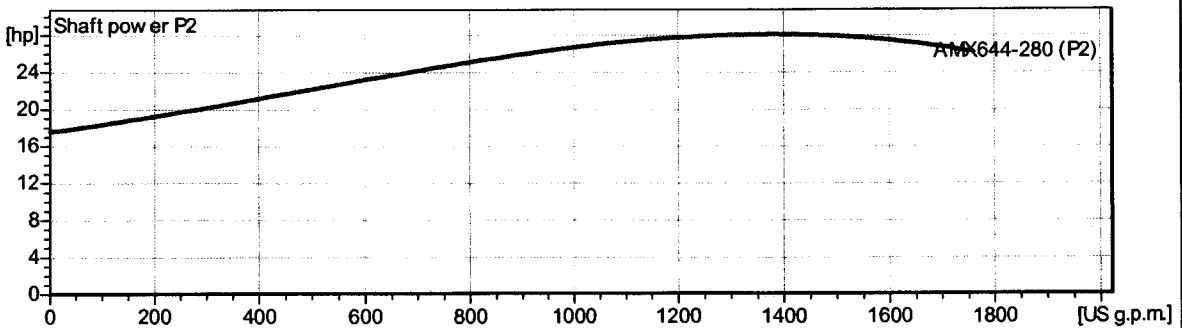
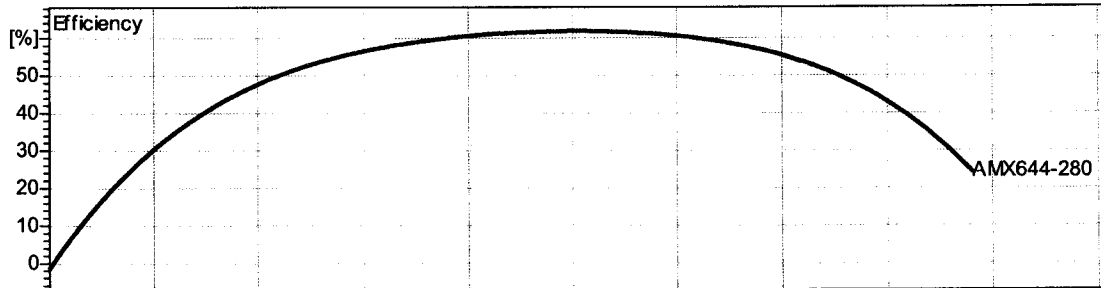
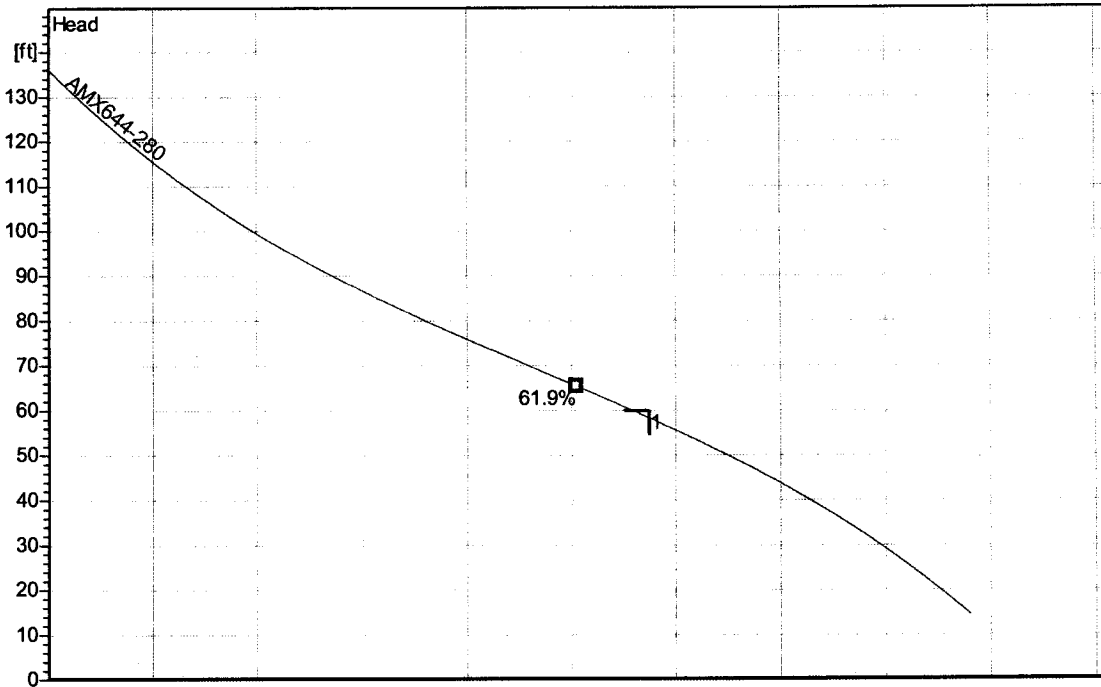

2.0 - 21.02.2006 (Build 105)

| | | | | |
|----------------------------------|----------------------------------|----------------------------------|-------------------|----------------------------|
| Project Manatee County | Project no.: Samoset 1 | Created by: nyackerman | Page: 2 | Date: 2008-01-15 |
|----------------------------------|----------------------------------|----------------------------------|-------------------|----------------------------|

Performance Curve

AMX434-178/4D/C

| Impeller | | | | | | |
|---|-----------------------------|--|--------------------------|---------------------------|----------------------|-----------------------------------|
| Impeller type: Single channel impeller | Solid size 3 inch | Ø: | Max. Ø: 8 1/8" | Min. Ø: 5 9/16" | Sel. Ø: 7" | |
| Operating data | | | | | | |
| Speed: 1750 rpm | Frequency: 60 Hz | Duty point: Q = 200 US g.p.m. H = 23 ft | | | Suction port: | Discharge port: 4" ANSI |
| Power data referred to: Water, pure [100%]; 68°F; 62.322lb/ft³; 1.0818E-5ft²/s | | | | | Testnorm: | ISO 9906 |

Curve number:

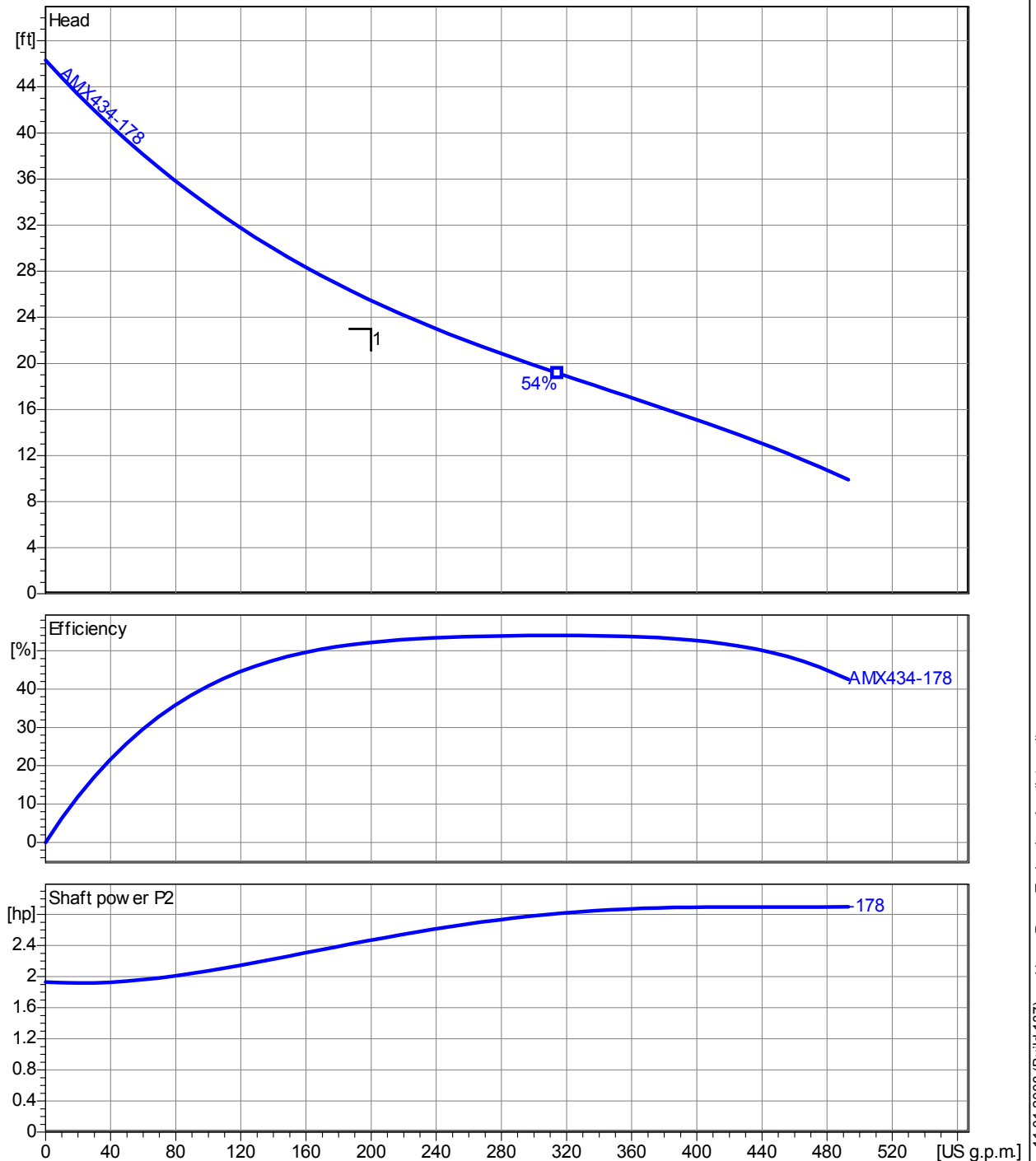

2.0 - 11.01.2008 (Build 137) Homa Pump Technology Inc. (internal)

| | | | | |
|--|---|----------------------------------|-------------------|--------------------------|
| Project Man. Cty IFB #09-0897-OV | Project no.: Manasota Industrial Park | Created by: nyackerman | Page: 2 | Date: 4/4/2009 |
|--|---|----------------------------------|-------------------|--------------------------|

Performance Curve

AMX434-178/4D/C

| Impeller | | | | | |
|---|-----------------------------|--|--------------------------|---------------------------|-----------------------------------|
| Impeller type: Single channel impeller | Solid size 3 inch | Ø: | Max. Ø: 8 1/8" | Min. Ø: 5 9/16" | Sel. Ø: 7" |
| Operating data | | | | | |
| Speed: 1750 rpm | Frequency: 60 Hz | Duty point: Q = 200 US g.p.m. H = 23 ft | | Suction port: | Discharge port: 4" ANSI |
| Power data referred to: Water, pure [100%]; 68°F; 62.322lb/ft³; 1.0818E-5ft²/s | | | | Testnorm: | ISO 9906 |

Curve number:

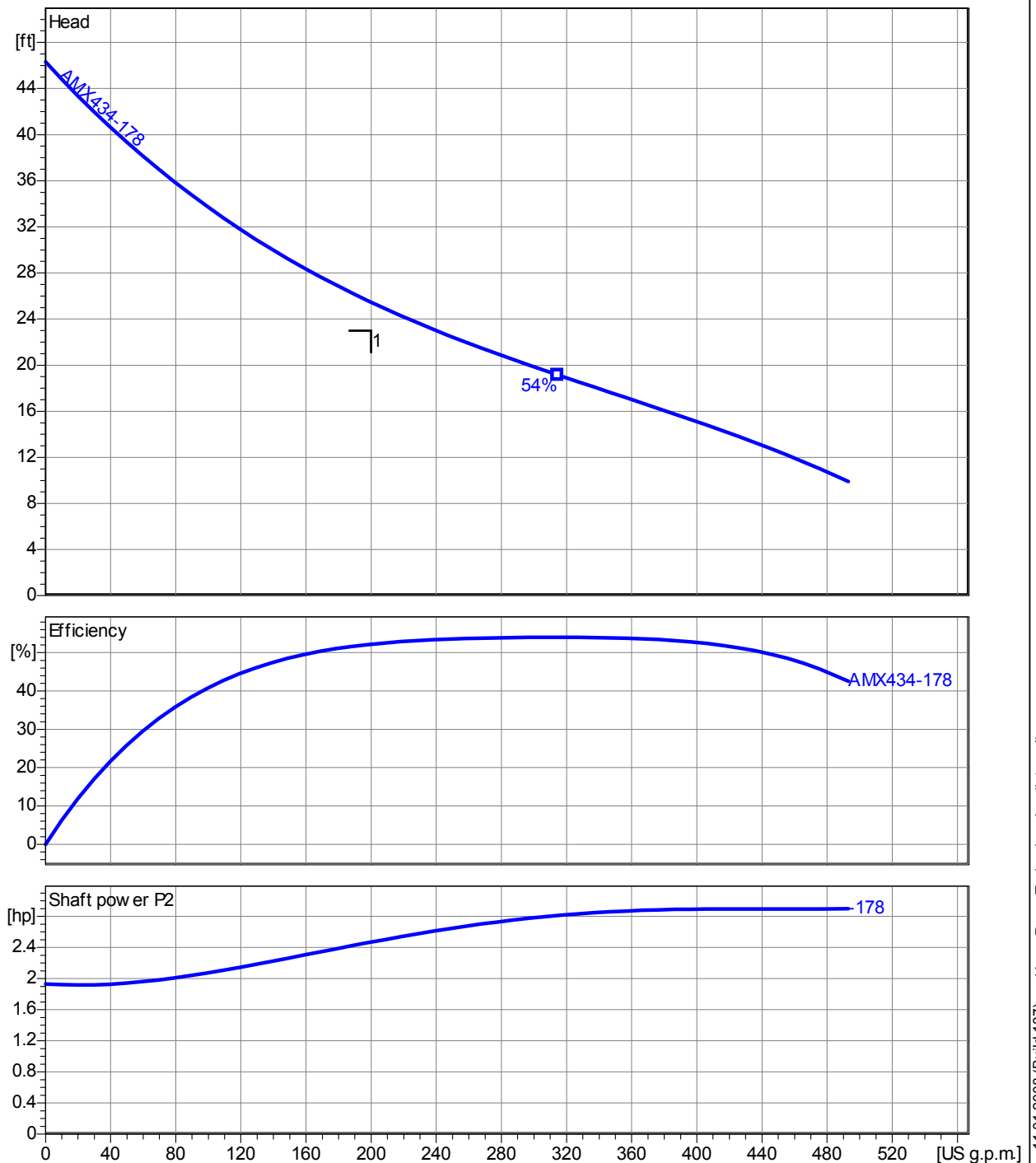

2.0 - 11.01.2008 (Build 137) Homa Pump Technology Inc. (internal)

| | | | | |
|--|---|----------------------------------|-------------------|--------------------------|
| Project Man. Cty IFB #09-0897-OV | Project no.: Manasota Industrial Park | Created by: nyackerman | Page: 2 | Date: 4/4/2009 |
|--|---|----------------------------------|-------------------|--------------------------|



IMPELMEX, S.A. DE C.V.

Lift Station 319

Bombas Sumergibles para Agua Residual



LD-100-xxx-yyy-W

Diámetro de Descarga: 100 mm (4")
Paso de Esfera: 76 mm (3")

→ Serie
L

GPM: 133

TDH: 21

| CÓDIGO DE MODELO | | | | | | |
|----------------------------|---|--------------------------------|----------|--------------|-------------------------|--------------------------|
| L | D | 100 | xx | x | yyy | W |
| Serie | Impulsor cerrado inatas cable de dos álabes | Diámetro de descarga en mm | HP motor | No. de polos | Diámetro impulsor en mm | Motor enfriado en aceite |
| ESPECIFICACIONES | | | | | | |
| MODELO | | LD-100-xxx-yyy-W | | | | |
| HP motor | | 10 | | 15 | | 20 |
| Diám. Std. Impulsor (mm) | | 195 | | 215 | | 235 |
| No. polos/r.p.m | | 4/1750 | | | | |
| Servicio | | Continuo | | | | |
| Temp. max. liq. bombeado | | 40°C (104°F) | | | | |
| Tipo de motor | | Inducción jaula de ardilla | | | | |
| Motor | | Inundado en aceite | | | | |
| Conexión de motor | | Estrella | | | | |
| Voltaje (V) | | 220/440 | | | | |
| No. Fases | | 3 | | | | |
| Frecuencia (Hz) | | 60 | | | | |
| Amperaje máximo 220 V. | | 30 | 43 | 65 | | |
| 440 V. | | 15 | 22 | 33 | | |
| Amps. a rotor bloq. 220 V. | | 170 | 170 | 242 | | |
| 440 V. | | 85 | 85 | 121 | | |
| Aislamiento clase | | F | | | | |
| Diseño NEMA | | B | | | | |
| Código | | H | H | G | | |
| Longitud del cable | | 8 m | | | | |
| Impulsor tipo | | Cerrado inatas cable, 2 álabes | | | | |
| Brida de descarga | | 100 mm (4") 125# | | | | |
| Lubricación de baleros | | Aceite dieléctrico | | | | |
| Sensores | | Humedad/Temperatura | | | | |

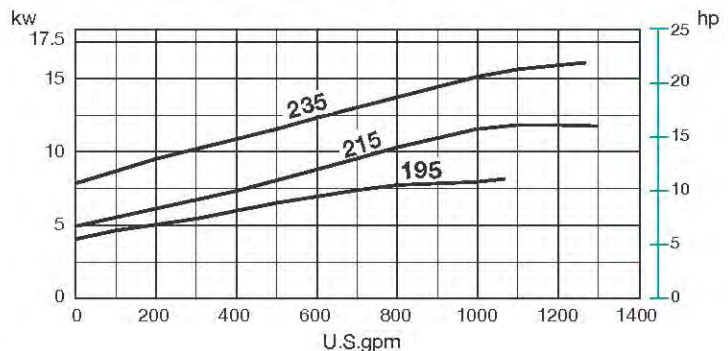
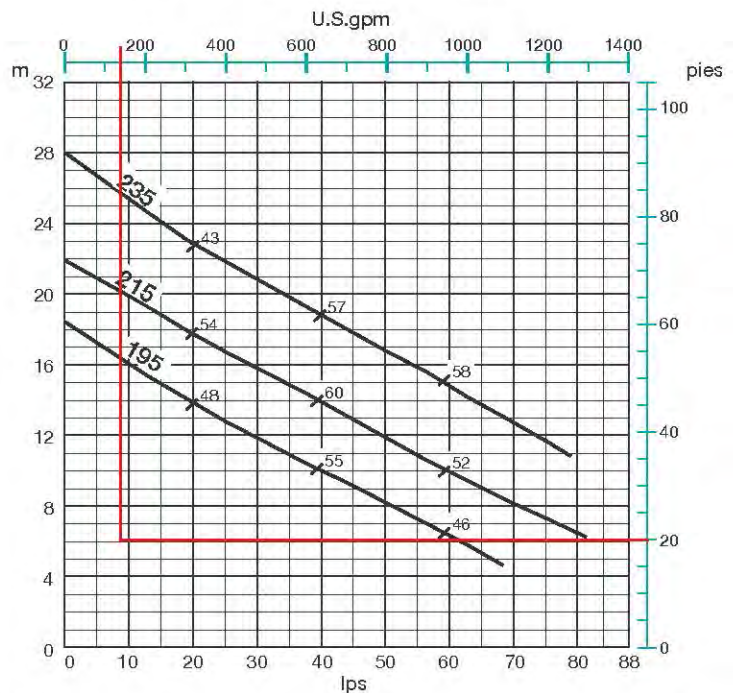

www.impel.com.mx

(55) 5536-0326

(55) 5536-3318

ventas@impel.mx



Performance Curve

AMX434-184/3.5D

Stone Creek (320)

Impeller

| | | | | | |
|---|-----------------------------|----|--------------------------|---------------------------|---------------------------|
| Impeller type: Single vane impeller | Solid size 3 1/8" | Ø: | Max. Ø: 8 1/8" | Min. Ø: 5 9/16" | Sel. Ø: 7 5/16" |
|---|-----------------------------|----|--------------------------|---------------------------|---------------------------|

Operating data

| | | | | |
|---------------------------|----------------------------|--|---------------------------------|-----------------------------------|
| Speed: 1700 rpm | Frequency: 60 Hz | Duty point: Q = 206 US g.p.m. H = 36 ft | Suction port: 4" ANSI | Discharge port: 4" ANSI |
|---------------------------|----------------------------|--|---------------------------------|-----------------------------------|

Power data referred to: Water, pure [100%] ; 68°F; 62.322lb/ft³; 1.0818E-5ft²/s Testnorm: ISO 9906

Curve number:

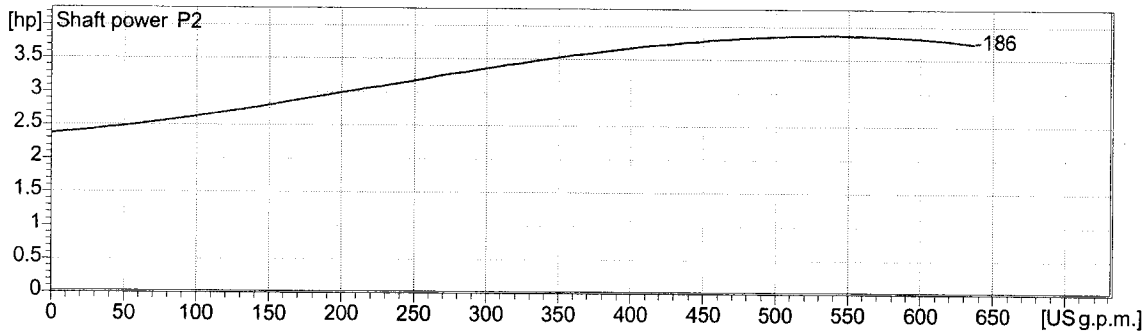
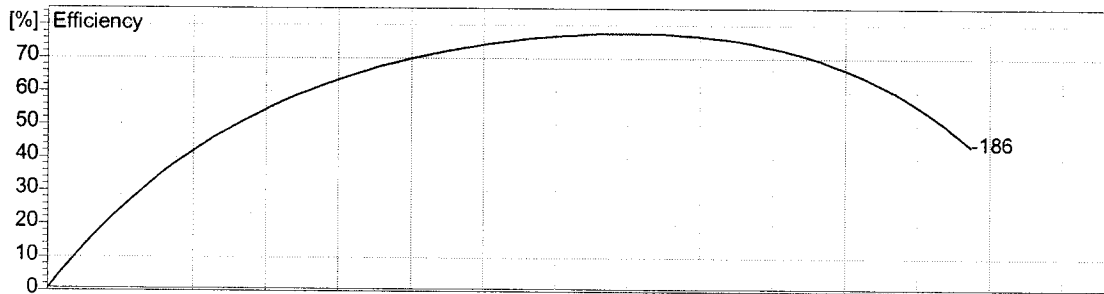
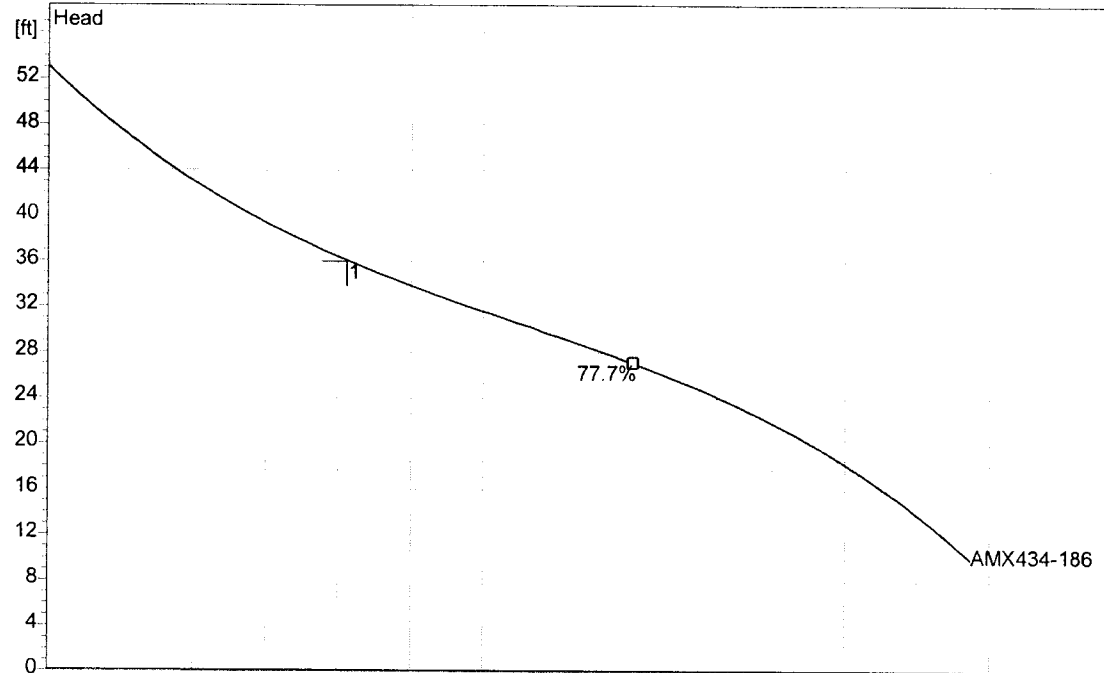

Project
Manatee Cty

Project no.:
Item Number 27

Created by:
nackerman

Page:
2

Date:
2005-09-14

Performance Curve

AMX434-193/5,5T/C

| Impeller | | | | | | |
|---|----------------------------|---|-------------------|-----------------------------------|-----------------------------------|--|
| Impeller type: Single channel impeller | Solid size 3 inch | Ø: | Max. Ø: 8 1/8" | Min. Ø: 7" | Sel. Ø: 7 5/8" | |
| Operating data | | | | | | |
| Speed: 1750 rpm | Frequency: 60 Hz | Duty point: Q = 206 US g.p.m. H = 36 ft | | Shaft power P2: 4.28 hp | Discharge port: 4" ANSI | |

Power data referred to: Water, clean [100%]; 68°F; 62.322lb/ft³; 1.0818E-5ft²/s

Testnorm: ISO 9906/A

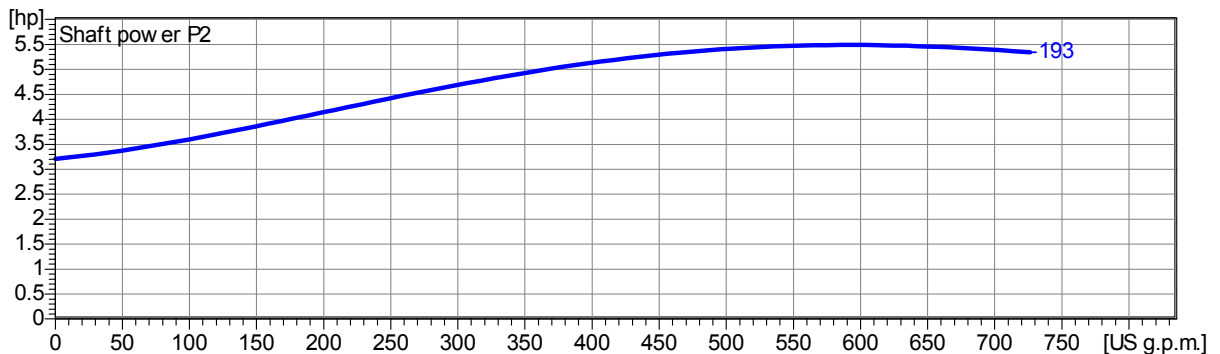
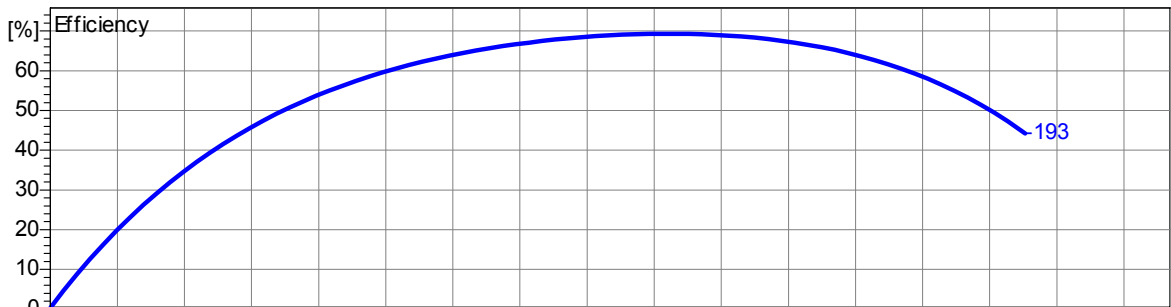
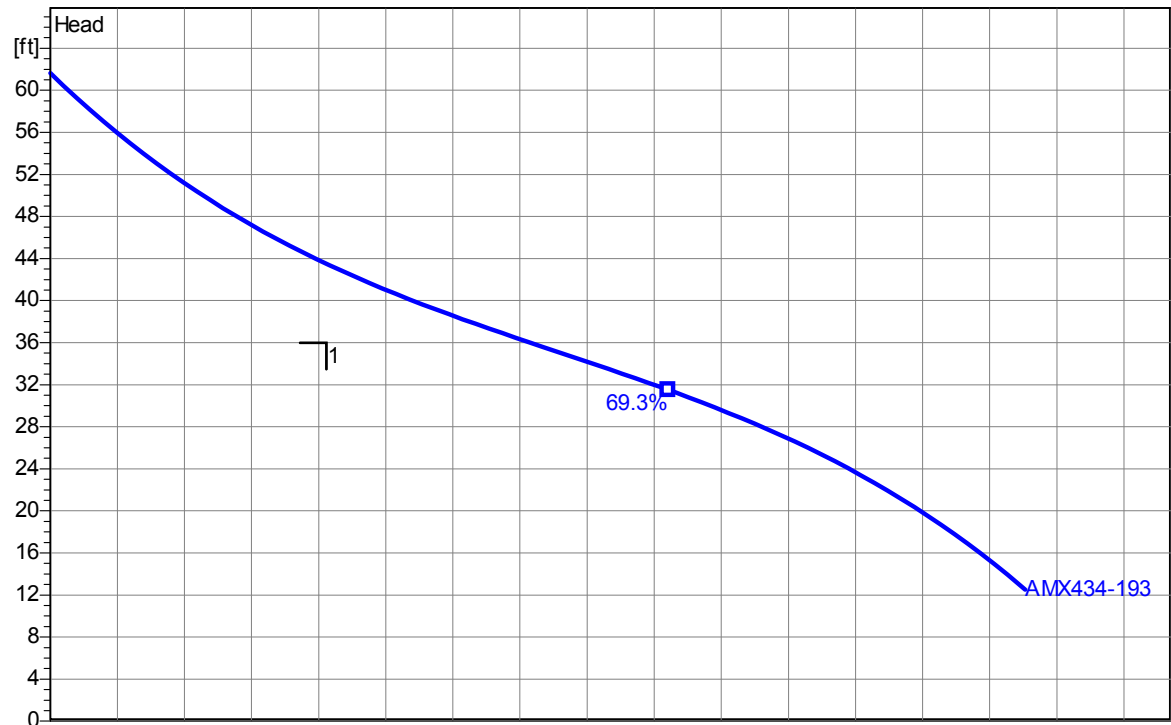

2.0 - 29.01.2009 (Build 168)

| | | | | |
|---------|------------------------------------|-------------|-------------------|----------------------------|
| Project | Project no.: STONE CREEK | Created by: | Page: 2 | Date: 2011-11-06 |
|---------|------------------------------------|-------------|-------------------|----------------------------|



Performance Curve

AMX434-184/3.5D

Palms Center (322)

Impeller

| | | | | |
|---|--------------------------------|--------------------------|---------------------------|--------------------------|
| Impeller type: Single vane impeller | Solid size Ø: 3 1/8" | Max. Ø: 8 1/8" | Min. Ø: 5 9/16" | Sel. Ø: 7 1/4" |
|---|--------------------------------|--------------------------|---------------------------|--------------------------|

Operating data

| | | | | |
|--|----------------------------|---|---------------------------------|-----------------------------------|
| Speed: 1700 rpm | Frequency: 60 Hz | Duty point: Q = 100 US g.p.m. H = 42 ft | Suction port: 4" ANSI | Discharge port: 4" ANSI |
| Power data referred to: Water, pure [100%] ; 68°F; 62.322lb/ft³; 1.0818E-5ft²/s | | | Testnorm: ISO 9906 | |

Curve number:

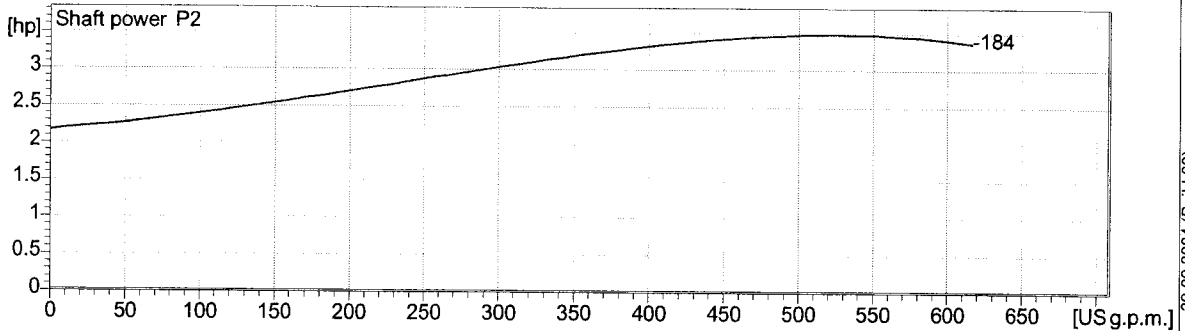
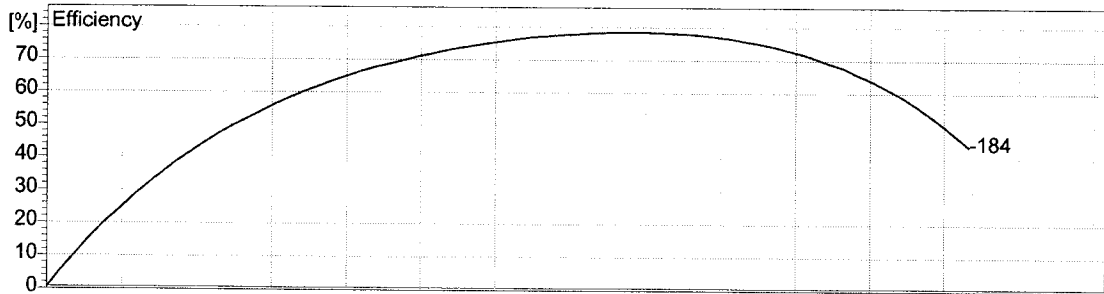
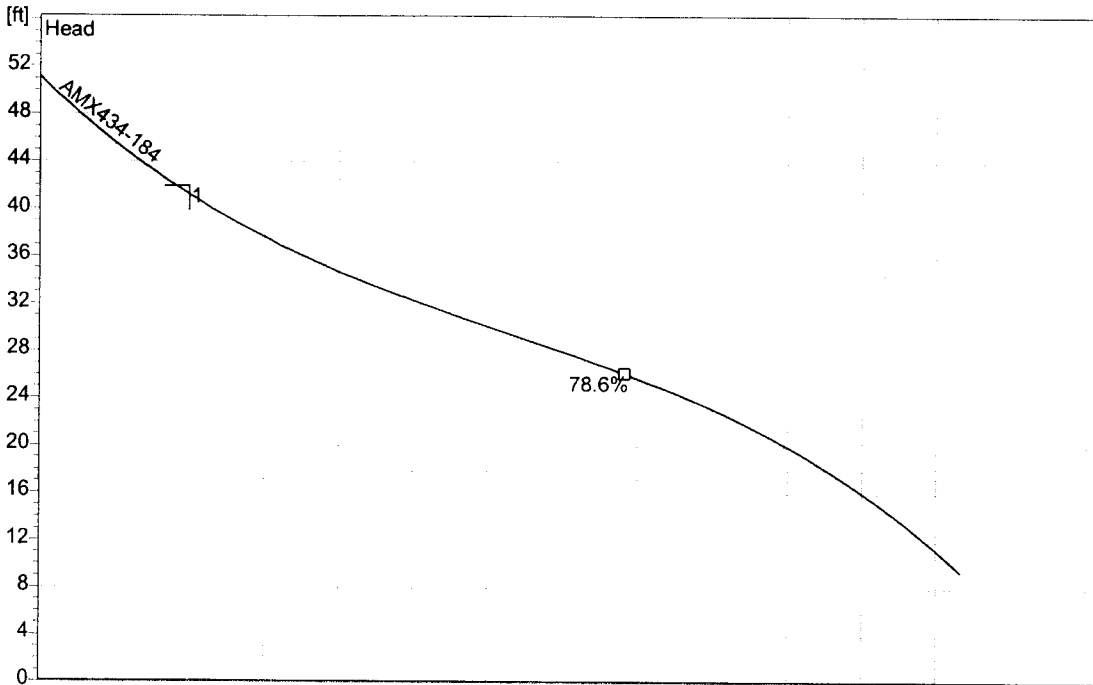

2.0 - 29.09.2004 (Build 60)

| | | | | |
|-------------------------------|---------------------------------------|---------------------------------|-------------------|----------------------------|
| Project Manatee Cty | Project no.: Item Number 21 | Created by: nackerman | Page: 2 | Date: 2005-09-14 |
|-------------------------------|---------------------------------------|---------------------------------|-------------------|----------------------------|

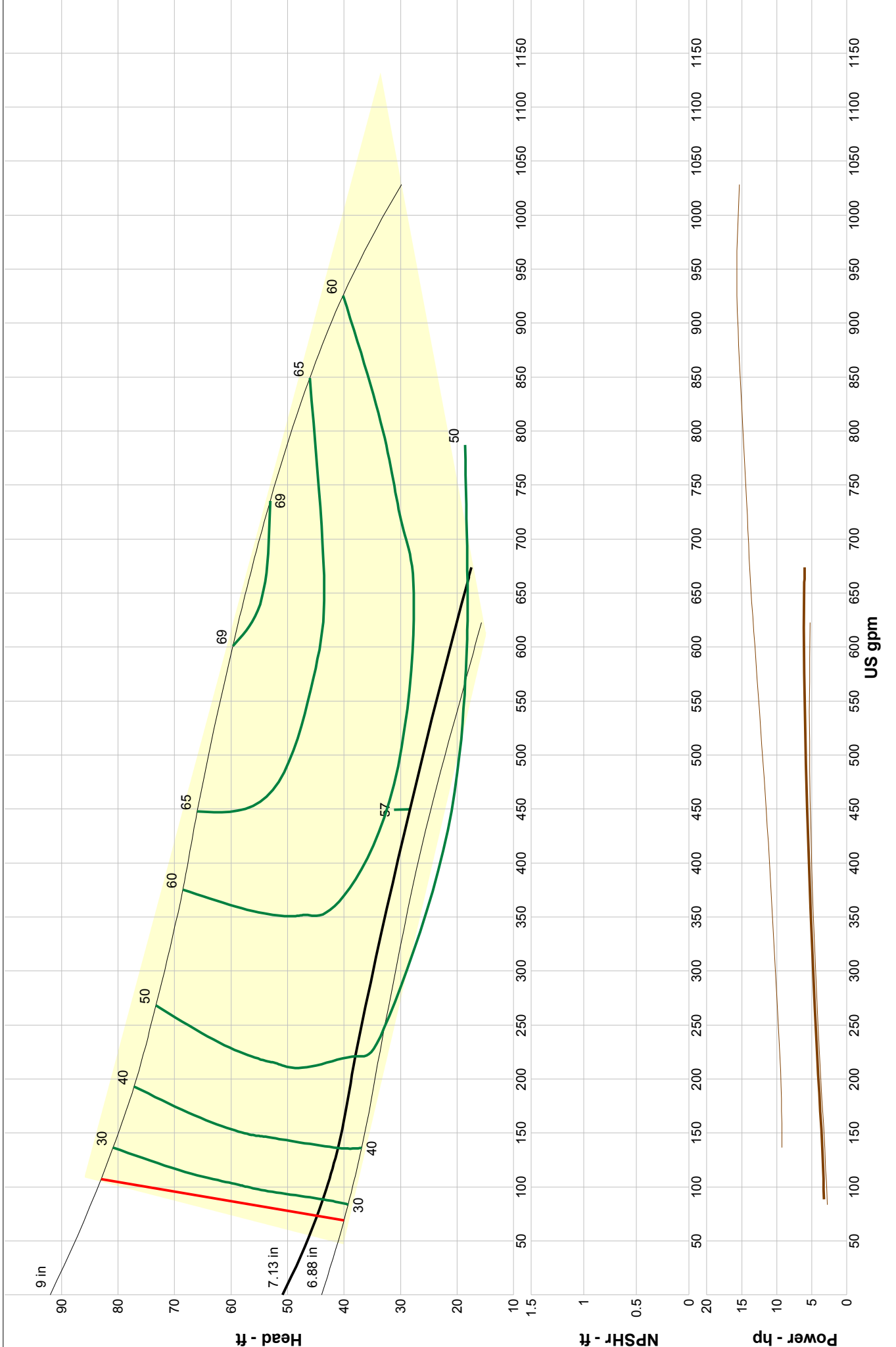

Company: Manatee County Utilities
 Name: 30-EE - RTU 333
 4/9/2012

HYDROMATIC
 Catalog: Non-Clog Pumps 60Hz, Vers Feb 2006
 NCLOG-4 - 1800

Size: S4M/S4MX
 Speed: 1750 rpm
 Dia: 7.13 in
 Curve: S4M1750



Performance Curve

AMX434-184/4,3T/C

| Impeller | | | | | | |
|---|----------------------------|---|-----------------------------------|---------------|-----------------------------------|--|
| Impeller type: Single channel impeller | Solid size 3 inch | Ø: | Max. Ø: 8 1/8" | Min. Ø: 7" | Sel. Ø: 7 1/4" | |
| Operating data | | | | | | |
| Speed: 1750 rpm | Frequency: 60 Hz | Duty point: Q = 238 US g.p.m. H = 30 ft | Shaft power P2: 3.28 hp | | Discharge port: 4" ANSI | |

Power data referred to: Water, clean [100%]; 68°F; 62.322lb/ft³; 1.0818E-5ft²/s

Testnorm: ISO 9906/A

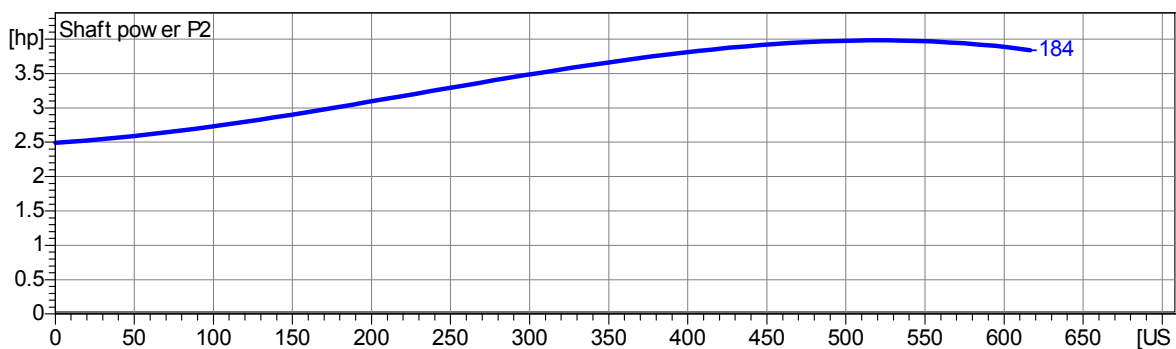
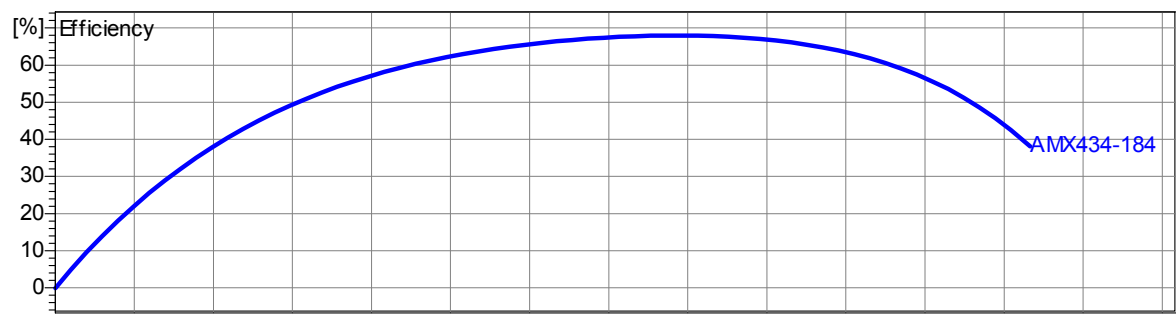
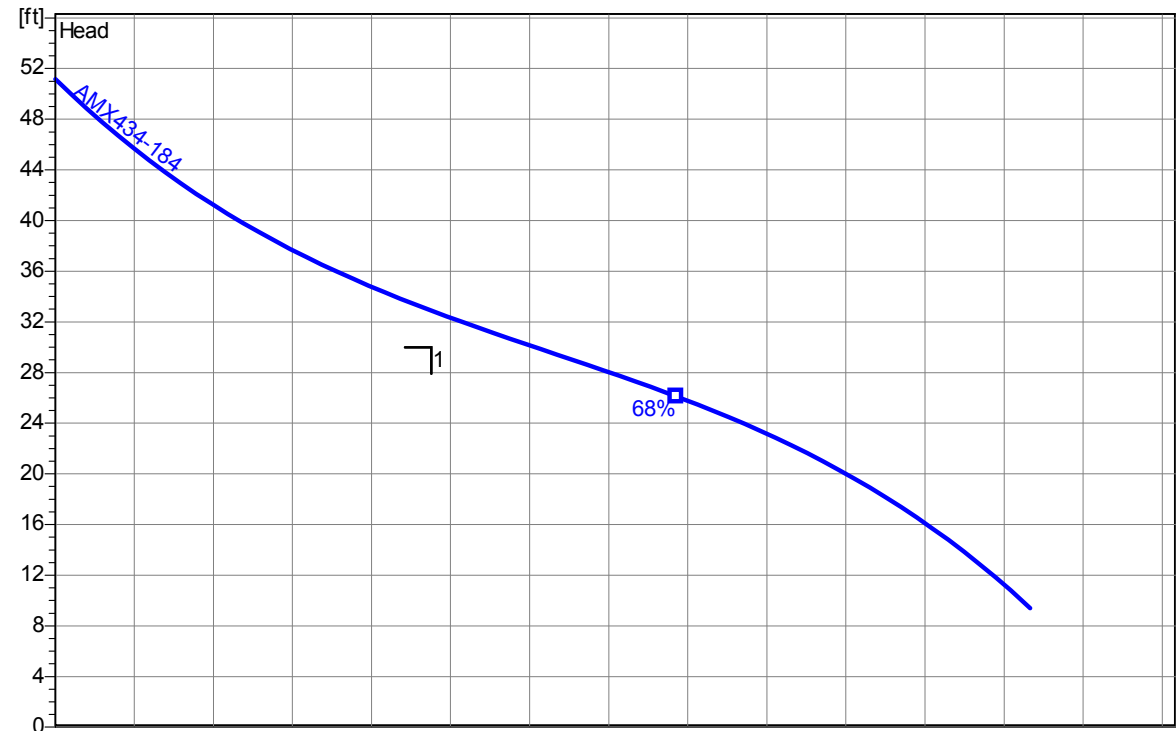

2.0 - 29.01.2009 (Build 168)

| | | | | |
|---------|---|-------------|-------------------|----------------------------|
| Project | Project no.: MANATEE COUNTY LS #32-AA | Created by: | Page: 2 | Date: 2011-11-06 |
|---------|---|-------------|-------------------|----------------------------|

Company: Manatee County Utilities

Name: 32AA - RTU 334

Date: 4/9/2012



Pump:

Size: S4N/S4NX
 Type: NCLOG-4
 Synch speed: 1800 rpm
 Curve: PAGE 109
 Specific Speeds:
 Dimensions:
 Speed: 1750 rpm
 Dia: 7 in
 Impeller:
 Ns: ---
 Nss: ---
 Suction: --- in
 Discharge: 4 in

Search Criteria:

Flow: --- US gpm Head: --- ft

Fluid:

Water
 Density: 62.37 lb/ft³
 Viscosity: 1.105 cP
 NPSHa: --- ft
 Temperature: 60 °F
 Vapor pressure: 0.2563 psi a
 Atm pressure: 14.7 psi a

Motor:

Consult HYDROMATIC to select a motor for this pump.

Pump Limits:

Temperature: 140 °F
 Pressure: 125 psi g
 Sphere size: 3 in
 Power: --- hp
 Eye area: --- in²

---- Data Point ----

Flow: 450 US gpm
 Head: 27.1 ft
 Eff: 66%
 Power: 4.66 hp
 NPSHr: --- ft

---- Design Curve ----

Shutoff head: 51.3 ft
 Shutoff dP: 22.2 psi
 Min flow: 45 US gpm
 BEP: 66% @ 426 US gpm
 NOL power:
 4.98 hp @ 544 US gpm

-- Max Curve --

Max power:
 9.61 hp @ 677 US gpm

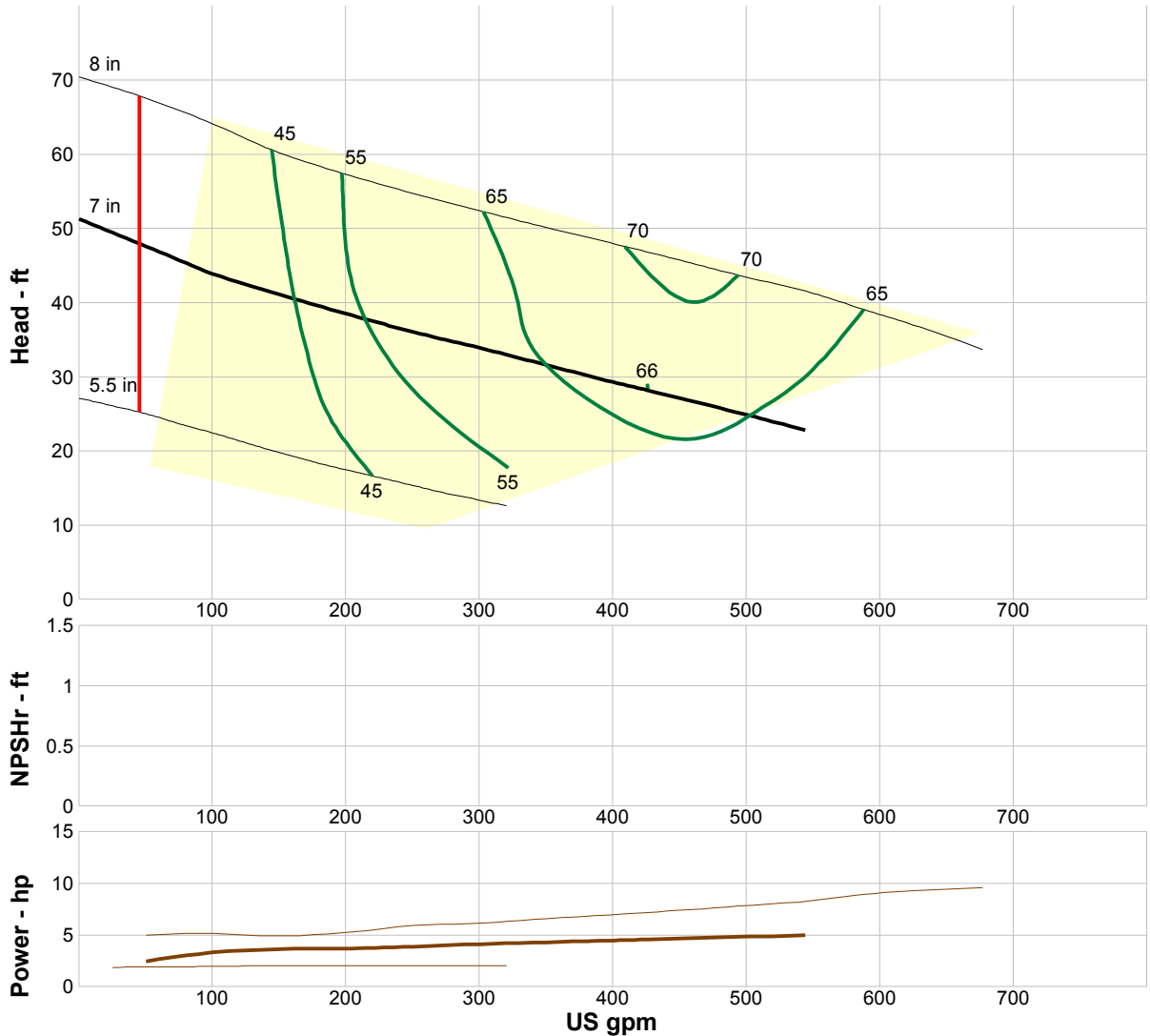

Performance Evaluation:

| Flow US gpm | Speed rpm | Head ft | Efficiency % | Power hp | NPSHr ft |
|----------------|--------------|------------|-----------------|-------------|-------------|
| 522 | 1750 | 23.8 | 64 | 4.91 | --- |
| 435 | 1750 | 27.8 | 66 | 4.61 | --- |
| 348 | 1750 | 31.7 | 65 | 4.3 | --- |
| 261 | 1750 | 35.6 | 59 | 3.94 | --- |
| 174 | 1750 | 39.8 | 47 | 3.68 | --- |

32AC (336)

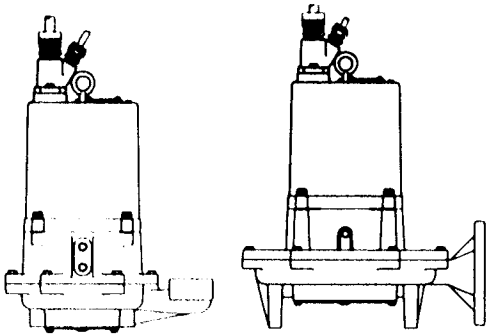

Performance Curve **HPGH/HPGHH**
 RPM: **3500** Discharge: **2"**

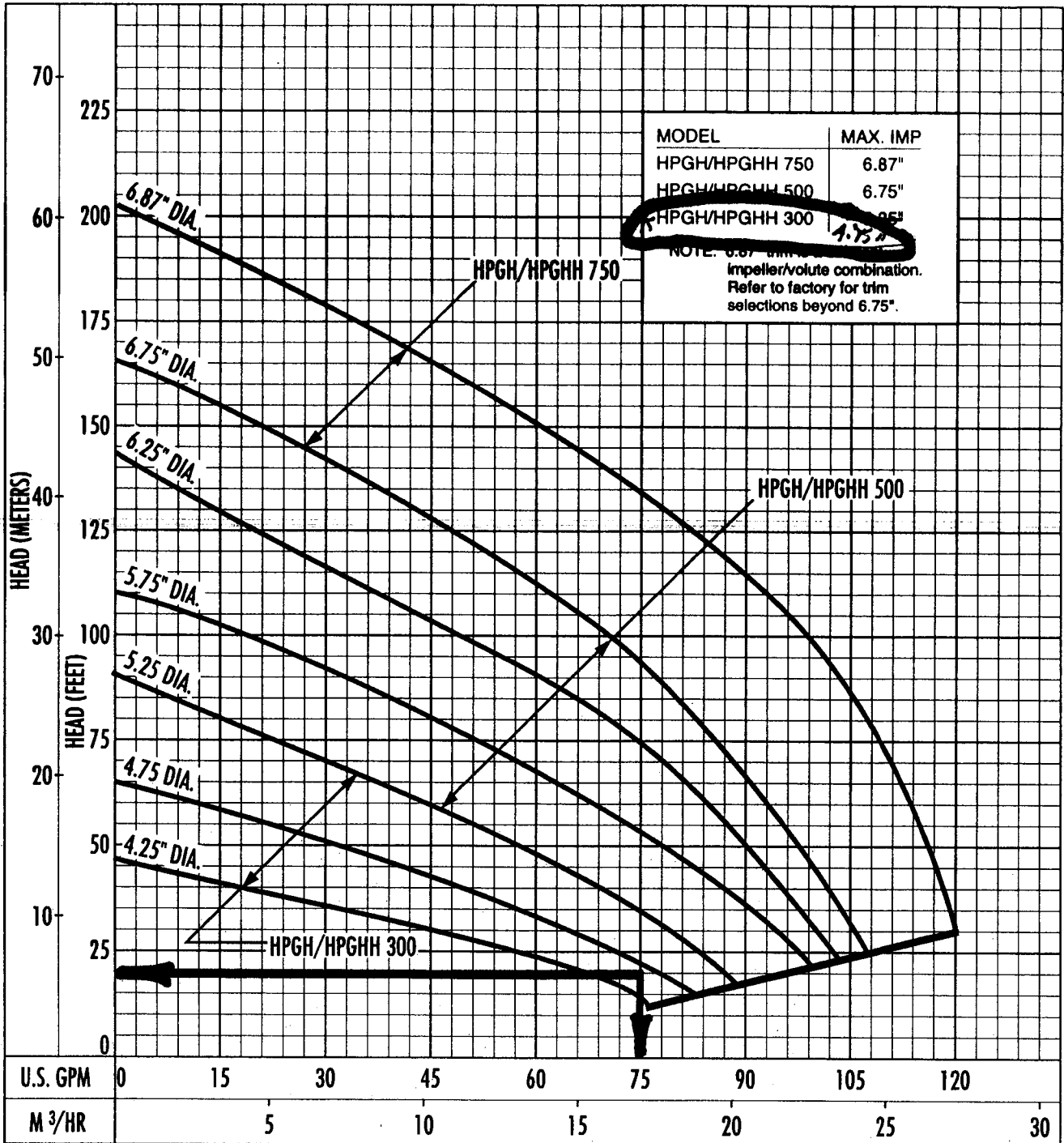

The curves reflect maximum performance characteristics without exceeding full load (Nameplate) horsepower. All pumps have a service factor of 1.2. Operation is recommended in the bounded area with operational point within the curve limit. Performance curves are based on actual tests with clear water at 70° F. and 1280 feet site elevation.

Conditions of Service:

GPM: _____ TDH: _____



RTU 338
S-2
Installed 7-20-2011

| Impeller | | | | | |
|--|-----------------------------|---|---|---|---|
| Impeller type: Single channel impeller | Solid size 4 inch | Ø: | Max. Ø: 12⁵/₁₆" | Min. Ø: 7⁷/₈" | Sel. Ø: 11⁷/₁₆" |
| Operating data | | | | | |
| Speed: 1750 rpm | Frequency: 60 Hz | Duty point: Q = 342 US g.p.m. H = 93 ft | Suction port: | Discharge port: 4" ANSI | |
| Power data referred to: Water, pure [100%] ; 68°F; 62.322lb/ft ³ ; 1.0775E-5ft ² /s | | | Testnom: | ISO 9906 | |

Curve number:

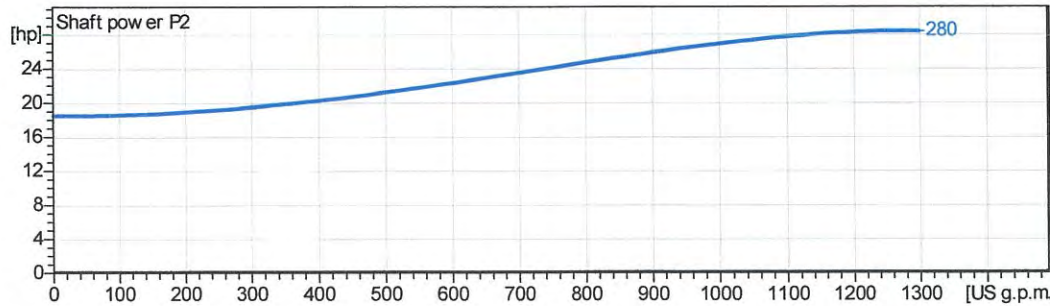
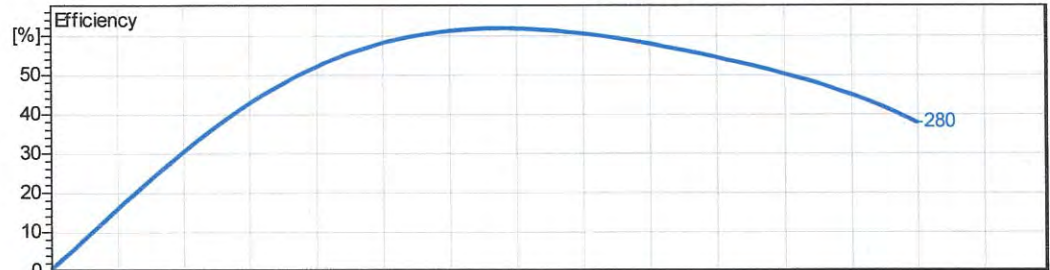
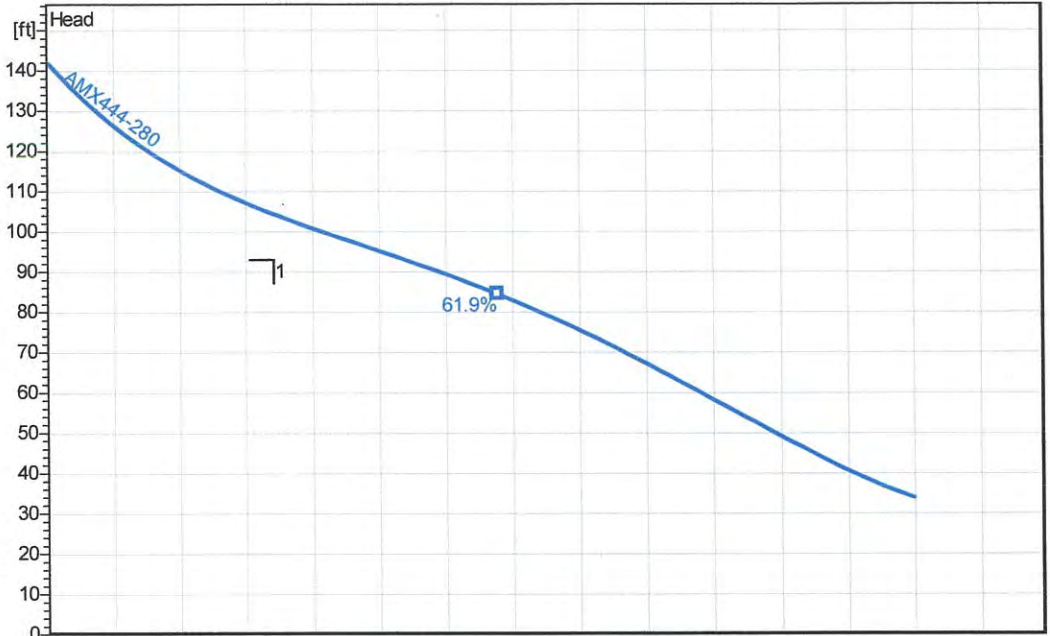

2.0 - 11.01.2008 (Build 137) Homa Pump Technology Inc. (internal)

| | | | | |
|----------------------------------|----------------------------|----------------------------------|-------------------|----------------------------|
| Project Manatee County | Project no.: S-2 | Created by: nyackerman | Page: 2 | Date: 2010-10-08 |
|----------------------------------|----------------------------|----------------------------------|-------------------|----------------------------|

RTU 339



S-3

Pump performance curves
AFP 1049 60 HZ

Curve number

Reference curve
AFP 1049

250 GPM at 85 TDH 14 HP

Discharge
DN100

Frequency
60 Hz

Density
62.43 lb/ft³

Viscosity
0.0000169 ft²/s

Testnorm
Hydraulic Institute

Rated speed
1735 rpm

Date
2008-10-27

Flow
259 US g.p.m.

Head
91.4 ft

Rated power
10.8 hp

Hydraulic efficiency
55.3 %

NPSH
4.2 ft

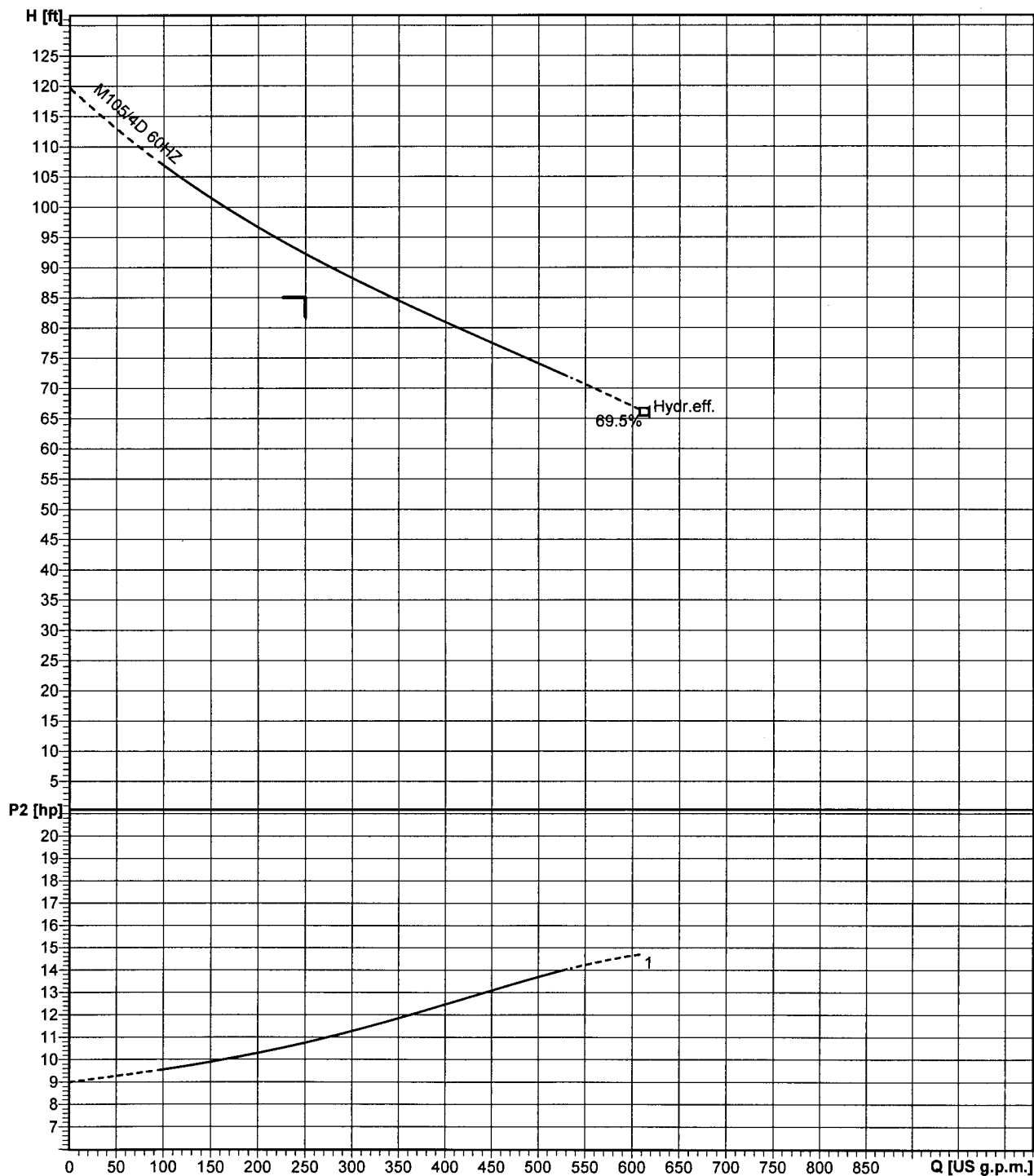

Impeller size
9.96 inch

N° of vanes
1

Impeller
ContraBlock impeller, 1 vane

Solid size
3 1/8"

Revision 2007-04-20

ABS reserves the right to change any data and dimensions without prior notice and can not be held responsible for the use of information contained in this software.

ABSEL PRO 1.7.2 / 2007-02-07

Performance Curve

AMX434-184/4D/C

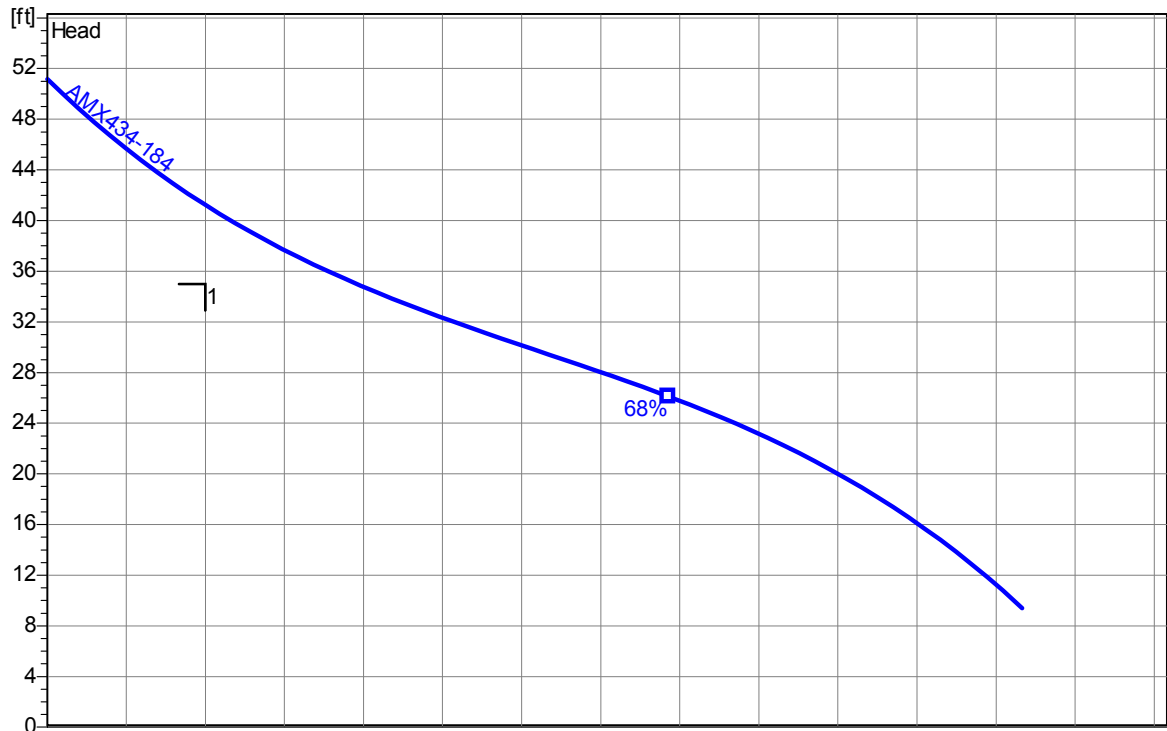
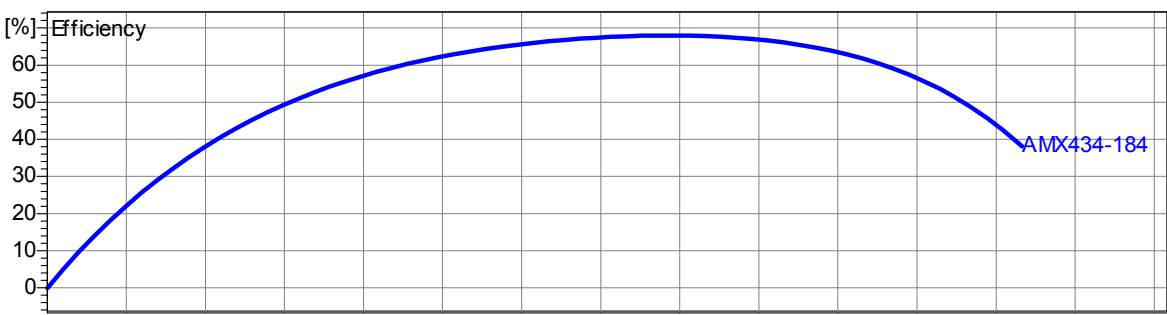
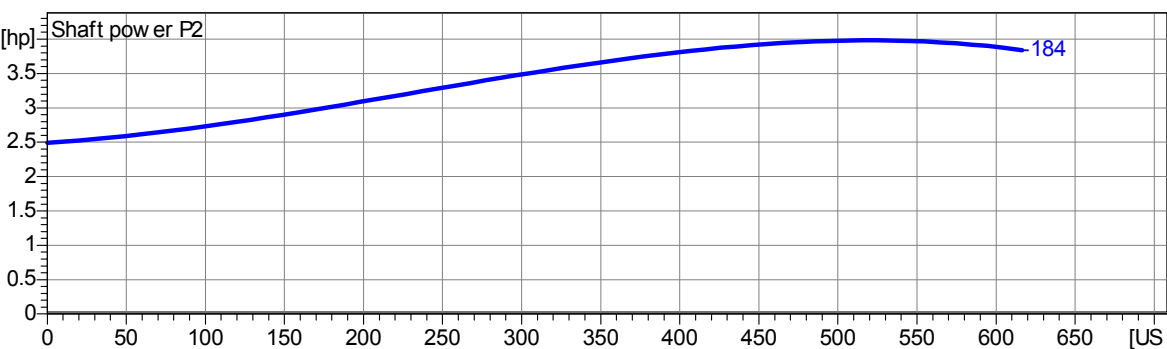
| Impeller | | | | | |
|--|---------------------------------|--|----------------------------------|---------------------------|-----------------------------------|
| Impeller type: Single channel impeller | Solid size 3 inch | Ø: | Max. Ø: 8 1/8" | Min. Ø: 5 9/16" | Sel. Ø: 7 1/4" |
| Operating data | | | | | |
| Speed: 1750 rpm | Frequency: 60 Hz | Duty point: Q = 100 US g.p.m. H = 35 ft | | Suction port: | Discharge port: 4" ANSI |
| Power data referred to: Water, pure [100%]; 68°F; 62.322lb/ft³; 1.0818E-5ft²/s | | | | Testnorm: | ISO 9906 |
| Curve number: | | | | | |
|  | | | | | |
|  | | | | | |
|  | | | | | |
| Project Man. Cty IFB #09-0897-OV | Project no.: LS # S-4 | | Created by: nyackerman | Page: 2 | Date: 4/4/2009 |

RTU 341
S-5
Installed 7-15-11

| Impeller | | | | | |
|--|-----------------------------|---|---|--|--|
| Impeller type: Single channel impeller | Solid size 3 inch | Ø: 9¹³/₁₆" | Max. Ø: 8¹/₈" | Min. Ø: 8⁹/₁₆" | Sel. Ø: 8⁹/₁₆" |
| Operating data | | | | | |
| Speed: 1750 rpm | Frequency: 60 Hz | Duty point: Q = 450 US g.p.m. H = 40 ft | Suction port: | Discharge port: 4" ANSI | |
| Power data referred to: Water, pure [100%] ; 68°F; 62.322lb/ft ³ ; 1.0818E-5ft ² /s | | | Testnorm: | ISO 9906 | |

Curve number:

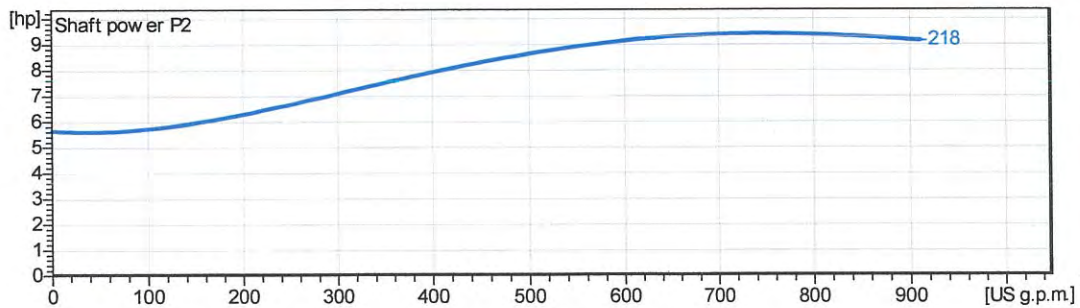
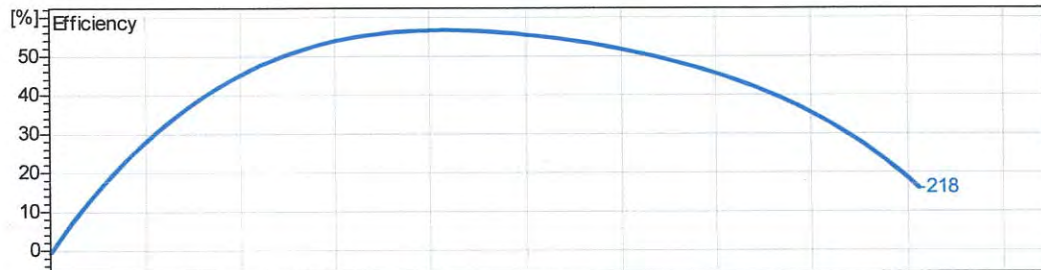
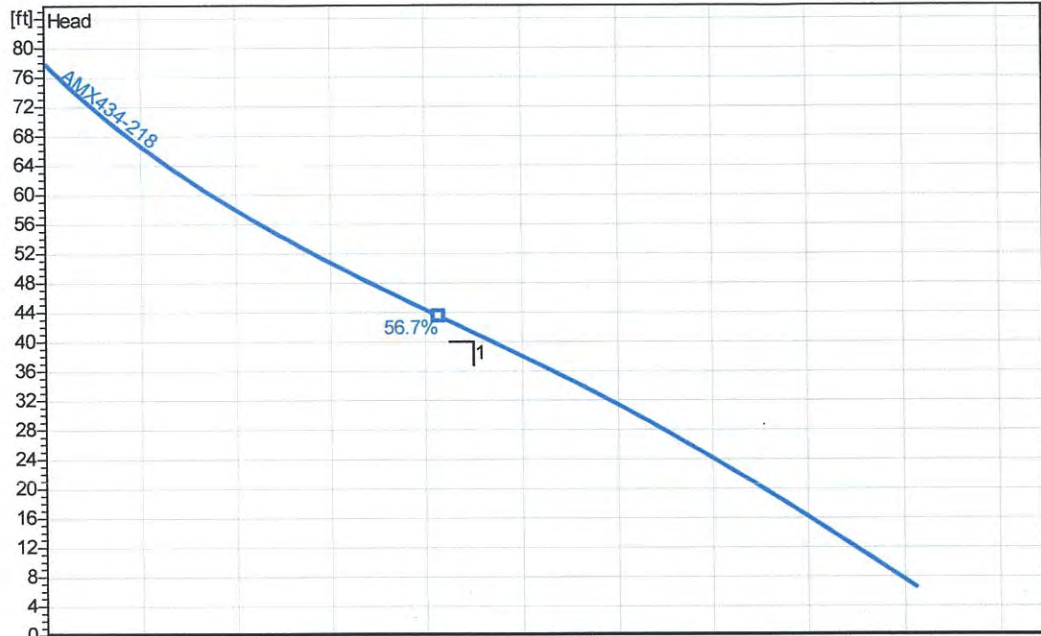

2.0 - 11.01.2008 (Build 137) Homa Pump Technology Inc. (internal)

| | | | | |
|----------------------------------|----------------------------|----------------------------------|-------------------|----------------------------|
| Project Manatee County | Project no.: S-5 | Created by: nyackerman | Page: 2 | Date: 2010-10-08 |
|----------------------------------|----------------------------|----------------------------------|-------------------|----------------------------|

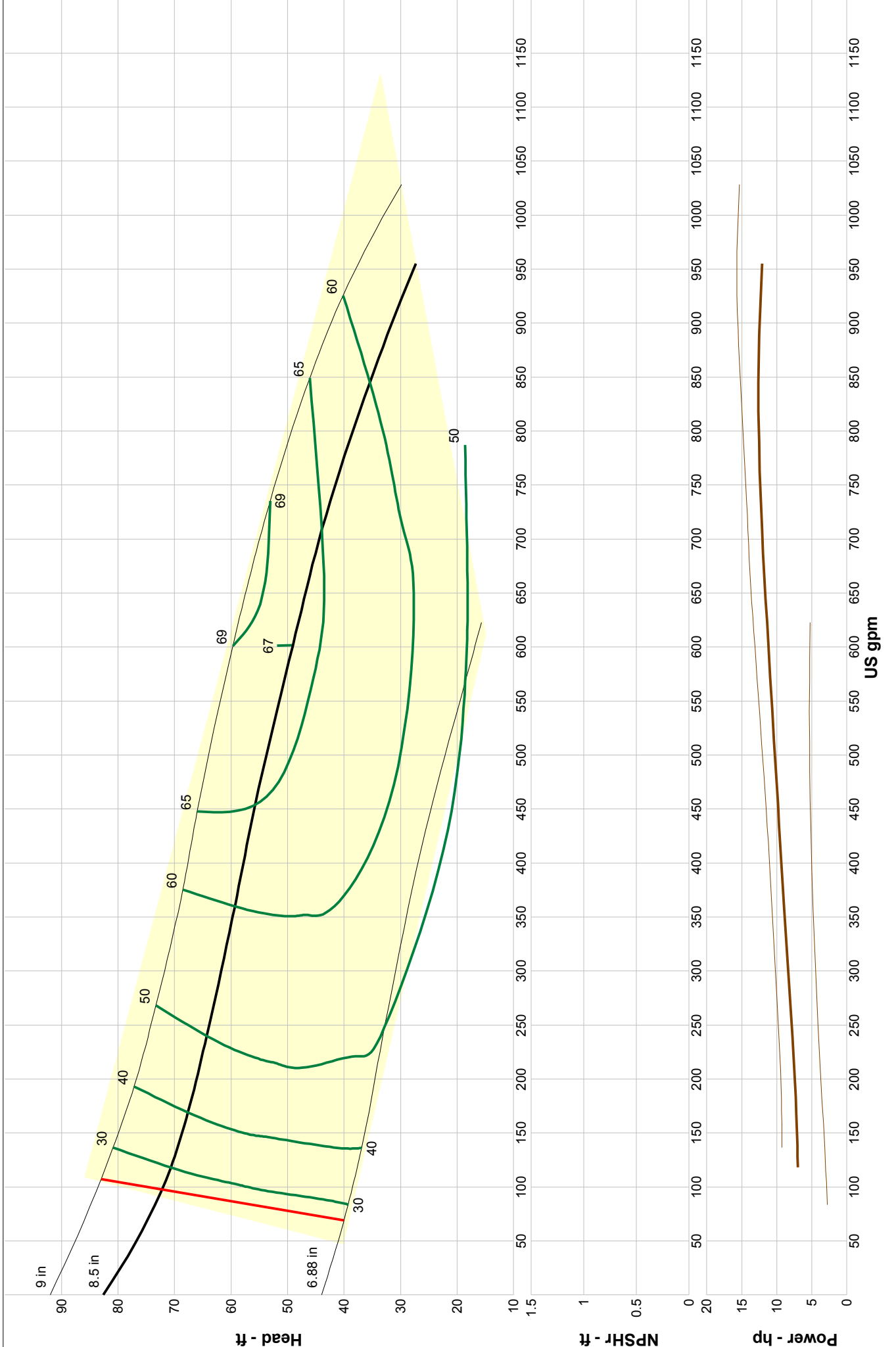

Company: Manatee County Utilities
 Name: S6 - RTU 342
 4/9/2012

HYDROMATIC
 Catalog: Non-Clog Pumps 60Hz, Vers Feb 2006
 NCLOG-4 - 1800

Size: S4M/S4MX
 Speed: 1750 rpm
 Dia: 8.5 in
 Curve: S4M1750



Performance Curve – S3HRC/S3HVX

RPM: 3450 DISCHARGE: 3" SOLIDS: 2"

Lift Station 343

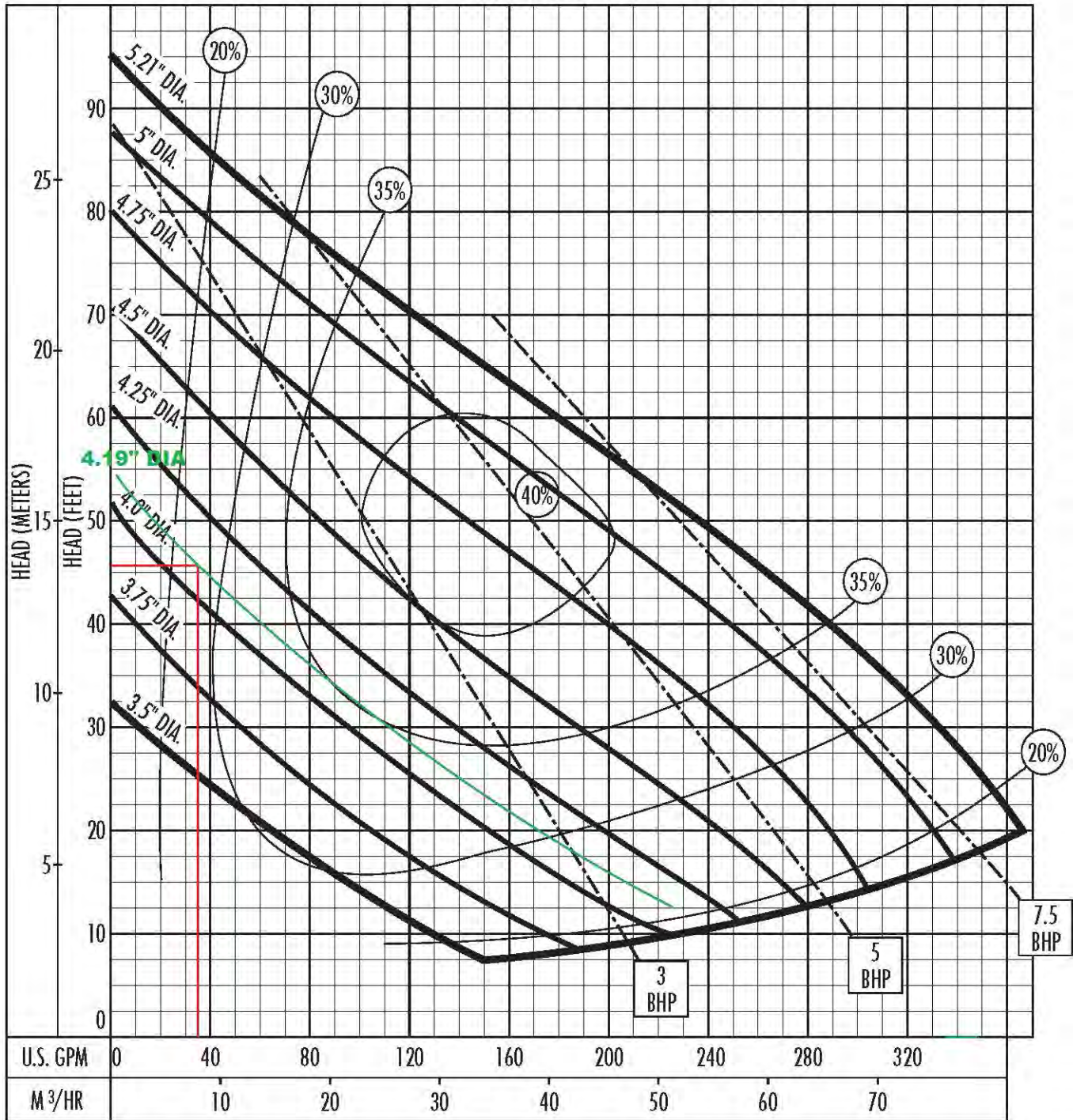

The curves reflect maximum performance characteristics without exceeding full load (Nameplate) horsepower. All pumps have a service factor of 1.2. Operation is recommended in the bounded area with operational point within the curve limit. Performance curves are based on actual tests with clear water at 70° F. and 1280 feet site elevation.

Conditions of Service:



HYDROMATIC

GPM: **35**

TDH: **46**

Performance Curve – S4N/S4NX

RPM: **1750** DISCHARGE: **4"** SOLIDS: **3"**

Lift Station 361

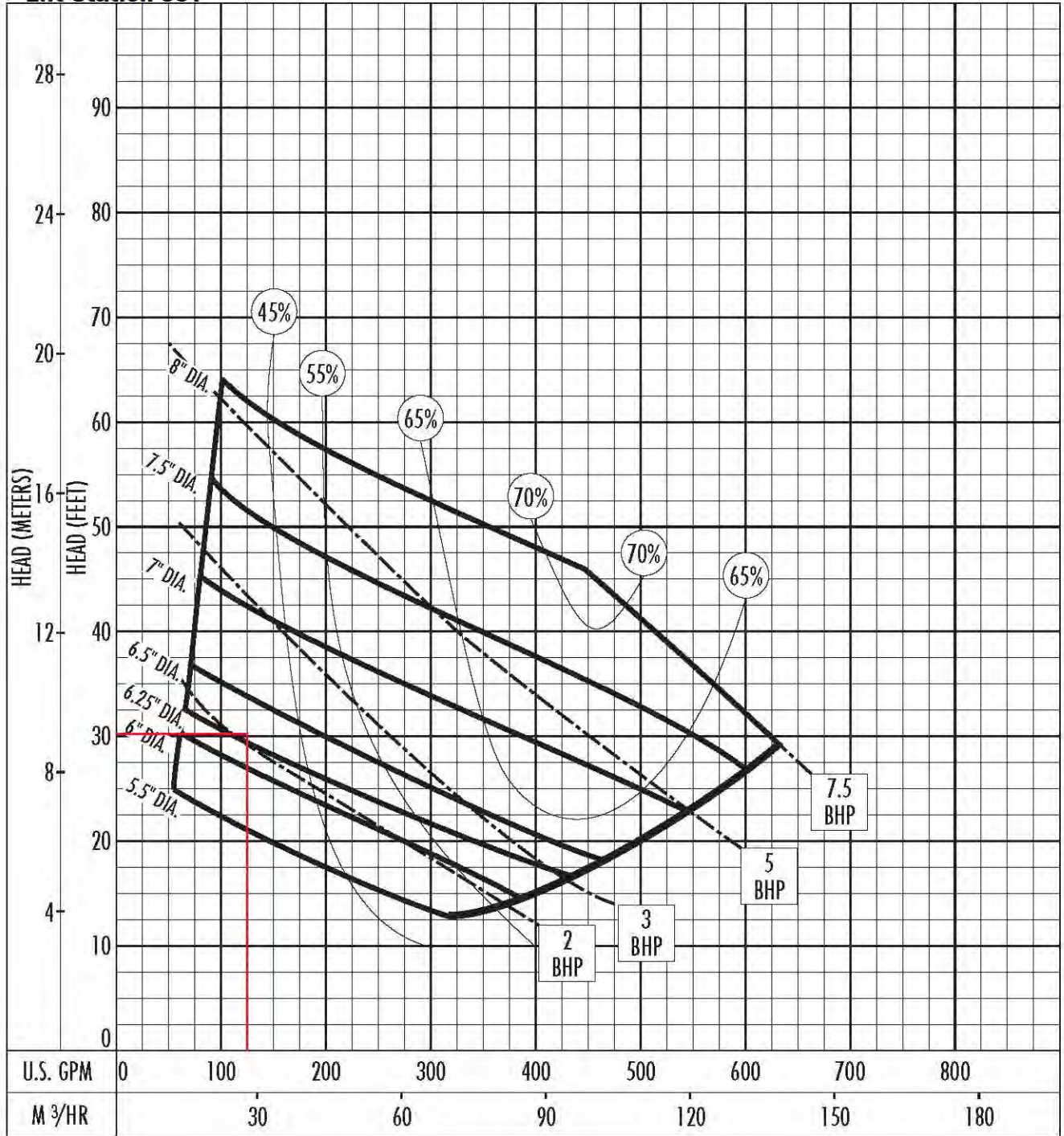

The curves reflect maximum performance characteristics without exceeding full load (Nameplate) horsepower. All pumps have a service factor of 1.2. Operation is recommended in the bounded area with operational point within the curve limit. Performance curves are based on actual tests with clear water at 70° F. and 1280 feet site elevation.

Conditions of Service:

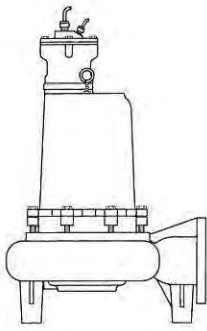

Lift Station 393

Performance Curve

S4P/S4PX

RPM: **1750** Discharge: **4"** Solids: **3"**

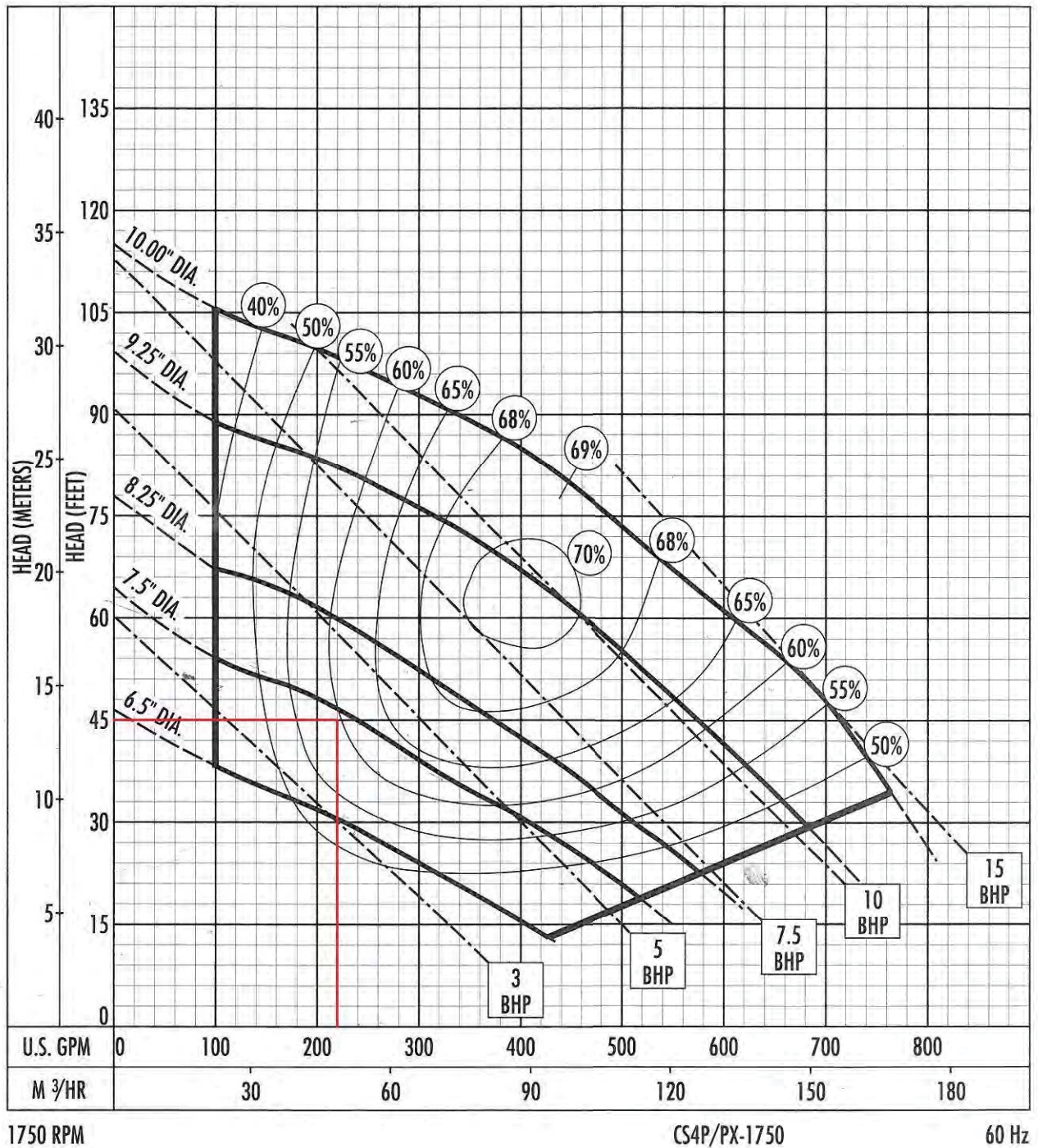

The curves reflect maximum performance characteristics without exceeding full load (Nameplate) horsepower. All pumps have a service factor of 1.2. Operation is recommended in the bounded area with operational point within the curve limit. Performance curves are based on actual tests with clear water at 70° F. and 1280 feet site elevation.

Selection chart

Single Phase

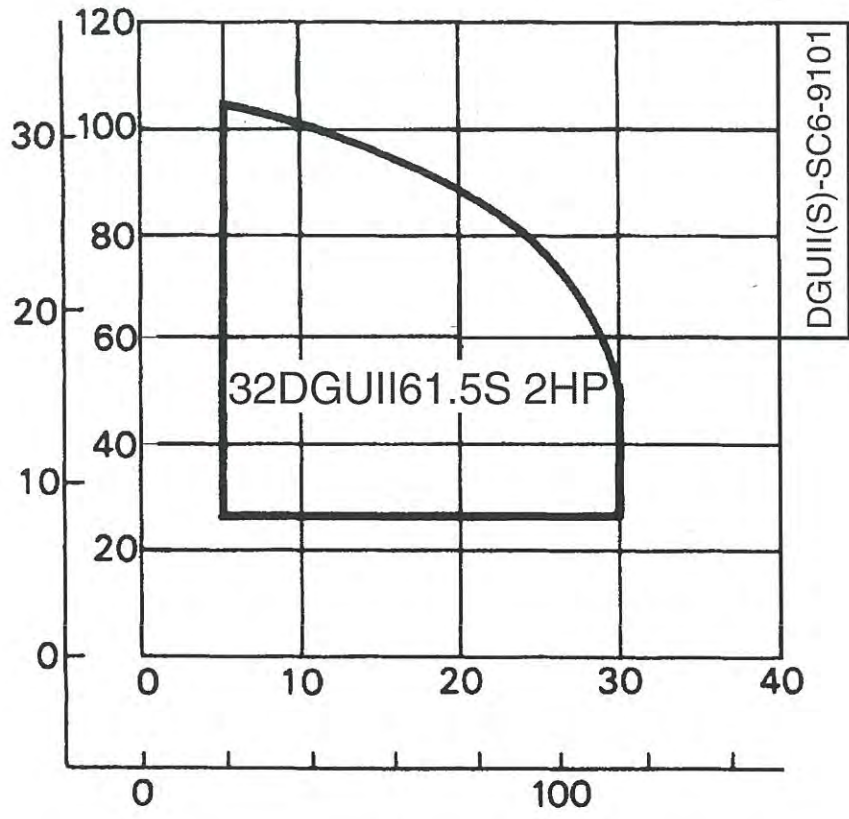

Series 4SE-L

Performance Curve
2.8, 3.7 & 5.0HP, 1750RPM, 60Hz

BARNES®

www.cranepumps.com

4" Horizontal Discharge - Submersible Non-Clog Pumps

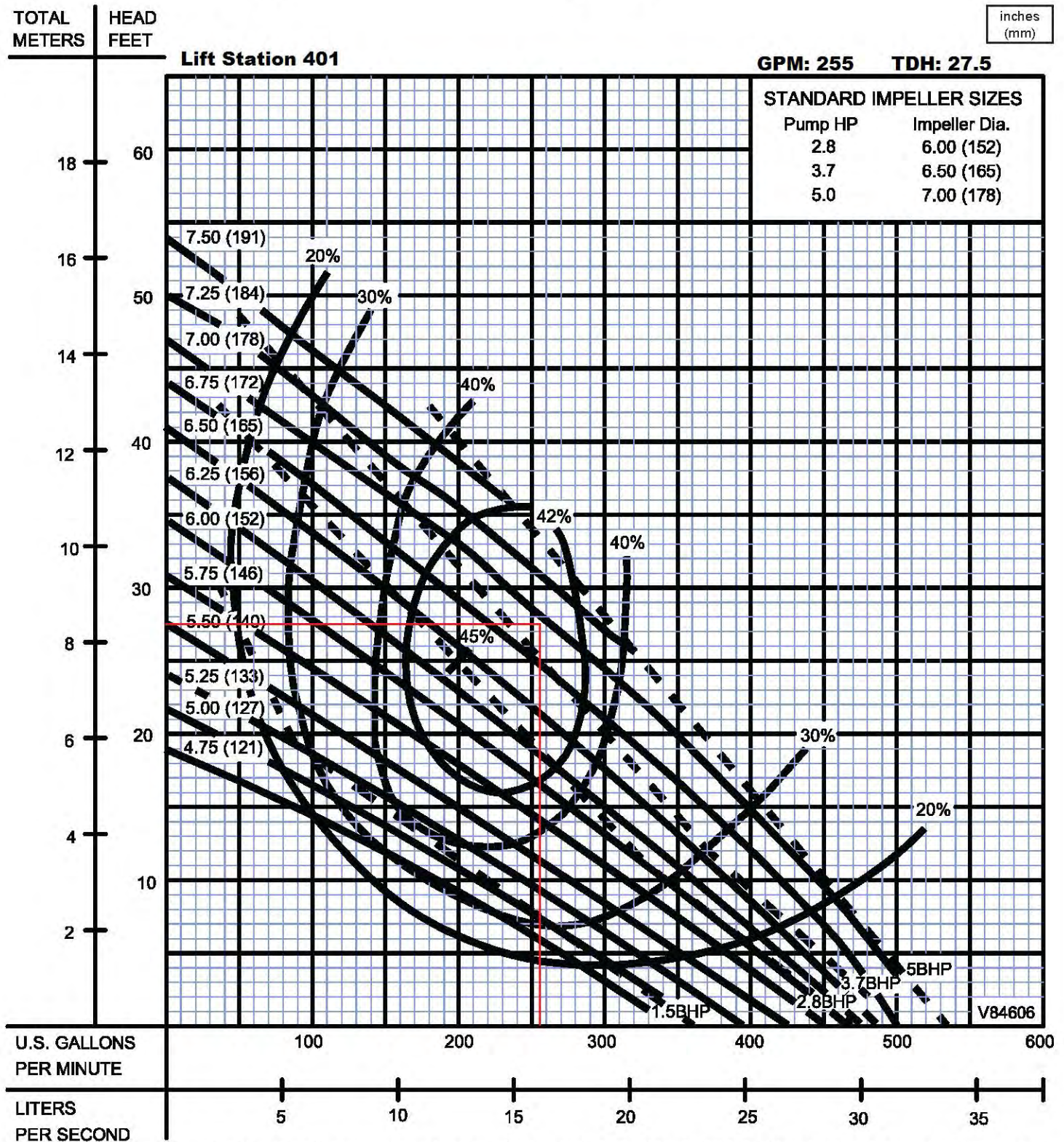

SECTION 1D
PAGE 10
DATE 1/05

CRANE®

PUMPS & SYSTEMS

A Crane Co. Company

USA: (937) 778-8947 • Canada: (905) 457-6223 • International: (937) 615-3598



15-A

Pump performance curves
AFP 1041 60 Hz

Curve number

Reference curve
AFP 1041

15-A Lift Station

(402)

Discharge
DN100

Frequency
60 Hz

Density
62.428 lb/ft³

Viscosity
0.00016813 ft²/s

Testnom
Hydraulic Institute

Rated speed
1700..1680 rpm

Date
2007-07-31

Flow
252 US g.p.m.

Head
35.5 ft

Rated power
3.85 hp

Hydraulic efficiency
58.7 %

NPSH
3.7 ft

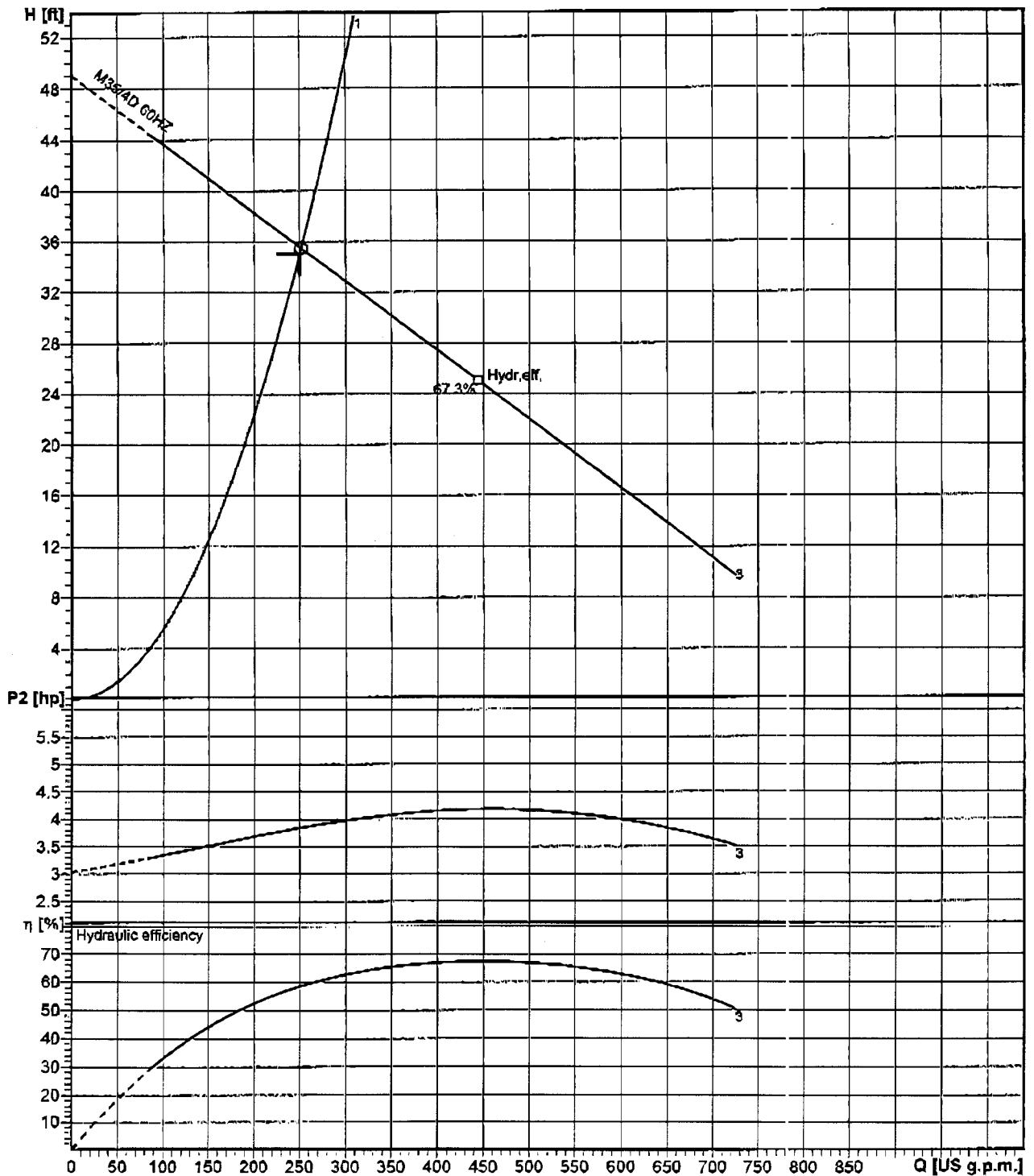

Impeller size
9.06..7.64 inch

N° of vanes
1

Impeller
ContraBlock impeller, 1 vane

Solid size
3 1/2"

Revision 2005-11-07

ABS reserves the right to change any data and dimensions without prior notice and can not be held responsible for the use of information contained in this software.

Series 4SE-L

Performance Curve

2.8, 3.7 & 5.0HP, 1750RPM, 60Hz

BARNES®

www.cranepumps.com

4" Horizontal Discharge - Submersible Non-Clog Pumps

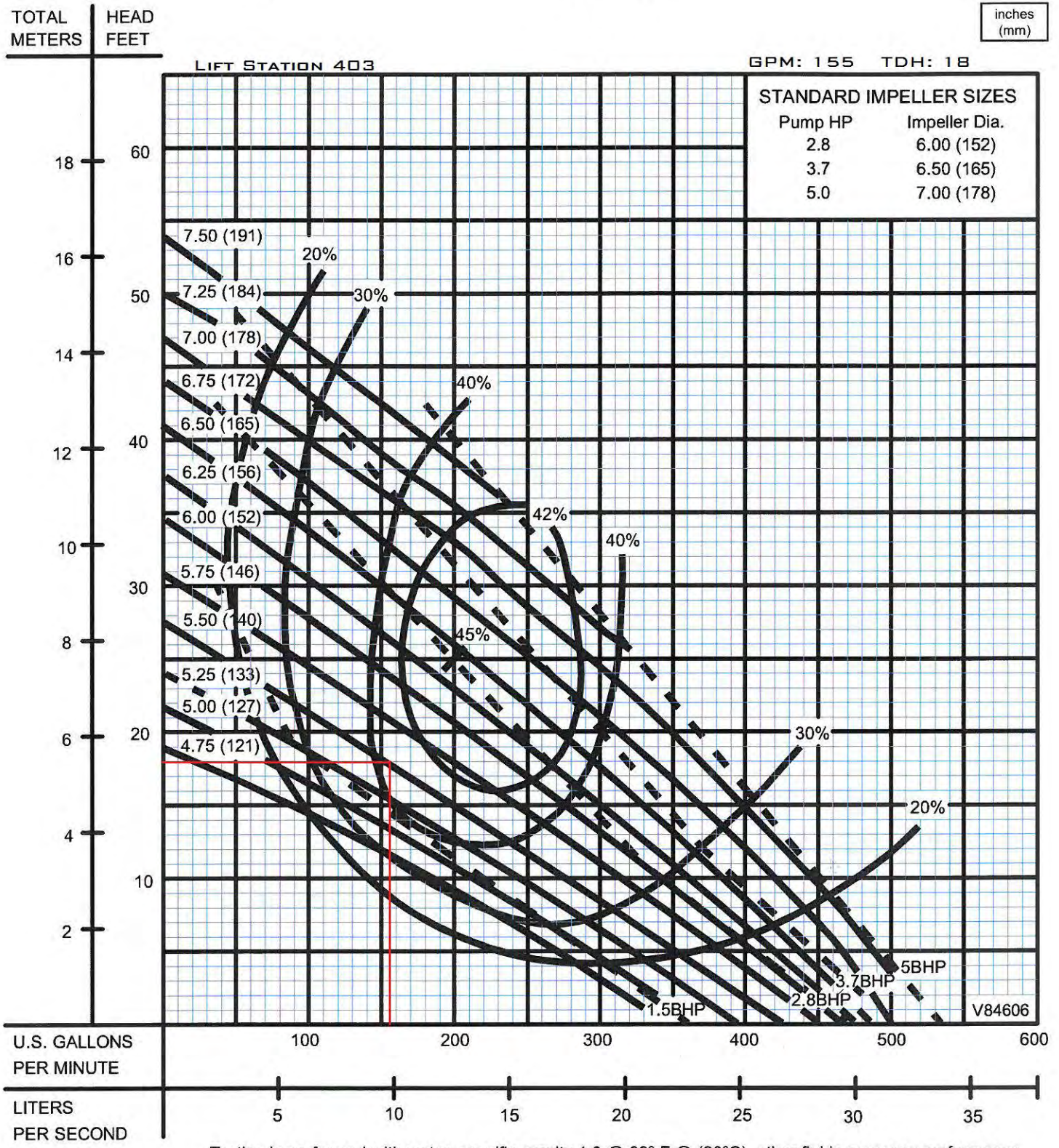

SECTION 1D
PAGE 10
DATE 1/05

CRANE
A Crane Co. Company

PUMPS & SYSTEMS

USA: (937) 778-8947 • Canada: (905) 457-6223 • International: (937) 615-3598

Performance Curve – S4N/S4NX

RPM: **1750** DISCHARGE: **4"** SOLIDS: **3"**

Lift Station 404

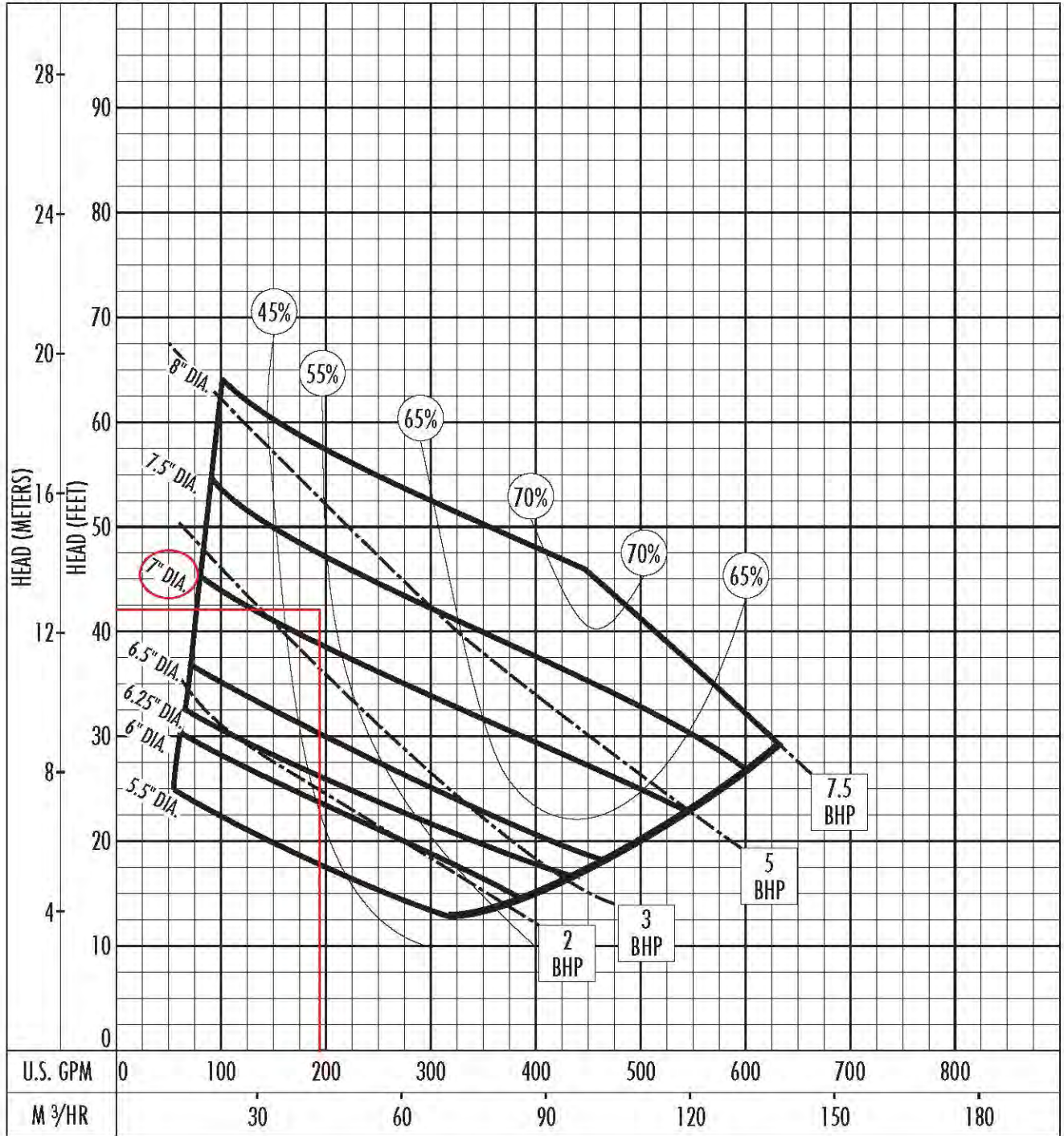

The curves reflect maximum performance characteristics without exceeding full load (Nameplate) horsepower. All pumps have a service factor of 1.2. Operation is recommended in the bounded area with operational point within the curve limit. Performance curves are based on actual tests with clear water at 70° F. and 1280 feet site elevation.

Conditions of Service:



Performance Curve

AMX434-228/10T

Windmill Village (405)

Impeller

| | | | | |
|---|--------------------------------|----------------------------|--------------------------|----------------------|
| Impeller type: Single vane impeller | Solid size Ø: 3 1/8" | Max. Ø: 9 13/16" | Min. Ø: 8 1/8" | Sel. Ø: 9" |
|---|--------------------------------|----------------------------|--------------------------|----------------------|

Operating data

| | | | | |
|---------------------------|----------------------------|--|---------------------------------|-----------------------------------|
| Speed: 1700 rpm | Frequency: 60 Hz | Duty point: Q = 184 US g.p.m. H = 59.5 ft | Suction port: 4" ANSI | Discharge port: 4" ANSI |
|---------------------------|----------------------------|--|---------------------------------|-----------------------------------|

| | |
|--|------------------------------|
| Power data referred to: Water, pure [100%] ; 68°F; 62.322lb/ft³; 1.0818E-5ft²/s | Testnorm: ISO 9906 |
|--|------------------------------|

Curve number:

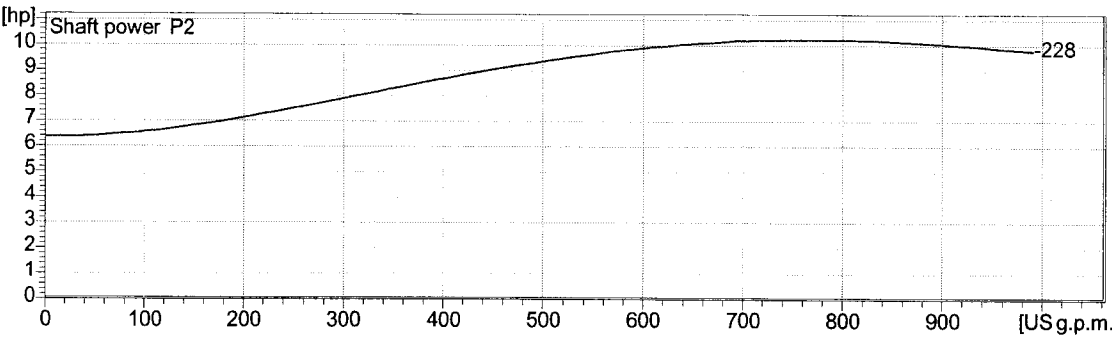
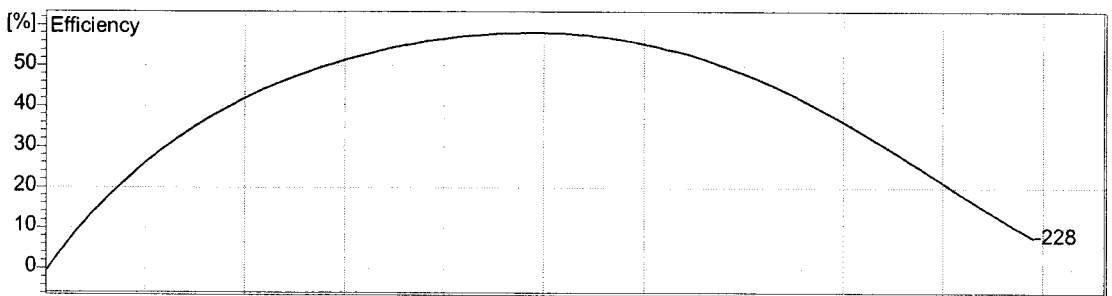
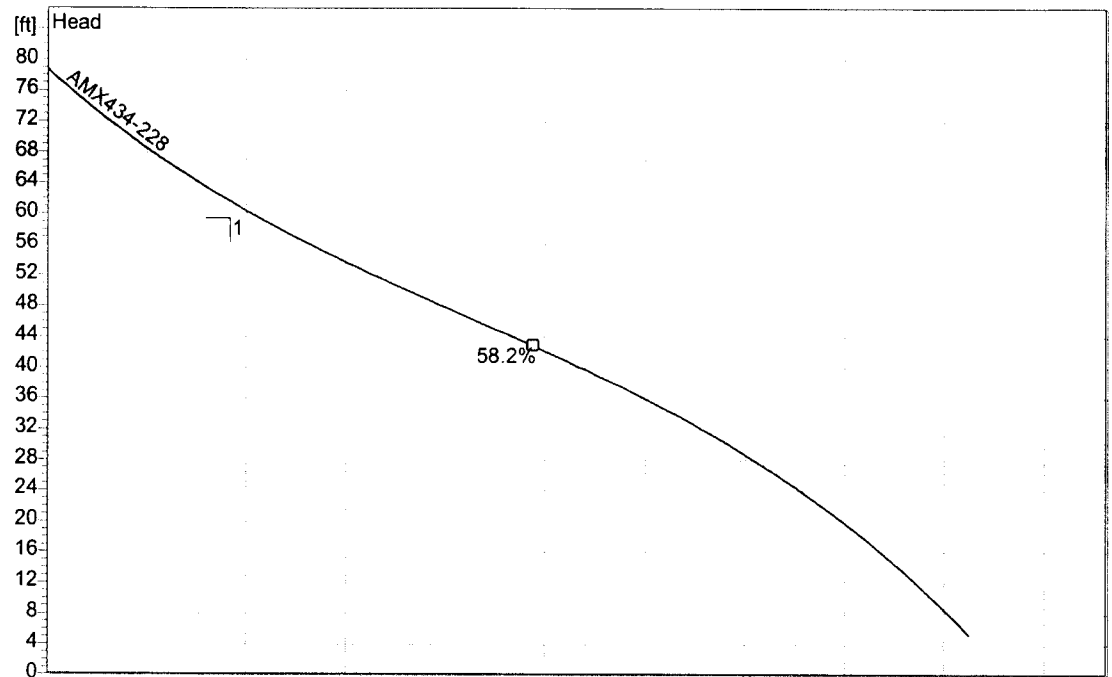

| | | | | |
|-------------------------------|---------------------------------------|---------------------------------|-------------------|----------------------------|
| Project Manatee Cty | Project no.: Item Number 31 | Created by: nackerman | Page: 2 | Date: 2005-09-14 |
|-------------------------------|---------------------------------------|---------------------------------|-------------------|----------------------------|

2.0 - 29.09.2004 (Build 60)



Performance Curve

AMX434-193/5,5T

18-A (406)

Impeller

| | | | | |
|---|--------------------------------|--------------------------|---------------------------|--------------------------|
| Impeller type: Single vane impeller | Solid size Ø: 3 1/8" | Max. Ø: 8 1/8" | Min. Ø: 5 9/16" | Sel. Ø: 7 5/8" |
|---|--------------------------------|--------------------------|---------------------------|--------------------------|

Operating data

| | | | | |
|---------------------------|----------------------------|--|---------------------------------|-----------------------------------|
| Speed: 1700 rpm | Frequency: 60 Hz | Duty point: Q = 250 US g.p.m. H = 38 ft | Suction port: 4" ANSI | Discharge port: 4" ANSI |
|---------------------------|----------------------------|--|---------------------------------|-----------------------------------|

Power data referred to: Water, pure [100%] ; 68°F; 62.322lb/ft³; 1.0818E-5ft²/s Testnorm: ISO 9906

Curve number:

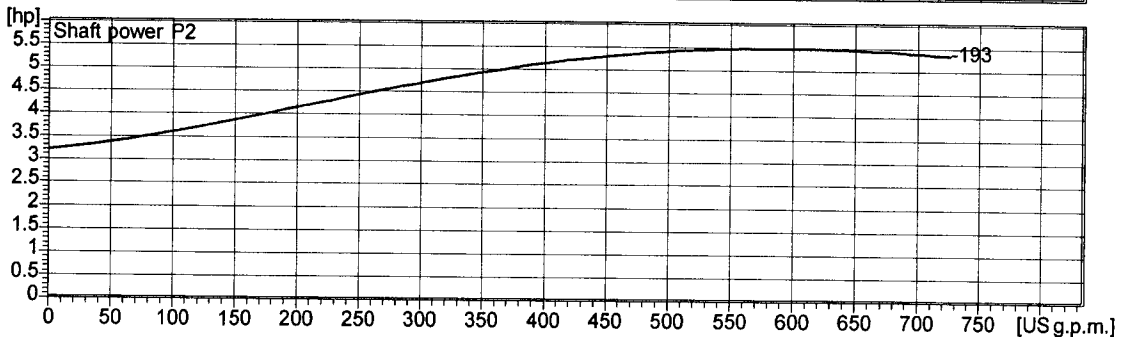
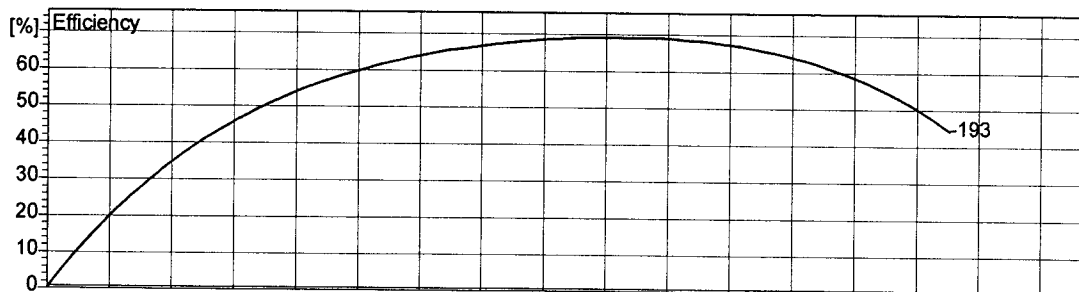
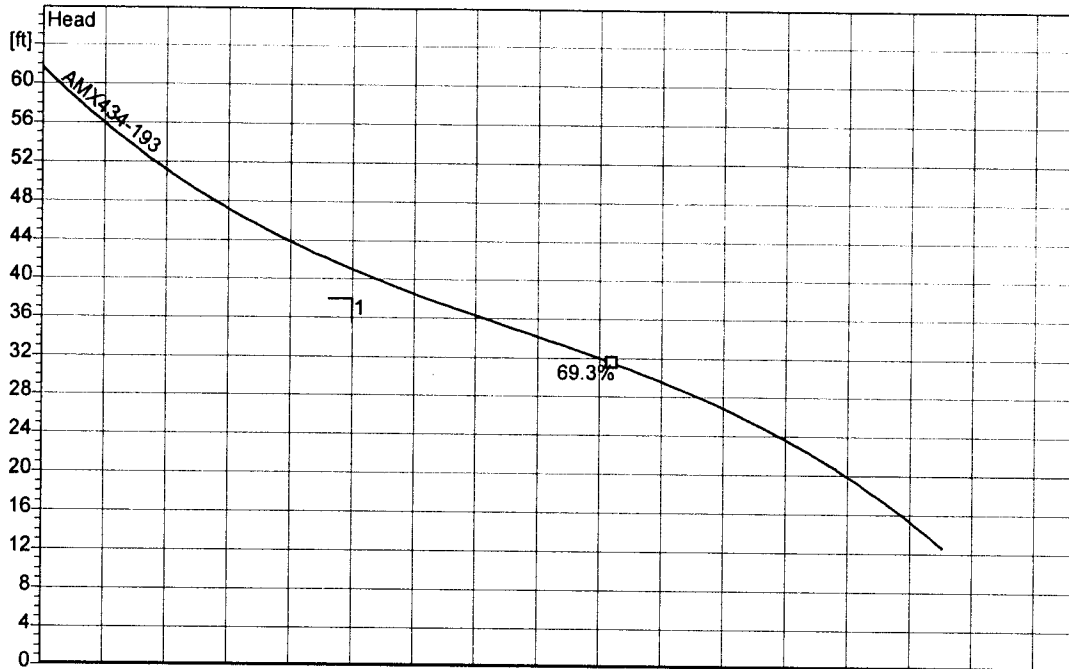

2.0 - 29.09.2004 (Build 60)

| | | | | |
|-------------------------------|--------------------------------------|---------------------------------|-------------------|----------------------------|
| Project Manatee Cty | Project no.: Item number 3 | Created by: nackerman | Page: 2 | Date: 2005-09-14 |
|-------------------------------|--------------------------------------|---------------------------------|-------------------|----------------------------|

Red Lobster 407

Crane/Barnes

Selection list: ---

Catalog: Crane Barnes 60Hz vers 8

Search Criteria:

Flow: 150 US gpm
Head: 25 ft
Tolerance: --- % of head

Pump: 4SE28*4L

Type: 1D4NONCLOG
Synch speed: 1800 rpm
Speed: 1750 rpm
Dia: 6 in
Curve no.:

Fluid: Water

Temperature: 60 °F
SG: 1
Viscosity: 1.105 cP
Vapor pressure: 0.2563 psi a
Atm pressure: 14.7 psi a

Specific Speeds

Ns: --- Nss: ---

Dimensions:

Suction: --- in Discharge: 4 in

NPSHa: --- ft

Pump Limits:

Temperature: --- °F
Pressure: --- psi g
Sphere size: 3 in
Power: --- bhp

Advanced Criteria:

Preferred Operating Area: ---
Secondary Operating Point: ---
Max temperature: --- °F
Max suction pressure: --- psi g
Max sphere size: --- in
Max power: --- bhp
Max suction specific speed: --- (Nss)
Min trim: --- % of max diameter
Min head rise: --- % to shutoff

Motor: Consult vendor

Curve Corrections: none

--- Data Point ---
 Flow: 150 US gpm
 Head: 24.2 ft
 Eff: 41%
 Power: 2.24 bhp
 NPSHr: --- ft

-- Design Curve --
 Shutoff Head: 34.5 ft
 Shutoff dP: 14.9 psi
 Min Flow: --- US gpm
 BEP: 43% eff
 @ 211 US gpm
 NOL Pwr: 2.9 bhp
 @ 342 US gpm

-- Max Curve --
 Max Pwr: 2.92 bhp
 @ 180 US gpm

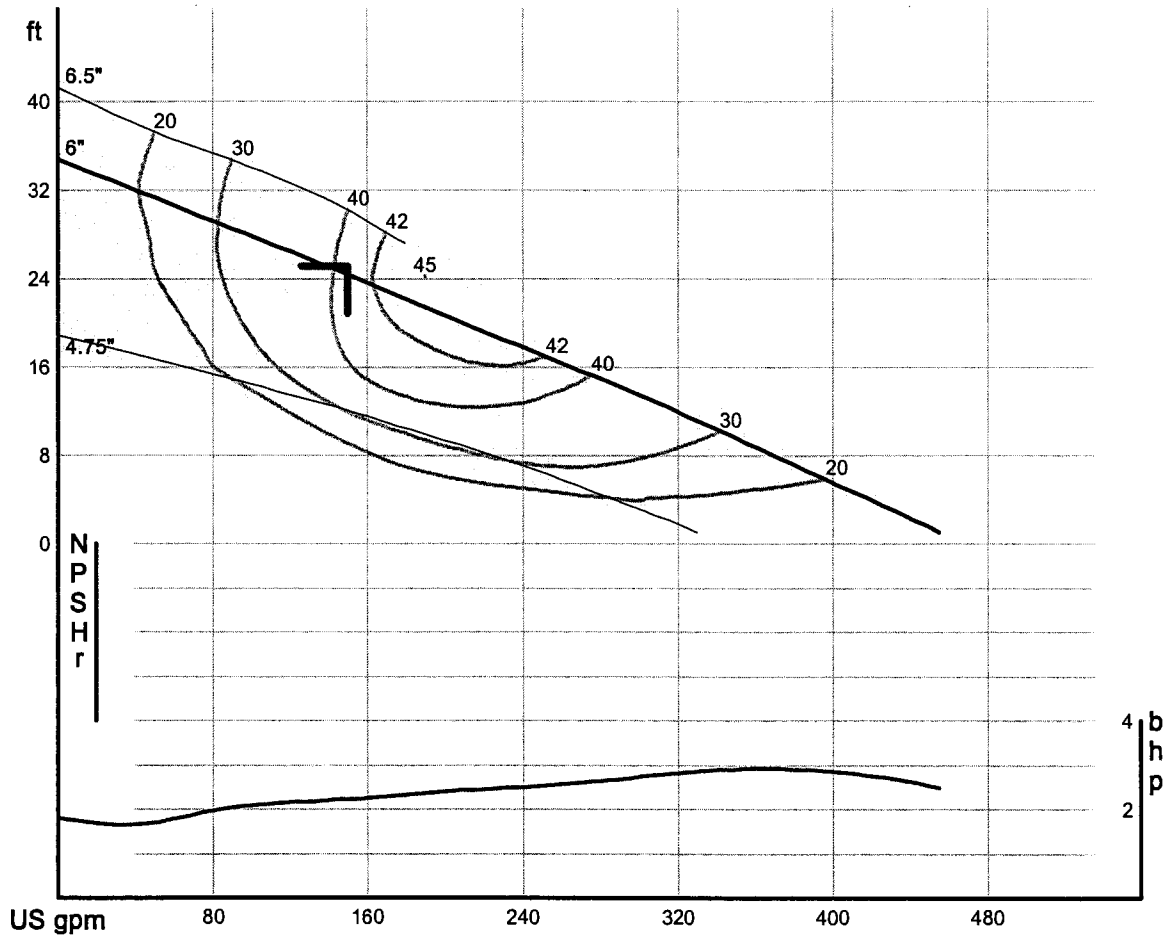

Pump note: Temp. 104°F (40°C) Continuous.

13-A RTU 408

| | | | | | | |
|--------------------|-----------------------------|--------------------------|------------------|------------------------------------|-----------------------------|-------------------|
| FLYGT | | PERFORMANCE CURVE | | | PRODUCT CP3231 /665 | TYPE |
| DATE 2009-05-06 | PROJECT | | | | CURVE NO 63-430 | ISSUE 8 |
| POWER FACTOR | 1/1-LOAD 0.83 | 3/4-LOAD 0.80 | 1/2-LOAD 0.70 | RATED POWER 160 hp | IMPELLER DIAMETER 355 mm | |
| EFFICIENCY | 94.0 % | 94.5 % | 95.0 % | STARTING CURRENT ... 950 A | MOTOR # 35-45-4AA | STATOR REV 01D |
| MOTOR DATA | --- | | | RATED CURRENT ... 190 A | REV 12 | |
| COMMENTS | INLET/OUTLET - / 8 inch | | | RATED SPEED 1780 rpm | FREQ. 60 Hz | PHASES 3 |
| | IMP. THROUGHLET 3.5 inch | | | TOT.MOM.OF INERTIA ... 1.5 kgm2 | VOLTAGE 460 V | POLES 4 |
| | | | | NO. OF BLADES 2 | GEARTYPE --- | RATIO --- |

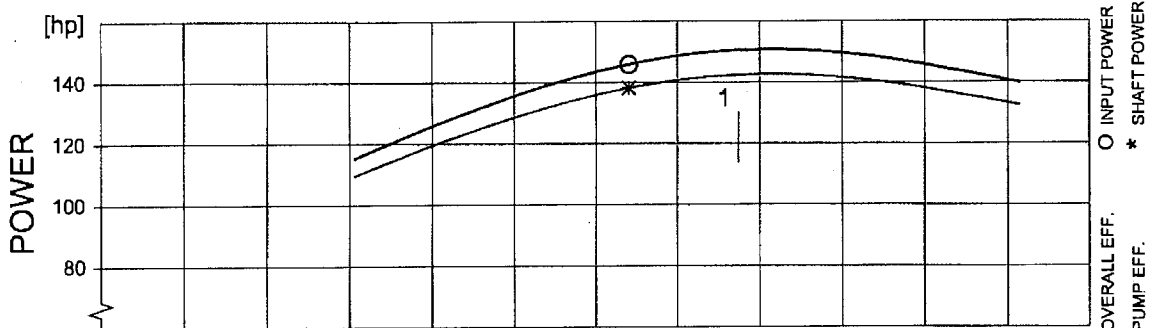

| DUTY-POINT | FLOW[USgpm] | HEAD[ft] | POWER [hp] | EFF. [%] | NPSHre[ft] |
|------------|-------------|----------|------------|-------------|------------|
| 1 | 3872 | 107 | 151 (143) | 69.5 (73.4) | 25.4 |
| B.E.P. | 3204 | 128 | 146 (139) | 70.9 (74.9) | 22.7 |

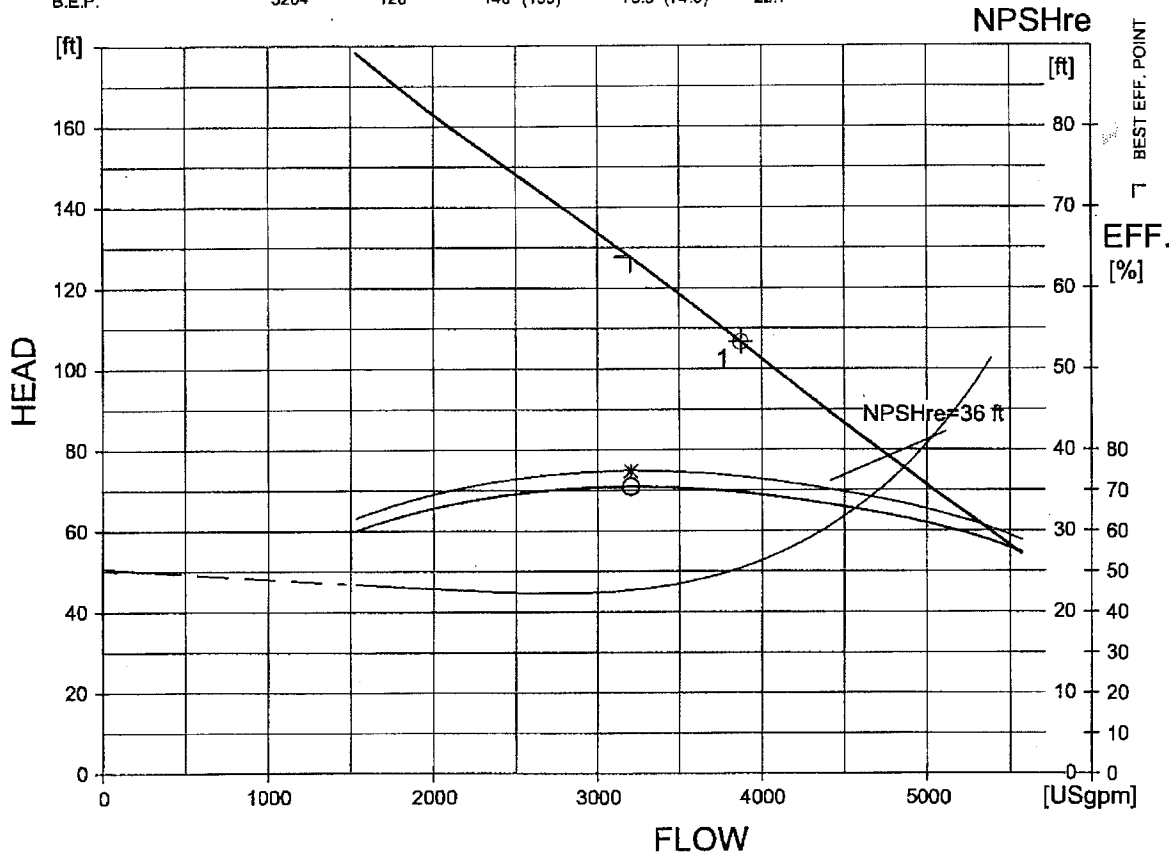

FLYPS3.1.6.3 (20060531)

NPSHre = NPSH3% + min. operational margin
Performance with clear water and ambient temp 40 °C

FLYGT **HI B Curve**

Pescara Lakes **409**

Crane/Barnes

Selection list: ---

Catalog: Crane Barnes 60Hz vers 8

Search Criteria:

Pump: 4SE28*4L

Type: 1D4NONCLOG

Synch speed: 1800 rpm

Speed: 1750 rpm

Dia: 6 in

Curve no.:

Specific Speeds

Ns: ---

Nss: ---

Dimensions:

Suction: --- in

Discharge: 4 in

Pump Limits:

Temperature: --- °F

Pressure: --- psi g

Sphere size: 3 in

Power: --- bhp

Motor: Consult vendor

Fluid: Water

Temperature: 60 °F

SG: 1

Viscosity: 1.105 cP

Vapor pressure: 0.2563 psi a

Atm pressure: 14.7 psi a

NPSHa: --- ft

Advanced Criteria:

Preferred Operating Area: ---

Secondary Operating Point: ---

Max temperature: --- °F

Max suction pressure: --- psi g

Max sphere size: --- in

Max power: --- bhp

Max suction specific speed: --- (Nss)

Min trim: --- % of max diameter

Min head rise: --- % to shutoff

Curve Corrections: none

--- Data Point ---

Flow: 200 US gpm
 Head: 20.5 ft
 Eff: 43%
 Power: 2.4 bhp
 NPSHr: --- ft

-- Design Curve --

Shutoff Head: 34.5 ft
 Shutoff dP: 14.9 psi
 Min Flow: --- US gpm
 BEP: 43% eff
 @ 211 US gpm
 NOL Pwr: 2.9 bhp
 @ 342 US gpm

-- Max Curve --

Max Pwr: 2.92 bhp
 @ 180 US gpm

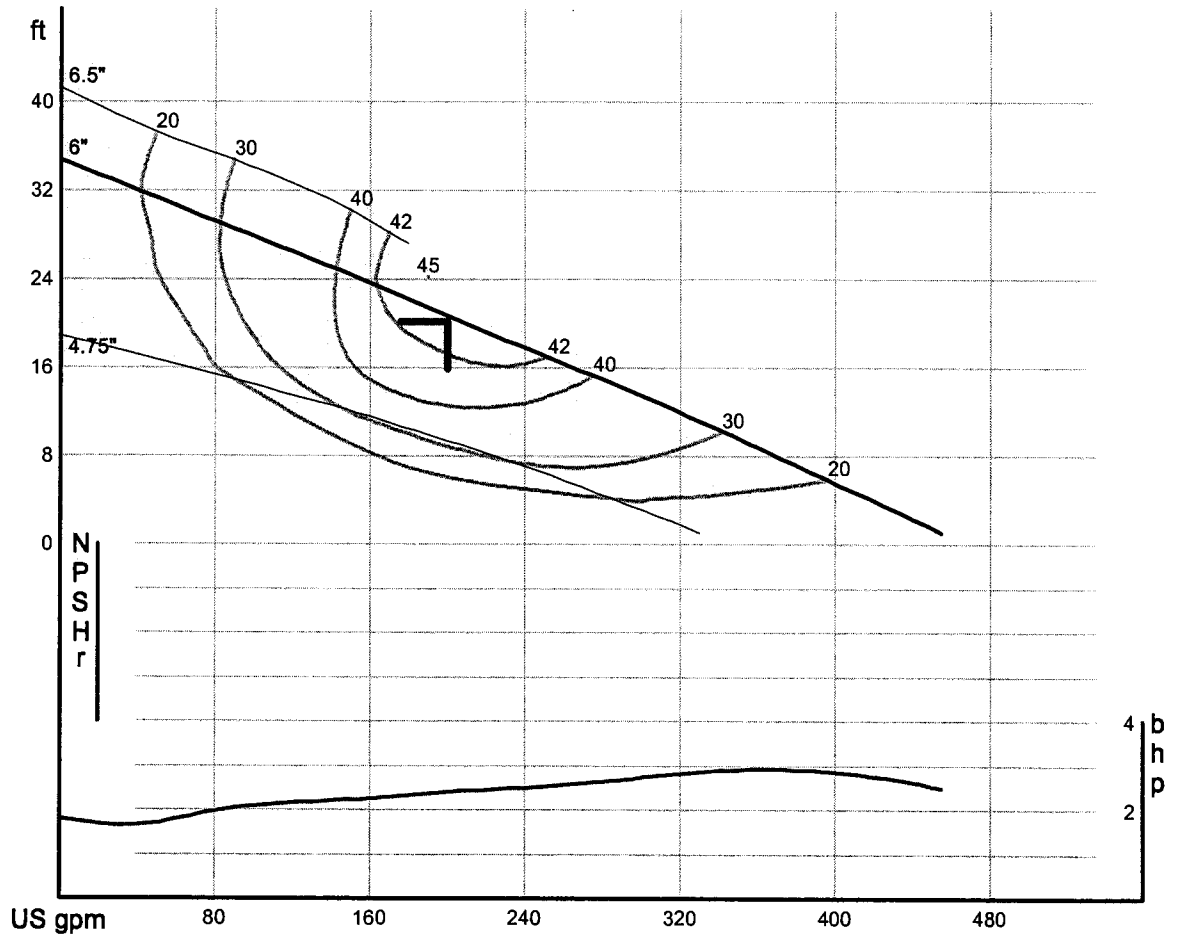

Pump note: Temp. 104°F (40°C) Continuous.

23-A (410)

S4P 1500 w/ 9.5" Imp.

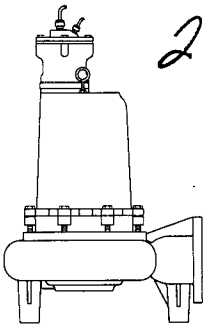

Performance Curve

S4P/S4PX

RPM: **1750** Discharge: **4"** Solids: **3"**

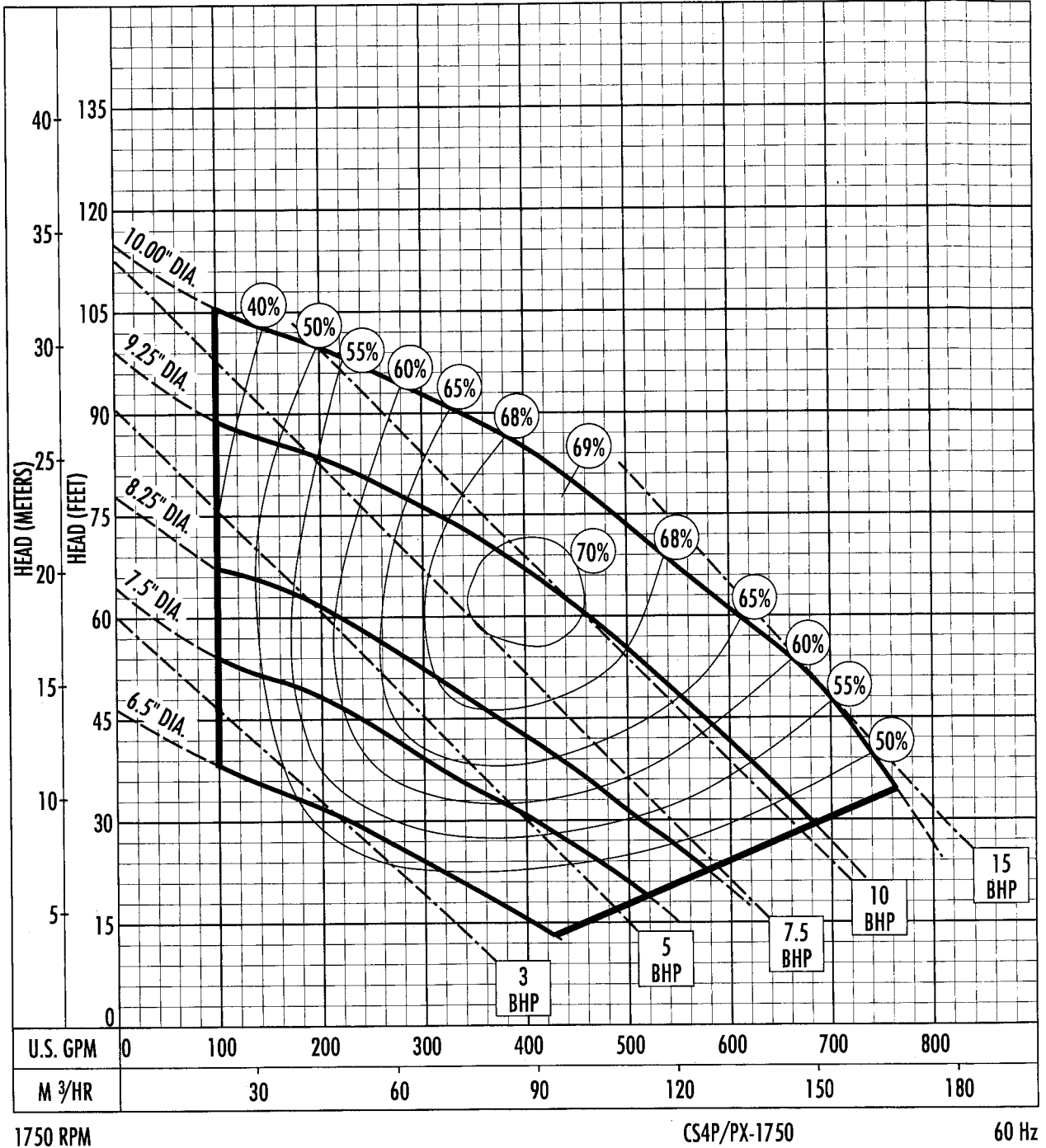

The curves reflect maximum performance characteristics without exceeding full load (Nameplate) horsepower. All pumps have a service factor of 1.2. Operation is recommended in the bounded area with operational point within the curve limit. Performance curves are based on actual tests with clear water at 70° F. and 1280 feet site elevation.

Conditions of Service:



GPM: _____ TDH: _____

HYDROMATIC™ PUMPS

23-AA (411) 6VH50 w/ 9" Imp.

Pump Performance

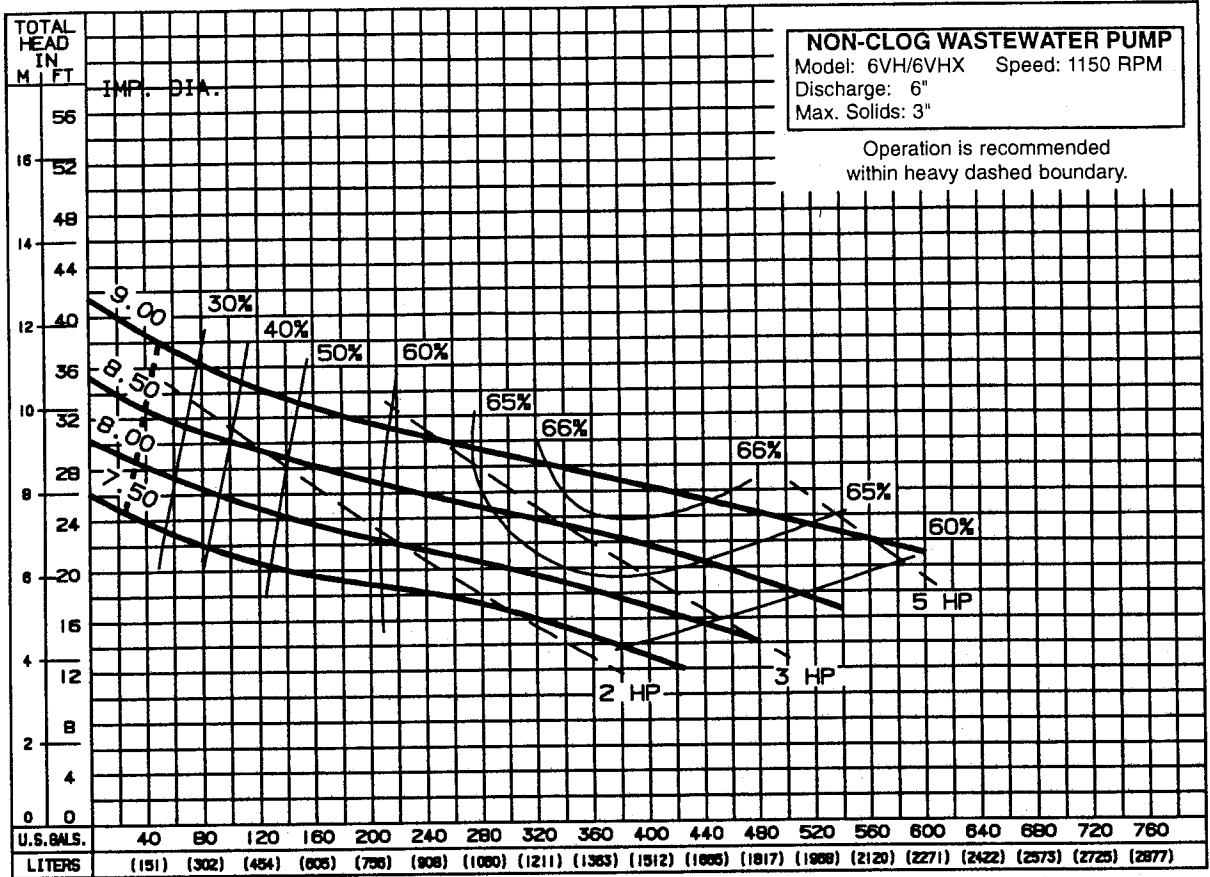

Pump performance is based on clear water (1.0 specific gravity @ 68°F) and pump fluid end (hydraulic) efficiency. Motor data based on 40°C ambient temperature.

| Available Models | | Motor Electrical Data | | | | | | | | | | | |
|------------------|-----------------|-----------------------|-------|-------|------------|----------|---------------------|--------|-------------------|-----------|---------|-----------------|----------------|
| Standard | Explosion Proof | HP | Volts | Phase | Start Amps | Run Amps | Service Factor Amps | Run KW | Service Factor KW | Start KVA | Run KVA | NEC Code Letter | Service Factor |
| 6VH30M6-03 | 6VHX30M6-03 | 3 | 200 | 3 | 77 | 15.9 | 19 | 3.3 | 4.3 | 26.7 | 5.5 | K | 1.2 |
| 6VH30M6-23 | 6VHX30M6-23 | 3 | 230 | 3 | 67 | 13.8 | 16.6 | 3.3 | 4.3 | 26.7 | 5.5 | K | 1.2 |
| 6VH30M6-43 | 6VHX30M6-43 | 3 | 460 | 3 | 33 | 7 | 8.3 | 3.3 | 4.3 | 26.7 | 5.5 | K | 1.2 |
| 6VH30M6-53 | 6VHX30M6-53 | 3 | 575 | 3 | 27 | 5.5 | 6.6 | 3.3 | 4.3 | 26.7 | 5.5 | K | 1.2 |
| 6VH50M6-03 | 6VHX50M6-03 | 5 | 200 | 3 | 115 | 24 | 29 | 5.4 | 6.9 | 39.8 | 8.3 | J | 1.2 |
| 6VH50M6-23 | 6VHX50M6-23 | 5 | 230 | 3 | 100 | 21 | 25.2 | 5.4 | 6.9 | 39.8 | 8.3 | J | 1.2 |
| 6VH50M6-43 | 6VHX50M6-43 | 5 | 460 | 3 | 50 | 10.5 | 12.6 | 5.4 | 6.9 | 39.8 | 8.3 | J | 1.2 |
| 6VH50M6-53 | 6VHX50M6-53 | 5 | 575 | 3 | 40 | 8.3 | 10 | 5.4 | 6.9 | 39.8 | 8.3 | J | 1.2 |

| Motor Efficiencies and Power Factor | | | | | | | | | |
|-------------------------------------|-------|---------------------|-----------|----------|----------|---------------------|-----------|----------|----------|
| | | Motor Efficiency % | | | | Power Factor % | | | |
| HP | Phase | Service Factor Load | 100% Load | 75% Load | 50% Load | Service Factor Load | 100% Load | 75% Load | 50% Load |
| 3 | 3 | 73 | 72 | 68 | 58.5 | 66 | 61 | 53.5 | 44 |
| 5 | 3 | 74 | 73 | 69.5 | 64 | 68.5 | 65 | 59 | 48.5 |

Series: PF4NC-SS



4" Discharge, Submersible Non-Clog Pumps
 3" Spherical Solids, Single Seal

RTU 412

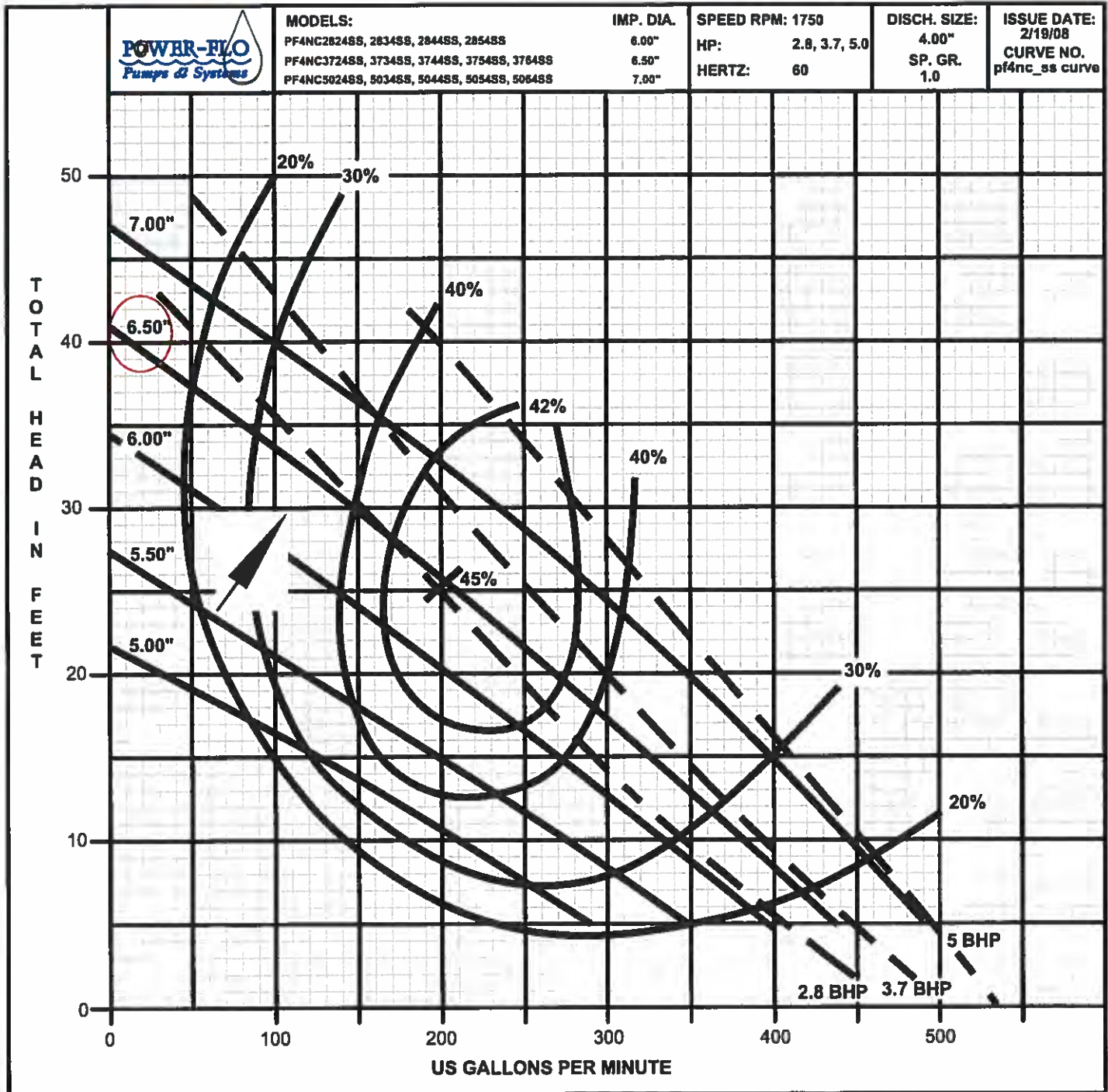

Lift Station 413

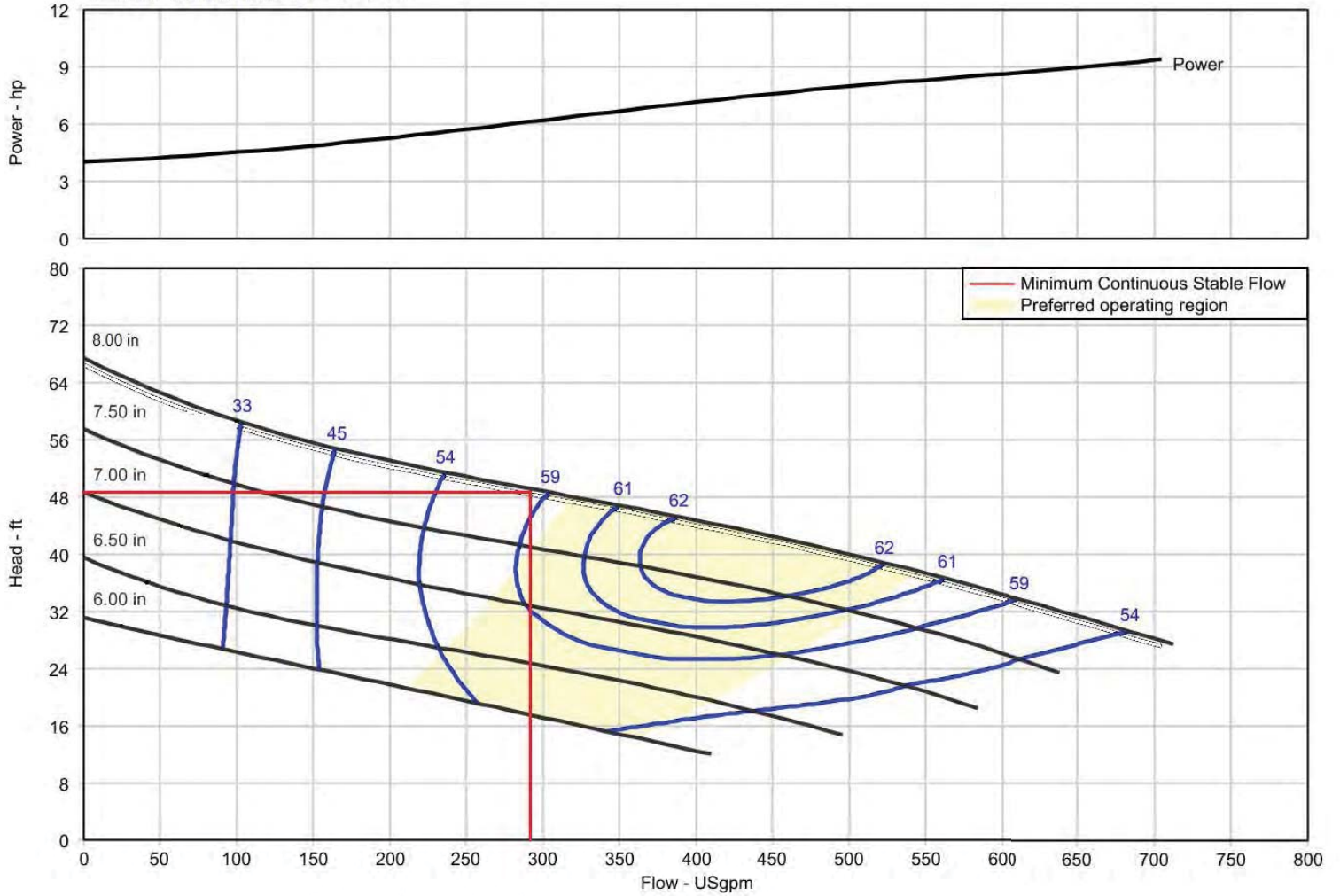

GPM: 286 TDH: 48.6

Series 4SE-L

Performance Curve

2.8, 3.7 & 5.0HP, 1750RPM, 60Hz

BARNES®

www.cranepumps.com

4" Horizontal Discharge - Submersible Non-Clog Pumps

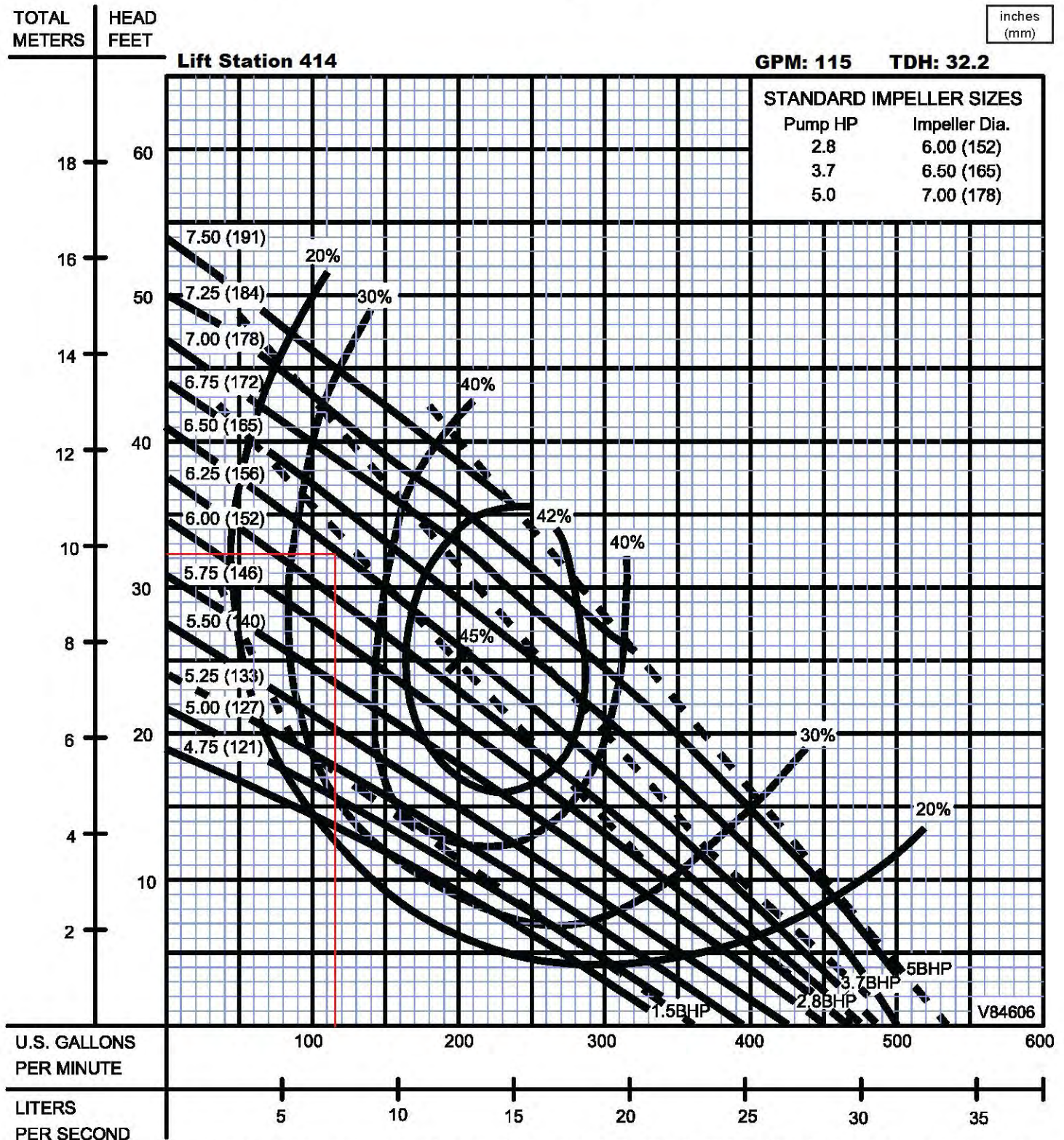

Testing is performed with water, specific gravity 1.0 @ 68° F @ (20°C), other fluids may vary performance

SECTION 1D
 PAGE 10
 DATE 1/05



PUMPS & SYSTEMS

A Crane Co. Company

USA: (937) 778-8947 • Canada: (905) 457-6223 • International: (937) 615-3598

Casa Loma 415

Crane/Barnes

Selection list: ---

Catalog: Crane Barnes 60Hz vers 8

Search Criteria:

Flow: 150 US gpm
Head: 29 ft
Tolerance: --- % of head

Pump: 4SE37*4L

Type: 1D4NONCLOG
Synch speed: 1800 rpm
Speed: 1750 rpm
Dia: 6.5 in
Curve no.:

Fluid: Water

Temperature: 60 °F
SG: 1
Viscosity: 1.105 cP
Vapor pressure: 0.2563 psi a
Atm pressure: 14.7 psi a

Specific Speeds

Ns: --- Nss: ---

Dimensions:

Suction: --- in Discharge: 4 in

NPSHa: --- ft

Pump Limits:

Temperature: --- °F
Pressure: --- psi g
Sphere size: 3 in
Power: --- bhp

Advanced Criteria:

Preferred Operating Area: ---
Secondary Operating Point: ---
Max temperature: --- °F
Max suction pressure: --- psi g
Max sphere size: --- in
Max power: --- bhp
Max suction specific speed: --- (Nss)
Min trim: --- % of max diameter
Min head rise: --- % to shutoff

Motor: Consult vendor

Curve Corrections: none

--- Data Point ---

Flow: 150 US gpm
Head: 29.8 ft
Eff: 40%
Power: 2.79 bhp
NPSHr: --- ft

-- Design Curve --

Shutoff Head: 40.9 ft
Shutoff dP: 17.7 psi
Min Flow: --- US gpm
BEP: 45% eff
@ 205 US gpm
NOL Pwr: 3.6 bhp
@ 364 US gpm

-- Max Curve --

Max Pwr: 5.16 bhp
@ 100 US gpm

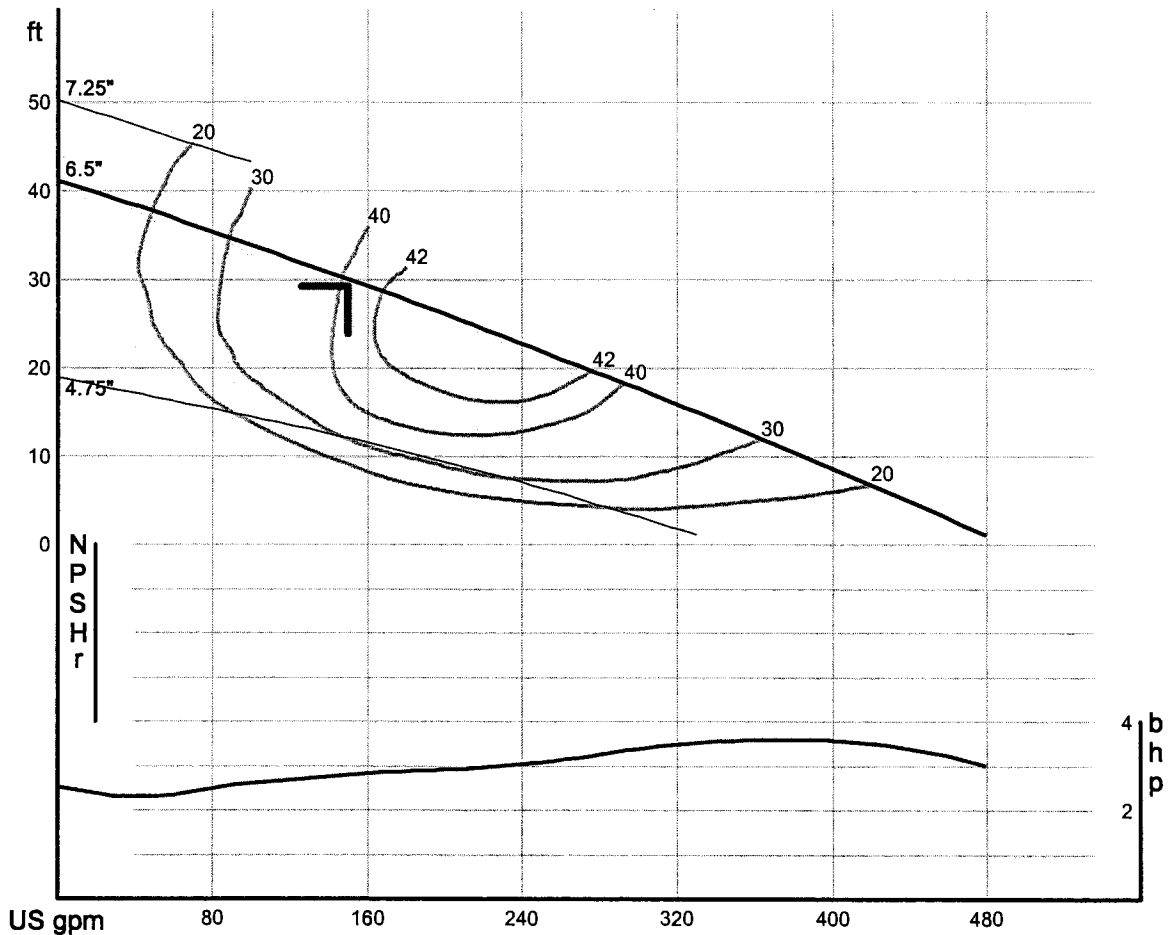

Pump note: Temp. 104°F (40°C) Continuous.



Performance Curve

AMX434-155/3.5D

Heather Hills (416)

Impeller

| | | | | | |
|---|-----------------------------|----|--------------------------|---------------------------|--------------------------|
| Impeller type: Single vane impeller | Solid size 3 1/8" | Ø: | Max. Ø: 8 1/8" | Min. Ø: 5 9/16" | Sel. Ø: 6 1/8" |
|---|-----------------------------|----|--------------------------|---------------------------|--------------------------|

Operating data

| | | | | |
|---------------------------|----------------------------|--|---------------|-----------------------------------|
| Speed: 1700 rpm | Frequency: 60 Hz | Duty point: Q = 200 US g.p.m. H = 21 ft | Suction port: | Discharge port: 4" ANSI |
|---------------------------|----------------------------|--|---------------|-----------------------------------|

Power data referred to: Water, pure [100%] ; 68°F; 62.322lb/ft³; 1.0818E-5ft²/s Testnorm: **ISO 9906**

Curve number:

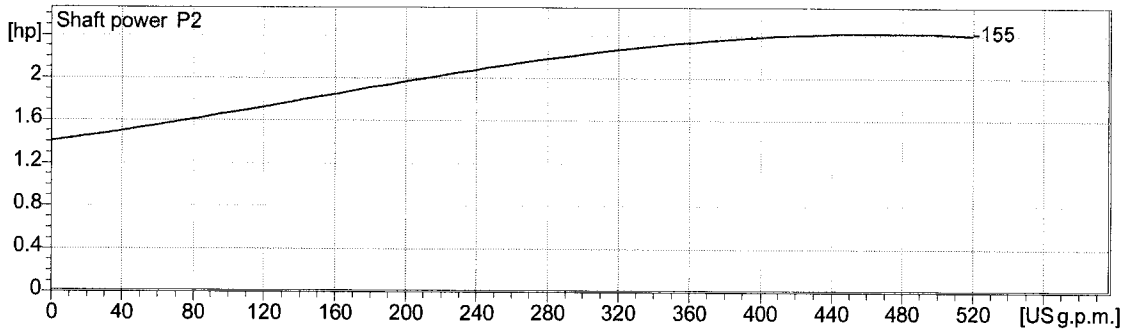
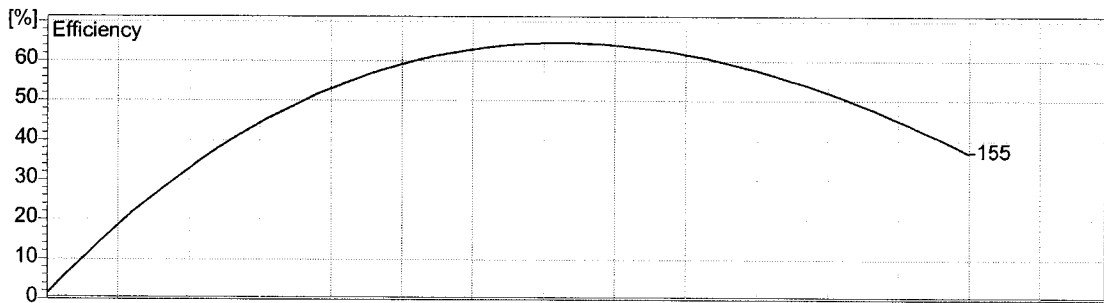
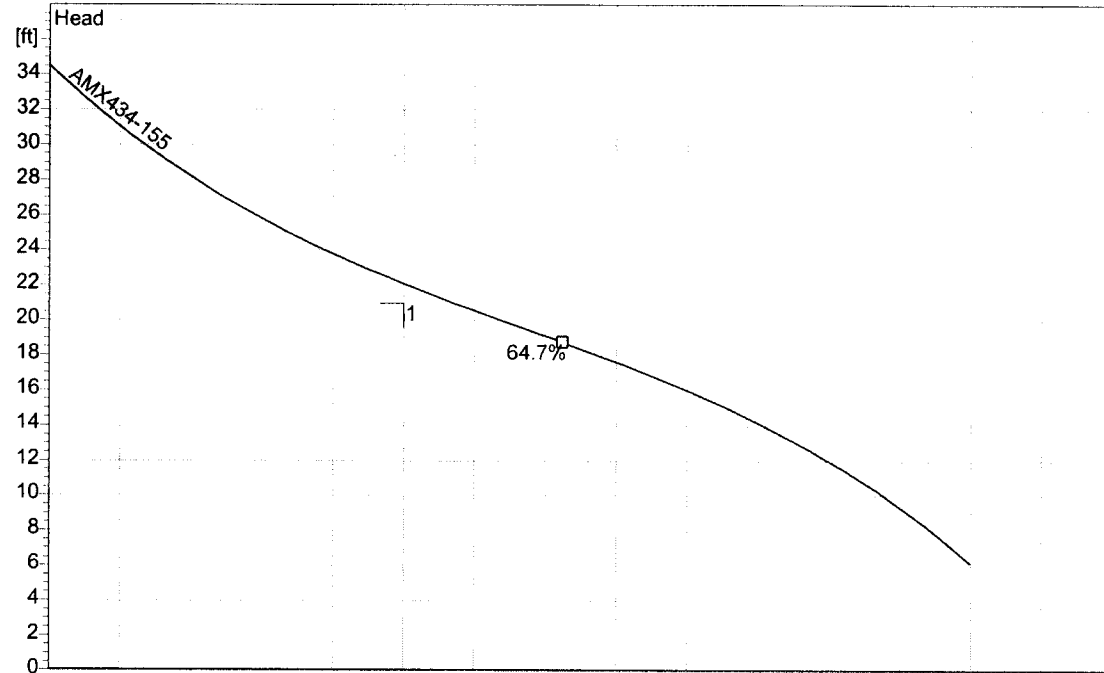

Project
Manatee Cty

Project no.:
Item Number 14

Created by:
nackerman

Page:
2

Date:
2005-09-14

Series 4SE-L

Performance Curve
2.8, 3.7 & 5.0HP, 1750RPM, 60Hz

BARNES®

www.cranepumps.com

4" Horizontal Discharge - Submersible Non-Clog Pumps

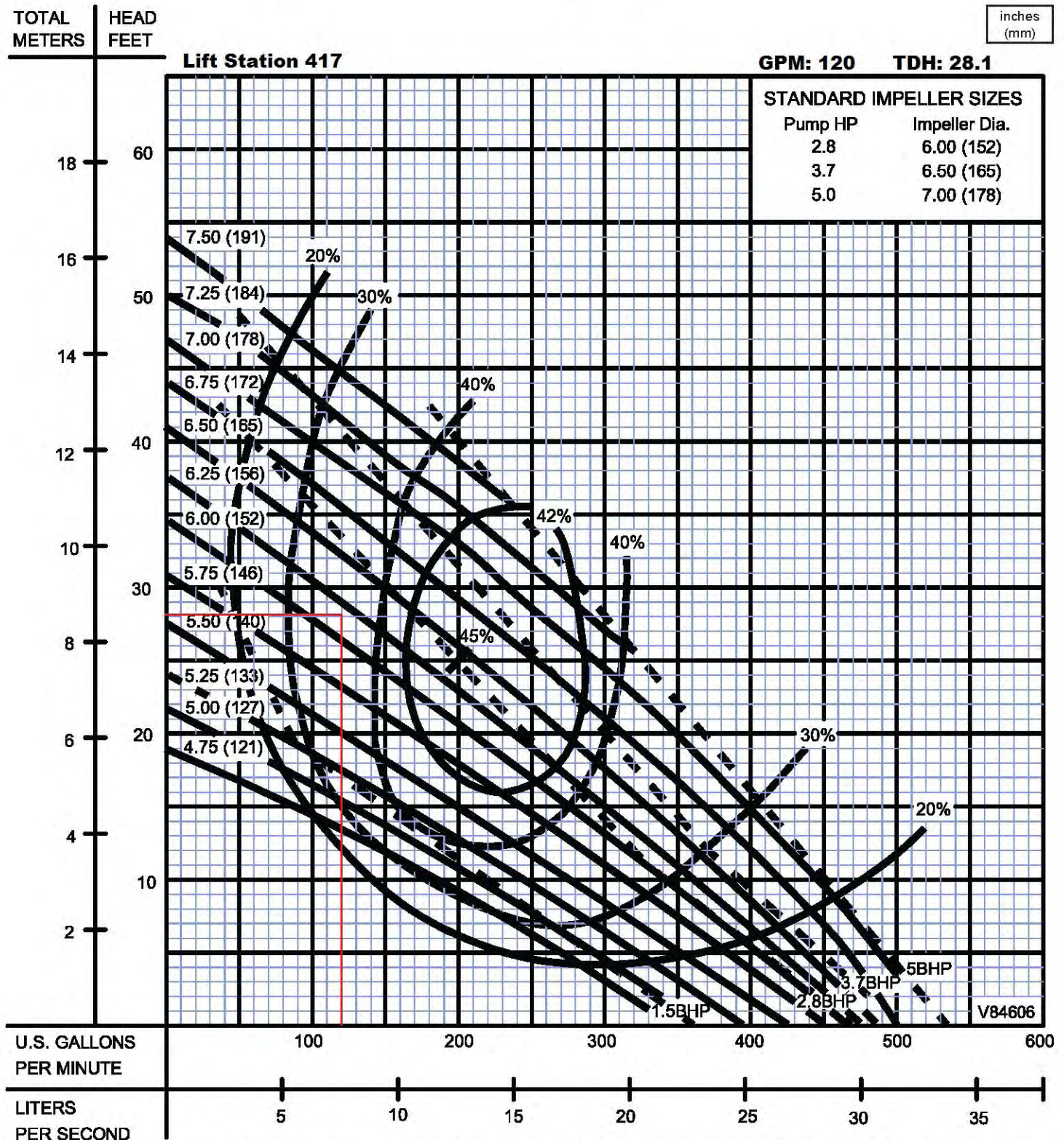

Testing is performed with water, specific gravity 1.0 @ 68° F @ (20°C), other fluids may vary performance

SECTION 1D
PAGE 10
DATE 1/05

CRANE®

PUMPS & SYSTEMS

A Crane Co. Company

USA: (937) 778-8947 • Canada: (905) 457-6223 • International: (937) 615-3598



26-A

418

SUBMERSIBLE SEWAGE PUMP

Pump Type FA100-420
Motor Type FK20.1- 4/17
Rated Motor H.P. 12.8
Rated R.P.M. 1740
Max. Sphere 4.0 inch

APPROVED SUBJECT TO RECEIPT
OF CERTIFIED PUMP CURVES
PRIOR TO SHIPPING

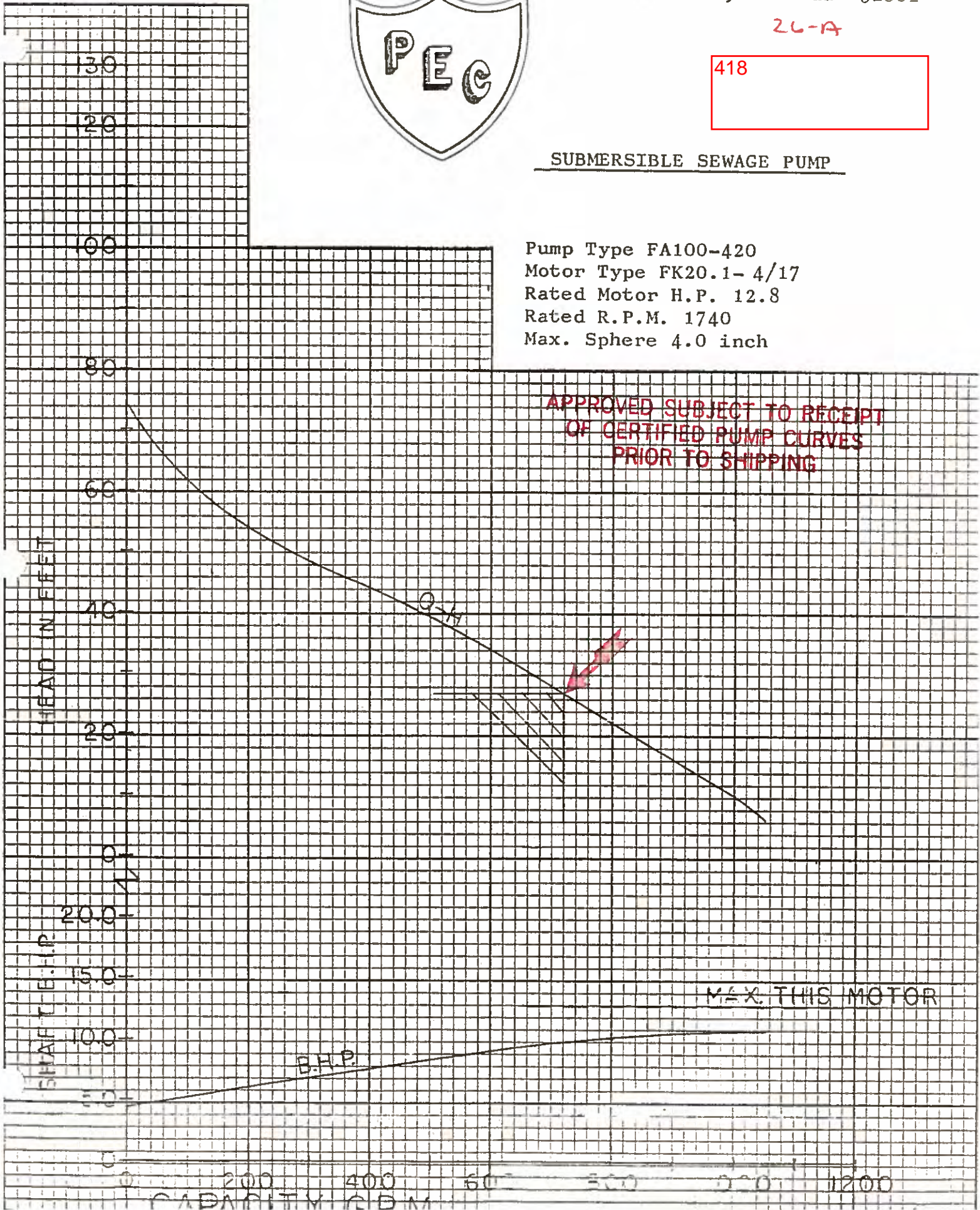

4" Horizontal Discharge - Submersible Non-Clog Pumps

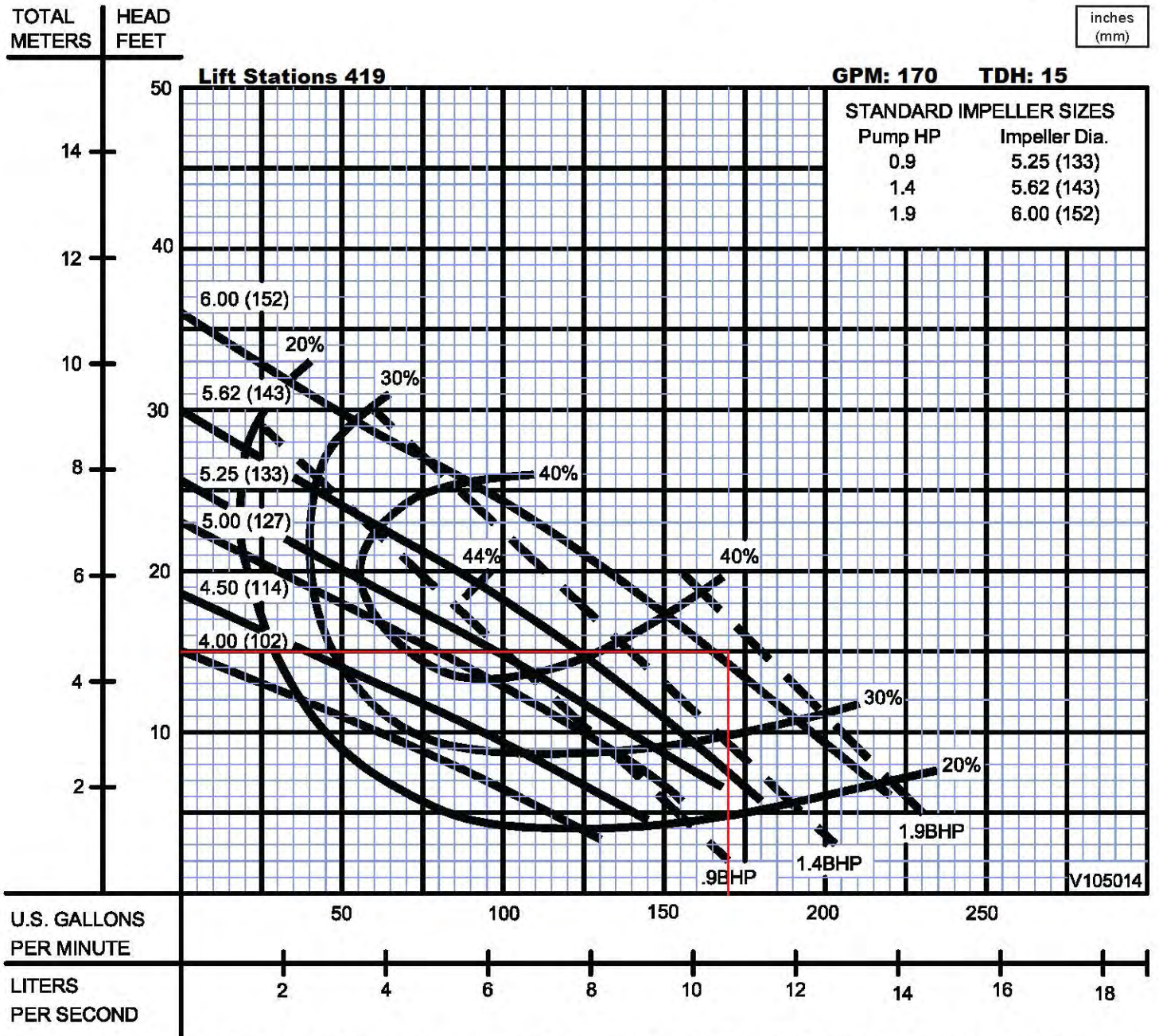

Testing is performed with water, specific gravity 1.0 @ 68° F @ (20°C), other fluids may vary performance

Lift Station 420A

MYERS 4V15M6-43A

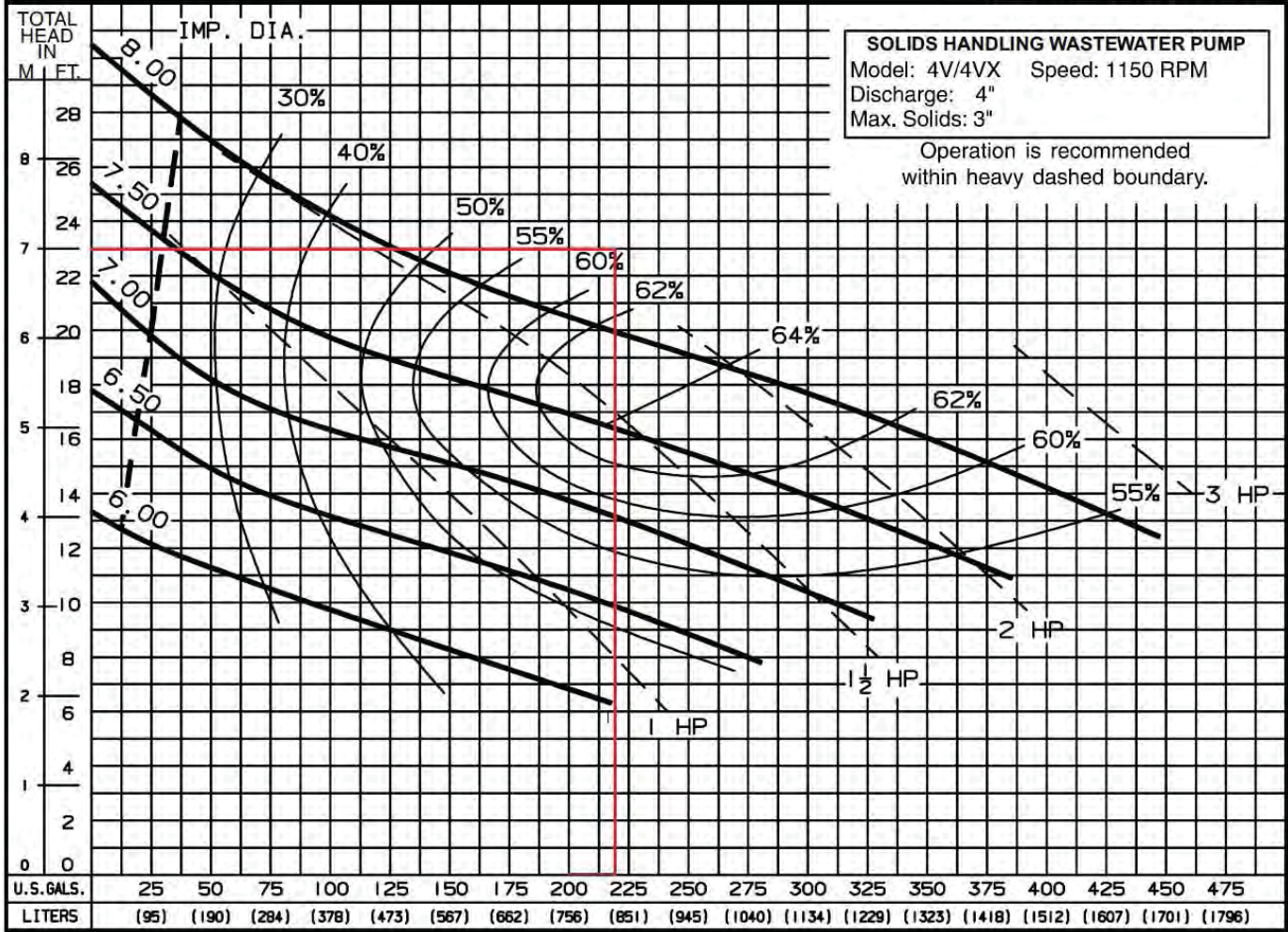

RPM: 1150

GPM: 220

TDH: 23

IMP: 6.375

Lift Station 420B

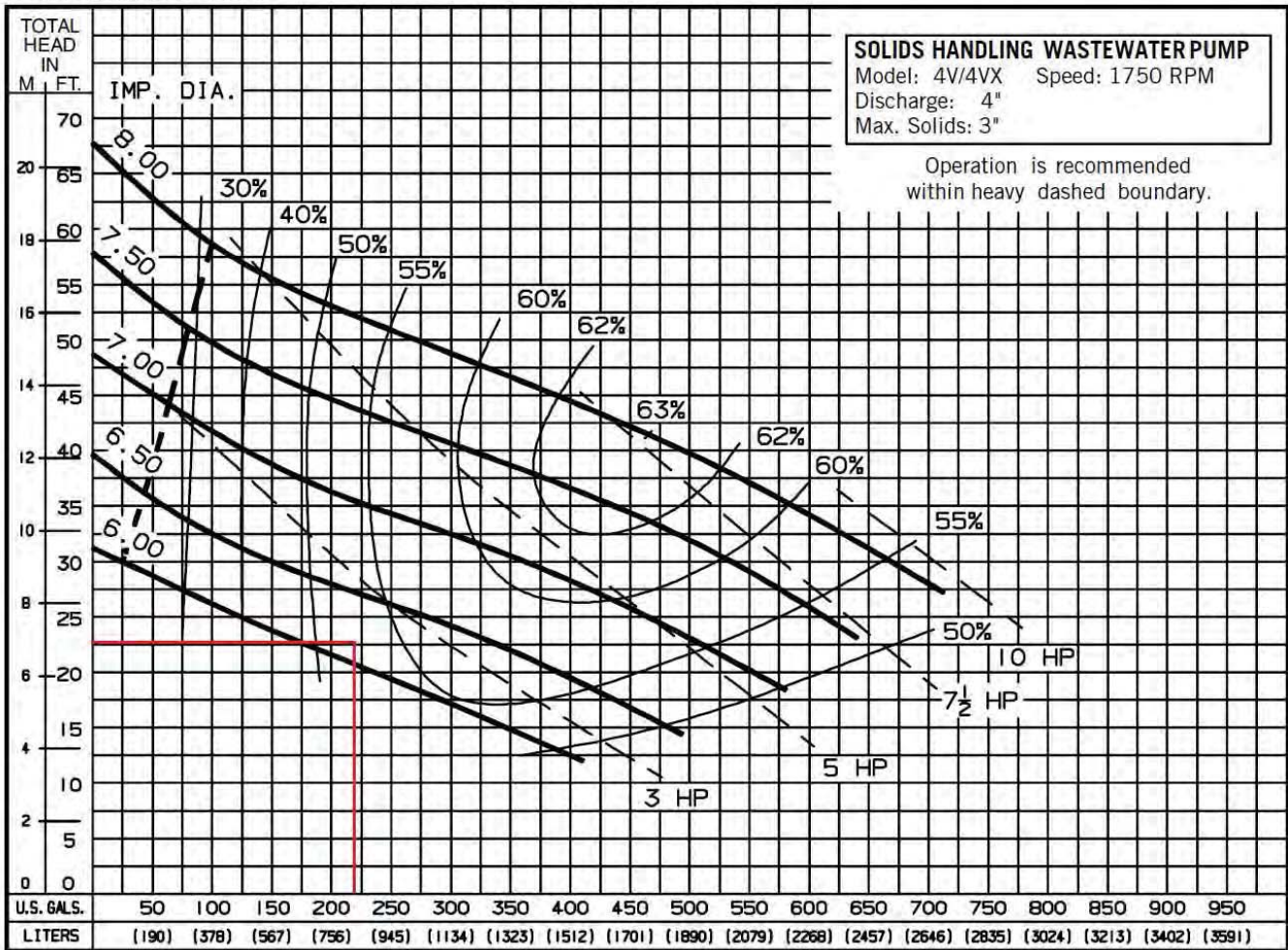

RPM: 1750

GMP: 220

TDH: 23

IMP: 6.375

Lift Station 421

SECT. 200 TAB 4" 1750 RPM 3Ø PG. 101



DATE April 1, 1983

MODEL RATED HP

STANDARD & EXPLOSION PROOF

| | | | | | | | | |
|----|----|----|--|--|--|--|--|-------|
| AF | 15 | 22 | | | | | | -4-4" |
| | 2 | 3 | | | | | | |

SOLID SIZE 3 1/2 BLADE 1 SPEED 1750 RPM
 DISCHARGE SIZE 4 VOLTAGE 230, 460, 575 ; 60 Hz 3 PH

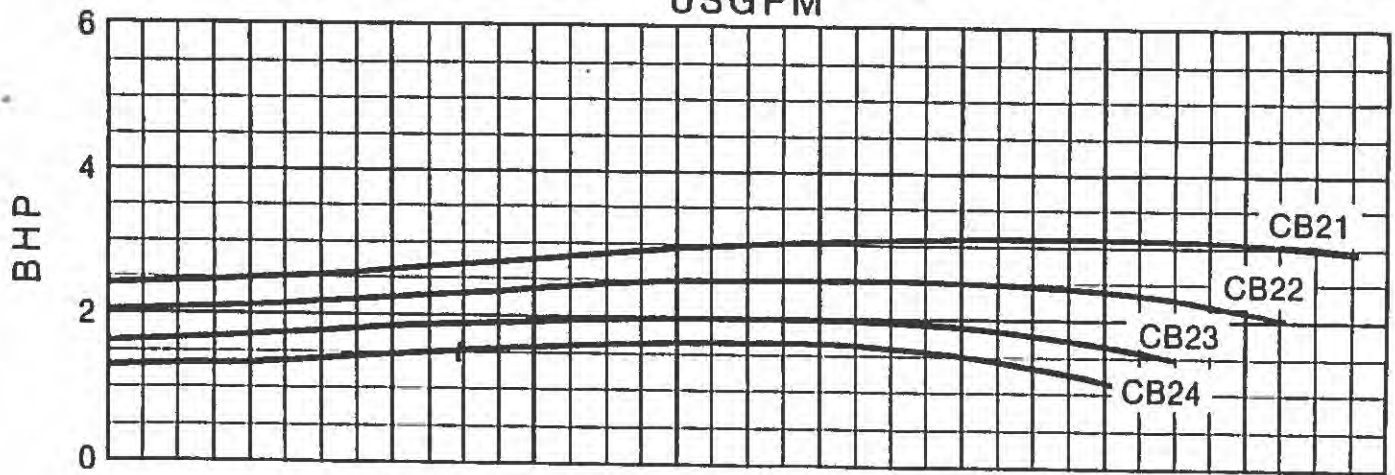
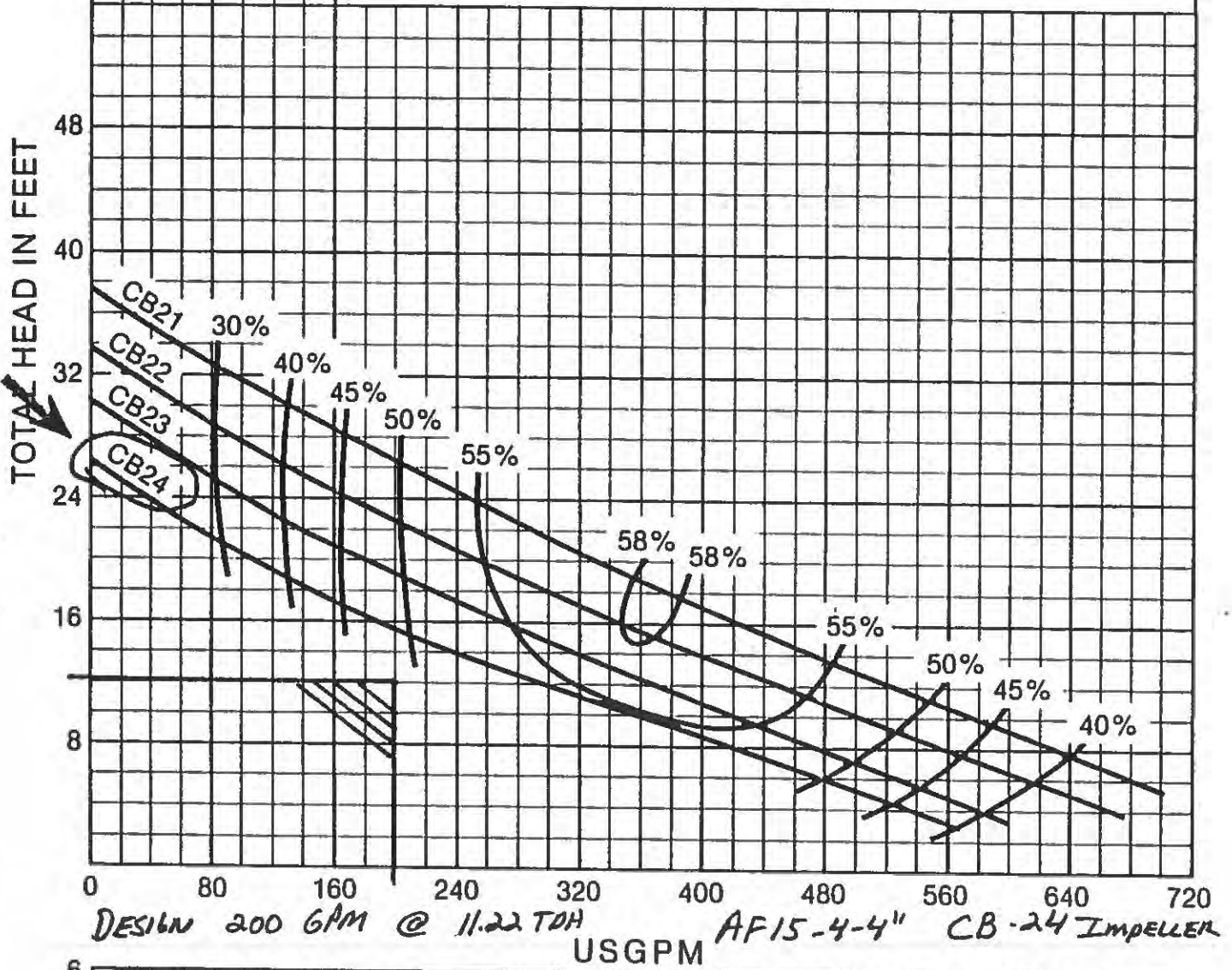

Cortez Plaza 4

422

Crane/Barnes

Selection list: ---

Catalog: Crane Barnes 60Hz vers 8

Selection Criteria:

Pump: 4SE28*4L

Flow: 100 US gpm
Head: 27 ft
Tolerance: --- % of head

Type: 1D4NONCLOG
Synch speed: 1800 rpm
Speed: 1750 rpm
Dia: 6 in
Curve no.:

Fluid: Water

Temperature: 60 °F
SG: 1
Viscosity: 1.105 cP
Vapor pressure: 0.2563 psi a
Atm pressure: 14.7 psi a

Specific Speeds

Ns: --- Nss: ---

Dimensions:

Suction: --- in Discharge: 4 in

NPSHa: --- ft

Pump Limits:

Temperature: --- °F
Pressure: --- psi g
Sphere size: 3 in
Power: --- bhp

Advanced Criteria:

Preferred Operating Area: ---
Secondary Operating Point: ---
Max temperature: --- °F
Max suction pressure: --- psi g
Max sphere size: --- in
Max power: --- bhp
Max suction specific speed: --- (Nss)
Min trim: --- % of max diameter
Min head rise: --- % to shutoff

Motor: Consult vendor

Curve Corrections: none

--- Data Point ---
Flow: 100 US gpm
Head: 27.6 ft
Eff: 33%
Power: 2.07 bhp
NPSHr: --- ft

-- Design Curve --
Shutoff Head: 34.5 ft
Shutoff dP: 14.9 psi
Min Flow: --- US gpm
BEP: 43% eff
@ 211 US gpm
NOL Pwr: 2.9 bhp
@ 342 US gpm

-- Max Curve --
Max Pwr: 2.92 bhp
@ 180 US gpm

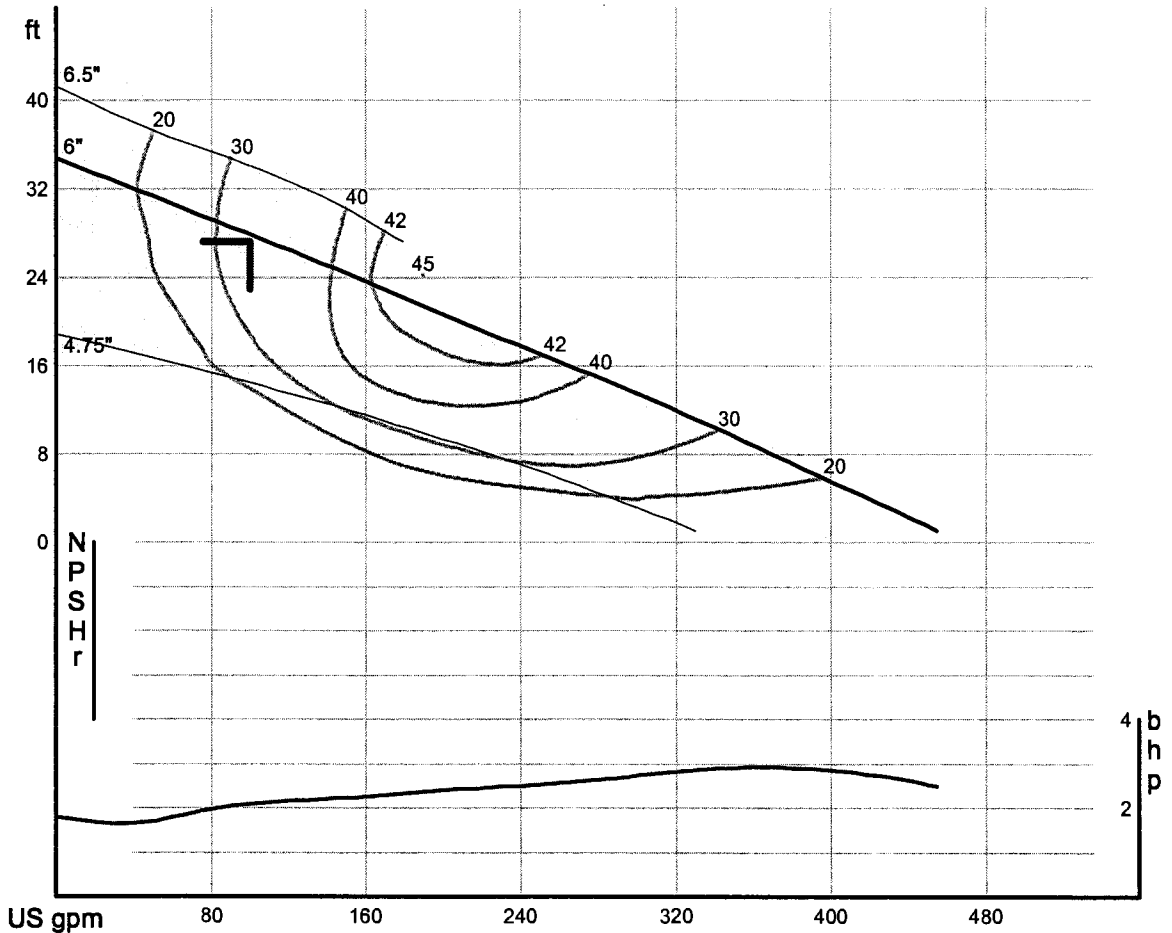

Pump note: Temp. 104°F (40°C) Continuous.

Performance Curve – S4N/S4NX

RPM: **1750** DISCHARGE: **4"** SOLIDS: **3"**

Lift Station 423

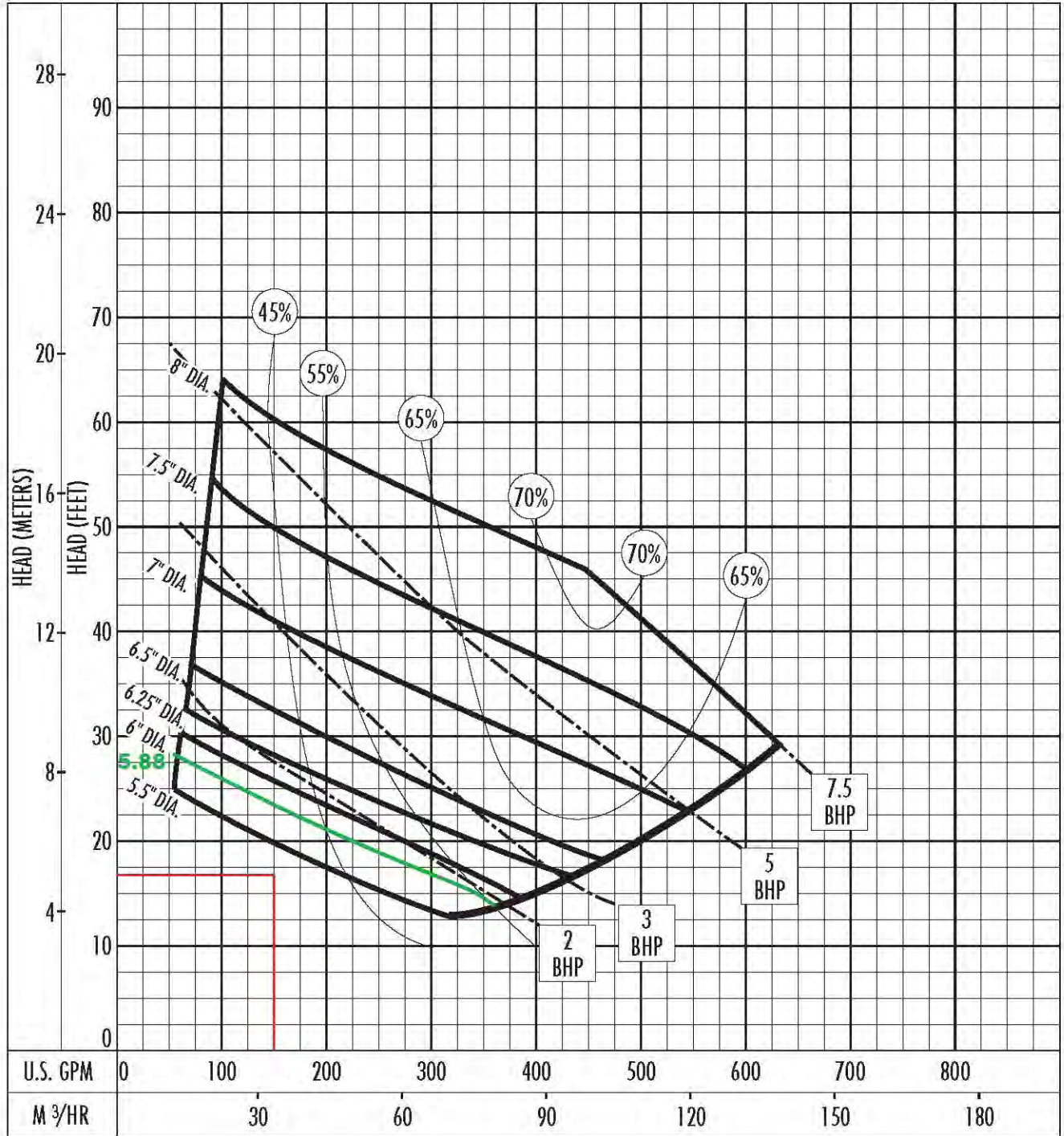

The curves reflect maximum performance characteristics without exceeding full load (Nameplate) horsepower. All pumps have a service factor of 1.2. Operation is recommended in the bounded area with operational point within the curve limit. Performance curves are based on actual tests with clear water at 70° F. and 1280 feet site elevation.

Conditions of Service:

Company: Manatee County Utilities

Name: 25A - RTU 424

Date: 4/9/2012



Pump:

Size: S4M/S4MX
 Type: NCLOG-4
 Synch speed: 1800 rpm
 Curve: S4M1750
 Specific Speeds:
 Dimensions:
 Speed: 1750 rpm
 Dia: 8.5 in
 Impeller:
 Ns: ---
 Nss: ---
 Suction: --- in
 Discharge: 4 in

Search Criteria:

Flow: --- US gpm Head: --- ft

Fluid:

Water
 Density: 62.37 lb/ft³
 Viscosity: 1.105 cP
 NPSHa: --- ft
 Temperature: 60 °F
 Vapor pressure: 0.2563 psi a
 Atm pressure: 14.7 psi a

Motor:

Consult HYDROMATIC to select a motor for this pump.

Pump Limits:

Temperature: 140 °F
 Pressure: 125 psi g
 Sphere size: 3 in
 Power: --- hp
 Eye area: --- in²

---- Data Point ----

Flow: 0 US gpm
 Head: 82.6 ft
 Eff: --- %
 Power: --- hp
 NPSHr: --- ft

---- Design Curve ----

Shutoff head: 82.6 ft
 Shutoff dP: 35.8 psi
 Min flow: 96.2 US gpm
 BEP: 67% @ 601 US gpm
 NOL power:
 12.6 hp @ 845 US gpm

-- Max Curve --

Max power:
 15.7 hp @ 925 US gpm

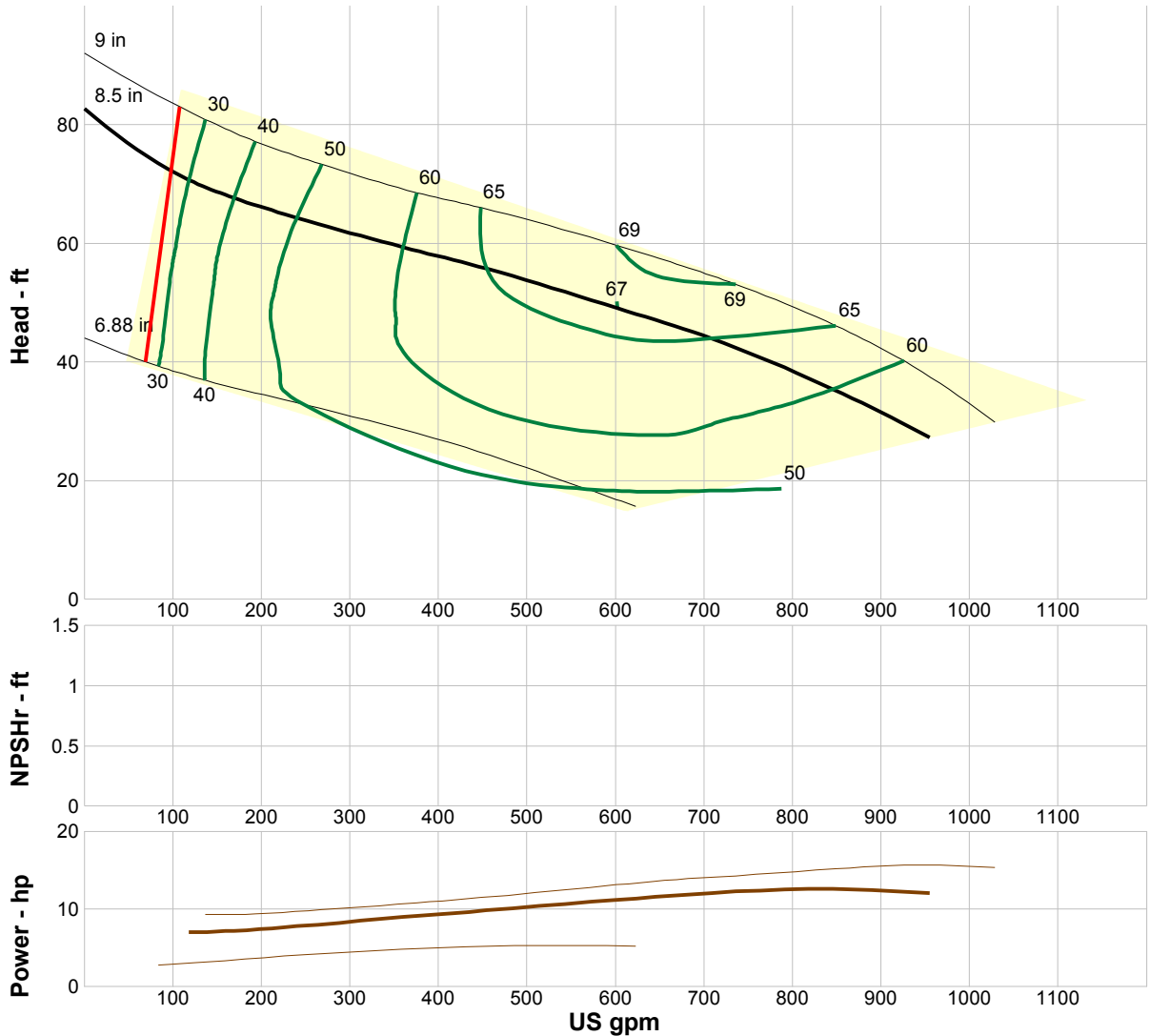

Performance Evaluation:

| Flow US gpm | Speed rpm | Head ft | Efficiency % | Power hp | NPSHr ft |
|----------------|--------------|------------|-----------------|-------------|-------------|
| 917 | 1750 | 30.1 | 56 | 12.3 | --- |
| 764 | 1750 | 40.5 | 63 | 12.3 | --- |
| 611 | 1750 | 48.6 | 66 | 11.3 | --- |
| 458 | 1750 | 55.5 | 65 | 9.88 | --- |
| 306 | 1750 | 61.6 | 56 | 8.46 | --- |

Company: Barney's Pumps, Inc.

EL RANCHO VILLAGE



Name:

Date: 10/8/2011

| Pump: | | Search Criteria: | |
|-----------------------|-----------------|---|------------------------------|
| Size: S4N/S4NX | | Flow: 250 US gpm | Head: 46 ft |
| Type: NCLOG-4 | Speed: 1750 rpm | Fluid: | |
| Synch speed: 1800 rpm | Dia: 7.5625 in | Water | Temperature: 60 °F |
| Curve: PAGE 109 | Impeller: | Density: 62.37 lb/ft ³ | Vapor pressure: 0.2563 psi a |
| Specific Speeds: | Ns: --- | Viscosity: 1.105 cP | Atm pressure: 14.7 psi a |
| | Nss: --- | NPSHa: --- | |
| Dimensions: | Suction: --- | Motor: | |
| | Discharge: 4 in | Consult HYDROMATIC to select a motor for this pump. | |

| Pump Limits: | |
|---------------------|---------------|
| Temperature: 140 °F | Power: --- |
| Pressure: 125 psi g | Eye area: --- |
| Sphere size: 3 in | |

| --- Data Point --- | |
|----------------------|----------------------|
| Flow: | 250 US gpm |
| Head: | 46 ft |
| Eff: | 59% |
| Power: | 4.81 hp |
| NPSHr: | --- |
| --- Design Curve --- | |
| Shutoff head: | 61.7 ft |
| Shutoff dP: | 26.7 psi |
| Min flow: | 45 US gpm |
| BEP: | 68% @ 437 US gpm |
| NOL power: | 6.9 hp @ 610 US gpm |
| -- Max Curve -- | |
| Max power: | 9.61 hp @ 677 US gpm |

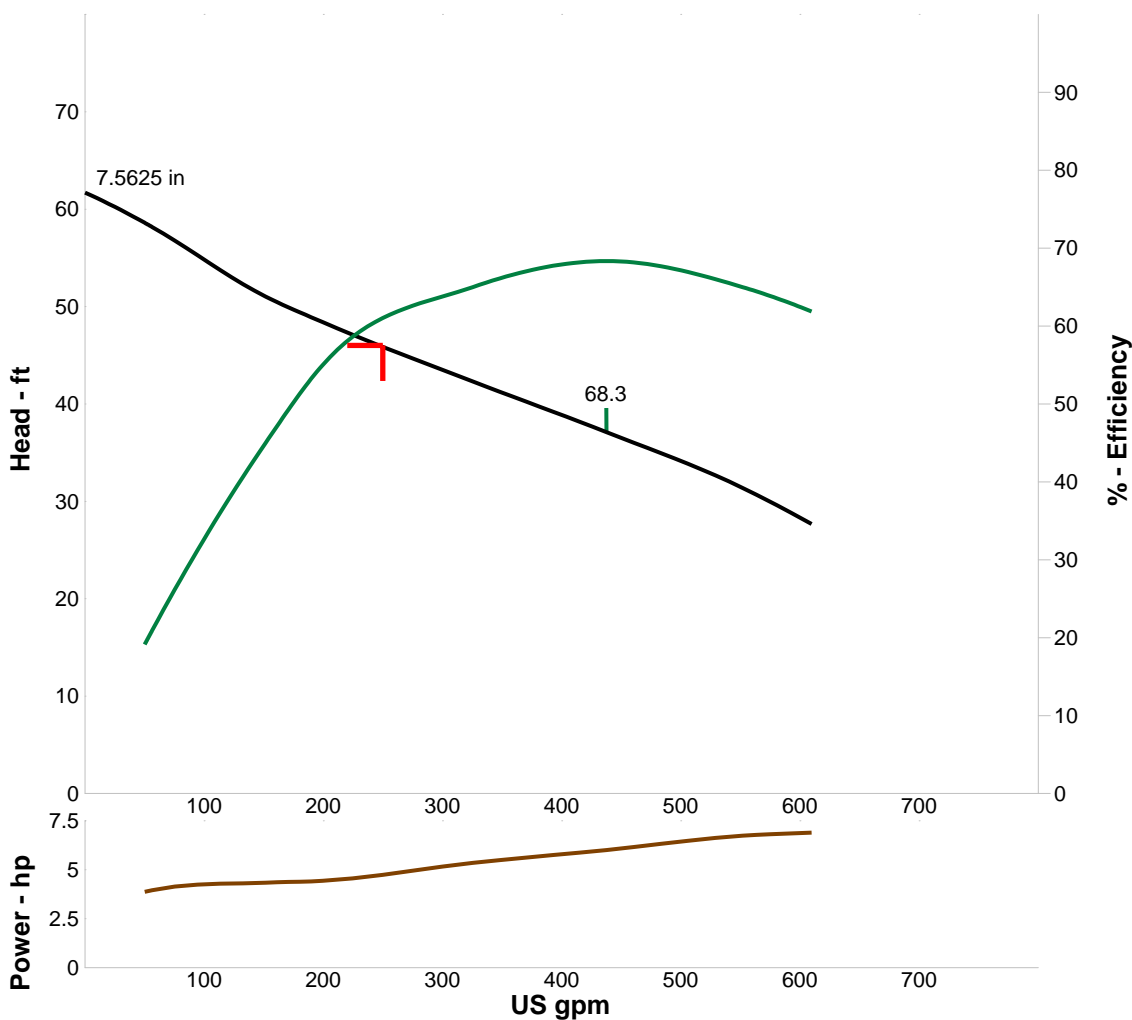

Performance Evaluation:

| Flow US gpm | Speed rpm | Head ft | Efficiency % | Power hp | NPSHr ft |
|----------------|--------------|------------|-----------------|-------------|-------------|
| 300 | 1750 | 43.5 | 63 | 5.17 | --- |
| 250 | 1750 | 46 | 59 | 4.81 | --- |
| 200 | 1750 | 48.4 | 55 | 4.44 | --- |
| 150 | 1750 | 51.1 | 45 | 4.34 | --- |
| 100 | 1750 | 54.9 | 32 | 4.14 | --- |



Performance Curve
AMX434-228/10,4T/C

| Impeller | | | | | |
|---|----------------------|---|---------------------------------|-------------------------------|----------------------------|
| Impeller type: Single channel impeller | Solid size 3 inch | Ø: | Max. Ø: 9 ^{13/16} " | Min. Ø: 8 ^{1/8} " | Sel. Ø: 9" |
| Operating data | | | | | |
| Speed: 1750 rpm | Frequency: 60 Hz | Duty point: Q = 525 US g.p.m. H = 43 ft | | Suction port: | Discharge port: 4" ANSI |
| Power data referred to: Water, pure [100%]; 68°F; 62.322lb/ft ³ ; 1.0818E-5ft ² /s | | | Testnorm: ISO 9906 | | |

Curve number:

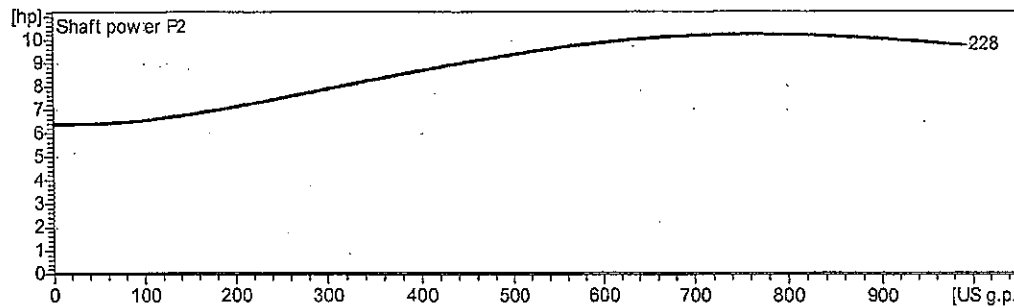
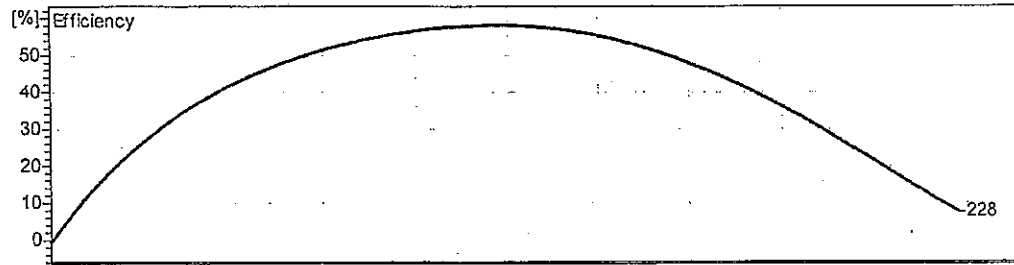
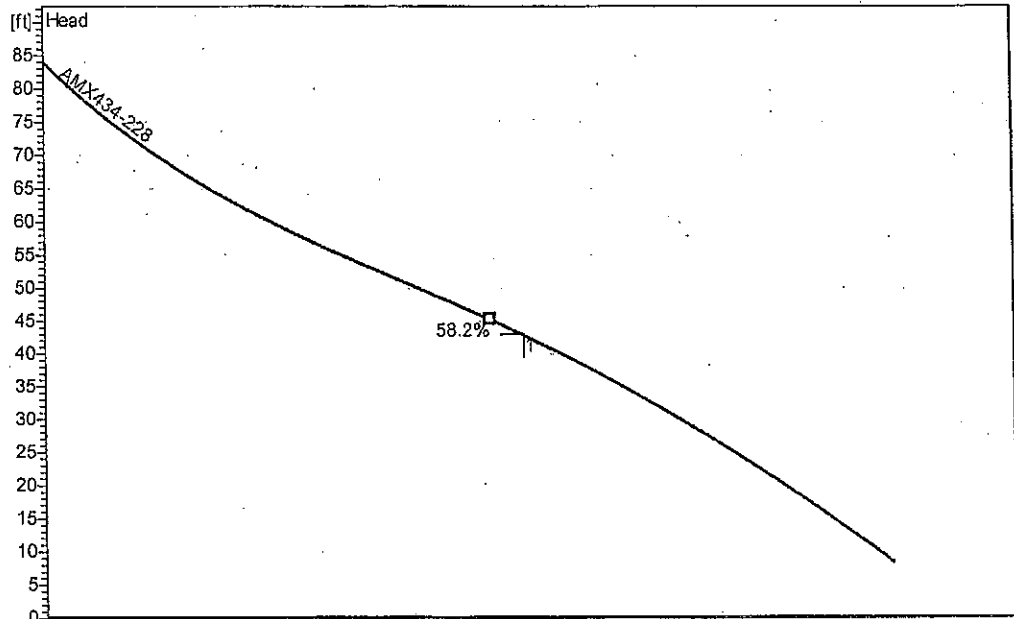

| | | | | |
|---------------------------|-------------------------|---------------------------|------------|-------------------|
| Project Manatee County | Project no.: LS 24-A | Created by: nyackerman | Page: 2 | Date: 1/3/2011 |
|---------------------------|-------------------------|---------------------------|------------|-------------------|

Performance Curve

AMX434-178/4D/C

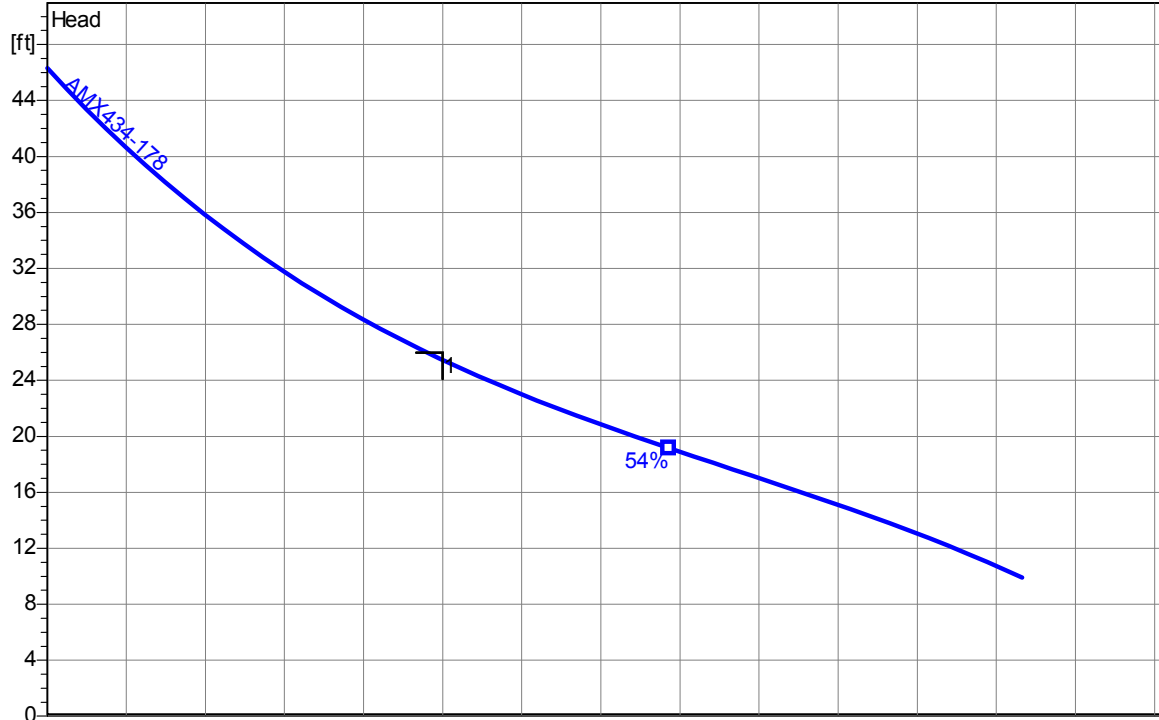
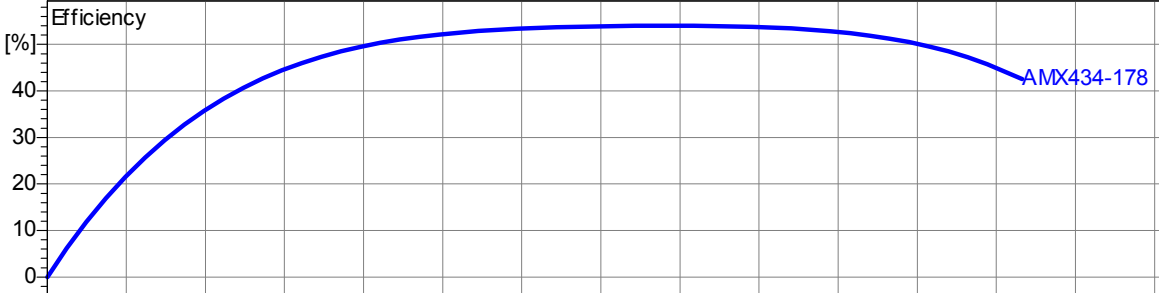
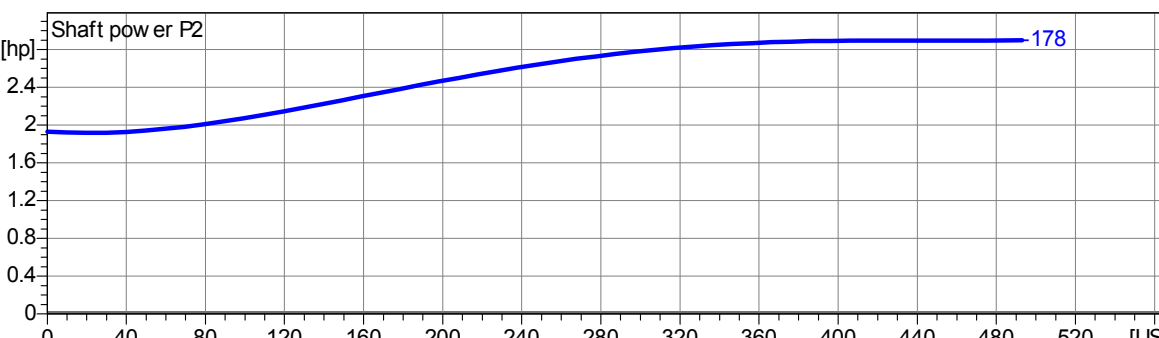
| Impeller | | | | | |
|--|----------------------------------|--|----------------------------------|---------------------------|-----------------------------------|
| Impeller type: Single channel impeller | Solid size 3 inch | Ø: | Max. Ø: 8 1/8" | Min. Ø: 5 9/16" | Sel. Ø: 7" |
| Operating data | | | | | |
| Speed: 1750 rpm | Frequency: 60 Hz | Duty point: Q = 200 US g.p.m. H = 26 ft | | Suction port: | Discharge port: 4" ANSI |
| Power data referred to: Water, pure [100%]; 68°F; 62.322lb/ft³; 1.0818E-5ft²/s | | | | Testnorm: | ISO 9906 |
| Curve number: | | | | | |
|  | | | | | |
|  | | | | | |
|  | | | | | |
| Project Man. Cty IFB #09-0897-OV | Project no.: LS # 42-A | | Created by: nyackerman | Page: 2 | Date: 4/1/2009 |

Performance Curve

AMX646-310/15,3P/C

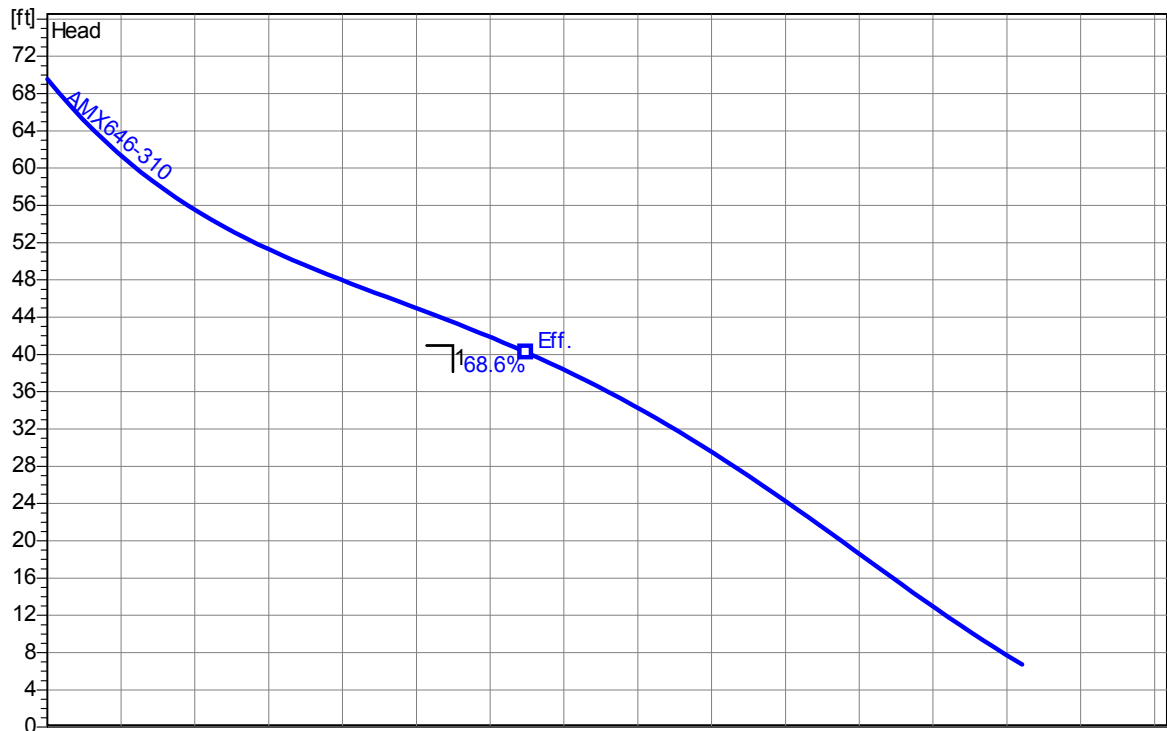
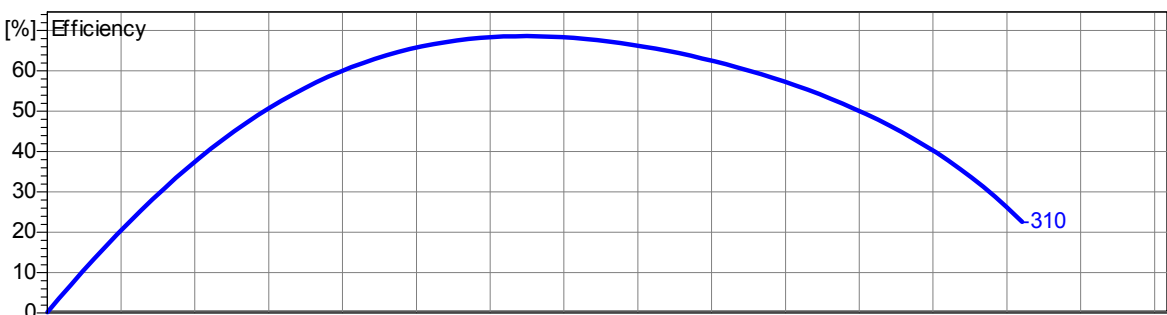
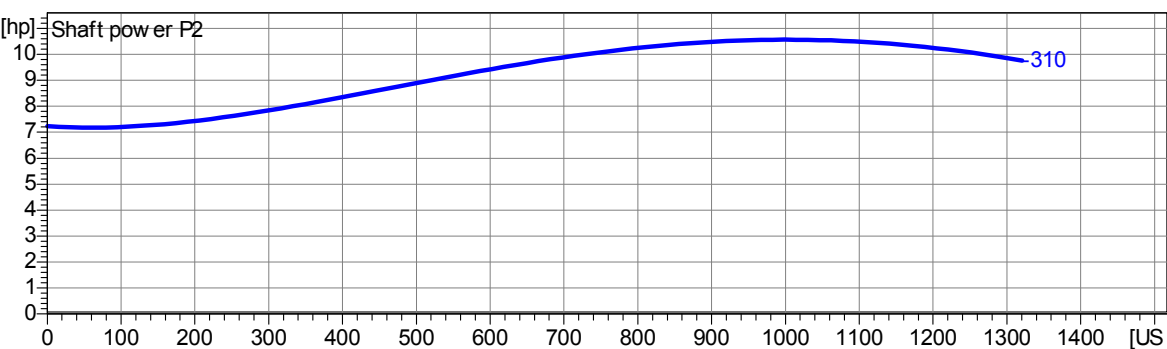
| Impeller | | | | | |
|--|----------------------------------|--|---|--|---|
| Impeller type: Single channel impeller | Solid size 4 inch | Ø: | Max. Ø: 12⁵/₁₆" | Min. Ø: 10³/₈" | Sel. Ø: 12⁵/₁₆" |
| Operating data | | | | | |
| Speed: 1160 rpm | Frequency: 60 Hz | Duty point: Q = 550 US g.p.m. H = 41 ft | | Suction port: | Discharge port: 6" ANSI |
| Power data referred to: Water [100%] ; 68°F; 62.322lb/ft³; 1.0818E-5ft²/s | | | | Testnorm: | ISO 9906 |
| Curve number: | | | | | |
|  | | | | | |
|  | | | | | |
|  | | | | | |
| Project Man. Cty IFB #09-0897-OV | Project no.: LS # 21-A | | Created by: nyackerman | Page: 2 | Date: 4/1/2009 |



Performance Curve

AMX646-300/9,8P

20-A

(433)

Impeller

| | | | | | |
|---|--|----|---|--|--|
| Impeller type: Single vane impeller | Solid size 3¹⁵/₁₆" | Ø: | Max. Ø: 12³/₁₆" | Min. Ø: 10¹/₄" | Sel. Ø: 11¹³/₁₆" |
|---|--|----|---|--|--|

Operating data

| | | | | |
|---------------------------|----------------------------|--|---------------------------------|-----------------------------------|
| Speed: 1160 rpm | Frequency: 60 Hz | Duty point: Q = 651 US g.p.m. H = 33 ft | Suction port: 6" ANSI | Discharge port: 6" ANSI |
|---------------------------|----------------------------|--|---------------------------------|-----------------------------------|

Power data referred to: Water [100%] ; 68°F; 62.322lb/ft³; 1.0818E-5ft²/s

Testnorm: **ISO 9906**

Curve number:

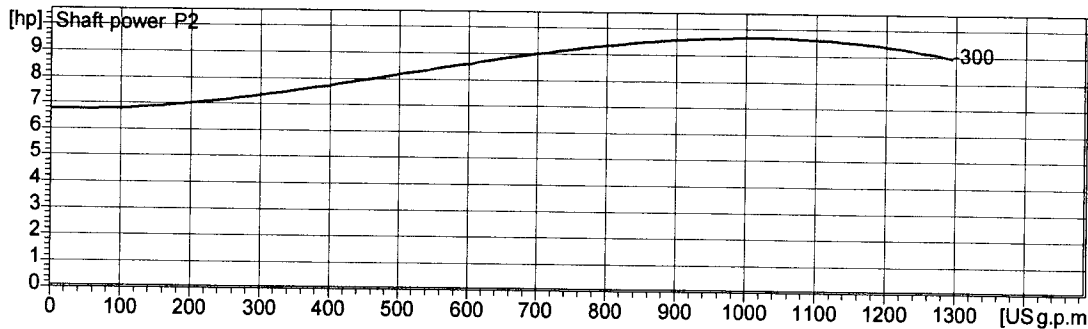
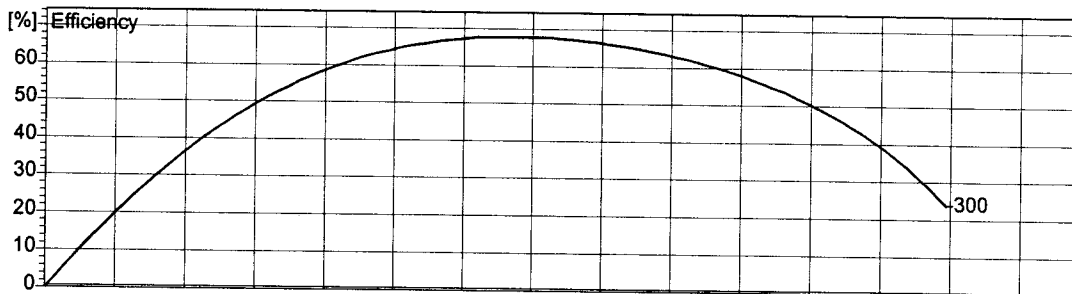
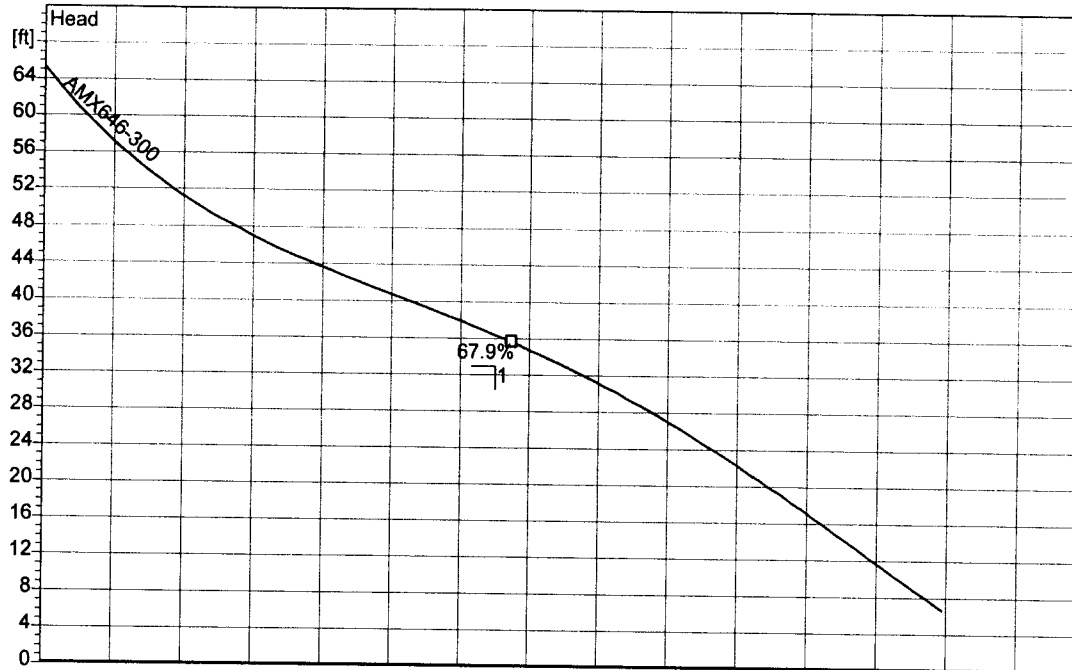

2.0 - 29.09.2004 (Build 60)

| | | | | |
|-------------------------------|--------------------------------------|---------------------------------|-------------------|----------------------------|
| Project Manatee Cty | Project no.: Item Number 4 | Created by: nackerman | Page: 2 | Date: 2005-09-14 |
|-------------------------------|--------------------------------------|---------------------------------|-------------------|----------------------------|



Performance Curve

AMX644-260/20P

14-A

(434)

Impeller

| | | | | |
|---|---|---|--|--|
| Impeller type: Single vane impeller | Solid size Ø: 3¹⁵/₁₆" | Max. Ø: 12³/₁₆" | Min. Ø: 10¹/₄" | Sel. Ø: 10¹/₄" |
|---|---|---|--|--|

Operating data

| | | | | |
|---------------------------|----------------------------|---|---------------------------------|-----------------------------------|
| Speed: 1750 rpm | Frequency: 60 Hz | Duty point: Q = 1085 US g.p.m. H = 38 ft | Suction port: 6" ANSI | Discharge port: 6" ANSI |
|---------------------------|----------------------------|---|---------------------------------|-----------------------------------|

Power data referred to: Water [100%] ; 68°F; 62.322lb/ft³; 1.0818E-5ft³/s Testnorm: **ISO 9906**

Curve number:

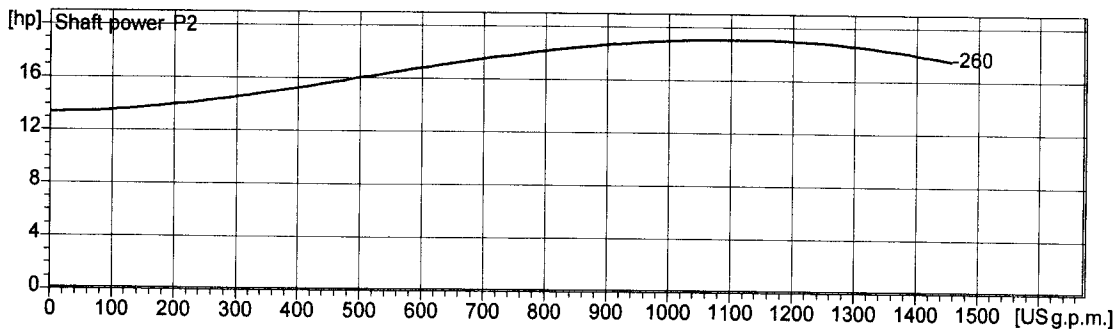
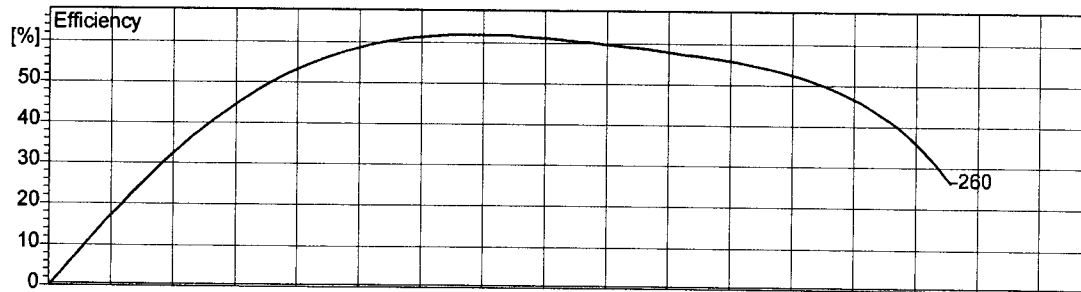
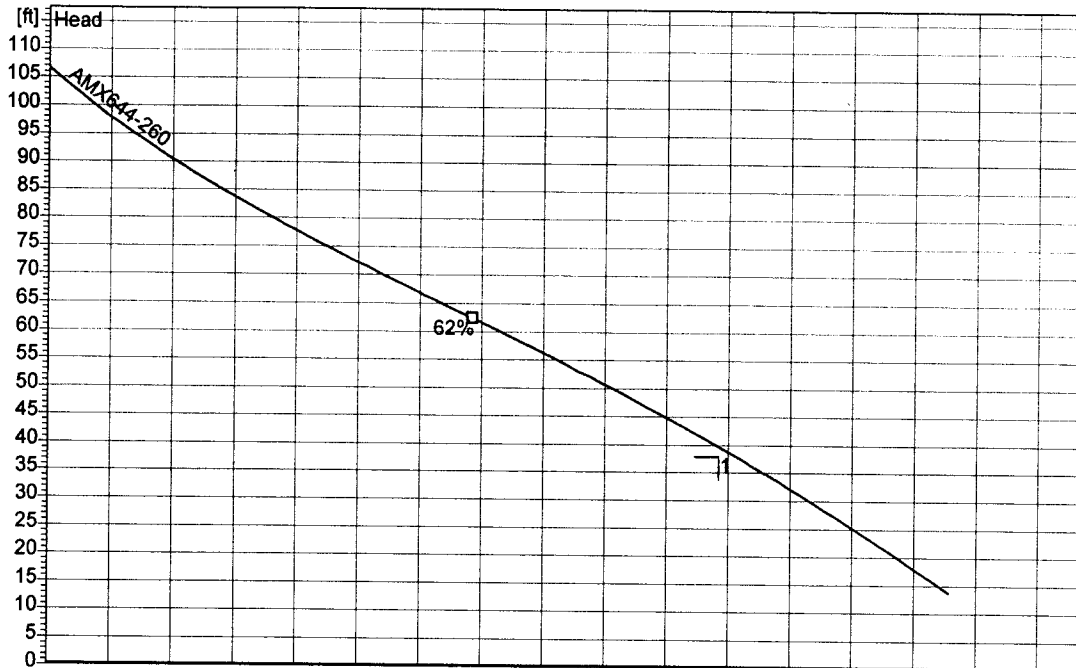

2.0 - 29.09.2004 (Build 60)

| | | | | |
|-------------------------------|-------------------------------|---------------------------------|-------------------|----------------------------|
| Project Manatee Cty | Project no.: Item 2 | Created by: nackerman | Page: 2 | Date: 2005-09-14 |
|-------------------------------|-------------------------------|---------------------------------|-------------------|----------------------------|

RTU 434

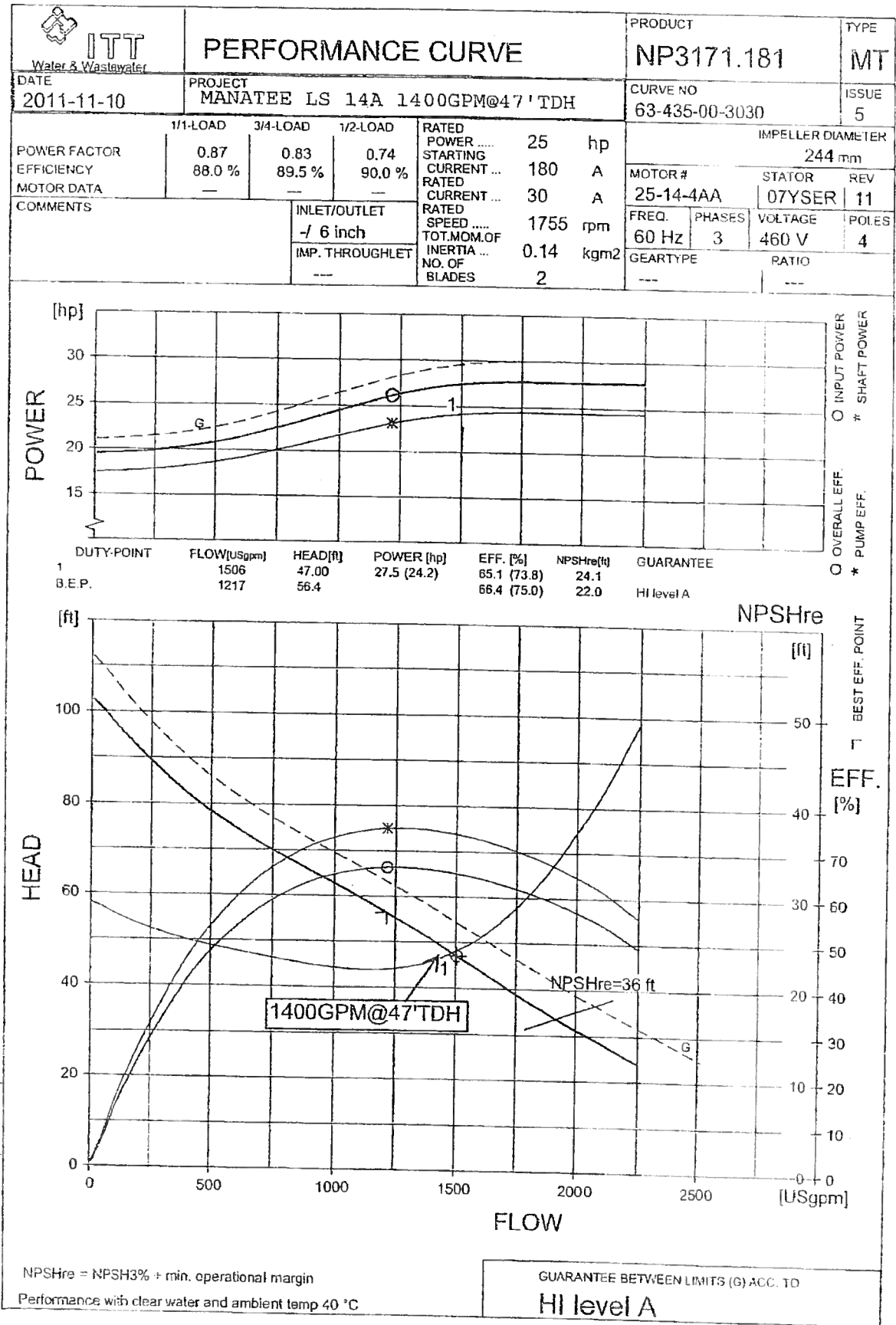

FLYPS3.1.6.5 (20090313)

Noods of Whitfield **A35**

Crane/Barnes

Selection list: ---

Catalog: Crane Barnes 60Hz vers 8

Selection Criteria:

Pump: 4SE37*4L

Flow: 175 US gpm
Head: 25 ft
Tolerance: --- % of head

Type: 1D4NONCLOG
Synch speed: 1800 rpm
Speed: 1750 rpm
Dia: 6.25 in
Curve no.:

Fluid: Water

Temperature: 60 °F
SG: 1
Viscosity: 1.105 cP
Vapor pressure: 0.2563 psi a
Atm pressure: 14.7 psi a

Specific Speeds

Ns: --- Nss: ---

Dimensions:

Suction: --- in Discharge: 4 in

NPSHa: --- ft

Pump Limits:

Temperature: --- °F
Pressure: --- psi g
Sphere size: 3 in
Power: --- bhp

Advanced Criteria:

Preferred Operating Area: ---
Secondary Operating Point: ---
Max temperature: --- °F
Max suction pressure: --- psi g
Max sphere size: --- in
Max power: --- bhp
Max suction specific speed: --- (Nss)
Min trim: --- % of max diameter
Min head rise: --- % to shutoff

Motor: Consult vendor

Curve Corrections: none

--- Data Point ---

Flow: 175 US gpm
Head: 25.1 ft
Eff: 42%
Power: 2.59 bhp
NPSHr: --- ft

-- Design Curve --

Shutoff Head: 37.7 ft
Shutoff dP: 16.3 psi
Min Flow: --- US gpm
BEP: 44% eff
@ 208 US gpm
NOL Pwr: 3.24 bhp
@ 353 US gpm

-- Max Curve --

Max Pwr: 5.16 bhp
@ 100 US gpm

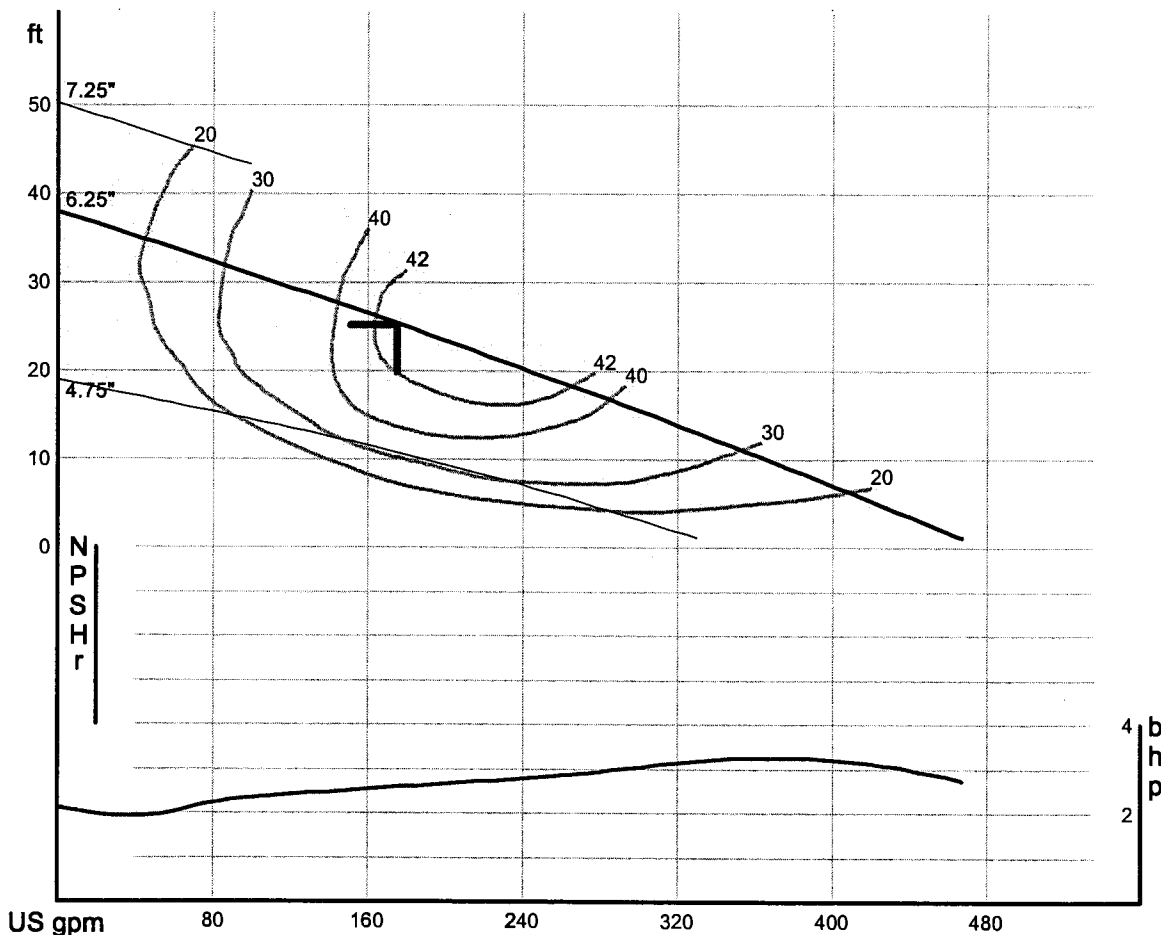

Pump note: Temp. 104°F (40°C) Continuous.

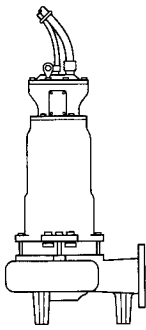

Performance Curve **S4M/S4MX**

RPM: **1750** Discharge: **4"** Solids: **3"**

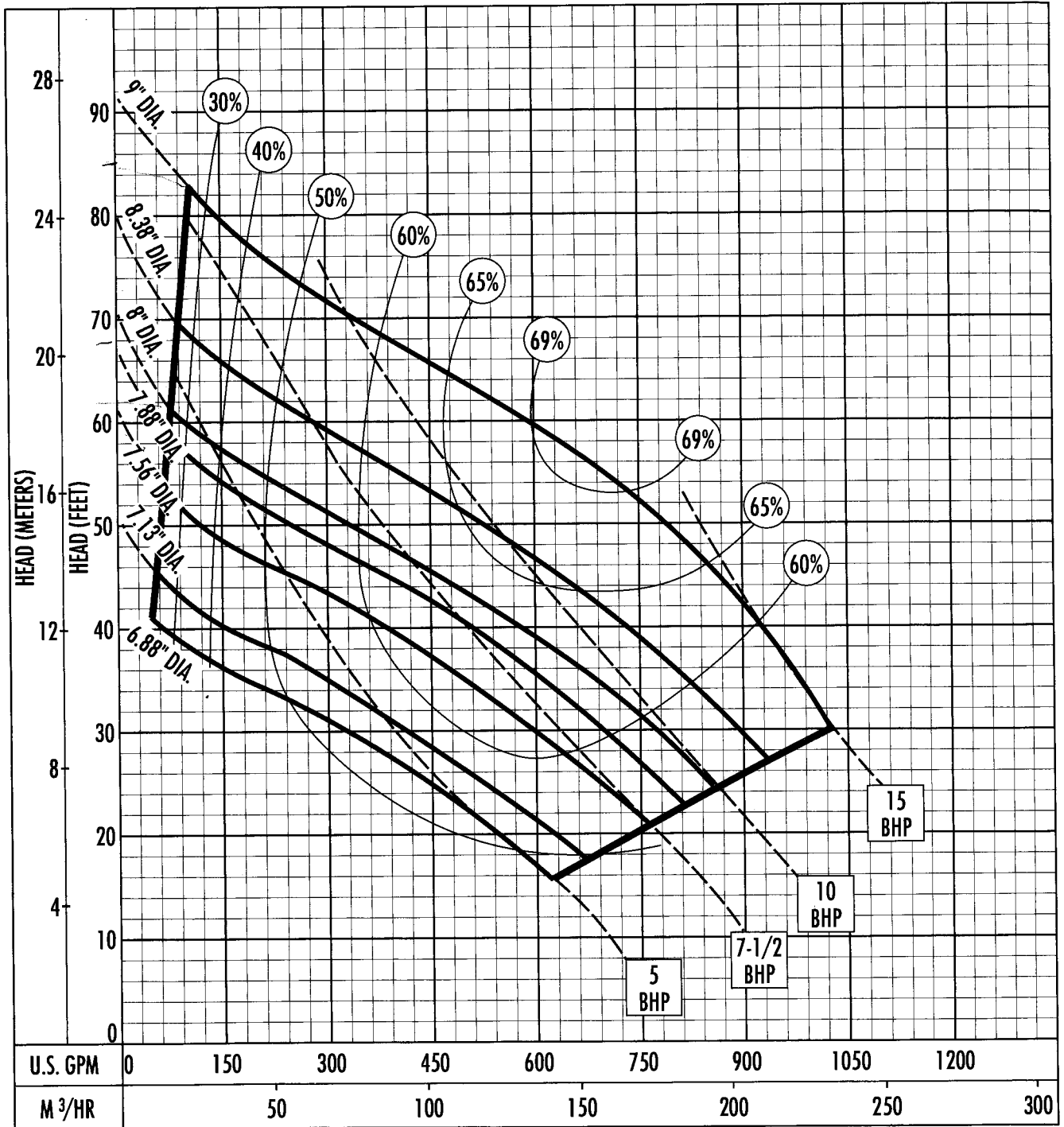

The curves reflect maximum performance characteristics without exceeding full load (Nameplate) horsepower. All pumps have a service factor of 1.2. Operation is recommended in the bounded area with operational point within the curve limit. Performance curves are based on actual tests with clear water at 70° F. and 1280 feet site elevation.

RTU 436
9-A
Installed 7-21-11

| Impeller | | | | | |
|--|-----------------------------|---|------------------------------|---------------------------|---------------------------------|
| Impeller type: Single channel impeller | Solid size 3 inch | Ø: | Max. Ø: 8 1/8" | Min. Ø: 5 9/16" | Sel. Ø: 7 1/4" |
| Operating data | | | | | |
| Speed: 1750 rpm | Frequency: 60 Hz | Duty point: Q = 225 US g.p.m. | H = 33 ft | | Suction port: 4" ANSI |
| Power data referred to: Water, pure [100%] ; 68°F; 62.322lb/ft³; 1.0818E-5ft²/s | | | Testnorm: ISO 9906 | | |

Curve number:

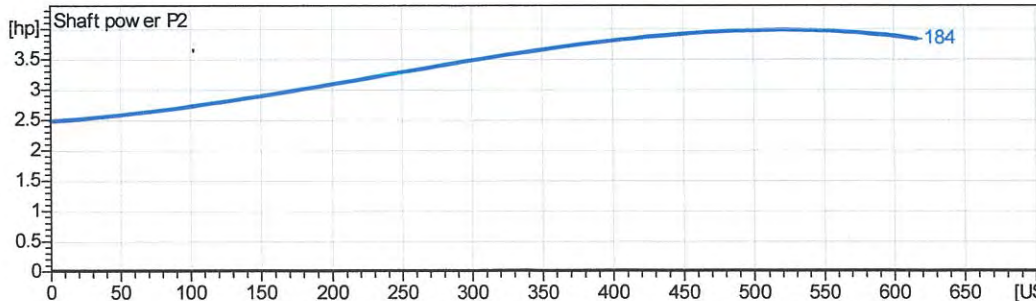
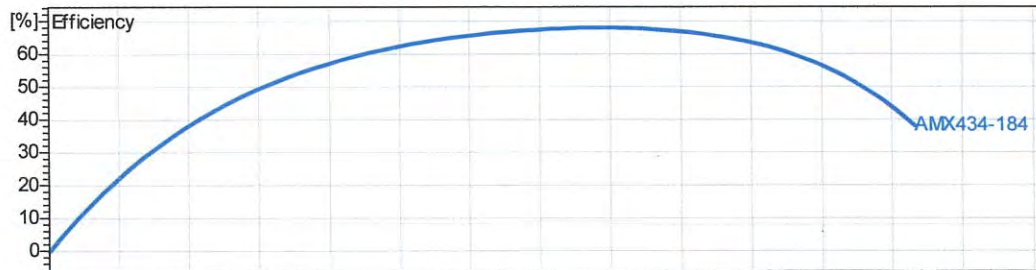

| | | | | |
|----------------------------------|---------------------------|----------------------------------|-------------------|----------------------------|
| Project Manatee County | Project no.: 9A | Created by: nyackerman | Page: 2 | Date: 2010-10-08 |
|----------------------------------|---------------------------|----------------------------------|-------------------|----------------------------|

Performance Curve – S4N/S4NX

RPM: **1750** DISCHARGE: **4"** SOLIDS: **3"**

Lift Station 437

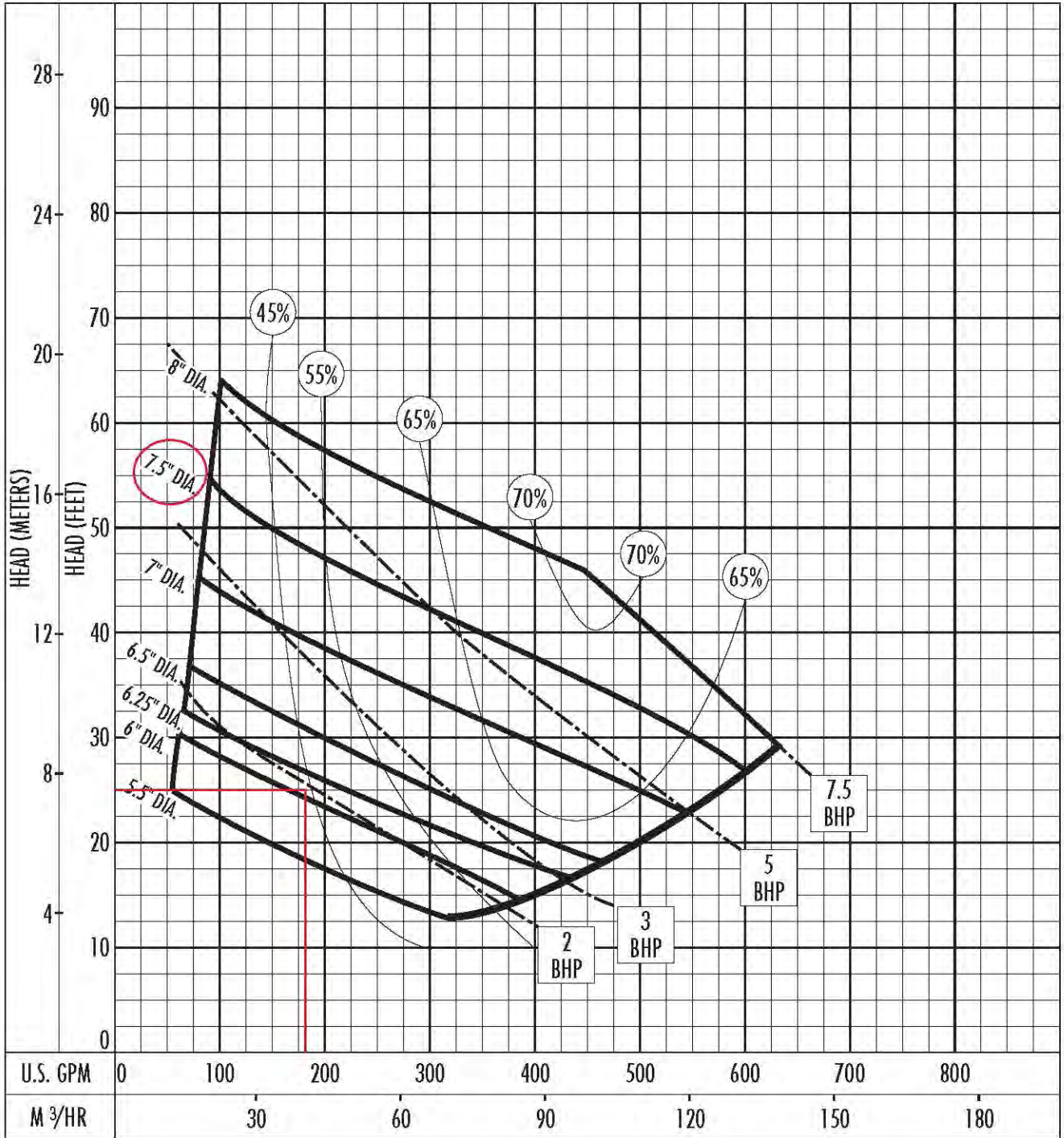

The curves reflect maximum performance characteristics without exceeding full load (Nameplate) horsepower. All pumps have a service factor of 1.2. Operation is recommended in the bounded area with operational point within the curve limit. Performance curves are based on actual tests with clear water at 70° F. and 1280 feet site elevation.

Conditions of Service:

Performance Curve – S4N/S4NX

RPM: **1750** DISCHARGE: **4"** SOLIDS: **3"**

Lift Station 438

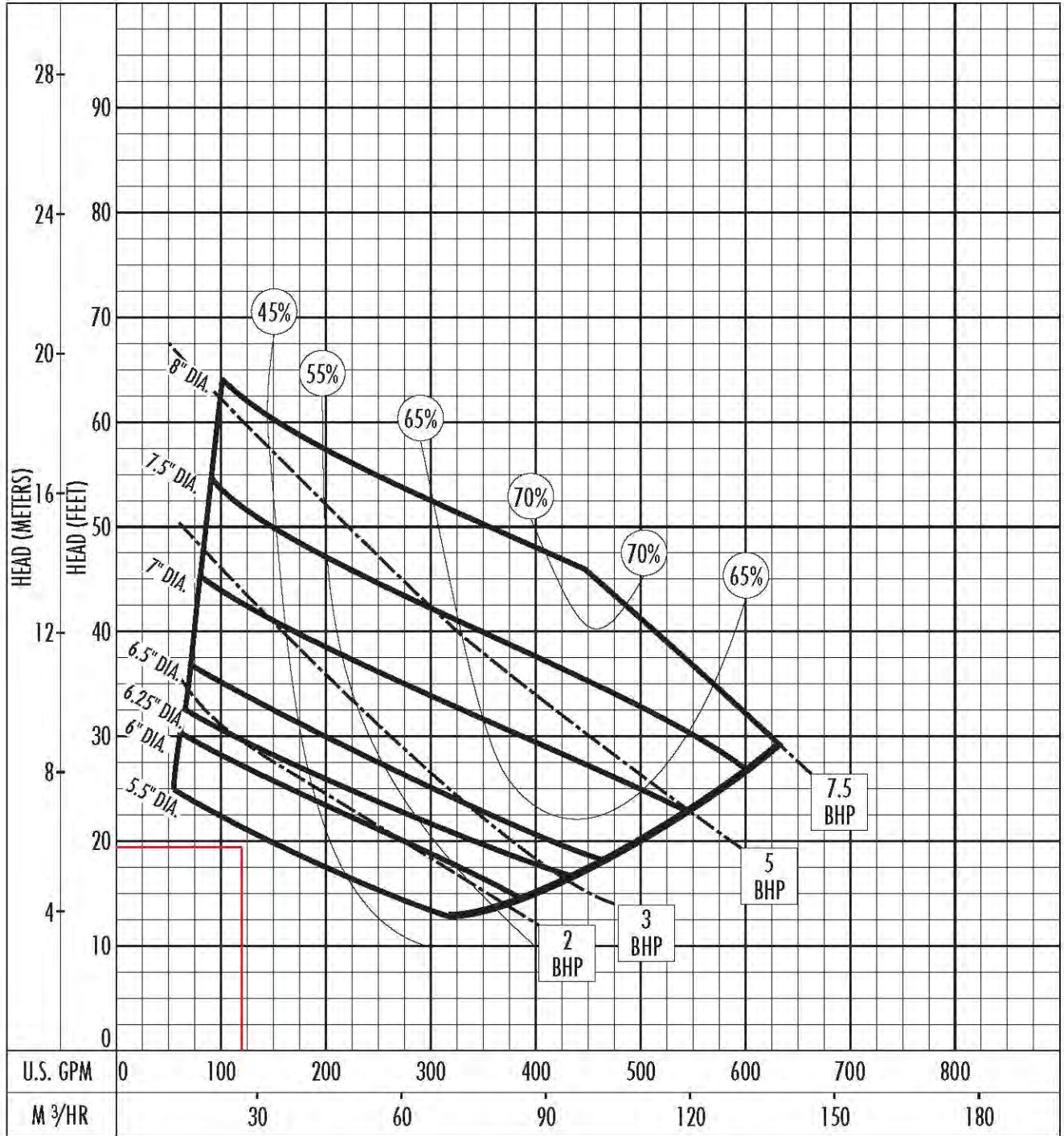

The curves reflect maximum performance characteristics without exceeding full load (Nameplate) horsepower. All pumps have a service factor of 1.2. Operation is recommended in the bounded area with operational point within the curve limit. Performance curves are based on actual tests with clear water at 70° F. and 1280 feet site elevation.

Conditions of Service:

ITEM # 7 5-A RTU 438

PERFORMANCE CURVES

| | | | |
|----------------------|----------|----------------------|-----------------------------|
| 4-poles ; 1750 rpm | M | Enclosed | ② Type: AM434-150/2.9N (FM) |
| 4" Nominal discharge | | single-vane impeller | |
| 3" Solid size | | 60 Hz | |

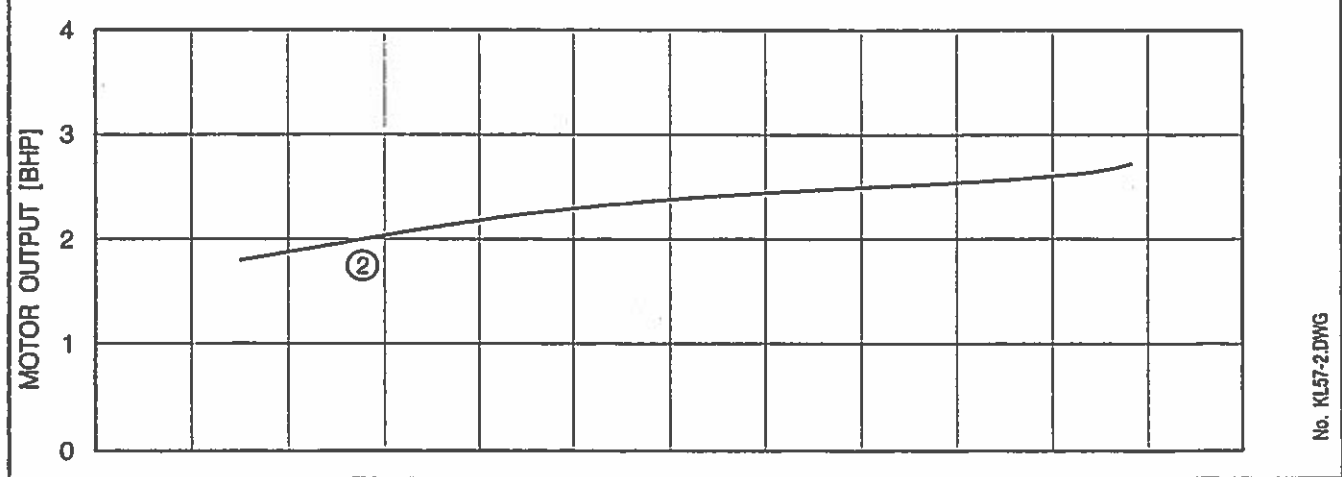
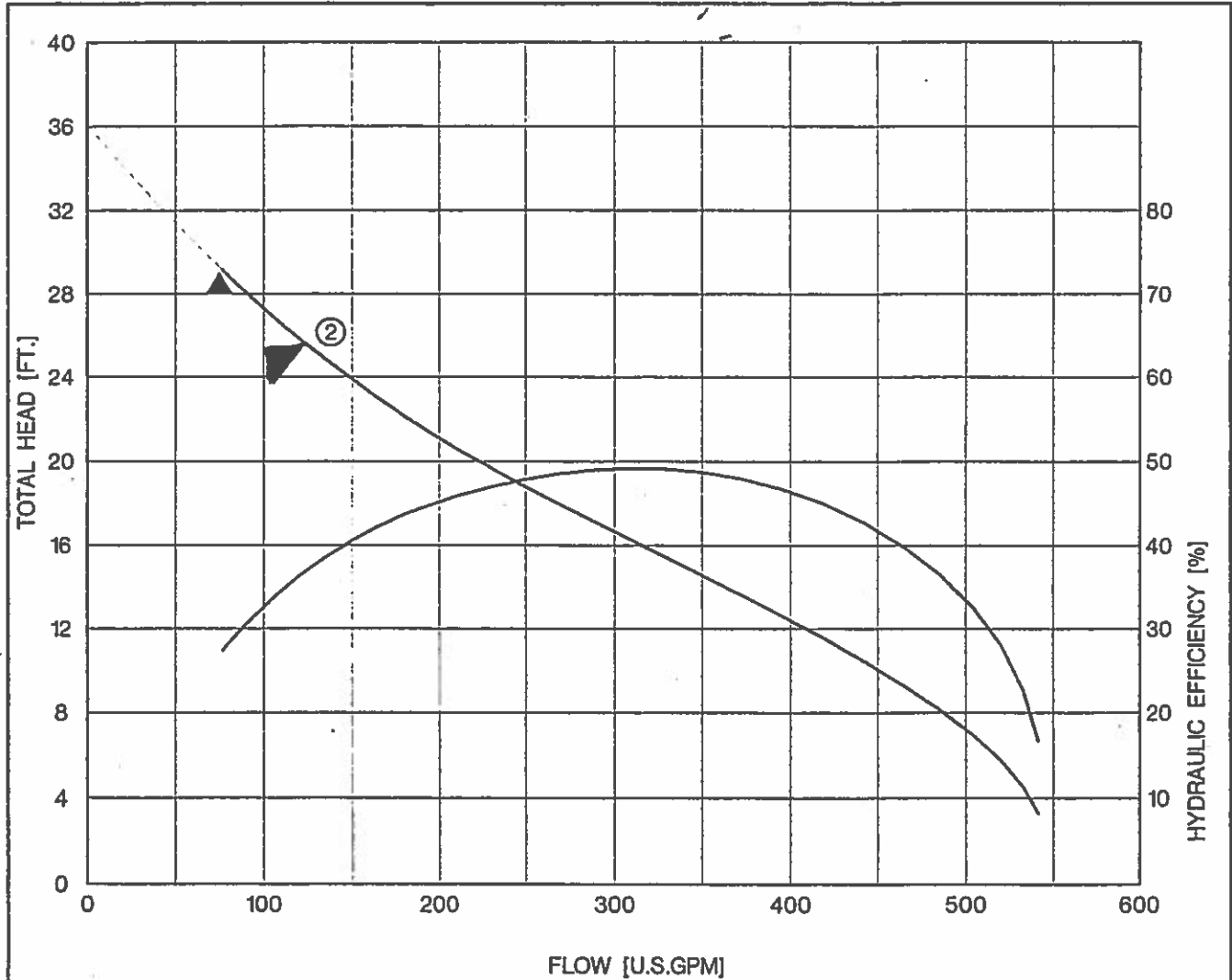

No. KL57-2.DWG

439 2-A

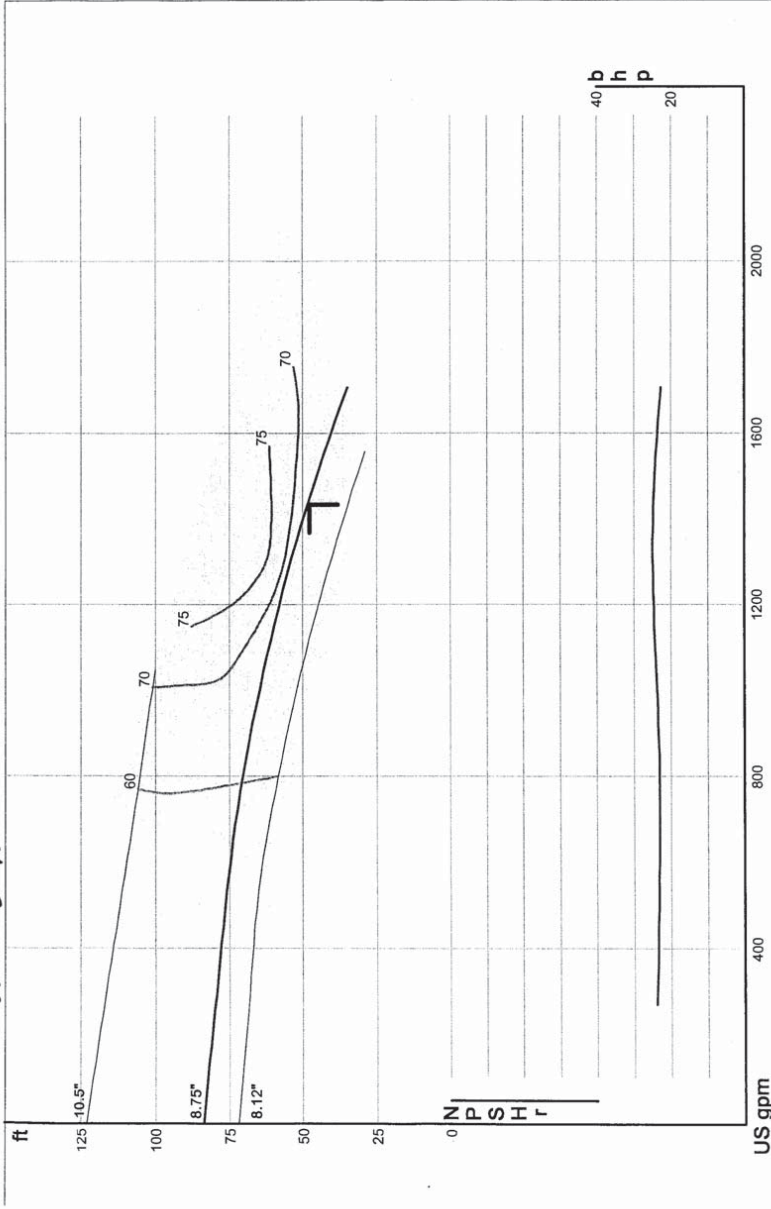

Curve No.:
Size: 6SE360*4HL
Speed: 1750 rpm
Dia: 8.75 in

Crane/Barnes
Catalog: Crane Barnes 60Hz, vers 8
1F6NONCLOG - 1800
Design Point: 1433 US gpm, 47 ft

Southwestern Pump
2-A
02/09/06
.ufs

BARNES

RTU 440

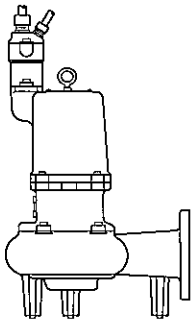

Performance Curve

S4N/S4NX

RPM: **1750** Discharge: **4"** Solids: **3"**

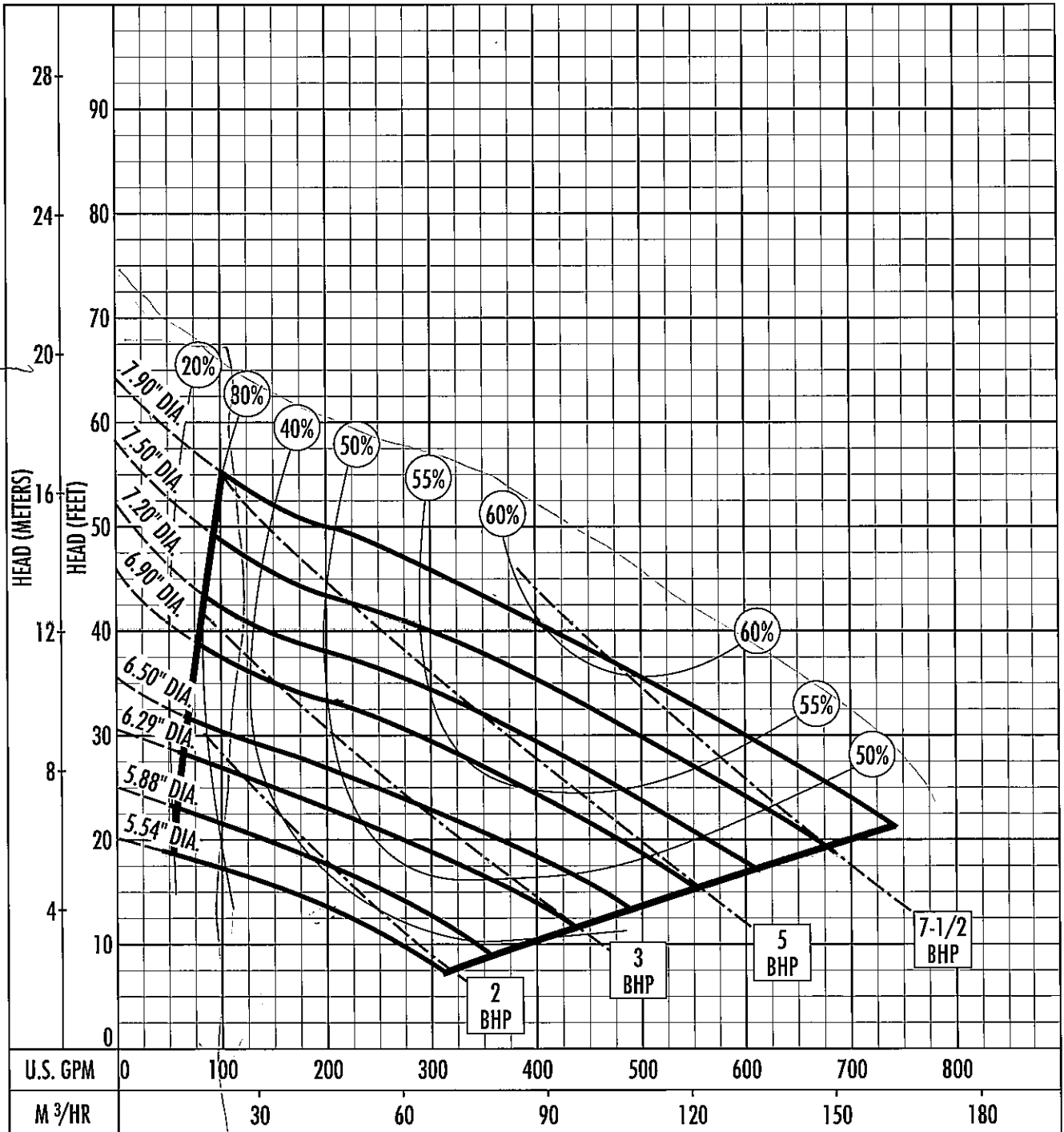

The curves reflect maximum performance characteristics without exceeding full load (Nameplate) horsepower. All pumps have a service factor of 1.2. Operation is recommended in the bounded area with operational point within the curve limit. Performance curves are based on actual tests with clear water at 70° F. and 1280 feet site elevation.

Conditions of Service:



GPM: _____ TDH: _____

HYDROMATIC™ PUMPS

*RTU 457
Whit. Ind. Pk. 1
Installed 6-27-11*

| Impeller | | | | | |
|--|-----------------------------|---|--------------------------|---------------------------|---------------------------------|
| Impeller type: Single channel impeller | Solid size 3 inch | Ø: | Max. Ø: 8 1/8" | Min. Ø: 5 9/16" | Sel. Ø: 6 1/8" |
| Operating data | | | | | |
| Speed: 1750 rpm | Frequency: 60 Hz | Duty point: Q = 110 US g.p.m. | H = 25 ft | | Suction port: 4" ANSI |
| Power data referred to: Water, pure [100%] ; 68°F; 62.322lb/ft³; 1.0818E-5ft²/s | | | Testnorm: | ISO 9906 | |

Curve number:

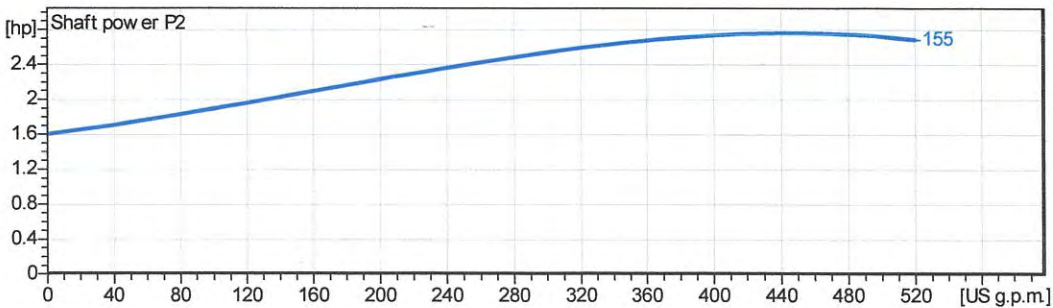
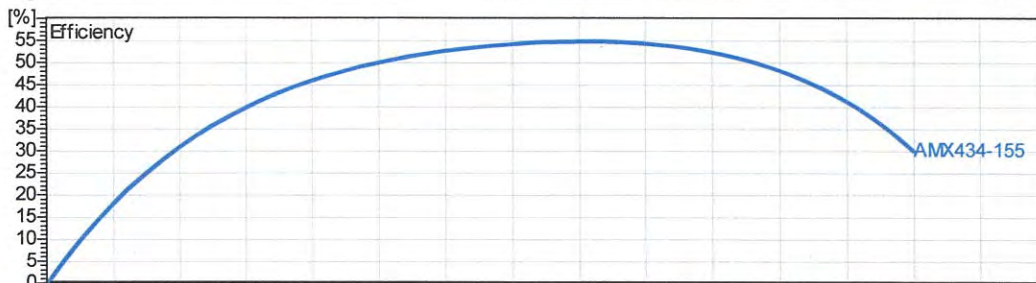
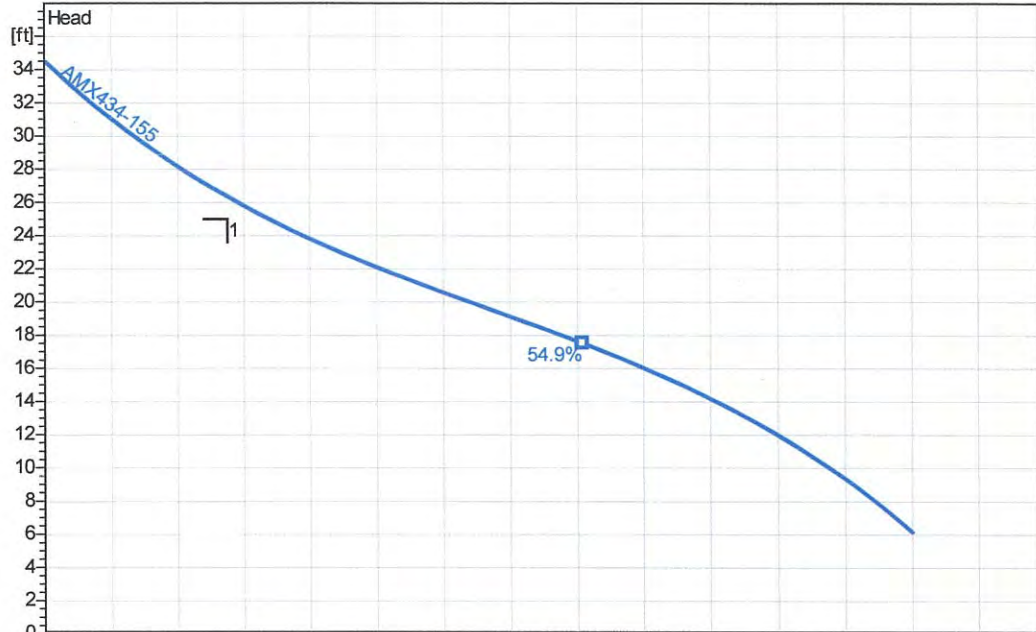

| | | | | |
|----------------------------------|--|----------------------------------|-------------------|----------------------------|
| Project Manatee County | Project no.: Whitfield Industrial Pk 1 | Created by: nyackerman | Page: 2 | Date: 2010-10-08 |
|----------------------------------|--|----------------------------------|-------------------|----------------------------|

TOTAL HEAD
MTRS | FT

Performance Curve
Models: 4SE203 - 4SE204
Impeller Dia: 6.62"
Solids: 3" Spherical
1725 RPM

Peabody Barnes Inc.

AS
Whitfield Inv. Park

14
13
12
11
10
9
8
7
6
5
4
3
2
1

50
40
30
20
10

U. S. GALLONS
PER MINUTE

50 100 150 200 250 300 350 400 450

LITERS
PER MINUTE

100 200 300 400 500 600 700 800 900 1000 1100 1200 1300 1400 1500 1600 1700

Form No. 1187-282

Page SW-39

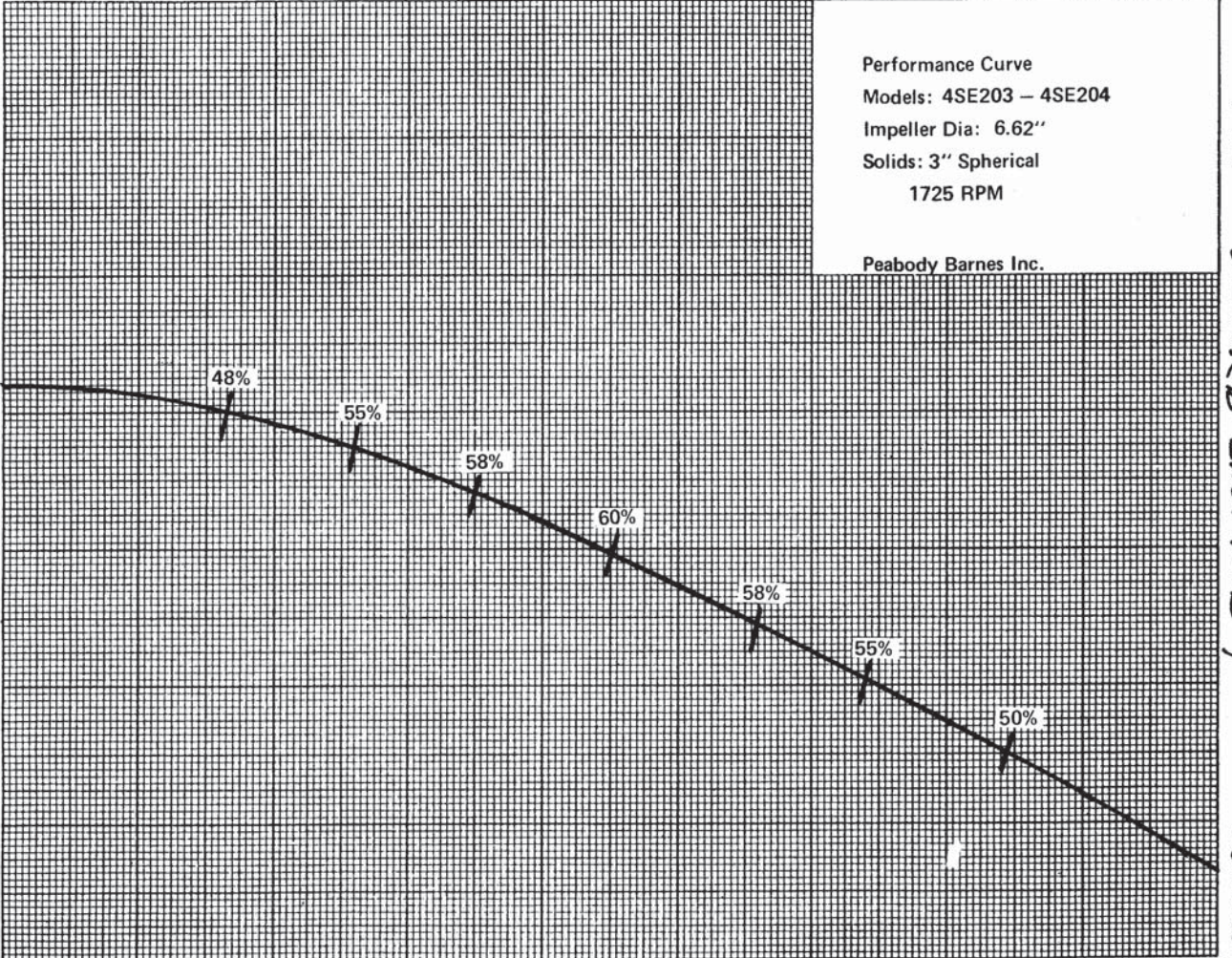

| Impeller | | | | | |
|---|-----------------------------|---|--------------------------|-----------------------------------|----------------------|
| Impeller type: Single channel impeller | Solid size 3 inch | Ø: | Max. Ø: 8 1/8" | Min. Ø: 5 9/16" | Sel. Ø: 7" |
| Operating data | | | | | |
| Speed: 1750 rpm | Frequency: 60 Hz | Duty point: Q = 66 US g.p.m. H = 33 ft | Suction port: | Discharge port: 4" ANSI | |
| Power data referred to: Water, pure [100%]; 68°F; 62.322lb/ft³; 1.0818E-5ft²/s | | | Testnorm: | ISO 9906 | |

Curve number:

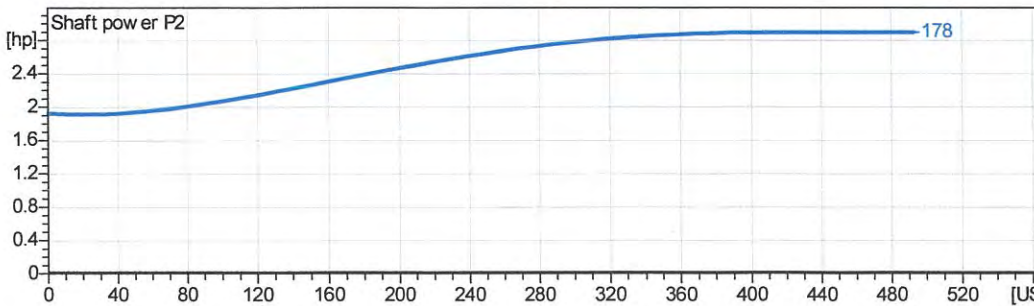
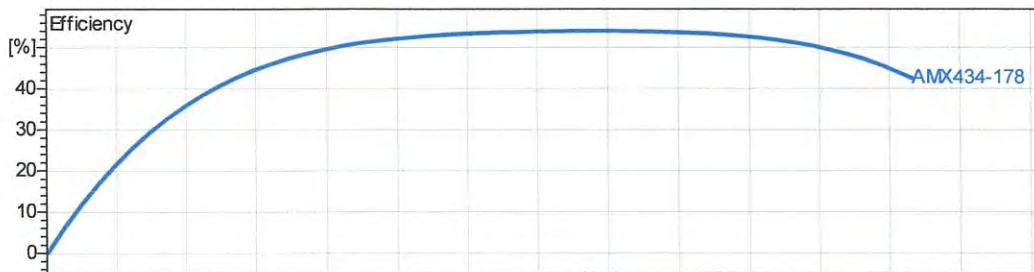

2.0 - 11.01.2008 (Build 137) Homa Pump Technology Inc. (internal)

| | | | | |
|----------------------------------|--|----------------------------------|-------------------|----------------------------|
| Project Manatee County | Project no.: Whitfield Industrial Pk 2 | Created by: nyackerman | Page: 2 | Date: 2010-10-08 |
|----------------------------------|--|----------------------------------|-------------------|----------------------------|

458 Whitfield Ind. Park 2

5.88" imp

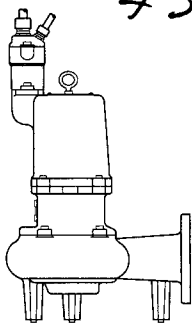

Performance Curve

S4N/S4NX

RPM: **1750**

Discharge: **4"**

Solids: **3"**

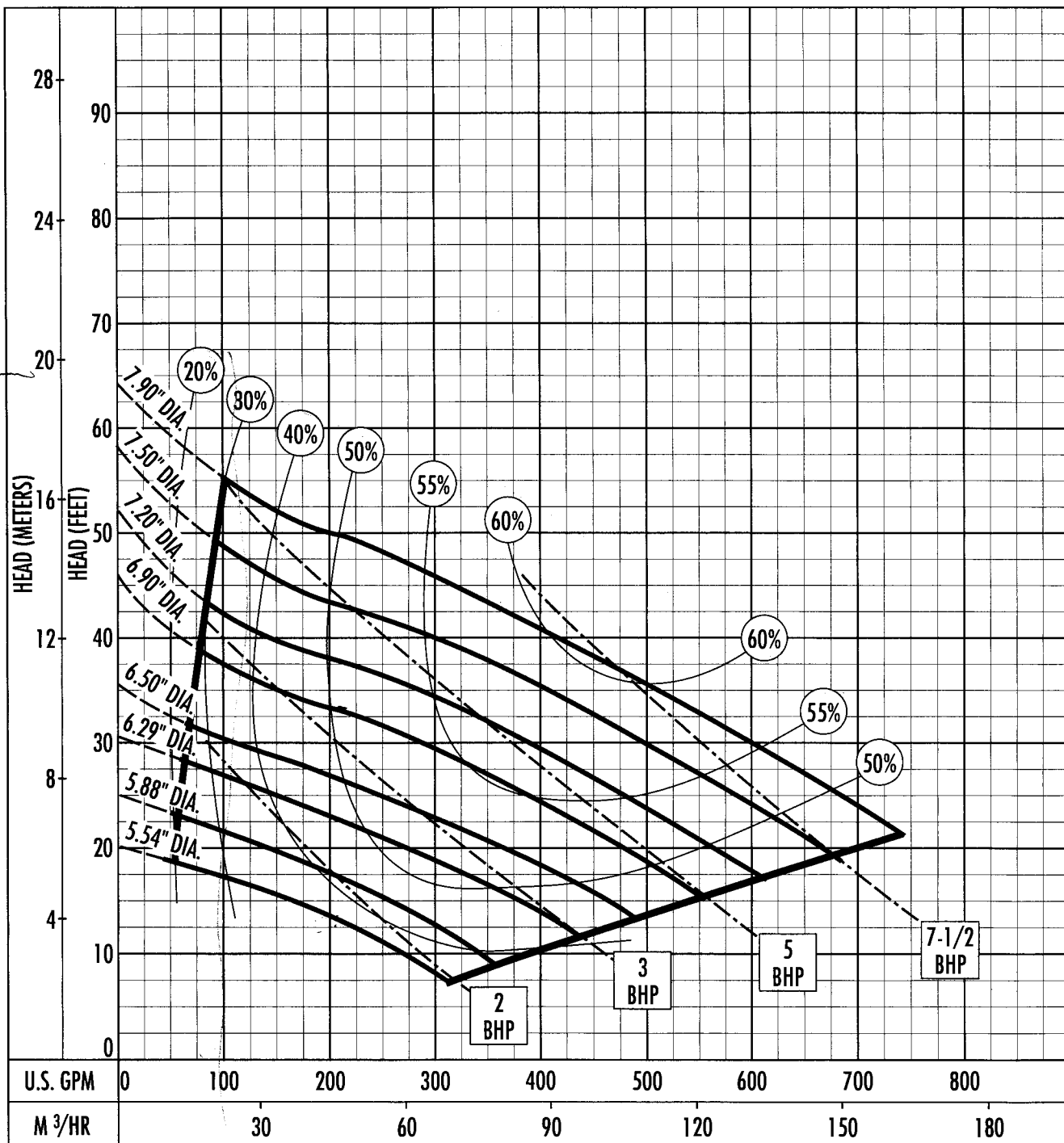

The curves reflect maximum performance characteristics without exceeding full load (Nameplate) horsepower. All pumps have a service factor of 1.2. Operation is recommended in the bounded area with operational point within the curve limit. Performance curves are based on actual tests with clear water at 70° F. and 1280 feet site elevation.



Performance Curve

AMX434-142/2.5D

Cortez Plaza 2-A (460)

Impeller

| | | | | | |
|---|-----------------------------|----|--------------------------|---------------------------|---------------------------|
| Impeller type: Single vane impeller | Solid size 3 1/8" | Ø: | Max. Ø: 8 1/8" | Min. Ø: 5 9/16" | Sel. Ø: 5 9/16" |
|---|-----------------------------|----|--------------------------|---------------------------|---------------------------|

Operating data

| | | | | |
|---------------------------|----------------------------|---|---------------|-----------------------------------|
| Speed: 1700 rpm | Frequency: 60 Hz | Duty point: Q = 75 US g.p.m. H = 16 ft | Suction port: | Discharge port: 4" ANSI |
|---------------------------|----------------------------|---|---------------|-----------------------------------|

Power data referred to: Water, pure [100%] ; 68°F; 62.322lb/ft³; 1.0818E-5ft²/s Testnorm: **ISO 9906**

Curve number:

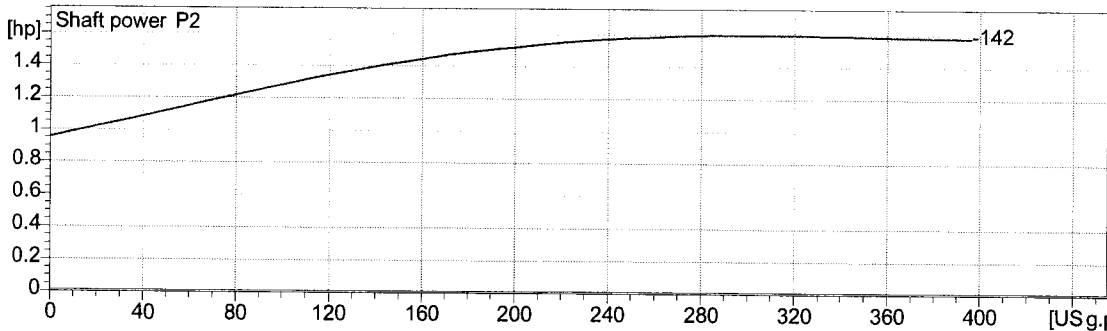
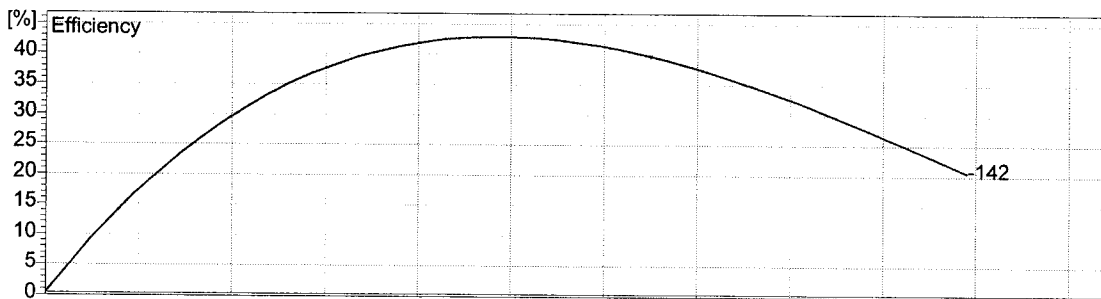
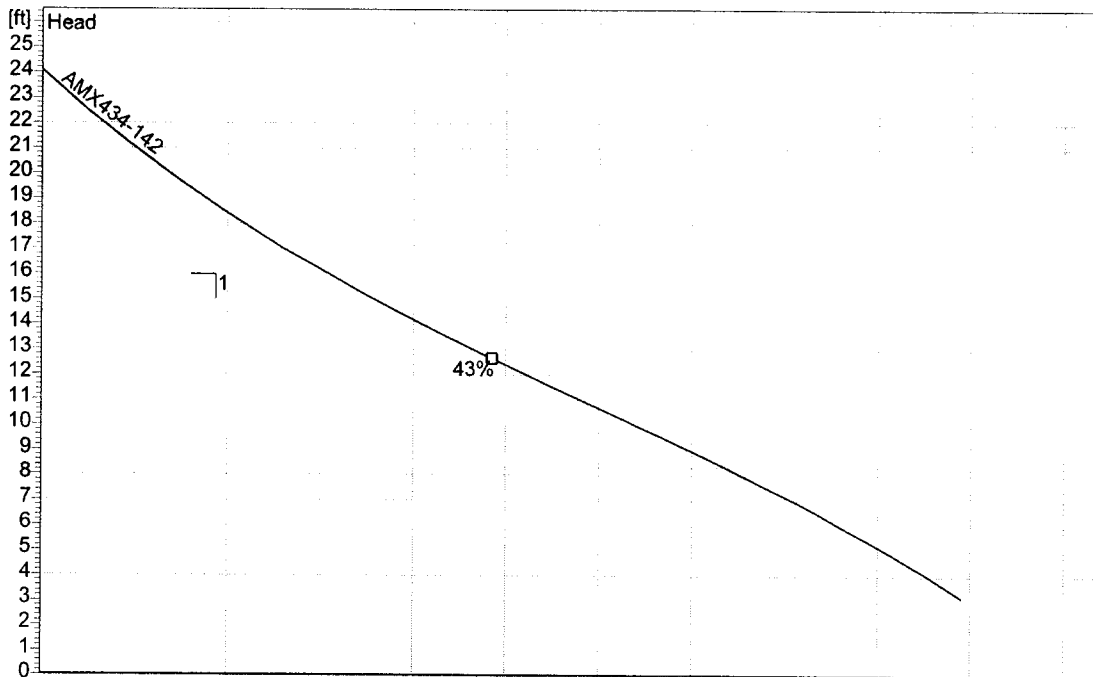

2.0 - 29.09.2004 (Build 60)

Performance Curve

AMX434-178/4D/C

| Impeller | | | | | |
|---|-----------------------------|--|--------------------------|---------------------------|-----------------------------------|
| Impeller type: Single channel impeller | Solid size 3 inch | Ø: | Max. Ø: 8 1/8" | Min. Ø: 5 9/16" | Sel. Ø: 7" |
| Operating data | | | | | |
| Speed: 1750 rpm | Frequency: 60 Hz | Duty point: Q = 150 US g.p.m. H = 25 ft | | Suction port: | Discharge port: 4" ANSI |
| Power data referred to: Water, pure [100%]; 68°F; 62.322lb/ft³; 1.0818E-5ft²/s | | | | Testnorm: | ISO 9906 |

Curve number:

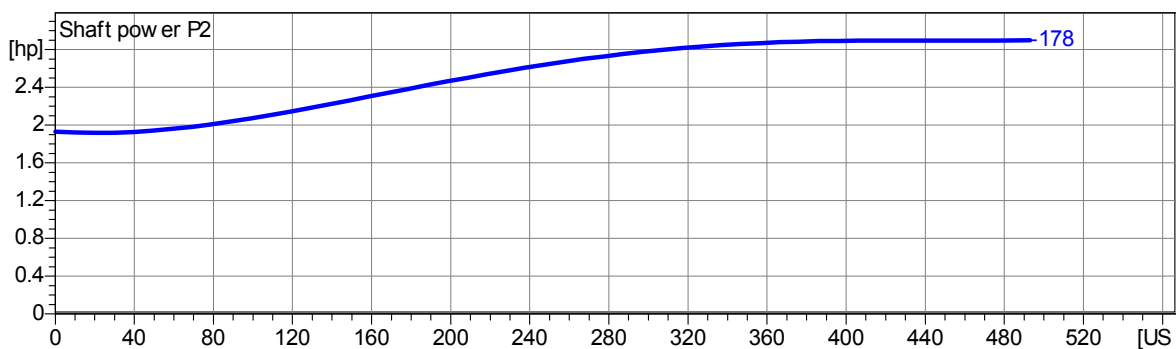
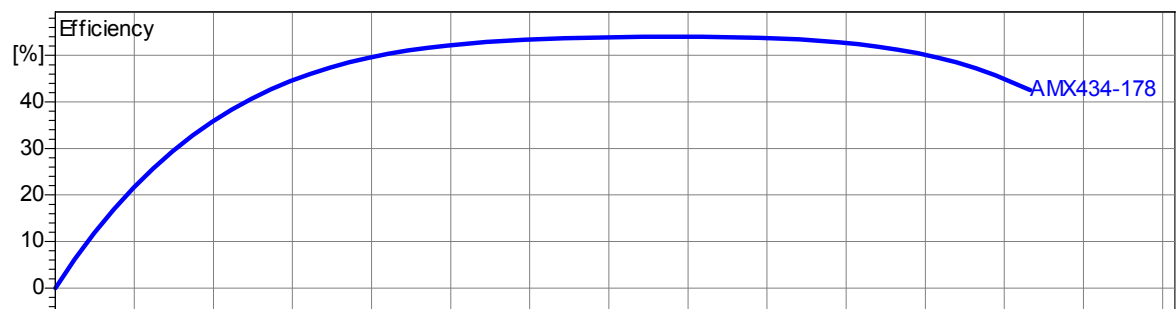
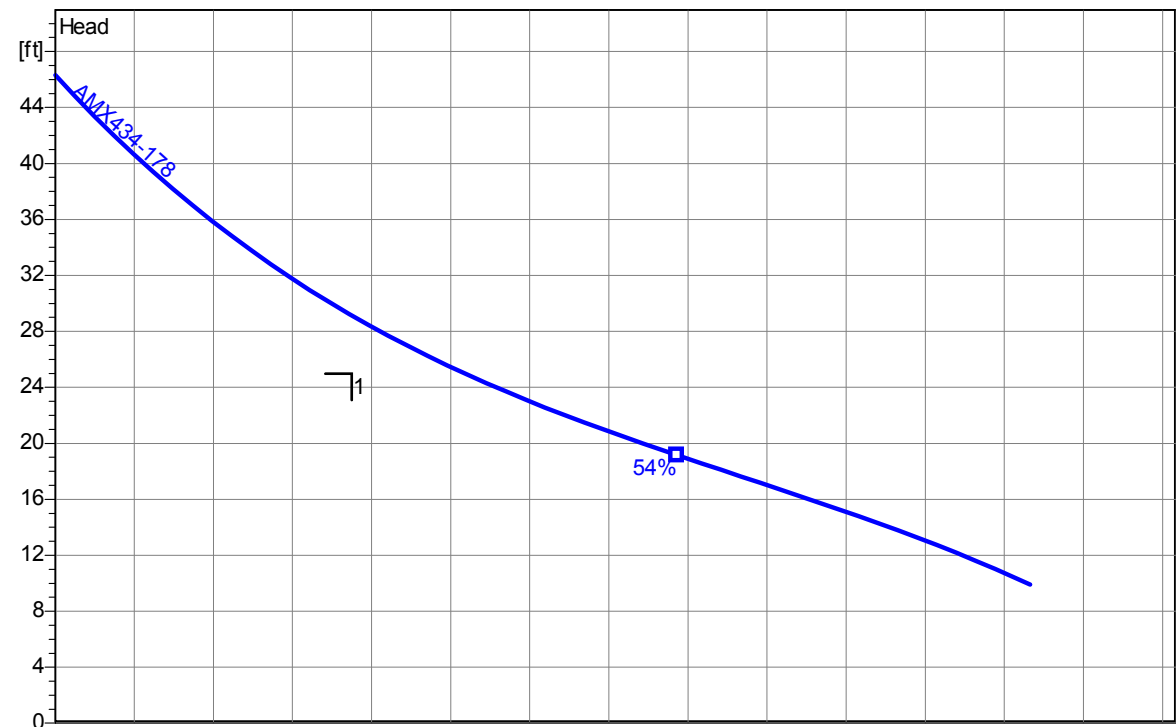

| | | | | |
|--|---|----------------------------------|-------------------|--------------------------|
| Project Man. Cty IFB #09-0897-OV | Project no.: Airport Industrial Pk. | Created by: nyackerman | Page: 2 | Date: 4/1/2009 |
|--|---|----------------------------------|-------------------|--------------------------|

Performance Curve – S4N/S4NX

RPM: **1750** DISCHARGE: **4"** SOLIDS: **3"**

Lift Station 471

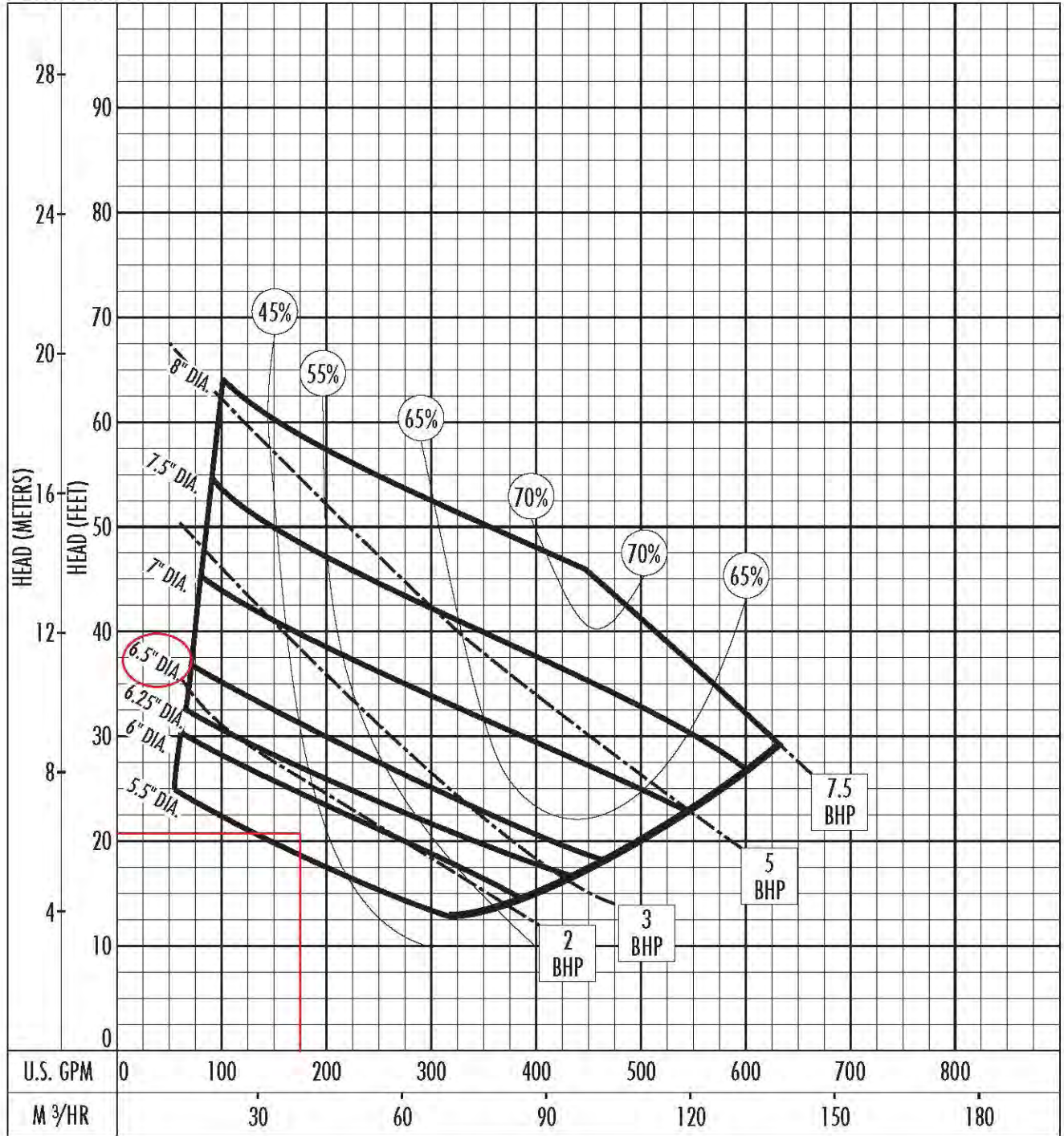

The curves reflect maximum performance characteristics without exceeding full load (Nameplate) horsepower. All pumps have a service factor of 1.2. Operation is recommended in the bounded area with operational point within the curve limit. Performance curves are based on actual tests with clear water at 70° F. and 1280 feet site elevation.

Conditions of Service:



Performance Curve

AMX434-178/4D/C

480

| Impeller | | | | | |
|---|----------------------|----|-------------------|--------------------|---------------|
| Impeller type: Single channel impeller | Solid size 3 inch | Ø: | Max. Ø: 8 1/8" | Min. Ø: 5 9/16" | Sel. Ø: 7" |

| Operating data | | | | |
|--|---------------------|---|---------------|----------------------------|
| Speed: 1750 rpm | Frequency: 60 Hz | Duty point: Q = 130 US g.p.m. H = 29 ft | Suction port: | Discharge port: 4" ANSI |
| Power data referred to: Water, pure [100%] ; 68°F; 62.322lb/ft³; 1.0818E-5ft²/s | | | Testnorm: | ISO 9906 |

Curve number:

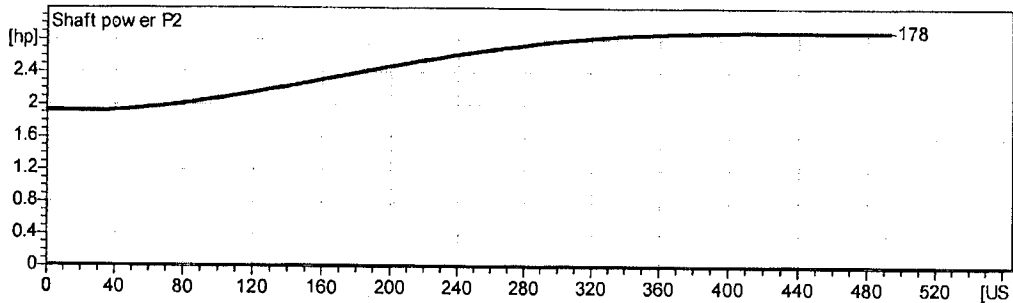
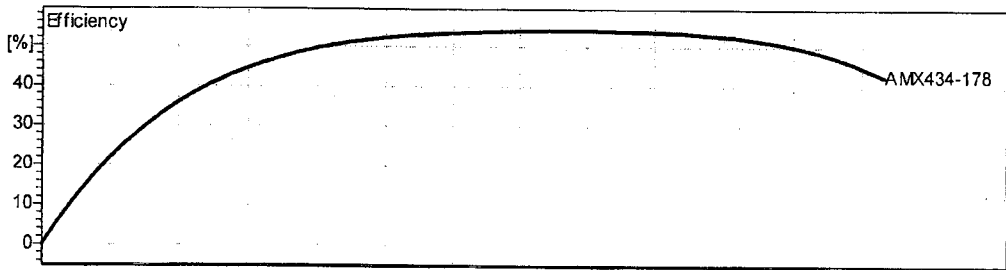
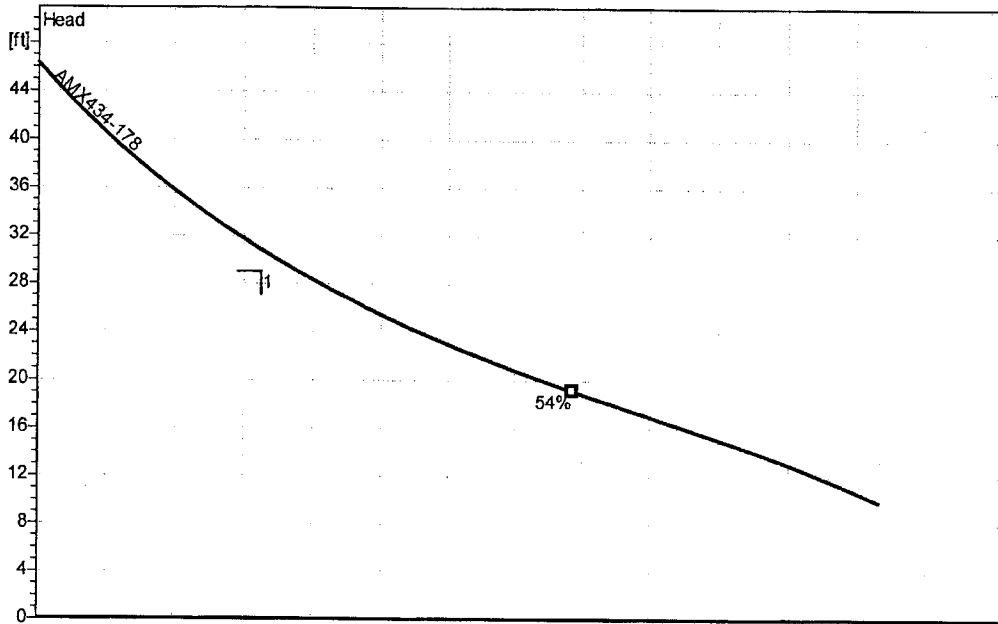

| | | | | |
|---------------------------|--|---------------------------|------------|--------------------|
| Project Manatee County | Project no.: Bradenton / Sar. Airport | Created by: nyackerman | Page: 2 | Date: 8/26/2010 |
|---------------------------|--|---------------------------|------------|--------------------|

2.0 - 11.01.2008 (Build 137) Homa Pump Technology Inc. (internal)

Performance Curve – S4N/S4NX

RPM: **1750** DISCHARGE: **4"** SOLIDS: **3"**

Lift Station 484

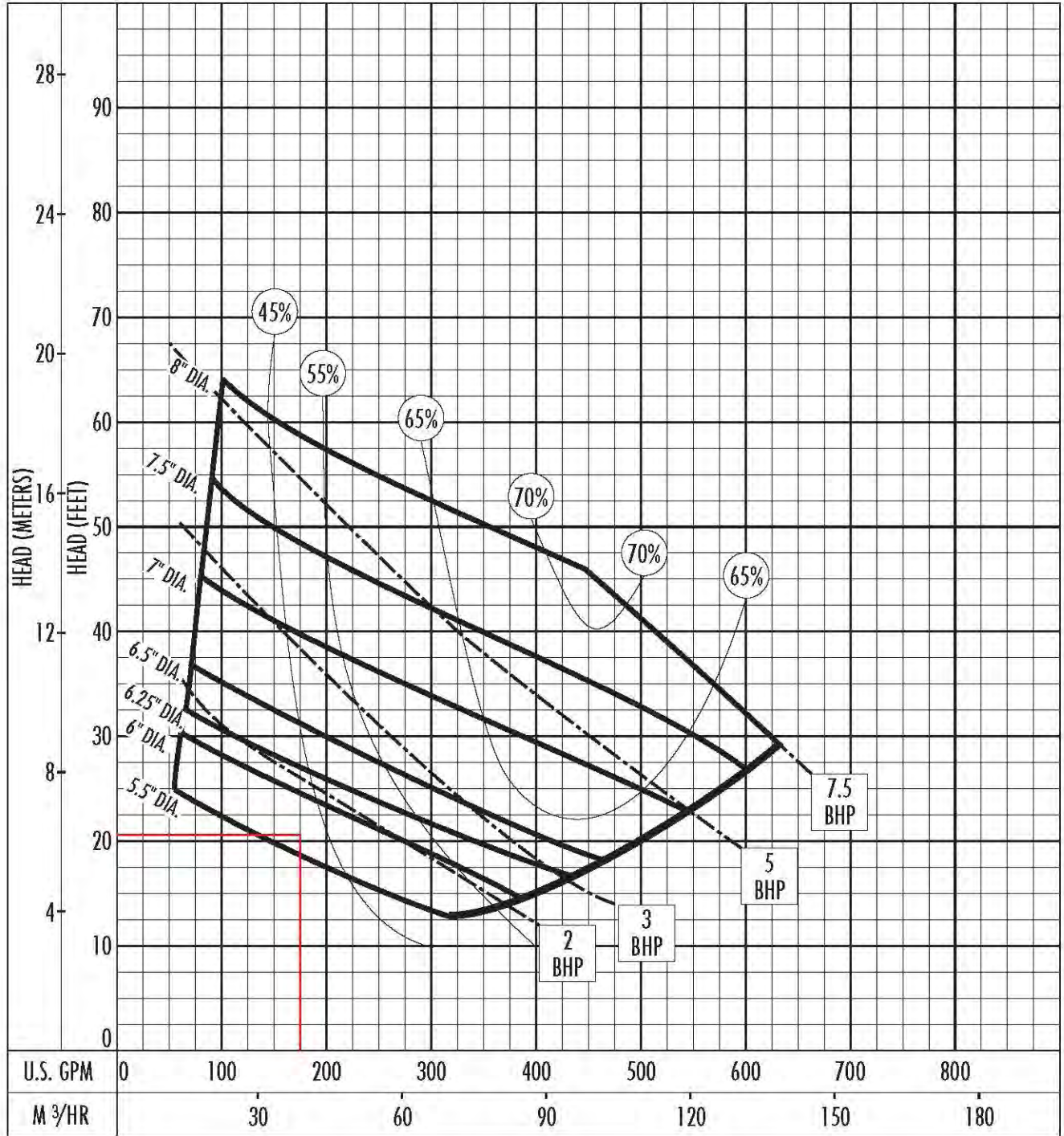

The curves reflect maximum performance characteristics without exceeding full load (Nameplate) horsepower. All pumps have a service factor of 1.2. Operation is recommended in the bounded area with operational point within the curve limit. Performance curves are based on actual tests with clear water at 70° F. and 1280 feet site elevation.

Conditions of Service:

ITEM #2

18AA RTU 484

PERFORMANCE CURVES

| | | | |
|----------------------|----------|----------------------|-----------------------------|
| 4-poles ; 1750 rpm | M | Enclosed | ② Type: AM434-150/2.9N (FM) |
| 4" Nominal discharge | | single-vane impeller | |
| 3" Solid size | | 60 Hz | |

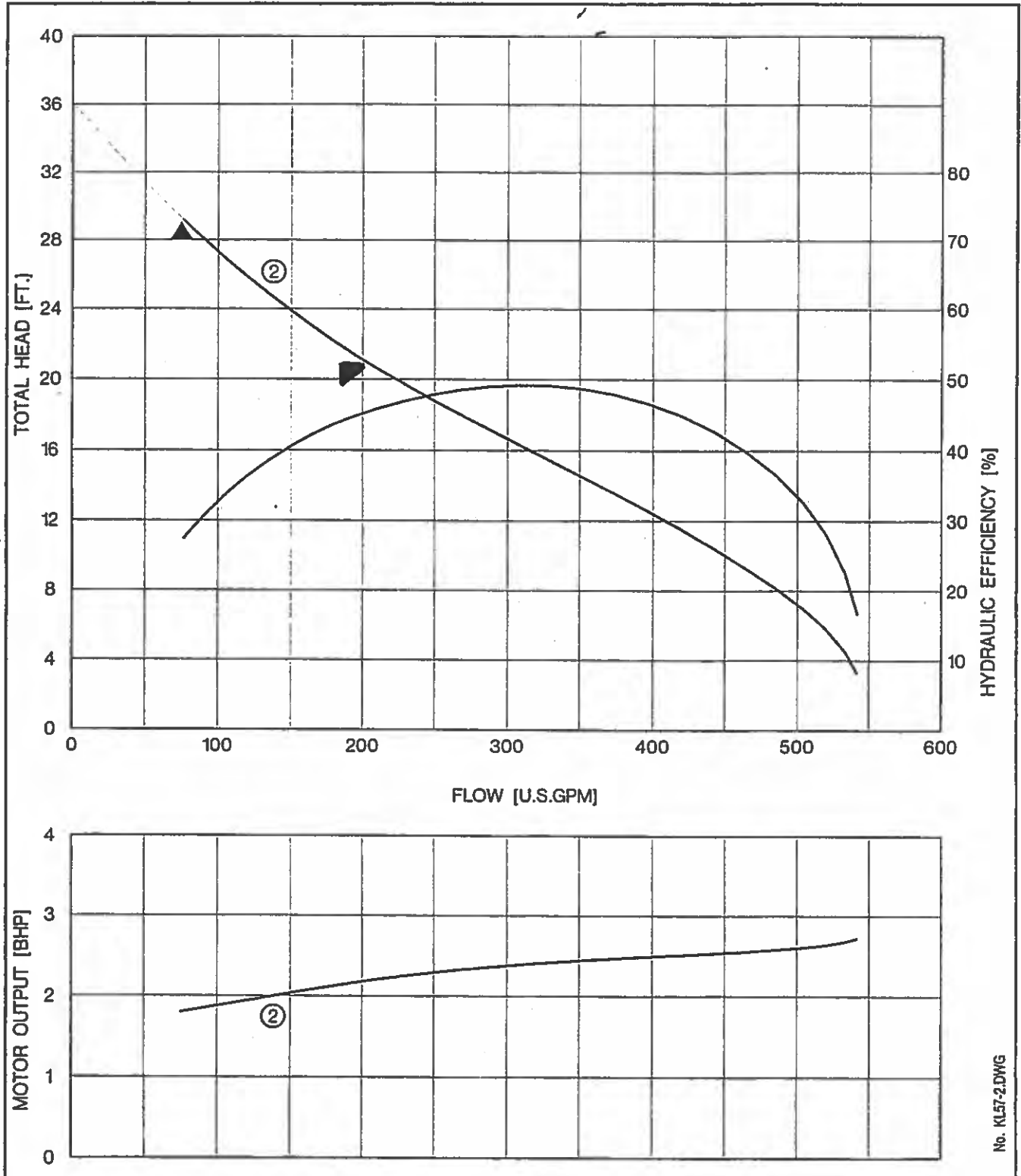

No. KL57-2.DWG

18-AB (485)

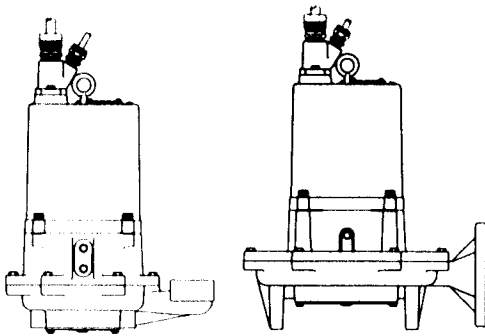

Performance Curve

HPGH/HPGHH

RPM: **3500**

Discharge: **2"**

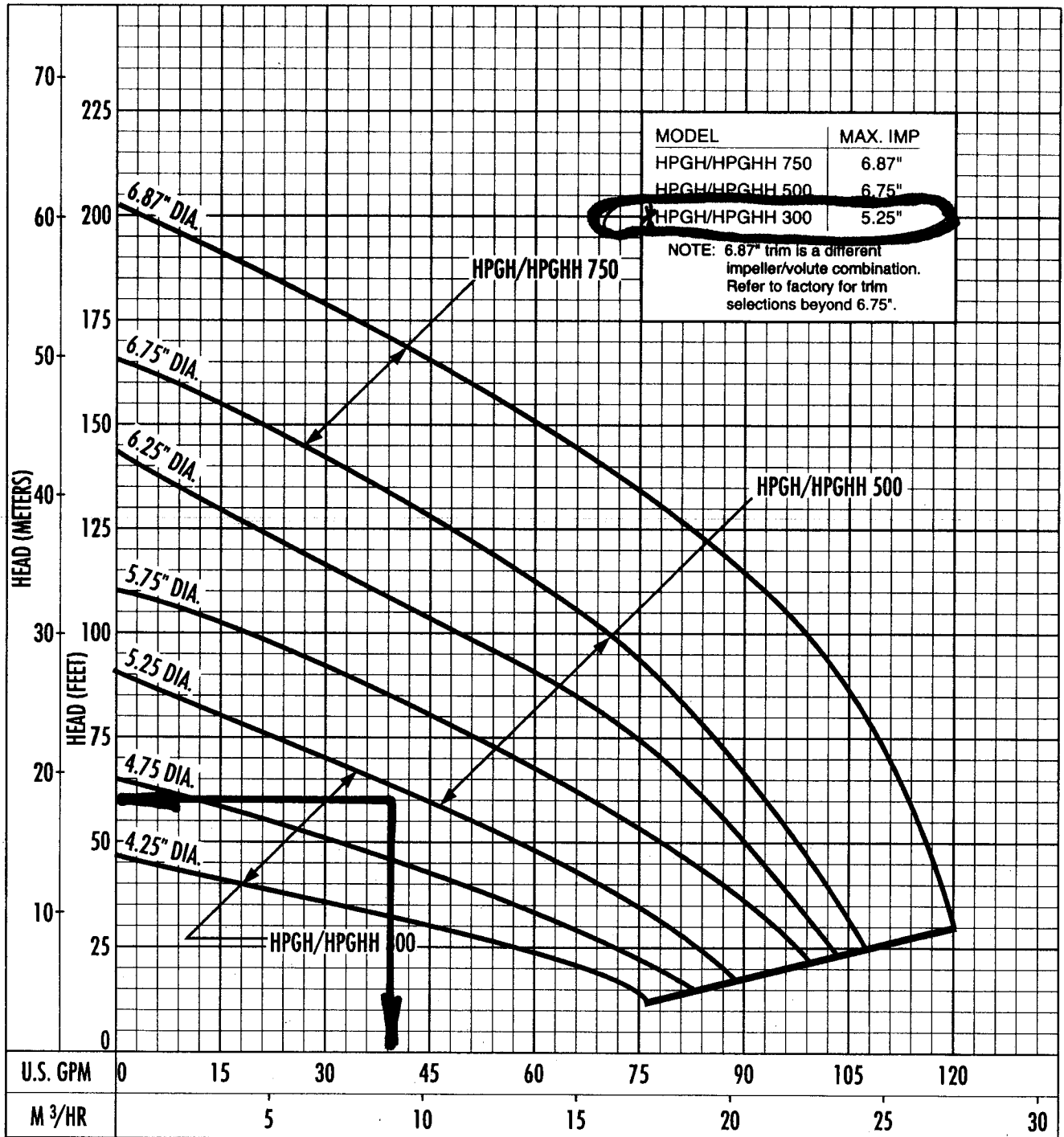

The curves reflect maximum performance characteristics without exceeding full load (Nameplate) horsepower. All pumps have a service factor of 1.2. Operation is recommended in the bounded area with operational point within the curve limit. Performance curves are based on actual tests with clear water at 70° F. and 1280 feet site elevation.

Conditions of Service:

GPM: _____ TDH: _____

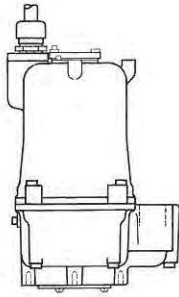

Lift Station 486

Performance Curve

SPG/SPGL

RPM: **3500** Discharge: **1-1/4"**

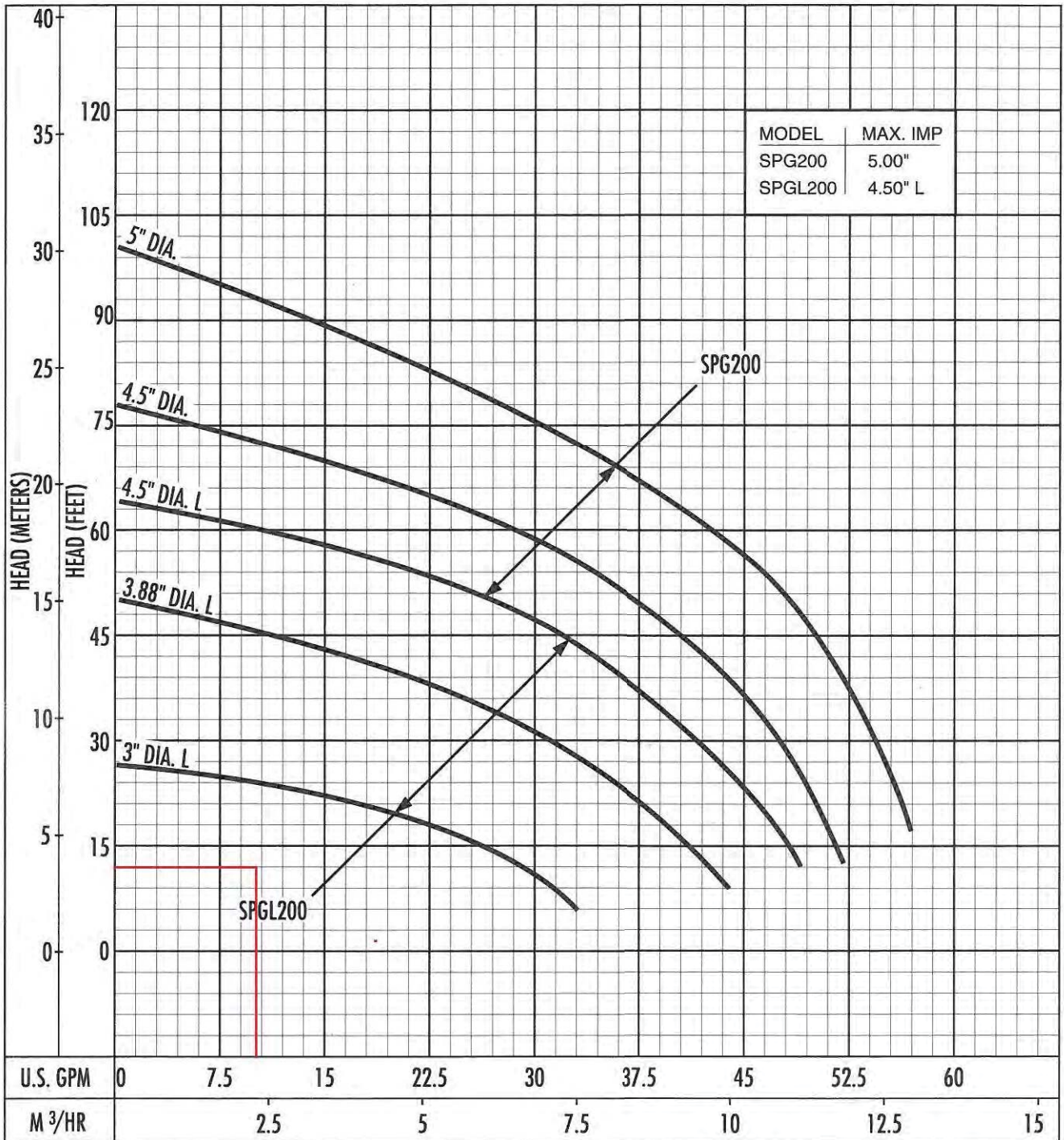

Operating point must fall within curve.

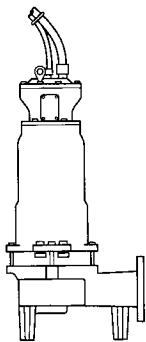

488

9-AA

5.69" Imp

Performance Curve

S4HRC/S4HVX

RPM: **3450** Discharge: **4"** Solids: **3"**

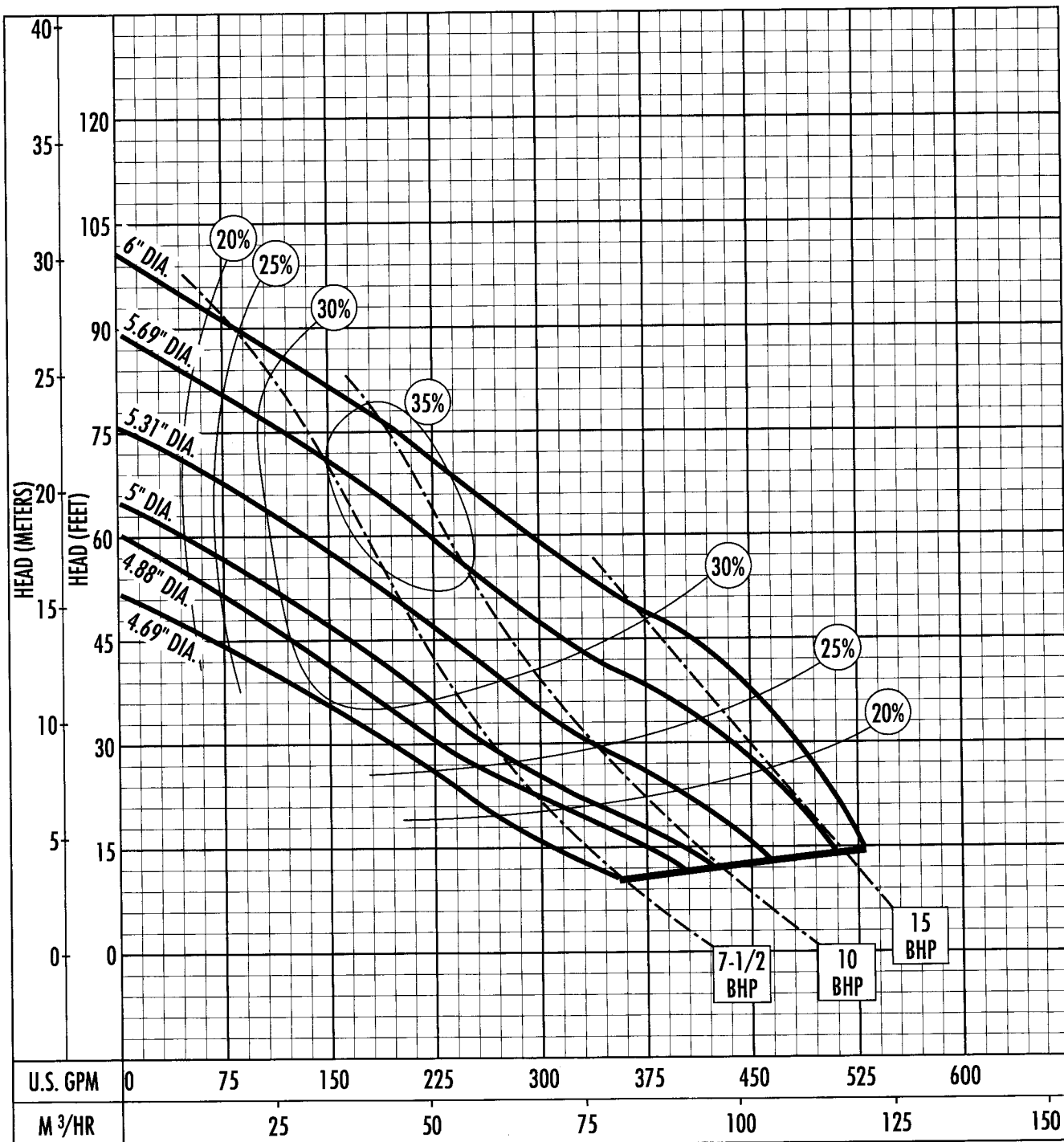

The curves reflect maximum performance characteristics without exceeding full load (Nameplate) horsepower. All pumps have a service factor of 1.2. Operation is recommended in the bounded area with operational point within the curve limit. Performance curves are based on actual tests with clear water at 70° F. and 1280 feet site elevation.

Conditions of Service:

GPM: _____ TDH: _____

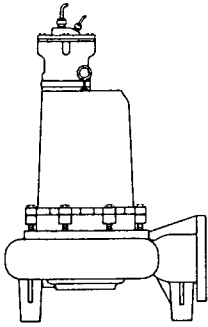

Performance Curve

S4P/S4PX

RPM: **1750** Discharge: **4"** Solids: **3"**

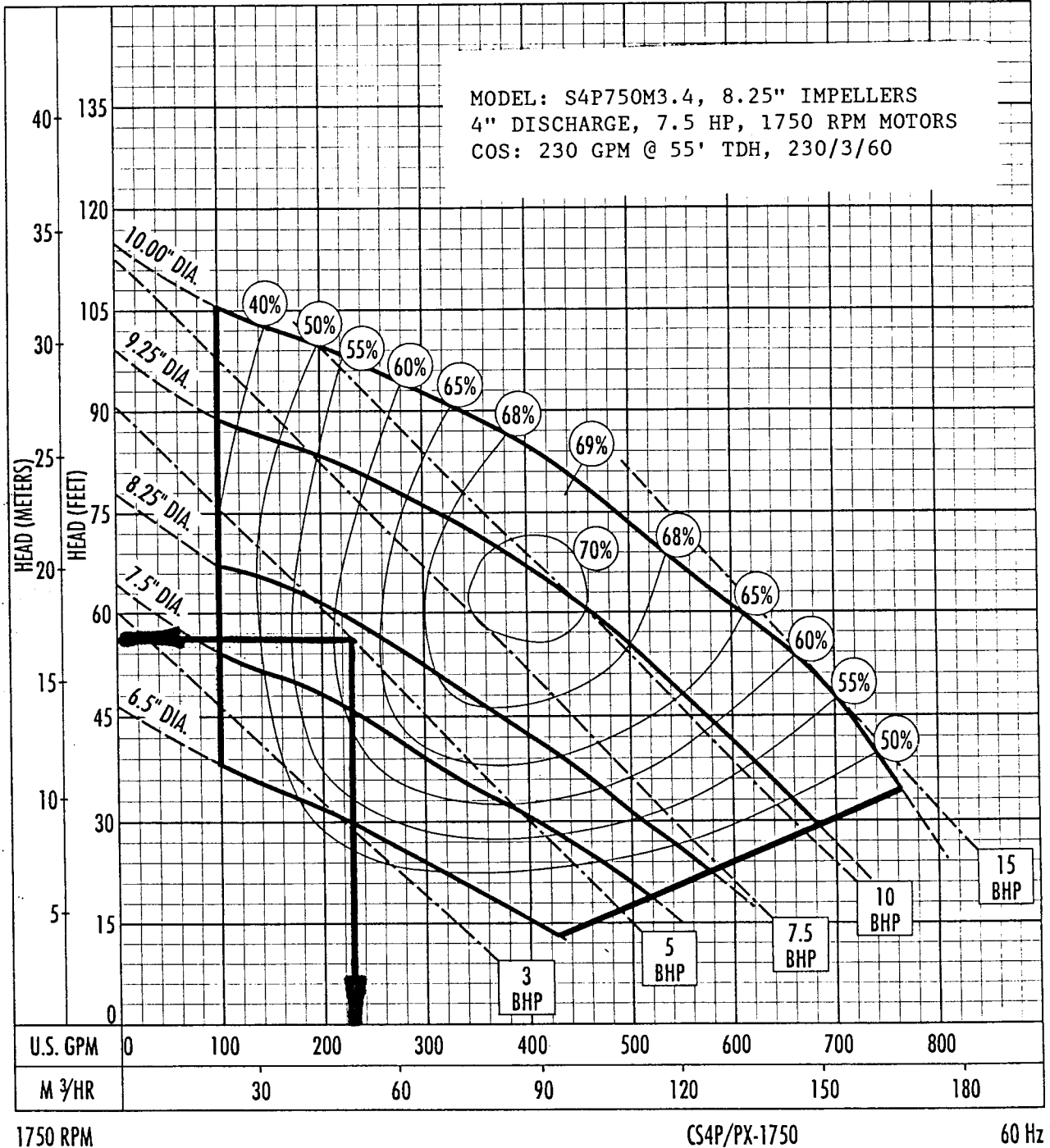

The curves reflect maximum performance characteristics without exceeding full load (Nameplate) horsepower. All pumps have a service factor of 1.2. Operation is recommended in the bounded area with operational point within the curve limit. Performance curves are based on actual tests with clear water at 70° F. and 1280 feet site elevation.

APPENDIX D – WET WELL EVALUATION FORMS

LIFT STATION FLOW CALCULATION WORKSHEET (Lift Stations with RTU)

DATE: ___/___/___ TIME: ___:___

LOCATION: BAYSHORE YACHT BASIN 101

WETWELL

VALVEBOX

* ALL MEASUREMENTS IN INCHES *

WETWELL DIAMETER 140

ON-LEVEL DEPTH (D1) 176

OFF LEVEL DEPTH (D2) 189

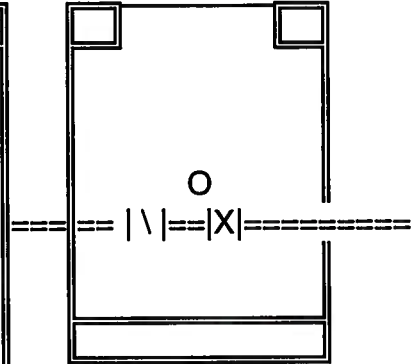
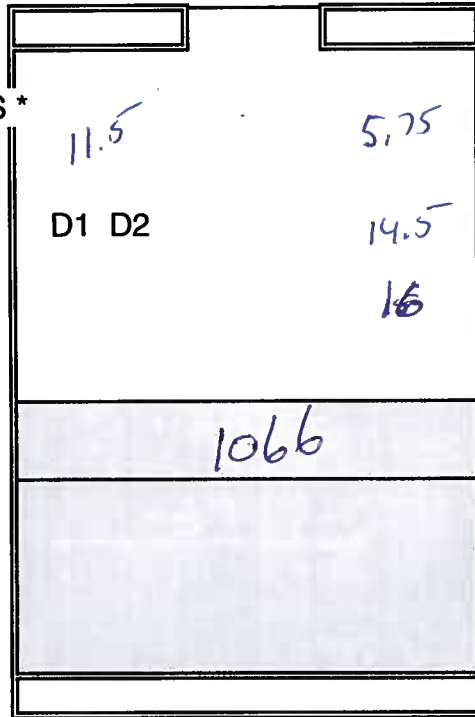

1. Measure the wet well diameter or rectangular size in inches.
2. When the pump turns on measure the distance from the top of the wet well to the sewage level (D)
3. When the pump turns off measure the distance from the top of the wet well to the sewage level (D)

Comments: _____

LIFT STATION FLOW CALCULATION WORKSHEET (Lift Stations with RTU)

DATE: ___/___/___ TIME: ___:___

LOCATION: Bay Drive 102

WETWELL

VALVEBOX

* ALL MEASUREMENTS IN INCHES *

WETWELL DIAMETER 44

ON-LEVEL DEPTH (D1) 101

OFF LEVEL DEPTH (D2) 117

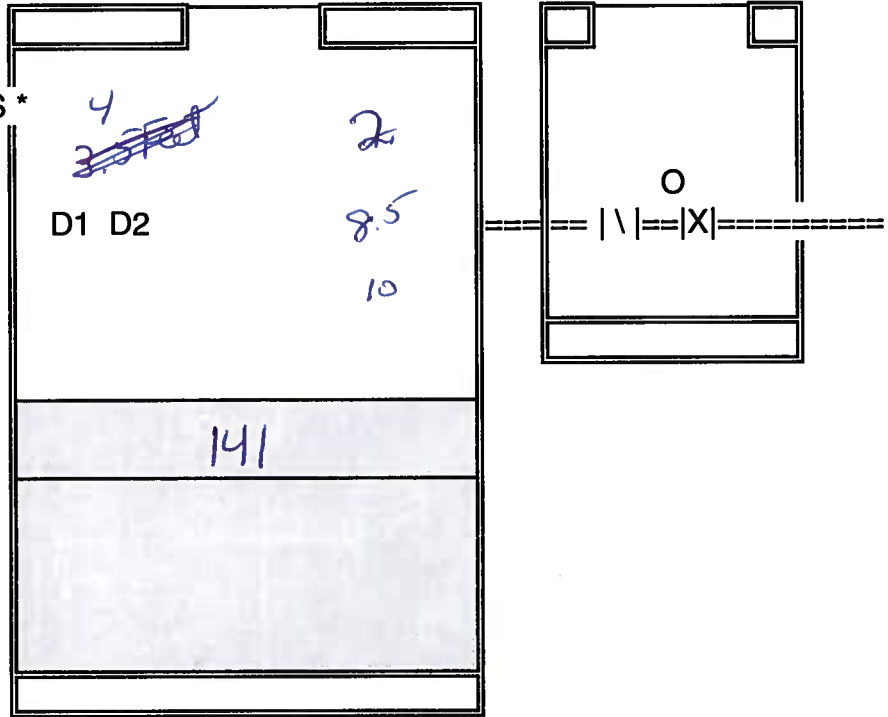

1. Measure the wet well diameter or rectangular size in inches.
2. When the pump turns on measure the distance from the top of the wet well to the sewage level (D)
3. When the pump turns off measure the distance from the top of the wet well to the sewage level (D)

Comments: _____

LIFT STATION FLOW CALCULATION WORKSHEET (Lift Stations with RTU)

DATE: ___/___/___ TIME: ___:___

LOCATION: EL CONQUISTADOR #2 103

WETWELL

VALVEBOX

* ALL MEASUREMENTS IN INCHES *

WETWELL DIAMETER 62

ON-LEVEL DEPTH (D1) 107

OFF LEVEL DEPTH (D2) 132

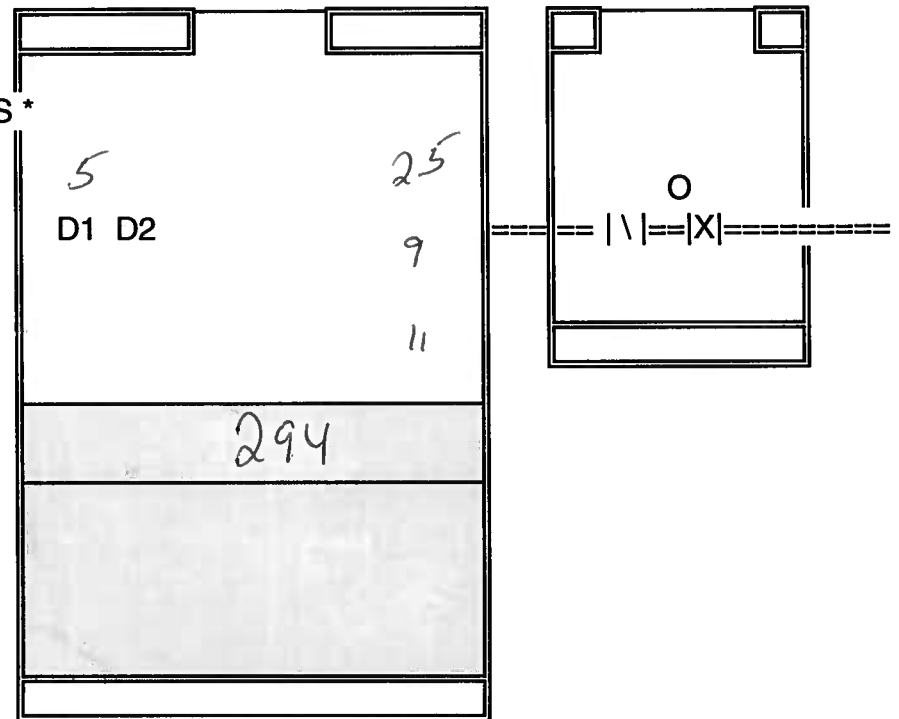

1. Measure the wet well diameter or rectangular size in inches.
2. When the pump turns on measure the distance from the top of the wet well to the sewage level (D1)
3. When the pump turns off measure the distance from the top of the wet well to the sewage level (D2)

Comments: _____

LIFT STATION FLOW CALCULATION WORKSHEET (Lift Stations with RTU)

DATE: ___/___/___ TIME: ___:___

LOCATION: EL CONAVISTADOR #1 104

WETWELL

VALVEBOX

* ALL MEASUREMENTS IN INCHES *

WETWELL DIAMETER 145 X 120

ON-LEVEL DEPTH (D1) 219

OFF LEVEL DEPTH (D2) 240

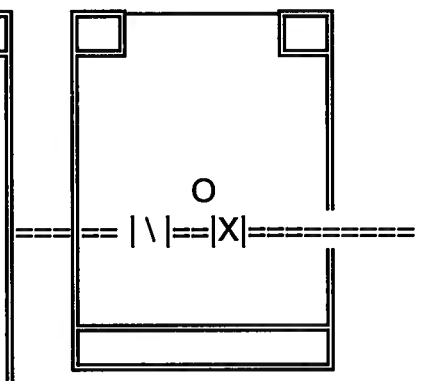
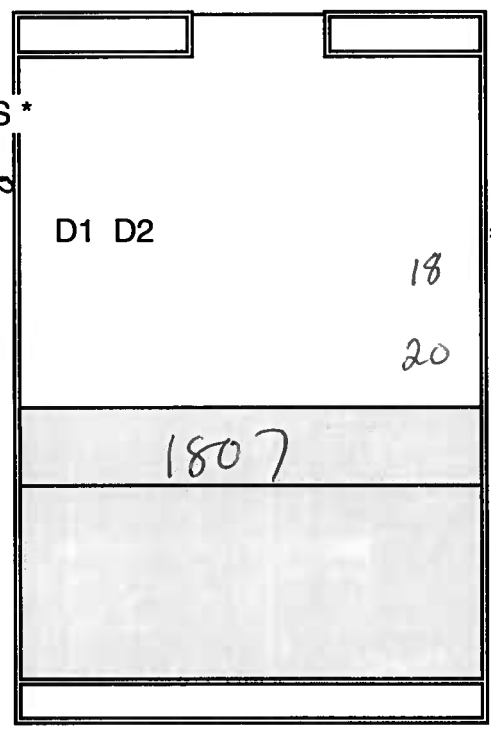

1. Measure the wet well diameter or rectangular size in inches.
2. When the pump turns on measure the distance from the top of the wet well to the sewage level (D)
3. When the pump turns off measure the distance from the top of the wet well to the sewage level (D)

Comments: _____

LIFT STATION FLOW CALCULATION WORKSHEET (Lift Stations with RTU)

DATE: ___/___/___ TIME: ___:___

LOCATION: WILD OAK BAY 105

WETWELL

VALVEBOX

* ALL MEASUREMENTS IN INCHES *

WETWELL DIAMETER 72

ON-LEVEL DEPTH (D1) 188

OFF LEVEL DEPTH (D2) 203

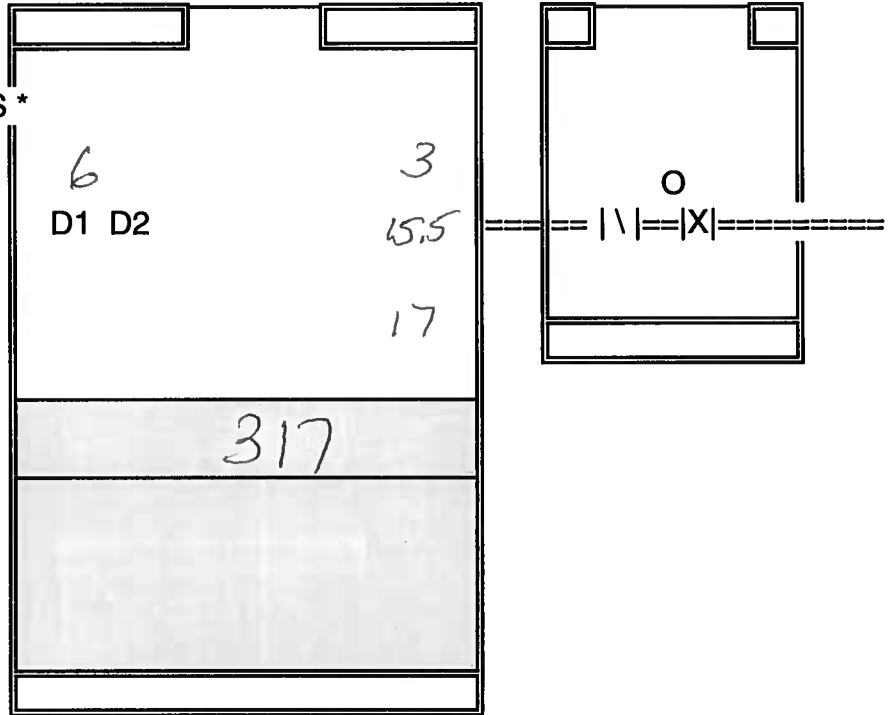

1. Measure the wet well diameter or rectangular size in inches.
2. When the pump turns on measure the distance from the top of the wet well to the sewage level (D)
3. When the pump turns off measure the distance from the top of the wet well to the sewage level (D)

Comments: _____

LIFT STATION FLOW CALCULATION WORKSHEET (Lift Stations with RTU)

DATE: ___/___/___ TIME: ___:___

LOCATION: VIVIENDA 106

WETWELL

VALVEBOX

* ALL MEASUREMENTS IN INCHES *

WETWELL DIAMETER 85

ON-LEVEL DEPTH (D1) 89

OFF LEVEL DEPTH (D2) 112

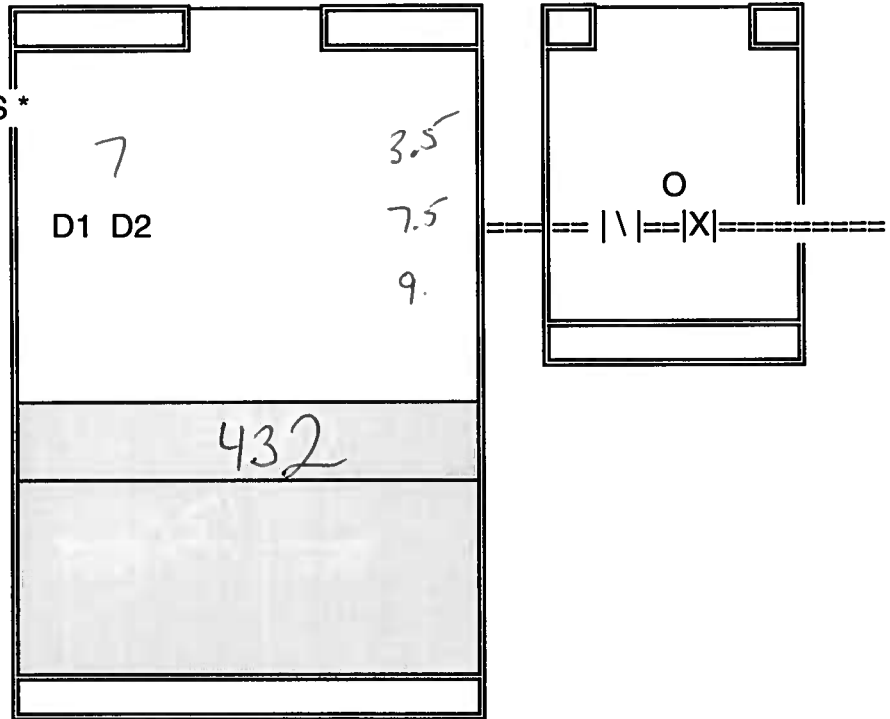

1. Measure the wet well diameter or rectangular size in inches.
2. When the pump turns on measure the distance from the top of the wet well to the sewage level (D)
3. When the pump turns off measure the distance from the top of the wet well to the sewage level (D)

Comments: _____

LIFT STATION FLOW CALCULATION WORKSHEET (Lift Stations with RTU)

DATE: ___/___/___ TIME: ___:___

LOCATION: MIRROR LAKE 107

WETWELL

VALVEBOX

* ALL MEASUREMENTS IN INCHES *

WETWELL DIAMETER 75

ON-LEVEL DEPTH (D1) 205

OFF LEVEL DEPTH (D2) 227

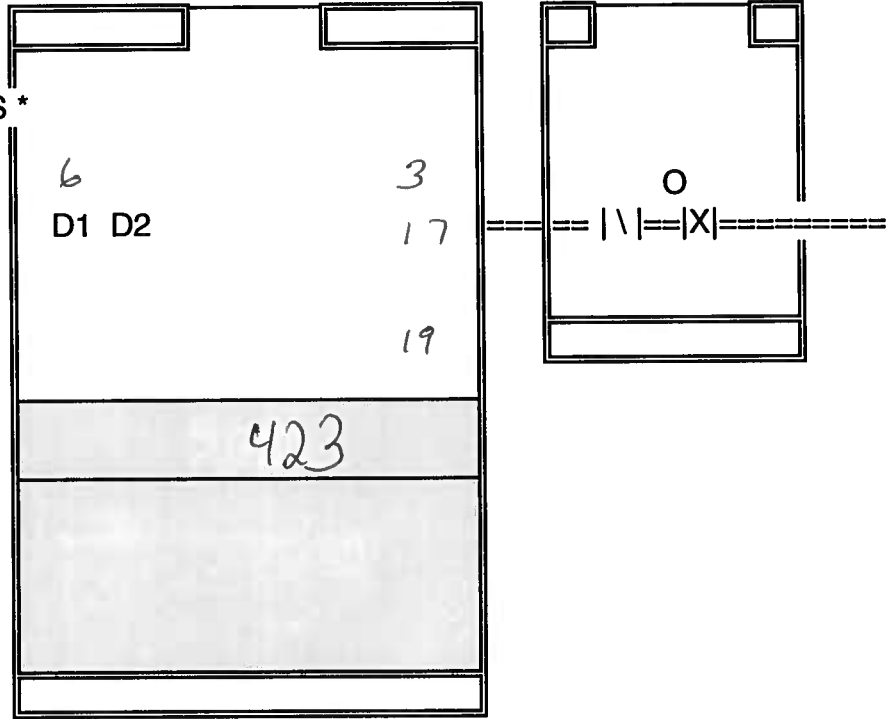

1. Measure the wet well diameter or rectangular size in inches.
2. When the pump turns on measure the distance from the top of the wet well to the sewage level (D)
3. When the pump turns off measure the distance from the top of the wet well to the sewage level (D)

Comments: _____

LIFT STATION FLOW CALCULATION WORKSHEET (Lift Stations with RTU)

DATE: ___/___/___ TIME: ___:___

LOCATION: LAKE BRIDGE 108

WETWELL

VALVEBOX

* ALL MEASUREMENTS IN INCHES *

WETWELL DIAMETER 63

ON-LEVEL DEPTH (D1) 153

OFF LEVEL DEPTH (D2) 167

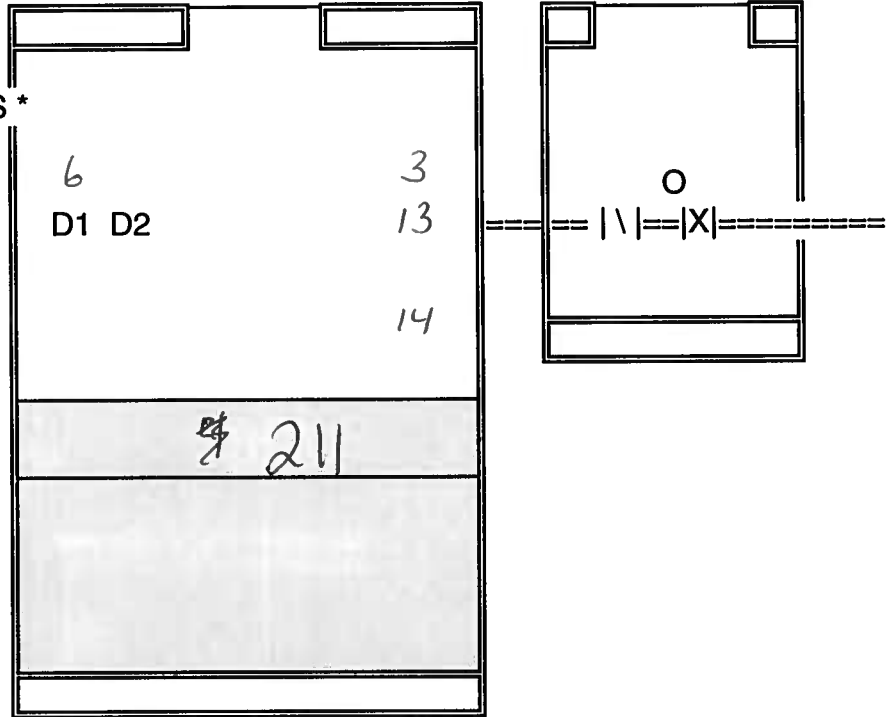

1. Measure the wet well diameter or rectangular size in inches.
2. When the pump turns on measure the distance from the top of the wet well to the sewage level (D)
3. When the pump turns off measure the distance from the top of the wet well to the sewage level (D)

Comments: _____

2019

LIFT STATION FLOW CALCULATION WORKSHEET (Lift Stations with RTU)

DATE: ___/___/___ TIME: ___:___

LOCATION: GLENN LAKE #2 109

WETWELL

VALVEBOX

* ALL MEASUREMENTS IN INCHES *

WETWELL DIAMETER 75

ON-LEVEL DEPTH (D1) 198

OFF LEVEL DEPTH (D2) 202

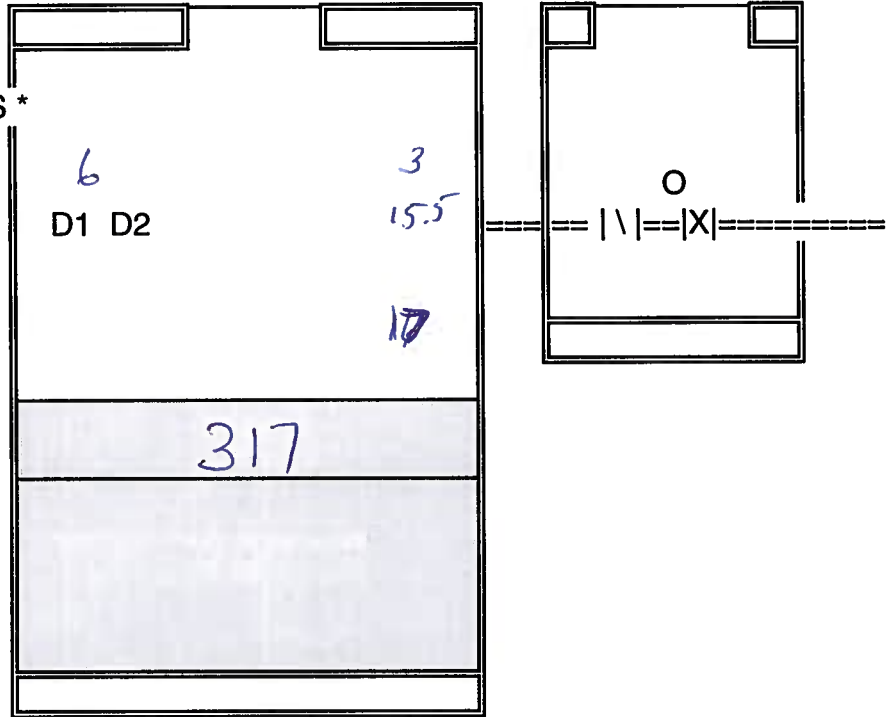

1. Measure the wet well diameter or rectangular size in inches.
2. When the pump turns on measure the distance from the top of the wet well to the sewage level (D)
3. When the pump turns off measure the distance from the top of the wet well to the sewage level (D)

Comments: _____

LIFT STATION FLOW CALCULATION WORKSHEET (Lift Stations with RTU)

DATE: ___/___/___ TIME: ___:___

LOCATION: *MORTON VILLAGE 110*

WETWELL

VALVEBOX

* ALL MEASUREMENTS IN INCHES *

WETWELL DIAMETER 72

ON-LEVEL DEPTH (D1) 177

OFF LEVEL DEPTH (D2) 186

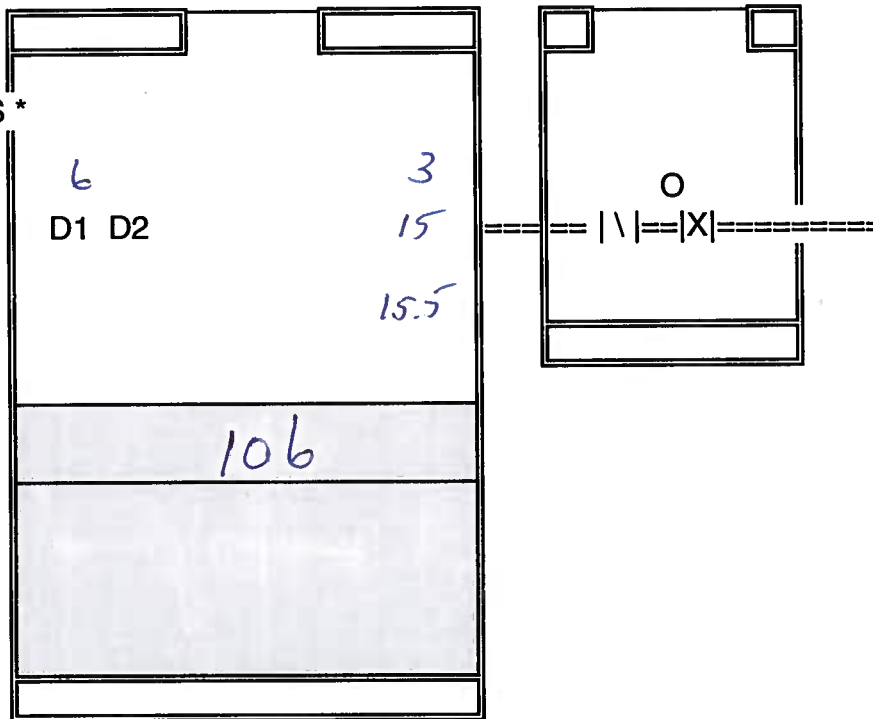

1. Measure the wet well diameter or rectangular size in inches.
2. When the pump turns on measure the distance from the top of the wet well to the sewage level (D)
3. When the pump turns off measure the distance from the top of the wet well to the sewage level (D)

Comments: _____

LIFT STATION FLOW CALCULATION WORKSHEET (Lift Stations with RTU)

DATE: ___/___/___ TIME: ___:___

LOCATION: VICTORIA SQUARE EAST 111

WETWELL

VALVEBOX

* ALL MEASUREMENTS IN INCHES *

WETWELL DIAMETER 49

ON-LEVEL DEPTH (D1) 77

OFF LEVEL DEPTH (D2) 90

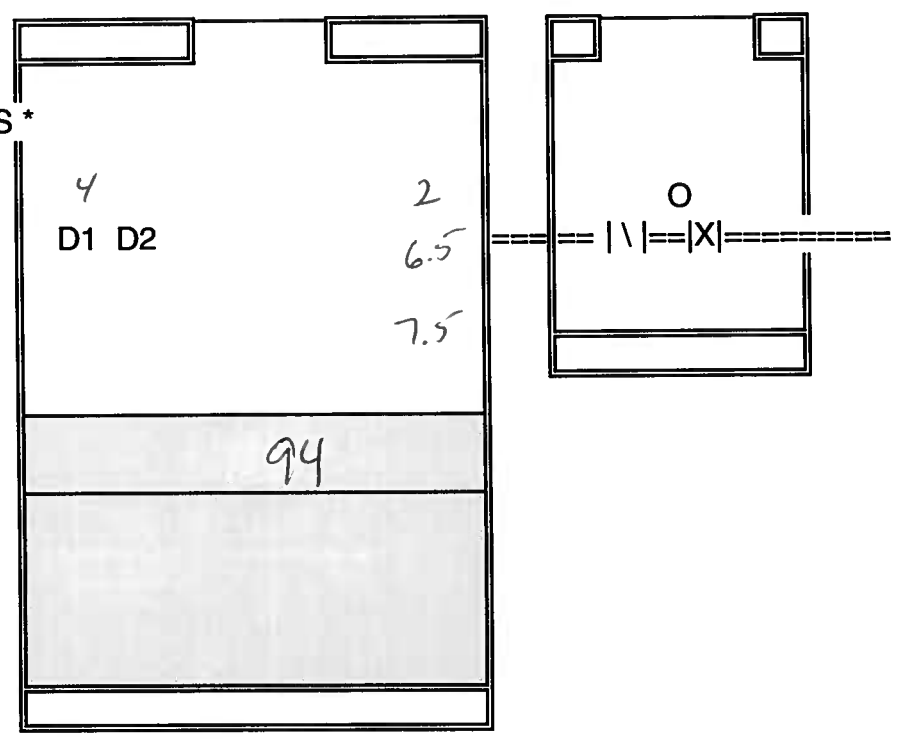

1. Measure the wet well diameter or rectangular size in inches.
2. When the pump turns on measure the distance from the top of the wet well to the sewage level (D)
3. When the pump turns off measure the distance from the top of the wet well to the sewage level (D)

Comments: _____

LIFT STATION FLOW CALCULATION WORKSHEET (Lift Stations with RTU)

DATE: ___/___/___ TIME: ___:___

LOCATION: *VICTORIA SQUARE WEST 112*

WETWELL

VALVEBOX

* ALL MEASUREMENTS IN INCHES *

WETWELL DIAMETER 53

ON-LEVEL DEPTH (D1) 116

OFF LEVEL DEPTH (D2) 134

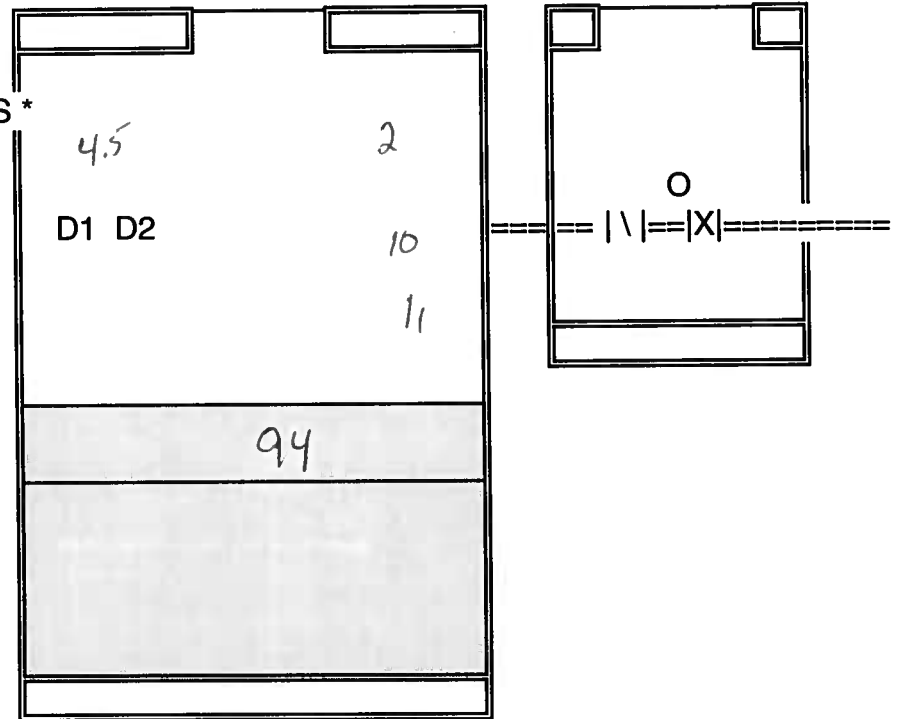

1. Measure the wet well diameter or rectangular size in inches.
2. When the pump turns on measure the distance from the top of the wet well to the sewage level (D)
3. When the pump turns off measure the distance from the top of the wet well to the sewage level (D)

Comments: _____

LIFT STATION FLOW CALCULATION WORKSHEET (Lift Stations with RTU)

DATE: ___/___/___ TIME: ___:___

LOCATION: COLLEGE PLAZA 113

WETWELL

VALVEBOX

* ALL MEASUREMENTS IN INCHES *

WETWELL DIAMETER 82

ON-LEVEL DEPTH (D1) 116

OFF LEVEL DEPTH (D2) 137

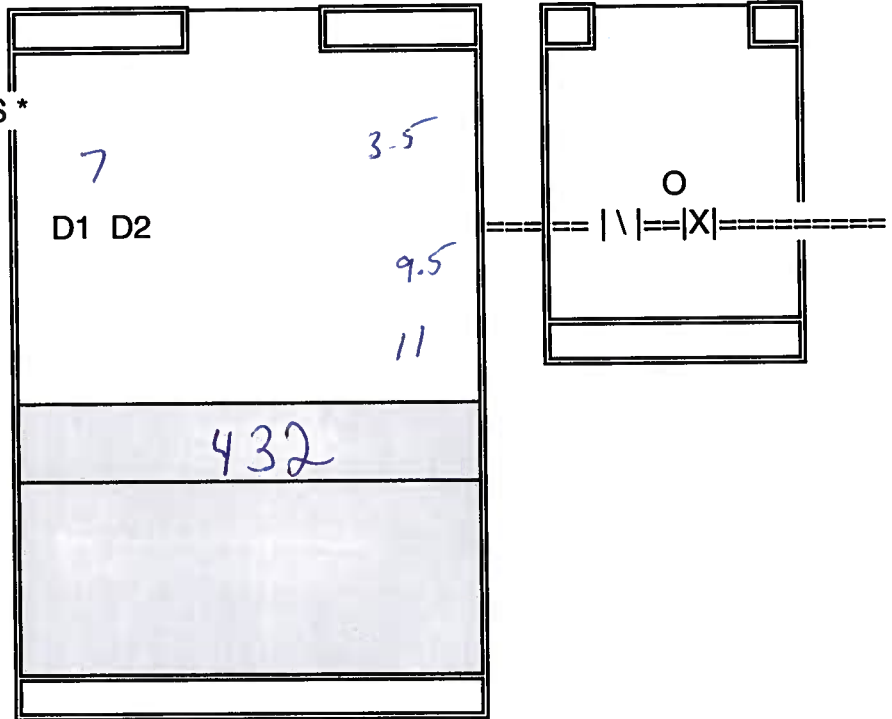

1. Measure the wet well diameter or rectangular size in inches.
2. When the pump turns on measure the distance from the top of the wet well to the sewage level (D1)
3. When the pump turns off measure the distance from the top of the wet well to the sewage level (D2)

Comments: _____

LIFT STATION FLOW CALCULATION WORKSHEET (Lift Stations with RTU)

DATE: ___/___/___ TIME: ___:___

LOCATION: WILDWOOD SPRINGS #1 114

WETWELL

VALVEBOX

* ALL MEASUREMENTS IN INCHES *

WETWELL DIAMETER 69

ON-LEVEL DEPTH (D1) 152

OFF LEVEL DEPTH (D2) 179

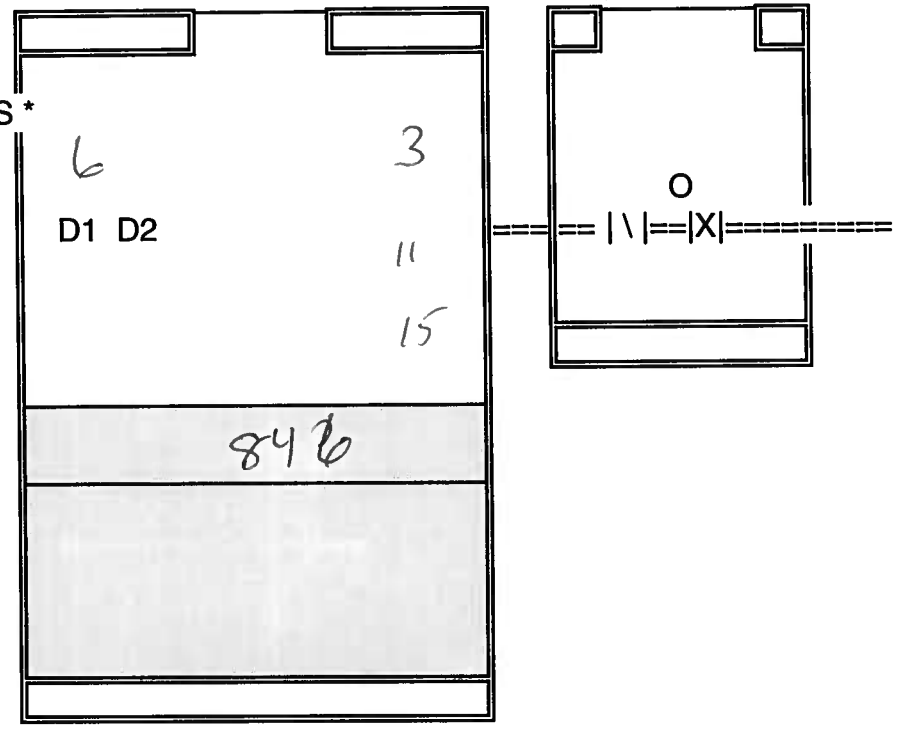

1. Measure the wet well diameter or rectangular size in inches.
2. When the pump turns on measure the distance from the top of the wet well to the sewage level (D
3. When the pump turns off measure the distance from the top of the wet well to the sewage level (D

Comments: _____

LIFT STATION FLOW CALCULATION WORKSHEET (Lift Stations with RTU)

DATE: ___/___/___ TIME: ___:___

LOCATION: WILDWOOD SPRINGS #2 115

WETWELL

VALVEBOX

* ALL MEASUREMENTS IN INCHES *

WETWELL DIAMETER 72

ON-LEVEL DEPTH (D1) 170

OFF LEVEL DEPTH (D2) 211

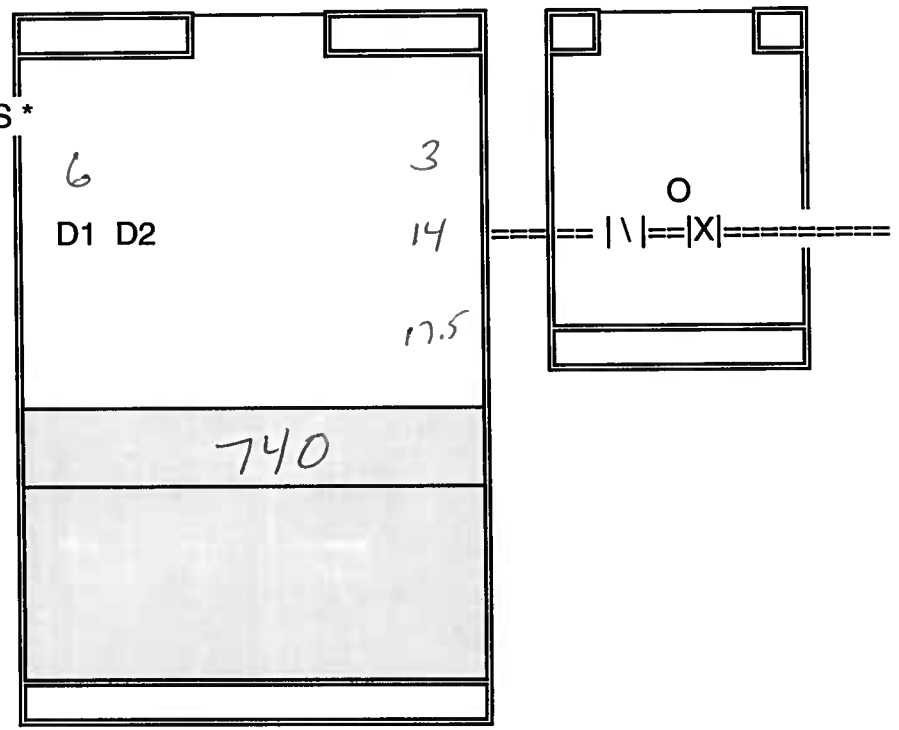

1. Measure the wet well diameter or rectangular size in inches.
2. When the pump turns on measure the distance from the top of the wet well to the sewage level (D
3. When the pump turns off measure the distance from the top of the wet well to the sewage level (D

Comments: _____

LIFT STATION FLOW CALCULATION WORKSHEET (Lift Stations with RTU)

18-M

DATE: 3/20/15 TIME: _____

LOCATION: L.S. 116

WETWELL

VALVEBOX

* ALL MEASUREMENTS IN INCHES *

WETWELL DIAMETER 72"

ON-LEVEL DEPTH (D1) 246"
20' =

OFF LEVEL DEPTH (D2) 264"
22' =

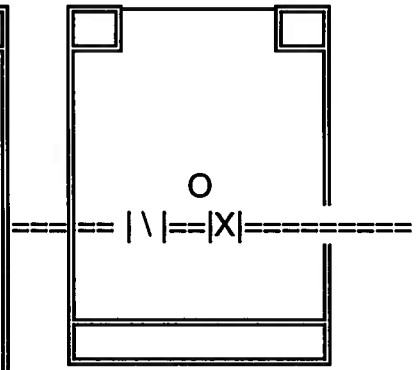
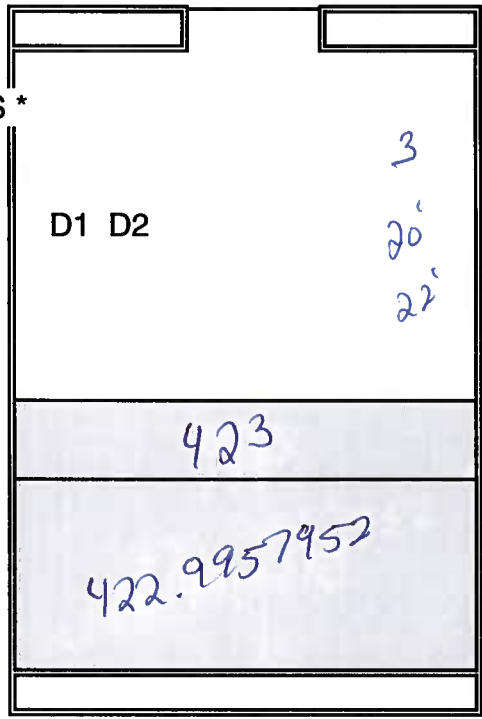

1. Measure the wet well diameter or rectangular size in inches.
2. When the pump turns on measure the distance from the top of the wet well to the sewage level (D1)
3. When the pump turns off measure the distance from the top of the wet well to the sewage level (D2)

Comments: _____

LIFT STATION FLOW CALCULATION WORKSHEET (Lift Stations with RTU)

M.C.U.O.P.

DATE: 3/20/15 TIME: _____

LOCATION: L.S. 117

WETWELL

VALVEBOX

* ALL MEASUREMENTS IN INCHES *

WETWELL DIAMETER 48"

ON-LEVEL DEPTH (D1) 96"
8' =

OFF LEVEL DEPTH (D2) 114"
9'-6" =

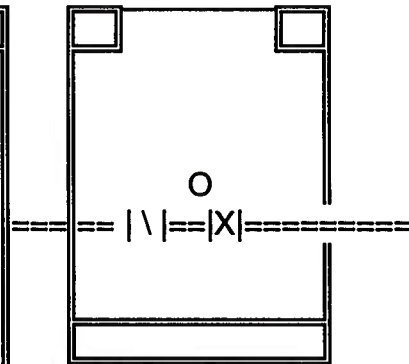
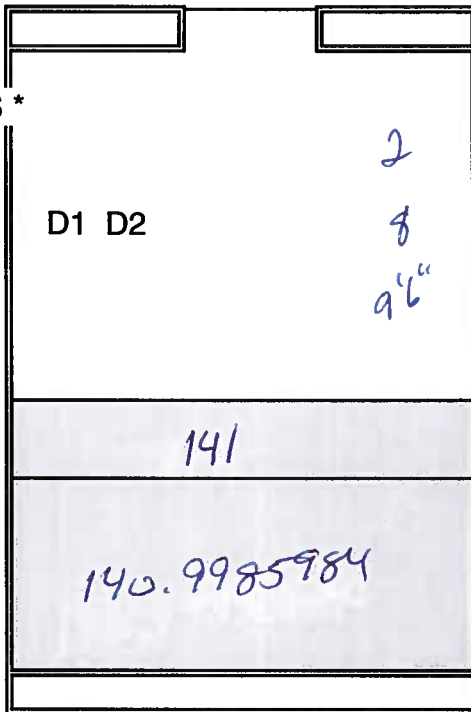

1. Measure the wet well diameter or rectangular size in inches.
2. When the pump turns on measure the distance from the top of the wet well to the sewage level (D)
3. When the pump turns off measure the distance from the top of the wet well to the sewage level (D)

Comments: _____

2118

LIFT STATION FLOW CALCULATION WORKSHEET (Lift Stations with RTU)

DORAYE VICCAS

DATE: 3/20/15 TIME: _____:

LOCATION: L.S. 118

WETWELL

VALVEBOX

* ALL MEASUREMENTS IN INCHES *

WETWELL DIAMETER 72"

ON-LEVEL DEPTH (D1) 132"

OFF LEVEL DEPTH (D2) 150"

12'-6" =

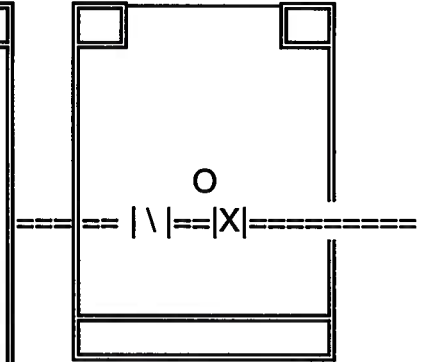
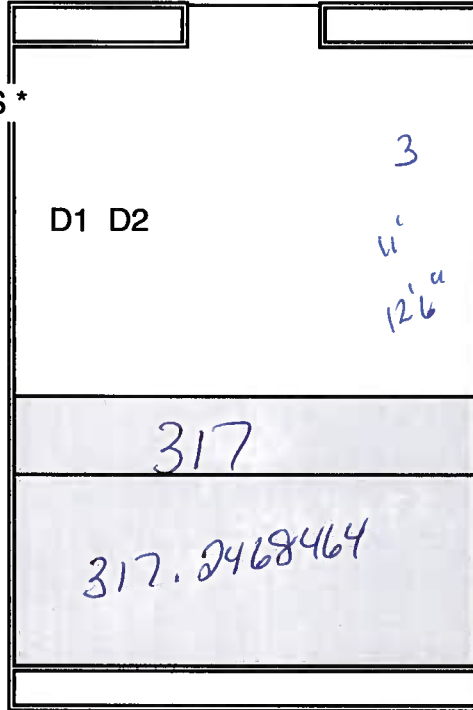

1. Measure the wet well diameter or rectangular size in inches.
2. When the pump turns on measure the distance from the top of the wet well to the sewage level (D1)
3. When the pump turns off measure the distance from the top of the wet well to the sewage level (D2)

Comments: _____

LIFT STATION FLOW CALCULATION WORKSHEET (Lift Stations with RTU)

DATE: ___/___/___ TIME: ___:___

LOCATION: GLENN LAKES #1 119

WETWELL

VALVEBOX

* ALL MEASUREMENTS IN INCHES *

WETWELL DIAMETER 65

ON-LEVEL DEPTH (D1) 259

OFF LEVEL DEPTH (D2) 283

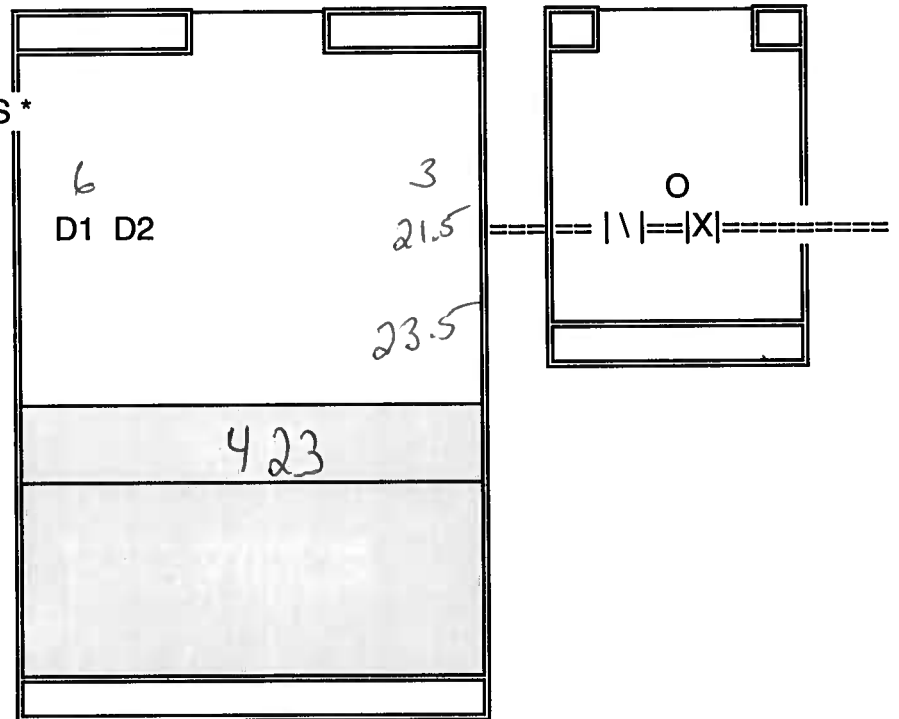

1. Measure the wet well diameter or rectangular size in inches.
2. When the pump turns on measure the distance from the top of the wet well to the sewage level (D1)
3. When the pump turns off measure the distance from the top of the wet well to the sewage level (D2)

Comments: _____

2170

LIFT STATION FLOW CALCULATION WORKSHEET (Lift Stations with RTU)

CORAL SHORES WEST

DATE: 3/24/15 TIME: _____:

LOCATION: L.S. 120

WETWELL

VALVEBOX

* ALL MEASUREMENTS IN INCHES *

WETWELL DIAMETER 72"

ON-LEVEL DEPTH (D1) 204"
17'

OFF LEVEL DEPTH (D2) 222"
18'-6"

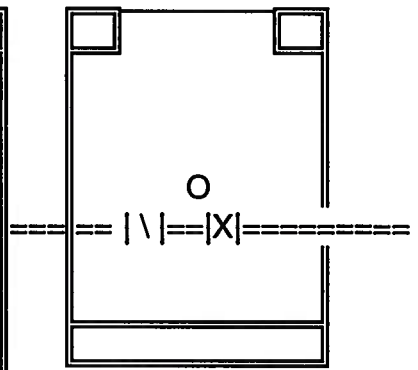
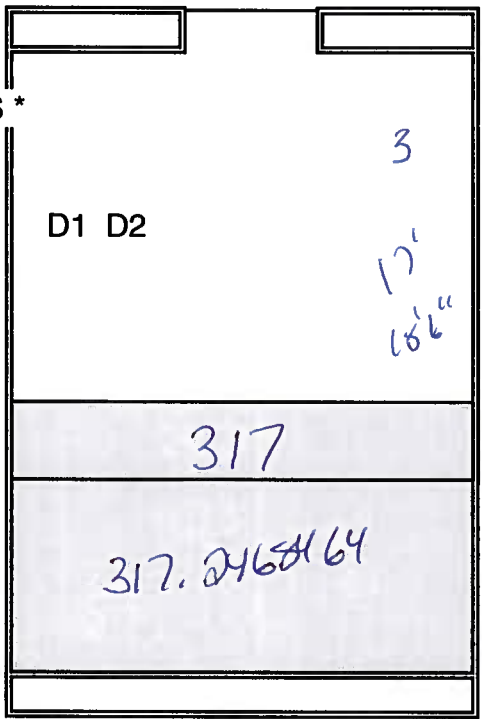

1. Measure the wet well diameter or rectangular size in inches.
2. When the pump turns on measure the distance from the top of the wet well to the sewage level (D)
3. When the pump turns off measure the distance from the top of the wet well to the sewage level (D)

Comments: _____

2121

LIFT STATION FLOW CALCULATION WORKSHEET (Lift Stations with RTU)

CORAL SHORES EAST 3

DATE: 3/24/15 TIME: _____:

LOCATION: L.S. 121

WETWELL

VALVEBOX

* ALL MEASUREMENTS IN INCHES *

WETWELL DIAMETER 60"

ON-LEVEL DEPTH (D1) 126"

10'-6"

OFF LEVEL DEPTH (D2) 144"

12'

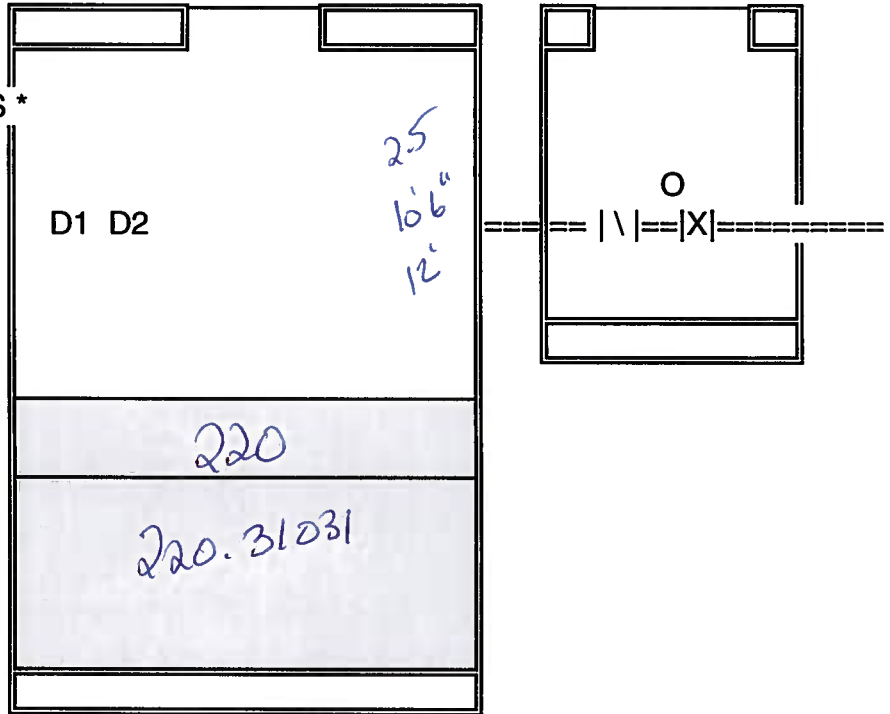

1. Measure the wet well diameter or rectangular size in inches.
2. When the pump turns on measure the distance from the top of the wet well to the sewage level (D)
3. When the pump turns off measure the distance from the top of the wet well to the sewage level (D)

Comments: _____

LIFT STATION FLOW CALCULATION WORKSHEET (Lift Stations with RTU)

CORAL SHORES EAST 4

DATE: 3 / 24 / 15 TIME: _____

LOCATION: L.S. 122

WETWELL

VALVEBOX

* ALL MEASUREMENTS IN INCHES *

WETWELL DIAMETER 60"

ON-LEVEL DEPTH (D1) 198"
16'-6" =

OFF LEVEL DEPTH (D2) 216"
18' =

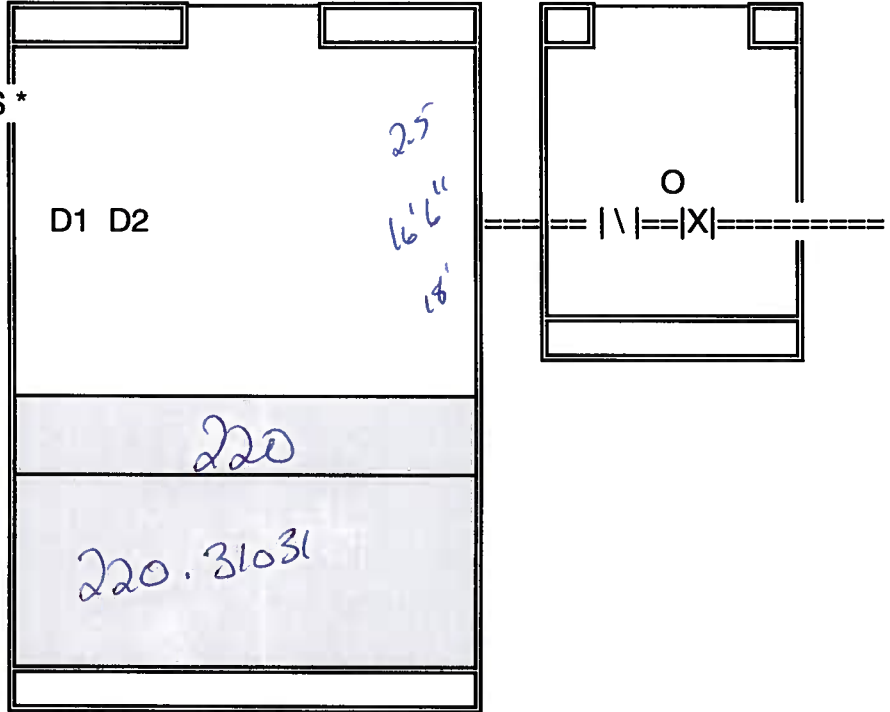

1. Measure the wet well diameter or rectangular size in inches.
2. When the pump turns on measure the distance from the top of the wet well to the sewage level (D
3. When the pump turns off measure the distance from the top of the wet well to the sewage level (D

Comments: _____

2125

LIFT STATION FLOW CALCULATION WORKSHEET (Lift Stations with RTU)

DATE: ___/___/___ TIME: ___:___

LOCATION: 30-A 125

WETWELL

VALVEBOX

* ALL MEASUREMENTS IN INCHES *

WETWELL DIAMETER 88

ON-LEVEL DEPTH (D1) 186

OFF LEVEL DEPTH (D2) 202

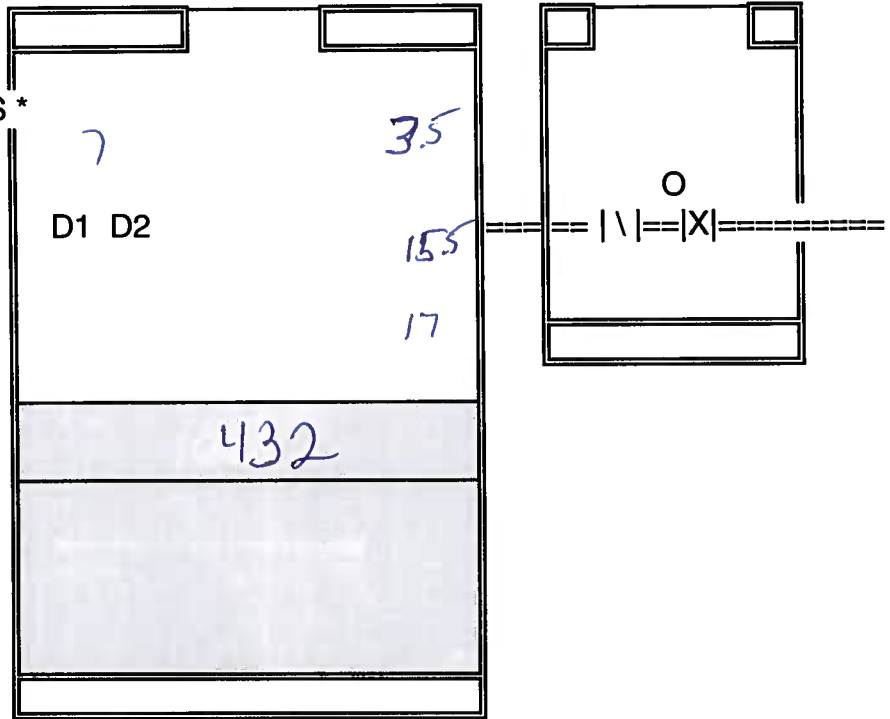

1. Measure the wet well diameter or rectangular size in inches.
2. When the pump turns on measure the distance from the top of the wet well to the sewage level (D1)
3. When the pump turns off measure the distance from the top of the wet well to the sewage level (D2)

Comments: _____

LIFT STATION FLOW CALCULATION WORKSHEET (Lift Stations with RTU)

DATE: ___/___/___ TIME: ___:___

LOCATION: TRINITY BAPTIST CHURCH
128

WETWELL

VALVEBOX

* ALL MEASUREMENTS IN INCHES *

WETWELL DIAMETER 48

ON-LEVEL DEPTH (D1) 81

OFF LEVEL DEPTH (D2) 106

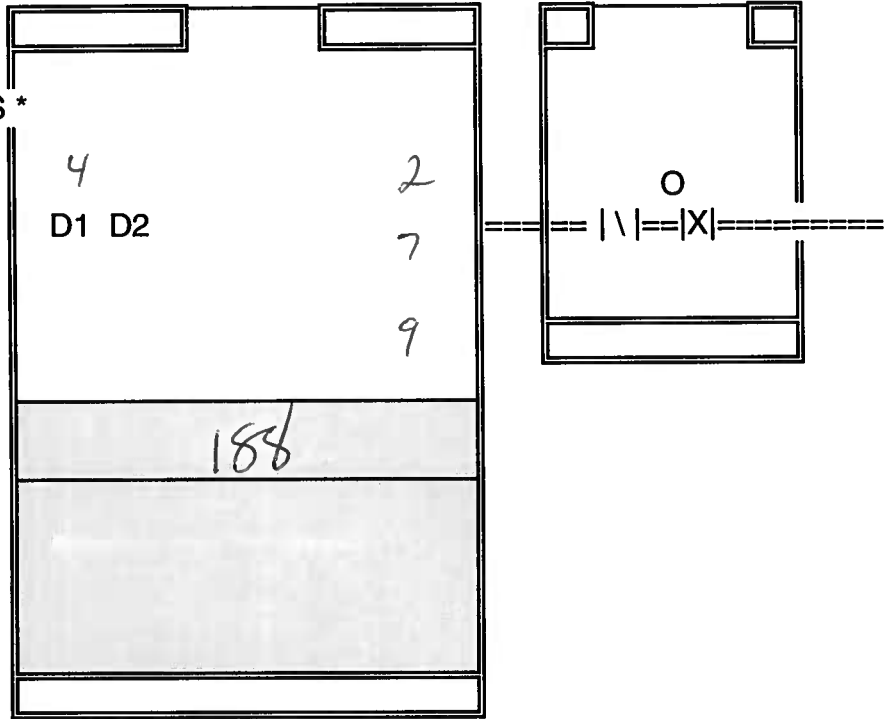

1. Measure the wet well diameter or rectangular size in inches.
2. When the pump turns on measure the distance from the top of the wet well to the sewage level (D)
3. When the pump turns off measure the distance from the top of the wet well to the sewage level (D)

Comments: _____

LIFT STATION FLOW CALCULATION WORKSHEET (Lift Stations with RTU)

DATE: ___/___/___ TIME: ___:___

LOCATION: FIVE LAKES 140

WETWELL

VALVEBOX

* ALL MEASUREMENTS IN INCHES *

WETWELL DIAMETER 72

ON-LEVEL DEPTH (D1) 159

OFF LEVEL DEPTH (D2) 174

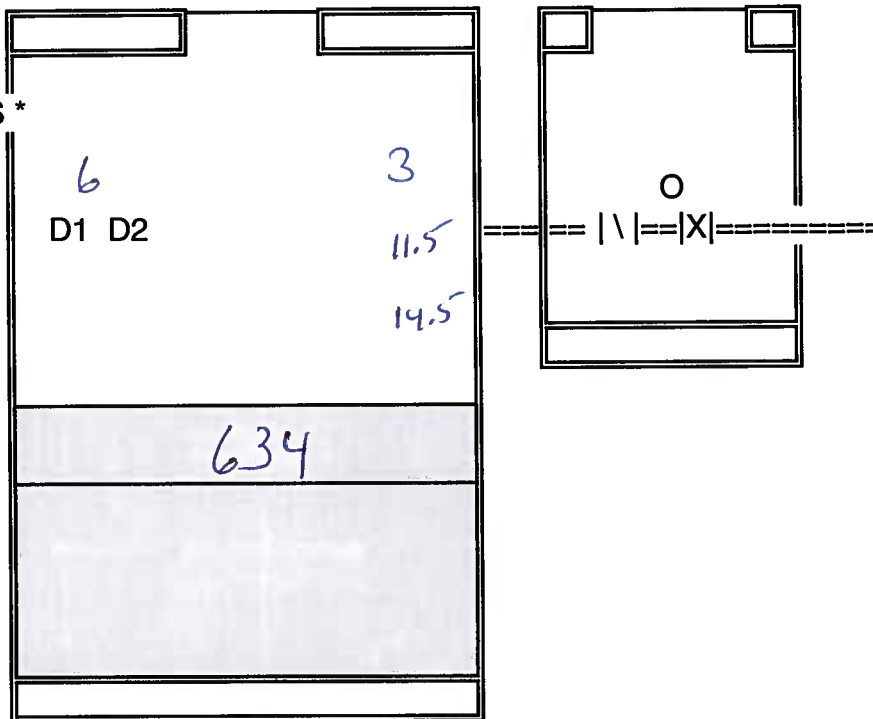

1. Measure the wet well diameter or rectangular size in inches.
2. When the pump turns on measure the distance from the top of the wet well to the sewage level (D)
3. When the pump turns off measure the distance from the top of the wet well to the sewage level (D)

Comments: _____

LIFT STATION FLOW CALCULATION WORKSHEET (Lift Stations with RTU)

DATE: ___/___/___ TIME: ___:___

LOCATION: VIZCAYA 141

WETWELL

VALVEBOX

* ALL MEASUREMENTS IN INCHES *

WETWELL DIAMETER 73

ON-LEVEL DEPTH (D1) ~~186~~ 169

OFF LEVEL DEPTH (D2) 186

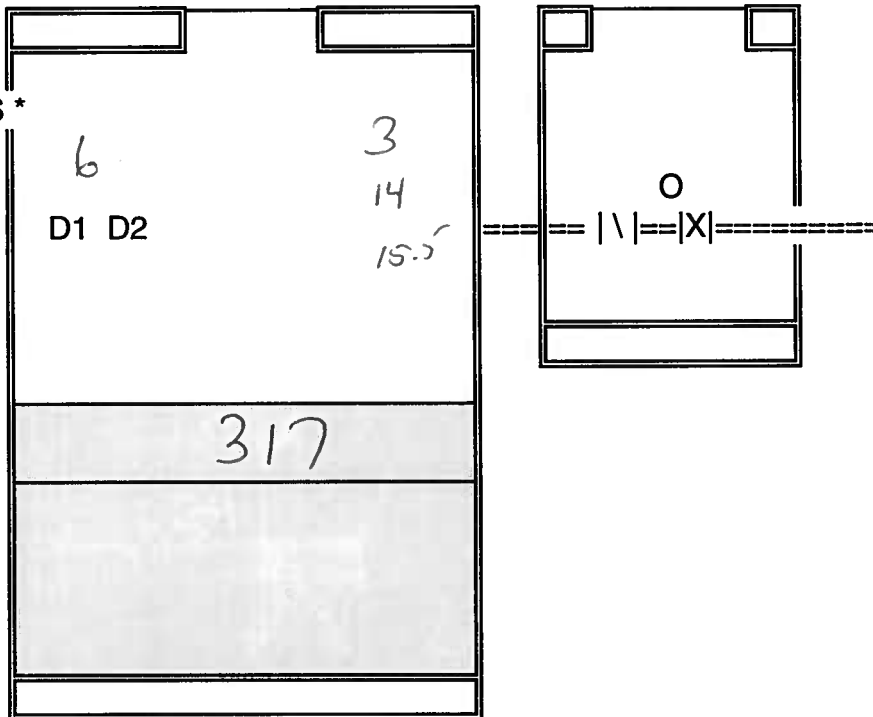

1. Measure the wet well diameter or rectangular size in inches.
2. When the pump turns on measure the distance from the top of the wet well to the sewage level (D)
3. When the pump turns off measure the distance from the top of the wet well to the sewage level (D)

Comments: _____

2142

LIFT STATION FLOW CALCULATION WORKSHEET (Lift Stations with RTU)

DATE: ___/___/___ TIME: ___:___

LOCATION: CORTEZ COMMERCIAL CENTER
142

WETWELL

VALVEBOX

* ALL MEASUREMENTS IN INCHES *

WETWELL DIAMETER 72

ON-LEVEL DEPTH (D1) 116

OFF LEVEL DEPTH (D2) 134

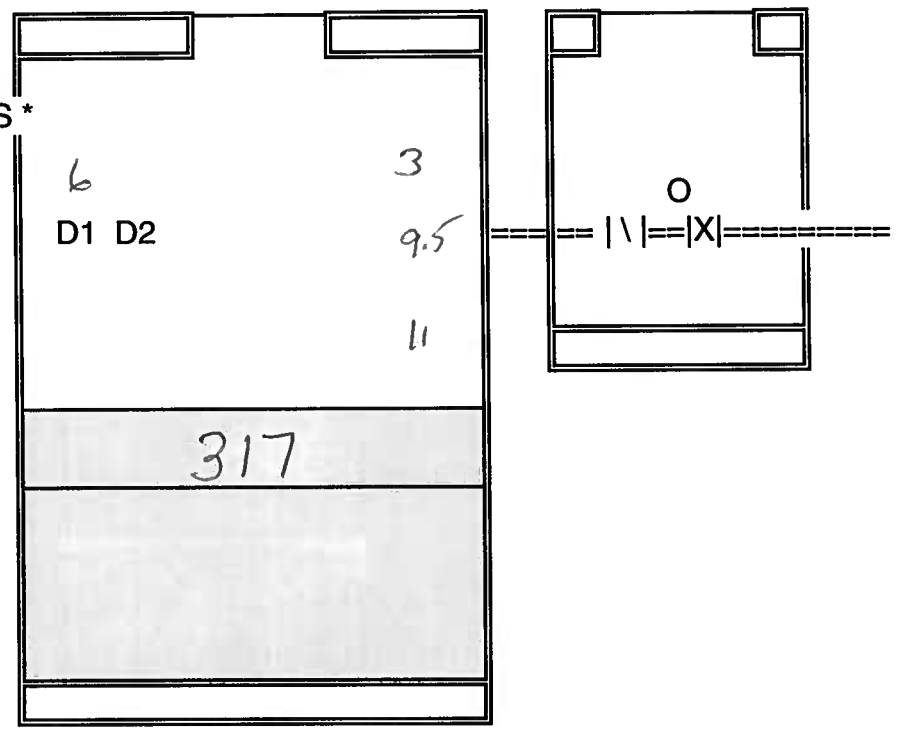

1. Measure the wet well diameter or rectangular size in inches.
2. When the pump turns on measure the distance from the top of the wet well to the sewage level (D)
3. When the pump turns off measure the distance from the top of the wet well to the sewage level (D)

Comments: _____

LIFT STATION FLOW CALCULATION WORKSHEET (Lift Stations with RTU)

DATE: ___/___/___ TIME: ___:___

LOCATION: BRADEN LAKES 143

WETWELL

VALVEBOX

* ALL MEASUREMENTS IN INCHES *

WETWELL DIAMETER 72

ON-LEVEL DEPTH (D1) 159

OFF LEVEL DEPTH (D2) 189

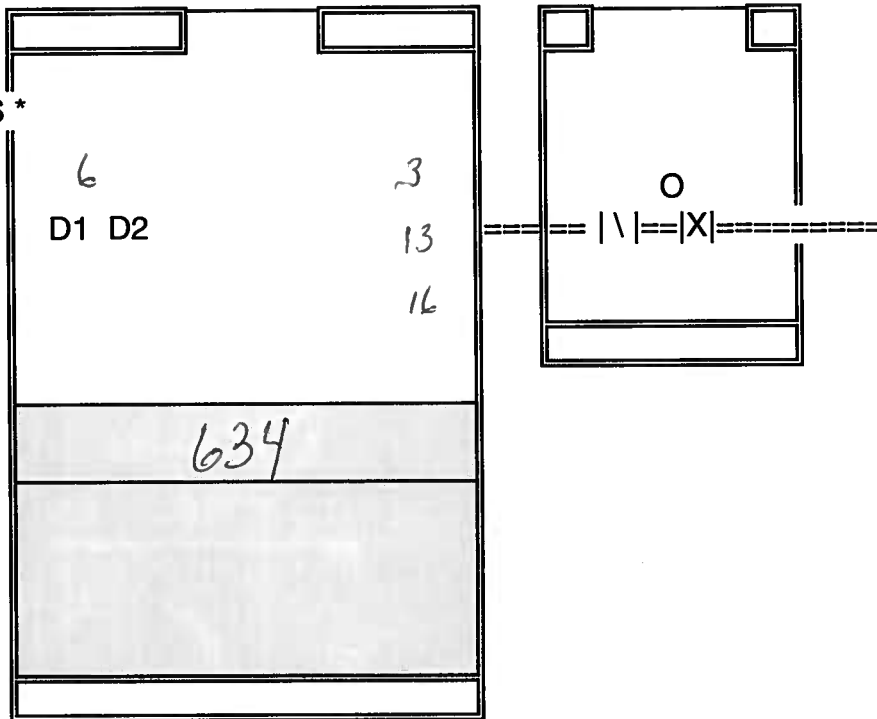

1. Measure the wet well diameter or rectangular size in inches.
2. When the pump turns on measure the distance from the top of the wet well to the sewage level (D)
3. When the pump turns off measure the distance from the top of the wet well to the sewage level (D)

Comments: _____

LIFT STATION FLOW CALCULATION WORKSHEET (Lift Stations with RTU)

PARK + REC. MAINT. BLDG.

DATE: 3/20/15 TIME: _____:

LOCATION: L.S. 144

WETWELL

VALVEBOX

* ALL MEASUREMENTS IN INCHES *

WETWELL DIAMETER 36"

ON-LEVEL DEPTH (D1) 54"

OFF LEVEL DEPTH (D2) 60"

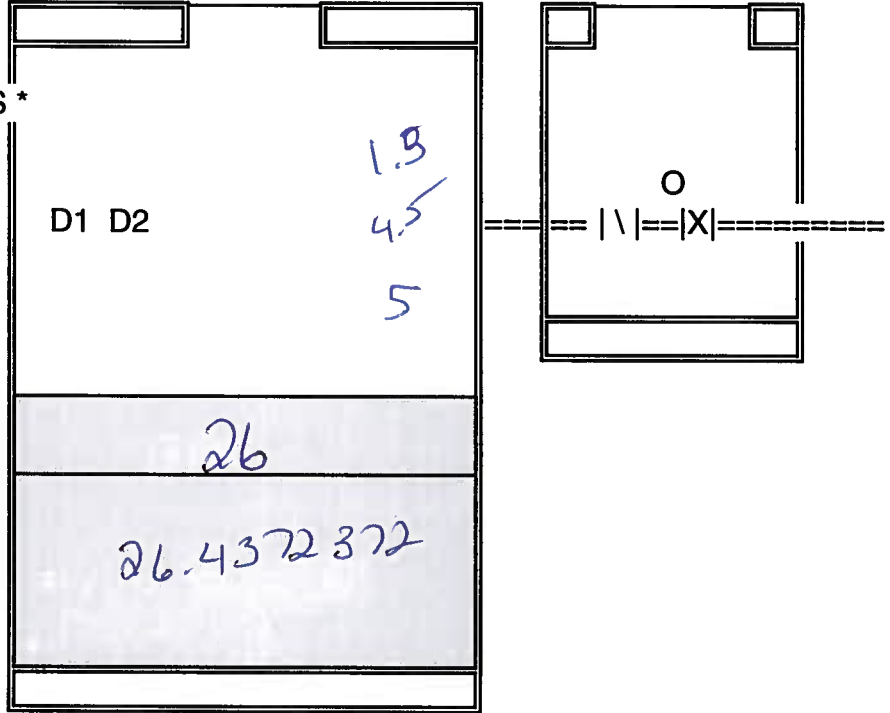

1. Measure the wet well diameter or rectangular size in inches.
2. When the pump turns on measure the distance from the top of the wet well to the sewage level (D1)
3. When the pump turns off measure the distance from the top of the wet well to the sewage level (D2)

Comments: _____

LIFT STATION FLOW CALCULATION WORKSHEET (Lift Stations with RTU)

DATE: ___/___/___ TIME: ___:___

LOCATION: PALM COURT 145

WETWELL

VALVEBOX

* ALL MEASUREMENTS IN INCHES *

WETWELL DIAMETER 100

ON-LEVEL DEPTH (D1) 196

OFF LEVEL DEPTH (D2) 210

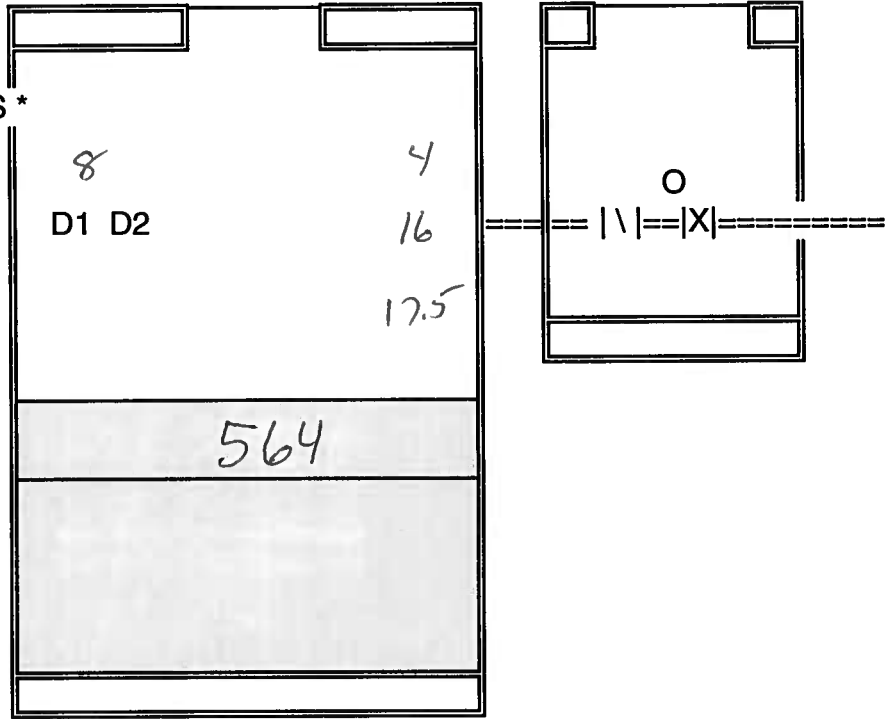

1. Measure the wet well diameter or rectangular size in inches.
2. When the pump turns on measure the distance from the top of the wet well to the sewage level (D)
3. When the pump turns off measure the distance from the top of the wet well to the sewage level (D)

Comments: _____

LIFT STATION FLOW CALCULATION WORKSHEET (Lift Stations with RTU)

DATE: ___/___/___ TIME: ___:___

LOCATION: WEST GLENN 146

WETWELL

VALVEBOX

* ALL MEASUREMENTS IN INCHES *

WETWELL DIAMETER 73

ON-LEVEL DEPTH (D1) 191

OFF LEVEL DEPTH (D2) 209

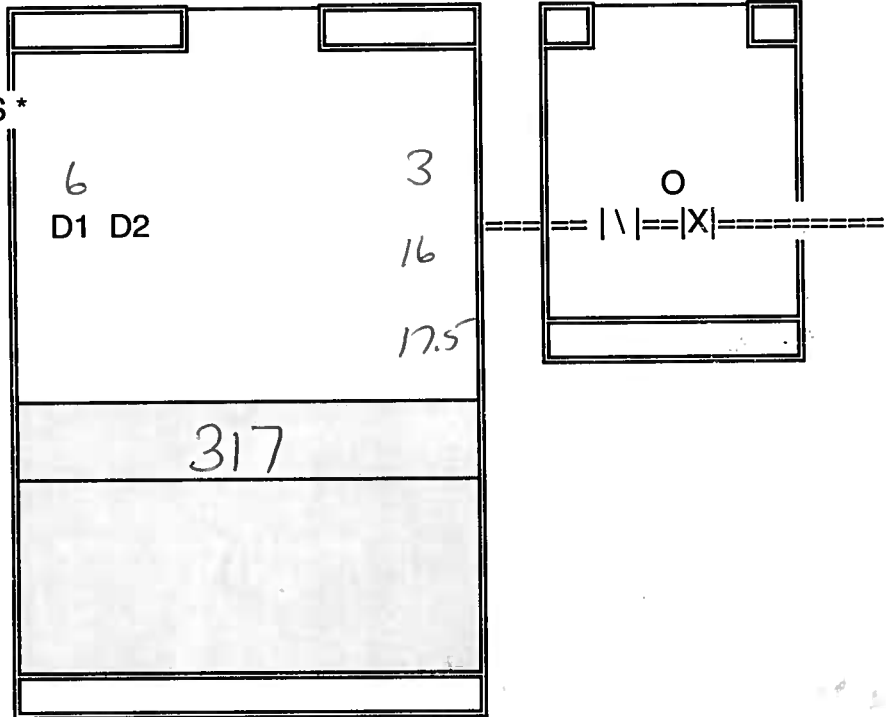

1. Measure the wet well diameter or rectangular size in inches.
2. When the pump turns on measure the distance from the top of the wet well to the sewage level (D)
3. When the pump turns off measure the distance from the top of the wet well to the sewage level (D)

Comments: _____

LIFT STATION FLOW CALCULATION WORKSHEET (Lift Stations with RTU)

DATE: 3/16/15 TIME: _____:

LOCATION: THE LOOP L.S. 147

WETWELL

VALVEBOX

* ALL MEASUREMENTS IN INCHES *

WETWELL DIAMETER 72"

ON-LEVEL DEPTH (D1) 228"
19' =

OFF LEVEL DEPTH (D2) 252"
21' =

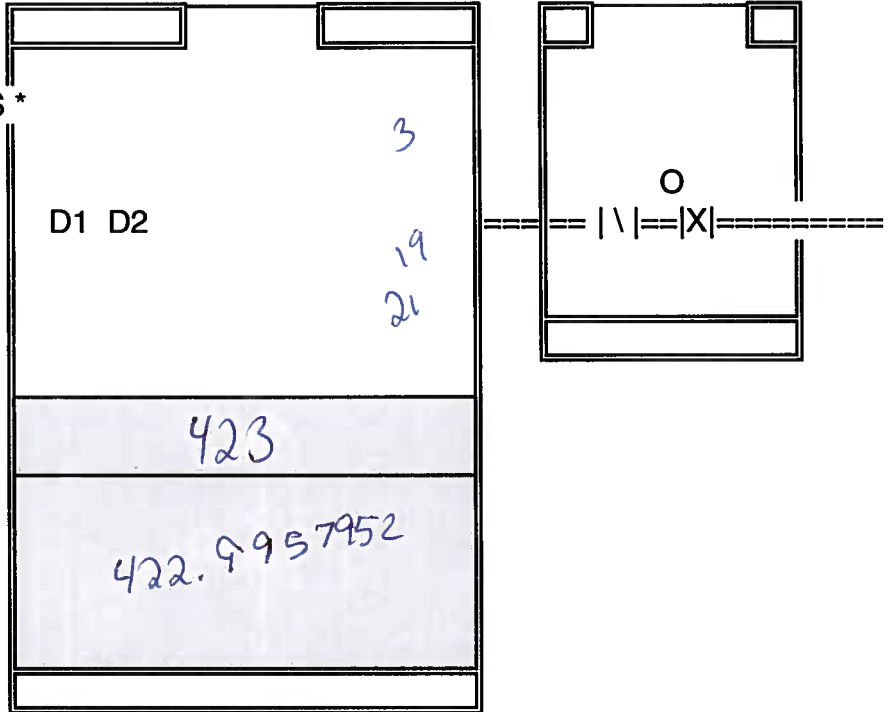

1. Measure the wet well diameter or rectangular size in inches.
2. When the pump turns on measure the distance from the top of the wet well to the sewage level (D1)
3. When the pump turns off measure the distance from the top of the wet well to the sewage level (D2)

Comments: _____

LIFT STATION FLOW CALCULATION WORKSHEET (Lift Stations with RTU)

LAKE ROYALE

DATE: 3/20/15 TIME: ____:____

LOCATION: L.S. 148

WETWELL

VALVEBOX

* ALL MEASUREMENTS IN INCHES *

WETWELL DIAMETER 72"

ON-LEVEL DEPTH (D1) 102"
8'-6" =

OFF LEVEL DEPTH (D2) 120"
10' =

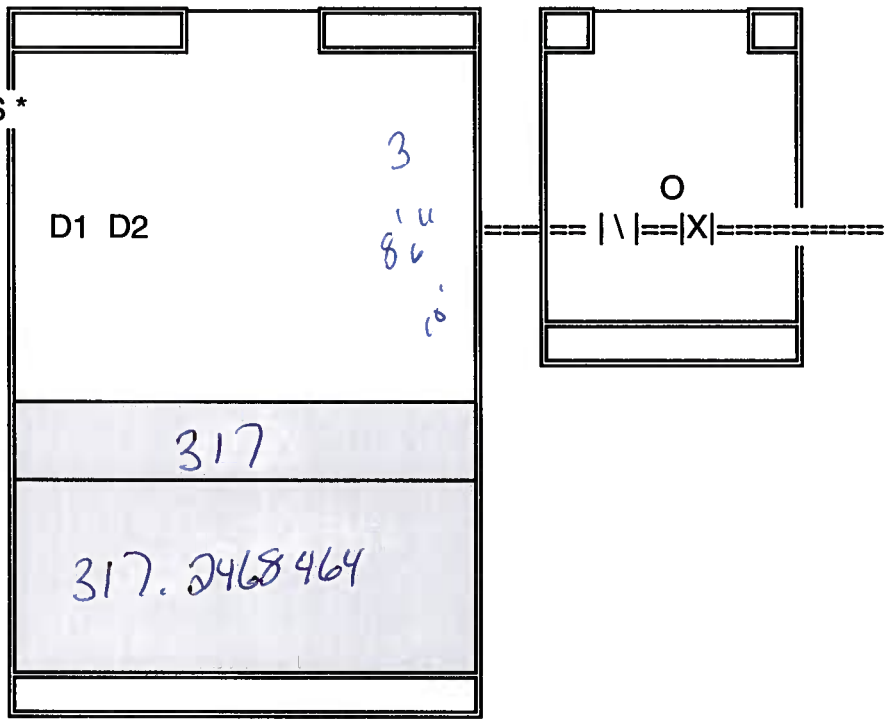

1. Measure the wet well diameter or rectangular size in inches.
2. When the pump turns on measure the distance from the top of the wet well to the sewage level (D1)
3. When the pump turns off measure the distance from the top of the wet well to the sewage level (D2)

Comments: _____

LIFT STATION FLOW CALCULATION WORKSHEET (Lift Stations with RTU)

DATE: ___/___/___ TIME: ___:___

LOCATION: BOLLETTIERI VILLAG 150

WETWELL

VALVEBOX

* ALL MEASUREMENTS IN INCHES *

WETWELL DIAMETER 96

ON-LEVEL DEPTH (D1) 230

OFF LEVEL DEPTH (D2) 258

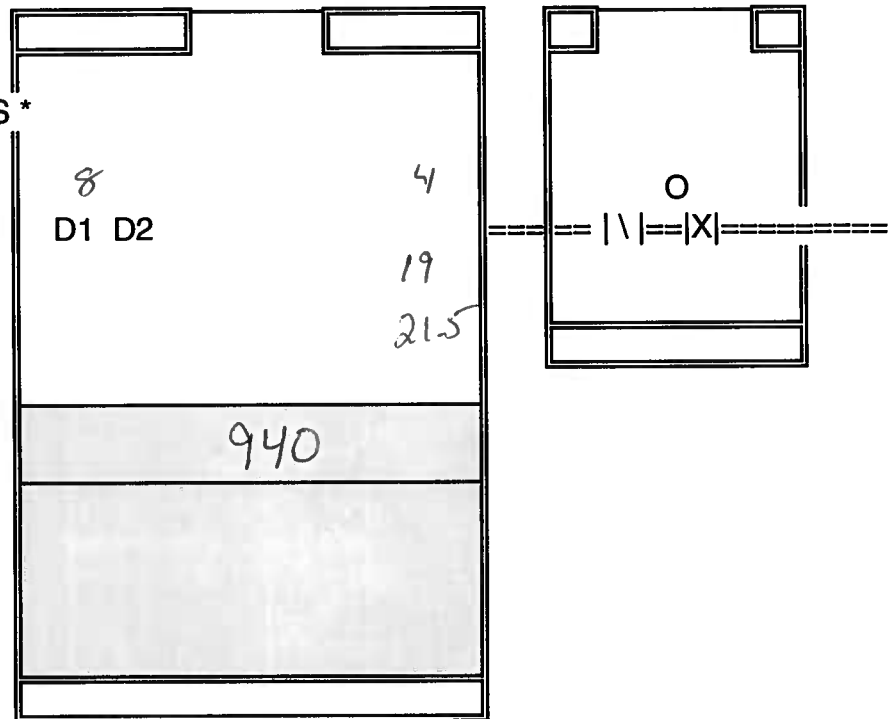

1. Measure the wet well diameter or rectangular size in inches.
2. When the pump turns on measure the distance from the top of the wet well to the sewage level (D)
3. When the pump turns off measure the distance from the top of the wet well to the sewage level (D)

Comments: _____

LIFT STATION FLOW CALCULATION WORKSHEET (Lift Stations with RTU)

DATE: ___/___/___ TIME: ___:___

LOCATION: WINN DIXIE PLAZA WEST

159

WETWELL

VALVEBOX

* ALL MEASUREMENTS IN INCHES *

WETWELL DIAMETER 74

ON-LEVEL DEPTH (D1) 184

OFF LEVEL DEPTH (D2) 196

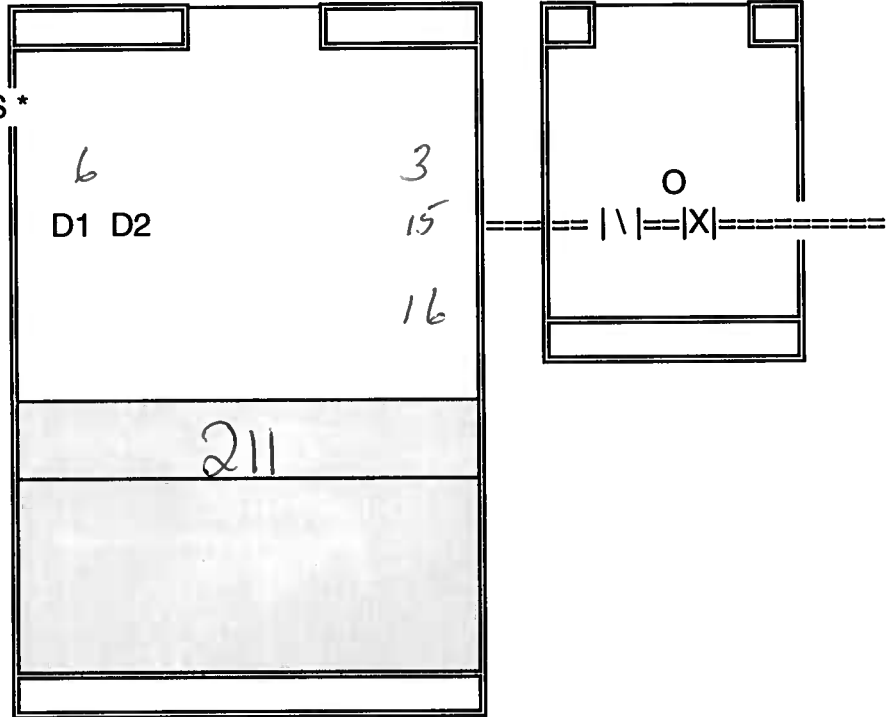

1. Measure the wet well diameter or rectangular size in inches.
2. When the pump turns on measure the distance from the top of the wet well to the sewage level (D)
3. When the pump turns off measure the distance from the top of the wet well to the sewage level (D)

Comments: _____

LIFT STATION FLOW CALCULATION WORKSHEET (Lift Stations with RTU)

DATE: ___/___/___ TIME: ___:___

LOCATION: DAKWOOD VILLAS 160

WETWELL

VALVEBOX

* ALL MEASUREMENTS IN INCHES *

WETWELL DIAMETER 47

ON-LEVEL DEPTH (D1) 142

OFF LEVEL DEPTH (D2) 154

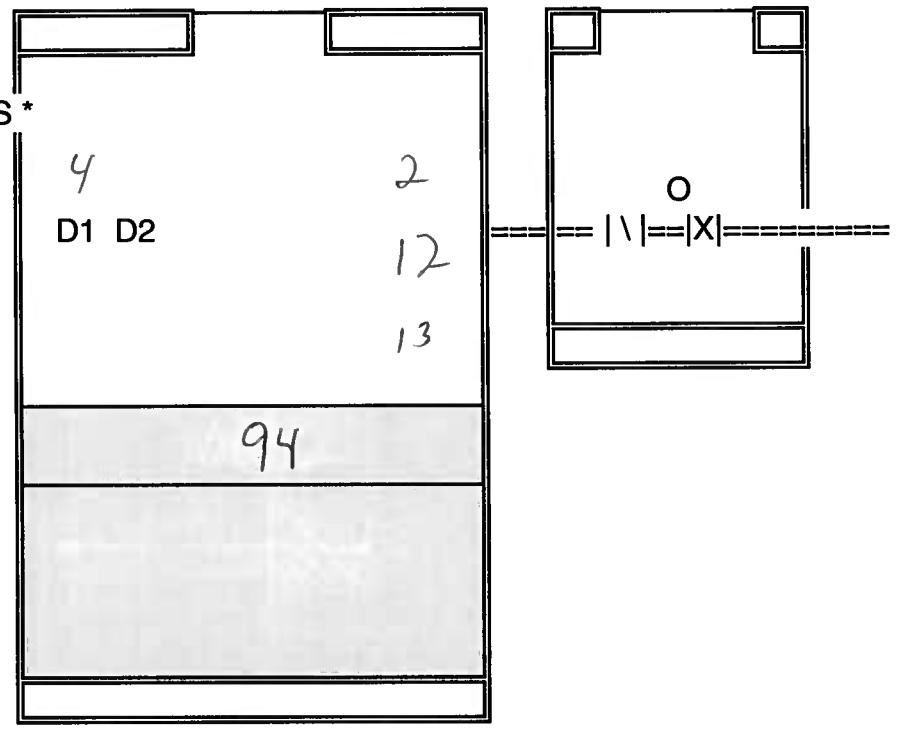

1. Measure the wet well diameter or rectangular size in inches.
2. When the pump turns on measure the distance from the top of the wet well to the sewage level (D)
3. When the pump turns off measure the distance from the top of the wet well to the sewage level (D)

Comments: _____

LIFT STATION FLOW CALCULATION WORKSHEET (Lift Stations with RTU)

Fleet Service

DATE: 3/20/15 TIME: _____:

LOCATION: L.S. 162

WETWELL

VALVEBOX

* ALL MEASUREMENTS IN INCHES *

WETWELL DIAMETER 48"

ON-LEVEL DEPTH (D1) 108"
9' =

OFF LEVEL DEPTH (D2) 126"
10'-6" =

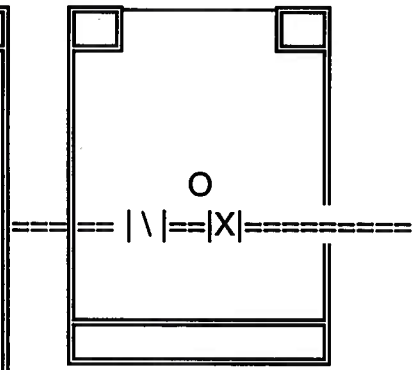
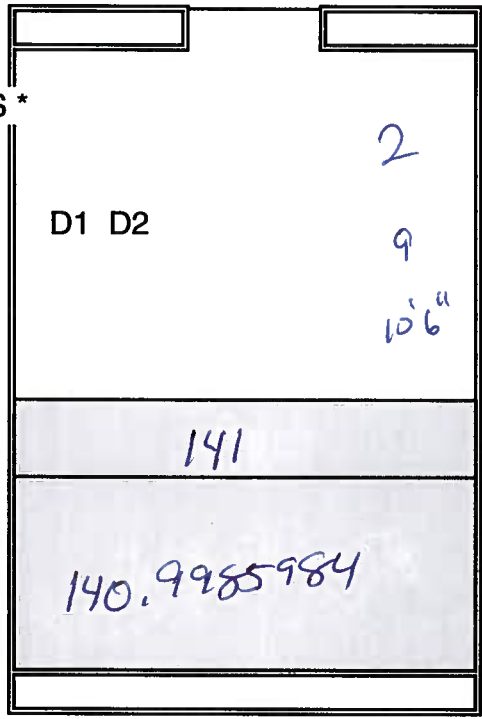

1. Measure the wet well diameter or rectangular size in inches.
2. When the pump turns on measure the distance from the top of the wet well to the sewage level (D1)
3. When the pump turns off measure the distance from the top of the wet well to the sewage level (D2)

Comments: _____

LIFT STATION FLOW CALCULATION WORKSHEET (Lift Stations with RTU)

WASTE WATER LAB

DATE: 3 / 20 / 15 TIME: _____

LOCATION: L.S. 163

WETWELL

VALVEBOX

* ALL MEASUREMENTS IN INCHES *

WETWELL DIAMETER 48"

ON-LEVEL DEPTH (D1) 72"
6' =

OFF LEVEL DEPTH (D2) 96"
7'-6" =

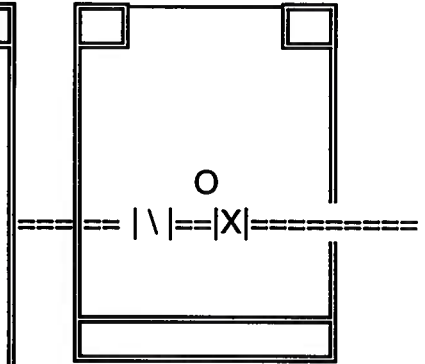
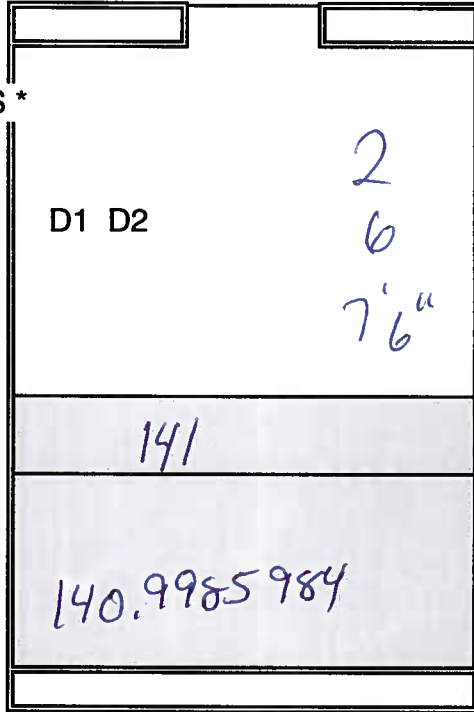

1. Measure the wet well diameter or rectangular size in inches.
2. When the pump turns on measure the distance from the top of the wet well to the sewage level (D)
3. When the pump turns off measure the distance from the top of the wet well to the sewage level (D)

Comments: _____

LIFT STATION FLOW CALCULATION WORKSHEET (Lift Stations with RTU)

PALMA VISTA

DATE: 3/24/15 TIME: _____

LOCATION: L.S. 201

WETWELL

VALVEBOX

* ALL MEASUREMENTS IN INCHES *

WETWELL DIAMETER 72"

ON-LEVEL DEPTH (D1) 108"
9' =

OFF LEVEL DEPTH (D2) 132"
11' =

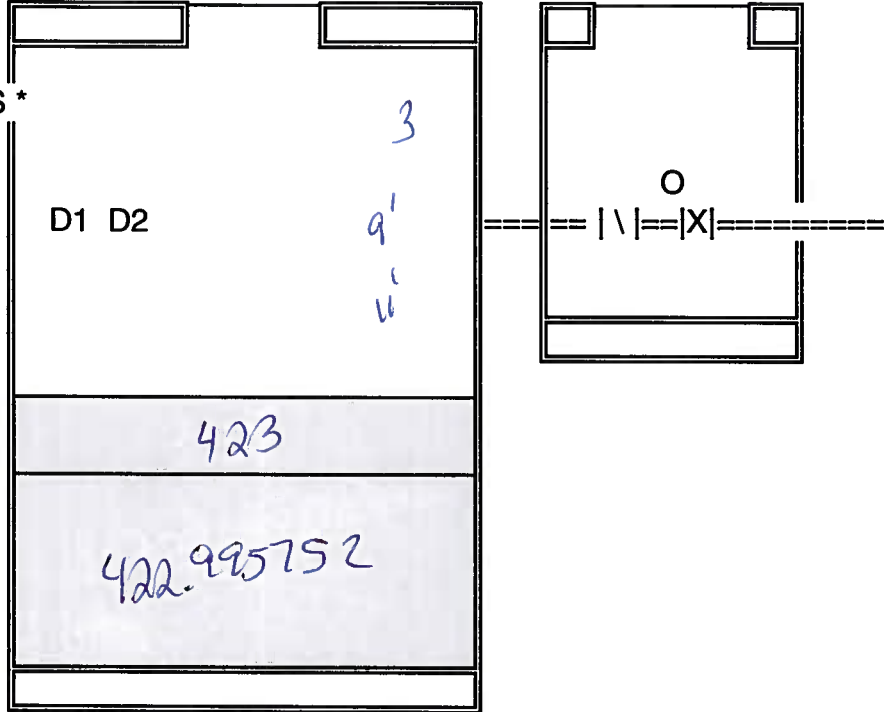

1. Measure the wet well diameter or rectangular size in inches.
2. When the pump turns on measure the distance from the top of the wet well to the sewage level (D1)
3. When the pump turns off measure the distance from the top of the wet well to the sewage level (D2)

Comments: _____

LIFT STATION FLOW CALCULATION WORKSHEET (Lift Stations with RTU)

PERICO ISLAND 2207

DATE: 3 / 16 / 15 TIME: _____ :

LOCATION: L.S. 207

WETWELL

VALVEBOX

* ALL MEASUREMENTS IN INCHES *

WETWELL DIAMETER 72"

ON-LEVEL DEPTH (D1) 204"

17' =

OFF LEVEL DEPTH (D2) 222"

18'-6" =

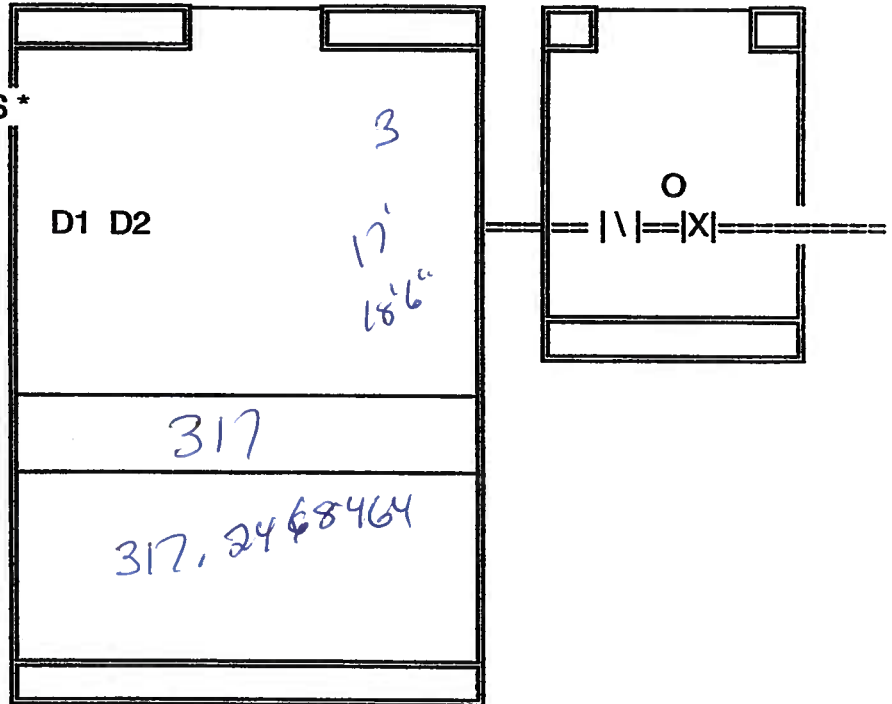

1. Measure the wet well diameter or rectangular size in inches.
2. When the pump turns on measure the distance from the top of the wet well to the sewage level (D)
3. When the pump turns off measure the distance from the top of the wet well to the sewage level (D)

Comments: _____

LIFT STATION FLOW CALCULATION WORKSHEET (Lift Stations with RTU)

FLAMINGO CAY

2208

DATE: 3 / 16 / 15 TIME: _____:

LOCATION: L.S. 208

WETWELL

VALVEBOX

* ALL MEASUREMENTS IN INCHES *

WETWELL DIAMETER 96"

ON-LEVEL DEPTH (D1) 168"

14' =

OFF LEVEL DEPTH (D2) 180"

15' =

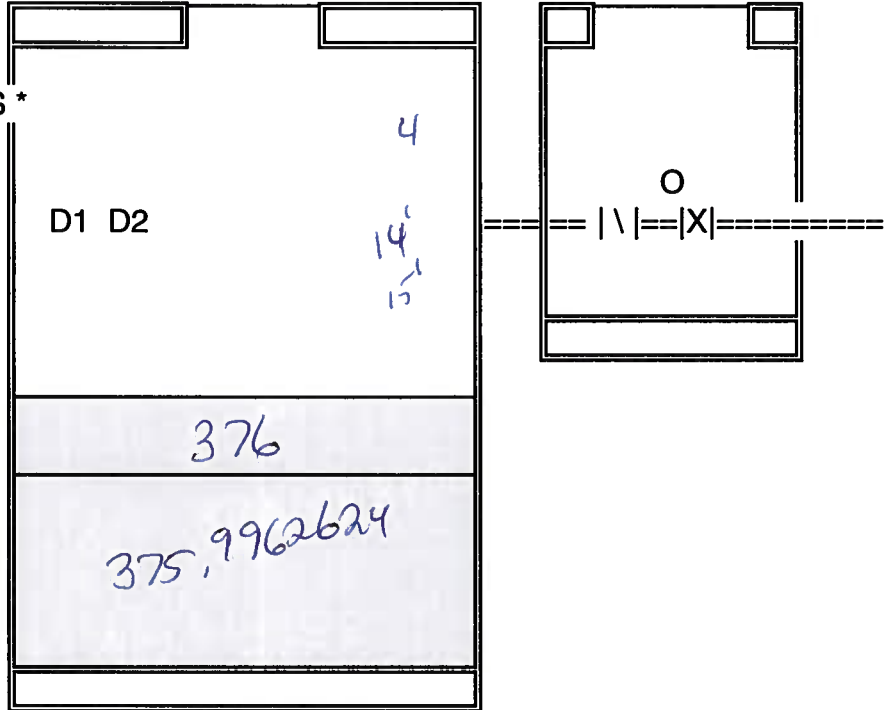

1. Measure the wet well diameter or rectangular size in inches.
2. When the pump turns on measure the distance from the top of the wet well to the sewage level (D)
3. When the pump turns off measure the distance from the top of the wet well to the sewage level (D)

Comments: _____

LIFT STATION FLOW CALCULATION WORKSHEET (Lift Stations with RTU)

PALMA SOLA CAUSEWAY

DATE: 3/13/15 TIME: _____:

LOCATION: L.S. 209

WETWELL

VALVEBOX

* ALL MEASUREMENTS IN INCHES *

WETWELL DIAMETER 48"

ON-LEVEL DEPTH (D1) 60"

OFF LEVEL DEPTH (D2) 72"

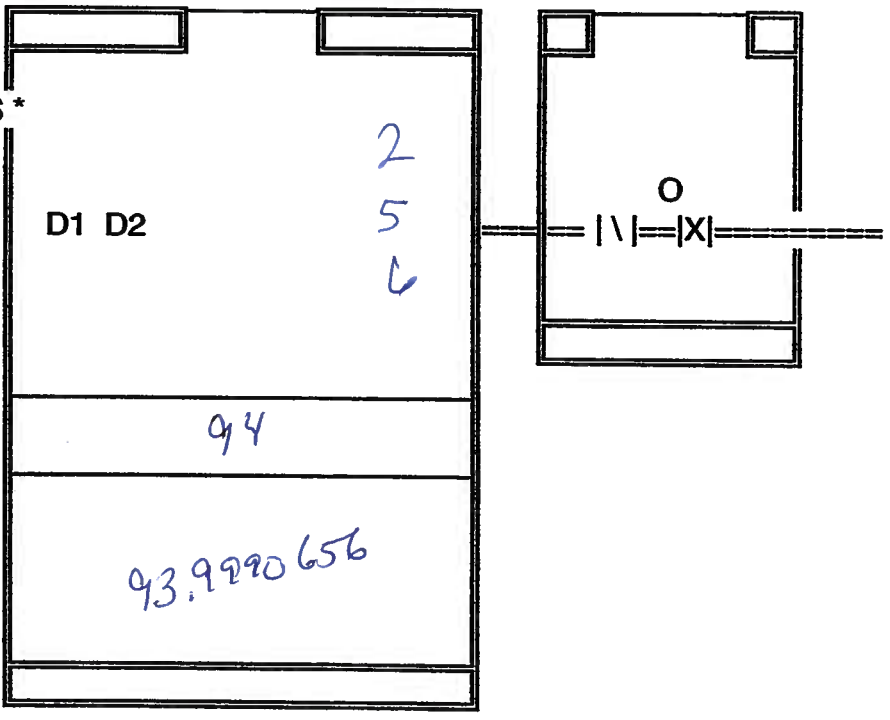

1. Measure the wet well diameter or rectangular size in inches.
2. When the pump turns on measure the distance from the top of the wet well to the sewage level (D)
3. When the pump turns off measure the distance from the top of the wet well to the sewage level (D)

Comments: _____

LIFT STATION FLOW CALCULATION WORKSHEET (Lift Stations with RTU)

DATE: ___/___/___ TIME: ___:___

LOCATION: 35-A 210

WETWELL

VALVEBOX

* ALL MEASUREMENTS IN INCHES *

WETWELL DIAMETER 73

ON-LEVEL DEPTH (D1) 147

OFF LEVEL DEPTH (D2) 156

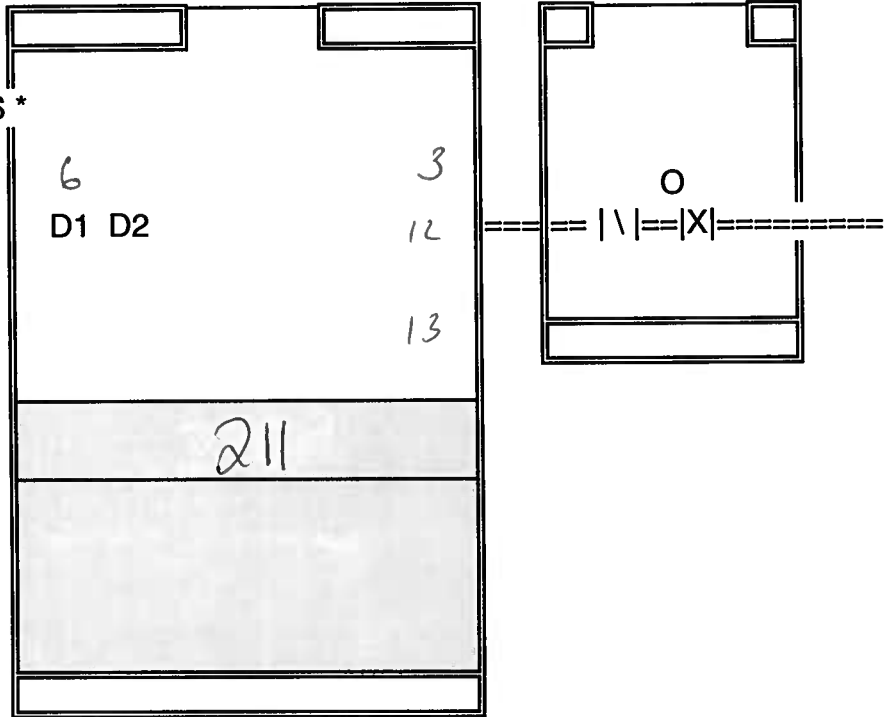

1. Measure the wet well diameter or rectangular size in inches.
2. When the pump turns on measure the distance from the top of the wet well to the sewage level (D)
3. When the pump turns off measure the distance from the top of the wet well to the sewage level (D)

Comments: _____

LIFT STATION FLOW CALCULATION WORKSHEET (Lift Stations with RTU)

THE OAKS

DATE: 3/23/15 TIME: _____:

LOCATION: L.S. 212

WETWELL

VALVEBOX

* ALL MEASUREMENTS IN INCHES *

WETWELL DIAMETER 72"

ON-LEVEL DEPTH (D1) 120"
10' =

OFF LEVEL DEPTH (D2) 144"
12' =

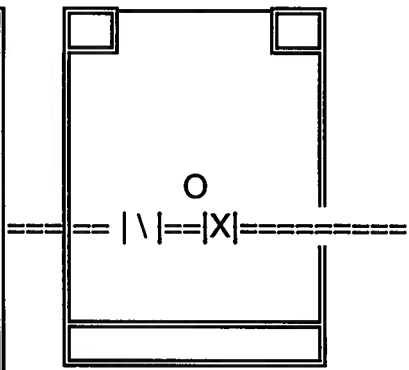
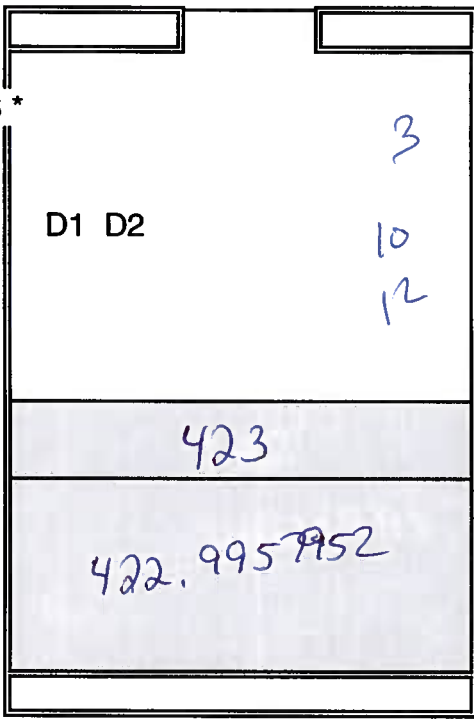

1. Measure the wet well diameter or rectangular size in inches.
2. When the pump turns on measure the distance from the top of the wet well to the sewage level (D)
3. When the pump turns off measure the distance from the top of the wet well to the sewage level (D)

Comments: _____

LIFT STATION FLOW CALCULATION WORKSHEET (Lift Stations with RTU)

Spanish Park

DATE: 3 / 23 / 15 TIME: _____: _____

LOCATION: L.S. 213

WETWELL

VALVEBOX

* ALL MEASUREMENTS IN INCHES *

WETWELL DIAMETER 72

ON-LEVEL DEPTH (D1) 13
13' =

OFF LEVEL DEPTH (D2) 15
15' =

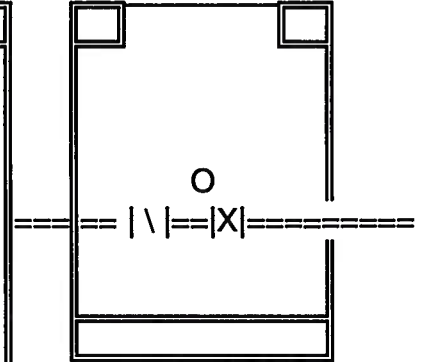
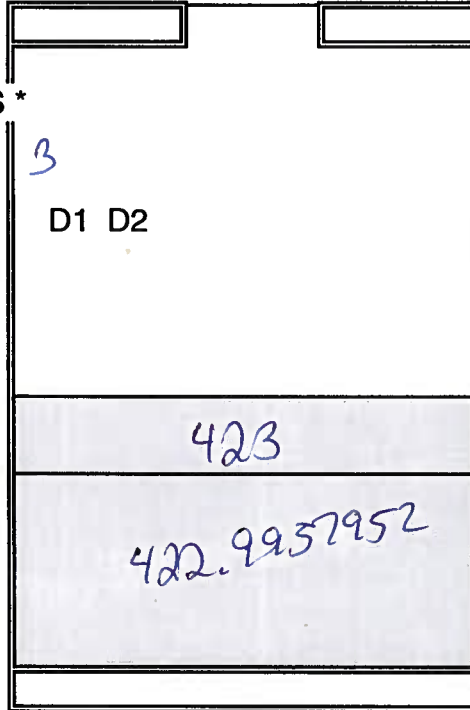

1. Measure the wet well diameter or rectangular size in inches.
2. When the pump turns on measure the distance from the top of the wet well to the sewage level (D)
3. When the pump turns off measure the distance from the top of the wet well to the sewage level (D)

Comments: _____

LIFT STATION FLOW CALCULATION WORKSHEET (Lift Stations with RTU)

PALMA SOLA woods I

DATE: 3/23/15 TIME: _____:

LOCATION: L.S. 214

WETWELL

VALVEBOX

* ALL MEASUREMENTS IN INCHES *

WETWELL DIAMETER 48"

ON-LEVEL DEPTH (D1) 96"
8' =

OFF LEVEL DEPTH (D2) 114"
9'-6" =

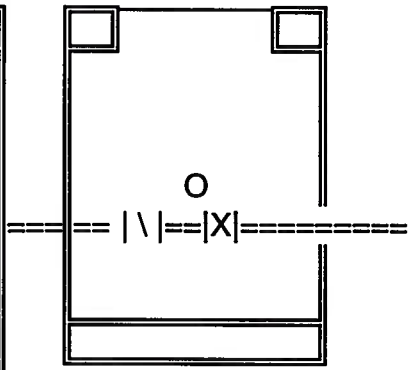
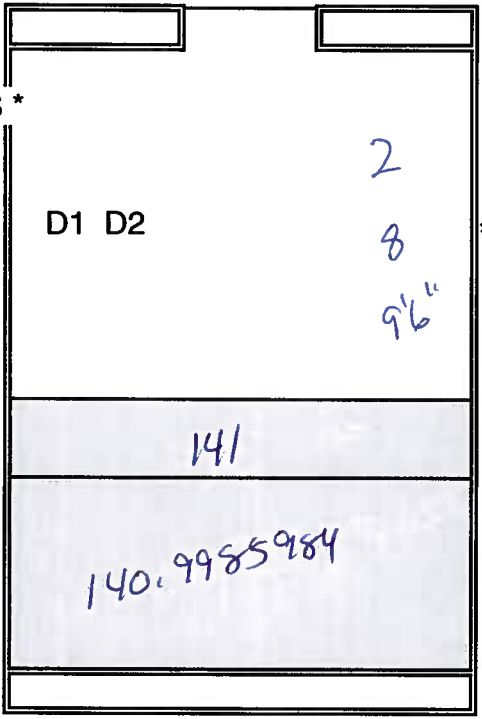

1. Measure the wet well diameter or rectangular size in inches.
2. When the pump turns on measure the distance from the top of the wet well to the sewage level (D1)
3. When the pump turns off measure the distance from the top of the wet well to the sewage level (D2)

Comments: _____

2215

LIFT STATION FLOW CALCULATION WORKSHEET (Lift Stations with RTU)

PALMA SOLA woods II

DATE: 3 / 23 / 15 TIME: _____:_____

LOCATION: L.S. 215

WETWELL

VALVEBOX

* ALL MEASUREMENTS IN INCHES *

WETWELL DIAMETER 48"

ON-LEVEL DEPTH (D1) 108"
9' =

OFF LEVEL DEPTH (D2) 132"
11' =

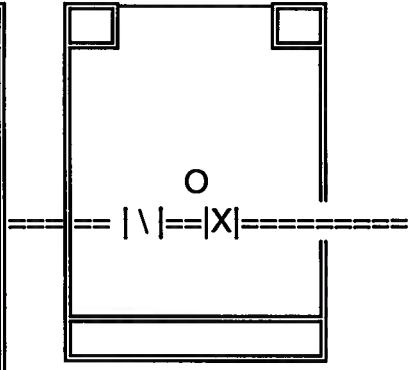
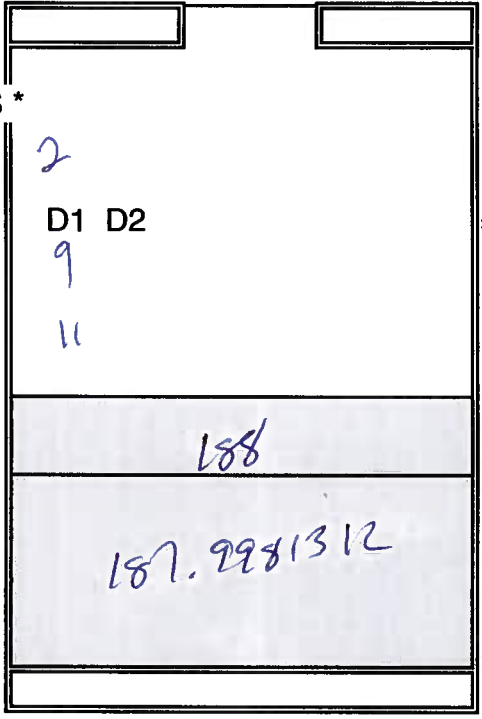

1. Measure the wet well diameter or rectangular size in inches.
2. When the pump turns on measure the distance from the top of the wet well to the sewage level (D1)
3. When the pump turns off measure the distance from the top of the wet well to the sewage level (D2)

Comments: _____

LIFT STATION FLOW CALCULATION WORKSHEET (Lift Stations with RTU)

DATE: 3/24/15 TIME: _____:

LOCATION: 19-D
L.S. 217

WETWELL

VALVEBOX

* ALL MEASUREMENTS IN INCHES *

WETWELL DIAMETER 72"

ON-LEVEL DEPTH (D1) 240"
30' =

OFF LEVEL DEPTH (D2) 264"
22' =

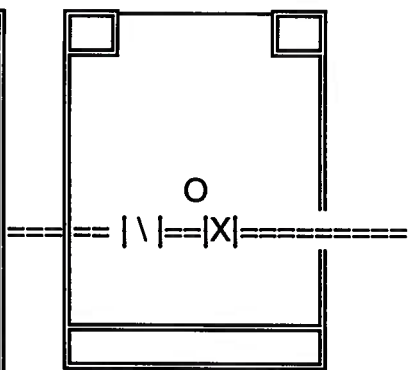
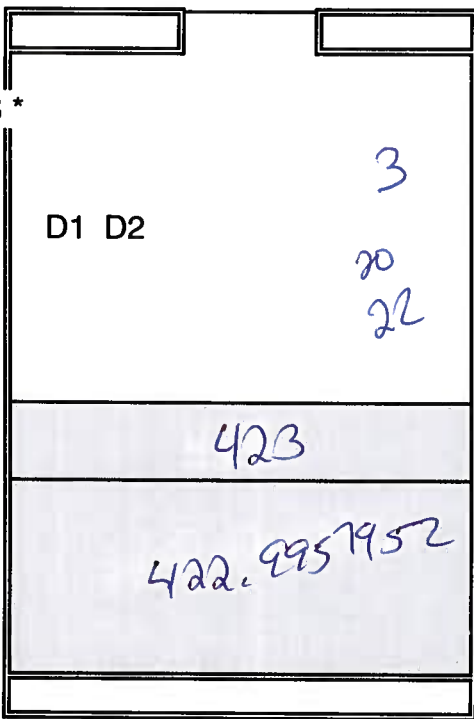

1. Measure the wet well diameter or rectangular size in inches.
2. When the pump turns on measure the distance from the top of the wet well to the sewage level (D)
3. When the pump turns off measure the distance from the top of the wet well to the sewage level (D)

Comments: _____

LIFT STATION FLOW CALCULATION WORKSHEET (Lift Stations with RTU)

DATE: 3 / 13 / 15 TIME: ____:____

LOCATION: 15-D
L.S. 218

WETWELL

VALVEBOX

* ALL MEASUREMENTS IN INCHES *

WETWELL DIAMETER 96"

ON-LEVEL DEPTH (D1) 162"
13'-6" =

OFF LEVEL DEPTH (D2) 204"
17' =

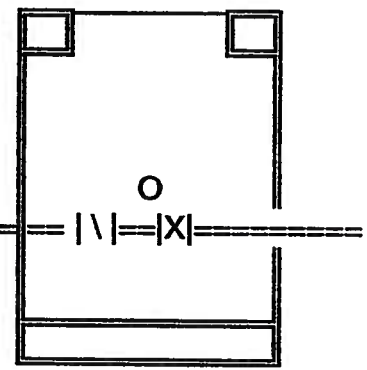
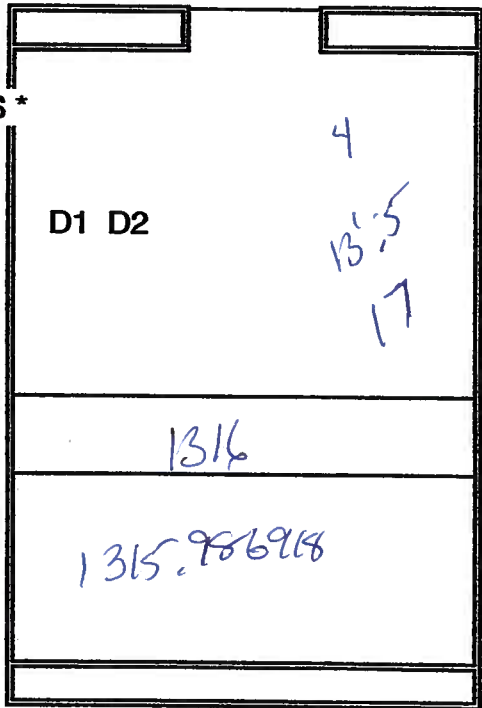

1. Measure the wet well diameter or rectangular size in inches.
2. When the pump turns on measure the distance from the top of the wet well to the sewage level (D)
3. When the pump turns off measure the distance from the top of the wet well to the sewage level (D)

Comments: _____

LIFT STATION FLOW CALCULATION WORKSHEET (Lift Stations with RTU)

DATE: 3/13/15 TIME: _____:

LOCATION: 14-D
L.S. 219

WETWELL

VALVEBOX

* ALL MEASUREMENTS IN INCHES *

WETWELL DIAMETER 72"

ON-LEVEL DEPTH (D1) 204"
17' =

OFF LEVEL DEPTH (D2) 228"
19' =

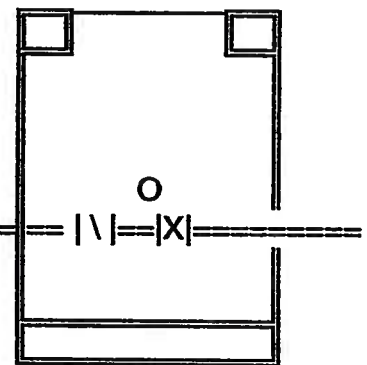
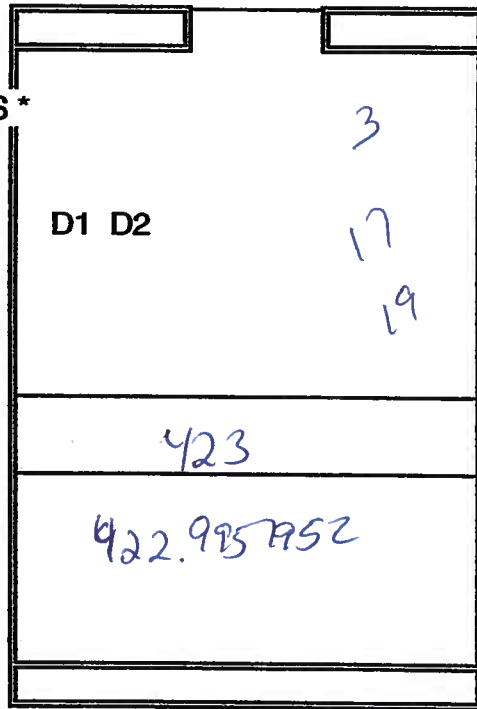

1. Measure the wet well diameter or rectangular size in inches.
2. When the pump turns on measure the distance from the top of the wet well to the sewage level (D)
3. When the pump turns off measure the distance from the top of the wet well to the sewage level (D)

Comments: _____

LIFT STATION FLOW CALCULATION WORKSHEET (Lift Stations with RTU)

DATE: 3/13/15 TIME: _____:

LOCATION: 10-D
L.S. # 220

WETWELL

VALVEBOX

* ALL MEASUREMENTS IN INCHES *

12' x 10' =
WETWELL DIAMETER 144" x 120"

ON-LEVEL DEPTH (D1) 48"

OFF LEVEL DEPTH (D2) 36"

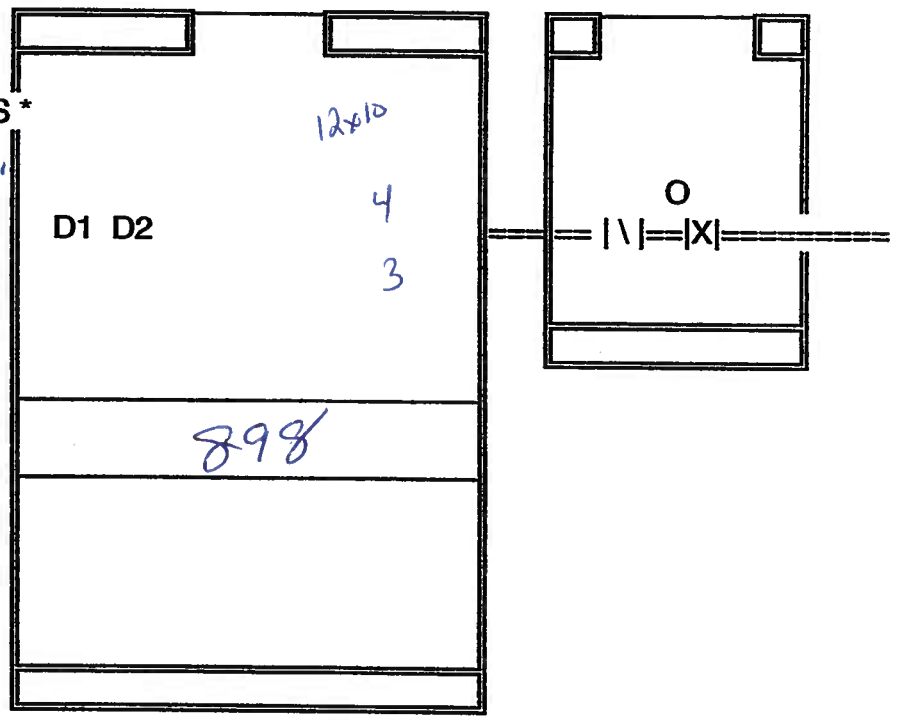

1. Measure the wet well diameter or rectangular size in inches.
2. When the pump turns on measure the distance from the top of the wet well to the sewage level (D1)
3. When the pump turns off measure the distance from the top of the wet well to the sewage level (D2)

Comments: STATION RUNS ON TRANSDUCER

LIFT STATION FLOW CALCULATION WORKSHEET (Lift Stations with RTU)

DATE: ___/___/___ TIME: ___:___

LOCATION: # 221 ^{12-D}

WETWELL

VALVEBOX

* ALL MEASUREMENTS IN INCHES *

WETWELL DIAMETER 96"

ON-LEVEL DEPTH (D1) 65"

OFF LEVEL DEPTH (D2) 24"

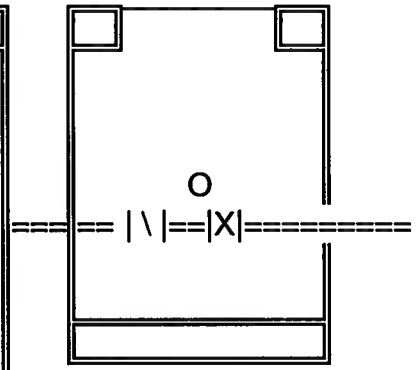
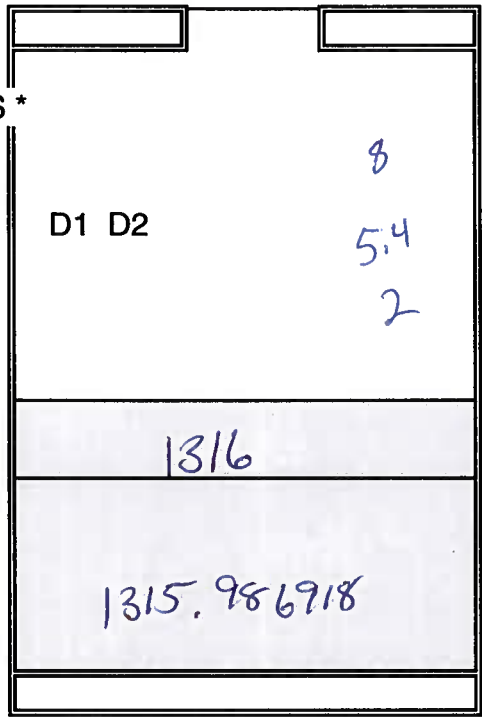

1. Measure the wet well diameter or rectangular size in inches.
2. When the pump turns on measure the distance from the top of the wet well to the sewage level (D)
3. When the pump turns off measure the distance from the top of the wet well to the sewage level (D)

Comments: STATION ON TRANSDUCER

LIFT STATION FLOW CALCULATION WORKSHEET (Lift Stations with RTU)

Desoto MEM. PARK

DATE: 3/19/15 TIME: _____:_____

LOCATION: L.S. 222

WETWELL

VALVEBOX

* ALL MEASUREMENTS IN INCHES *

WETWELL DIAMETER 60"

ON-LEVEL DEPTH (D1) 60"

OFF LEVEL DEPTH (D2) 72"

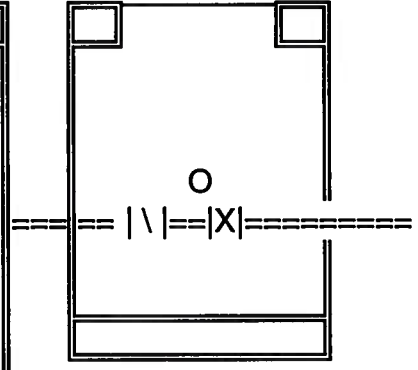
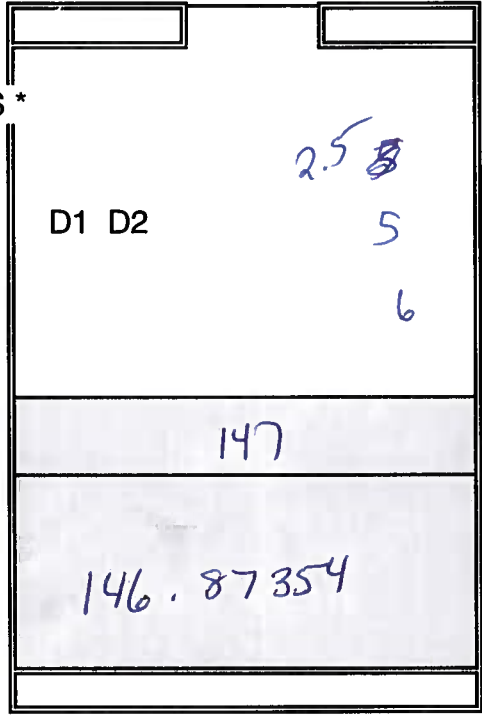

1. Measure the wet well diameter or rectangular size in inches.
2. When the pump turns on measure the distance from the top of the wet well to the sewage level (D1)
3. When the pump turns off measure the distance from the top of the wet well to the sewage level (D2)

Comments: _____

LIFT STATION FLOW CALCULATION WORKSHEET (Lift Stations with RTU)

RIVER VIEW HANDINGS

DATE: 3/19/15 TIME: _____:

LOCATION: L.S. 223

WETWELL

VALVEBOX

* ALL MEASUREMENTS IN INCHES *

WETWELL DIAMETER 72"

ON-LEVEL DEPTH (D1) 156"
13'

OFF LEVEL DEPTH (D2) 186"
15.6'

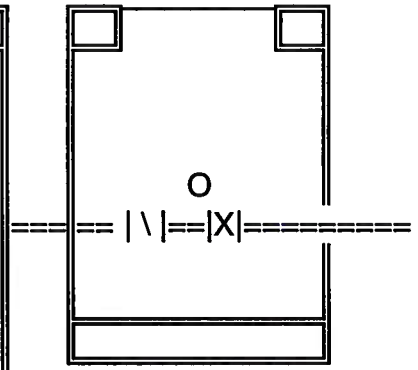
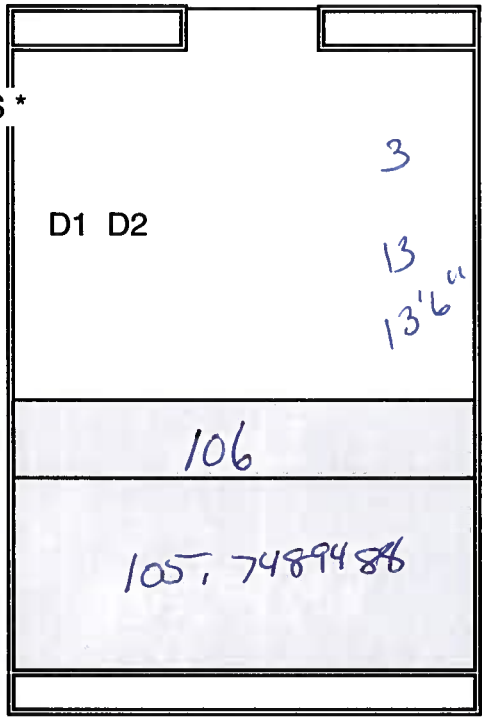

1. Measure the wet well diameter or rectangular size in inches.
2. When the pump turns on measure the distance from the top of the wet well to the sewage level (D)
3. When the pump turns off measure the distance from the top of the wet well to the sewage level (D)

Comments: _____

LIFT STATION FLOW CALCULATION WORKSHEET (Lift Stations with RTU)

22-D

DATE: 3/19/15 TIME: _____

LOCATION: L.S. 224

WETWELL

VALVEBOX

* ALL MEASUREMENTS IN INCHES *

WETWELL DIAMETER 72"

ON-LEVEL DEPTH (D1) 168"

14' =

OFF LEVEL DEPTH (D2) 192"

16' =

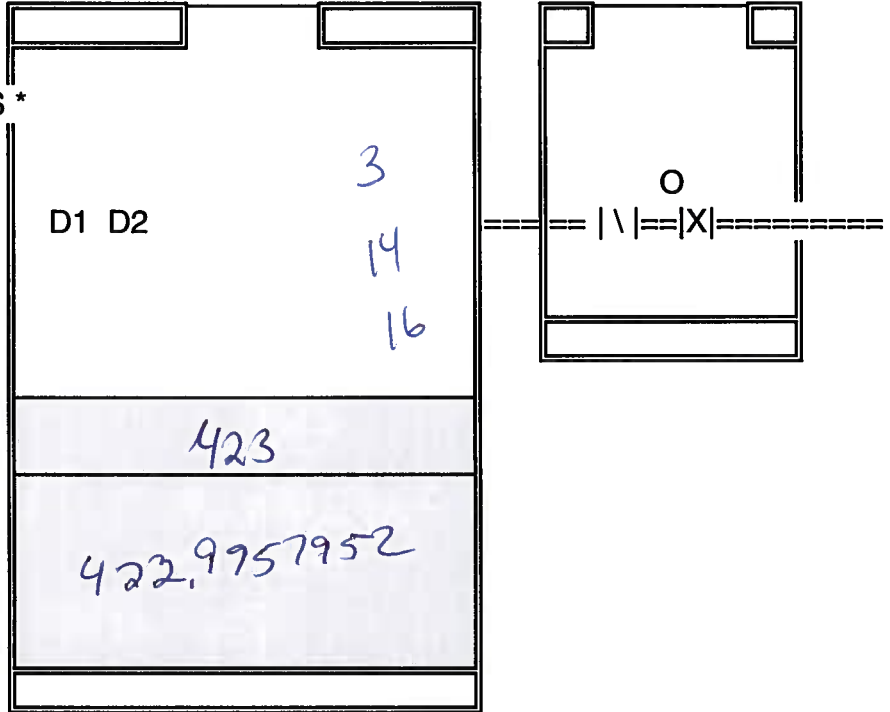

1. Measure the wet well diameter or rectangular size in inches.
2. When the pump turns on measure the distance from the top of the wet well to the sewage level (D
3. When the pump turns off measure the distance from the top of the wet well to the sewage level (D

Comments: _____

LIFT STATION FLOW CALCULATION WORKSHEET (Lift Stations with RTU)

DATE: 3 / 19 / 15 TIME: _____

LOCATION: 8-D
L.S. 225

WETWELL

VALVEBOX

* ALL MEASUREMENTS IN INCHES *

WETWELL DIAMETER 96"

ON-LEVEL DEPTH (D1) 54"

OFF LEVEL DEPTH (D2) 24"

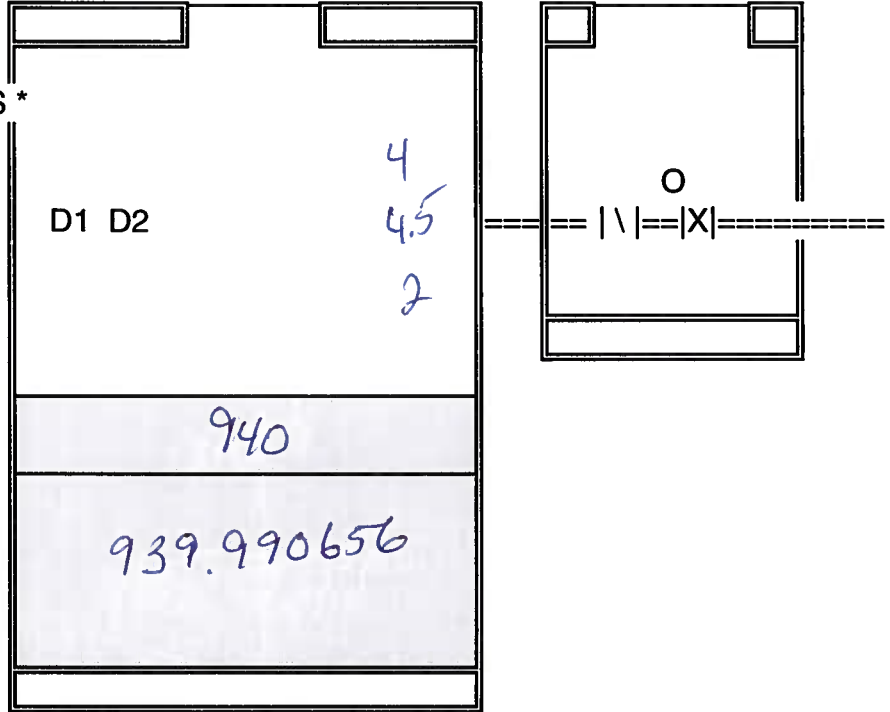

1. Measure the wet well diameter or rectangular size in inches.
2. When the pump turns on measure the distance from the top of the wet well to the sewage level (D1)
3. When the pump turns off measure the distance from the top of the wet well to the sewage level (D2)

Comments: STATION RUNS ON A TRANSDUCER

LIFT STATION FLOW CALCULATION WORKSHEET (Lift Stations with RTU)

DATE: 3/19/15 TIME: ____:____

LOCATION: 9-D
L.S. 226

WETWELL

VALVEBOX

* ALL MEASUREMENTS IN INCHES *

WETWELL DIAMETER 144"

ON-LEVEL DEPTH (D1) 78"

OFF LEVEL DEPTH (D2) 36"

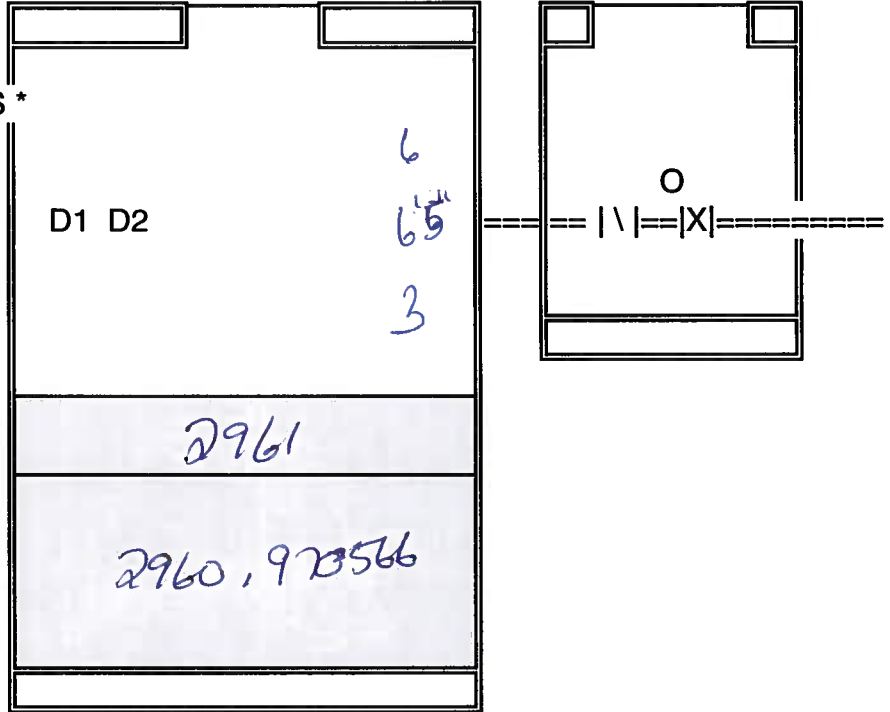

1. Measure the wet well diameter or rectangular size in inches.
2. When the pump turns on measure the distance from the top of the wet well to the sewage level (D1)
3. When the pump turns off measure the distance from the top of the wet well to the sewage level (D2)

Comments: STATION RUN ON A TRANSDUCER.

LIFT STATION FLOW CALCULATION WORKSHEET (Lift Stations with RTU)

BELAIRE BAYOU

DATE: 3/19/15 TIME: _____:

LOCATION: L.S. 227

WETWELL

VALVEBOX

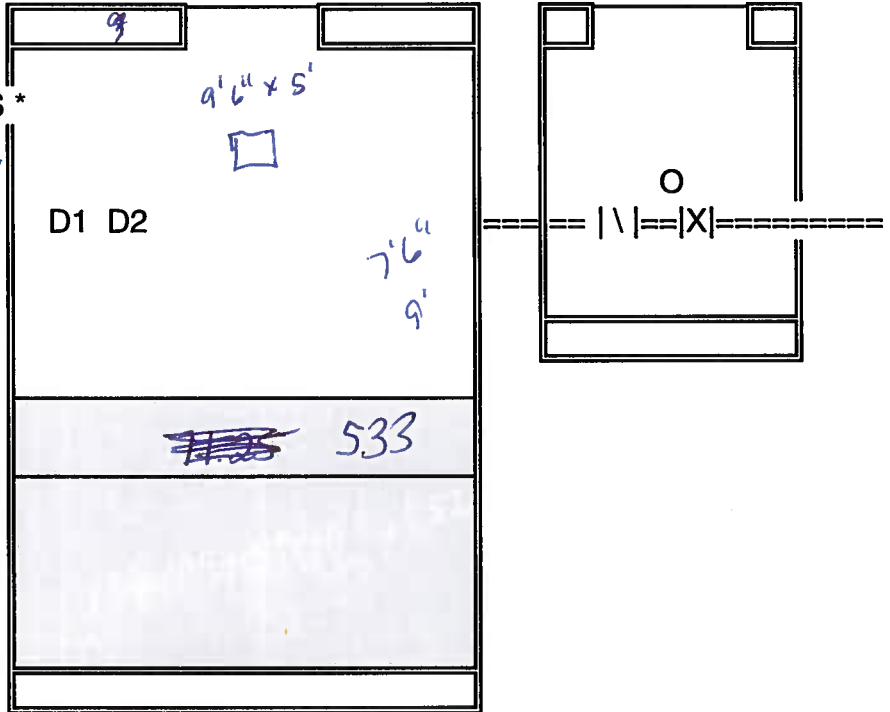

* ALL MEASUREMENTS IN INCHES *

WETWELL DIAMETER 114" X 60"
 9'-6" X 5' =
 ON-LEVEL DEPTH (D1) 90"
 7'-6" =
 OFF LEVEL DEPTH (D2) 108"
 9' =

1. Measure the wet well diameter or rectangular size in inches.
2. When the pump turns on measure the distance from the top of the wet well to the sewage level (D
3. When the pump turns off measure the distance from the top of the wet well to the sewage level (D

Comments: _____

2227

LIFT STATION FLOW CALCULATION WORKSHEET (Lift Stations with RTU)

HARBOR woods

DATE: 3/23/15 TIME: _____:

LOCATION: L.S. 228

WETWELL

VALVEBOX

* ALL MEASUREMENTS IN INCHES *

WETWELL DIAMETER 72"

ON-LEVEL DEPTH (D1) 186"

15'-6" =

OFF LEVEL DEPTH (D2) 204"

17' =

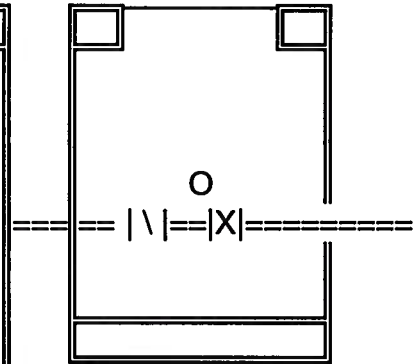
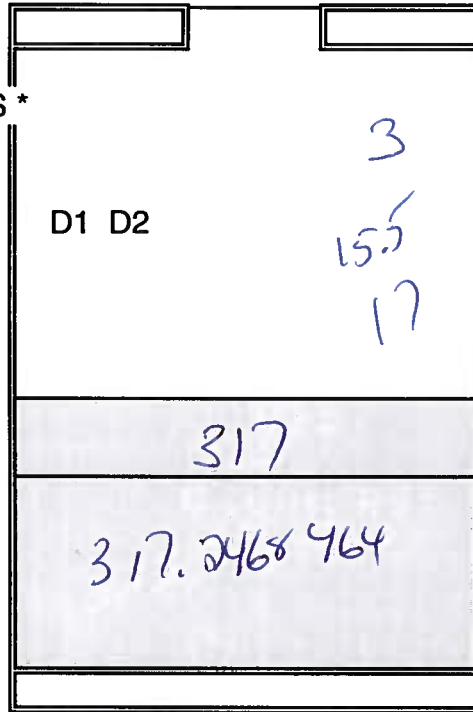

1. Measure the wet well diameter or rectangular size in inches.
2. When the pump turns on measure the distance from the top of the wet well to the sewage level (D)
3. When the pump turns off measure the distance from the top of the wet well to the sewage level (D)

Comments: _____

LIFT STATION FLOW CALCULATION WORKSHEET (Lift Stations with RTU)

21-D

DATE: 3/23/15 TIME: _____:_____

LOCATION: L.S. 229

WETWELL

VALVEBOX

* ALL MEASUREMENTS IN INCHES *

WETWELL DIAMETER 72"

ON-LEVEL DEPTH (D1) 144"
12' =

OFF LEVEL DEPTH (D2) 168"
14' =

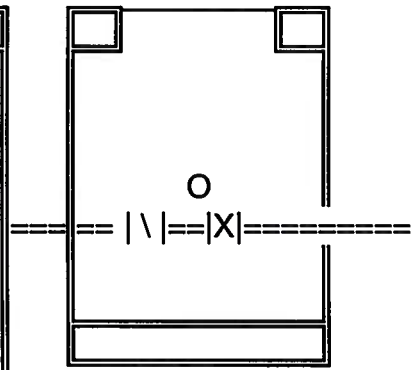
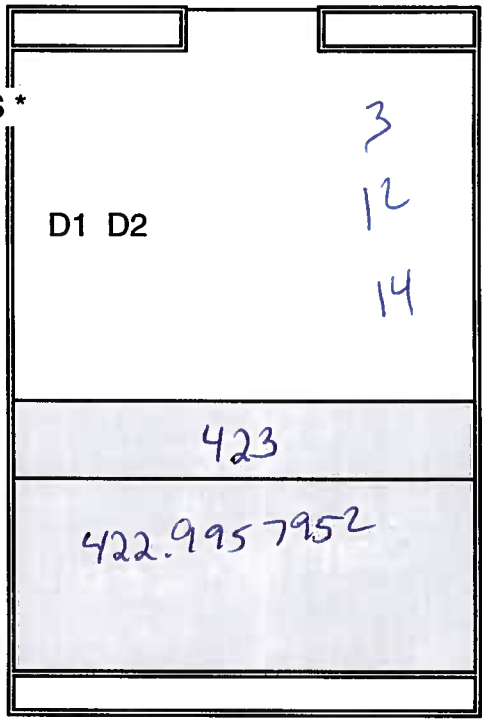

1. Measure the wet well diameter or rectangular size in inches.
2. When the pump turns on measure the distance from the top of the wet well to the sewage level (D)
3. When the pump turns off measure the distance from the top of the wet well to the sewage level (D)

Comments: _____

LIFT STATION FLOW CALCULATION WORKSHEET (Lift Stations with RTU)

7-D

DATE: 3 / 23 / 15 TIME: _____

LOCATION: L.S. 230

WETWELL

VALVEBOX

* ALL MEASUREMENTS IN INCHES *

WETWELL DIAMETER 96"

ON-LEVEL DEPTH (D1) 204"

OFF LEVEL DEPTH (D2) 222"
18'-6"

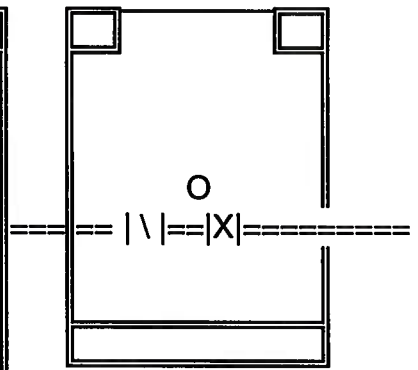
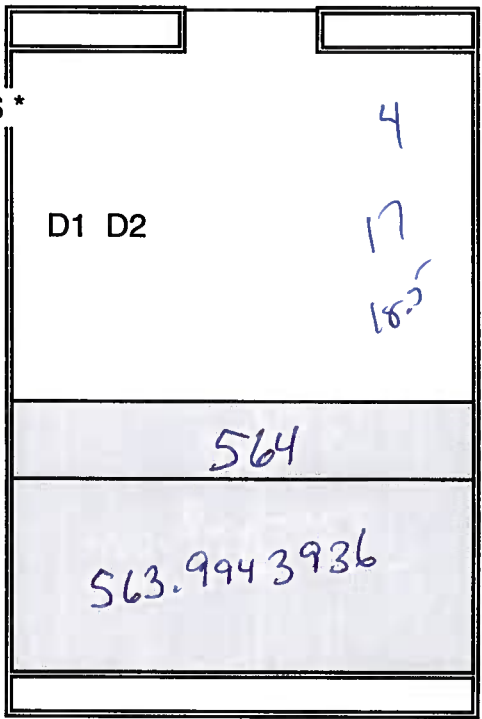

1. Measure the wet well diameter or rectangular size in inches.
2. When the pump turns on measure the distance from the top of the wet well to the sewage level (D)
3. When the pump turns off measure the distance from the top of the wet well to the sewage level (D)

Comments: _____

LIFT STATION FLOW CALCULATION WORKSHEET (Lift Stations with RTU)

DATE: 3 / 23 / 15 TIME: _____

LOCATION: 4-D L.S. 231

WETWELL

VALVEBOX

* ALL MEASUREMENTS IN INCHES *

WETWELL DIAMETER 72"

ON-LEVEL DEPTH (D1) 168"
14' =

OFF LEVEL DEPTH (D2) 186"
15'-6" =

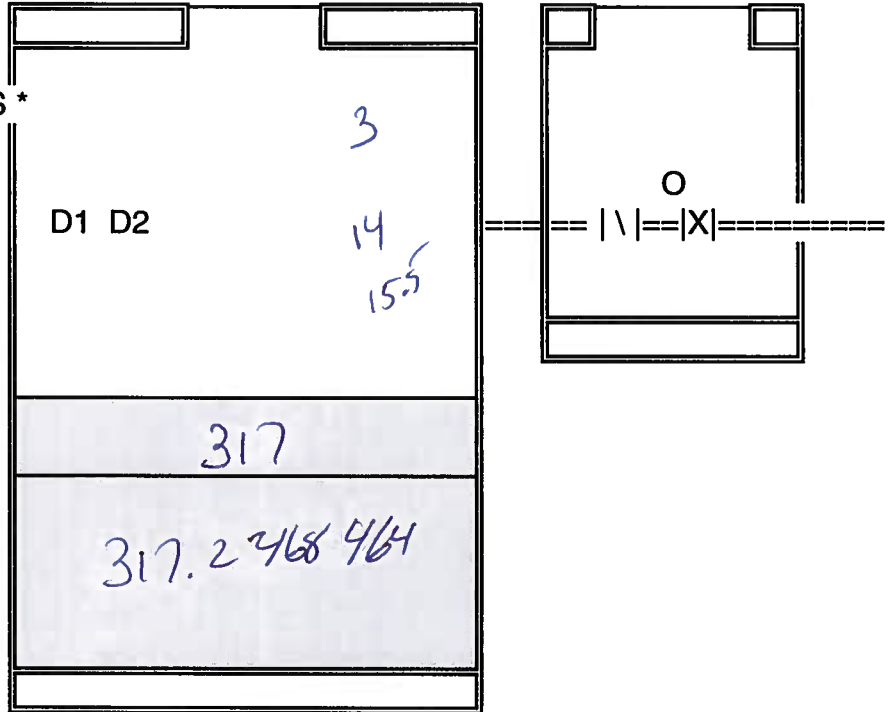

1. Measure the wet well diameter or rectangular size in inches.
2. When the pump turns on measure the distance from the top of the wet well to the sewage level (D)
3. When the pump turns off measure the distance from the top of the wet well to the sewage level (D)

Comments: _____

LIFT STATION FLOW CALCULATION WORKSHEET (Lift Stations with RTU)

DATE: 3/23/15 TIME: _____

LOCATION: 6-D L.S. 232

WETWELL

VALVEBOX

* ALL MEASUREMENTS IN INCHES *

WETWELL DIAMETER 72"

ON-LEVEL DEPTH (D1) 138"
11'-6" =

OFF LEVEL DEPTH (D2) 162"
13'-6" =

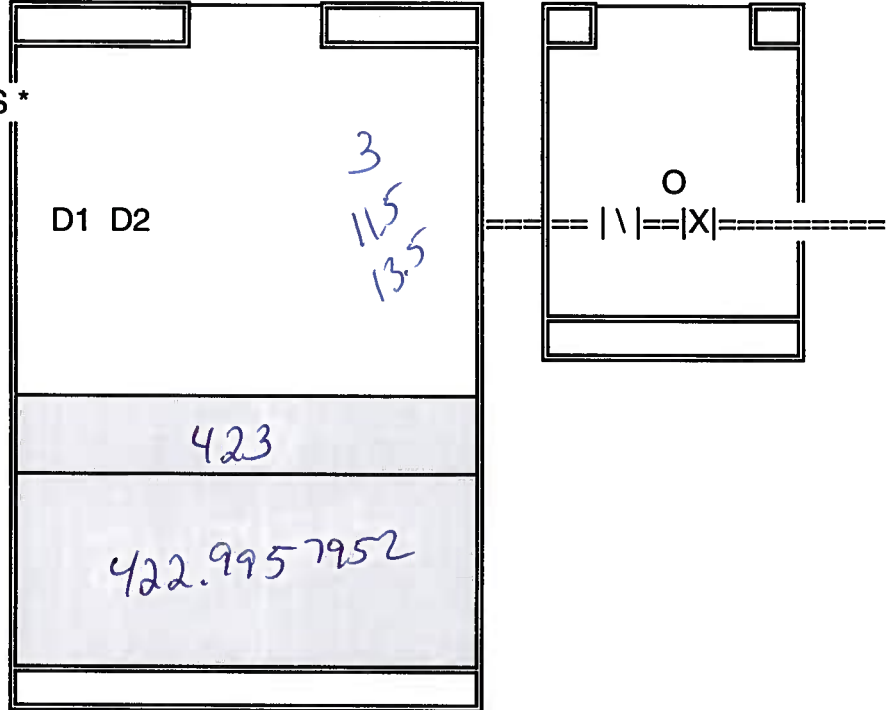

1. Measure the wet well diameter or rectangular size in inches.
2. When the pump turns on measure the distance from the top of the wet well to the sewage level (D)
3. When the pump turns off measure the distance from the top of the wet well to the sewage level (D)

Comments: _____

LIFT STATION FLOW CALCULATION WORKSHEET (Lift Stations with RTU)

3-D

DATE: 3 / 20 / 15 TIME: _____:_____

LOCATION: L.S. 233

WETWELL

VALVEBOX

* ALL MEASUREMENTS IN INCHES *

WETWELL DIAMETER 96"

ON-LEVEL DEPTH (D1) 150"
12'-6" =

OFF LEVEL DEPTH (D2) 168"
14' =

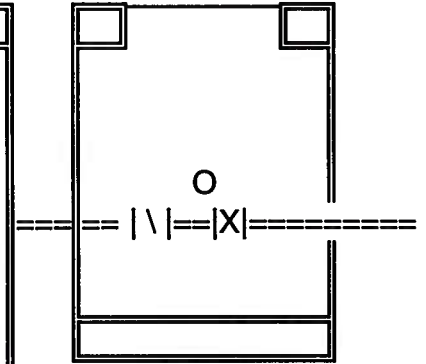
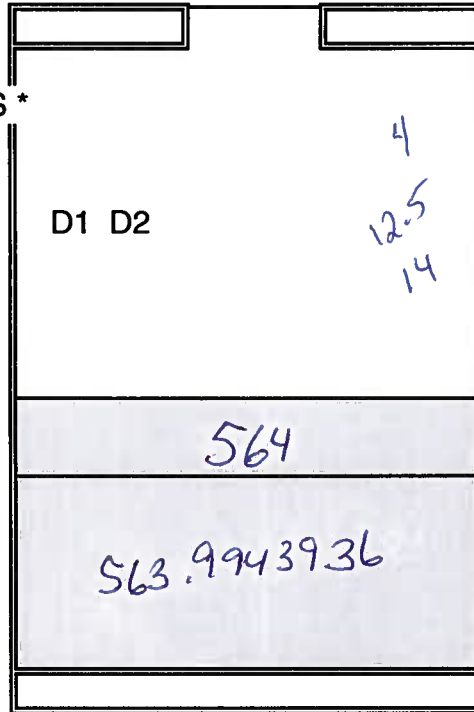

1. Measure the wet well diameter or rectangular size in inches.
2. When the pump turns on measure the distance from the top of the wet well to the sewage level (D)
3. When the pump turns off measure the distance from the top of the wet well to the sewage level (D)

Comments: _____

LIFT STATION FLOW CALCULATION WORKSHEET (Lift Stations with RTU)

20-D

DATE: 3 / 20 / 15 TIME: _____:_____

LOCATION: L.S. 234

WETWELL

VALVEBOX

* ALL MEASUREMENTS IN INCHES *

WETWELL DIAMETER 72"

ON-LEVEL DEPTH (D1) 186"

15' 6" =

OFF LEVEL DEPTH (D2) 204"

17' 0"

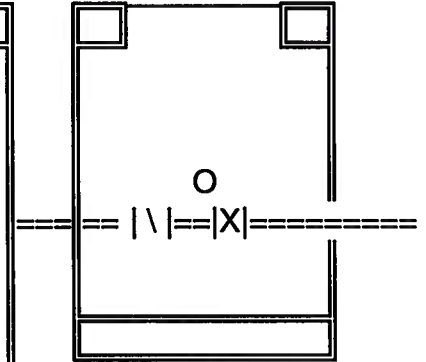
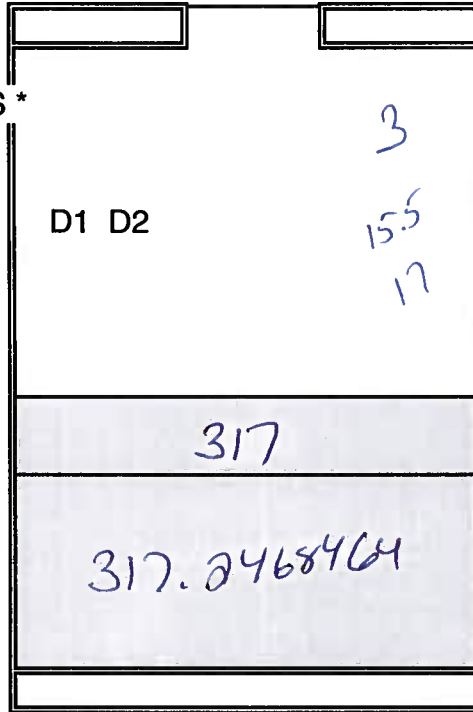

1. Measure the wet well diameter or rectangular size in inches.
2. When the pump turns on measure the distance from the top of the wet well to the sewage level (D)
3. When the pump turns off measure the distance from the top of the wet well to the sewage level (D)

Comments: _____

LIFT STATION FLOW CALCULATION WORKSHEET (Lift Stations with RTU)

DATE: 3 / 20 / 15 TIME: _____

LOCATION: 5-D L.S. 235

WETWELL

VALVEBOX

* ALL MEASUREMENTS IN INCHES *

WETWELL DIAMETER 72"

ON-LEVEL DEPTH (D1) 60"

OFF LEVEL DEPTH (D2) 24"

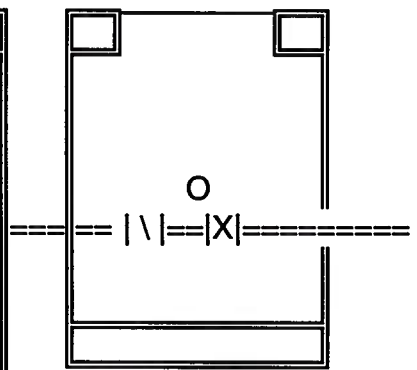
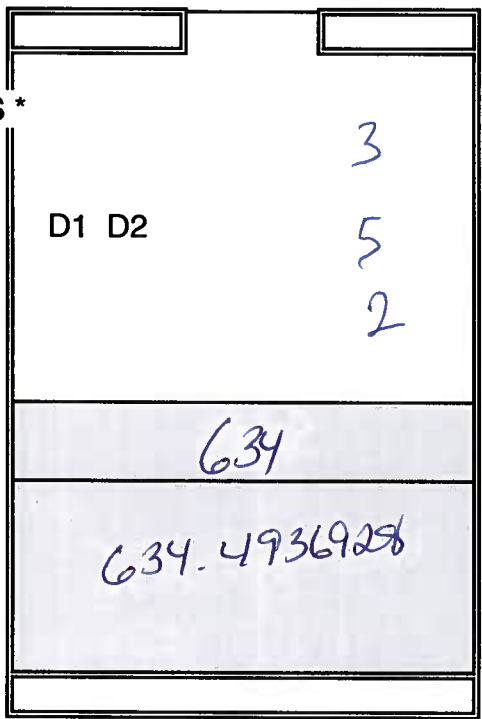

1. Measure the wet well diameter or rectangular size in inches.
2. When the pump turns on measure the distance from the top of the wet well to the sewage level (D)
3. When the pump turns off measure the distance from the top of the wet well to the sewage level (D)

Comments: STATION RUNS ON TRANSDUCER

LIFT STATION FLOW CALCULATION WORKSHEET (Lift Stations with RTU)

DATE: 3/20/15 TIME: _____:

LOCATION: 2.P
L.S. 236

WETWELL

VALVEBOX

* ALL MEASUREMENTS IN INCHES *

WETWELL DIAMETER 96"

ON-LEVEL DEPTH (D1) 204"
17' =

OFF LEVEL DEPTH (D2) 240"
19' =

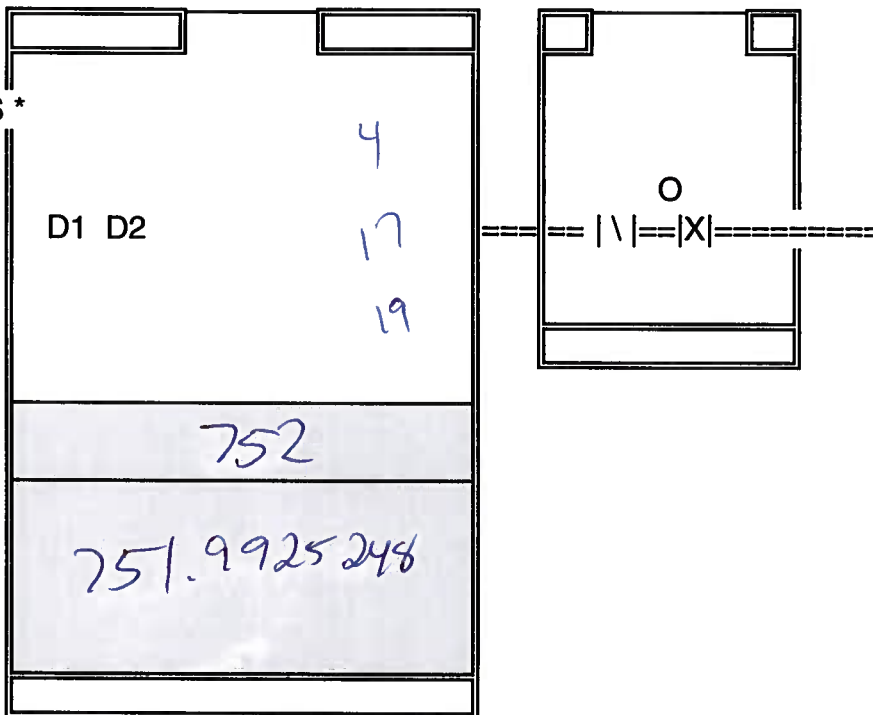

1. Measure the wet well diameter or rectangular size in inches.
2. When the pump turns on measure the distance from the top of the wet well to the sewage level (D1)
3. When the pump turns off measure the distance from the top of the wet well to the sewage level (D2)

Comments: _____

LIFT STATION FLOW CALCULATION WORKSHEET (Lift Stations with RTU)

DATE: ___/___/___ TIME: ___:___

LOCATION: 33-A 238

WETWELL

VALVEBOX

* ALL MEASUREMENTS IN INCHES *

WETWELL DIAMETER 97

ON-LEVEL DEPTH (D1) 232

OFF LEVEL DEPTH (D2) 243

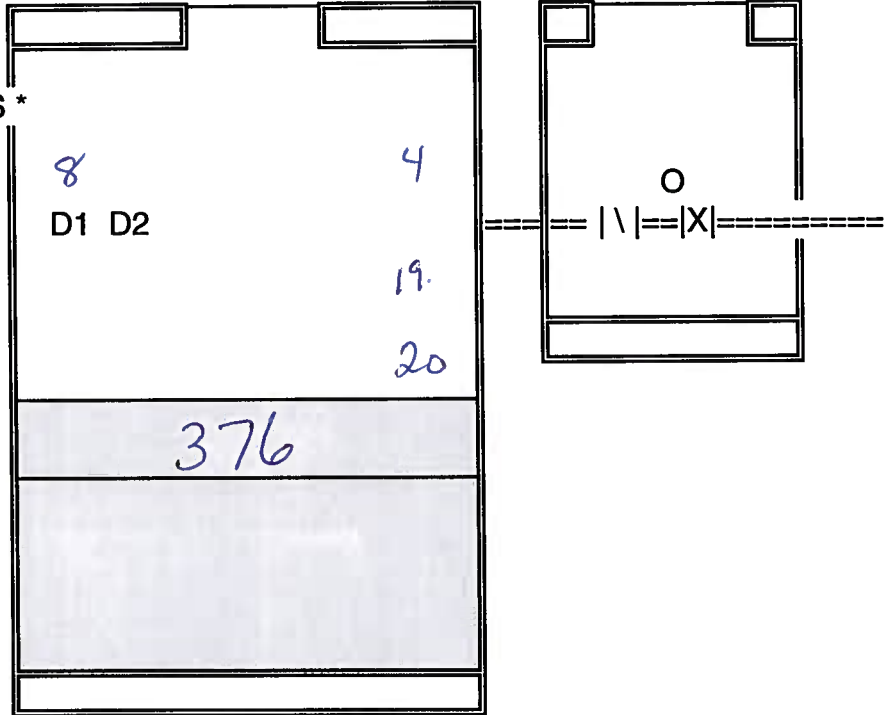

1. Measure the wet well diameter or rectangular size in inches.
2. When the pump turns on measure the distance from the top of the wet well to the sewage level (D
3. When the pump turns off measure the distance from the top of the wet well to the sewage level (D

Comments: _____

LIFT STATION FLOW CALCULATION WORKSHEET (Lift Stations with RTU)

DATE: ___/___/___ TIME: ___:___

LOCATION: 34-A 239

WETWELL

VALVEBOX

* ALL MEASUREMENTS IN INCHES *

WETWELL DIAMETER 114

ON-LEVEL DEPTH (D1) 226

OFF LEVEL DEPTH (D2) 259

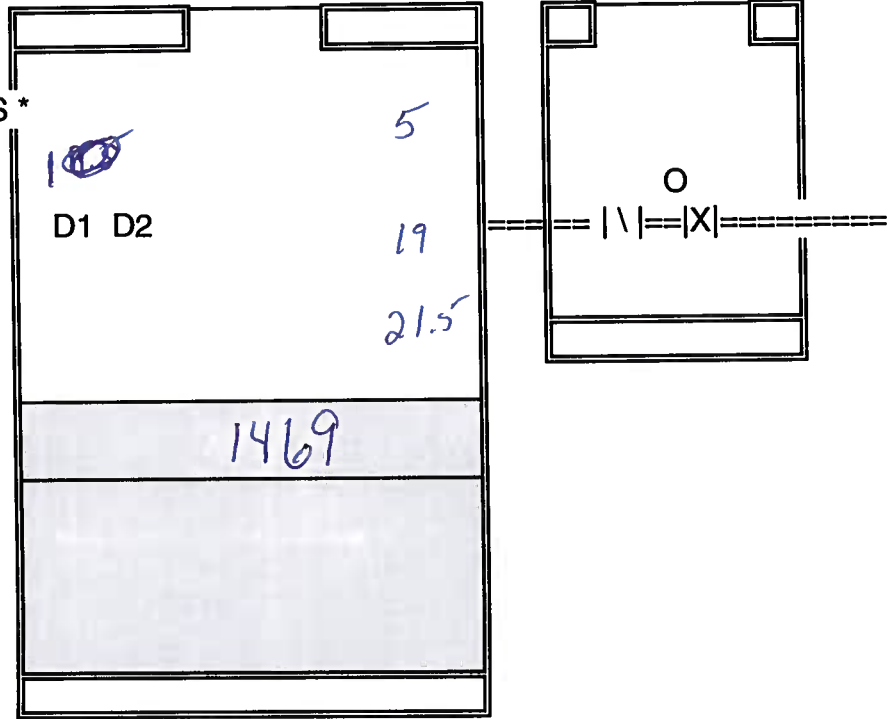

1. Measure the wet well diameter or rectangular size in inches.
2. When the pump turns on measure the distance from the top of the wet well to the sewage level (D)
3. When the pump turns off measure the distance from the top of the wet well to the sewage level (D)

Comments: _____

LIFT STATION FLOW CALCULATION WORKSHEET (Lift Stations with RTU)

River Harbor West

DATE: 3/19/15 TIME: _____:

LOCATION: L.S. 242

WETWELL

VALVEBOX

* ALL MEASUREMENTS IN INCHES *

WETWELL DIAMETER 72"

ON-LEVEL DEPTH (D1) 150"
12'-6" =

OFF LEVEL DEPTH (D2) 174"
14'-6" =

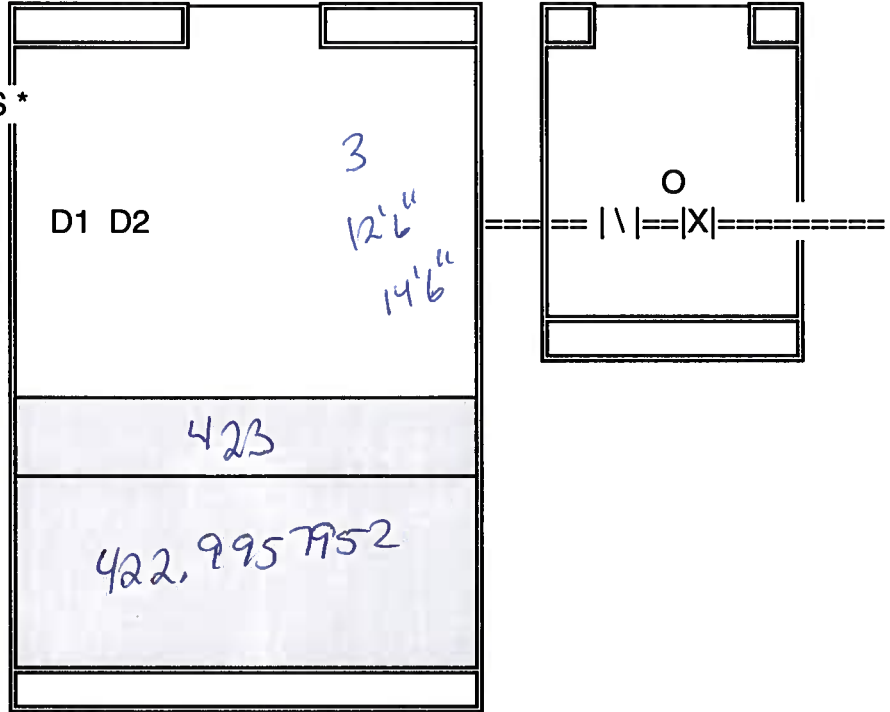

1. Measure the wet well diameter or rectangular size in inches.
2. When the pump turns on measure the distance from the top of the wet well to the sewage level (D)
3. When the pump turns off measure the distance from the top of the wet well to the sewage level (D)

Comments: _____

2243

LIFT STATION FLOW CALCULATION WORKSHEET (Lift Stations with RTU)

SUNSET ESTATES

DATE: 3 / 19 / 15 TIME: _____:

LOCATION: L.S. 243

WETWELL

VALVEBOX

* ALL MEASUREMENTS IN INCHES *

WETWELL DIAMETER 72"

ON-LEVEL DEPTH (D1) 180"

15'

OFF LEVEL DEPTH (D2) 204"

17'

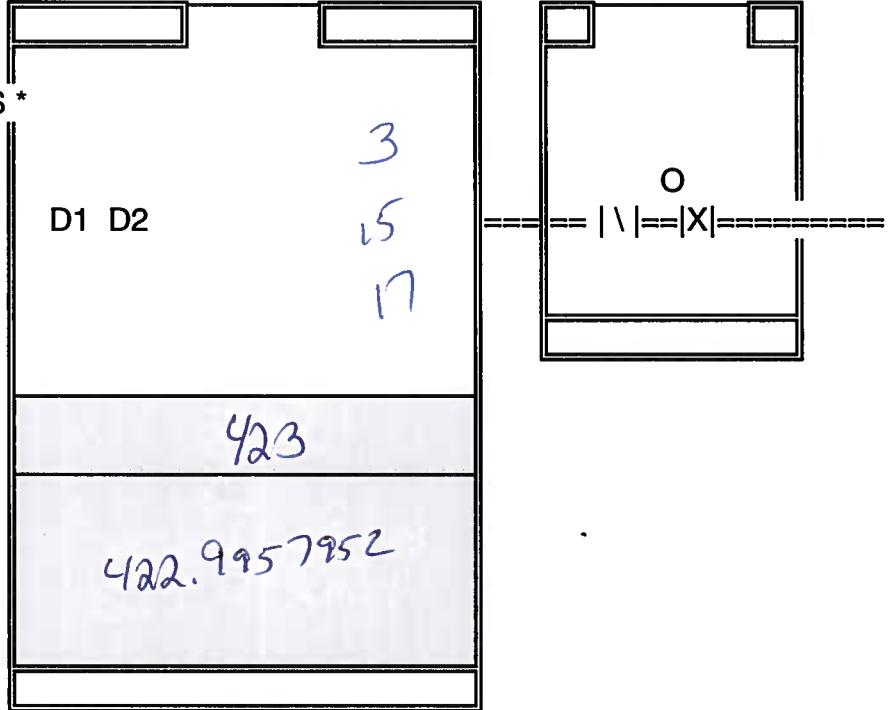

1. Measure the wet well diameter or rectangular size in inches.
2. When the pump turns on measure the distance from the top of the wet well to the sewage level (D1)
3. When the pump turns off measure the distance from the top of the wet well to the sewage level (D2)

Comments: _____

2025

LIFT STATION FLOW CALCULATION WORKSHEET (Lift Stations with RTU)

Broome Park

DATE: 3/23/15 TIME: _____

LOCATION: L.S. 245

WETWELL

VALVEBOX

* ALL MEASUREMENTS IN INCHES *

WETWELL DIAMETER 72"

ON-LEVEL DEPTH (D1) 186"
15'6" =

OFF LEVEL DEPTH (D2) 210"
17'6" =

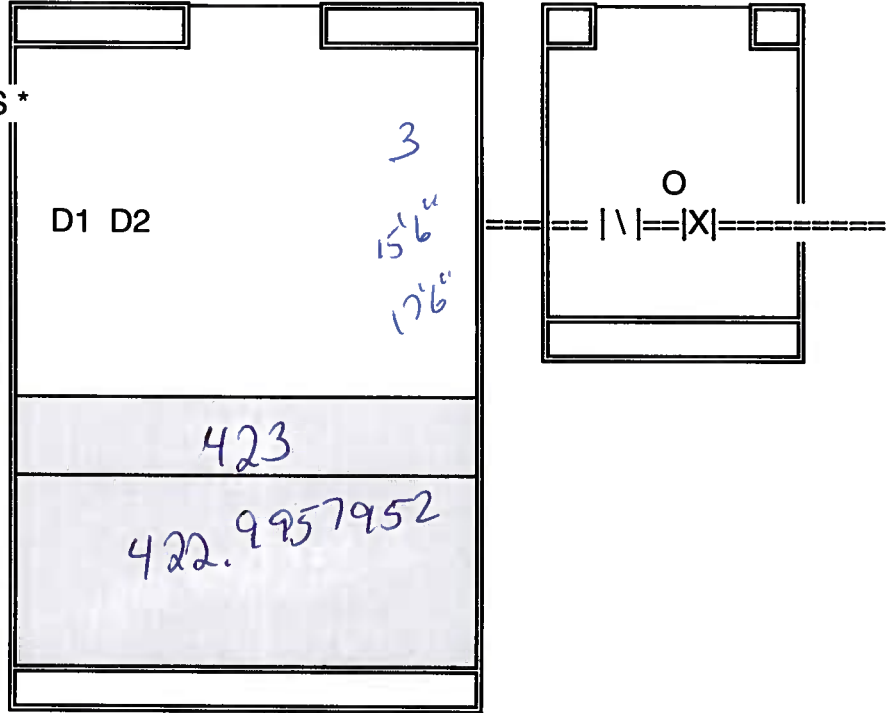

1. Measure the wet well diameter or rectangular size in inches.
2. When the pump turns on measure the distance from the top of the wet well to the sewage level (D)
3. When the pump turns off measure the distance from the top of the wet well to the sewage level (D)

Comments: _____

LIFT STATION FLOW CALCULATION WORKSHEET (Lift Stations with RTU)

AZALEA PARK 2246

DATE: 3/13/15 TIME: _____

LOCATION: L.S. 246

WETWELL

VALVEBOX

* ALL MEASUREMENTS IN INCHES *

WETWELL DIAMETER 72"

ON-LEVEL DEPTH (D1) 216"
18' 0"

OFF LEVEL DEPTH (D2) 234"
19' 6"

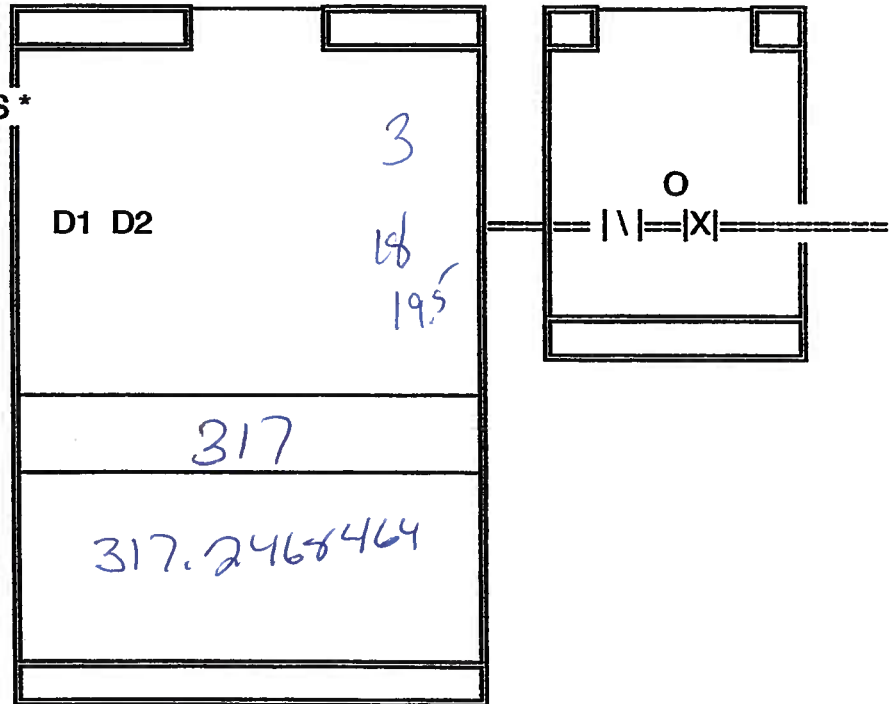

1. Measure the wet well diameter or rectangular size in inches.
2. When the pump turns on measure the distance from the top of the wet well to the sewage level (D1)
3. When the pump turns off measure the distance from the top of the wet well to the sewage level (D2)

Comments: _____

LIFT STATION FLOW CALCULATION WORKSHEET (Lift Stations with RTU)

DATE: 3/13/15 TIME: _____:

LOCATION: 23-D
L.S. 247

WETWELL

VALVEBOX

* ALL MEASUREMENTS IN INCHES *

WETWELL DIAMETER 72"

ON-LEVEL DEPTH (D1) 210"
17'-6" =

OFF LEVEL DEPTH (D2) 228"
19' =

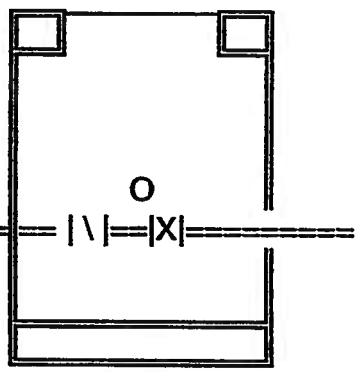
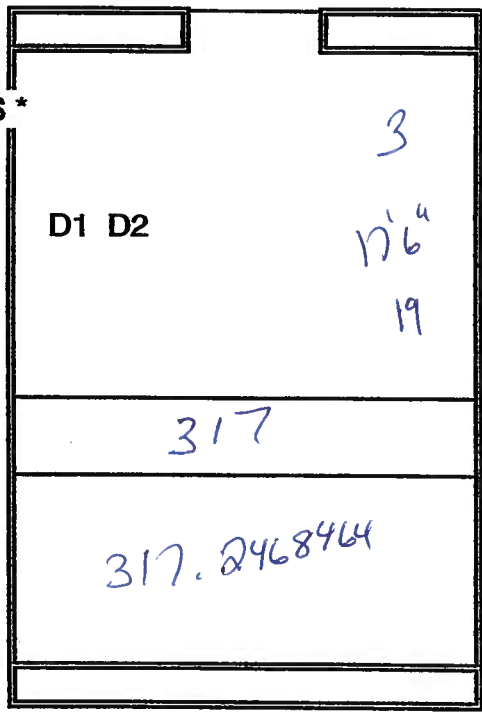

1. Measure the wet well diameter or rectangular size in inches.
2. When the pump turns on measure the distance from the top of the wet well to the sewage level (D1)
3. When the pump turns off measure the distance from the top of the wet well to the sewage level (D2)

Comments: _____

LIFT STATION FLOW CALCULATION WORKSHEET (Lift Stations with RTU)

DATE: ___/___/___ TIME: ___:___

LOCATION: 30-AA 248

WETWELL

VALVEBOX

* ALL MEASUREMENTS IN INCHES *

WETWELL DIAMETER 138" x 70"

ON-LEVEL DEPTH (D1) 188

OFF LEVEL DEPTH (D2) 220

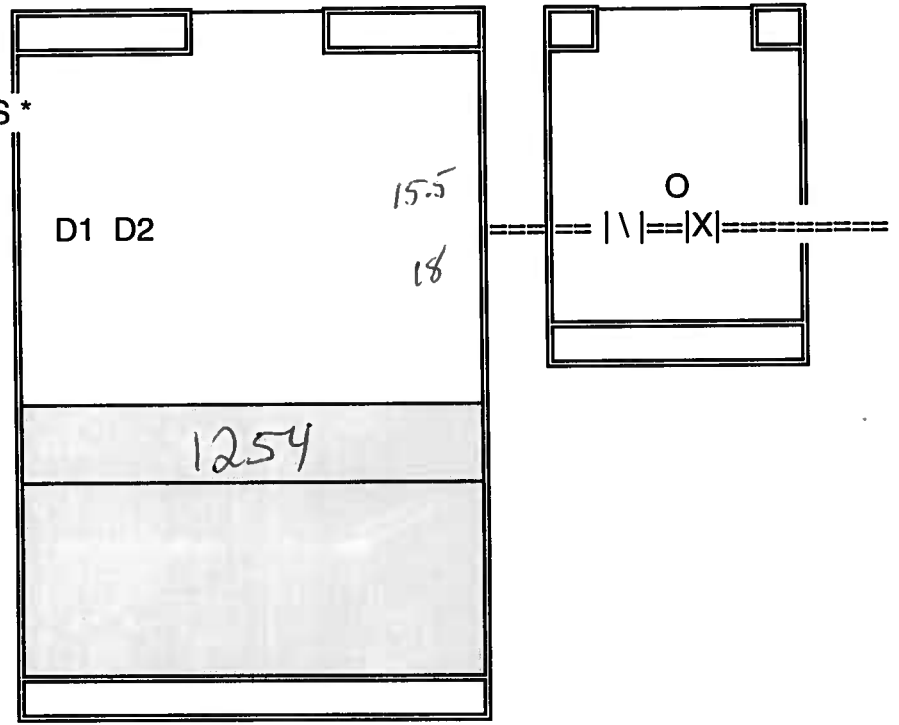

1. Measure the wet well diameter or rectangular size in inches.
2. When the pump turns on measure the distance from the top of the wet well to the sewage level (D)
3. When the pump turns off measure the distance from the top of the wet well to the sewage level (D)

Comments: _____

LIFT STATION FLOW CALCULATION WORKSHEET (Lift Stations with RTU)

FIDDLERS GREEN

DATE: 3/19/15 TIME: _____:_____

LOCATION: L.S. 250

WETWELL

VALVEBOX

* ALL MEASUREMENTS IN INCHES *

WETWELL DIAMETER 48"

ON-LEVEL DEPTH (D1) 156"
13' =

OFF LEVEL DEPTH (D2) 180"
15' =

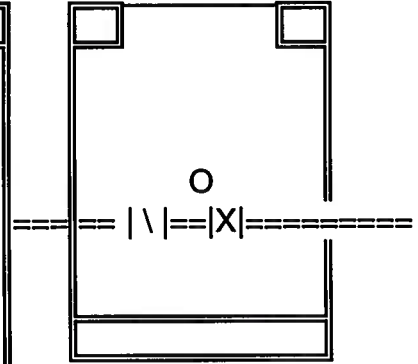
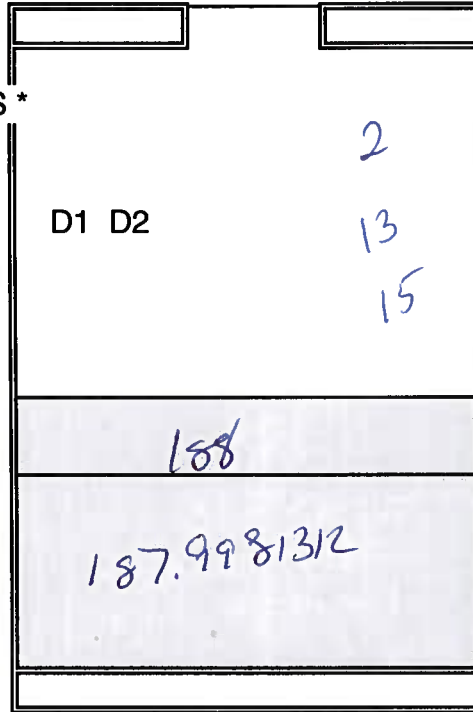

1. Measure the wet well diameter or rectangular size in inches.
2. When the pump turns on measure the distance from the top of the wet well to the sewage level (D1)
3. When the pump turns off measure the distance from the top of the wet well to the sewage level (D2)

Comments: _____

LIFT STATION FLOW CALCULATION WORKSHEET (Lift Stations with RTU)

Hawthorn Park

DATE: 3/16/15 TIME: _____:

LOCATION: L.S. 251

WETWELL

VALVEBOX

* ALL MEASUREMENTS IN INCHES *

WETWELL DIAMETER 72"

ON-LEVEL DEPTH (D1) 162"
13'-6" =

OFF LEVEL DEPTH (D2) 186"
15'-6" =

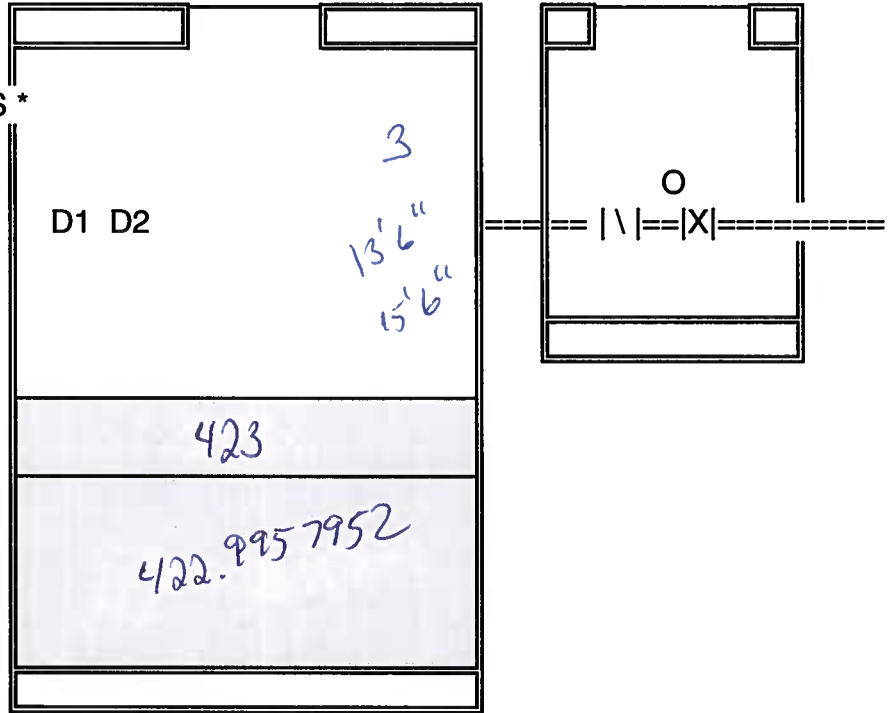

1. Measure the wet well diameter or rectangular size in inches.
2. When the pump turns on measure the distance from the top of the wet well to the sewage level (D)
3. When the pump turns off measure the distance from the top of the wet well to the sewage level (D)

Comments: _____

LIFT STATION FLOW CALCULATION WORKSHEET (Lift Stations with RTU)

~~257~~

PALMA SOLA BALL PARK 257

DATE: 3/23/15 TIME: _____:

LOCATION: L.S. 257

WETWELL

VALVEBOX

* ALL MEASUREMENTS IN INCHES *

WETWELL DIAMETER 48"

ON-LEVEL DEPTH (D1) 90"

7'-6" =

OFF LEVEL DEPTH (D2) 102"

8'-6" =

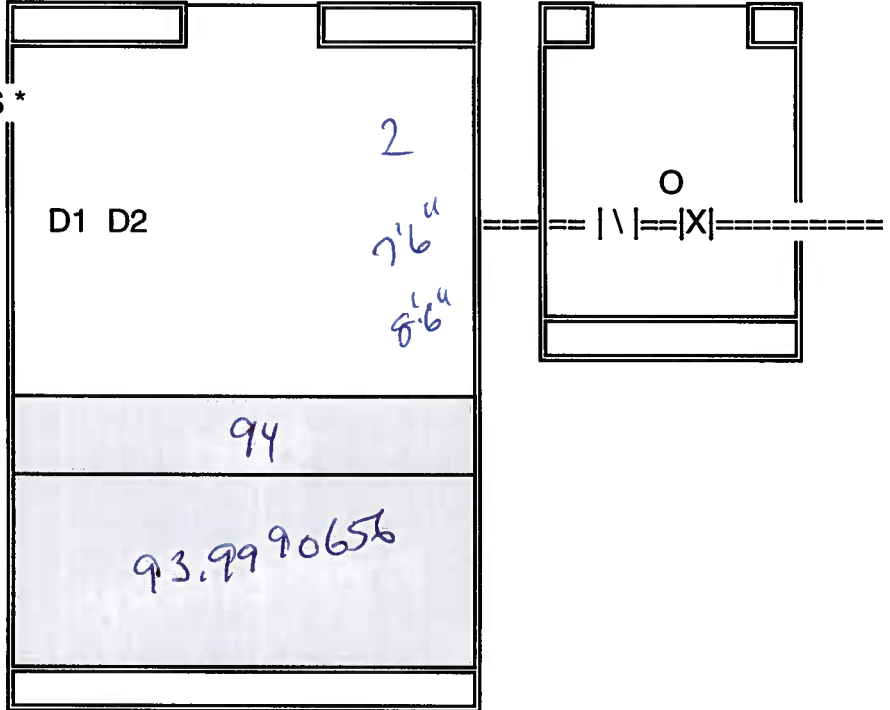

1. Measure the wet well diameter or rectangular size in inches.
2. When the pump turns on measure the distance from the top of the wet well to the sewage level (D)
3. When the pump turns off measure the distance from the top of the wet well to the sewage level (D)

Comments: _____

LIFT STATION FLOW CALCULATION WORKSHEET (Lift Stations with RTU)

25-D

DATE: 3 / 19 / 15 TIME: _____:

LOCATION: L.S. 258

WETWELL

VALVEBOX

* ALL MEASUREMENTS IN INCHES *

WETWELL DIAMETER 48"

ON-LEVEL DEPTH (D1) 138"

11'-6" =

OFF LEVEL DEPTH (D2) 150"

12'-6" =

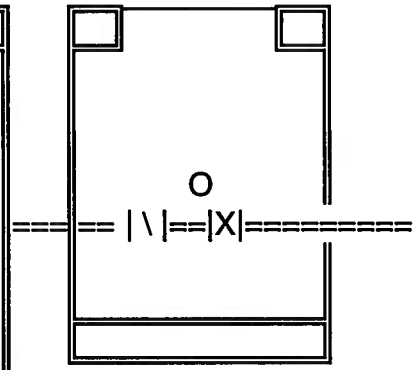
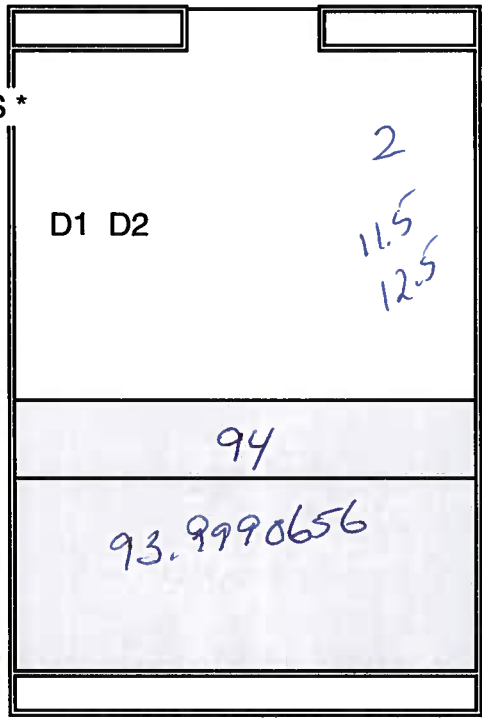

1. Measure the wet well diameter or rectangular size in inches.
2. When the pump turns on measure the distance from the top of the wet well to the sewage level (D1)
3. When the pump turns off measure the distance from the top of the wet well to the sewage level (D2)

Comments: _____

LIFT STATION FLOW CALCULATION WORKSHEET (Lift Stations with RTU)

DATE: 3/20/15 TIME: _____:

LOCATION: 26-D
L.S. 259

WETWELL

VALVEBOX

* ALL MEASUREMENTS IN INCHES *

WETWELL DIAMETER 48"

ON-LEVEL DEPTH (D1) 108"
9' =

OFF LEVEL DEPTH (D2) 132"
11' =

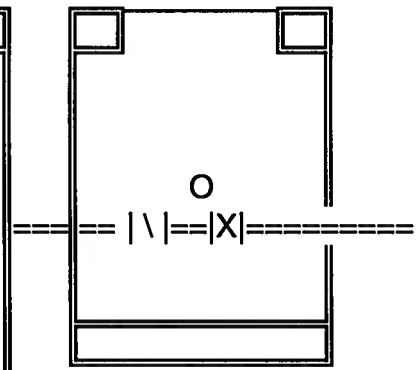
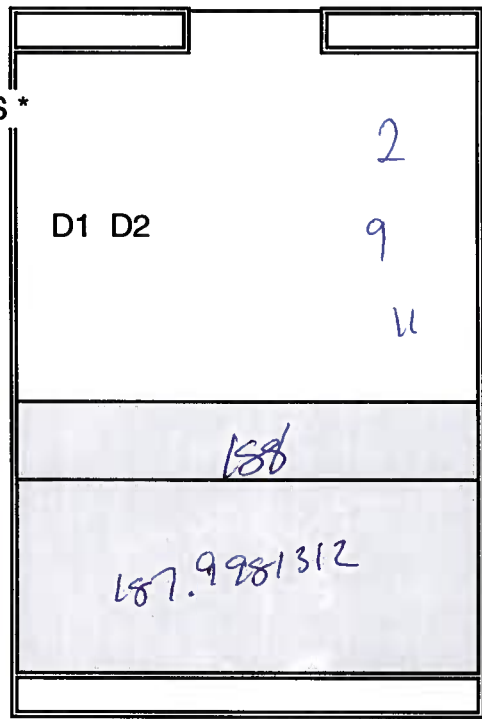

1. Measure the wet well diameter or rectangular size in inches.
2. When the pump turns on measure the distance from the top of the wet well to the sewage level (D)
3. When the pump turns off measure the distance from the top of the wet well to the sewage level (D)

Comments: _____

LIFT STATION FLOW CALCULATION WORKSHEET (Lift Stations with RTU)

DATE: ___/___/___ TIME: ___:___

LOCATION: BOLLETTIERI PARK 260

WETWELL

VALVEBOX

* ALL MEASUREMENTS IN INCHES *

WETWELL DIAMETER 120

ON-LEVEL DEPTH (D1) 208

OFF LEVEL DEPTH (D2) 247

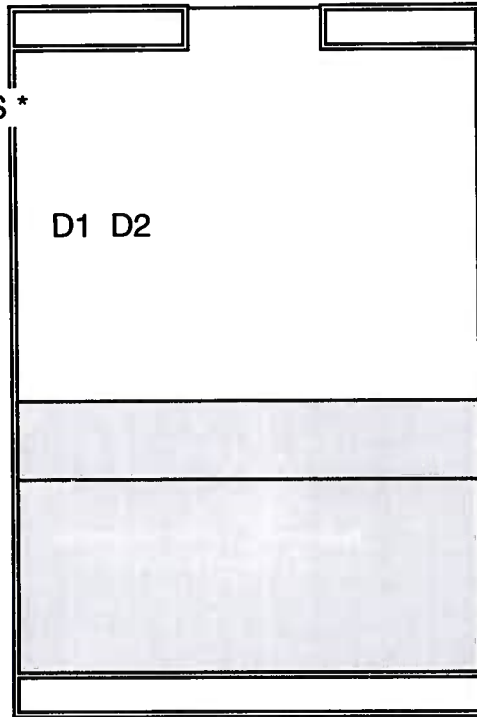

Dia = 10'
on = 20.58'
off = 17.33'
Volume = 1909

1. Measure the wet well diameter or rectangular size in inches.
2. When the pump turns on measure the distance from the top of the wet well to the sewage level (D)
3. When the pump turns off measure the distance from the top of the wet well to the sewage level (D)

Comments: _____

1909 gal

D = 10'

LIFT STATION FLOW CALCULATION WORKSHEET (Lift Stations with RTU)

MANATEE CTY. GOLF COURSE

DATE: 3/20/15 TIME: _____

LOCATION: L.S. 261

WETWELL

VALVEBOX

* ALL MEASUREMENTS IN INCHES *

WETWELL DIAMETER 48"

ON-LEVEL DEPTH (D1) 66"
5'-6" =

OFF LEVEL DEPTH (D2) 78"
6'-6" =

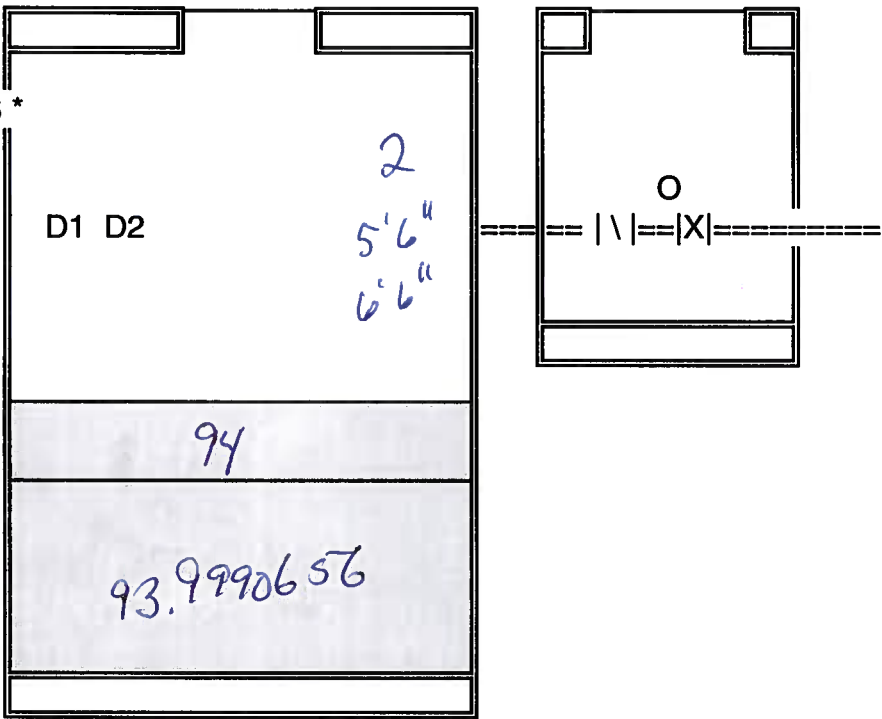

1. Measure the wet well diameter or rectangular size in inches.
2. When the pump turns on measure the distance from the top of the wet well to the sewage level (D1)
3. When the pump turns off measure the distance from the top of the wet well to the sewage level (D2)

Comments: _____

LIFT STATION FLOW CALCULATION WORKSHEET (Lift Stations with RTU)

DATE: 3/19/15 TIME: _____:

LOCATION: COLONIAK woods
L.S. 262

WETWELL

VALVEBOX

* ALL MEASUREMENTS IN INCHES *

WETWELL DIAMETER 72"

ON-LEVEL DEPTH (D1) 156"

13'

OFF LEVEL DEPTH (D2) 174"

14'-6"

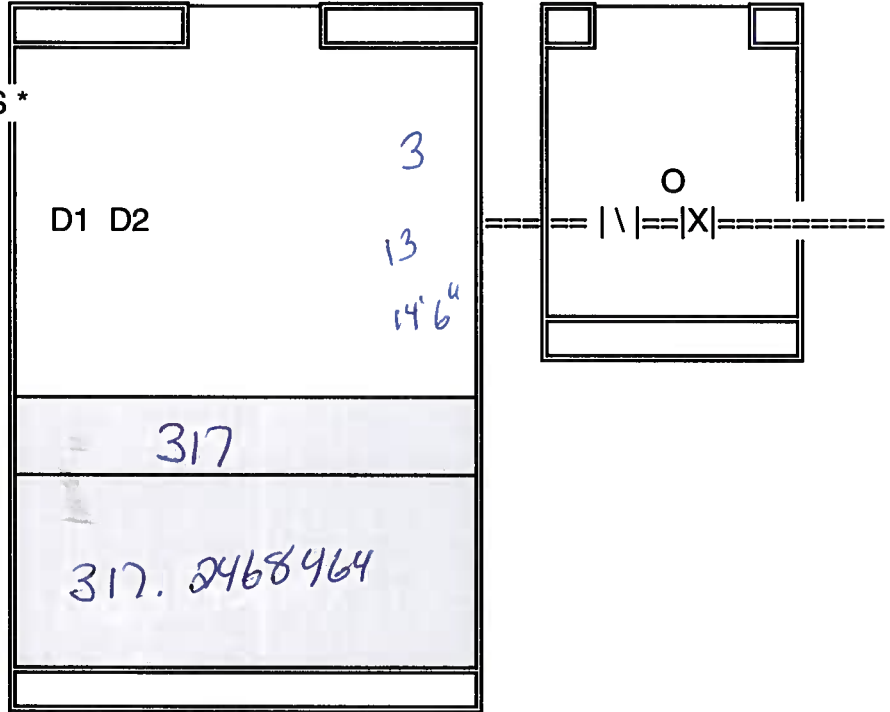

1. Measure the wet well diameter or rectangular size in inches.
2. When the pump turns on measure the distance from the top of the wet well to the sewage level (D1)
3. When the pump turns off measure the distance from the top of the wet well to the sewage level (D2)

Comments: _____

212

LIFT STATION FLOW CALCULATION WORKSHEET (Lift Stations with RTU)

WISTERIA PARK

DATE: 3 / 19 / 15 TIME: _____

LOCATION: L.S. 263

WETWELL

VALVEBOX

* ALL MEASUREMENTS IN INCHES *

WETWELL DIAMETER 72"

ON-LEVEL DEPTH (D1) 168"
14' 0"

OFF LEVEL DEPTH (D2) 186"
15' 6"

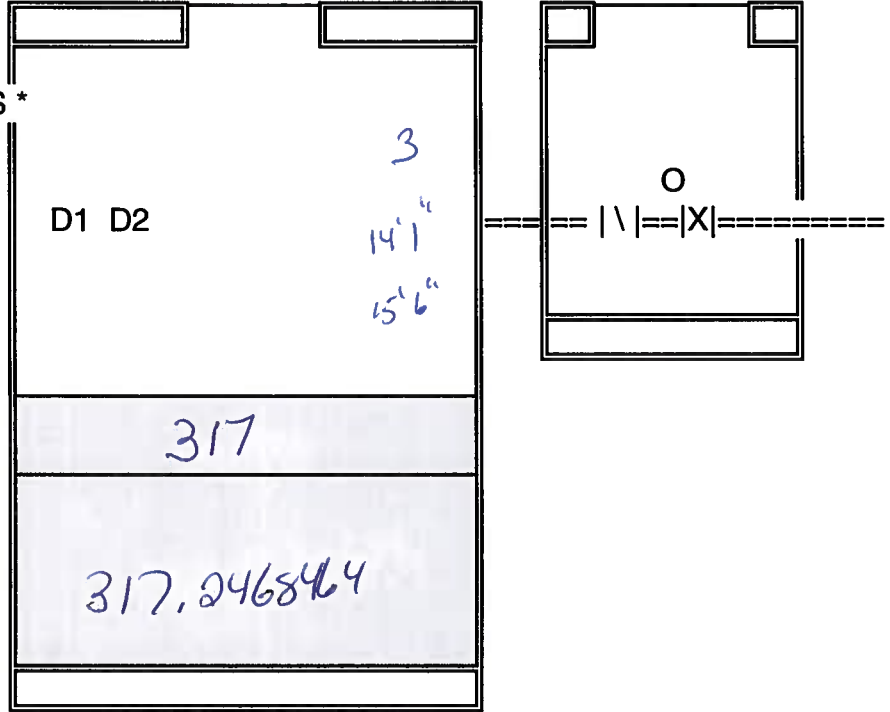

1. Measure the wet well diameter or rectangular size in inches.
2. When the pump turns on measure the distance from the top of the wet well to the sewage level (D1)
3. When the pump turns off measure the distance from the top of the wet well to the sewage level (D2)

Comments: _____

LIFT STATION FLOW CALCULATION WORKSHEET (Lift Stations with RTU)

THE NURSERY

DATE: 3/19/15 TIME: _____:

LOCATION: C.S. 264

WETWELL

VALVEBOX

* ALL MEASUREMENTS IN INCHES *

WETWELL DIAMETER 72"

ON-LEVEL DEPTH (D1) 192"
16' =

OFF LEVEL DEPTH (D2) 210"
17'-6" =

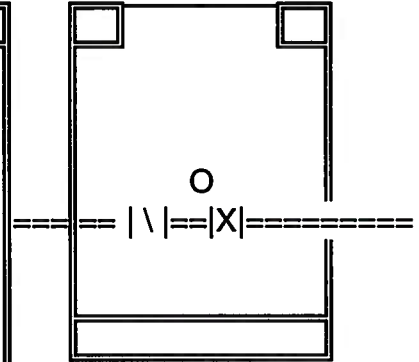
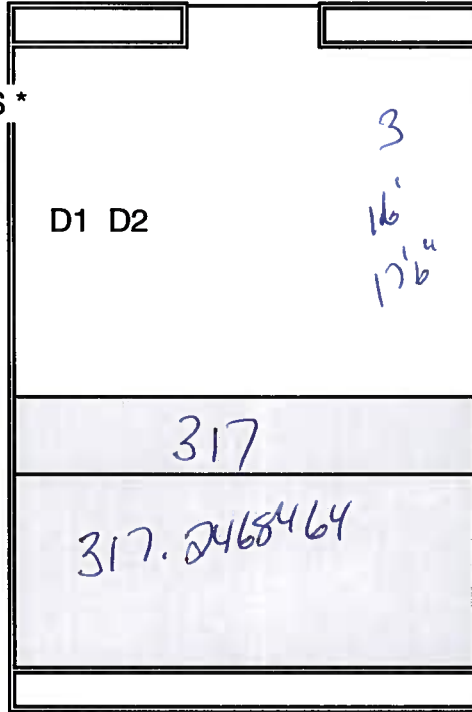

1. Measure the wet well diameter or rectangular size in inches.
2. When the pump turns on measure the distance from the top of the wet well to the sewage level (D1)
3. When the pump turns off measure the distance from the top of the wet well to the sewage level (D2)

Comments: _____

LIFT STATION FLOW CALCULATION WORKSHEET (Lift Stations with RTU)

87th ST. CT. NW

DATE: 3/16/15 TIME: _____:

LOCATION: L.S. 265

WETWELL

VALVEBOX

* ALL MEASUREMENTS IN INCHES *

WETWELL DIAMETER 48"

ON-LEVEL DEPTH (D1) 108"
9' =

OFF LEVEL DEPTH (D2) 132"
11' =

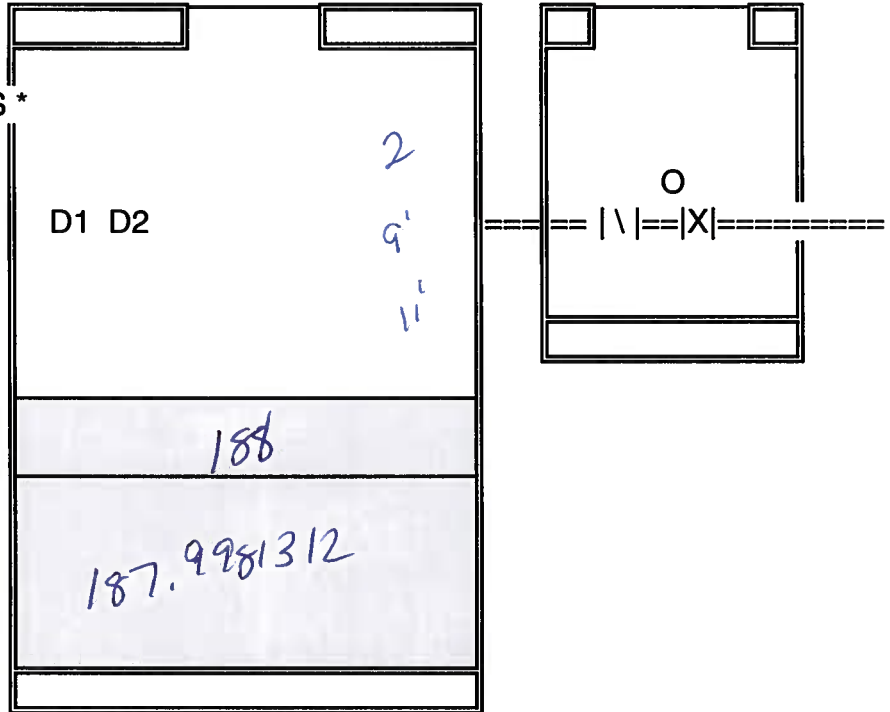

1. Measure the wet well diameter or rectangular size in inches.
2. When the pump turns on measure the distance from the top of the wet well to the sewage level (D1)
3. When the pump turns off measure the distance from the top of the wet well to the sewage level (D2)

Comments: _____

LIFT STATION FLOW CALCULATION WORKSHEET (Lift Stations with RTU)

ROBINSON PRES. 1

DATE: 3/16/15 TIME: _____:

LOCATION: L.S. 267

WETWELL

VALVEBOX

* ALL MEASUREMENTS IN INCHES *

WETWELL DIAMETER 48"

ON-LEVEL DEPTH (D1) 60"

OFF LEVEL DEPTH (D2) 78"

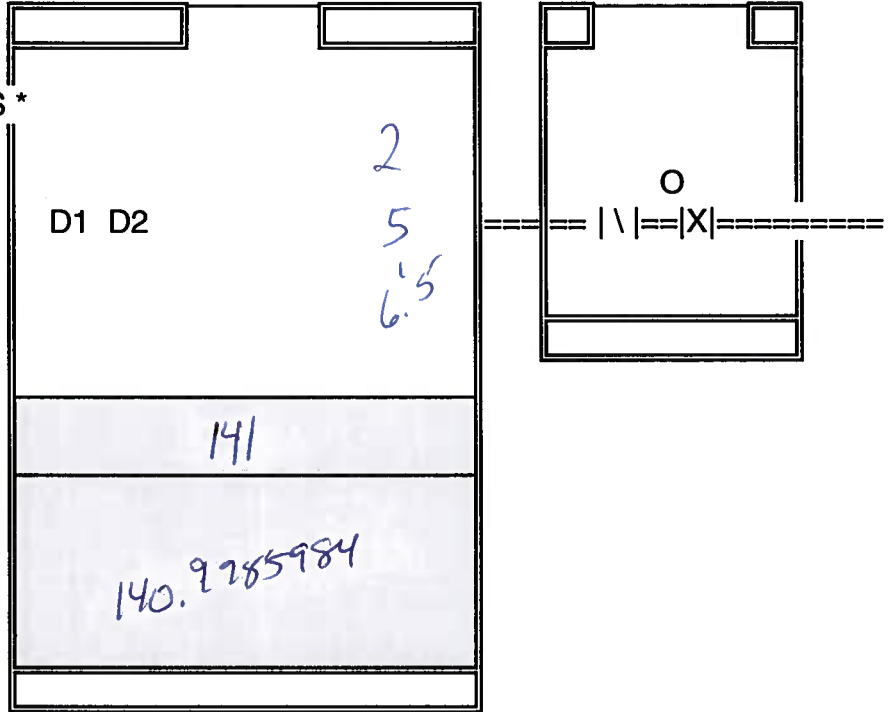

1. Measure the wet well diameter or rectangular size in inches.
2. When the pump turns on measure the distance from the top of the wet well to the sewage level (D
3. When the pump turns off measure the distance from the top of the wet well to the sewage level (D

Comments: _____

LIFT STATION FLOW CALCULATION WORKSHEET (Lift Stations with RTU)

ROBINSON PRESS. 2

DATE: 3 / 14 / 15 TIME: _____:

LOCATION: L.S. 268

WETWELL

VALVEBOX

* ALL MEASUREMENTS IN INCHES *

WETWELL DIAMETER 36"

ON-LEVEL DEPTH (D1) 42"

OFF LEVEL DEPTH (D2) 48"

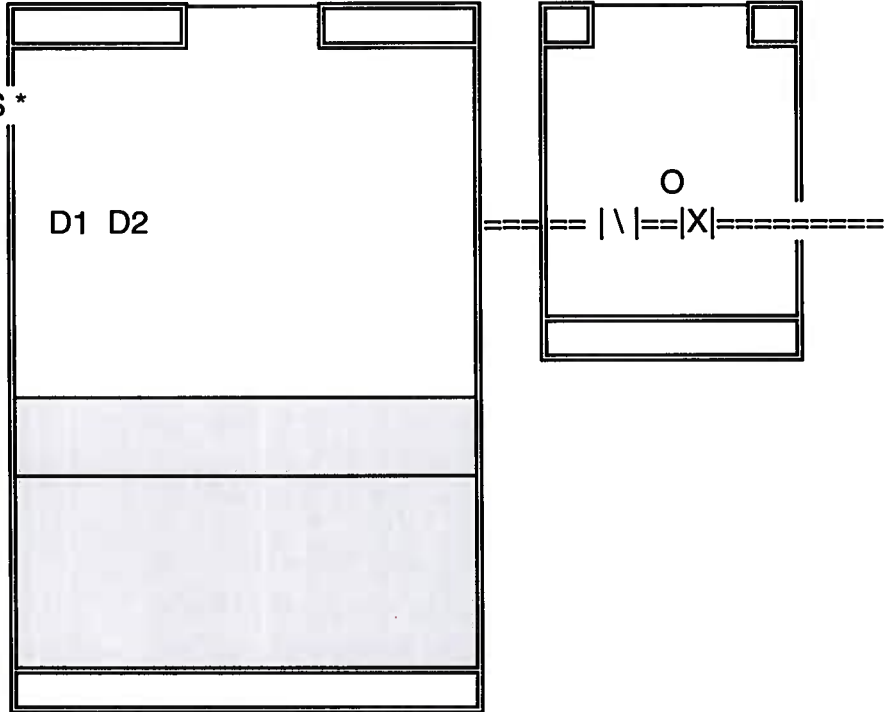

1. Measure the wet well diameter or rectangular size in inches.
2. When the pump turns on measure the distance from the top of the wet well to the sewage level (D1)
3. When the pump turns off measure the distance from the top of the wet well to the sewage level (D2)

Comments: (NO Radio) Not listed in HSS

LIFT STATION FLOW CALCULATION WORKSHEET (Lift Stations with RTU)

Robinson Park, 3

DATE: 3/16/15 TIME: _____:

LOCATION: L.S. 269

WETWELL

VALVEBOX

* ALL MEASUREMENTS IN INCHES *

WETWELL DIAMETER 36"

ON-LEVEL DEPTH (D1) 36"

OFF LEVEL DEPTH (D2) 48"

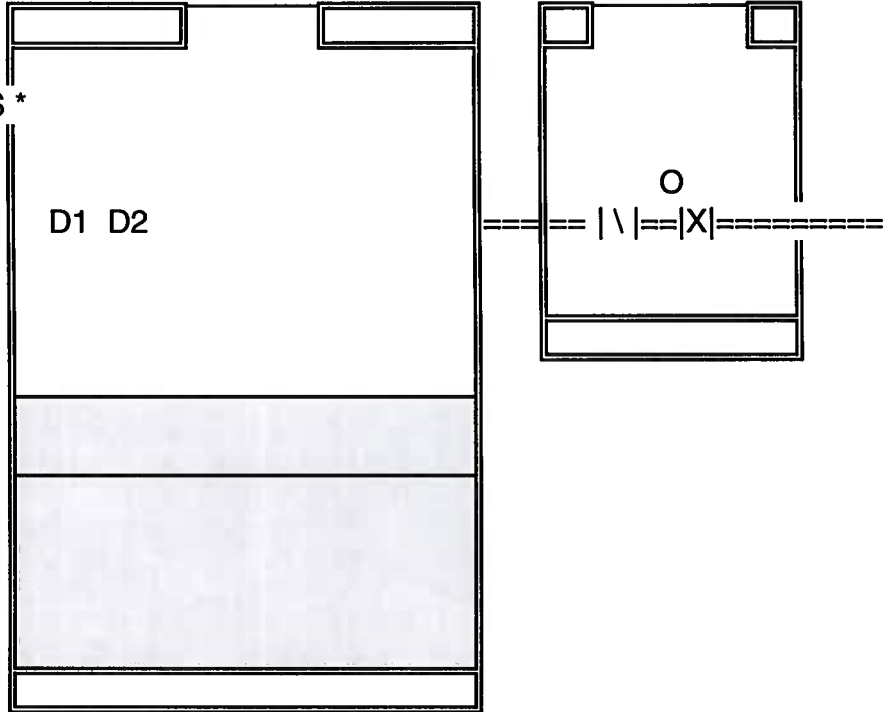

1. Measure the wet well diameter or rectangular size in inches.
2. When the pump turns on measure the distance from the top of the wet well to the sewage level (D1)
3. When the pump turns off measure the distance from the top of the wet well to the sewage level (D2)

Comments: (no Reach) NOT Able to Cistern in HSS

LIFT STATION FLOW CALCULATION WORKSHEET (Lift Stations with RTU) 60

DATE 3/11/15 LOCATION: CENTRAL PARK 298

WETWELL DIAMETER 6'

WETWELL

VALVEBOX

* ALL MEASUREMENTS IN INCHES *

ON-LEVEL DEPTH (D1) 16'6"

OFF LEVEL DEPTH (D2) 20'

WETWELL DEPTH (D3) _____

GAUGE-V.B.TOP (D4) _____

P.S.I. #1 PUMP _____

P.S.I. #2 PUMP _____

P.S.I. BOTH PUMPS _____

P.S.I. NO PUMPS _____

DEAD HEAD #1 PUMP _____

DEAD HEAD #2 PUMP _____

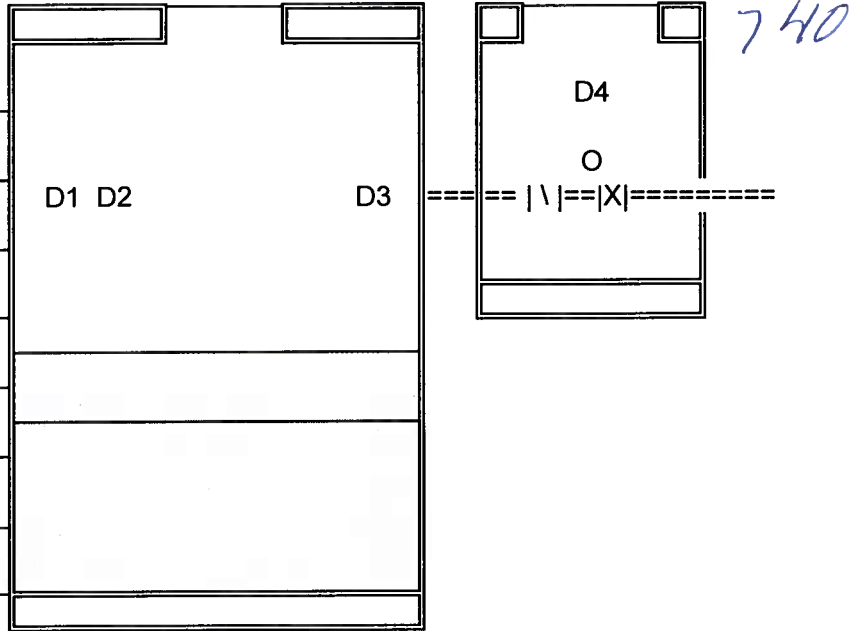

1. Measure the wet well diameter or rectangular size in inches.
2. When the pump turns on measure the distance from the top of the wet well to the sewage level (D1).
3. When the pump turns off measure the distance from the top of the wet well to the sewage level (D2).
4. Measure the pressure for each pump while running, no pumps running, and both pumps running.
5. Measure the "Dead Head" pressure for each pump with the pump gate valve closed.
6. Measure the distance from top of the valve vault to the center of the pressure gauge (D4).
7. Measure to total depth of the wet well (D3).

Comments: _____

| PUMP #1 | MO# | HP | IMP |
|----------|-----|----|-----|
| | | | |
| PUMP # 2 | | | |

LIFT STATION FLOW CALCULATION WORKSHEET (Lift Stations with RTU)

2318

DATE

3/18/05

LOCATION:

MINNESOTA WOOD PK. 318

WETWELL DIAMETER

6'

WETWELL

VALVEBOX

* ALL MEASUREMENTS IN INCHES *

ON-LEVEL DEPTH (D1)

146"

OFF LEVEL DEPTH (D2)

20'

WETWELL DEPTH (D3)

GAUGE-V.B.TOP (D4)

P.S.I. #1 PUMP

P.S.I. #2 PUMP

P.S.I. BOTH PUMPS

P.S.I. NO PUMPS

DEAD HEAD #1 PUMP

DEAD HEAD #2 PUMP

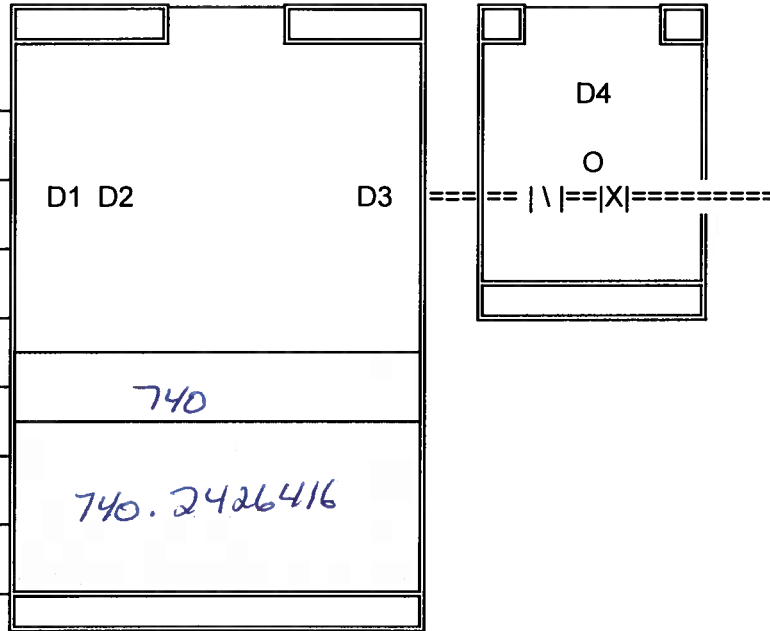

1. Measure the wet well diameter or rectangular size in inches.
2. When the pump turns on measure the distance from the top of the wet well to the sewage level (D1).
3. When the pump turns off measure the distance from the top of the wet well to the sewage level (D2).
4. Measure the pressure for each pump while running, no pumps running, and both pumps running.
5. Measure the "Dead Head" pressure for each pump with the pump gate valve closed.
6. Measure the distance from top of the valve vault to the center of the pressure gauge (D4).
7. Measure to total depth of the wet well (D3).

Comments:

| PUMP #1 | MO# | HP | IMP |
|----------|-----|----|-----|
| | | | |
| PUMP # 2 | | | |

LIFT STATION FLOW CALCULATION WORKSHEET (Lift Stations with RTU)

DATE 3/18/15 LOCATION: MANATOWOODS 319

WETWELL DIAMETER 8'

* ALL MEASUREMENTS IN INCHES *

ON-LEVEL DEPTH (D1) 13'6"

OFF LEVEL DEPTH (D2) 16'

WETWELL DEPTH (D3) _____

GAUGE-V.B.TOP (D4) _____

P.S.I. #1 PUMP _____

P.S.I. #2 PUMP _____

P.S.I. BOTH PUMPS _____

P.S.I. NO PUMPS _____

DEAD HEAD #1 PUMP _____

DEAD HEAD #2 PUMP _____

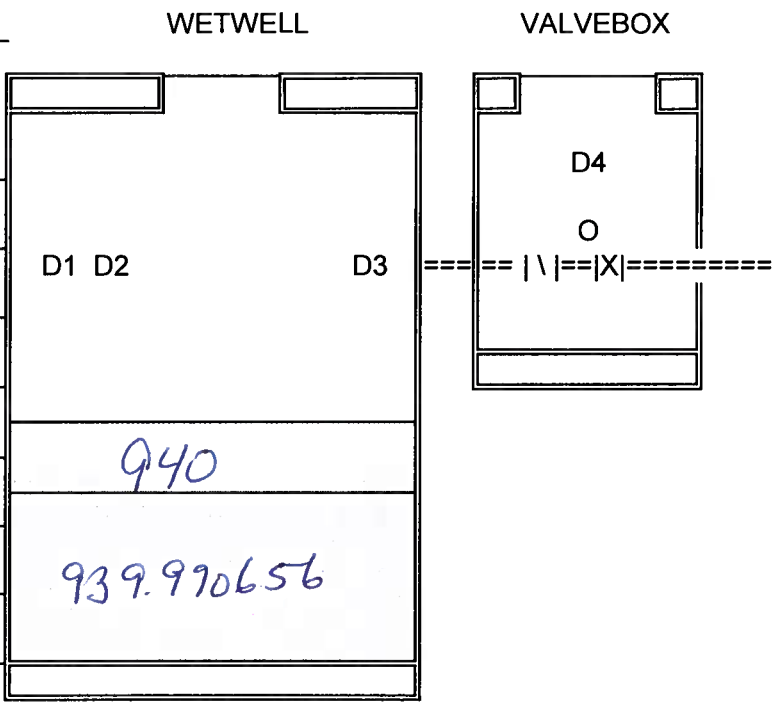

1. Measure the wet well diameter or rectangular size in inches.
2. When the pump turns on measure the distance from the top of the wet well to the sewage level (D1).
3. When the pump turns off measure the distance from the top of the wet well to the sewage level (D2).
4. Measure the pressure for each pump while running, no pumps running, and both pumps running.
5. Measure the "Dead Head" pressure for each pump with the pump gate valve closed.
6. Measure the distance from top of the valve vault to the center of the pressure gauge (D4).
7. Measure to total depth of the wet well (D3).

Comments: _____

| PUMP #1 | MO# | HP | IMP |
|----------|-----|----|-----|
| | | | |
| PUMP # 2 | | | |

LIFT STATION FLOW CALCULATION WORKSHEET (Lift Stations with RTU)

DATE 3/19/15 LOCATION: STONECREEK 320

WETWELL DIAMETER 6'

* ALL MEASUREMENTS IN INCHES *

ON-LEVEL DEPTH (D1) 9'6"

OFF LEVEL DEPTH (D2) 12'6"

WETWELL DEPTH (D3) _____

GAUGE-V.B.TOP (D4) _____

P.S.I. #1 PUMP _____

P.S.I. #2 PUMP _____

P.S.I. BOTH PUMPS _____

P.S.I. NO PUMPS _____

DEAD HEAD #1 PUMP _____

DEAD HEAD #2 PUMP _____

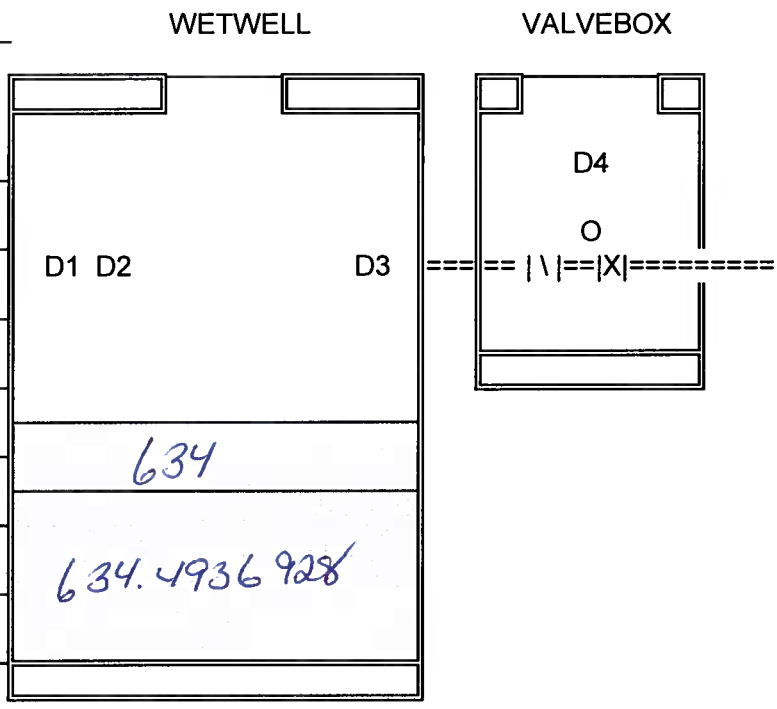

1. Measure the wet well diameter or rectangular size in inches.
2. When the pump turns on measure the distance from the top of the wet well to the sewage level (D1).
3. When the pump turns off measure the distance from the top of the wet well to the sewage level (D2).
4. Measure the pressure for each pump while running, no pumps running, and both pumps running.
5. Measure the "Dead Head" pressure for each pump with the pump gate valve closed.
6. Measure the distance from top of the valve vault to the center of the pressure gauge (D4).
7. Measure to total depth of the wet well (D3).

Comments: _____

| PUMP #1 | MO# | HP | IMP |
|----------|-----|----|-----|
| | | | |
| PUMP # 2 | | | |

LIFT STATION FLOW CALCULATION WORKSHEET (Lift Stations with RTU)

2195

DATE 3/18/15

LOCATION: Palmer Control 322

WETWELL DIAMETER 6'

WETWELL

VALVEBOX

* ALL MEASUREMENTS IN INCHES *

ON-LEVEL DEPTH (D1) 10'6"

OFF LEVEL DEPTH (D2) 14'6"

WETWELL DEPTH (D3) _____

GAUGE-V.B.TOP (D4) _____

P.S.I. #1 PUMP _____

P.S.I. #2 PUMP _____

P.S.I. BOTH PUMPS _____

P.S.I. NO PUMPS _____

DEAD HEAD #1 PUMP _____

DEAD HEAD #2 PUMP _____

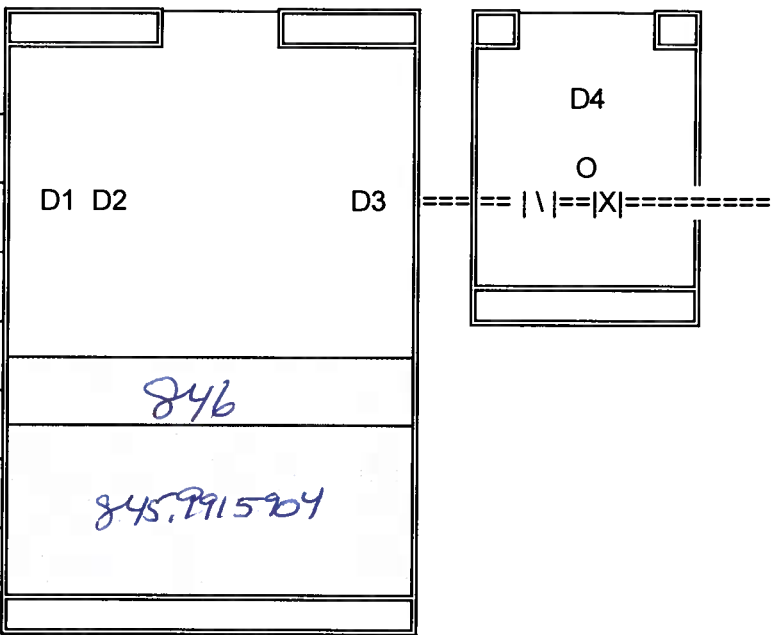

1. Measure the wet well diameter or rectangular size in inches.
2. When the pump turns on measure the distance from the top of the wet well to the sewage level (D1).
3. When the pump turns off measure the distance from the top of the wet well to the sewage level (D2).
4. Measure the pressure for each pump while running, no pumps running, and both pumps running.
5. Measure the "Dead Head" pressure for each pump with the pump gate valve closed.
6. Measure the distance from top of the valve vault to the center of the pressure gauge (D4).
7. Measure to total depth of the wet well (D3).

Comments: _____

| PUMP #1 | MO# | HP | IMP |
|----------|-----|----|-----|
| | | | |
| PUMP # 2 | | | |

LIFT STATION FLOW CALCULATION WORKSHEET (Lift Stations with RTU)

2333

DATE: 3/14/15 LOCATION: 30 EE 333

WETWELL DIAMETER: 8'

WETWELL

VALVEBOX

* ALL MEASUREMENTS IN INCHES *

ON-LEVEL DEPTH (D1) 16'6"

OFF LEVEL DEPTH (D2) 20'

WETWELL DEPTH (D3) _____

GAUGE-V.B.TOP (D4) _____

P.S.I. #1 PUMP _____

P.S.I. #2 PUMP _____

P.S.I. BOTH PUMPS _____

P.S.I. NO PUMPS _____

DEAD HEAD #1 PUMP _____

DEAD HEAD #2 PUMP _____

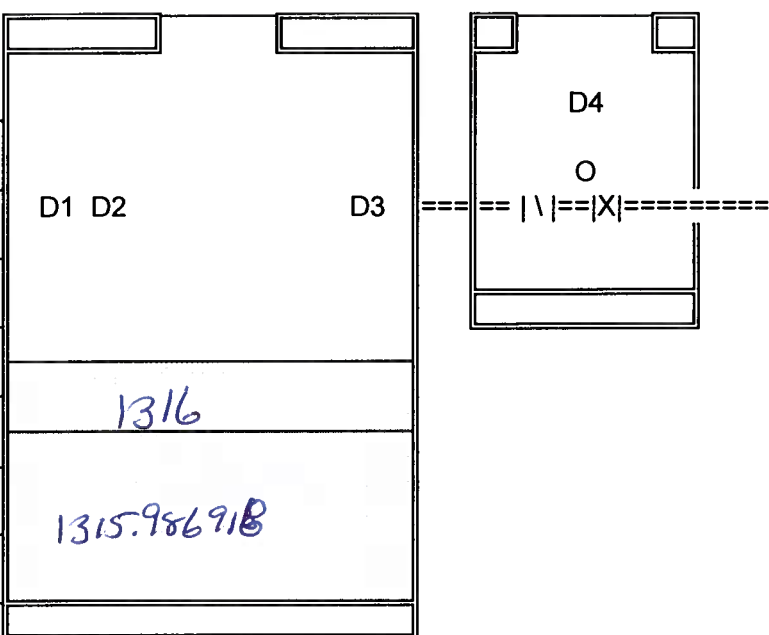

1. Measure the wet well diameter or rectangular size in inches.
2. When the pump turns on measure the distance from the top of the wet well to the sewage level (D1).
3. When the pump turns off measure the distance from the top of the wet well to the sewage level (D2).
4. Measure the pressure for each pump while running, no pumps running, and both pumps running.
5. Measure the "Dead Head" pressure for each pump with the pump gate valve closed.
6. Measure the distance from top of the valve vault to the center of the pressure gauge (D4).
7. Measure to total depth of the wet well (D3).

Comments: _____

| PUMP #1 | MO# | HP | IMP |
|----------|-----|----|-----|
| | | | |
| PUMP # 2 | | | |

LIFT STATION FLOW CALCULATION WORKSHEET (Lift Stations with RTU)

2334

DATE: ___/___/___ TIME: ___:___

LOCATION: 32-AA 334

WETWELL

VALVEBOX

* ALL MEASUREMENTS IN INCHES *

WETWELL DIAMETER 93

ON-LEVEL DEPTH (D1) 270

OFF LEVEL DEPTH (D2) 282

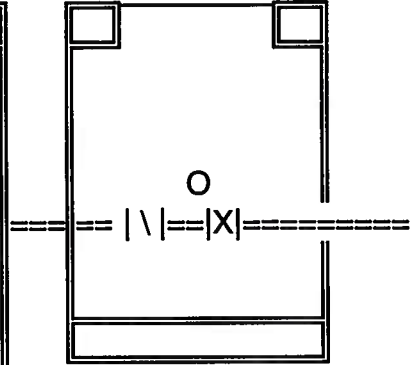
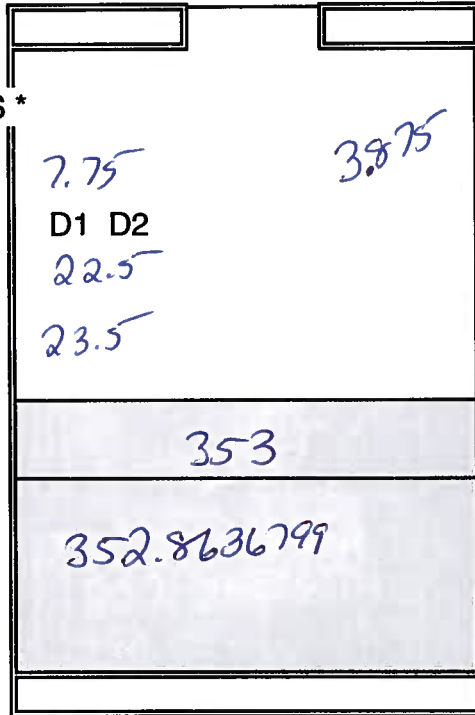

1. Measure the wet well diameter or rectangular size in inches.
2. When the pump turns on measure the distance from the top of the wet well to the sewage level (D)
3. When the pump turns off measure the distance from the top of the wet well to the sewage level (D)

Comments: _____

2338

LIFT STATION FLOW CALCULATION WORKSHEET (Lift Stations with RTU)

DATE 3/18/15 LOCATION: S-2 338

WETWELL DIAMETER 8'

WETWELL

VALVEBOX

* ALL MEASUREMENTS IN INCHES *

ON-LEVEL DEPTH (D1) 21'

OFF LEVEL DEPTH (D2) 24'

WETWELL DEPTH (D3) _____

GAUGE-V.B.TOP (D4) _____

P.S.I. #1 PUMP _____

P.S.I. #2 PUMP _____

P.S.I. BOTH PUMPS _____

P.S.I. NO PUMPS _____

DEAD HEAD #1 PUMP _____

DEAD HEAD #2 PUMP _____

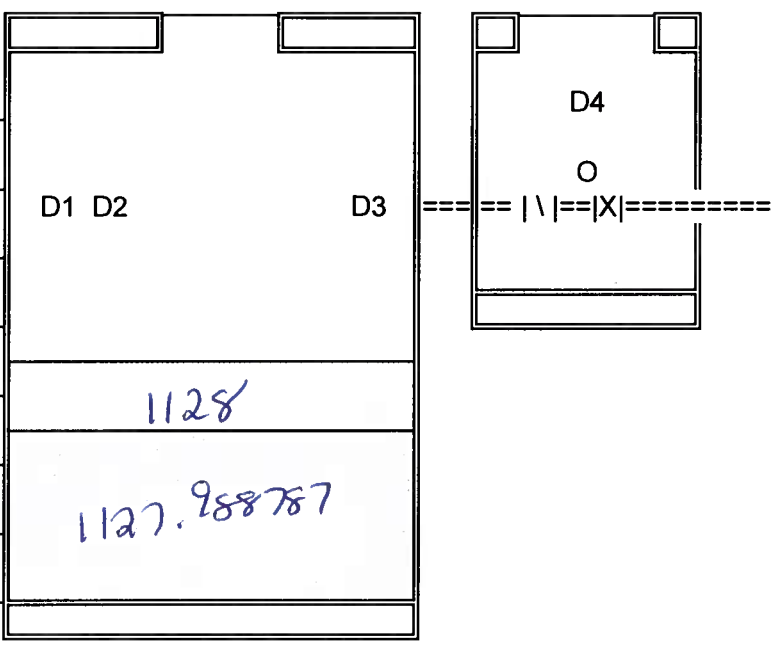

1. Measure the wet well diameter or rectangular size in inches.
2. When the pump turns on measure the distance from the top of the wet well to the sewage level (D1).
3. When the pump turns off measure the distance from the top of the wet well to the sewage level (D2).
4. Measure the pressure for each pump while running, no pumps running, and both pumps running.
5. Measure the "Dead Head" pressure for each pump with the pump gate valve closed.
6. Measure the distance from top of the valve vault to the center of the pressure gauge (D4).
7. Measure to total depth of the wet well (D3).

Comments: _____

| PUMP #1 | MO# | HP | IMP |
|----------|-----|----|-----|
| | | | |
| PUMP # 2 | | | |

344

LIFT STATION FLOW CALCULATION WORKSHEET (Lift Stations with RTU)

2339

DATE 3/18/15 LOCATION: S-3 339

WETWELL DIAMETER 8'

WETWELL

VALVEBOX

* ALL MEASUREMENTS IN INCHES *

ON-LEVEL DEPTH (D1) 19'

OFF LEVEL DEPTH (D2) 21'

WETWELL DEPTH (D3) _____

GAUGE-V.B.TOP (D4) _____

P.S.I. #1 PUMP _____

P.S.I. #2 PUMP _____

P.S.I. BOTH PUMPS _____

P.S.I. NO PUMPS _____

DEAD HEAD #1 PUMP _____

DEAD HEAD #2 PUMP _____

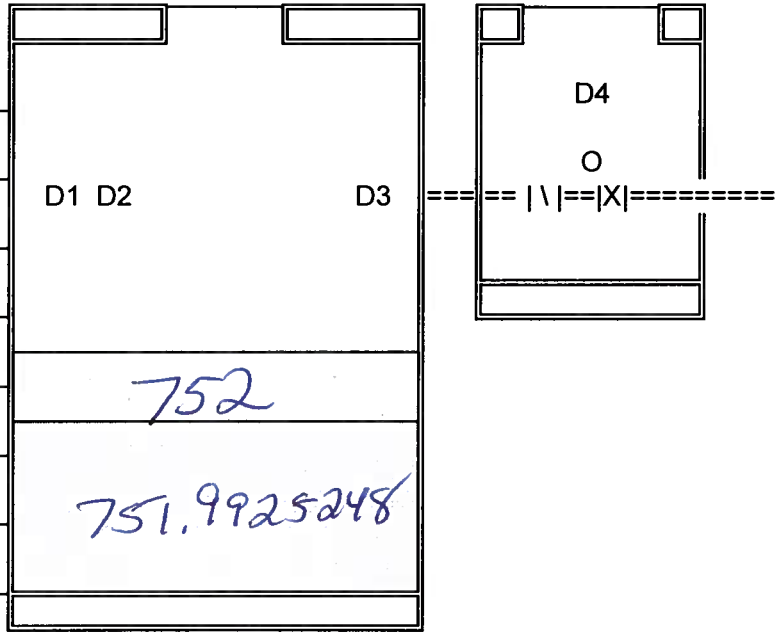

1. Measure the wet well diameter or rectangular size in inches.
2. When the pump turns on measure the distance from the top of the wet well to the sewage level (D1).
3. When the pump turns off measure the distance from the top of the wet well to the sewage level (D2).
4. Measure the pressure for each pump while running, no pumps running, and both pumps running.
5. Measure the "Dead Head" pressure for each pump with the pump gate valve closed.
6. Measure the distance from top of the valve vault to the center of the pressure gauge (D4).
7. Measure to total depth of the wet well (D3).

Comments: _____

| PUMP #1 | MO# | HP | IMP |
|---------|-----|----|-----|
| | | | |

| PUMP # 2 |
|----------|
| |

LIFT STATION FLOW CALCULATION WORKSHEET (Lift Stations with RTU)

DATE 3/18/15 LOCATION: S-4 2(340)

WETWELL DIAMETER 6' WETWELL VALVEBOX

* ALL MEASUREMENTS IN INCHES *

ON-LEVEL DEPTH (D1) 15'

OFF LEVEL DEPTH (D2) 17'6"

WETWELL DEPTH (D3) _____

GAUGE-V.B.TOP (D4) _____

P.S.I. #1 PUMP _____

P.S.I. #2 PUMP _____

P.S.I. BOTH PUMPS _____

P.S.I. NO PUMPS _____

DEAD HEAD #1 PUMP _____

DEAD HEAD #2 PUMP _____

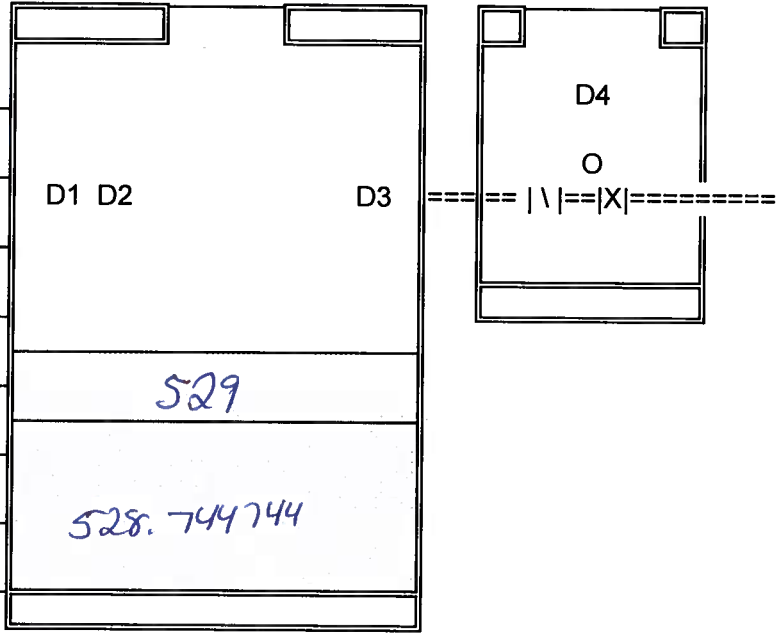

1. Measure the wet well diameter or rectangular size in inches.
2. When the pump turns on measure the distance from the top of the wet well to the sewage level (D1).
3. When the pump turns off measure the distance from the top of the wet well to the sewage level (D2).
4. Measure the pressure for each pump while running, no pumps running, and both pumps running.
5. Measure the "Dead Head" pressure for each pump with the pump gate valve closed.
6. Measure the distance from top of the valve vault to the center of the pressure gauge (D4).
7. Measure to total depth of the wet well (D3).

Comments: _____

| PUMP #1 | MO# | HP | IMP |
|----------|-----|----|-----|
| | | | |
| PUMP # 2 | | | |

LIFT STATION FLOW CALCULATION WORKSHEET (Lift Stations with RTU)

DATE 3/19/15 LOCATION: S-6 342

WETWELL DIAMETER 8'

WETWELL

VALVEBOX

* ALL MEASUREMENTS IN INCHES *

ON-LEVEL DEPTH (D1) 19'

OFF LEVEL DEPTH (D2) 22'6"

WETWELL DEPTH (D3) _____

GAUGE-V.B.TOP (D4) _____

P.S.I. #1 PUMP _____

P.S.I. #2 PUMP _____

P.S.I. BOTH PUMPS _____

P.S.I. NO PUMPS _____

DEAD HEAD #1 PUMP _____

DEAD HEAD #2 PUMP _____

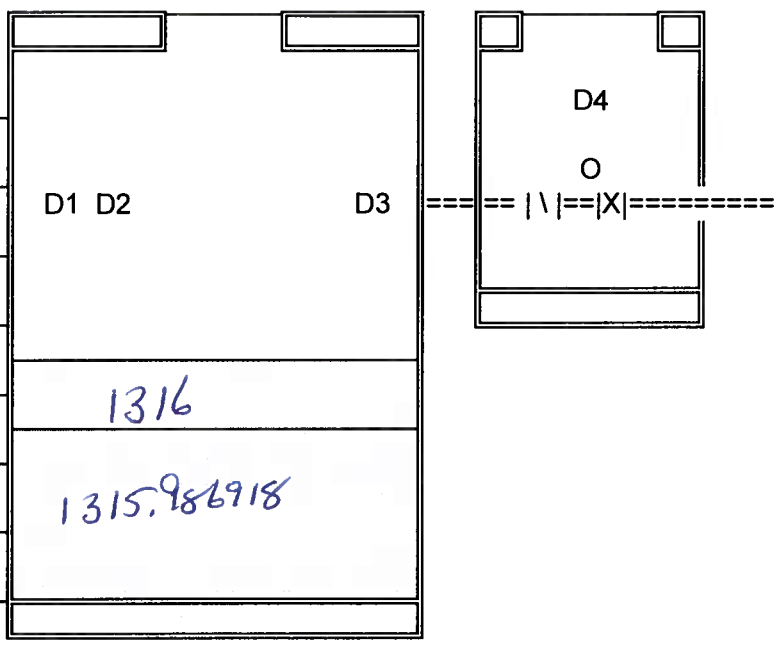

1. Measure the wet well diameter or rectangular size in inches.
2. When the pump turns on measure the distance from the top of the wet well to the sewage level (D1).
3. When the pump turns off measure the distance from the top of the wet well to the sewage level (D2).
4. Measure the pressure for each pump while running, no pumps running, and both pumps running.
5. Measure the "Dead Head" pressure for each pump with the pump gate valve closed.
6. Measure the distance from top of the valve vault to the center of the pressure gauge (D4).
7. Measure to total depth of the wet well (D3).

Comments: _____

| PUMP #1 | MO# | HP | IMP |
|----------|-----|----|-----|
| PUMP # 2 | | | |

LIFT STATION FLOW CALCULATION WORKSHEET (Lift Stations with RTU)

2343

DATE

3/18/15

LOCATION:

S-7 343

WETWELL DIAMETER

6'

WETWELL

VALVEBOX

* ALL MEASUREMENTS IN INCHES *

ON-LEVEL DEPTH (D1)

19'

OFF LEVEL DEPTH (D2)

21'

WETWELL DEPTH (D3)

GAUGE-V.B.TOP (D4)

P.S.I. #1 PUMP

P.S.I. #2 PUMP

P.S.I. BOTH PUMPS

P.S.I. NO PUMPS

DEAD HEAD #1 PUMP

DEAD HEAD #2 PUMP

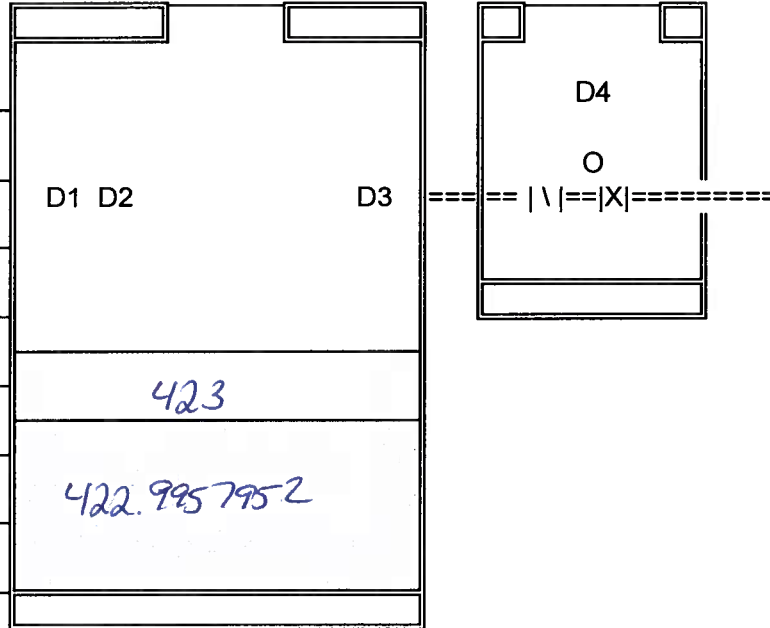

1. Measure the wet well diameter or rectangular size in inches.
2. When the pump turns on measure the distance from the top of the wet well to the sewage level (D1).
3. When the pump turns off measure the distance from the top of the wet well to the sewage level (D2).
4. Measure the pressure for each pump while running, no pumps running, and both pumps running.
5. Measure the "Dead Head" pressure for each pump with the pump gate valve closed.
6. Measure the distance from top of the valve vault to the center of the pressure gauge (D4).
7. Measure to total depth of the wet well (D3).

Comments:

| PUMP #1 | MO# | HP | IMP |
|----------|-----|----|-----|
| | | | |
| PUMP # 2 | | | |

LIFT STATION FLOW CALCULATION WORKSHEET (Lift Stations with RTU)

DATE 3/19/15 LOCATION: SUGAR RIDGE 361

WETWELL DIAMETER 6'

WETWELL

VALVEBOX

* ALL MEASUREMENTS IN INCHES *

ON-LEVEL DEPTH (D1) 13'

OFF LEVEL DEPTH (D2) 15'

WETWELL DEPTH (D3) _____

GAUGE-V.B.TOP (D4) _____

P.S.I. #1 PUMP _____

P.S.I. #2 PUMP _____

P.S.I. BOTH PUMPS _____

P.S.I. NO PUMPS _____

DEAD HEAD #1 PUMP _____

DEAD HEAD #2 PUMP _____

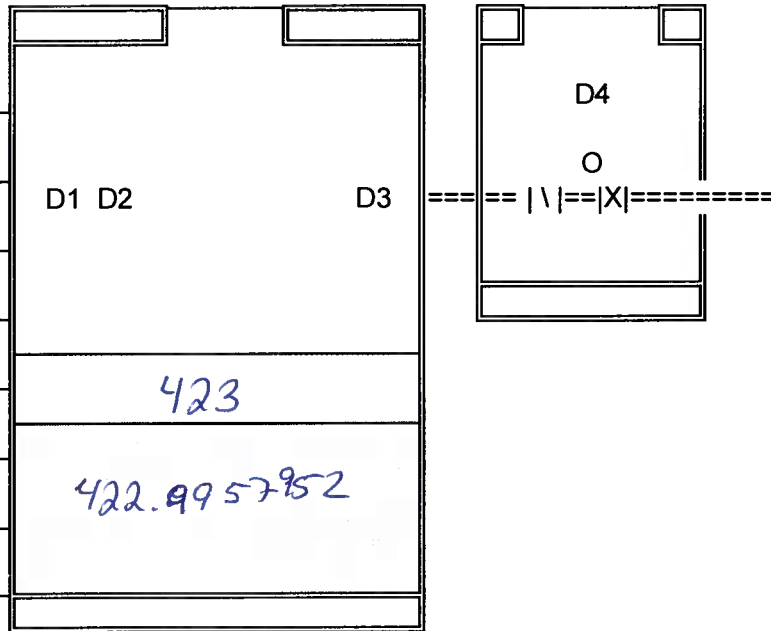

1. Measure the wet well diameter or rectangular size in inches.
2. When the pump turns on measure the distance from the top of the wet well to the sewage level (D1).
3. When the pump turns off measure the distance from the top of the wet well to the sewage level (D2).
4. Measure the pressure for each pump while running, no pumps running, and both pumps running.
5. Measure the "Dead Head" pressure for each pump with the pump gate valve closed.
6. Measure the distance from top of the valve vault to the center of the pressure gauge (D4).
7. Measure to total depth of the wet well (D3).

Comments: _____

| PUMP #1 | MO# | HP | IMP |
|----------|-----|----|-----|
| | | | |
| PUMP # 2 | | | |

LIFT STATION FLOW CALCULATION WORKSHEET (Lift Stations with RTU)

DATE 3/19/15 LOCATION: Tropical Stores #1 393

WETWELL DIAMETER 6'

WETWELL

VALVEBOX

* ALL MEASUREMENTS IN INCHES *

ON-LEVEL DEPTH (D1) 14'6"

OFF LEVEL DEPTH (D2) 17'6"

WETWELL DEPTH (D3) _____

GAUGE-V.B.TOP (D4) _____

P.S.I. #1 PUMP _____

P.S.I. #2 PUMP _____

P.S.I. BOTH PUMPS _____

P.S.I. NO PUMPS _____

DEAD HEAD #1 PUMP _____

DEAD HEAD #2 PUMP _____

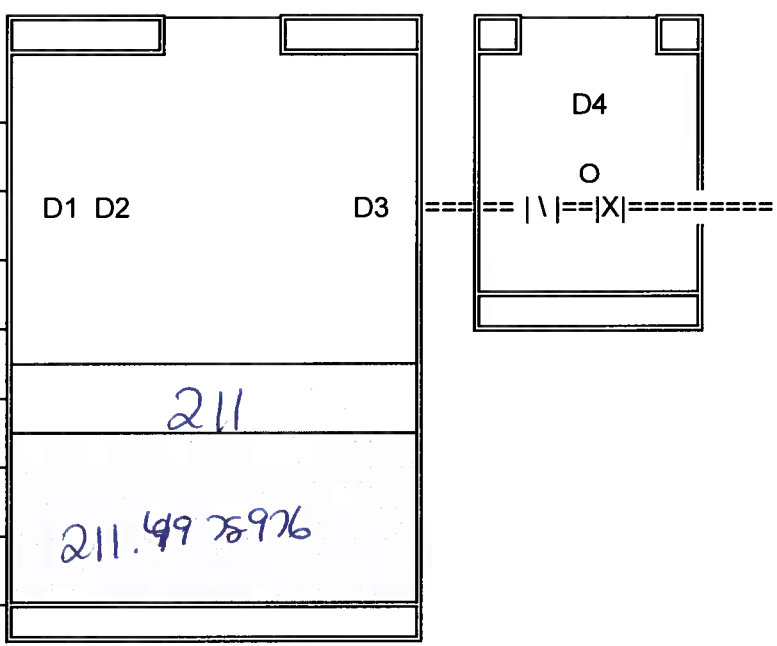

1. Measure the wet well diameter or rectangular size in inches.
2. When the pump turns on measure the distance from the top of the wet well to the sewage level (D1).
3. When the pump turns off measure the distance from the top of the wet well to the sewage level (D2).
4. Measure the pressure for each pump while running, no pumps running, and both pumps running.
5. Measure the "Dead Head" pressure for each pump with the pump gate valve closed.
6. Measure the distance from top of the valve vault to the center of the pressure gauge (D4).
7. Measure to total depth of the wet well (D3).

Comments: _____

| PUMP #1 | MO# | HP | IMP |
|----------|-----|----|-----|
| | | | |
| PUMP # 2 | | | |

LIFT STATION FLOW CALCULATION WORKSHEET (Lift Stations with RTU)

DATE 3/19/15 LOCATION: Tropical Shores #2 396

WETWELL DIAMETER 4'

* ALL MEASUREMENTS IN INCHES *

ON-LEVEL DEPTH (D1) 11'6"

OFF LEVEL DEPTH (D2) 14'

WETWELL DEPTH (D3) _____

GAUGE-V.B.TOP (D4) _____

P.S.I. #1 PUMP _____

P.S.I. #2 PUMP _____

P.S.I. BOTH PUMPS _____

P.S.I. NO PUMPS _____

DEAD HEAD #1 PUMP _____

DEAD HEAD #2 PUMP _____

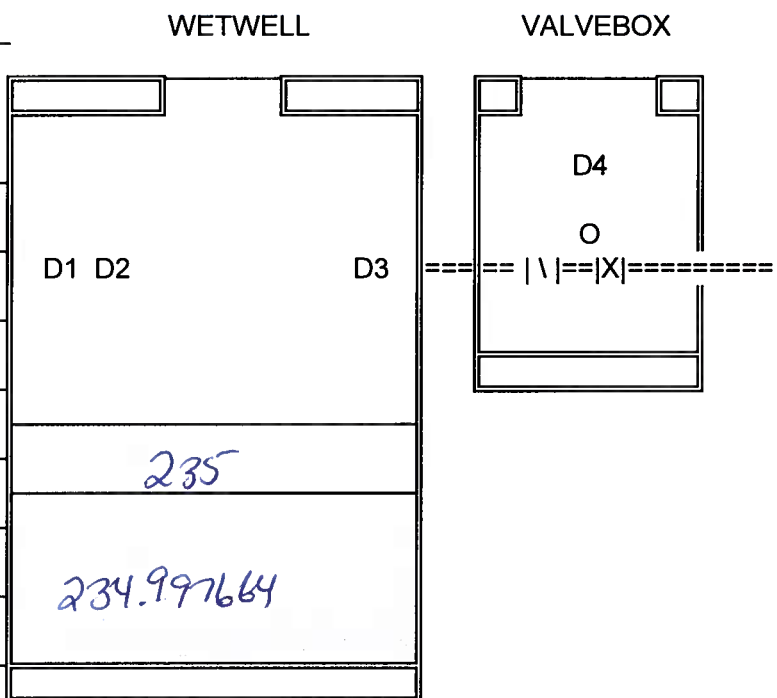

235

234.997664

1. Measure the wet well diameter or rectangular size in inches.
2. When the pump turns on measure the distance from the top of the wet well to the sewage level (D1).
3. When the pump turns off measure the distance from the top of the wet well to the sewage level (D2).
4. Measure the pressure for each pump while running, no pumps running, and both pumps running.
5. Measure the "Dead Head" pressure for each pump with the pump gate valve closed.
6. Measure the distance from top of the valve vault to the center of the pressure gauge (D4).
7. Measure to total depth of the wet well (D3).

Comments: _____

| PUMP #1 | MO# | HP | IMP |
|----------|-----|----|-----|
| | | | |
| PUMP # 2 | | | |

LIFT STATION FLOW CALCULATION WORKSHEET (Lift Stations with RTU)

DATE 3/19/15 LOCATION: RESCARA LAGES 409

WETWELL DIAMETER 4'

WETWELL

VALVEBOX

* ALL MEASUREMENTS IN INCHES *

ON-LEVEL DEPTH (D1) 14'

OFF LEVEL DEPTH (D2) 15'

WETWELL DEPTH (D3) _____

GAUGE-V.B.TOP (D4) _____

P.S.I. #1 PUMP _____

P.S.I. #2 PUMP _____

P.S.I. BOTH PUMPS _____

P.S.I. NO PUMPS _____

DEAD HEAD #1 PUMP _____

DEAD HEAD #2 PUMP _____

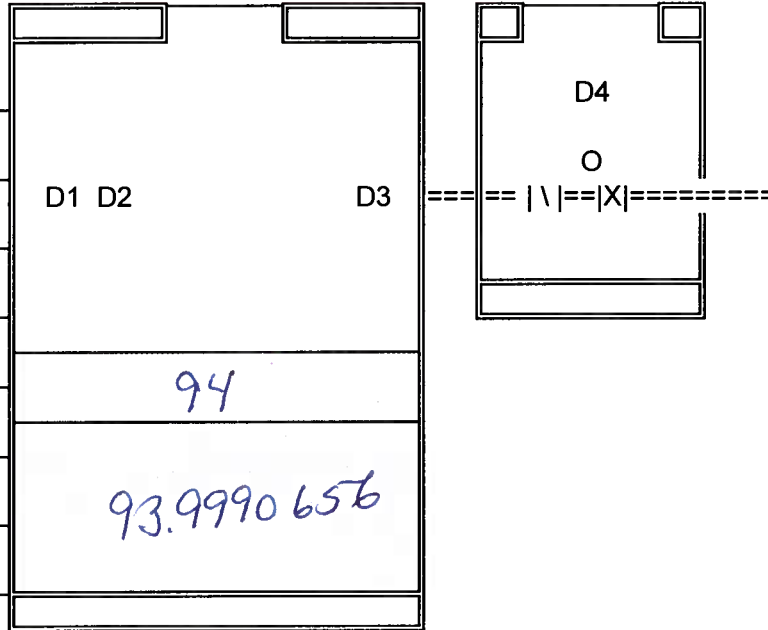

1. Measure the wet well diameter or rectangular size in inches.
2. When the pump turns on measure the distance from the top of the wet well to the sewage level (D1).
3. When the pump turns off measure the distance from the top of the wet well to the sewage level (D2).
4. Measure the pressure for each pump while running, no pumps running, and both pumps running.
5. Measure the "Dead Head" pressure for each pump with the pump gate valve closed.
6. Measure the distance from top of the valve vault to the center of the pressure gauge (D4).
7. Measure to total depth of the wet well (D3).

Comments: _____

| PUMP #1 | MO# | HP | IMP |
|----------|-----|----|-----|
| | | | |
| PUMP # 2 | | | |

LIFT STATION FLOW CALCULATION WORKSHEET (Lift Stations with RTU)

DATE 3/19/15 LOCATION: 22A 412 2133

WETWELL DIAMETER 6'

WETWELL

VALVEBOX

* ALL MEASUREMENTS IN INCHES *

ON-LEVEL DEPTH (D1) 10'

OFF LEVEL DEPTH (D2) 21'

WETWELL DEPTH (D3) _____

GAUGE-V.B.TOP (D4) _____

P.S.I. #1 PUMP _____

P.S.I. #2 PUMP _____

P.S.I. BOTH PUMPS _____

P.S.I. NO PUMPS _____

DEAD HEAD #1 PUMP _____

DEAD HEAD #2 PUMP _____

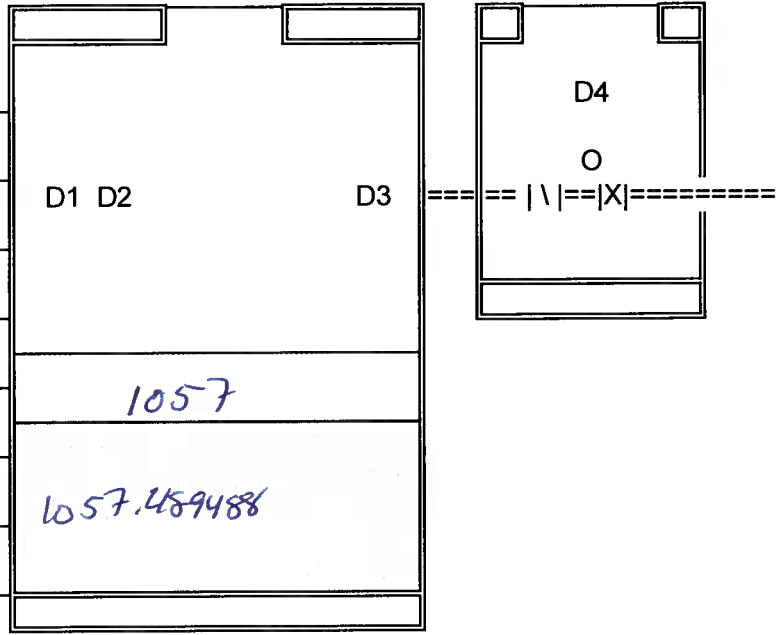

1. Measure the wet well diameter or rectangular size in inches.
2. When the pump turns on measure the distance from the top of the wet well to the sewage level (D1).
3. When the pump turns off measure the distance from the top of the wet well to the sewage level (D2).
4. Measure the pressure for each pump while running, no pumps running, and both pumps running.
5. Measure the "Dead Head" pressure for each pump with the pump gate valve closed.
6. Measure the distance from top of the valve vault to the center of the pressure gauge (D4).
7. Measure to total depth of the wet well (D3).

Comments: _____

| PUMP #1 | MO# | HP | IMP |
|----------|-----|----|-----|
| | | | |
| PUMP # 2 | | | |

414

LIFT STATION FLOW CALCULATION WORKSHEET (Lift Stations with RTU)

DATE 3/19/15 LOCATION: Palm Lakes 414

WETWELL DIAMETER 4'

WETWELL VALVEBOX

* ALL MEASUREMENTS IN INCHES *

ON-LEVEL DEPTH (D1) 6'

OFF LEVEL DEPTH (D2) 8'

WETWELL DEPTH (D3)

GAUGE-V.B.TOP (D4)

P.S.I. #1 PUMP

P.S.I. #2 PUMP

P.S.I. BOTH PUMPS

P.S.I. NO PUMPS

DEAD HEAD #1 PUMP

DEAD HEAD #2 PUMP

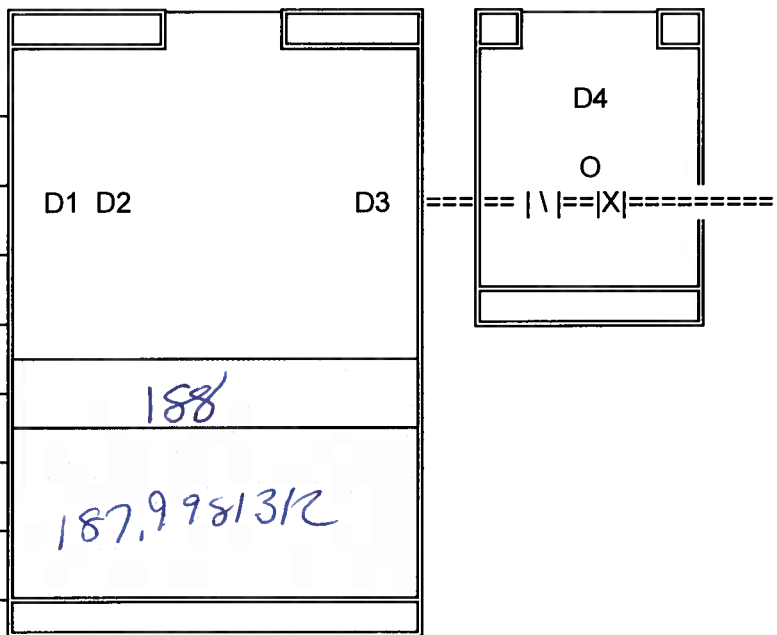

1. Measure the wet well diameter or rectangular size in inches.
2. When the pump turns on measure the distance from the top of the wet well to the sewage level (D1).
3. When the pump turns off measure the distance from the top of the wet well to the sewage level (D2).
4. Measure the pressure for each pump while running, no pumps running, and both pumps running.
5. Measure the "Dead Head" pressure for each pump with the pump gate valve closed.
6. Measure the distance from top of the valve vault to the center of the pressure gauge (D4).
7. Measure to total depth of the wet well (D3).

Comments:

| PUMP #1 | MO# | HP | IMP |
|----------|-----|----|-----|
| PUMP # 2 | | | |

2047

LIFT STATION FLOW CALCULATION WORKSHEET (Lift Stations with RTU)

DATE 3/18/15 LOCATION: 25A 424

WETWELL DIAMETER 6'

WETWELL

VALVEBOX

* ALL MEASUREMENTS IN INCHES *

ON-LEVEL DEPTH (D1) 15'

OFF LEVEL DEPTH (D2) 14'6"

WETWELL DEPTH (D3) _____

GAUGE-V.B.TOP (D4) _____

P.S.I. #1 PUMP _____

P.S.I. #2 PUMP _____

P.S.I. BOTH PUMPS _____

P.S.I. NO PUMPS _____

DEAD HEAD #1 PUMP _____

DEAD HEAD #2 PUMP _____

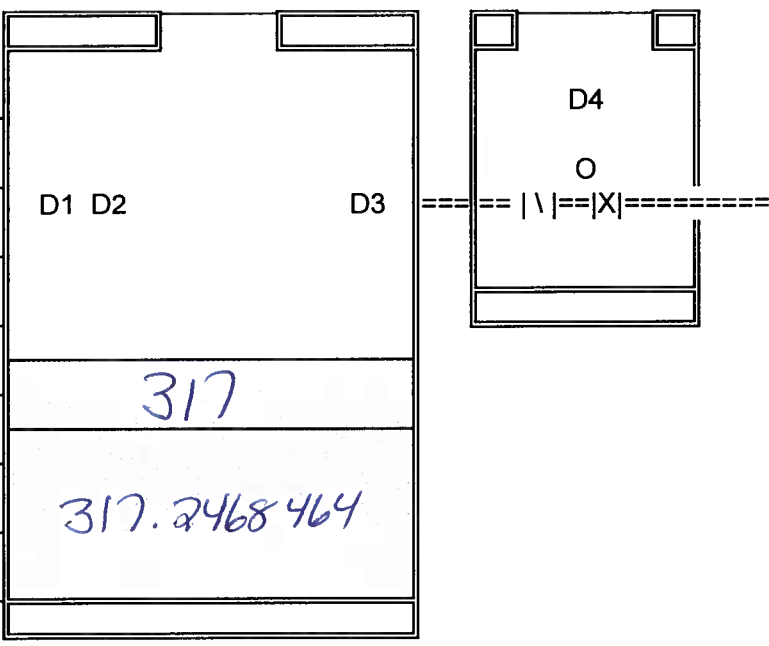

1. Measure the wet well diameter or rectangular size in inches.
2. When the pump turns on measure the distance from the top of the wet well to the sewage level (D1).
3. When the pump turns off measure the distance from the top of the wet well to the sewage level (D2).
4. Measure the pressure for each pump while running, no pumps running, and both pumps running.
5. Measure the "Dead Head" pressure for each pump with the pump gate valve closed.
6. Measure the distance from top of the valve vault to the center of the pressure gauge (D4).
7. Measure to total depth of the wet well (D3).

Comments: _____

| PUMP #1 | MO# | HP | IMP |
|----------|-----|----|-----|
| | | | |
| PUMP # 2 | | | |

425

LIFT STATION FLOW CALCULATION WORKSHEET (Lift Stations with RTU)

DATE 3/18/15 LOCATION: EL Rancho Village 425

WETWELL DIAMETER 6'

WETWELL

VALVEBOX

* ALL MEASUREMENTS IN INCHES *

ON-LEVEL DEPTH (D1) 11'6"

OFF LEVEL DEPTH (D2) 15'

WETWELL DEPTH (D3) _____

GAUGE-V.B.TOP (D4) _____

P.S.I. #1 PUMP _____

P.S.I. #2 PUMP _____

P.S.I. BOTH PUMPS _____

P.S.I. NO PUMPS _____

DEAD HEAD #1 PUMP _____

DEAD HEAD #2 PUMP _____

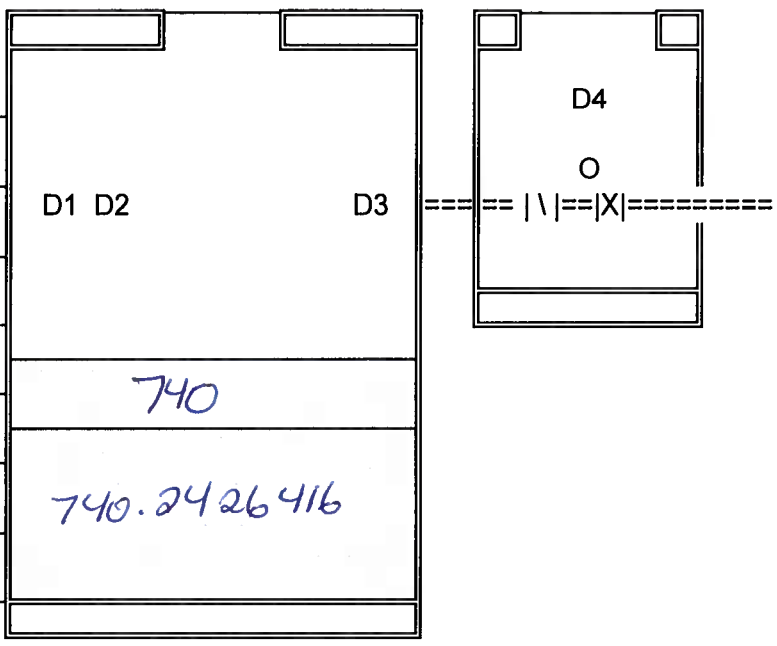

1. Measure the wet well diameter or rectangular size in inches.
2. When the pump turns on measure the distance from the top of the wet well to the sewage level (D1).
3. When the pump turns off measure the distance from the top of the wet well to the sewage level (D2).
4. Measure the pressure for each pump while running, no pumps running, and both pumps running.
5. Measure the "Dead Head" pressure for each pump with the pump gate valve closed.
6. Measure the distance from top of the valve vault to the center of the pressure gauge (D4).
7. Measure to total depth of the wet well (D3).

Comments: _____

| PUMP #1 | MO# | HP | IMP |
|----------|-----|----|-----|
| | | | |
| PUMP # 2 | | | |

LIFT STATION FLOW CALCULATION WORKSHEET (Lift Stations with RTU)

2084

DATE: 3/18/15 LOCATION: 24A 426

WETWELL DIAMETER: 6' WETWELL VALVEBOX

* ALL MEASUREMENTS IN INCHES *

ON-LEVEL DEPTH (D1) 13'

OFF LEVEL DEPTH (D2) 15'

WETWELL DEPTH (D3) _____

GAUGE-V.B.TOP (D4) _____

P.S.I. #1 PUMP _____

P.S.I. #2 PUMP _____

P.S.I. BOTH PUMPS _____

P.S.I. NO PUMPS _____

DEAD HEAD #1 PUMP _____

DEAD HEAD #2 PUMP _____

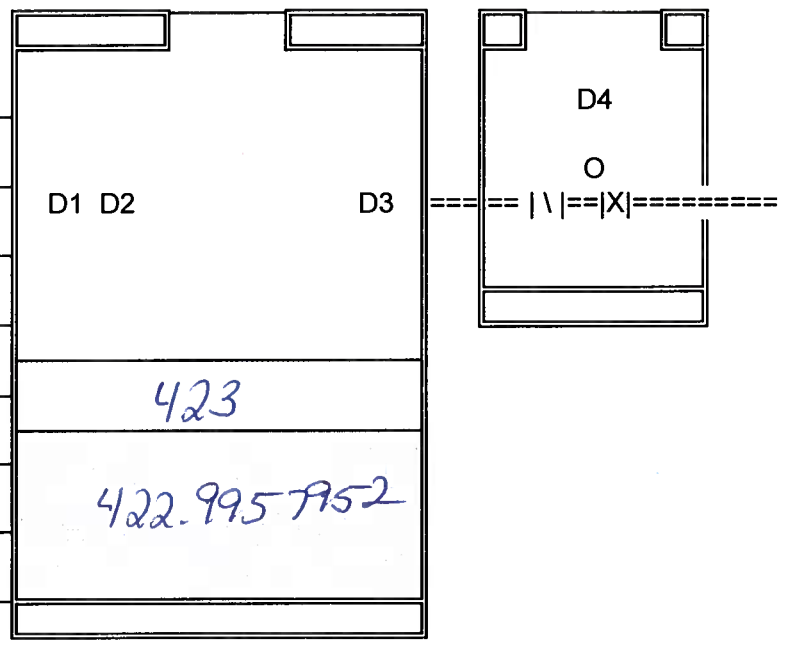

1. Measure the wet well diameter or rectangular size in inches.
2. When the pump turns on measure the distance from the top of the wet well to the sewage level (D1).
3. When the pump turns off measure the distance from the top of the wet well to the sewage level (D2).
4. Measure the pressure for each pump while running, no pumps running, and both pumps running.
5. Measure the "Dead Head" pressure for each pump with the pump gate valve closed.
6. Measure the distance from top of the valve vault to the center of the pressure gauge (D4).
7. Measure to total depth of the wet well (D3).

Comments: _____

| PUMP #1 | MO# | HP | IMP |
|----------|-----|----|-----|
| | | | |
| PUMP # 2 | | | |

708-7476

LIFT STATION FLOW CALCULATION WORKSHEET (Lift Stations with RTU) 2431

DATE 3/11/15 LOCATION: 42A 431

WETWELL DIAMETER 6'

WETWELL

VALVEBOX

* ALL MEASUREMENTS IN INCHES *

ON-LEVEL DEPTH (D1) 15'

OFF LEVEL DEPTH (D2) 20'

WETWELL DEPTH (D3) _____

GAUGE-V.B.TOP (D4) _____

P.S.I. #1 PUMP _____

P.S.I. #2 PUMP _____

P.S.I. BOTH PUMPS _____

P.S.I. NO PUMPS _____

DEAD HEAD #1 PUMP _____

DEAD HEAD #2 PUMP _____

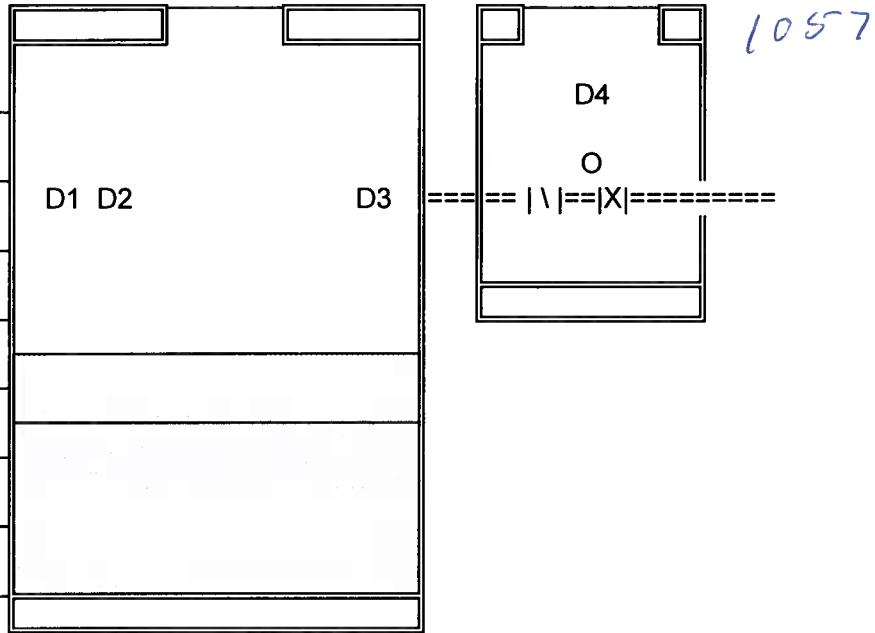

1. Measure the wet well diameter or rectangular size in inches.
2. When the pump turns on measure the distance from the top of the wet well to the sewage level (D1).
3. When the pump turns off measure the distance from the top of the wet well to the sewage level (D2).
4. Measure the pressure for each pump while running, no pumps running, and both pumps running.
5. Measure the "Dead Head" pressure for each pump with the pump gate valve closed.
6. Measure the distance from top of the valve vault to the center of the pressure gauge (D4).
7. Measure to total depth of the wet well (D3).

Comments: _____

| PUMP #1 | MO# | HP | IMP |
|----------|-----|----|-----|
| | | | |
| PUMP # 2 | | | |

LIFT STATION FLOW CALCULATION WORKSHEET (Lift Stations with RTU) 2163

DATE 3/11/15 LOCATION: 21A 432

WETWELL DIAMETER 8'

* ALL MEASUREMENTS IN INCHES *

ON-LEVEL DEPTH (D1) 19'

OFF LEVEL DEPTH (D2) 22'6"

WETWELL DEPTH (D3) _____

GAUGE-V.B.TOP (D4) _____

P.S.I. #1 PUMP _____

P.S.I. #2 PUMP _____

P.S.I. BOTH PUMPS _____

P.S.I. NO PUMPS _____

DEAD HEAD #1 PUMP _____

DEAD HEAD #2 PUMP _____

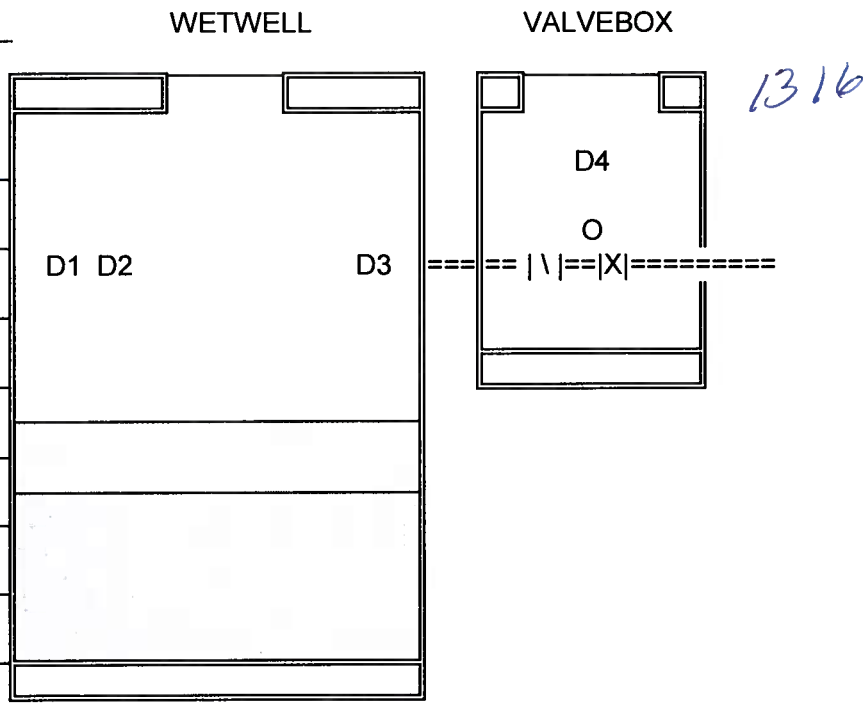

1. Measure the wet well diameter or rectangular size in inches.
2. When the pump turns on measure the distance from the top of the wet well to the sewage level (D1).
3. When the pump turns off measure the distance from the top of the wet well to the sewage level (D2).
4. Measure the pressure for each pump while running, no pumps running, and both pumps running.
5. Measure the "Dead Head" pressure for each pump with the pump gate valve closed.
6. Measure the distance from top of the valve vault to the center of the pressure gauge (D4).
7. Measure to total depth of the wet well (D3).

Comments: _____

| PUMP #1 | MO# | HP | IMP |
|----------|-----|----|-----|
| | | | |
| PUMP # 2 | | | |

South West
2162

LIFT STATION FLOW CALCULATION WORKSHEET (Lift Stations with RTU)

DATE: 3/11/15 LOCATION: 20A 433

WETWELL DIAMETER: 8' WETWELL VALVEBOX

* ALL MEASUREMENTS IN INCHES *

ON-LEVEL DEPTH (D1) 21'

OFF LEVEL DEPTH (D2) 24'

WETWELL DEPTH (D3) _____

GAUGE-V.B.TOP (D4) _____

P.S.I. #1 PUMP _____

P.S.I. #2 PUMP _____

P.S.I. BOTH PUMPS _____

P.S.I. NO PUMPS _____

DEAD HEAD #1 PUMP _____

DEAD HEAD #2 PUMP _____

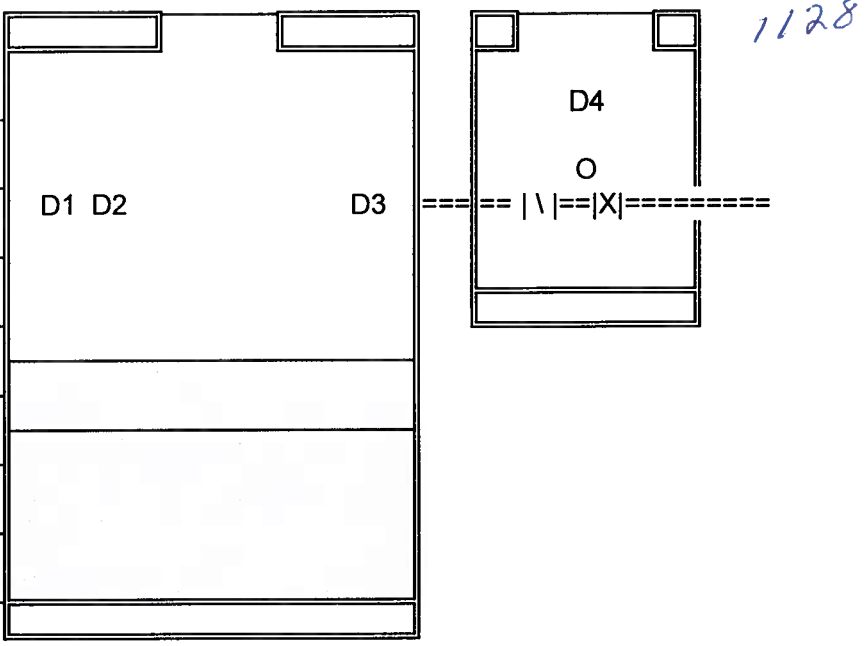

1. Measure the wet well diameter or rectangular size in inches.
2. When the pump turns on measure the distance from the top of the wet well to the sewage level (D1).
3. When the pump turns off measure the distance from the top of the wet well to the sewage level (D2).
4. Measure the pressure for each pump while running, no pumps running, and both pumps running.
5. Measure the "Dead Head" pressure for each pump with the pump gate valve closed.
6. Measure the distance from top of the valve vault to the center of the pressure gauge (D4).
7. Measure to total depth of the wet well (D3).

Comments: _____

| PUMP #1 | MO# | HP | IMP |
|----------|-----|----|-----|
| | | | |
| PUMP # 2 | | | |

LIFT STATION FLOW CALCULATION WORKSHEET (Lift Stations with RTU)

2027

DATE: 3/9/15

LOCATION: woods of welfield 435

WETWELL DIAMETER: 4'

WETWELL

VALVEBOX

* ALL MEASUREMENTS IN INCHES *

ON-LEVEL DEPTH (D1): 11'6"

OFF LEVEL DEPTH (D2): 15'

WETWELL DEPTH (D3): _____

GAUGE-V.B.TOP (D4): _____

P.S.I. #1 PUMP: _____

P.S.I. #2 PUMP: _____

P.S.I. BOTH PUMPS: _____

P.S.I. NO PUMPS: _____

DEAD HEAD #1 PUMP: _____

DEAD HEAD #2 PUMP: _____

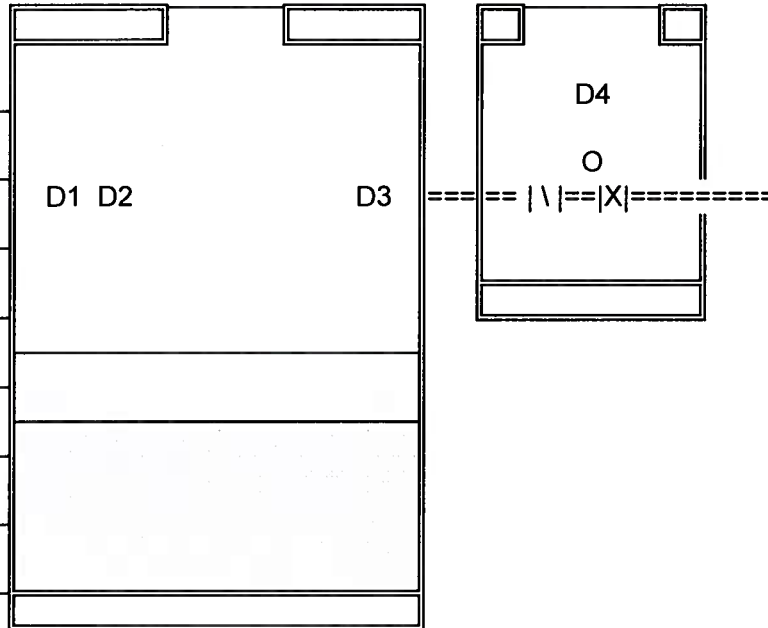

329

1. Measure the wet well diameter or rectangular size in inches.
2. When the pump turns on measure the distance from the top of the wet well to the sewage level (D1).
3. When the pump turns off measure the distance from the top of the wet well to the sewage level (D2).
4. Measure the pressure for each pump while running, no pumps running, and both pumps running.
5. Measure the "Dead Head" pressure for each pump with the pump gate valve closed.
6. Measure the distance from top of the valve vault to the center of the pressure gauge (D4).
7. Measure to total depth of the wet well (D3).

Comments: _____

| PUMP #1 | MO# | HP | IMP |
|----------|-----|----|-----|
| | | | |
| PUMP # 2 | | | |

LIFT STATION FLOW CALCULATION WORKSHEET (Lift Stations with RTU) 2457

DATE 3/11/15 LOCATION: WH. AED HD. P.S.#1 457

WETWELL DIAMETER 5'

WETWELL

VALVEBOX

* ALL MEASUREMENTS IN INCHES *

ON-LEVEL DEPTH (D1) 8'

OFF LEVEL DEPTH (D2) 11'

WETWELL DEPTH (D3) _____

GAUGE-V.B.TOP (D4) _____

P.S.I. #1 PUMP _____

P.S.I. #2 PUMP _____

P.S.I. BOTH PUMPS _____

P.S.I. NO PUMPS _____

DEAD HEAD #1 PUMP _____

DEAD HEAD #2 PUMP _____

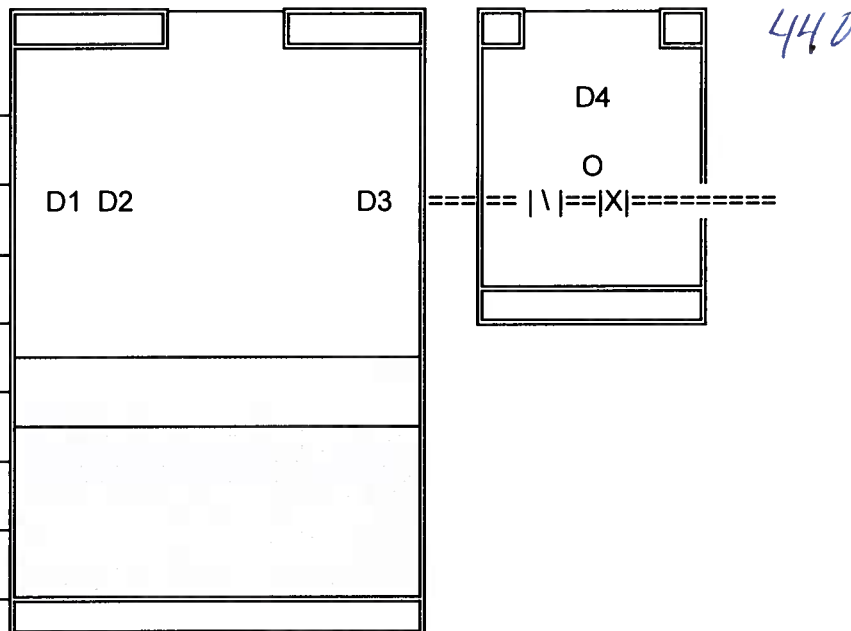

1. Measure the wet well diameter or rectangular size in inches.
2. When the pump turns on measure the distance from the top of the wet well to the sewage level (D1).
3. When the pump turns off measure the distance from the top of the wet well to the sewage level (D2).
4. Measure the pressure for each pump while running, no pumps running, and both pumps running.
5. Measure the "Dead Head" pressure for each pump with the pump gate valve closed.
6. Measure the distance from top of the valve vault to the center of the pressure gauge (D4).
7. Measure to total depth of the wet well (D3).

Comments: _____

| PUMP #1 | MO# | HP | IMP |
|----------|-----|----|-----|
| | | | |
| PUMP # 2 | | | |

LIFT STATION FLOW CALCULATION WORKSHEET (Lift Stations with RTU)

120

DATE

3/11/15

LOCATION:

WILTFIELD W.D. PK. #2 458

WETWELL DIAMETER

6'

WETWELL

VALVEBOX

* ALL MEASUREMENTS IN INCHES *

ON-LEVEL DEPTH (D1)

15'

OFF LEVEL DEPTH (D2)

17'

WETWELL DEPTH (D3)

GAUGE-V.B.TOP (D4)

P.S.I. #1 PUMP

P.S.I. #2 PUMP

P.S.I. BOTH PUMPS

P.S.I. NO PUMPS

DEAD HEAD #1 PUMP

DEAD HEAD #2 PUMP

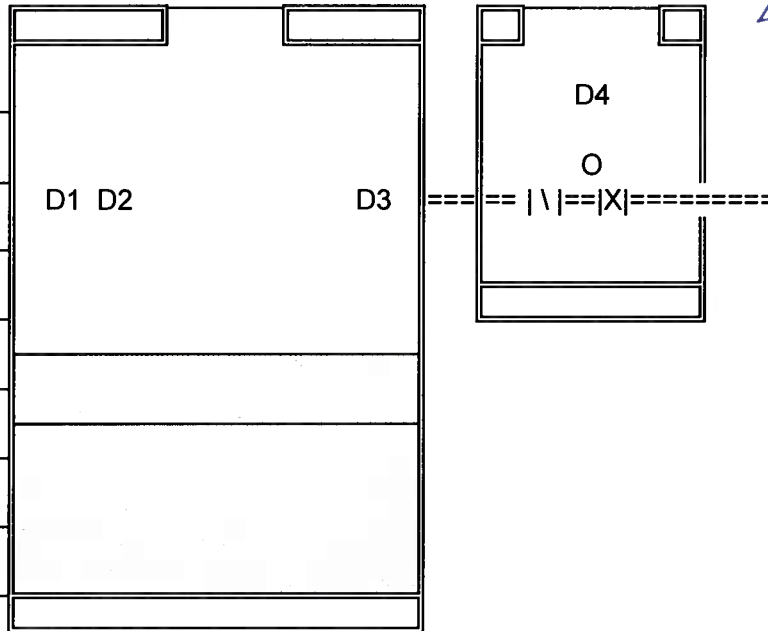

423

1. Measure the wet well diameter or rectangular size in inches.
2. When the pump turns on measure the distance from the top of the wet well to the sewage level (D1).
3. When the pump turns off measure the distance from the top of the wet well to the sewage level (D2).
4. Measure the pressure for each pump while running, no pumps running, and both pumps running.
5. Measure the "Dead Head" pressure for each pump with the pump gate valve closed.
6. Measure the distance from top of the valve vault to the center of the pressure gauge (D4).
7. Measure to total depth of the wet well (D3).

Comments:

| PUMP #1 | MO# | HP | IMP |
|----------|-----|----|-----|
| | | | |
| PUMP # 2 | | | |

LIFT STATION FLOW CALCULATION WORKSHEET (Lift Stations with RTU) 2469

DATE 3/9/15 LOCATION: AIRPORT LND. PK. 469

WETWELL DIAMETER 8'

WETWELL

VALVEBOX

* ALL MEASUREMENTS IN INCHES *

ON-LEVEL DEPTH (D1) 21'

OFF LEVEL DEPTH (D2) 22'6"

WETWELL DEPTH (D3) _____

GAUGE-V.B.TOP (D4) _____

P.S.I. #1 PUMP _____

P.S.I. #2 PUMP _____

P.S.I. BOTH PUMPS _____

P.S.I. NO PUMPS _____

DEAD HEAD #1 PUMP _____

DEAD HEAD #2 PUMP _____

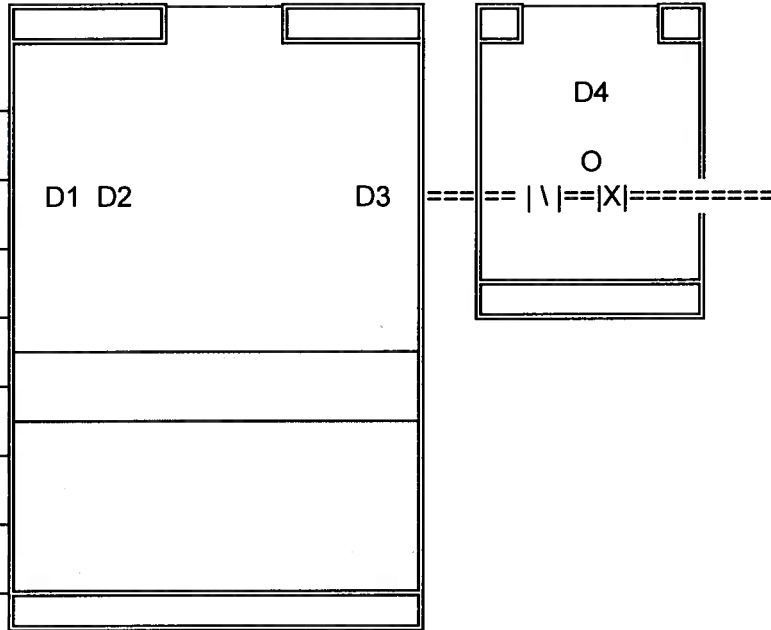

1. Measure the wet well diameter or rectangular size in inches.
2. When the pump turns on measure the distance from the top of the wet well to the sewage level (D1).
3. When the pump turns off measure the distance from the top of the wet well to the sewage level (D2).
4. Measure the pressure for each pump while running, no pumps running, and both pumps running.
5. Measure the "Dead Head" pressure for each pump with the pump gate valve closed.
6. Measure the distance from top of the valve vault to the center of the pressure gauge (D4).
7. Measure to total depth of the wet well (D3).

Comments: _____

| PUMP #1 | MO# | HP | IMP |
|----------|-----|----|-----|
| | | | |
| PUMP # 2 | | | |

2471

LIFT STATION FLOW CALCULATION WORKSHEET (Lift Stations with RTU)

DATE 3/19/15 LOCATION: MODOR SUB-DIV. 471

WETWELL DIAMETER 6'

WETWELL

VALVEBOX

* ALL MEASUREMENTS IN INCHES *

ON-LEVEL DEPTH (D1) 9'

OFF LEVEL DEPTH (D2) 11'6"

WETWELL DEPTH (D3) _____

GAUGE-V.B.TOP (D4) _____

P.S.I. #1 PUMP _____

P.S.I. #2 PUMP _____

P.S.I. BOTH PUMPS _____

P.S.I. NO PUMPS _____

DEAD HEAD #1 PUMP _____

DEAD HEAD #2 PUMP _____

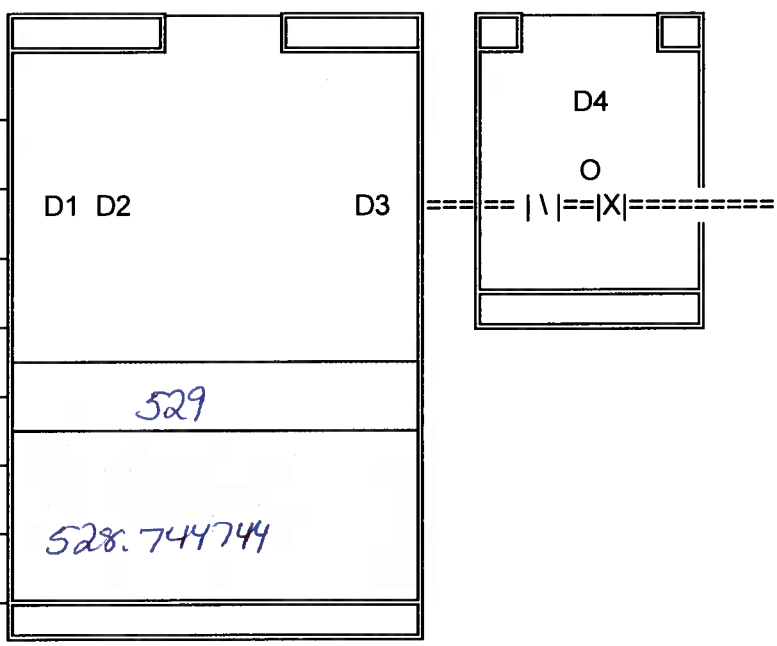

1. Measure the wet well diameter or rectangular size in inches.
2. When the pump turns on measure the distance from the top of the wet well to the sewage level (D1).
3. When the pump turns off measure the distance from the top of the wet well to the sewage level (D2).
4. Measure the pressure for each pump while running, no pumps running, and both pumps running.
5. Measure the "Dead Head" pressure for each pump with the pump gate valve closed.
6. Measure the distance from top of the valve vault to the center of the pressure gauge (D4).
7. Measure to total depth of the wet well (D3).

Comments: _____

| PUMP #1 | MO# | HP | IMP |
|----------|-----|----|-----|
| | | | |
| PUMP # 2 | | | |

LIFT STATION FLOW CALCULATION WORKSHEET (Lift Stations with RTU) 2/28

DATE 2/9/15 LOCATION: 9AA 488

WETWELL DIAMETER 8'

WETWELL

VALVEBOX

* ALL MEASUREMENTS IN INCHES *

ON-LEVEL DEPTH (D1) 18'

OFF LEVEL DEPTH (D2) 22'

WETWELL DEPTH (D3) _____

GAUGE-V.B.TOP (D4) _____

P.S.I. #1 PUMP _____

P.S.I. #2 PUMP _____

P.S.I. BOTH PUMPS _____

P.S.I. NO PUMPS _____

DEAD HEAD #1 PUMP _____

DEAD HEAD #2 PUMP _____

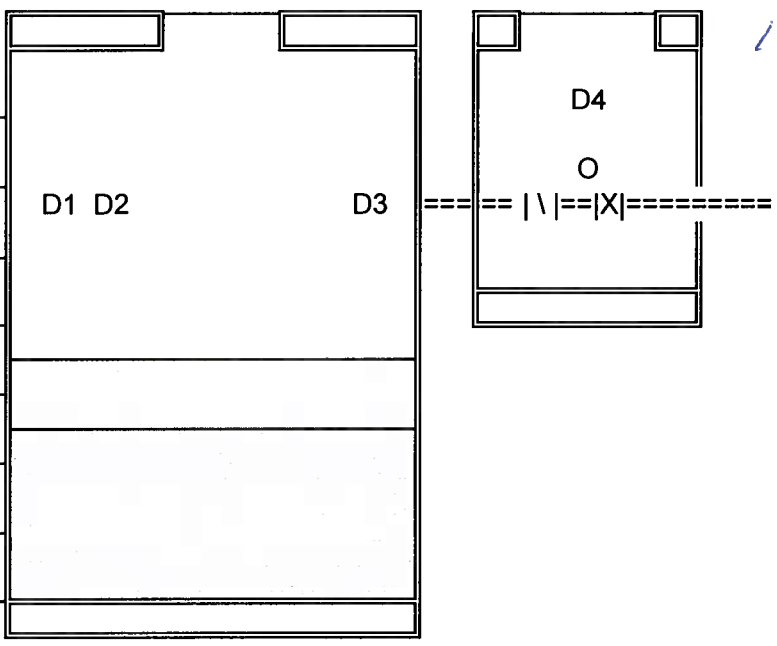

1503

1. Measure the wet well diameter or rectangular size in inches.
2. When the pump turns on measure the distance from the top of the wet well to the sewage level (D1).
3. When the pump turns off measure the distance from the top of the wet well to the sewage level (D2).
4. Measure the pressure for each pump while running, no pumps running, and both pumps running.
5. Measure the "Dead Head" pressure for each pump with the pump gate valve closed.
6. Measure the distance from top of the valve vault to the center of the pressure gauge (D4).
7. Measure to total depth of the wet well (D3).

Comments: _____

| PUMP #1 | MO# | HP | IMP |
|----------|-----|----|-----|
| | | | |
| PUMP # 2 | | | |

LIFT STATION FLOW CALCULATION WORKSHEET (Lift Stations with RTU)

491

DATE 3/9/15 LOCATION: AIRPORT PARK OF COMM. 491

WETWELL DIAMETER 6'

WETWELL

VALVEBOX

* ALL MEASUREMENTS IN INCHES *

ON-LEVEL DEPTH (D1) 18'

OFF LEVEL DEPTH (D2) 22'

WETWELL DEPTH (D3) _____

GAUGE-V.B.TOP (D4) _____

P.S.I. #1 PUMP _____

P.S.I. #2 PUMP _____

P.S.I. BOTH PUMPS _____

P.S.I. NO PUMPS _____

DEAD HEAD #1 PUMP _____

DEAD HEAD #2 PUMP _____

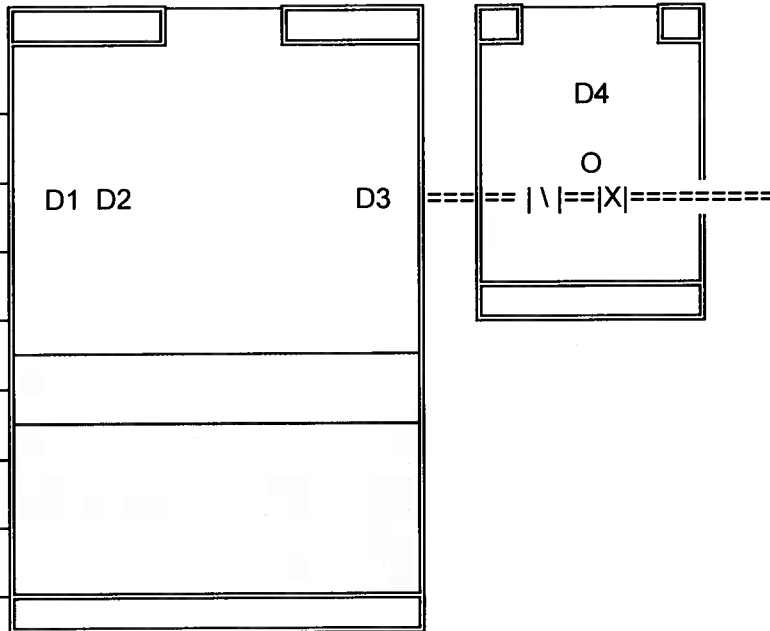

1. Measure the wet well diameter or rectangular size in inches.
2. When the pump turns on measure the distance from the top of the wet well to the sewage level (D1).
3. When the pump turns off measure the distance from the top of the wet well to the sewage level (D2).
4. Measure the pressure for each pump while running, no pumps running, and both pumps running.
5. Measure the "Dead Head" pressure for each pump with the pump gate valve closed.
6. Measure the distance from top of the valve vault to the center of the pressure gauge (D4).
7. Measure to total depth of the wet well (D3).

Comments: _____

| PUMP #1 | MO# | HP | IMP |
|----------|-----|----|-----|
| | | | |
| PUMP # 2 | | | |

APPENDIX D – LIFT STATION SPREADSHEET

| LIFT STATION NAME/NO. | RTU # | WWTP | DOWNSTREAM LIFT STATION | STREET ADDRESS | GPM | TDH | PIPE SIZE | PIPE TYPE | WET WELL SIZE | BOTTOM ELEV. | TOP ELEV. | INF. LINE ELEV. | INF. LINE SIZE | INF. LINE TYPE | FORCE MAIN SIZE | FORCE MAIN TYPE | FORCE MAIN LENGTH | FORCE MAIN TERMINATION LOCATION |
|---------------------------|-------|------|-------------------------|--------------------------|------|------|-----------|-----------|---------------|--------------|-----------|-----------------|----------------|----------------|-----------------|-----------------|-------------------|---|
| 24-A | 426 | SW | 13-A | 1600 51AV.E. | 525 | 43.0 | 4 | HDPE | 6.0 | 10.00 | 26.50 | 16.20 | 10 | CIP | 6 | CIP | 2300 | M.H.,1116 51AV.E. |
| 42-A | 431 | SW | 20-A | 1560 60 AV.DR.E. | 200 | 26.0 | 4 | HDPE | 6.0 | -6.70 | 13.80 | -1.20 | 10 | CIP | 6 | CIP | 756 | M.H., 6024 15ST.E., FRONT OF #6 |
| 21-A | 432 | SW | 13-A | 5503 12ST.E. | 550 | 41.0 | 6 | HDPE | 10.0 | -3.70 | 20.50 | 1.30 | 16 | DIP | 8 | CIP | 2810 | M.H.,57AV.E.& 8ST.CT.E. |
| 20-A | 433 | SW | 13-A | 5932 12TH ST. E. | 651 | 33.0 | 6 | HDPE | 10.0 | -6.30 | 18.75 | -0.30 | 16 | DIP | 8 | CIP | 1651 | M.H.,6204 12ST.E. |
| 14-A | 434 | SW | 13-A | 902 WHITFIELD AVE. | 1400 | 47.0 | 10 | HDPE | 12.0 | -11.50 | 15.00 | -5.50 | 18 | DIP | 12 | DIP | 4044 | M.H.,9ST.E.& 63AV.E. |
| WOODS OF WHITFIELD | 435 | SW | 14-A | 7325 9ST.E. | 175 | 25.0 | 4 | PVC | 4.0 | | | | | | 4 | PVC | | MH, 850 SOUTHERN PINE LANE |
| 9-A | 436 | SW | 14-A | 1160 ROME AV. | 225 | 33.0 | 4 | HDPE | 6.0 | 4.10 | 24.00 | 9.30 | 12 | CIP | 6 | CIP | 3190 | M.H., 7230 15ST.E. |
| MACARTHUR & MEADOWBROOK | 437 | SW | 2-A | 506 MACARTHUR | 180 | 25.0 | 4 | PVC | 6.0 | | | | 12 | CIP | 4 | PVC | 150 | M.H. 7222 MEADOWBROOK DR. |
| 5-A | 438 | SW | 6-A | 420 SUWANEE AVE. | 120 | 19.0 | 4 | HDPE | 6.0 | -15.75 | 6.50 | -9.14 | 8 | CIP | 4 | CIP | 375 | M.H.,W.OF US41 ON SUWANEE AV. |
| 2-A | 439 | SW | 12-A | 350 MAGELLAN DR. | 1433 | 47.0 | 6 | HDPE | 12.0 | -15.90 | 11.50 | -8.90 | 20 | CIP | 12 | CIP | 2037 | 1-A F.M.,S.E.CORNER OF U.S.41 & MEGELLAN |
| 16-A | 440 | SW | 12-A | 1009 69AV.W. | 345 | 26.0 | 4 | HDPE | 8.0 | -11.25 | 11.50 | -3.75 | 18 | CIP | 10 | CIP | 725 | 1-A F.M.,69AV.& U.S.41 |
| WHITFIELD INDUSTRIAL PARK | 457 | SW | 14-A | 8519 WHIT.IND.PK.LP. | 110 | 24.8 | 4 | CIP | 6.0 | | | | | | 4 | CIP | 1200 | M.H. WEST OF R.R.TRACK @ 1711A 67AV.E. |
| WHITFIELD INDUSTRIAL PARK | 458 | SW | WHITFIELD IND.PARK | 8600 WHIT.IND.PK.LP. | 66 | 33.0 | 4 | HDPE | 6.0 | 12.24 | 30.50 | 16.24 | 8 | VCP | 4 | PVC | | MH, 2120 WHITFIELD PARK LOOP |
| CORTEZ PLAZA 2A | 460 | SW | CORTEZ PLAZA 2 | 1131 CORTEZ RD.W. | 75 | 16.0 | 4 | HDPE | 5.0 | 7.07 | 17.50 | 11.07 | 8 | DIP | 4 | PVC | 900 | M.H. @ CORTEZ PLAZA #2 L.S. |
| AIRPORT INDUSTRIAL PARK | 469 | SW | 9-A | 1165 TALLEVAST RD. | 150 | 25.0 | 4 | DIP | 8.0 | -3.16 | 21.50 | 0.84 | 12 | PVC | 6 | PVC | 1900 | M.H. ACROSS FROM 7667 15ST.E. |
| MEDOR SUB-DIVISION | 471 | SW | 13-A | 6100 8ST.E. | 115 | 8.0 | 4 | DIP | 6.0 | 6.10 | 18.50 | 9.60 | 8 | PVC | 4 | PVC | 85 | M.H., 85' W.OF L.S., E.END OF 59AV.E., E. OF 5 ST.E. |
| BRADENTON/SARASOTA AIR | 480 | SW | 7-A | GEN.SPATZ & GEN.KENNY AV | 130 | 28.2 | 4 | HDPE | 6.0 | 8.00 | 24.00 | 11.76 | 8 | DIP | 4 | DIP | | M.H. IN GRASS, S.END ROW A-9, PARKING AREA |
| 18-AA | 484 | SW | 12-A | 6322 14th.ST.W. | 175 | 21.0 | 4 | HDPE | 8.0 | 0.60 | 18.30 | 7.49 | 8 | DIP | 4 | PVC | 400 | M.H., 1305 HARVARD AVE. |
| 18-AB | 485 | SW | 18-AA | 6326 14th.ST.W. | 40 | 60.0 | 2 | PVC | 6.0 | 7.80 | 21.50 | 13.30 | 8 | DIP | 2 | PVC | 350 | M.H. @ 37 BUNION LANE WILHELM'S M.H.P. |
| 18-AC | 486 | SW | 12-A | 6510 14th.ST.W. | 10 | 12.0 | 2 | PVC | 6.0 | 11.00 | 21.00 | 15.02 | 8 | DIP | 2 | PVC | 45 | M.H. 75' W. OF L.S., REAR OF 1604 TENNESSEE ST. (TRAILER ESTATES) |
| 9-AA | 488 | SW | 9-A | 1703 W. UNIVERSITY PKWY | 260 | 40.0 | 8 | DIP | 8.0 | -7.50 | 17.00 | -0.42 | 10 | DIP | 8 | PVC | 8200 | M.H., TELLEVAST RD. & 15ST.E., SE CORNER |
| AIRPORT COMMERCIAL PARK | 491 | SW | 9-A | 8231 LINDBERG CT. | 230 | 55.0 | 4 | PVC | 6.0 | 1.00 | 25.50 | 10.00 | 8 | PVC | 6 | C-900 | 825 | 9-AA FM @ 15ST.E. & LINDBERG CT. |

APPENDIX D – COLLECTION SYSTEM FLOW CHART

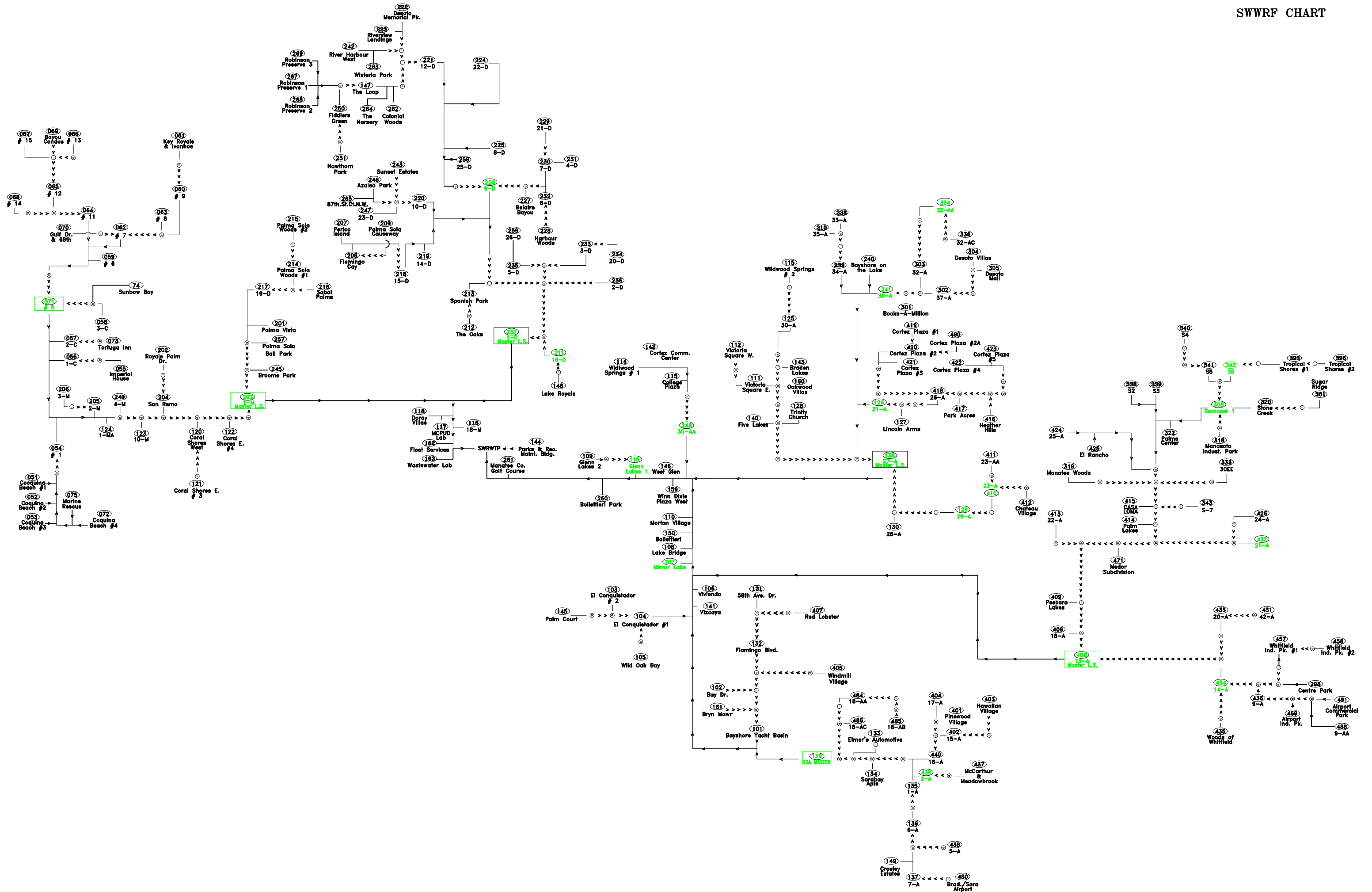

APPENDIX E – MODEL FLEX TABLES

Pump Flex Table

| ID | Label | Pump Definition | Elevation (On) (ft) | Elevation (Off) (ft) | Elevation (Invert) (ft) | Elevation (Ground) (ft) | Notes | Status (Initial) |
|------|-----------|--|---------------------|----------------------|-------------------------|-------------------------|-------|------------------|
| 5863 | PMP-054-1 | 054_HYDROMATIC_S4M1000_8.25"_10hp | -12.5 | -14.5 | -14.5 | 1.15 | | On |
| 5862 | PMP-054-2 | 054_HYDROMATIC_S4M1000_8.25"_10hp | -11.5 | -14.5 | -14.5 | 1.15 | | Off |
| 5954 | PMP-055-1 | 055_HYDROMATIC_S4N/S4NX_5.54-in_1bhp | -6.8 | -11.49 | -14.5 | 3.44 | | On |
| 5955 | PMP-055-2 | 055_HYDROMATIC_S4N/S4NX_5.54-in_1bhp | -5.8 | -11.49 | -14.5 | 3.44 | | Off |
| 5854 | PMP-056-1 | 056_HYDROMATIC_S4N750_7.35"_7.5hp | -9.5 | -11.5 | -11.8 | 3.78 | | On |
| 5856 | PMP-056-2 | 056_HYDROMATIC_S4N750_7.35"_7.5hp | -8.5 | -11.5 | -11.8 | 3.78 | | Off |
| 5848 | PMP-057-1 | 057_HYDROMATIC_S4M1000_8.25"_10hp | -16.5 | -18 | -18 | 2.76 | | On |
| 5850 | PMP-057-2 | 057_HYDROMATIC_S4M1000_8.25"_10hp | -15.5 | -18 | -18 | 2.76 | | Off |
| 6619 | PMP-058-1 | 058_HYDROMATIC_S4N/S4NX_6.29-in_2bhp | -13 | -14.5 | -14.5 | 1.92 | | On |
| 6620 | PMP-058-2 | 058_HYDROMATIC_S4N/S4NX_6.29-in_2bhp | -12 | -14.5 | -14.5 | 1.92 | | Off |
| 8364 | PMP-059-1 | 059_HOMA_AMX434-193_7 5/8"_5hp | -9.5 | -12 | -12 | 1.82 | | On |
| 8365 | PMP-059-2 | 059_HOMA_AMX434-193_7 5/8"_5hp | -8.5 | -12 | -12 | 1.82 | | Off |
| 6430 | PMP-060-1 | 060_HYDROMATIC_SM41750_7.88"_10hp | -11.5 | -13.5 | -13.5 | 1.85 | | On |
| 6428 | PMP-060-2 | 060_HYDROMATIC_SM41750_7.88"_10hp | -10.5 | -13.5 | -13.5 | 1.85 | | Off |
| 6433 | PMP-061-1 | 061_HOMA_Am434-160/4.3N_-in_3bhp | -9.6 | -11.6 | -11.6 | 2.3 | | On |
| 6434 | PMP-061-2 | 061_HOMA_Am434-160/4.3N_-in_3bhp | -8.6 | -11.6 | -11.6 | 2.3 | | Off |
| 8358 | PMP-062-1 | 062_HOMA_AMX646-310_12 5/16"_15hp | -14 | -17.99 | -17.99 | 2.39 | | On |
| 8357 | PMP-062-2 | 062_HOMA_AMX646-310_12 5/16"_15hp | -13 | -17.99 | -17.99 | 2.39 | | Off |
| 6365 | PMP-063-1 | 063_HOMA_AM434-170_nn"_5.5hp | -14 | -14.25 | -14.25 | 1.42 | | On |
| 6364 | PMP-063-2 | 063_HOMA_AM434-170_nn"_5.5hp | -13 | -14.25 | -14.25 | 1.42 | | On |
| 8350 | PMP-064-1 | 064_HOMA_AMX646-370_14 9/16"_21hp | -9.133 | -15.26 | -15.26 | 2.04 | | On |
| 8351 | PMP-064-2 | 064_HOMA_AMX646-370_14 9/16"_21hp | -8.133 | -15.26 | -15.26 | 2.04 | | Off |
| 8375 | PMP-065-1 | 065_HOMA_AMX434-218_8 9/16"_10hp | -7.8 | -16.29 | -16.29 | 3.09 | | On |
| 8371 | PMP-065-2 | 065_HOMA_AMX434-218_8 9/16"_10hp | -6.8 | -16.29 | -16.29 | 3.09 | | Off |
| 8470 | PMP-066-1 | 066_HOMA_AMX434-184_7 1/4"_4hp | -8 | -10.5 | -10.5 | 1.85 | | On |
| 8471 | PMP-066-2 | 066_HOMA_AMX434-184_7 1/4"_4hp | -7.5 | -10.5 | -10.5 | 1.85 | | Off |
| 8648 | PMP-067-1 | 067_HOMA_AMX434-193_7 5/8"_5hp | -14.5 | -16.1 | -16.1 | 2.1 | | On |
| 8649 | PMP-067-2 | 067_HOMA_AMX434-193_7 5/8"_5hp | -13.5 | -16.1 | -16.1 | 2.1 | | Off |
| 8379 | PMP-068-1 | 068_HOMA_AMX434-206_8 1/8"_7hp | -14 | -15.63 | -15.63 | 1.91 | | On |
| 8376 | PMP-068-2 | 068_HOMA_AMX434-206_8 1/8"_7hp | -13 | -15.63 | -15.63 | 1.91 | | Off |
| 5844 | PMP-071-1 | 071_WET_Cal-Range_SWMM_Solver_VFD-Flow-Depth | -12.35 | -12.75 | -14.75 | 5.56 | MLS | On |

| | | | | | | | | |
|-------|-----------|--|--------|--------|--------|-------|-----|-----|
| 5843 | PMP-071-2 | 071_WET_Cal-Range_SWMM_Solver_VFD-Flow-Depth | -11.85 | -12.75 | -14.75 | 5.56 | MLS | Off |
| 22601 | PMP-071-3 | 071_WET_Cal-Range_SWMM_Solver_VFD-Flow-Depth | -11.35 | -12.75 | -14.75 | 5.56 | MLS | Off |
| 6670 | PMP-074-1 | 074_HYDROMATIC_S4N_5.5" _2hp | -2.5 | -3.5 | -11.8 | 1.9 | | On |
| 6669 | PMP-074-2 | 074_HYDROMATIC_S4N_5.5" _2hp | -1.5 | -3.5 | -11.8 | 1.9 | | On |
| 7991 | PMP-101-1 | 101_HOMA_AMX644-350_13 11/16" _56hp | -8.167 | -9.25 | -9.5 | 3.79 | | On |
| 7990 | PMP-101-2 | 101_HOMA_AMX644-350_13 11/16" _56hp | -7.167 | -9.25 | -9.5 | 3.79 | | Off |
| 2059 | PMP-102-1 | 102_BARNES_4SE282-4L_5" _2hp | 0.783 | -0.55 | -8.5 | 3.64 | | On |
| 2058 | PMP-102-2 | 102_BARNES_4SE282-4L_5" _2hp | 1.783 | -0.55 | -8.5 | 3.64 | | Off |
| 1516 | PMP-103-1 | 103_HOMA_AMX434-142_5 9/16" _2.5hp | 6.083 | 4 | 2 | 14.28 | | On |
| 1517 | PMP-103-2 | 103_HOMA_AMX434-142_5 9/16" _2.5hp | 7.083 | 4 | 2 | 14.28 | | Off |
| 8003 | PMP-104-1 | 104_HOMA_AMX644-330_13 3/16" _53hp | -7.35 | -9.1 | -13.6 | 9.35 | | On |
| 8004 | PMP-104-2 | 104_HOMA_AMX644-330_13 3/16" _53hp | -6.35 | -9.1 | -13.6 | 9.35 | | On |
| 1526 | PMP-105-1 | 105_HOMA_AMX434-193_7 5/8" _5hp | 0.67 | -3.9 | -3.9 | 5.47 | | On |
| 1527 | PMP-105-2 | 105_HOMA_AMX434-193_7 5/8" _5hp | 1.67 | -3.9 | -3.9 | 5.47 | | Off |
| 7984 | PMP-106-1 | 106_FLYGT_C-3126_-in_7.5hp | 11.68 | 9.77 | 9.39 | 18.34 | | On |
| 7985 | PMP-106-2 | 106_FLYGT_C-3126_-in_7.5hp | 12.68 | 9.77 | 9.39 | 18.34 | | Off |
| 7929 | PMP-107-1 | 107#1_GODWIN_CD103M_10 7/16" _41hp | 6.177 | 4.343 | 4.11 | 21.12 | | On |
| 7928 | PMP-107-2 | 107#2_HOMA_AMX434-250_9 13/16" _13hp | 7.177 | 4.343 | 4.11 | 21.12 | | Off |
| 7924 | PMP-108-1 | 108_HYDROMATIC_S4HRC750_4.75" _7.5hp | 8.45 | 7.283 | 7.283 | 23.5 | | On |
| 7923 | PMP-108-2 | 108_HYDROMATIC_S4HRC750_4.75" _7.5hp | 9.45 | 7.283 | 7.283 | 23.5 | | Off |
| 7761 | PMP-109-1 | 109_HOMA_AMX434-178_7" _4hp | 4.033 | 2.867 | 1.25 | 15.64 | | On |
| 7757 | PMP-109-2 | 109_HOMA_AMX434-178_7" _4hp | 5.033 | 2.867 | 1.25 | 15.64 | | Off |
| 7939 | PMP-110-1 | 110_HYDROMATIC_H4H/H4HX_9-in_10hp | 9.75 | 9 | 7 | 23.62 | | On |
| 7942 | PMP-110-2 | 110_HYDROMATIC_H4H/H4HX_9-in_10hp | 10.75 | 9 | 7 | 23.62 | | Off |
| 4451 | PMP-111-1 | 111_BARNES_4SE28-4L_5.75" _3hp | 9.953 | 8.87 | 8.87 | 18.93 | | On |
| 4454 | PMP-111-2 | 111_BARNES_4SE28-4L_5.75" _3hp | 10.953 | 8.87 | 8.87 | 18.93 | | Off |
| 7949 | PMP-112-1 | 112_HYDROMATIC_S4N75_6.25" _1hp | 8.673 | 7.173 | 7.173 | 20.02 | | On |
| 7948 | PMP-112-2 | 112_HYDROMATIC_S4N75_6.25" _1hp | 9.673 | 7.173 | 7.173 | 20.02 | | Off |
| 5206 | PMP-113-1 | 113_HOMA_AMX434-142_5 9/16" _2.5hp | 9.393 | 7.643 | 7.643 | 14.24 | | On |
| 5205 | PMP-113-2 | 113_HOMA_AMX434-142_5 9/16" _2.5hp | 10.393 | 7.643 | 7.643 | 14.24 | | Off |
| 5221 | PMP-114-1 | 114_HOMA_AMX434-250_9 13/16" _13hp | 7.39 | 5.44 | 5.44 | 19.02 | | On |
| 5216 | PMP-114-2 | 114_HOMA_AMX434-250_9 13/16" _13hp | 8.39 | 5.44 | 5.44 | 19.02 | | Off |
| 5133 | PMP-115-1 | 115_HYDROMATIC_S4P1750_7.93" _nnhp | 12.033 | 10.36 | 10.36 | 24.2 | | On |
| 5134 | PMP-115-2 | 115_HYDROMATIC_S4P1750_7.93" _nnhp | 13.033 | 10.36 | 10.36 | 24.2 | | Off |
| 7902 | PMP-116-1 | 116_HYDROMATIC_S4M/S4MX_8.5-in_10hp | 4.2 | -2.895 | -2.8 | 18.04 | | On |
| 7899 | PMP-116-2 | 116_HYDROMATIC_S4M/S4MX_8.5-in_10hp | 5.2 | -2.895 | -2.8 | 18.04 | | On |

| | | | | | | | | |
|-------|-----------|--------------------------------------|---------|---------|---------|-------|--|-----|
| 7868 | PMP-117-1 | 117_HYDROMATIC_S4N1750_7.20"_7.5hp | 7 | 5.5 | 3 | 14.24 | | On |
| 7870 | PMP-117-2 | 117_HYDROMATIC_S4N1750_7.20"_7.5hp | 8 | 5.5 | 3 | 14.24 | | On |
| 7874 | PMP-118-1 | 118_HOMA_AV432-178_7"_13hp | 7.483 | 6.9 | 0 | 14.02 | | On |
| 7873 | PMP-118-2 | 118_HOMA_AV432-178_7"_13hp | 8.483 | 6.9 | 0 | 14.02 | | On |
| 7853 | PMP-119-1 | 119_HOMA_AMX444-260_10 3/8"_20hp | 2.667 | 0.667 | -1.83 | 19.77 | | On |
| 7852 | PMP-119-2 | 119_HOMA_AMX444-260_10 3/8"_20hp | 3.667 | 0.667 | -1.83 | 19.77 | | Off |
| 5672 | PMP-120-1 | 120_FLYGT_-in_hp | -7.5 | -9 | -9 | 8.06 | | On |
| 5671 | PMP-120-2 | 120_FLYGT_-in_hp | -6.5 | -9 | -9 | 8.06 | | Off |
| 7891 | PMP-122-1 | 122_Alternative_BARNES_6.5-in_3.7bhp | -18.49 | -20.99 | -20.99 | 0.9 | | On |
| 7894 | PMP-122-2 | 122_Alternative_BARNES_6.5-in_3.7bhp | -17.49 | -20.99 | -20.99 | 0.9 | | Off |
| 5728 | PMP-123-1 | 123_HYDROMATIC_5.75-in_2bhp | -7 | -8 | -8.79 | 0.56 | | On |
| 5725 | PMP-123-2 | 123_HYDROMATIC_5.75-in_2bhp | -6 | -8 | -8.79 | 0.56 | | Off |
| 5791 | PMP-124-1 | 124_HOMA_AMX434-184_7 1/4"_4hp | -13.5 | -15.5 | -15.6 | 2.35 | | On |
| 5789 | PMP-124-2 | 124_HOMA_AMX434-184_7 1/4"_4hp | -12.5 | -15.5 | -15.6 | 2.35 | | Off |
| 4467 | PMP-125-1 | 125_HOMA_AMX434-184_7 1/4"_3.5hp | 4.5 | 3.167 | 1.3 | 17.59 | | On |
| 4466 | PMP-125-2 | 125_HOMA_AMX434-184_7 1/4"_3.5hp | 5.5 | 3.167 | 1.3 | 17.59 | | Off |
| 3973 | PMP-126-1 | 126_HYDROMATIC_S6A3000_9.25"_30hp | -1 | -2.5 | -4.4 | 20.23 | | On |
| 3976 | PMP-126-2 | 126_HYDROMATIC_S6A3000_9.25"_30hp | 0 | -2.5 | -4.4 | 20.23 | | On |
| 5045 | PMP-127-1 | 127_HOMA_AM434-170/5.5N_-in_4bhp | 6.66 | 5.743 | 3 | 14.41 | | On |
| 5046 | PMP-127-2 | 127_HOMA_AM434-170/5.5N_-in_4bhp | 7.66 | 5.743 | 3 | 14.41 | | Off |
| 4508 | PMP-128-1 | 128_BARNES_4.75-in_0.5hp | 13.25 | 11.167 | 3 | 20.07 | | On |
| 4506 | PMP-128-2 | 128_BARNES_4.75-in_0.5hp | 14.25 | 11.167 | 3 | 20.07 | | Off |
| 4512 | PMP-129-1 | 129_PEC_FA125-628_-in_10bhp | 0.033 | -3.217 | -3.217 | 17.6 | | On |
| 4515 | PMP-129-2 | 129_PEC_FA125-628_-in_10bhp | 1.033 | -3.217 | -3.217 | 17.6 | | Off |
| 4639 | PMP-130-1 | 130_HOMA_AMX434-178_7"_4hp | 1.7 | 0.533 | 0.533 | 17.91 | | On |
| 4637 | PMP-130-2 | 130_HOMA_AMX434-178_7"_4hp | 2.7 | 0.533 | 0.533 | 17.91 | | Off |
| 2364 | PMP-132-1 | 132#1_HOMA_AMX434-184_7 1/4"_4hp | 6 | 3.75 | 3.65 | 14.56 | | On |
| 2365 | PMP-132-2 | 132#2_EBARA_100DLF63.7_172mm_5hp | 7 | 3.75 | 3.65 | 14.56 | | On |
| 1745 | PMP-133-1 | 133_HYDROMATIC_S4N_5.75"_2.88hp | 5.15 | 3.65 | -1 | 10.43 | | On |
| 1748 | PMP-133-2 | 133_HYDROMATIC_S4N_5.75"_2.88hp | 6.15 | 3.65 | -1 | 10.43 | | Off |
| 22747 | PMP-134-1 | 134_HOMA_AMX434-155_6 1/8"_4hp | -5.7 | -7.7 | -8 | 3.08 | | On |
| 22756 | PMP-134-2 | 134_HOMA_AMX434-155_6 1/8"_4hp | -4.7 | -7.7 | -8 | 3.08 | | Off |
| 2605 | PMP-135-1 | 135_HOMA_AMX646-330_13"_15hp | -13.333 | -15.917 | -17.8 | 8.37 | | On |
| 2602 | PMP-135-2 | 135_HOMA_AMX646-330_13"_15hp | -12.333 | -15.917 | -17.8 | 8.37 | | On |
| 2698 | PMP-136-1 | 136_HOMA_AMX434-193_7 5/8"_5hp | -8.667 | -11.167 | -11.167 | 1.94 | | On |
| 2699 | PMP-136-2 | 136_HOMA_AMX434-193_7 5/8"_5hp | -7.667 | -11.167 | -11.167 | 1.94 | | Off |

| | | | | | | | | |
|-------|-----------|--|--------|--------|--------|-------|-----|-----|
| 2725 | PMP-137-1 | 137_HOMA_AMX434-178_7"_4hp | -4.167 | -6 | -6 | 9.08 | | On |
| 2723 | PMP-137-2 | 137_HOMA_AMX434-178_7"_4hp | -3.167 | -6 | -6 | 9.08 | | On |
| 7959 | PMP-138-1 | 138_WET_Cal-Range_SWMM-Solver_VFD-Flow-Depth | 4 | 3.44 | -1.66 | 18.79 | MLS | On |
| 7960 | PMP-138-2 | 138_WET_Cal-Range_SWMM-Solver_VFD-Flow-Depth | 4.02 | 3.44 | -1.66 | 18.79 | MLS | On |
| 22614 | PMP-138-3 | 138_WET_Cal-Range_SWMM-Solver_VFD-Flow-Depth | 4.04 | 3.44 | -1.66 | 18.79 | MLS | Off |
| 7997 | PMP-139-1 | 139_WET_Cal-Range_SWMM-Solver_VFD-Flow-Depth | -12.45 | -12.75 | -14.95 | 3.07 | MLS | On |
| 7996 | PMP-139-2 | 139_WET_Cal-Range_SWMM-Solver_VFD-Flow-Depth | -11.45 | -12.75 | -14.95 | 3.07 | MLS | On |
| 22620 | PMP-139-3 | 139_WET_Cal-Range_SWMM-Solver_VFD-Flow-Depth | -10.45 | -12.75 | -14.95 | 3.07 | MLS | On |
| 4457 | PMP-140-1 | 140_BARNES_4SE28-4L_5.25"_3hp | 12.25 | 11 | 9.2 | 23.97 | | On |
| 4459 | PMP-140-2 | 140_BARNES_4SE28-4L_5.25"_3hp | 13.25 | 11 | 9.2 | 23.97 | | Off |
| 8013 | PMP-141-1 | 141_HYDROMATIC_S4HRC/S4HVX_5.5-in_7.5bhp | -1.373 | -2.79 | -4.3 | 9.31 | | On |
| 8010 | PMP-141-2 | 141_HYDROMATIC_S4HRC/S4HVX_5.5-in_7.5bhp | -0.373 | -2.79 | -4.3 | 9.31 | | Off |
| 5211 | PMP-142-1 | 142_BARNES_4SE28-4L_6"_3hp | 12.633 | 11.133 | 10.6 | 19.14 | | On |
| 5210 | PMP-142-2 | 142_BARNES_4SE28-4L_6"_3hp | 13.633 | 11.133 | 10.6 | 19.14 | | Off |
| 4472 | PMP-143-1 | 143_HOMA_AMX434-155_6 1/8"_4hp | 6.84 | 4.34 | 3.93 | 14.64 | | On |
| 4474 | PMP-143-2 | 143_HOMA_AMX434-155_6 1/8"_4hp | 7.84 | 4.34 | 3.93 | 14.64 | | Off |
| 1492 | PMP-145-1 | 145_HYDROMATIC_S4M1750_8.75"_15hp | -7.633 | -8.8 | -9.5 | 3.74 | | On |
| 1490 | PMP-145-2 | 145_HYDROMATIC_S4M1750_8.75"_15hp | -6.633 | -8.8 | -9.5 | 3.74 | | On |
| 7970 | PMP-146-1 | 146_HOMA_AMX434-250_9 13/16"_13hp | 8.083 | 6.583 | 6.583 | 23.32 | | On |
| 7972 | PMP-146-2 | 146_HOMA_AMX434-250_9 13/16"_13hp | 9.083 | 6.583 | 6.583 | 23.32 | | Off |
| 8848 | PMP-147-1 | 147_HYDROMATIC_S4M1750_7.56"_7.5hp | -9.41 | -11.41 | -12.69 | 7.06 | | On |
| 8849 | PMP-147-2 | 147_HYDROMATIC_S4M1750_7.56"_7.5hp | -8.41 | -11.41 | -12.69 | 7.06 | | Off |
| 6791 | PMP-148-1 | 148_HYDROMATIC_S4N/S4NX_7.65-in_2bhp | 14.16 | 12.66 | 11 | 20.53 | | On |
| 6790 | PMP-148-2 | 148_HYDROMATIC_S4N/S4NX_7.65-in_2bhp | 15.16 | 12.66 | 11 | 20.53 | | Off |
| 2731 | PMP-149-1 | 149_BARNES_VERS-4-14_3.625-in_0.5hp | 1.96 | 0.627 | 0.627 | 9.5 | | On |
| 2729 | PMP-149-2 | 149_BARNES_VERS-4-14_3.625-in_0.5hp | 2.96 | 0.627 | 0.627 | 9.5 | | Off |
| 7934 | PMP-150-1 | 150_ABS_AFP1049_8.82"_10hp | 4.843 | 2.51 | 2.51 | 24.01 | | On |
| 7935 | PMP-150-2 | 150_ABS_AFP1049_8.82"_10hp | 5.843 | 2.51 | 2.51 | 24.01 | | Off |
| 7916 | PMP-159-1 | 159_HYDROMATIC_S4P/S4PX_9.25-in_10bhp | 11.167 | 10.167 | 8.2 | 23.93 | | On |
| 7918 | PMP-159-2 | 159_HYDROMATIC_S4P/S4PX_9.25-in_10bhp | 12.167 | 10.167 | 8.2 | 23.93 | | On |
| 4478 | PMP-160-1 | 160_HYDROMATIC_SP50_-in_bhp | 9.27 | 7.3 | 7.3 | 16.51 | | On |
| 4463 | PMP-160-2 | 160_HYDROMATIC_SP50_-in_bhp | 10.27 | 7.3 | 7.3 | 16.51 | | Off |
| 22780 | PMP-161-1 | 161_EBARA_5.63-in_2hp | 3.107 | 1.773 | 1.773 | 7.35 | | On |
| 22784 | PMP-161-2 | 161_EBARA_5.63-in_2hp | 4.107 | 1.773 | 1.773 | 7.35 | | On |
| 5534 | PMP-201-1 | 201_HYDROMATIC_S4N/S4NX_6.5-in_3bhp | -5.1 | -6.1 | -7.1 | 3.19 | | On |
| 5535 | PMP-201-2 | 201_HYDROMATIC_S4N/S4NX_6.5-in_3bhp | -4.1 | -6.1 | -7.1 | 3.19 | | Off |

| | | | | | | | | |
|-------|-----------|--|--------|--------|--------|-------|-----|-----|
| 5721 | PMP-202-1 | 202_HYDROMATIC_S4N/S4NX_6-in_2bhp | -15.67 | -17.67 | -17.67 | 0.33 | | On |
| 5722 | PMP-202-2 | 202_HYDROMATIC_S4N/S4NX_6-in_2bhp | -14.67 | -17.67 | -17.67 | 0.33 | | On |
| 7887 | PMP-203-1 | 203_WET_Cal-Range_SWMM-Solver_VFD-Flow-Depth | -12.02 | -12.42 | -11.75 | 3.88 | MLS | On |
| 7886 | PMP-203-2 | 203_WET_Cal-Range_SWMM-Solver_VFD-Flow-Depth | -11.52 | -12.42 | -11.75 | 3.88 | MLS | On |
| 22593 | PMP-203-3 | 203_WET_Cal-Range_SWMM-Solver_VFD-Flow-Depth | -11.02 | -12.42 | -11.75 | 3.88 | MLS | On |
| 5713 | PMP-204-1 | 204_HOMA_AMX434-178_7" _4hp | -8.8 | -10.3 | -10.3 | 0.75 | | On |
| 5714 | PMP-204-2 | 204_HOMA_AMX434-178_7" _4hp | -7.8 | -10.3 | -10.3 | 0.75 | | Off |
| 5838 | PMP-205-1 | 205_HOMA_AMX434-184_7 1/4" _4hp | -11.5 | -12.5 | -12.5 | 3.69 | | On |
| 5837 | PMP-205-2 | 205_HOMA_AMX434-184_7 1/4" _4hp | -10.5 | -12.5 | -12.5 | 3.69 | | Off |
| 5880 | PMP-206-1 | 206_HOMA_AMX434-155_6 1/8" _4hp | -13 | -15 | -15 | 2.16 | | On |
| 5881 | PMP-206-2 | 206_HOMA_AMX434-155_6 1/8" _4hp | -12 | -15 | -15 | 2.16 | | Off |
| 8955 | PMP-207-1 | 207_HYDROMATIC_S4M/S4MX_7.56-in_7.5bhp | -9.5 | -11 | -12 | 6.32 | | On |
| 8956 | PMP-207-2 | 207_HYDROMATIC_S4M/S4MX_7.56-in_7.5bhp | -8.5 | -11 | -12 | 6.32 | | Off |
| 8944 | PMP-208-1 | 208_HYDROMATIC_S4N/S4NX_8.25-in_7.5bhp | -6.1 | -7.1 | -7.9 | 3.19 | | On |
| 8946 | PMP-208-2 | 208_HYDROMATIC_S4N/S4NX_8.25-in_7.5bhp | -5.1 | -7.1 | -7.9 | 3.19 | | Off |
| 8965 | PMP-209-1 | 209_BARNES_SE51-SP_-in_0.5hp | 0 | -1 | -7 | 4.8 | | On |
| 8960 | PMP-209-2 | 209_BARNES_SE51-SP_-in_0.5hp | 1 | -1 | -7 | 4.8 | | Off |
| 4091 | PMP-210-1 | 210_HYDROMATIC_S4N/S4NX_6-in_2bhp | 6.75 | 6 | 5.8 | 20.11 | | On |
| 4089 | PMP-210-2 | 210_HYDROMATIC_S4N/S4NX_6-in_2bhp | 7.75 | 6 | 5.8 | 20.11 | | On |
| 6786 | PMP-211-1 | 211_HOMA_AMX434-178_7" _4hp | 4.2 | 2.2 | 1.2 | 18.49 | | On |
| 6785 | PMP-211-2 | 211_HOMA_AMX434-178_7" _4hp | 5.2 | 2.2 | 1.2 | 18.49 | | Off |
| 6994 | PMP-212-1 | 212_FLYGT_CP 3085 MT 3_-in_3hp | 13.5 | 11.5 | 9.31 | 20.9 | | On |
| 6990 | PMP-212-2 | 212_FLYGT_CP 3085 MT 3_-in_3hp | 14.5 | 11.5 | 9.31 | 20.9 | | Off |
| 6966 | PMP-213-1 | 213_HOMA_AMX434-178_7" _4hp | 12 | 10.53 | 10.53 | 24.16 | | On |
| 6965 | PMP-213-2 | 213_HOMA_AMX434-178_7" _4hp | 13 | 10.53 | 10.53 | 24.16 | | On |
| 5585 | PMP-214-1 | 214_BARNES_SGVF_4.5-in_2hp | 9.5 | 8 | 7.93 | 14.86 | | On |
| 5588 | PMP-214-2 | 214_BARNES_SGVF_4.5-in_2hp | 10.5 | 8 | 7.93 | 14.86 | | Off |
| 5598 | PMP-215-1 | 215_PIR10-60_UNK | 7.5 | 5.5 | 4.9 | 13.75 | | On |
| 5600 | PMP-215-2 | 215_PIR10-60_UNK | 8.5 | 5.5 | 4.9 | 13.75 | | Off |
| 5573 | PMP-216-1 | 216_HOMA_AMX434-184_7 1/4" _4hp | 6.27 | 4.77 | 4.77 | 18.85 | | On |
| 5575 | PMP-216-2 | 216_HOMA_AMX434-184_7 1/4" _4hp | 7.27 | 4.77 | 4.77 | 18.85 | | Off |
| 5540 | PMP-217-1 | 217_HOMA_AM434-230/13P_-in_12bhp | -17.5 | -19.5 | -21.2 | 6.49 | | On |
| 5539 | PMP-217-2 | 217_HOMA_AM434-230/13P_-in_12bhp | -16.5 | -19.5 | -21.2 | 6.49 | | On |
| 9168 | PMP-218-1 | 218_HOMA_AMX444-230_9 3/8" _20hp | -7.5 | -11 | -12 | 4.75 | | On |
| 9167 | PMP-218-2 | 218_HOMA_AMX444-230_9 3/8" _20hp | -6.5 | -11 | -12 | 4.75 | | Off |
| 9155 | PMP-219-1 | 219_HOMA_AMX434-206_8 1/8" _7hp | -7 | -9 | -9.6 | 8.65 | | On |

| | | | | | | | | |
|------|-----------|--|--------|--------|--------|-------|-----|-----|
| 9156 | PMP-219-2 | 219_HOMA_AMX434-206_8 1/8" _7hp | -6 | -9 | -9.6 | 8.65 | | Off |
| 9183 | PMP-220-1 | 220_HYDROMATIC_S4M_9" _10HP | -12.42 | -13.42 | -15.42 | 5.03 | | On |
| 9181 | PMP-220-2 | 220_HYDROMATIC_S4M_9" _10HP | -11.42 | -13.42 | -15.42 | 5.03 | | On |
| 8324 | PMP-221-1 | 221_HOMA_AMX434-228_9" _10hp | -3.183 | -6.6 | -7.6 | 8.9 | | On |
| 8325 | PMP-221-2 | 221_HOMA_AMX434-228_9" _10hp | -2.183 | -6.6 | -7.6 | 8.9 | | Off |
| 8169 | PMP-222-1 | 222_BARNES_4SE-L_4.75_1.5bhp | -2.1 | -3.1 | -3.1 | 2.9 | | On |
| 8168 | PMP-222-2 | 222_BARNES_4SE-L_4.75_1.5bhp | -1.1 | -3.1 | -3.1 | 2.9 | | Off |
| 8166 | PMP-223-1 | 223_HOMA_AMX434-184_7 1/4" _4hp | -3 | -5.5 | -6.44 | 5.14 | | On |
| 8164 | PMP-223-2 | 223_HOMA_AMX434-184_7 1/4" _4hp | -2 | -5.5 | -6.44 | 5.14 | | Off |
| 8334 | PMP-224-1 | 224_HOMA_AMX434-178_7" _4hp | -3 | -5 | -6.29 | 8.69 | | On |
| 8329 | PMP-224-2 | 224_HOMA_AMX434-178_7" _4hp | -2 | -5 | -6.29 | 8.69 | | Off |
| 8338 | PMP-225-1 | 225_HOMA_AMX444-260_10 1/4" _20hp | -9.5 | -12 | -13 | 4.05 | | On |
| 8336 | PMP-225-2 | 225_HOMA_AMX444-260_10 1/4" _20hp | -8.5 | -12 | -13 | 4.05 | | Off |
| 9175 | PMP-226-1 | 226_BARNES_6SE360-4HL_8.12" _20hp | 1.8 | -1.7 | -3.7 | 10.39 | | On |
| 9174 | PMP-226-2 | 226_BARNES_6SE360-4HL_8.12" _20hp | 2.8 | -1.7 | -3.7 | 10.39 | | On |
| 7464 | PMP-227-1 | 227_GOULDS_WS1512D4U_nn" _nnhp | 0.8 | -0.7 | -3.3 | 9.33 | | On |
| 7463 | PMP-227-2 | 227_GOULDS_WS1512D4U_nn" _nnhp | 1.8 | -0.7 | -3.3 | 9.33 | | Off |
| 7557 | PMP-228-1 | 228_HOMA_AMX434-184_7 1/4" _4hp | 4.1 | 2.6 | 1.59 | 18.79 | | On |
| 7555 | PMP-228-2 | 228_HOMA_AMX434-184_7 1/4" _4hp | 5.1 | 2.6 | 1.59 | 18.79 | | Off |
| 7585 | PMP-229-1 | 229_HOMA_AMX434-155_6 1/8" _4hp | -7 | -9 | -9 | 0.18 | | On |
| 7583 | PMP-229-2 | 229_HOMA_AMX434-155_6 1/8" _4hp | -6 | -9 | -9 | 0.18 | | Off |
| 7411 | PMP-230-1 | 230_HOMA_AMX646-300_11 3/4" _9hp | -12.5 | -14 | -14 | 8.25 | | On |
| 7409 | PMP-230-2 | 230_HOMA_AMX646-300_11 3/4" _9hp | -11.5 | -14 | -14 | 8.25 | | Off |
| 7417 | PMP-231-1 | 231_HOMA_AMX434-155_6 1/8" _4hp | -9.5 | -11 | -11 | 3.07 | | On |
| 7416 | PMP-231-2 | 231_HOMA_AMX434-155_6 1/8" _4hp | -8.5 | -11 | -11 | 3.07 | | Off |
| 7402 | PMP-232-1 | 232_HOMA_AMX434-235_9 1/16" _10hp | -4.5 | -6.5 | -6.5 | 6.03 | | On |
| 7404 | PMP-232-2 | 232_HOMA_AMX434-235_9 1/16" _10hp | -3.5 | -6.5 | -6.5 | 6.03 | | Off |
| 6960 | PMP-233-1 | 233_HYDOMATIC_S4M1750_8.5625" _13hp | -6.8 | -8.3 | -8.3 | 5.33 | | On |
| 6958 | PMP-233-2 | 233_HYDOMATIC_S4M1750_8.5625" _13hp | -5.8 | -8.3 | -8.3 | 5.33 | | Off |
| 7625 | PMP-234-1 | 234_HOMA_AMX434-155_6 1/8" _4hp | -8.4 | -9.9 | -9.9 | 5.87 | | On |
| 7627 | PMP-234-2 | 234_HOMA_AMX434-155_6 1/8" _4hp | -7.4 | -9.9 | -9.9 | 5.87 | | Off |
| 7730 | PMP-235-1 | 235_HOMA_AMX434-193_7 5/8" _5hp | -2 | -5 | -6 | 1.82 | | On |
| 7729 | PMP-235-2 | 235_HOMA_AMX434-193_7 5/8" _5hp | -1 | -5 | -6 | 1.82 | | Off |
| 6952 | PMP-236-1 | 236_HOMA_AMX434-228_9" _10hp | 5.1 | 2.1 | 0.6 | 20.15 | | On |
| 6953 | PMP-236-2 | 236_HOMA_AMX434-228_9" _10hp | 6.1 | 2.1 | 0.6 | 20.15 | | Off |
| 7880 | PMP-237-1 | 237_WET_Cal-Range_SWMM-Solver_VFD-Flow-Depth | 5 | 4.45 | 0.75 | 22.1 | MLS | On |

| | | | | | | | | |
|-------|-----------|--|--------|--------|--------|-------|-----|-----|
| 7879 | PMP-237-2 | 237_WET_Cal-Range_SWMM-Solver_VFD-Flow-Depth | 5.075 | 4.45 | 0.75 | 22.1 | MLS | On |
| 22609 | PMP-237-3 | 237_WET_Cal-Range_SWMM-Solver_VFD-Flow-Depth | 5.15 | 4.45 | 0.75 | 22.1 | MLS | Off |
| 4002 | PMP-238-1 | 238_HOMA_AMX434-193_7 5/8" _5hp | 3.967 | 3.05 | 0.8 | 21.85 | | On |
| 4001 | PMP-238-2 | 238_HOMA_AMX434-193_7 5/8" _5hp | 4.967 | 3.05 | 0.8 | 21.85 | | On |
| 3954 | PMP-239-1 | 239_BARNES_6SE300-4HL_8.12" _30hp | 3.667 | 0.917 | 0.2 | 23.73 | | On |
| 3955 | PMP-239-2 | 239_BARNES_6SE300-4HL_8.12" _30hp | 4.667 | 0.917 | 0.2 | 23.73 | | On |
| 3966 | PMP-240-1 | 240_HOMA_AMX434-235_9 1/4" _13hp | 5.167 | 1.5 | 1.5 | 18.26 | | On |
| 3965 | PMP-240-2 | 240_HOMA_AMX434-235_9 1/4" _13hp | 6.167 | 1.5 | 1.5 | 18.26 | | Off |
| 3958 | PMP-241-1 | 241_BARNES_6SE480-4HL_10" _48hp | 5.083 | 1.583 | 1 | 18.96 | | On |
| 3960 | PMP-241-2 | 241_BARNES_6SE480-4HL_10" _48hp | 6.083 | 1.583 | 1 | 18.96 | | On |
| 8206 | PMP-242-1 | 242_HYDROMATIC_S_6-in_2bhp | -0.2 | -2.2 | -3 | 11.9 | | On |
| 8205 | PMP-242-2 | 242_HYDROMATIC_S_6-in_2bhp | 0.8 | -2.2 | -3 | 11.9 | | Off |
| 9 | PMP-243-1 | 243_HYDROMATIC_S4N/S4NX_6.8-in_2bhp | 2.7 | 0.7 | 0.7 | 17.28 | | On |
| 8 | PMP-243-2 | 243_HYDROMATIC_S4N/S4NX_6.8-in_2bhp | 3.7 | 0.7 | 0.7 | 17.28 | | Off |
| 5496 | PMP-245-1 | 245_HYDROMATIC_S4N/S4NX_5.5-in_2bhp | -8.89 | -9.89 | -9.89 | 5.97 | | On |
| 5497 | PMP-245-2 | 245_HYDROMATIC_S4N/S4NX_5.5-in_2bhp | -7.89 | -9.89 | -9.89 | 5.97 | | Off |
| 206 | PMP-246-1 | 246_HYDROMATIC_S4N/S4NX_7.5-in_5bhp | -0.07 | -1.57 | -2.7 | 15.48 | | On |
| 204 | PMP-246-2 | 246_HYDROMATIC_S4N/S4NX_7.5-in_5bhp | 0.93 | -1.57 | -2.7 | 15.48 | | Off |
| 217 | PMP-247-1 | 247_HYDROMATIC_S3HRC/S3HVX_4.1-in_3bhp | -10.5 | -12 | -13.2 | 1.64 | | On |
| 220 | PMP-247-2 | 247_HYDROMATIC_S3HRC/S3HVX_4.1-in_3bhp | -9.5 | -12 | -13.2 | 1.64 | | Off |
| 7951 | PMP-248-1 | 248_MYERS_6VC300_10.25-in_30hp | 4.833 | 2.167 | -5.22 | 19.06 | | On |
| 7954 | PMP-248-2 | 248_MYERS_6VC300_10.25-in_30hp | 5.833 | 2.167 | -5.22 | 19.06 | | Off |
| 5748 | PMP-249-1 | 249_HYDROMATIC_S4N_6.5" _3.3hp | -17 | -19.5 | -19.5 | 3.71 | | On |
| 5744 | PMP-249-2 | 249_HYDROMATIC_S4N_6.5" _3.3hp | -16 | -19.5 | -19.5 | 3.71 | | Off |
| 8897 | PMP-250-1 | 250_HYDOMATIC_HPGF750_10.5" _7.5hp | -1.5 | -3.5 | -3.5 | 9.65 | | On |
| 8899 | PMP-250-2 | 250_HYDOMATIC_HPGF750_10.5" _7.5hp | -0.5 | -3.5 | -3.5 | 9.65 | | Off |
| 8857 | PMP-251-1 | 251_HYDROMATIC_S4N/S4NX_6.25-in_3bhp | -5 | -7 | -7.5 | 6.99 | | On |
| 8856 | PMP-251-2 | 251_HYDROMATIC_S4N/S4NX_6.25-in_3bhp | -4 | -7 | -7.5 | 6.99 | | Off |
| 5511 | PMP-257-1 | 257_HYDROMATIC_SPGL200_3.75-in_hp | 1.6 | -0.4 | -0.51 | 8.22 | | On |
| 5510 | PMP-257-2 | 257_HYDROMATIC_SPGL200_3.75-in_hp | 2.6 | -0.4 | -0.51 | 8.22 | | On |
| 8348 | PMP-258-1 | 258_Design Point | 0.73 | -4.72 | -4.72 | 6.77 | | On |
| 8346 | PMP-258-2 | 258_Design Point | 1.73 | -4.72 | -4.72 | 6.77 | | Off |
| 7012 | PMP-259-1 | 259_EBARA_32DGUII61.5S_nn" _2hp | 3.6 | 1.6 | 1.6 | 9.46 | | On |
| 7011 | PMP-259-2 | 259_EBARA_32DGUII61.5S_nn" _2hp | 4.6 | 1.6 | 1.6 | 9.46 | | Off |
| 7977 | PMP-260-1 | 260_HYDROMATIC_S4B_9.25-in_20bhp | -1.533 | -4.783 | -4.783 | 15.35 | | On |
| 7979 | PMP-260-2 | 260_HYDROMATIC_S4B_9.25-in_20bhp | -0.533 | -4.783 | -4.783 | 15.35 | | Off |

| | | | | | | | | |
|-------|-----------|---|--------|--------|-------|-------|--|-----|
| 22696 | PMP-262-1 | 262_HYDROMATIC_HPGF/HPGFH 500_10-in_hp | 7.42 | 5.92 | 5.17 | 18.26 | | On |
| 22695 | PMP-262-2 | 262_HYDROMATIC_HPGF/HPGFH 500_10-in_hp | 8.42 | 5.92 | 5.17 | 18.26 | | Off |
| 22718 | PMP-263-1 | 263_HYDROMATIC_S4N/S4NX_5.81-in_3bhp | 2.12 | 0.62 | -1.45 | 14.72 | | On |
| 22717 | PMP-263-2 | 263_HYDROMATIC_S4N/S4NX_5.81-in_3bhp | 3.12 | 0.62 | -1.45 | 14.72 | | Off |
| 22705 | PMP-264-1 | 264_HYDROMATIC_HPGF/HPGFH 500_8.5-in_hp | 3.66 | 2.16 | 1 | 16.51 | | On |
| 22706 | PMP-264-2 | 264_HYDROMATIC_HPGF/HPGFH 500_8.5-in_hp | 4.66 | 2.16 | 2.16 | 16.51 | | Off |
| 191 | PMP-265-1 | 265_HYDROMATIC_HPG200_4.5-in_hp | -3 | -5 | -5 | 8.05 | | On |
| 194 | PMP-265-2 | 265_HYDROMATIC_HPG200_4.5-in_hp | -2 | -5 | -5 | 8.05 | | Off |
| 22727 | PMP-298-1 | 298_HYDROMATIC_S4P_8.3-in_3bhp | 12 | 8.5 | 8.5 | 27.2 | | On |
| 22726 | PMP-298-2 | 298_HYDROMATIC_S4P_8.3-in_3bhp | 13 | 8.5 | 8.5 | 27.2 | | Off |
| 4689 | PMP-301-1 | 301_HYDROMATIC_S4N/S4NX_5.5-in_2bhp | 10.117 | 8.7 | 4.2 | 19.09 | | On |
| 4691 | PMP-301-2 | 301_HYDROMATIC_S4N/S4NX_5.5-in_2bhp | 11.117 | 8.7 | 4.2 | 19.09 | | Off |
| 4685 | PMP-302-1 | 302_HOMA_AMX434-193_7 5/8" 5hp | -1.833 | -3.333 | -4.7 | 9.39 | | On |
| 4682 | PMP-302-2 | 302_HOMA_AMX434-193_7 5/8" 5hp | -0.833 | -3.333 | -4.7 | 9.39 | | On |
| 4807 | PMP-303-1 | 303_FLYGT_63-438-00-3704_202mm_10hp | -4.683 | -5.433 | -5.7 | 15.07 | | On |
| 4806 | PMP-303-2 | 303_FLYGT_63-438-00-3704_202mm_10hp | -3.683 | -5.433 | -5.7 | 15.07 | | On |
| 4720 | PMP-304-1 | 304_FLYGT_CP 3102 MT 1_6.81-in_hp | 8.77 | 4.7 | 4.7 | 17.7 | | On |
| 4719 | PMP-304-2 | 304_FLYGT_CP 3102 MT 1_6.81-in_hp | 9.77 | 4.7 | 4.7 | 17.7 | | Off |
| 4702 | PMP-305-1 | 305_HYDROSTAL_D4D-L_in_2hp | 5.16 | 2.66 | 2.66 | 15.14 | | On |
| 4704 | PMP-305-2 | 305_HYDROSTAL_D4D-L_in_2hp | 6.16 | 2.66 | 2.66 | 14.14 | | Off |
| 3779 | PMP-308-1 | 308_HOMA_AMX644-280_11" 29hp | 10.13 | 6.38 | 6.38 | 31.94 | | On |
| 3778 | PMP-308-2 | 308_HOMA_AMX644-280_11" 29hp | 10.13 | 6.38 | 6.38 | 31.94 | | On |
| 3206 | PMP-318-1 | 318_HOMA_AMX434-178_7" 4hp | 17.17 | 13.67 | 13.67 | 33.67 | | On |
| 3208 | PMP-318-2 | 318_HOMA_AMX434-178_7" 4hp | 18.17 | 13.67 | 13.67 | 33.67 | | Off |
| 3188 | PMP-319-1 | 319_Design Point | 18.6 | 16.1 | 10.7 | 29.94 | | On |
| 3190 | PMP-319-2 | 319_Design Point | 19.6 | 16.1 | 10.7 | 29.94 | | Off |
| 3197 | PMP-320-1 | 320#1_HOMA_AMX434-184_7 5/16" 3.5hp | 6.32 | 3.32 | 3.06 | 14.8 | | On |
| 3196 | PMP-320-2 | 320#2_HOMA_AMX434-193_7 5/8" 5hp | 7.32 | 3.32 | 3.06 | 14.8 | | Off |
| 3774 | PMP-322-1 | 322_HOMA_AMX434-184_7 1/4" 3.5hp | 21.21 | 17.21 | 9.71 | 29.04 | | On |
| 3776 | PMP-322-2 | 322_HOMA_AMX434-184_7 1/4" 3.5hp | 22.21 | 17.21 | 9.71 | 29.04 | | Off |
| 569 | PMP-333-1 | 333_HYDROMATIC_S4M1750_7.13" nnhp | 17.5 | 14 | 13.8 | 32.32 | | On |
| 570 | PMP-333-2 | 333_HYDROMATIC_S4M1750_7.13" nnhp | 18.5 | 14 | 13.8 | 32.32 | | Off |
| 4946 | PMP-334-1 | 334_HOMA_AMX434-184_7 1/4" 4hp | -2 | -3 | -5.22 | 18.37 | | On |
| 4949 | PMP-334-2 | 334_HOMA_AMX434-184_7 1/4" 4hp | -1 | -3 | -5.22 | 18.37 | | Off |
| 4954 | PMP-336-1 | 336_HYDROMATIC_HPGH300_4.75" 3hp | 3.883 | 1.8 | 1.3 | 16.23 | | On |
| 4952 | PMP-336-2 | 336_HYDROMATIC_HPGH300_4.75" 3hp | 4.883 | 1.8 | 1.3 | 16.23 | | Off |

| | | | | | | | | |
|-------|-----------|--|---------|---------|---------|-------|-----|-----|
| 3792 | PMP-338-1 | 338_HOMA_AMX444-280_11 7/16" _29hp | 11.7 | 8.7 | 6.7 | 31.91 | | On |
| 3790 | PMP-338-2 | 338_HOMA_AMX444-280_11 7/16" _29hp | 12.7 | 8.7 | 6.7 | 31.91 | | On |
| 3767 | PMP-339-1 | 339_ABS_AFP1049_9.96" _10.8hp | 9.9 | 7.9 | 6.5 | 27.5 | | On |
| 3770 | PMP-339-2 | 339_ABS_AFP1049_9.96" _10.8hp | 10.9 | 7.9 | 6.5 | 27.5 | | Off |
| 22735 | PMP-340-1 | 340_HOMA_AMX434-184_7 1/4" _4hp | 1.2 | -1.3 | -1.5 | 14.31 | | On |
| 22738 | PMP-340-2 | 340_HOMA_AMX434-184_7 1/4" _4hp | 2.2 | -1.3 | -1.5 | 14.31 | | Off |
| 3572 | PMP-341-1 | 341_HOMA_AMX434-218_8 9/16" _10hp | 9.6 | 8.3 | -6.2 | 13.55 | | On |
| 3575 | PMP-341-2 | 341_HOMA_AMX434-218_8 9/16" _10hp | -4.92 | -7 | -6.2 | 13.55 | | On |
| 3202 | PMP-342-1 | 342_HYDROMATIC_S4M1750_8.5" _12hp? | -4 | -7.5 | -8.5 | 13.45 | | On |
| 3203 | PMP-342-2 | 342_HYDROMATIC_S4M1750_8.5" _12hp? | -3 | -7.5 | -8.5 | 13.45 | | Off |
| 553 | PMP-343-1 | 343_Hydromatic_S3HRC_4.19" _UNK | 11.5 | 9.5 | 8 | 29.76 | | On |
| 556 | PMP-343-2 | 343_Hydromatic_S3HRC_4.19" _UNK | 12.5 | 9.5 | 8 | 29.76 | | Off |
| 3653 | PMP-361-1 | 361_HYDROMATIC_S4N_6.25 _UNK | 2.9 | 0.9 | -0.6 | 12.49 | | On |
| 3652 | PMP-361-2 | 361_HYDROMATIC_S4N_6.25 _UNK | 3.9 | 0.9 | -0.6 | 12.49 | | Off |
| 3475 | PMP-393-1 | 393_HYDROMATIC_S4P_7.5" _UNK | -12.42 | -13.42 | -13.42 | 4.08 | | On |
| 3473 | PMP-393-2 | 393_HYDROMATIC_S4P_7.5" _UNK | -11.42 | -13.42 | -13.42 | 4.08 | | Off |
| 3424 | PMP-396-1 | 396_EBARA_32DGUII61.5S_nn" _2hp | -6.71 | -9.21 | -9.21 | 4.79 | | On |
| 3425 | PMP-396-2 | 396_EBARA_32DGUII61.5S_nn" _2hp | -5.71 | -9.21 | -9.21 | 4.79 | | Off |
| 2414 | PMP-401-1 | 401_BARNES_4SE-L_7" _UNK | 11.667 | 10.833 | 7 | 18.16 | | On |
| 2417 | PMP-401-2 | 401_BARNES_4SE-L_7" _UNK | 12.667 | 10.833 | 7 | 18.16 | | On |
| 2502 | PMP-402-1 | 402_ABS_AFP1041_7.64" _3.85hp | -14.913 | -16.997 | -16.997 | 8.58 | | On |
| 2501 | PMP-402-2 | 402_ABS_AFP1041_7.64" _3.85hp | -13.913 | -16.997 | -16.997 | 8.58 | | Off |
| 2506 | PMP-403-1 | 403_BARNES_5.5" _5HP | -0.677 | -2.01 | -2.01 | 13.49 | | On |
| 2508 | PMP-403-2 | 403_BARNES_5.5" _5HP | 0.323 | -2.01 | -2.01 | 13.49 | | On |
| 2434 | PMP-404-1 | 404_HYDROMATIC_S4N_7" _UNK | 0.167 | -1 | -1.4 | 19.02 | | On |
| 2433 | PMP-404-2 | 404_HYDROMATIC_S4N_7" _UNK | 1.167 | -1 | -1.4 | 19.02 | | On |
| 1736 | PMP-405-1 | 405_HOMA_AMX434-228_9" _10hp | 10.833 | 9.583 | 10 | 19.01 | | On |
| 1735 | PMP-405-2 | 405_HOMA_AMX434-228_9" _10hp | 11.833 | 9.583 | 10 | 19.01 | | Off |
| 688 | PMP-406-1 | 406_HOMA_AMX434-193_7 5/8" _5hp | -0.883 | -2.383 | -2.383 | 15.56 | | On |
| 687 | PMP-406-2 | 406_HOMA_AMX434-193_7 5/8" _5hp | 0.117 | -2.383 | -2.383 | 15.56 | | Off |
| 8842 | PMP-407-1 | 407_BARNES_4SE28-4L_6" _3hp | 12.833 | 12.333 | 2 | 18.33 | | On |
| 8846 | PMP-407-2 | 407_BARNES_4SE28-4L_6" _3hp | 13.833 | 12.333 | 2 | 18.33 | | On |
| 8018 | PMP-408-1 | 408_WET_Cal-Range_SWMM-Solver_VFD-Flow-Depth | 0.1 | -1.3 | -8 | 15.7 | MLS | On |
| 8017 | PMP-408-2 | 408_WET_Cal-Range_SWMM-Solver_VFD-Flow-Depth | 1.1 | -1.3 | -8 | 15.7 | MLS | On |
| 22617 | PMP-408-3 | 408_WET_Cal-Range_SWMM-Solver_VFD-Flow-Depth | 2.1 | -1.3 | -8 | 15.7 | MLS | Off |
| 8835 | PMP-409-1 | 409_BARNES_4SE28-4L_6" _3hp | 11 | 10 | 6 | 19.02 | | On |

| | | | | | | | | |
|------|-----------|--------------------------------------|--------|--------|--------|-------|--|-----|
| 8836 | PMP-409-2 | 409_BARNES_4SE28-4L_6"_3hp | 12 | 10 | 6 | 19.02 | | On |
| 8802 | PMP-410-1 | 410_HYDROMATIC_S4P1500_9.5"_15hp | -1.95 | -3.95 | -3.95 | 16.17 | | On |
| 8803 | PMP-410-2 | 410_HYDROMATIC_S4P1500_9.5"_15hp | -0.95 | -3.95 | -3.95 | 16.17 | | Off |
| 8731 | PMP-411-1 | 411_MYERS_6VH50_9"_5hp | -3.617 | -5.867 | -5.867 | 15.05 | | On |
| 8730 | PMP-411-2 | 411_MYERS_6VH50_9"_5hp | -2.617 | -5.867 | -5.867 | 15.05 | | Off |
| 337 | PMP-412-1 | 412_POWER-FLO_PF4NC-SS_6.5-in_2.8bhp | 9.35 | 8.35 | 2 | 19.02 | | On |
| 339 | PMP-412-2 | 412_POWER-FLO_PF4NC-SS_6.5-in_2.8bhp | 10.35 | 8.35 | 2 | 19.02 | | On |
| 411 | PMP-413-1 | 413_UNK MODEL | 0.9 | -4.1 | -4.1 | 18.73 | | On |
| 409 | PMP-413-2 | 413_UNK MODEL | 1.9 | -4.1 | -4.1 | 18.73 | | Off |
| 453 | PMP-414-1 | 414_BARNES_FSE-L6.5"_UNK | 14 | 12 | 2 | 18.96 | | On |
| 454 | PMP-414-2 | 414_BARNES_FSE-L6.5"_UNK | 15 | 12 | 2 | 18.96 | | On |
| 447 | PMP-415-1 | 415_BARNES_4SE37-4L_6.5"_3.6hp | 10.833 | 9.417 | 2 | 16.78 | | On |
| 448 | PMP-415-2 | 415_BARNES_4SE37-4L_6.5"_3.6hp | 11.833 | 9.417 | 2 | 16.78 | | Off |
| 4278 | PMP-416-1 | 416_HOMA_AMX434-155_6 1/8"_3.5hp | 7.4 | 6.15 | 6.15 | 14.66 | | On |
| 4280 | PMP-416-2 | 416_HOMA_AMX434-155_6 1/8"_3.5hp | 8.4 | 6.15 | 6.15 | 14.66 | | On |
| 4171 | PMP-417-1 | 417_BARNES_4SE-L_6.25"_UNK | 9.2 | 6.95 | 6 | 17.89 | | On |
| 4169 | PMP-417-2 | 417_BARNES_4SE-L_6.25"_UNK | 10.2 | 6.95 | 6 | 17.89 | | Off |
| 4163 | PMP-418-1 | 418_PEC_FA100-420_-in_5bhp | -0.75 | -2.583 | -4.6 | 17.26 | | On |
| 4166 | PMP-418-2 | 418_PEC_FA100-420_-in_5bhp | 0.25 | -2.583 | -4.6 | 17.26 | | On |
| 4206 | PMP-419-1 | 419_BARNES_4SE-L_UNK_UNK | 5.117 | 4.2 | -2.2 | 13.95 | | On |
| 4204 | PMP-419-2 | 419_BARNES_4SE-L_UNK_UNK | 6.117 | 4.2 | -2.2 | 13.95 | | Off |
| 4176 | PMP-420-1 | 420A_MYERS_4V15M6-43A_UNK_UNK | 4.713 | 3.463 | -2 | 13.62 | | On |
| 4179 | PMP-420-2 | 420A_MYERS_4V15M6-43A_UNK_UNK | 5.713 | 3.463 | -2 | 13.62 | | Off |
| 4195 | PMP-421-1 | 421_ABS_CB24_2HP | 9.967 | 7.8 | 7.8 | 16.71 | | On |
| 4198 | PMP-421-2 | 421_ABS_CB24_2HP | 10.967 | 7.8 | 7.8 | 16.71 | | Off |
| 4267 | PMP-422-1 | 422_BARNES_4SE28-4L_6"_3hp | 11.633 | 9.967 | -1.2 | 19.13 | | On |
| 4265 | PMP-422-2 | 422_BARNES_4SE28-4L_6"_3hp | 12.633 | 9.967 | -1.2 | 19.13 | | Off |
| 4260 | PMP-423-1 | 423_HYDROMATIC_S4N_5.88"_UNK | 5.09 | 4.59 | 4.59 | 13.84 | | On |
| 4261 | PMP-423-2 | 423_HYDROMATIC_S4N_5.88"_UNK | 6.09 | 4.59 | 4.59 | 13.84 | | Off |
| 511 | PMP-424-1 | 424_HYDROMATIC_S4M1750_8.5"_12.6hp | 1 | -0.5 | -0.5 | 17.13 | | On |
| 512 | PMP-424-2 | 424_HYDROMATIC_S4M1750_8.5"_12.6hp | 2 | -0.5 | -0.5 | 17.13 | | On |
| 547 | PMP-425-1 | 425_HYDROMATIC_S4N1750_7.5625"_6.9hp | 17.5 | 15.5 | 15.5 | 25.36 | | On |
| 549 | PMP-425-2 | 425_HYDROMATIC_S4N1750_7.5625"_6.9hp | 18.5 | 15.5 | 15.5 | 25.36 | | Off |
| 606 | PMP-426-1 | 426_HOMA_AMX434-228_9"_10hp | 13.5 | 11.5 | 11 | 24.31 | | On |
| 609 | PMP-426-2 | 426_HOMA_AMX434-228_9"_10hp | 14.5 | 11.5 | 11 | 24.31 | | On |
| 1368 | PMP-431-1 | 431_HOMA_AMX434-178_7"_4hp | -1.2 | -6.2 | -6.2 | 9.17 | | On |

| | | | | | | | | |
|------|-----------|--------------------------------------|---------|---------|---------|-------|--|-----|
| 1365 | PMP-431-2 | 431_HOMA_AMX434-178_7" _4hp | -0.2 | -6.2 | -6.2 | 9.17 | | Off |
| 230 | PMP-432-1 | 432_HOMA_AMX646-310_12 5/16" _15hp | 1.5 | -2 | -2.7 | 18.99 | | On |
| 228 | PMP-432-2 | 432_HOMA_AMX646-310_12 5/16" _15hp | 2.5 | -2 | -2.7 | 18.99 | | Off |
| 733 | PMP-433-1 | 433_HOMA_AMX646-300_11 3/16" _9hp | -2.25 | -5.25 | -5.3 | 18.89 | | On |
| 731 | PMP-433-2 | 433_HOMA_AMX646-300_11 3/16" _9hp | -1.25 | -5.25 | -5.3 | 18.89 | | Off |
| 725 | PMP-434-1 | 434#1_HOMA_AMX644-260_10 1/4" _20hp | 4.71 | -10.45 | -10.5 | 14.16 | | On |
| 726 | PMP-434-2 | 434#2_ITT_NP3171.181_244mm_25hp | -1.87 | -10.45 | -10.5 | 14.16 | | On |
| 2983 | PMP-435-1 | 435_BARNES_4SE37-4L_6.25" _3.24hp | 10.3 | 6.8 | 6.8 | 19.58 | | On |
| 2984 | PMP-435-2 | 435_BARNES_4SE37-4L_6.25" _3.24hp | 11.3 | 6.8 | 6.8 | 19.58 | | Off |
| 9189 | PMP-436-1 | 436#1_HYDROMATIC_S4M1500_9" _15hp | 11.63 | 9.97 | 5.1 | 25.2 | | On |
| 9192 | PMP-436-2 | 436#2_HOMA_AMX434-184_7 1/4" _4hp | 9.43 | 8.77 | 5.1 | 25.2 | | On |
| 2977 | PMP-437-1 | 437_HYDROMATIC_S4N_UNK_UNK | -0.18 | -3.43 | -3.5 | 13.66 | | On |
| 2978 | PMP-437-2 | 437_HYDROMATIC_S4N_UNK_UNK | 1.18 | -3.43 | -3.5 | 13.66 | | Off |
| 2706 | PMP-438-1 | 438_HOMA_AM434-150/2.9N_-in_2bhp | 3.51 | 2.26 | -14.75 | 21.01 | | On |
| 2704 | PMP-438-2 | 438_HOMA_AM434-150/2.9N_-in_2bhp | 4.51 | 2.26 | -14.75 | 21.01 | | Off |
| 2610 | PMP-439-1 | 439_BARNES_6SE360-4HL_8.75" _nnhp | -10.333 | -13.167 | -14.9 | 11.82 | | On |
| 2611 | PMP-439-2 | 439_BARNES_6SE360-4HL_8.75" _nnhp | -9.333 | -13.167 | -14.9 | 11.82 | | On |
| 2614 | PMP-440-1 | 440_HYDROMATIC_S4N1750_9" _10hp? | -8.75 | -10.333 | -10.333 | 10.67 | | On |
| 2616 | PMP-440-2 | 440_HYDROMATIC_S4N1750_9" _10hp? | -7.75 | -10.333 | -10.333 | 10.67 | | On |
| 1085 | PMP-457-1 | 457#1_HOMA_AMX434-155_6 1/8" _4hp | 20.1 | 17.83 | 17.83 | 27.22 | | On |
| 1086 | PMP-457-2 | 457#2_BARNES_4SE204-204_6.62" _nnhp | 21.1 | 17.83 | 17.83 | 27.22 | | Off |
| 1113 | PMP-458-1 | 458#1_HOMA_AMX434-178_7" _4hp | 15.5 | 13.5 | 13.24 | 29.46 | | On |
| 1115 | PMP-458-2 | 458#2_HYDROMATIC_5.88" _2.5hp | 16.5 | 13.5 | 13.24 | 29.46 | | Off |
| 4183 | PMP-460-1 | 460_HOMA_AMX434-142_5 9/16" _2.5hp | 9.167 | 6.75 | 6.75 | 14.08 | | On |
| 4182 | PMP-460-2 | 460_HOMA_AMX434-142_5 9/16" _2.5hp | 10.167 | 6.75 | 6.75 | 14.08 | | Off |
| 9283 | PMP-469-1 | 469_HOMA_AMX434-178_7" _4hp | 0.5 | -1 | -2.16 | 19.31 | | On |
| 9285 | PMP-469-2 | 469_HOMA_AMX434-178_7" _4hp | 1.5 | -1 | -2.16 | 19.31 | | Off |
| 322 | PMP-471-1 | 471_HYDROMATIC_S4N_UNK_UNK | 9.5 | 7 | 7 | 18.52 | | On |
| 321 | PMP-471-2 | 471_HYDROMATIC_S4N_UNK_UNK | 10.5 | 7 | 7 | 18.52 | | Off |
| 1707 | PMP-484-1 | 484_HOMA_AM434-150/2.9N_-in_2bhp | 3.633 | 1.383 | 1.383 | 17.61 | | On |
| 1706 | PMP-484-2 | 484_HOMA_AM434-150/2.9N_-in_2bhp | 4.633 | 1.383 | 1.383 | 17.61 | | Off |
| 1713 | PMP-485-1 | 485_HYDROMATIC_HPGH300_5.25" _3hp | 10 | 8.833 | 8.8 | 19.08 | | On |
| 1714 | PMP-485-2 | 485_HYDROMATIC_HPGH300_5.25" _3hp | 11 | 8.833 | 8.8 | 19.08 | | Off |
| 1753 | PMP-486-1 | 486_HYDROMATIC_SPG_UNK_UNK | 13.25 | 12.167 | 12 | 18.57 | | On |
| 1751 | PMP-486-2 | 486_HYDROMATIC_SPG_UNK_UNK | 14.25 | 12.167 | 12 | 18.57 | | Off |
| 9218 | PMP-488-1 | 488_HYDROMATIC_S4HRC3450_5.69" _15hp | -1 | -5 | -6.5 | 15.77 | | On |

| | | | | | | | | |
|------|-----------|-------------------------------------|-----|-----|------|-------|--|-----|
| 9217 | PMP-488-2 | 488_HYDROMATIC_S4HRC3450_5.69"_15hp | 0 | -5 | -6.5 | 15.77 | | Off |
| 9226 | PMP-491-1 | 491_HYDROMATIC_S4P750_8.25"_7.5hp | 7.5 | 3.5 | 2 | 23.89 | | On |
| 9223 | PMP-491-2 | 491_HYDROMATIC_S4P750_8.25"_7.5hp | 8.5 | 3.5 | 2 | 23.89 | | Off |

Wet Well Flex Table

| ID | Label | Operating Range Type | Elevation (Base) (ft) | Elevation (Ground) (ft) | Elevation (Initial) (ft) | Elevation (Minimum) (ft) | Elevation (Maximum) (ft) | Diameter (ft) | Section | Area (Average) (ft ²) |
|------|--------|----------------------|-----------------------|-------------------------|--------------------------|--------------------------|--------------------------|---------------|------------------------------|-----------------------------------|
| 5861 | WW-054 | Elevation | -15.5 | 1.154 | -12 | -15.5 | 6 | 6 | Constant Area - Circular | |
| 5953 | WW-055 | Elevation | -15.5 | 3.444 | -6.3 | -15.5 | 6 | 4 | Constant Area - Circular | |
| 5855 | WW-056 | Elevation | -12.8 | 3.775 | -9 | -12.8 | 4.5 | 5.75 | Constant Area - Circular | |
| 5849 | WW-057 | Elevation | -19 | 2.756 | -16 | -19 | 0 | 7.5 | Constant Area - Circular | |
| 6618 | WW-058 | Elevation | -15.5 | 1.921 | -12.5 | -15.5 | 0 | 7.5 | Constant Area - Circular | |
| 8363 | WW-059 | Elevation | -13 | 1.82 | -9 | -13 | 0.6 | 6 | Constant Area - Circular | |
| 6427 | WW-060 | Elevation | -14.6 | 1.848 | -11 | -14.6 | 5.2 | 8 | Constant Area - Circular | |
| 6432 | WW-061 | Elevation | -12.6 | 2.302 | -9.1 | -12.6 | 6.4 | 6 | Constant Area - Circular | |
| 8356 | WW-062 | Elevation | -18.99 | 2.388 | -13.5 | -18.99 | 3 | 12 | Constant Area - Circular | |
| 6363 | WW-063 | Elevation | -15.25 | 1.42 | -13.5 | -15.25 | 4.2 | 6 | Constant Area - Circular | |
| 8349 | WW-064 | Elevation | -16.26 | 2.039 | -8.63 | -16.26 | 5.2 | 12 | Constant Area - Circular | |
| 8370 | WW-065 | Elevation | -17.29 | 3.085 | -7.3 | -17.29 | 4.4 | 8 | Constant Area - Circular | |
| 8469 | WW-066 | Elevation | -11.5 | 1.85 | -7.75 | -11.5 | 3.4 | 13 | Constant Area - Circular | |
| 8647 | WW-067 | Elevation | -17.1 | 2.101 | -14 | -17.1 | 3.4 | 6 | Constant Area - Circular | |
| 8378 | WW-068 | Elevation | -16.63 | 1.911 | -13.5 | -16.63 | 3.3 | 8 | Constant Area - Circular | |
| 5842 | WW-071 | Elevation | -15.75 | 8 | -12.1 | -15.75 | 8 | | Constant Area - Non-Circular | 232 |
| 6668 | WW-074 | Elevation | -12.8 | 1.902 | -2 | -12.8 | 4.5 | 4 | Constant Area - Circular | |
| 7989 | WW-101 | Elevation | -10.5 | 3.794 | -7.67 | -10.5 | 6.5 | 12 | Constant Area - Circular | |
| 2057 | WW-102 | Elevation | -9.5 | 3.645 | 1.28 | -9.5 | 9.2 | 4 | Constant Area - Circular | |
| 1515 | WW-103 | Elevation | 0.78 | 14.282 | 6.58 | 0.78 | 13.29 | 5 | Constant Area - Circular | |
| 8002 | WW-104 | Elevation | -14.6 | 9.346 | -6.85 | -14.6 | 10.9 | | Constant Area - Non-Circular | 120 |
| 1525 | WW-105 | Elevation | -4.9 | 5.469 | 1.17 | -4.9 | 12 | 6 | Constant Area - Circular | |
| 7983 | WW-106 | Elevation | 8.39 | 18.34 | 12.18 | 8.39 | 18.55 | 6 | Constant Area - Circular | |
| 7927 | WW-107 | Elevation | 3.11 | 21.121 | 6.68 | 3.11 | 23.26 | 6 | Constant Area - Circular | |
| 7922 | WW-108 | Elevation | 7.2 | 23.496 | 8.95 | 7.2 | 21.2 | 6 | Constant Area - Circular | |
| 7756 | WW-109 | Elevation | 0.25 | 15.643 | 4.53 | 0.25 | 19.7 | 6 | Constant Area - Circular | |
| 7941 | WW-110 | Elevation | 6 | 23.62 | 10.25 | 6 | 24.5 | 6 | Constant Area - Circular | |
| 4450 | WW-111 | Elevation | 7.87 | 18.929 | 10.45 | 7.87 | 16.37 | 4 | Constant Area - Circular | |
| 7947 | WW-112 | Elevation | 6.34 | 20.022 | 9.17 | 6.34 | 18.34 | 4 | Constant Area - Circular | |

| | | | | | | | | | | |
|-------|--------|-----------|--------|--------|--------|--------|-------|-----|------------------------------|-----|
| 5204 | WW-113 | Elevation | 6.64 | 14.236 | 9.89 | 6.64 | 19.06 | 6 | Constant Area - Circular | |
| 5215 | WW-114 | Elevation | 4.44 | 19.02 | 6.89 | 4.44 | 22.8 | 6 | Constant Area - Circular | |
| 5132 | WW-115 | Elevation | 9.36 | 24.201 | 12.53 | 9.36 | 16.95 | 6 | Constant Area - Circular | |
| 7901 | WW-116 | Elevation | -2.9 | 18.045 | 0.7 | -2.9 | 19.2 | 6 | Constant Area - Circular | |
| 7867 | WW-117 | Elevation | 2 | 14.238 | 7.5 | 2 | 15 | 4 | Constant Area - Circular | |
| 7872 | WW-118 | Elevation | -1 | 14.016 | 7.98 | -1 | 19.4 | 6 | Constant Area - Circular | |
| 7851 | WW-119 | Elevation | -2.83 | 19.773 | 3.17 | -2.83 | 24.25 | 6 | Constant Area - Circular | |
| 5670 | WW-120 | Elevation | -10 | 8.059 | -7 | -10 | 6.55 | 6 | Constant Area - Circular | |
| 7893 | WW-122 | Elevation | -21.99 | 0.902 | -16.5 | -21.99 | 8.88 | 6 | Constant Area - Circular | |
| 5727 | WW-123 | Elevation | -9.79 | 0.565 | -6.5 | -9.79 | 5 | 6 | Constant Area - Circular | |
| 5790 | WW-124 | Elevation | -16.6 | 2.352 | -13 | -16.6 | 3.5 | 6 | Constant Area - Circular | |
| 4465 | WW-125 | Elevation | 0.3 | 17.587 | 5 | 0.3 | 20 | 8 | Constant Area - Circular | |
| 3975 | WW-126 | Elevation | -5.4 | 20.234 | -0.5 | -5.4 | 20 | 12 | Constant Area - Circular | |
| 5044 | WW-127 | Elevation | 2 | 14.414 | 7.16 | 2 | 14.41 | | Constant Area - Non-Circular | 60 |
| 4507 | WW-128 | Elevation | 2 | 20.071 | 13.75 | 2 | 20 | 4 | Constant Area - Circular | |
| 4511 | WW-129 | Elevation | -4.2 | 17.599 | 0.53 | -4.2 | 20.2 | 12 | Constant Area - Circular | |
| 4638 | WW-130 | Elevation | -0.15 | 17.909 | 2.2 | -0.15 | 17.2 | 6 | Constant Area - Circular | |
| 2363 | WW-132 | Elevation | 2.65 | 14.556 | 6.5 | 2.65 | 18 | 6 | Constant Area - Circular | |
| 1747 | WW-133 | Elevation | -2 | 10.427 | 5.65 | -2 | 11.9 | 4 | Constant Area - Circular | |
| 22745 | WW-134 | Elevation | -9 | 3.081 | -5.2 | -9 | 4.8 | 7 | Constant Area - Circular | |
| 2601 | WW-135 | Elevation | -18.8 | 8.368 | -12.83 | -18.8 | 7 | 10 | Constant Area - Circular | |
| 2697 | WW-136 | Elevation | -11.78 | 1.943 | -8.17 | -11.78 | 6 | 6 | Constant Area - Circular | |
| 2724 | WW-137 | Elevation | -7 | 9.084 | -3.67 | -7 | 9 | 8 | Constant Area - Circular | |
| 7958 | WW-138 | Elevation | -2.66 | 18.788 | 4.02 | -2.66 | 18.79 | | Constant Area - Non-Circular | 232 |
| 7995 | WW-139 | Elevation | -15.95 | 3.073 | -11.45 | -15.95 | 3.07 | | Constant Area - Non-Circular | 232 |
| 4456 | WW-140 | Elevation | 8.2 | 23.968 | 12.75 | 8.2 | 25.5 | 6 | Constant Area - Circular | |
| 8009 | WW-141 | Elevation | -5.3 | 9.313 | -0.87 | -5.3 | 12.71 | 6 | Constant Area - Circular | |
| 5209 | WW-142 | Elevation | 9.6 | 19.144 | 13.13 | 9.6 | 22.3 | 6 | Constant Area - Circular | |
| 4471 | WW-143 | Elevation | 2.93 | 14.643 | 7.34 | 2.93 | 20.09 | 6 | Constant Area - Circular | |
| 1489 | WW-145 | Elevation | -10.5 | 3.735 | -7.13 | -10.5 | 8.7 | 8 | Constant Area - Circular | |
| 7969 | WW-146 | Elevation | 6.2 | 23.316 | 8.58 | 6.2 | 24 | 6 | Constant Area - Circular | |
| 8847 | WW-147 | Elevation | -13.69 | 7.063 | -8.91 | -13.69 | 9.59 | 6 | Constant Area - Circular | |
| 6789 | WW-148 | Elevation | 10 | 20.535 | 14.66 | 10 | 22.66 | 5.5 | Constant Area - Circular | |
| 2730 | WW-149 | Elevation | 0.21 | 9.496 | 2.46 | 0.21 | 10.21 | 4 | Constant Area - Circular | |
| 7933 | WW-150 | Elevation | 2.5 | 24.006 | 5.34 | 2.5 | 24.01 | 10 | Constant Area - Circular | |

| | | | | | | | | | | |
|-------|--------|-----------|--------|--------|--------|--------|-------|------|------------------------------|-----|
| 7917 | WW-159 | Elevation | 7.2 | 23.935 | 11.67 | 7.2 | 26.5 | 6 | Constant Area - Circular | |
| 4462 | WW-160 | Elevation | 6.3 | 16.507 | 9.77 | 6.3 | 18.15 | 10 | Constant Area - Circular | |
| 22778 | WW-161 | Elevation | 1.08 | 7.355 | 3.61 | 1.08 | 9.19 | 4 | Constant Area - Circular | |
| 5533 | WW-201 | Elevation | -8 | 3.194 | -4.6 | -8 | 3.9 | 6 | Constant Area - Circular | |
| 5720 | WW-202 | Elevation | -18.67 | 0.328 | -15.17 | -18.67 | 0.33 | 6 | Constant Area - Circular | |
| 7885 | WW-203 | Elevation | -12.75 | 3.883 | -12 | -12.75 | 3.88 | | Constant Area - Non-Circular | 232 |
| 5712 | WW-204 | Elevation | -10.3 | 0.75 | -8.3 | -10.3 | 5.2 | 6 | Constant Area - Circular | |
| 5836 | WW-205 | Elevation | -13.33 | 3.69 | -11 | -13.33 | 4.5 | 6 | Constant Area - Circular | |
| 5879 | WW-206 | Elevation | -16 | 2.161 | -12.5 | -16 | 4.5 | 6 | Constant Area - Circular | |
| 8954 | WW-207 | Elevation | -13 | 6.32 | -9 | -13 | 7.5 | 6 | Constant Area - Circular | |
| 8943 | WW-208 | Elevation | -8.9 | 3.188 | -5.6 | -8.9 | 7.9 | 10 | Constant Area - Circular | |
| 8959 | WW-209 | Elevation | -8 | 4.796 | 0.5 | -8 | 5 | 4 | Constant Area - Circular | |
| 4090 | WW-210 | Elevation | 4.8 | 20.111 | 7.25 | 4.8 | 19 | 6 | Constant Area - Circular | |
| 6784 | WW-211 | Elevation | 0.2 | 18.489 | 4.6 | 0.2 | 19.2 | 8 | Constant Area - Circular | |
| 6989 | WW-212 | Elevation | 8.31 | 20.896 | 14 | 8.31 | 23.5 | 6 | Constant Area - Circular | |
| 6964 | WW-213 | Elevation | 9.53 | 24.165 | 12.5 | 9.53 | 25.8 | 6 | Constant Area - Circular | |
| 5584 | WW-214 | Elevation | 6.93 | 14.857 | 8 | 6.93 | 16.9 | 4 | Constant Area - Circular | |
| 5599 | WW-215 | Elevation | 3.9 | 13.752 | 8 | 3.9 | 16.5 | 4 | Constant Area - Circular | |
| 5572 | WW-216 | Elevation | 3.77 | 18.855 | 6.77 | 3.77 | 18.27 | 6 | Constant Area - Circular | |
| 5538 | WW-217 | Elevation | -22.2 | 6.487 | -15 | -22.2 | 6.49 | 6 | Constant Area - Circular | |
| 9166 | WW-218 | Elevation | -13 | 4.746 | -7 | -13 | 6 | 8 | Constant Area - Circular | |
| 9154 | WW-219 | Elevation | -10.6 | 8.646 | -6.5 | -10.6 | 10 | 6 | Constant Area - Circular | |
| 9180 | WW-220 | Elevation | -16.42 | 5.032 | -11.92 | -16.42 | 6 | | Constant Area - Non-Circular | 120 |
| 8323 | WW-221 | Elevation | -8.6 | 8.904 | -2.68 | -8.6 | 8 | 8 | Constant Area - Circular | |
| 8167 | WW-222 | Elevation | -4.1 | 2.896 | -1.6 | -4.1 | 2.9 | 6 | Constant Area - Circular | |
| 8163 | WW-223 | Elevation | -7.44 | 5.14 | -2.5 | -7.44 | 10 | 6 | Constant Area - Circular | |
| 8328 | WW-224 | Elevation | -7.29 | 8.689 | -2.5 | -7.29 | 11 | 6 | Constant Area - Circular | |
| 8337 | WW-225 | Elevation | -14 | 4.049 | -9 | -14 | 5.2 | 8 | Constant Area - Circular | |
| 9173 | WW-226 | Elevation | -4.7 | 10.387 | 2.3 | -4.7 | 12.2 | 11.5 | Constant Area - Circular | |
| 7462 | WW-227 | Elevation | -4.3 | 9.326 | 1.3 | -4.3 | 8.3 | | Constant Area - Non-Circular | 50 |
| 7554 | WW-228 | Elevation | 0.59 | 18.795 | 4.6 | 0.59 | 19.6 | 5 | Constant Area - Circular | |
| 7584 | WW-229 | Elevation | -9.83 | 0.175 | -6.5 | -9.83 | 5 | 6 | Constant Area - Circular | |
| 7408 | WW-230 | Elevation | -15 | 8.25 | -12 | -15 | 4.5 | 8 | Constant Area - Circular | |
| 7415 | WW-231 | Elevation | -12 | 3.065 | -9 | -12 | 4.5 | 6 | Constant Area - Circular | |
| 7403 | WW-232 | Elevation | -7 | 6.034 | -4 | -7 | 7 | 6 | Constant Area - Circular | |

| | | | | | | | | | | |
|-------|--------|-----------|--------|--------|-------|--------|-------|----|------------------------------|-----|
| 6959 | WW-233 | Elevation | -9.2 | 5.332 | -6.3 | -9.2 | 5.7 | 8 | Constant Area - Circular | |
| 7624 | WW-234 | Elevation | -10.9 | 5.868 | -7.9 | -10.9 | 7.1 | 6 | Constant Area - Circular | |
| 7728 | WW-235 | Elevation | -7 | 5 | -1.5 | -7 | 5 | 6 | Constant Area - Circular | |
| 6951 | WW-236 | Elevation | -0.4 | 20.155 | 5.6 | -0.4 | 22.1 | 8 | Constant Area - Circular | |
| 7878 | WW-237 | Elevation | -0.25 | 22.104 | 5.077 | -0.25 | 22.1 | | Constant Area - Non-Circular | 232 |
| 4000 | WW-238 | Elevation | -0.2 | 21.853 | 4.47 | -0.2 | 23.3 | 8 | Constant Area - Circular | |
| 3953 | WW-239 | Elevation | -0.8 | 23.728 | 4.17 | -0.8 | 22.5 | 10 | Constant Area - Circular | |
| 3964 | WW-240 | Elevation | 0.5 | 18.261 | 5.67 | 0.5 | 20 | 6 | Constant Area - Circular | |
| 3959 | WW-241 | Elevation | 0 | 18.962 | 5.58 | 0 | 19 | 10 | Constant Area - Circular | |
| 8204 | WW-242 | Elevation | -4 | 11.901 | 0.3 | -4 | 12.3 | 6 | Constant Area - Circular | |
| 7 | WW-243 | Elevation | 0.32 | 17.278 | 3.2 | 0.32 | 17.7 | 6 | Constant Area - Circular | |
| 5495 | WW-245 | Elevation | -10.89 | 5.97 | -8.39 | -10.89 | 8.84 | 6 | Constant Area - Circular | |
| 205 | WW-246 | Elevation | -3.7 | 15.485 | 0.43 | -3.7 | 17.93 | 6 | Constant Area - Circular | |
| 216 | WW-247 | Elevation | -14.2 | 1.644 | -10 | -14.2 | 7 | 4 | Constant Area - Circular | |
| 7953 | WW-248 | Elevation | -6.22 | 19.057 | 5.33 | -6.22 | 20.5 | | Constant Area - Non-Circular | 120 |
| 5743 | WW-249 | Elevation | -20.5 | 3.708 | -16.5 | -20.5 | 5 | 8 | Constant Area - Circular | |
| 8896 | WW-250 | Elevation | -4.2 | 9.652 | -1 | -4.2 | 11.5 | 4 | Constant Area - Circular | |
| 8855 | WW-251 | Elevation | -8.5 | 6.992 | -4.5 | -8.5 | 8.5 | 6 | Constant Area - Circular | |
| 5509 | WW-257 | Elevation | -1.51 | 8.219 | 2.1 | -1.51 | 12 | 6 | Constant Area - Circular | |
| 8345 | WW-258 | Elevation | -5.72 | 6.77 | -3.23 | -5.72 | 8.5 | 4 | Constant Area - Circular | |
| 7010 | WW-259 | Elevation | 0.6 | 9.456 | 4.1 | 0.6 | 12.6 | 4 | Constant Area - Circular | |
| 7976 | WW-260 | Elevation | -5.78 | 15.346 | -1.03 | -5.78 | 15.8 | 10 | Constant Area - Circular | |
| 22631 | WW-262 | Elevation | 4.17 | 18.264 | 7.92 | 4.17 | 20.42 | 5 | Constant Area - Circular | |
| 22629 | WW-263 | Elevation | -2.45 | 14.716 | 2.62 | -2.45 | 16.12 | 6 | Constant Area - Circular | |
| 22630 | WW-264 | Elevation | 1.16 | 16.514 | 4.16 | 1.16 | 18.5 | 6 | Constant Area - Circular | |
| 190 | WW-265 | Elevation | -6 | 8.053 | -2.5 | -6 | 6 | 10 | Constant Area - Circular | |
| 22632 | WW-298 | Elevation | 7.5 | 27.198 | 12.5 | 7.5 | 28.5 | 6 | Constant Area - Circular | |
| 4688 | WW-301 | Elevation | 3.2 | 19.087 | 10.62 | 3.2 | 17.2 | 5 | Constant Area - Circular | |
| 4684 | WW-302 | Elevation | -5.7 | 9.394 | -1.33 | -5.7 | 14 | 8 | Constant Area - Circular | |
| 4805 | WW-303 | Elevation | -6.7 | 15.073 | -4.18 | -6.7 | 14.9 | 10 | Constant Area - Circular | |
| 4718 | WW-304 | Elevation | 3.7 | 17.696 | 7.27 | 3.7 | 19.09 | 8 | Constant Area - Circular | |
| 4703 | WW-305 | Elevation | 1.66 | 14.138 | 5.66 | 1.66 | 17.25 | 10 | Constant Area - Circular | |
| 3777 | WW-308 | Elevation | 5.38 | 31.944 | 10.63 | 5.38 | 33 | 12 | Constant Area - Circular | |
| 3207 | WW-318 | Elevation | 12.67 | 33.666 | 17.67 | 12.67 | 33.67 | 10 | Constant Area - Circular | |
| 3189 | WW-319 | Elevation | 9.7 | 29.939 | 19.1 | 9.7 | 32.1 | 8 | Constant Area - Circular | |

| | | | | | | | | | | |
|-------|--------|-----------|--------|--------|--------|--------|-------|----|------------------------------|-----|
| 3195 | WW-320 | Elevation | 2.06 | 14.797 | 6.82 | 2.06 | 15.82 | 6 | Constant Area - Circular | |
| 3773 | WW-322 | Elevation | 8.71 | 29.042 | 21.71 | 8.71 | 31.71 | 6 | Constant Area - Circular | |
| 568 | WW-333 | Elevation | 12.8 | 32.317 | 18 | 12.8 | 34 | 8 | Constant Area - Circular | |
| 4945 | WW-334 | Elevation | -6.22 | 18.371 | -1.5 | -6.22 | 20.5 | 8 | Constant Area - Circular | |
| 4953 | WW-336 | Elevation | 0.3 | 16.23 | 4.38 | 0.3 | 17.8 | 6 | Constant Area - Circular | |
| 3789 | WW-338 | Elevation | 5.7 | 31.908 | 12.2 | 5.7 | 32.7 | 8 | Constant Area - Circular | |
| 3766 | WW-339 | Elevation | 5.5 | 27.504 | 10.4 | 5.5 | 28.9 | 8 | Constant Area - Circular | |
| 22633 | WW-340 | Elevation | -2.5 | 14.306 | 1.7 | -2.5 | 16.2 | 6 | Constant Area - Circular | |
| 3571 | WW-341 | Elevation | -7.2 | 13.55 | 10.1 | -7.2 | 15 | 8 | Constant Area - Circular | |
| 3201 | WW-342 | Elevation | -9.5 | 13.453 | -3.5 | -9.5 | 15 | 8 | Constant Area - Circular | |
| 555 | WW-343 | Elevation | 7 | 29.757 | 12 | 7 | 30.5 | 6 | Constant Area - Circular | |
| 3651 | WW-361 | Elevation | -1.6 | 12.488 | 3.4 | -1.6 | 15.9 | 6 | Constant Area - Circular | |
| 3474 | WW-393 | Elevation | -14.42 | 4.084 | -11.92 | -14.42 | 4.08 | 10 | Constant Area - Circular | |
| 3423 | WW-396 | Elevation | -10.21 | 4.788 | -6.21 | -10.21 | 4.79 | 10 | Constant Area - Circular | |
| 2413 | WW-401 | Elevation | 7 | 18.159 | 12.17 | 7 | 23 | 5 | Constant Area - Circular | |
| 2500 | WW-402 | Elevation | -18 | 8.582 | -14.41 | -18 | 6.67 | 6 | Constant Area - Circular | |
| 2507 | WW-403 | Elevation | -3.01 | 13.488 | -0.18 | -3.01 | 13.49 | 4 | Constant Area - Circular | |
| 2432 | WW-404 | Elevation | -2.4 | 19.019 | 0.67 | -2.4 | 18 | 8 | Constant Area - Circular | |
| 1734 | WW-405 | Elevation | 9 | 19.012 | 11.33 | 9 | 22 | 6 | Constant Area - Circular | |
| 686 | WW-406 | Elevation | -2.8 | 15.555 | -0.38 | -2.8 | 17.7 | 6 | Constant Area - Circular | |
| 8841 | WW-407 | Elevation | 1 | 18.329 | 13.33 | 1 | 20 | 5 | Constant Area - Circular | |
| 8016 | WW-408 | Elevation | -8 | 15.705 | 1.1 | -8 | 15.7 | | Constant Area - Non-Circular | 232 |
| 8834 | WW-409 | Elevation | 5 | 19.019 | 11.5 | 5 | 25 | 5 | Constant Area - Circular | |
| 8801 | WW-410 | Elevation | -4.8 | 16.166 | -1.45 | -4.8 | 18.8 | 8 | Constant Area - Circular | |
| 8729 | WW-411 | Elevation | -6.87 | 15.049 | -3.12 | -6.87 | 15.05 | 10 | Constant Area - Circular | |
| 336 | WW-412 | Elevation | 1 | 19.019 | 9.85 | 1 | 19.1 | 4 | Constant Area - Circular | |
| 410 | WW-413 | Elevation | -5.1 | 18.732 | 1.4 | -5.1 | 16.9 | 6 | Constant Area - Circular | |
| 452 | WW-414 | Elevation | 1 | 18.961 | 14.5 | 1 | 20 | 4 | Constant Area - Circular | |
| 446 | WW-415 | Elevation | 1 | 16.783 | 11.33 | 1 | 20 | 6 | Constant Area - Circular | |
| 4279 | WW-416 | Elevation | 5.15 | 14.655 | 7.9 | 5.15 | 17.9 | 4 | Constant Area - Circular | |
| 4170 | WW-417 | Elevation | 5 | 17.885 | 9.7 | 5 | 17.2 | 5 | Constant Area - Circular | |
| 4165 | WW-418 | Elevation | -5.6 | 17.258 | -0.25 | -5.6 | 16 | 8 | Constant Area - Circular | |
| 4205 | WW-419 | Elevation | -3.2 | 13.954 | 5.62 | -3.2 | 13.95 | 6 | Constant Area - Circular | |
| 4175 | WW-420 | Elevation | -3 | 13.625 | 5.21 | -3 | 17.38 | 6 | Constant Area - Circular | |
| 4194 | WW-421 | Elevation | 7.6 | 16.707 | 10.47 | 7.6 | 18.3 | 4 | Constant Area - Circular | |

| | | | | | | | | | | |
|------|--------|-----------|--------|--------|-------|--------|-------|----|--------------------------|--|
| 4266 | WW-422 | Elevation | -1.2 | 19.135 | 12.13 | -1.2 | 18.8 | 4 | Constant Area - Circular | |
| 4259 | WW-423 | Elevation | 3.59 | 13.841 | 5.59 | 3.59 | 13.84 | 4 | Constant Area - Circular | |
| 510 | WW-424 | Elevation | -1.5 | 17.125 | 1.5 | -1.5 | 16 | 6 | Constant Area - Circular | |
| 548 | WW-425 | Elevation | 14.5 | 25.36 | 18.36 | 14.5 | 28 | 5 | Constant Area - Circular | |
| 608 | WW-426 | Elevation | 10 | 24.305 | 14 | 10 | 26.5 | 6 | Constant Area - Circular | |
| 1367 | WW-431 | Elevation | -6.7 | 9.168 | -0.7 | -6.7 | 13.8 | 6 | Constant Area - Circular | |
| 227 | WW-432 | Elevation | -3.7 | 18.985 | 2 | -3.7 | 20.5 | 10 | Constant Area - Circular | |
| 732 | WW-433 | Elevation | -6.3 | 18.889 | -1.75 | -6.3 | 18.75 | 10 | Constant Area - Circular | |
| 724 | WW-434 | Elevation | -11.5 | 14.16 | 5.21 | -11.5 | 15 | 12 | Constant Area - Circular | |
| 2982 | WW-435 | Elevation | 5.8 | 19.58 | 10.8 | 5.8 | 19.1 | 4 | Constant Area - Circular | |
| 9188 | WW-436 | Elevation | 4.1 | 25.2 | 12.13 | 4.1 | 24 | 6 | Constant Area - Circular | |
| 2976 | WW-437 | Elevation | -4.5 | 13.663 | -0.68 | -4.5 | 14.4 | 6 | Constant Area - Circular | |
| 2703 | WW-438 | Elevation | -15.75 | 21.01 | 4.01 | -15.75 | 21.01 | 6 | Constant Area - Circular | |
| 2609 | WW-439 | Elevation | -15.9 | 11.817 | -9.83 | -15.9 | 11.5 | 12 | Constant Area - Circular | |
| 2615 | WW-440 | Elevation | -11.25 | 10.669 | -8.25 | -11.25 | 11.5 | 8 | Constant Area - Circular | |
| 1084 | WW-457 | Elevation | 16.83 | 28.22 | 20.6 | 16.83 | 28.22 | 6 | Constant Area - Circular | |
| 1112 | WW-458 | Elevation | 12.24 | 29.46 | 16 | 12.24 | 30.5 | 6 | Constant Area - Circular | |
| 4181 | WW-460 | Elevation | 5.75 | 14.084 | 9.67 | 5.75 | 17.5 | 5 | Constant Area - Circular | |
| 9282 | WW-469 | Elevation | -3.16 | 19.31 | 1 | -3.16 | 21.5 | 8 | Constant Area - Circular | |
| 320 | WW-471 | Elevation | 6.1 | 18.516 | 10 | 6.1 | 18.5 | 6 | Constant Area - Circular | |
| 1705 | WW-484 | Elevation | 0.6 | 17.612 | 4.13 | 0.6 | 18.3 | 8 | Constant Area - Circular | |
| 1712 | WW-485 | Elevation | 7.8 | 19.076 | 10.5 | 7.8 | 21.5 | 6 | Constant Area - Circular | |
| 1752 | WW-486 | Elevation | 11 | 18.567 | 13.75 | 11 | 21 | 6 | Constant Area - Circular | |
| 9216 | WW-488 | Elevation | -7.5 | 15.772 | -0.5 | -7.5 | 17 | 8 | Constant Area - Circular | |
| 9222 | WW-491 | Elevation | 1 | 23.891 | 8 | 1 | 25.5 | 6 | Constant Area - Circular | |

APPENDIX F – FIELD TEST PLAN



MANATEE COUNTY GOVERNMENT

WWCS MASTER PLAN UPDATE

FIELD TEST PLAN

DRAFT

April 2015

MANATEE COUNTY GOVERNMENT

WWCS MASTER PLAN UPDATE

FIELD TEST PLAN

TABLE OF CONTENTS

| | <u>Page</u> |
|---|--------------------|
| 1.0 OVERVIEW..... | 1 |
| 2.0 INSTALLATION OF FLOW METERS..... | 2 |
| 3.0 INSTALLATION OF PRESSURE LOGGERS..... | 7 |
| 4.0 SCADA DATA..... | 10 |

APPENDIX A Event Log

LIST OF TABLES

| | | |
|---------|---|----|
| Table 1 | Flow Meter Locations..... | 6 |
| Table 2 | Temporary Pressure Logger Locations – Week 1..... | 8 |
| Table 3 | Temporary Pressure Logger Locations – Week 2..... | 9 |
| Table 4 | SCADA Data Requirements – North Service Area..... | 10 |
| Table 5 | SCADA Data Requirements – Southwest Service Area..... | 11 |
| Table 6 | SCADA Data Requirements – Southeast Service Area..... | 12 |

LIST OF FIGURES

| | | |
|----------|---|---|
| Figure 1 | Field Test Components – North Service Area..... | 3 |
| Figure 2 | Field Test Components – Southeast Service Area..... | 4 |
| Figure 3 | Field Test Components – Southwest Service Area..... | 5 |

FIELD TEST PLAN

1.0 OVERVIEW

The purpose of the Field Test is to gather data needed to quantify the flow and pressure in various areas of the wastewater collection system. The Field Test will assist in calibrating the County's wastewater collection system hydraulic models. The County's Field Test includes the following components:

- Installation of temporary flow meters
- Installation of temporary pressure loggers
- Collection of SCADA data

The Field Test Plan outlines the specific data required, recommended locations for field measurements, and instructions for installing field equipment. During the Field Test it is important for County staff to track and document any operational changes, maintenance activities, and/or weather events that may affect readings. Table A-1, provided in the Appendix, can be used to keep track of such events.

The Field Test will be completed within a two week period, from **April 14-30, 2015**. The North and Southwest service areas will be tested during Week 1, and the Southeast service area will be tested during Week 2. A detailed schedule is provided below.

Week 1 (North and Southwest Service Areas):

- Tuesday April 14, 2015:
 - Water Resource Technology (WRT) to install flow meters
 - County to install pressure loggers
- Wednesday April 15, 2015:
 - WRT to complete installation of flow meters, if necessary
- Tuesday April 21, 2015:
 - WRT to download data and remove some of the flow meters. Several flow meters will be left in place in the North and Southwest service areas for the entire two-week period. Refer to Section 2.0 for more details.
 - County to uninstall pressure loggers and provide to Carollo to download data.

Week 2 (Southeast Service Area):

- Tuesday April 21, 2015 (if time permits after Week 1 flow meter removal):
 - WRT to install flow meters

- Wednesday April 22, 2015:
 - WRT to complete installation of flow meters
 - County to install pressure loggers
- Thursday April 30, 2015:
 - WRT to remove all flow meters (all service areas)
 - County to remove all pressure loggers

2.0 INSTALLATION OF FLOW METERS

Temporary flowmeters will be installed by a subconsultant, Water Resource Technologies (WRT). Figures 1 through 3 show the locations where flow meters will be installed. Accessibility to County infrastructure will be required for the subconsultant to install the temporary flow meters. Coordination between all parties is required before the start of the monitoring to ensure that the field conditions are appropriate (accessibility, existence of a point of connection, minimum traffic disruption). The County, Carollo, and the subconsultant met on February 19, 2015 to review flow monitoring locations.

Table 1 provides a list of flow meter locations for each service area. Refer to Section 1.0 for a detailed schedule. The County shall provide at least one staff member to accompany the subconsultant and Carollo staff at the time of installation and removal. The County shall also be responsible for providing MOT as needed at each location.

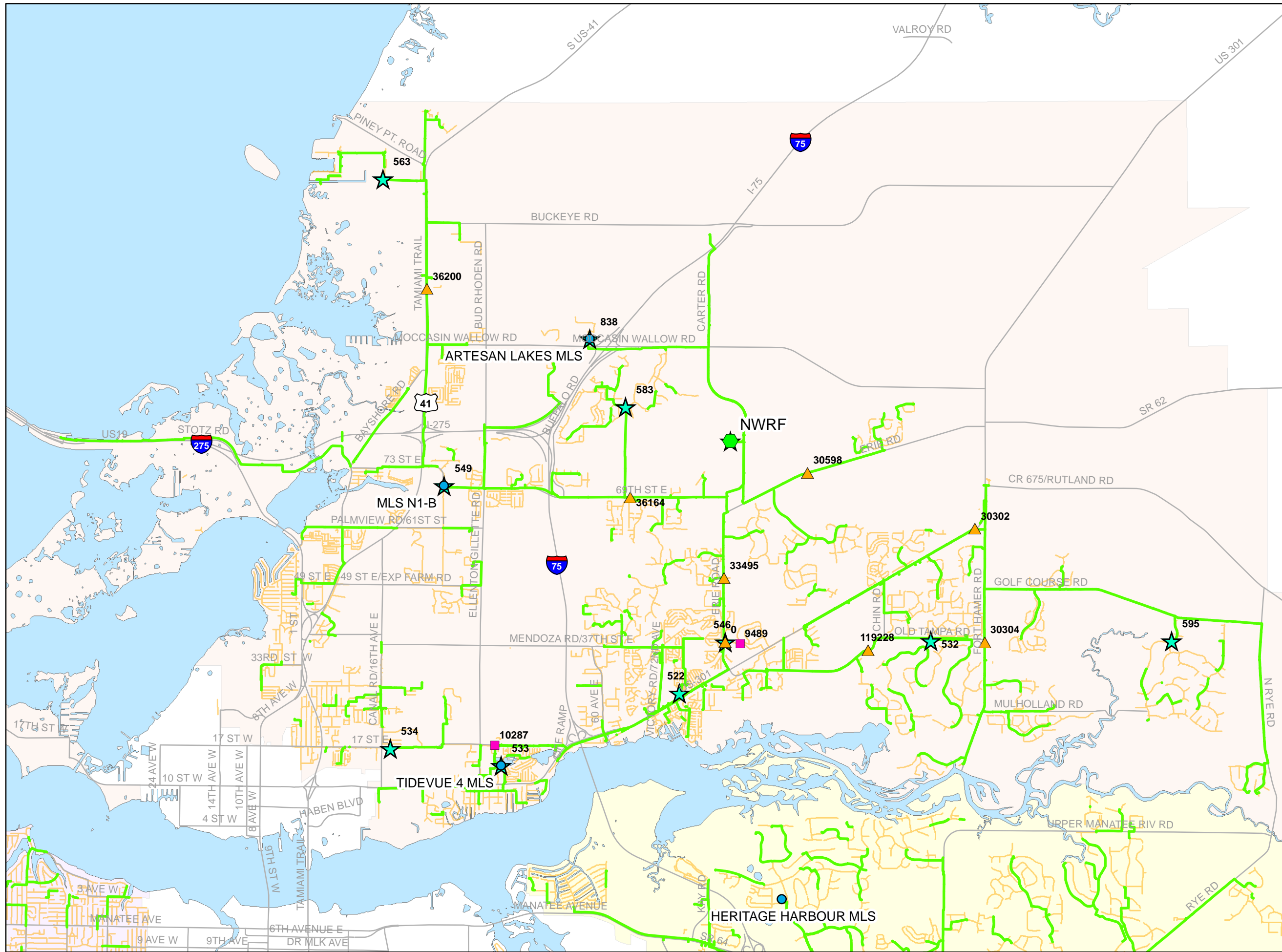

- Legend**
- ◆ Treatment Plants
 - Master Lift Station
 - Temporary Flowmeter (Manhole UWOW #)
 - ▲ Temporary Pressure Logger (ARV UWOW #)
 - ★ SCADA Data Locations (RTU #)
 - County-owned Force Main
 - Gravity Main
 - Major Road
 - North Service Area
 - Southeast Service Area
 - Southwest Service Area

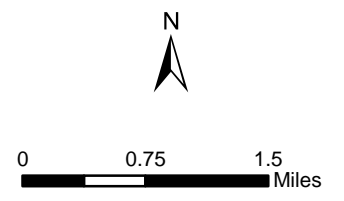
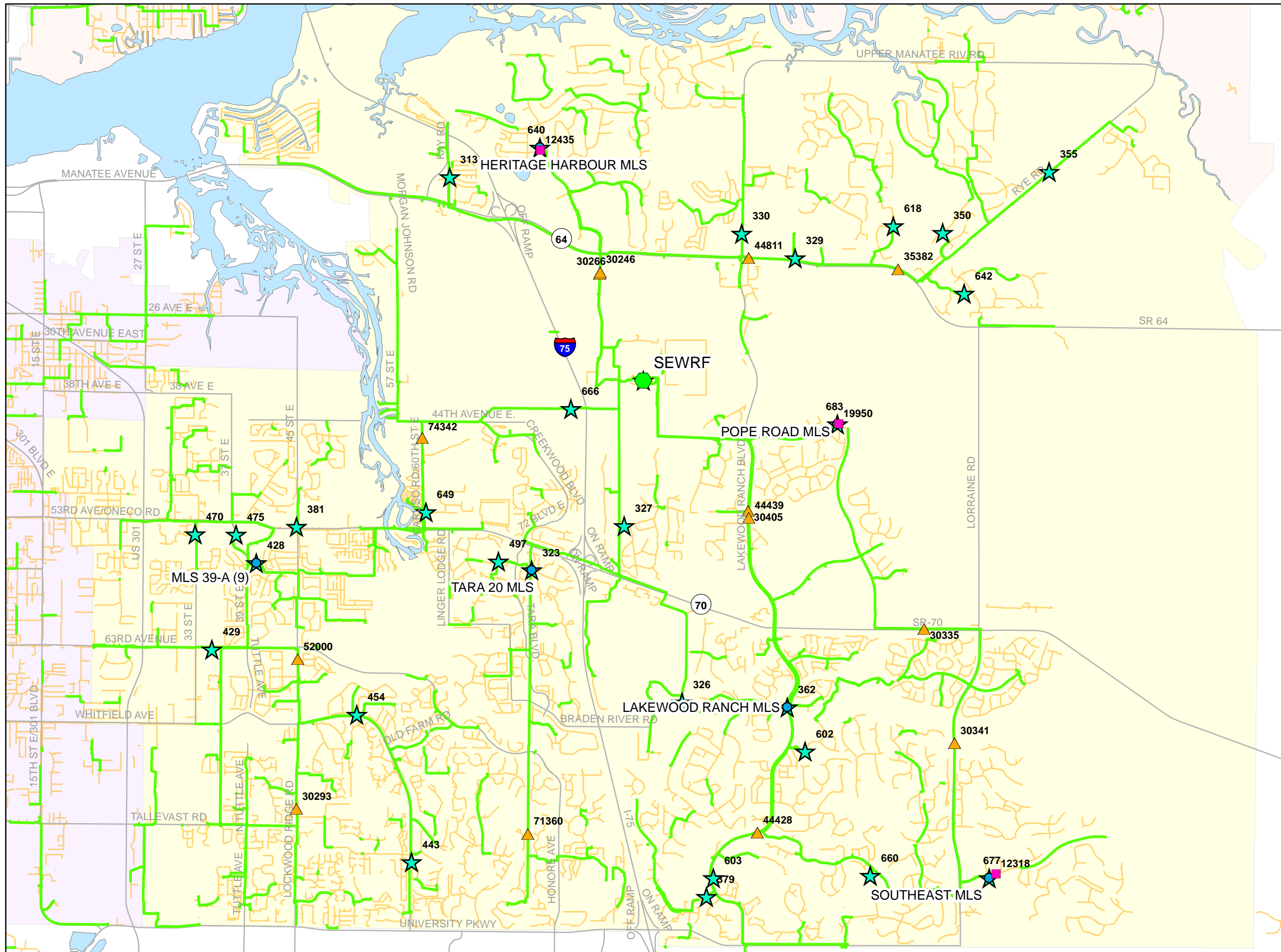

Figure 1
Field Test Components
North Service Area
 WWCS Master Plan Update
 Manatee County





- Legend**
- Treatment Plants
 - Master Lift Station
 - Temporary Flowmeter (Manhole UWOW #)
 - Temporary Pressure Logger (ARV UWOW #)
 - SCADA Data Locations (RTU #)
 - County-owned Force Main
 - Gravity Main
 - Major Road
 - North Service Area
 - Southeast Service Area
 - Southwest Service Area

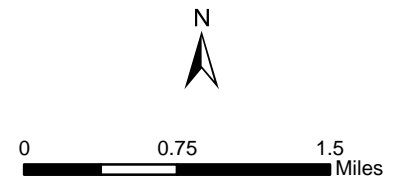
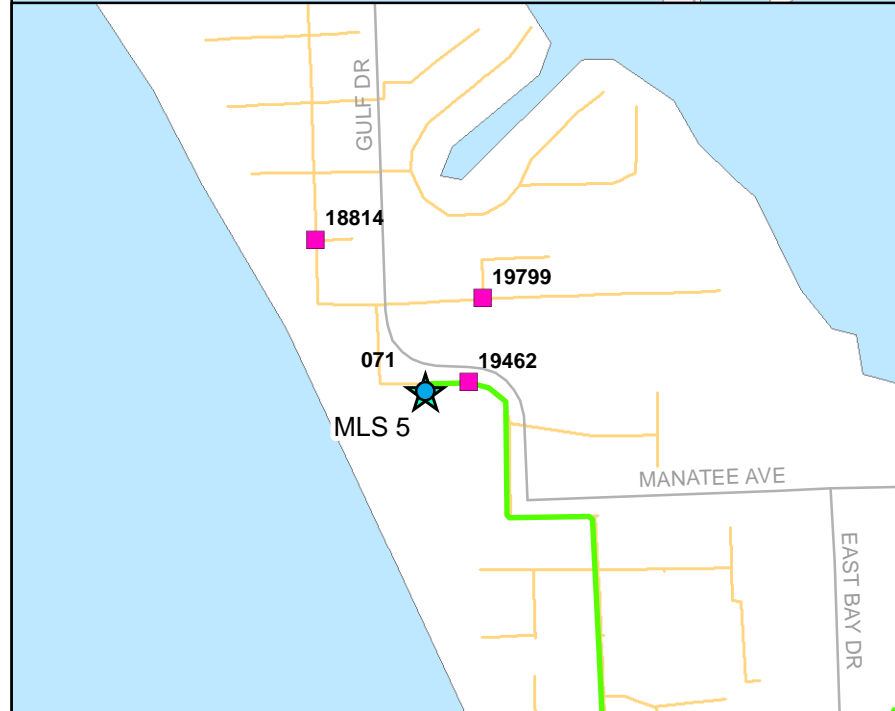
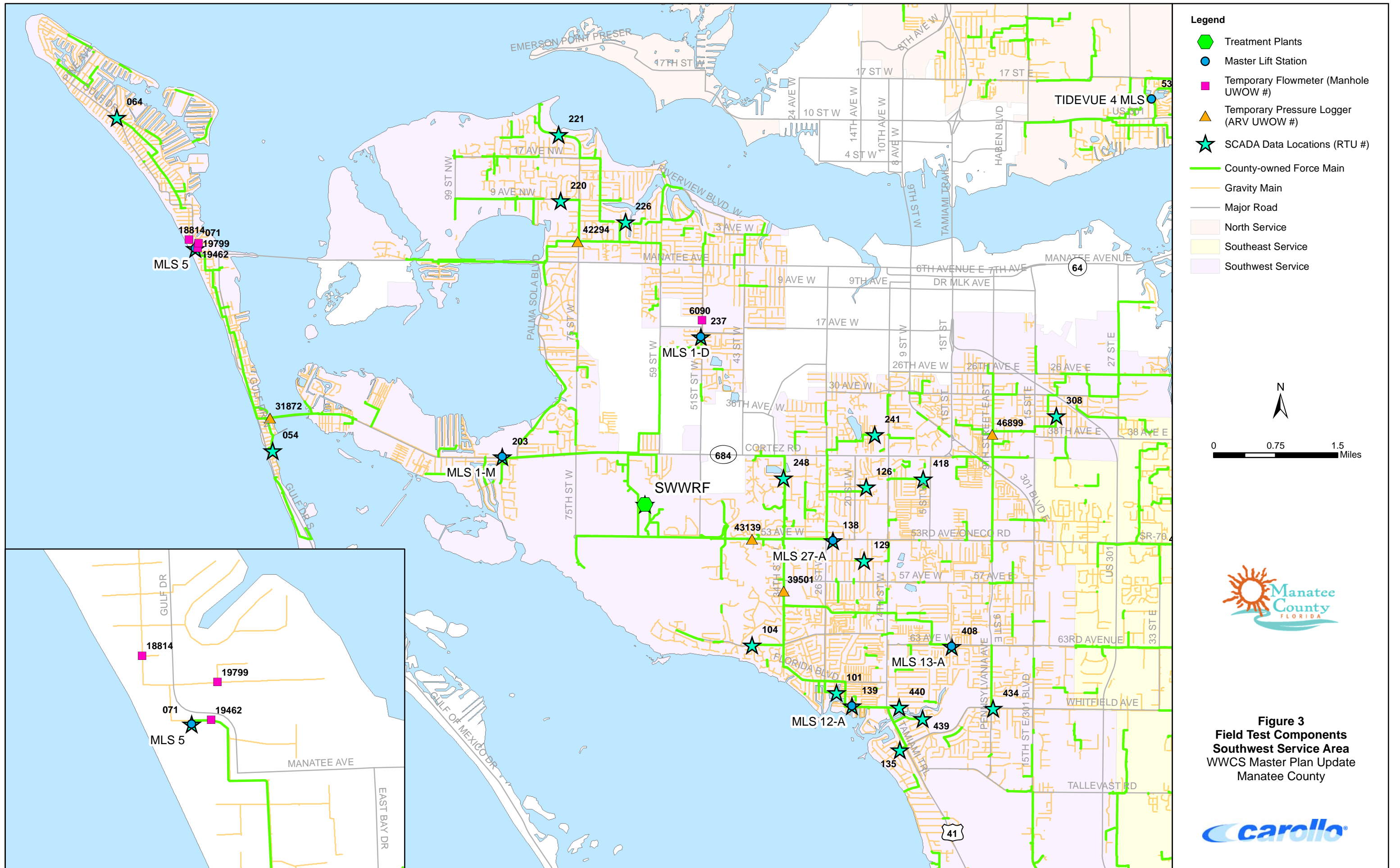

Figure 2
Field Test Components
Southeast Service Area
 WWCS Master Plan Update
 Manatee County





| Table 1 Flow Meter Locations Manatee County Government Field Test Plan | | | | |
|--|---|---------------------|-------------------------------------|-----------------------------------|
| Manhole Number | Location Description | Service Area | Flow Meter Type and Quantity | Pipe Diameter and Material |
| Week 1 (April 14-21, 2015) | | | | |
| 10287 ⁽¹⁾ | Upstream of Tidevue 4 MLS (at the intersection of Franklin Ave and 17th Street) | North | 1 Sigma ⁽²⁾ | 24" PVC |
| 9489 ⁽³⁾ | Upstream of Lift Station N1C (behind property on 39th Street Circle East) | North | 1 Sigma ⁽²⁾ | 24" PVC |
| 18814 ⁽¹⁾ | Upstream of MLS 5 (at the intersection of 2nd Avenue and 44th Street) | SW | 1 Sigma | 21" VCP |
| 19799 ⁽¹⁾ | Upstream of MLS 5 (on 43rd Street, east of Palm Harbor Boulevard) | SW | 2 Sigmas | 8" PVC & 8" VCP |
| 19462 ⁽¹⁾ | Second manhole upstream of MLS 5 (east of MLS 5) | SW | 1 Flodar | 15" VCP |
| 6090 ⁽¹⁾ | Upstream of MLS 1-D (Manhole at 51st Street W, just south of 15th Ave W). | SW | 1 Sigma ⁽²⁾ | 30" DIP |
| Week 2 (April 21-30, 2015) | | | | |
| 12318 ⁽¹⁾ | Upstream of Southeast MLS on The Masters Ave (west of the driveway to Willis Elementary School) | SE | 1 Sigma | 12" PVC |
| 12435 ⁽¹⁾ | Manhole upstream of Heritage Harbor MLS (at intersection of River Heritage Blvd and Montauk Point Xing) | SE | 2 Sigmas | 20" PVC & 15" PVC |
| 19950 | Upstream of Pope Road MLS (Pope Road and 44th Avenue East) | SE | 1 Flodar | 27" PVC |
| Notes: | | | | |
| (1) County to provide MOT at these locations. | | | | |
| (2) These flow meters will be left in place for the entire 2-week testing period. All other Week 1 flow meters will be removed at the end of Week 1 and transferred to the Week 2 locations. | | | | |
| (3) County to coordinate with homeowners for access to manhole. | | | | |

3.0 INSTALLATION OF PRESSURE LOGGERS

Pressure loggers will be temporarily placed in the field at locations shown in Table 2 (Week 1) and Table 3 (Week 2). Locations are also shown on Figures 1 through 3.

The County will be responsible for:

- Installing and removing the pressure loggers,
- Recording the pressure logger tag numbers and elevation relative to the ground for each pressure logger installed (see Tables 2 and 3),
- Documenting any operational, maintenance, or weather event that occurs during the testing period that may affect readings (See Table A-1).

Each pressure logger has a unique tag number. It is important to keep a record of which logger is used at each location. The elevation of each pressure logger (relative to the ground) must also be recorded for each location. Tables 2 and 3 may be used to keep track of the logger tag number and elevation. The County may also choose to mark the tag numbers on Figures 1 through 3.

The following considerations should be followed when installing the pressure loggers:

- Pressure loggers shall be installed on air release valve connectors, at selected locations.
- Fittings and/or adapters may be required to install the devices (fittings have a ¼" NPT thread with 5/8" Hex).
- The device shall be accessible from grade and minimal equipment should be necessary for the installation by County staff (pipe wrench, safety equipment).
- Pressure loggers shall be placed in valve boxes or in other places where flooding is not likely to occur.
- Where a pressure logger is accessible to public, a 6-in or 8-in diameter PVC pipe shall be placed surrounding the device such that it is not visible or subject to vandalism.

| Table 2 Pressure Logger Locations – Week 1 Manatee County Government Field Test Plan | | | |
|--|---|---|---|
| ARV UWOW Number | ARV Location Description | Carollo Pressure Logger Tag Number⁽¹⁾ | Pressure Logger Elevation (feet)⁽²⁾ |
| North Service Area | | | |
| N/A | N1C (RTU #546) discharge piping (Erie Road just south of Desoto Drive) | | |
| 30304 | 8-inch pipe at Fort Hamer Rd and Old Tampa Rd | | |
| 30302 (or 30523) | 16-inch pipe on US 301 at 121st Avenue East (Fort Hamer Road and Britt Road) | | |
| 119228 ⁽³⁾ | 10-inch pipe (River Wilderness FM) along Old Tampa Rd, west of Chin Rd | | |
| 33495 | 20-inch pipe on Erie Road, between Erie Lane and 55th Street East) | | |
| 36200 ⁽⁴⁾ | 12-inch pipe on US 41 between Buckeye Road and Moccasin Wallow Road | | |
| 36164 ⁽⁴⁾ | 16-inch pipe on 69th Street, east of I-75 | | |
| 30598 or 30599 | 16-inch pipe on Erie Rd, west of Sawgrass Rd | | |
| Southwest Service Area | | | |
| 31872 | SR 684 at the west end of the bridge | | |
| 42294 ⁽⁴⁾ | 8-inch pipe on 1st Avenue West, just west of 75th Street West | | |
| 43139 ⁽⁴⁾ | 42-inch pipe on 53rd Ave West, between 42nd Street West and 36th Street West | | |
| 39501 | 30-inch pipe on 34th Street West, north of 59th Avenue West | | |
| 46899 ⁽⁴⁾ | 16-inch pipe on 9th St E, at 37th Ave Dr | | |
| Notes: | | | |
| (1) Each pressure logger has a unique tag number. It is important to keep a record of which pressure logger is used at each location. This column is to be filled out by the County to document the pressure logger tag numbers used at each location. This table should be completed and returned to Carollo once pressure loggers are installed. | | | |
| (2) At the time of installation, the County shall record the elevation of the ARV in relation to the ground (height above ground level). | | | |
| (3) This ARV is not shown in GIS. ARV location verified by County staff. | | | |
| (4) This ARV located in a manhole. | | | |

| Table 3 Pressure Logger Locations – Week 2 Manatee County Government Field Test Plan | | | |
|--|--|---|---|
| ARV UWOW Number | ARV Location Description | Carollo Pressure Logger Tag Number⁽¹⁾ | Pressure Logger Elevation (feet)⁽²⁾ |
| Southeast Service Area | | | |
| 30266 | 16-inch pipe at Lana Road and Gillis Road (just south of SR 64) | | |
| 30246 | 16-inch pipe at Lana Road and Gillis Road (just south of SR 64) | | |
| 44811 | 12-inch PVC on SR 64, just east of Upper Manatee River Road | | |
| 35382 (or 35381) | 12-inch pipe on SR 64 between Pope Road and Rye Road East | | |
| 74342 | 20-inch pipe (FM 39A) on Caruso Road at 45th Avenue Drive East | | |
| 44439 | 16-inch piping on Lakewood Ranch Boulevard just south of Malachite Drive | | |
| 30405 | 12-inch piping on Lakewood Ranch Boulevard at Malachite Drive | | |
| 52000 | 16-inch pipe on Lockwood Ridge Rd just south of 63rd Ave East (FM 41A in median) | | |
| 30293 | 10-inch pipe at Lockwood Ridge Rd and Sandner Dr (just north of Tallevast Road) | | |
| 71360 | 10-inch pipe west of Honore Ave, north of Glen Eagles Xing (in FPL right of way) | | |
| 44428 | 12-inch pipe on Lakewood Ranch Blvd just south of The Masters Avenue | | |
| 30335 (or 30336) | 24-inch pipe on SR 70, west of Lorraine Road | | |
| 30341 | 16-inch pipe on Lorraine Road at 70th Terrace East | | |
| Notes: | | | |
| (1) Each pressure logger has a unique tag number. It is important to keep a record of which pressure logger is used at each location. This column is to be filled out by the County to document the pressure logger tag numbers used at each location. This table should be completed and returned to Carollo once pressure loggers are installed. | | | |
| (2) At the time of installation, the County shall record the elevation of the ARV in relation to the ground (height above ground level). | | | |

4.0 SCADA DATA

Tables 4 through 6 outline the lift stations in each service area where SCADA data will be required. SCADA data will be required for the following dates:

- North and Southwest Service Areas: April 14 - April 21, 2015
- Southeast Service Area: April 21 - April 30, 2015
- Locations where temporary flow meters will be in place for the entire 2-week testing period shall have derived flow SCADA data collected for the entire 2-week testing period (April 14, 2015 through April 30, 2015). These locations include:
 - Tidevue 4 MLS
 - N1C
 - MLS 1-D

Carollo will notify the County of any changes to the field testing schedule.

| Table 4 SCADA Data Requirements – North Service Area Manatee County Government Field Test Plan | | | | | | |
|--|-------------------|------------------|-----------------------------------|---------------------|-----------------|-----------------------|
| Location Name | RTU Number | Pressure | Derived Flow⁽¹⁾ | Metered Flow | Rainfall | Wet Well Level |
| North WRF | - | | | ✓ | ✓ | |
| Tidevue 4 Master | 533 | ✓ ⁽²⁾ | ✓ ⁽³⁾ | | ✓ | ✓ |
| N1B Master | 549 | ✓ | | ✓ | ✓ | ✓ |
| Artesan Lakes Master | 838 | | ✓ | | ✓ | ✓ |
| Colony Cove 6 | 522 | | ✓ | | | ✓ |
| River Wilderness 4 | 532 | | ✓ | | | ✓ |
| Memphis Road | 534 | | ✓ | | | ✓ |
| N1C | 546 | | ✓ ⁽³⁾ | | | ✓ |
| Port Manatee 3 (N1-G) | 563 | | ✓ | | | ✓ |
| Fairway Imperial | 583 | | ✓ | | | ✓ |
| Twin Rivers 1 | 595 | | ✓ | | | ✓ |
| Notes: | | | | | | |
| (1) Each location shall have “high speed” data recorded for one day during the SCADA data collection period. The “high speed” data can be collected on any day as long as it is collected within the field testing period for this service area. | | | | | | |
| (2) A pressure sensor is scheduled to be installed. Provide SCADA data if available at time of field testing. | | | | | | |
| (3) County shall provide derived flow for the entire 2-week testing period (April 14 through April 30). | | | | | | |

| Table 5 SCADA Data Requirements – Southwest Service Area Manatee County Government Field Test Plan | | | | | | |
|--|-----------------------|------------------|---------------------------------------|-------------------------|-----------------|---------------------------|
| Location Name | RTU Number | Pressure | Derived Flow⁽¹⁾ | Metered Flow | Rainfall | Wet Well Level |
| Southwest WRF | - | | | ✓ | ✓ | |
| #5 Master | 071 | ✓ | ✓ | | ✓ | ✓ |
| 27-A Master | 138 | ✓ | ✓ | | ✓ | ✓ |
| 12-A Master | 139 | ✓ | ✓ | | ✓ | ✓ |
| 1-M Master | 203 | ✓ | | ✓ | ✓ | ✓ |
| 1-D Master | 237 | ✓ | ✓ ⁽³⁾ | | ✓ | ✓ |
| 13-A Master | 408 | ✓ ⁽²⁾ | | ✓ | ✓ | ✓ |
| #1 | 054 | | ✓ | | | ✓ |
| #11 | 064 | | ✓ | | | ✓ |
| Bayshore Yacht Basin | 101 | | ✓ | | | ✓ |
| El Conquistador 1 | 104 | | ✓ | | | ✓ |
| 31-A | 126 | | ✓ | | | ✓ |
| 29-A | 129 | | ✓ | | | ✓ |
| 1-A | 135 | | ✓ | | | ✓ |
| 10-D | 220 | | ✓ | | | ✓ |
| 12-D | 221 | | ✓ | | | ✓ |
| 9-D | 226 | | ✓ | | | ✓ |
| 36-A | 241 | | ✓ | | | ✓ |
| 30-AA | 248 | | ✓ | | | ✓ |
| Samoset 1 | 308 | | ✓ | | | ✓ |
| 26-A | 418 | | ✓ | | | ✓ |
| 14-A | 434 | | ✓ | | | ✓ |
| 2-A | 439 | | ✓ | | | ✓ |
| 16-A | 440 | | ✓ | | | ✓ |
| Notes: | | | | | | |
| (1) Each location shall have “high speed” data recorded for one day during the SCADA data collection period. The “high speed” data can be collected on any day as long as it is collected within the field testing period for this service area. | | | | | | |
| (2) A pressure sensor is scheduled to be installed. Provide SCADA data if available at time of field testing. | | | | | | |
| (3) County shall provide derived flow for the entire 2-week testing period (April 14 through April 29). | | | | | | |

| Table 6 SCADA Data Requirements – Southeast Service Area Manatee County Government Field Test Plan | | | | | | |
|--|-----------------------|------------------|---------------------------------------|-------------------------|-----------------|-------------------------------|
| Location Name | RTU Number | Pressure | Derived Flow⁽¹⁾ | Metered Flow | Rainfall | Wet Well Level |
| Southeast WRF | - | | | ✓ ⁽²⁾ | ✓ | |
| Tara 20 Master | 323 | ✓ | ✓ | | ✓ | ✓ |
| Lakewood Ranch Master | 362 | ✓ | ✓ | | ✓ | ✓ |
| 39-A Master | 428 | ✓ | | ✓ | ✓ | ✓ |
| Heritage Harbour Master | 640 | ✓ | ✓ | | ✓ | ✓ |
| 428 Booster Station | 666 | ✓ | | | ✓ | ✓ |
| Southeast Master Lift Station | 677 | ✓ ⁽³⁾ | ✓ | | ✓ | ✓ |
| Pope Road Master | 683 | ✓ | ✓ | | ✓ | ✓ |
| Manatee Palms 1 | 313 | | ✓ | | | ✓ |
| Braden Woods (#18) | 326 | | ✓ | | | ✓ |
| Rosedale 1 | 327 | | ✓ | | | ✓ |
| Missionary Village | 329 | | ✓ | | | ✓ |
| Upper Manatee River Rd. | 330 | | ✓ | | | ✓ |
| Mill Creek 1 | 350 | | ✓ | | | ✓ |
| Rye Road School | 355 | | ✓ | | | ✓ |
| Lakewood Town Center 1 | 379 | | ✓ | | | ✓ |
| State Road 70 | 381 | | ✓ | | | ✓ |
| 40-A | 429 | | ✓ | | | ✓ |
| Palm Aire 3 | 443 | | ✓ | | | ✓ |
| 41-A | 454 | | ✓ | | | ✓ |
| Sabal Cove | 470 | | ✓ | | | ✓ |
| Garden Lakes | 475 | | ✓ | | | ✓ |
| Tara 2 | 497 | | ✓ | | | ✓ |
| Lakewood Ranch Riverwalk | 602 | | ✓ | | | ✓ |
| Lakewood Ranch Re- Pump | 603 | | ✓ | | | ✓ |
| Greyhawk Landings 1 | 618 | | ✓ | | | ✓ |
| Mill Creek 6 | 642 | | ✓ | | | ✓ |
| Braden River High School | 649 | | ✓ | | | ✓ |
| Legacy 10 | 660 | | ✓ | | | ✓ |
| Notes: | | | | | | |
| (1) Each location shall have “high speed” data recorded for one day during the SCADA data collection period. The “high speed” data can be collected on any day as long as it is collected within the field testing period for this service area. | | | | | | |
| (2) SCADA data is required for both 30-inch influent force mains. | | | | | | |
| (3) A pressure sensor is scheduled to be installed. Provide SCADA data if available at time of field testing. | | | | | | |

APPENDIX G – CALIBRATION RESULTS

- **Base Calibration Scenario**
- **Wet Weather Calibration Scenario**

APPENDIX G – BASE CALIBRATION SCENARIO

Base Calibration Scenario

Hourly Flow Calibration:

**vs. SWWRF Influent SCADA Flow
vs. SWWRF Influent Simulated Flow**

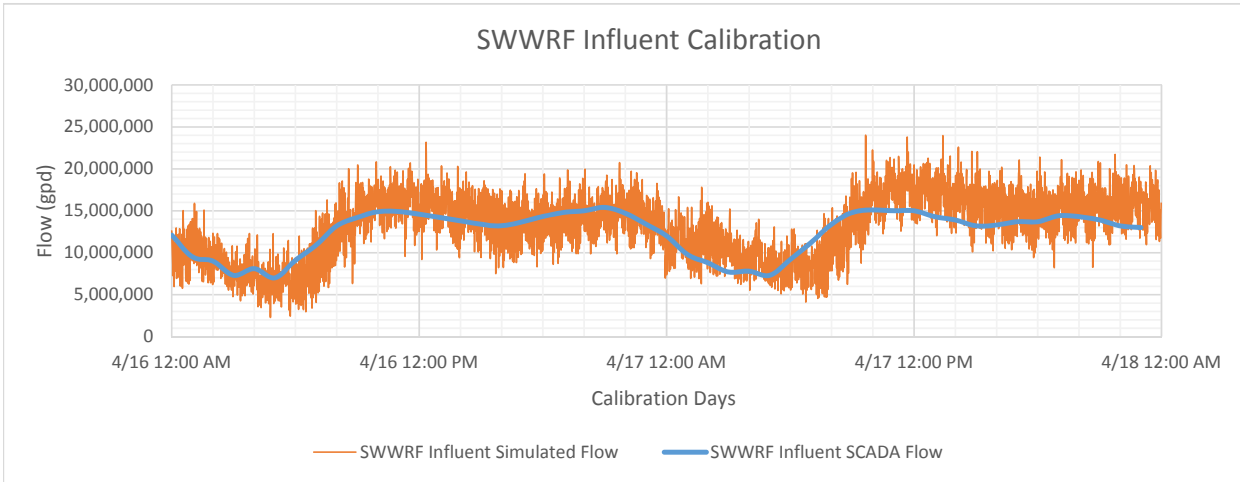

**vs. SWSA Collection Only (SWWRF SCADA Data minus LBK Meter Data)
vs. Simulated Flow from SWSA Collection Only (East Branch plus West Branch)**

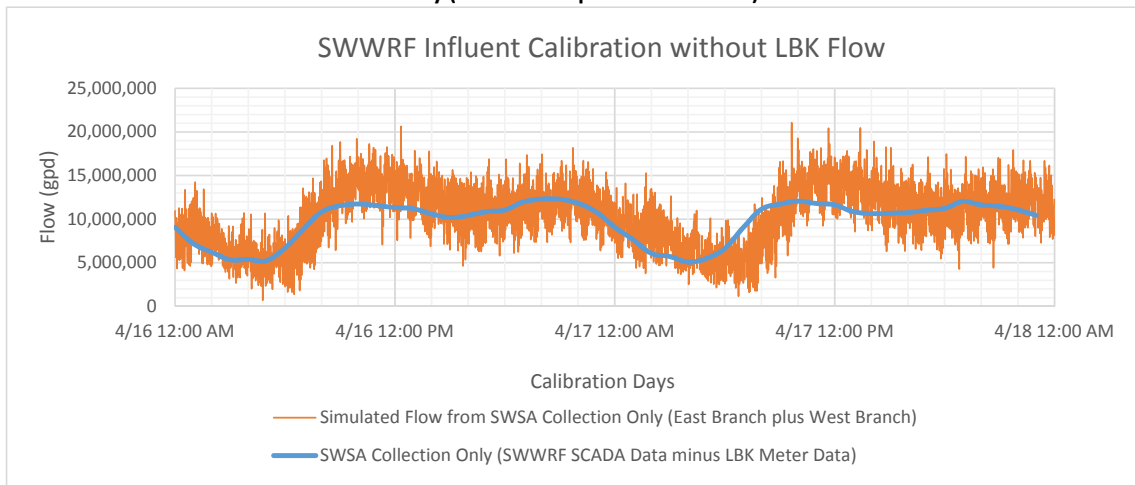

**vs. MLS #5 Total Metered Gravity Flow
vs. MLS #5 Total Simulated Gravity Flow**

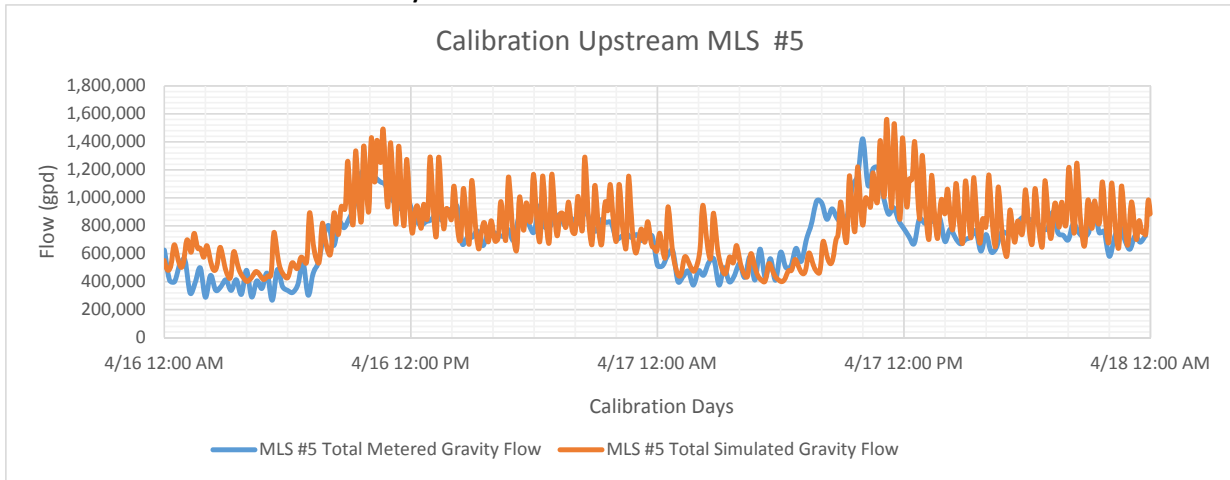

MLS #5 SCADA Flow
vs.
MLS #5 Simulated Flow

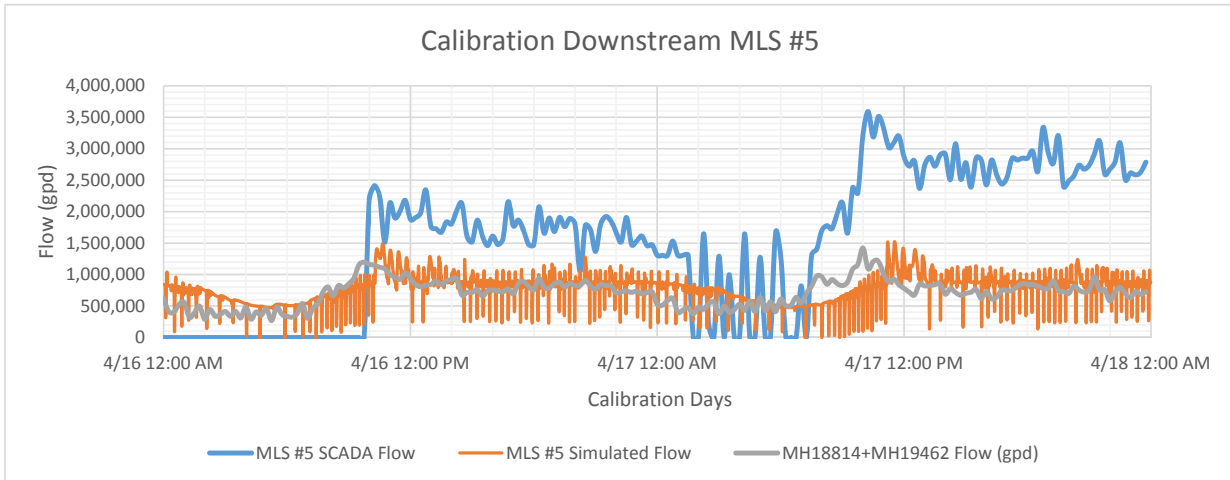

1M Flow from SCADA Pressure-Pump Speed
vs.
1M Simulated Flow

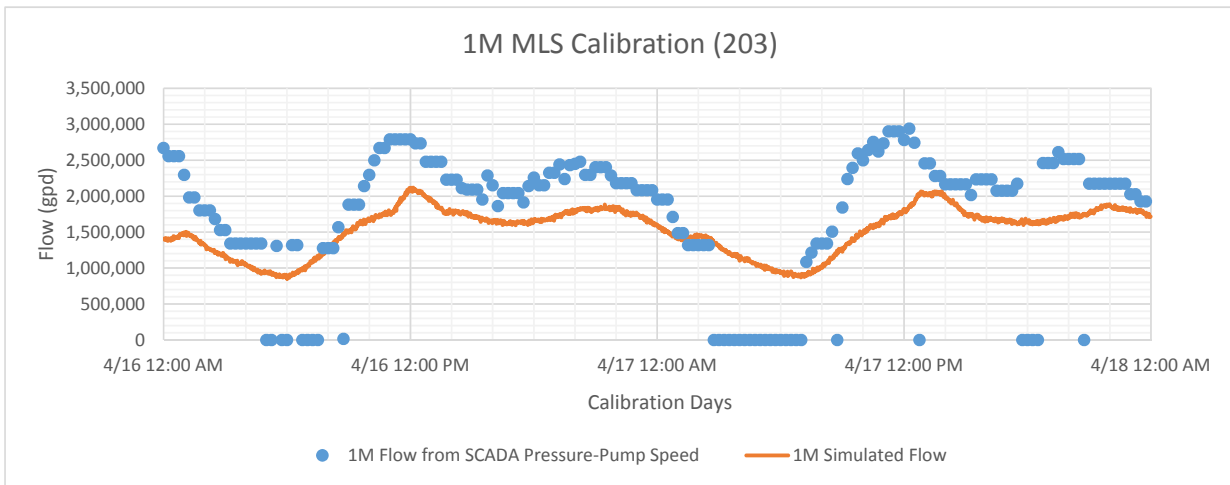

1D Metered Gravity Inflow
vs.
1D Simulated Gravity Inflow

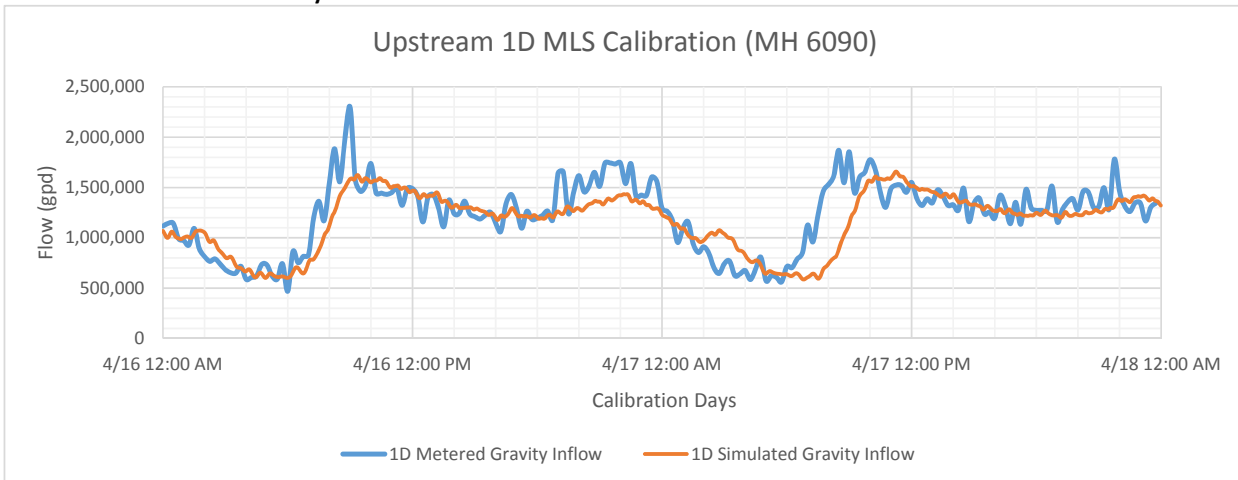

27-A Flow from SCADA Pressure-Pump Speed
vs.
27-A Simulated Flow

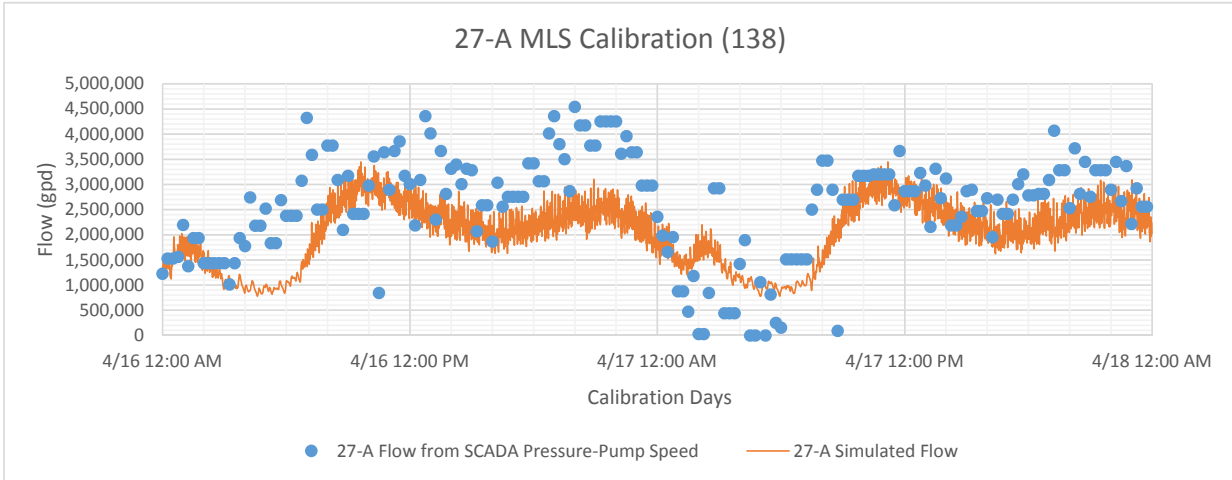

12-A Flow from SCADA Pressure-Pump Speed
vs.
12-A Simulated Flow

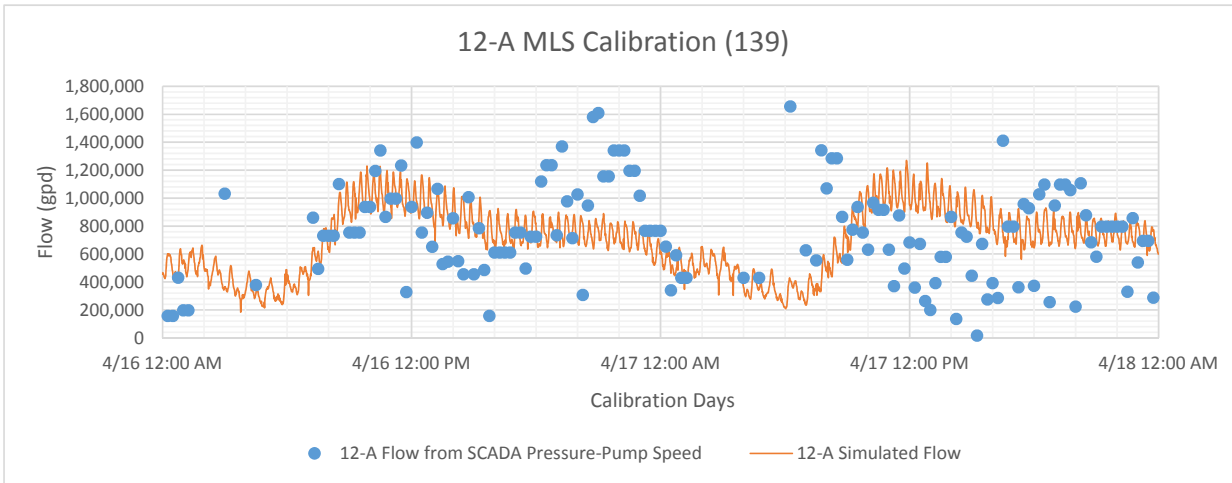

13-A 24-h Average Flow from SCADA Pressure-Pump Speed
vs.
13-A Flow from SCADA Pressure-Pump Speed
vs.
13-A Simulated Flow

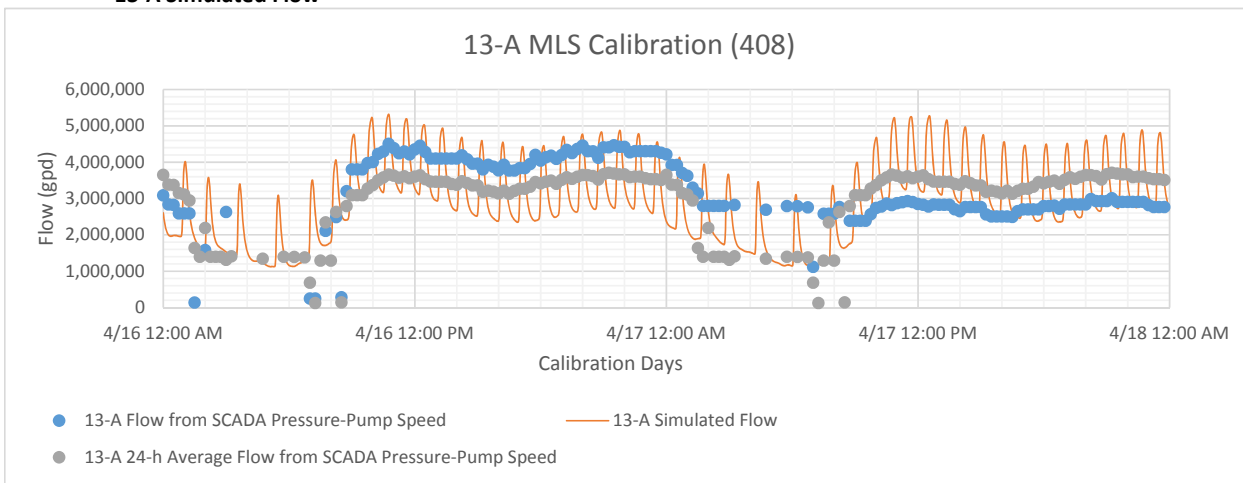

Daily & Derived Flow Calibration:

vs.
SWWRF Influent SCADA Flow
SWWRF Influent Simulated Flow

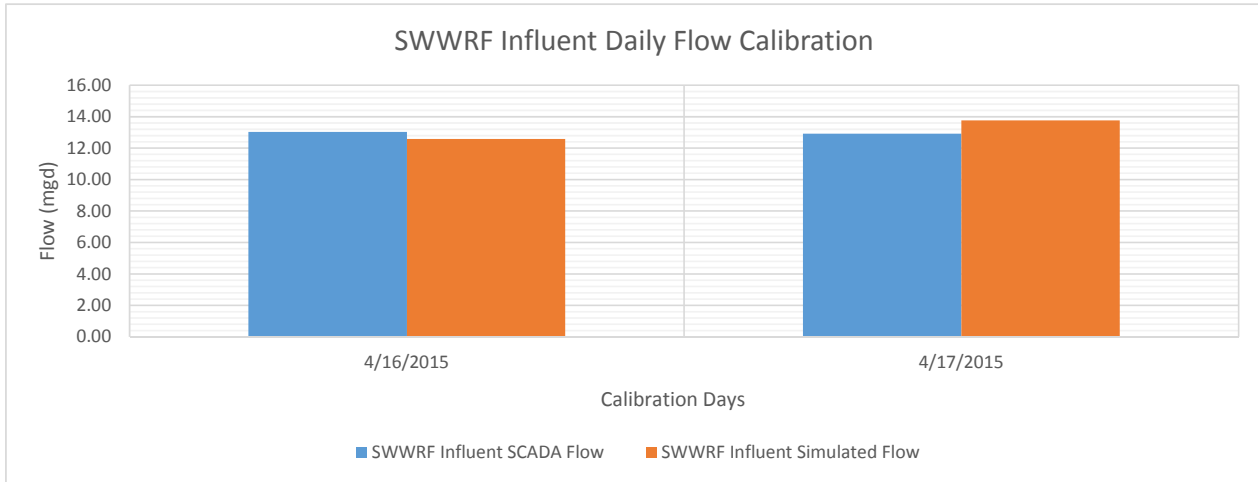

MLS 1-M Basin:

vs.
1M Flow from SCADA Pressure-Pump Speed
1M Simulated Flow

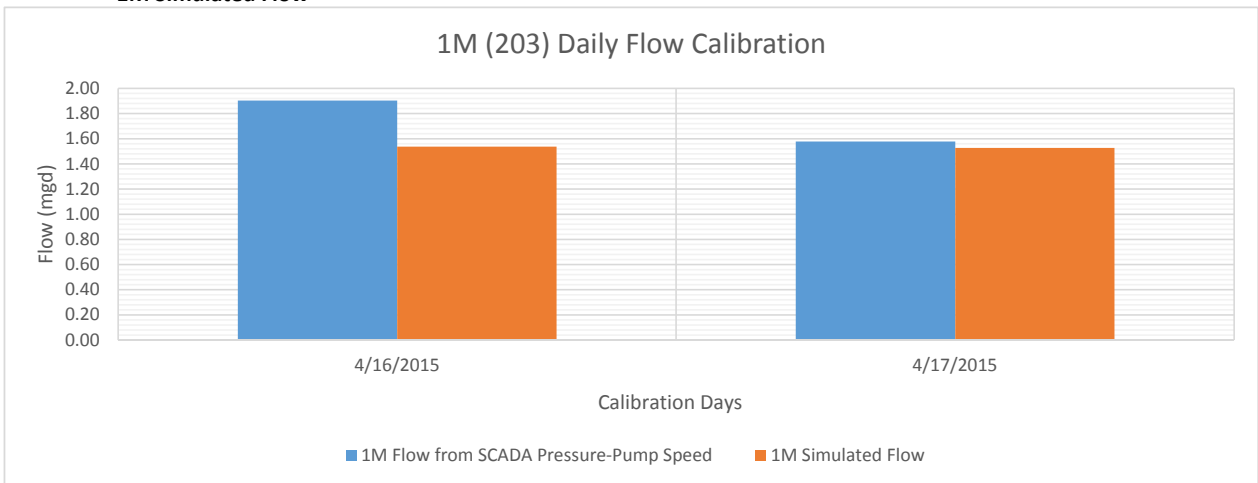

vs.
MLS #5 Total Metered Gravity Flow
MLS #5 Total Simulated Gravity Flow

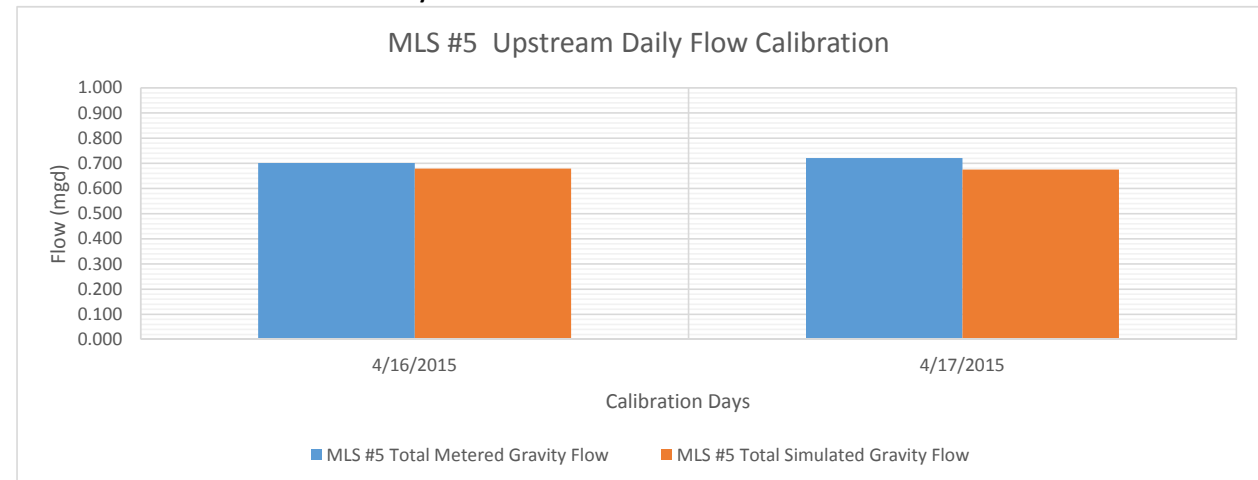

#11 BEACH 064 SW Derived Flow
vs.
#11 BEACH 064 SW Simulated Flow

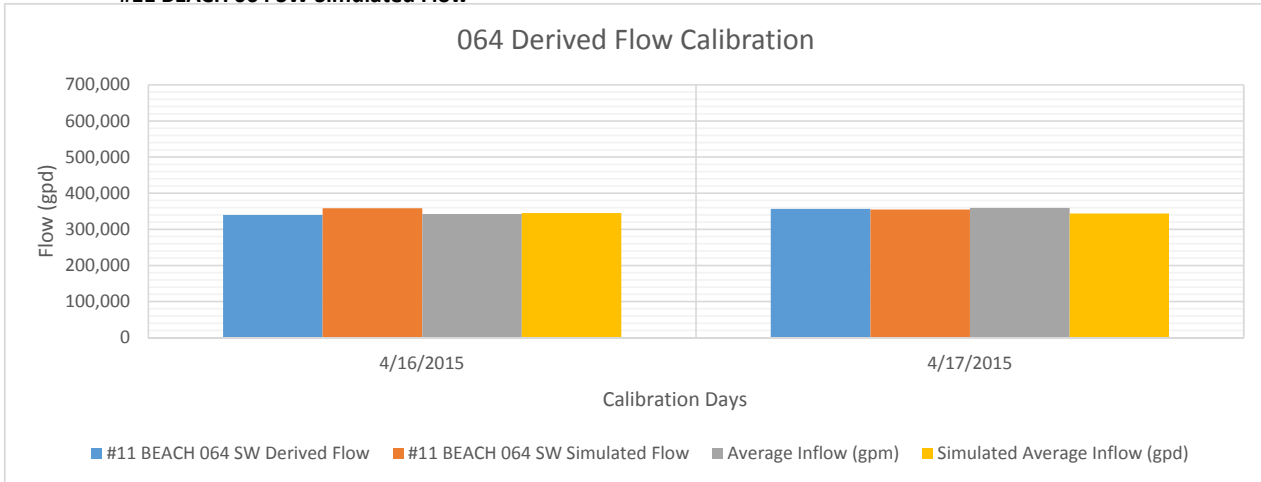

#1 54SW Derived Flow
vs.
#1 54SW Simulated Flow

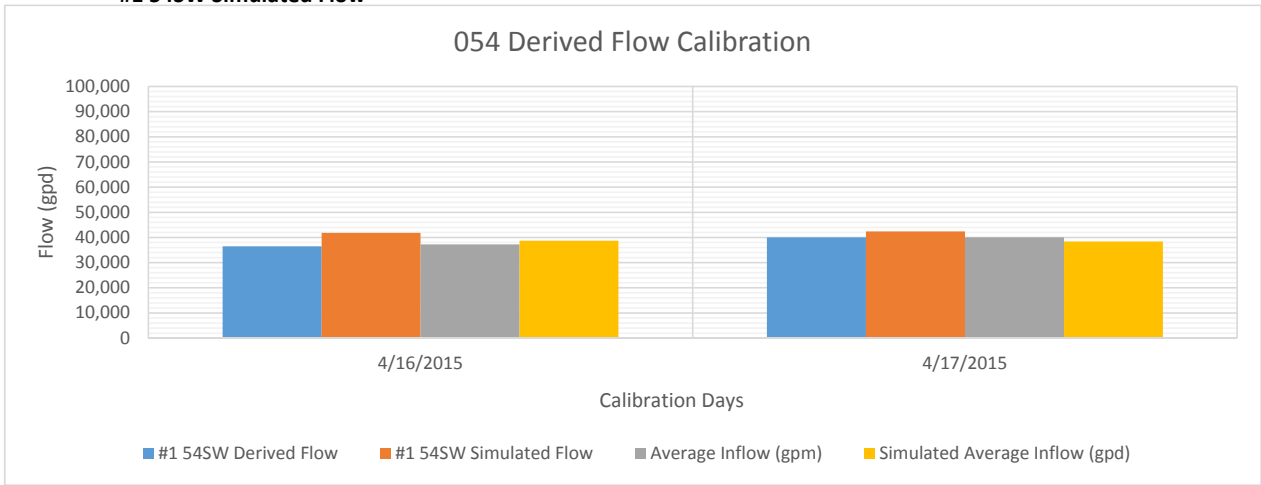

MLS1-D Basin:

vs. **1D Flow from SCADA Pressure-Pump Speed**
1D Simulated Outflow
Metered Flow at Upstream MH 6090

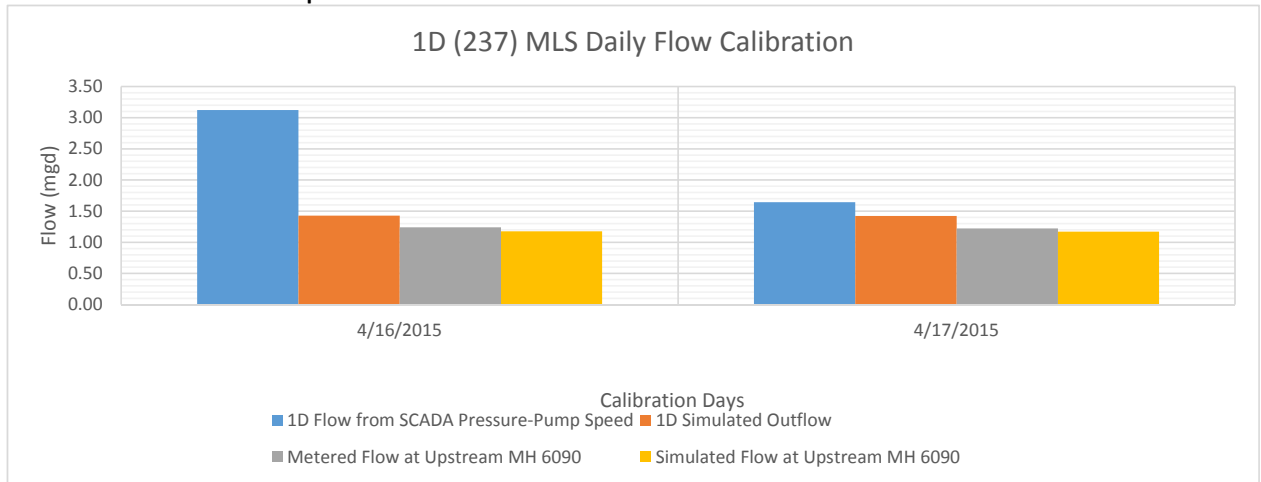

vs. **10D 220SW Derived Flow**
10D 220SW Simulated Flow

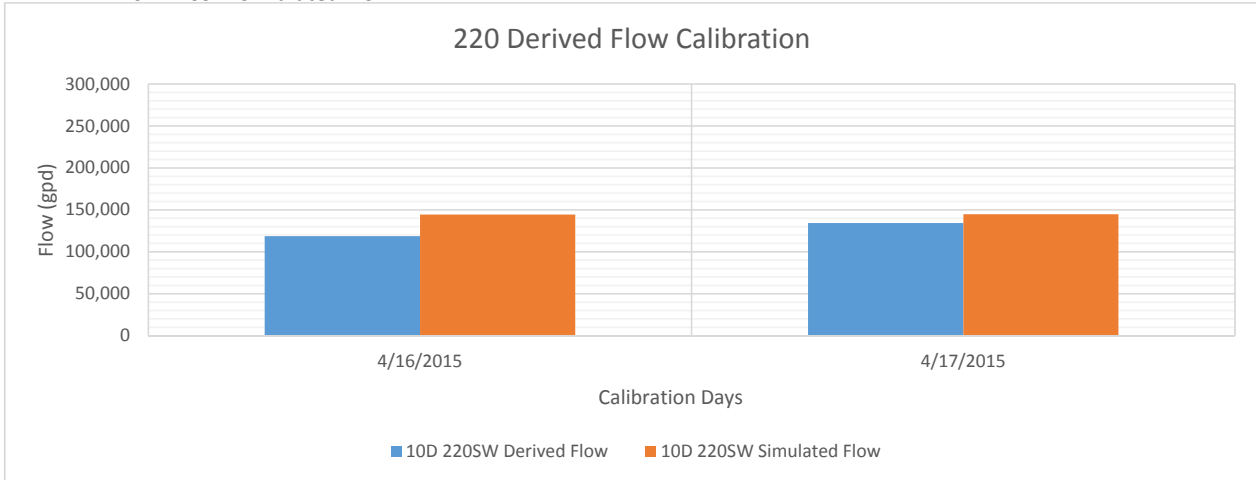

vs. **12D 221SW Derived Flow**
12D 221SW Simulated Flow

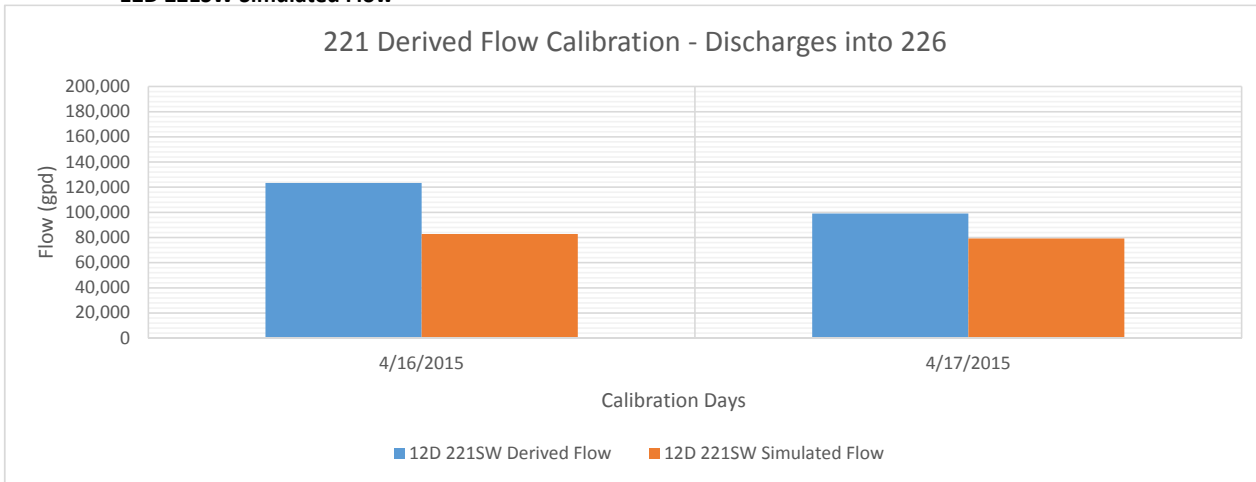

vs. **9D 226SW Derived Flow**
9D 226SW Simulated Flow

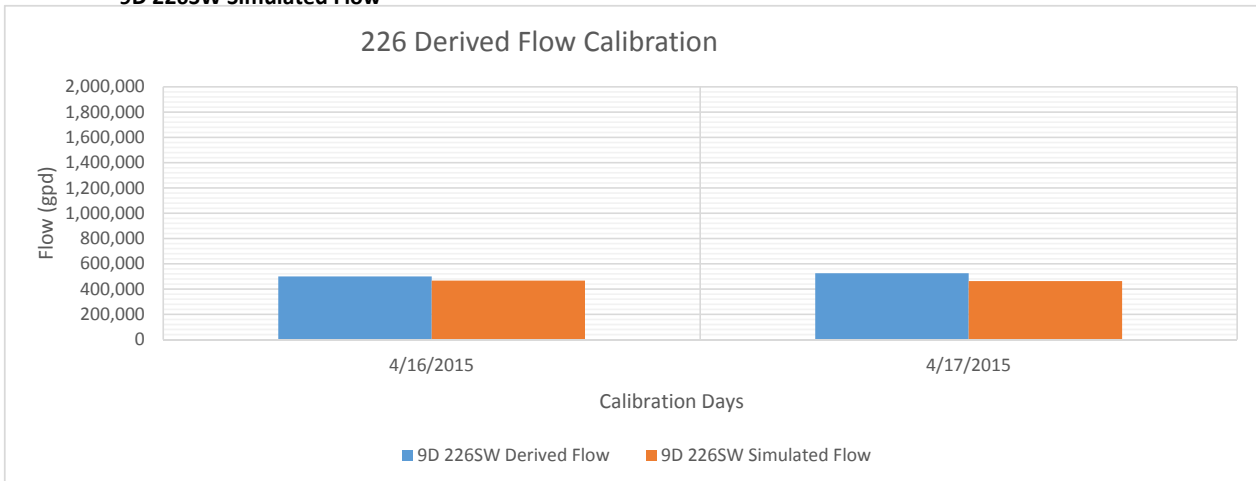

MLS 12-A Basin:

**vs. 12-A Flow from SCADA Pressure-Pump Speed
12-A Simulated Flow**

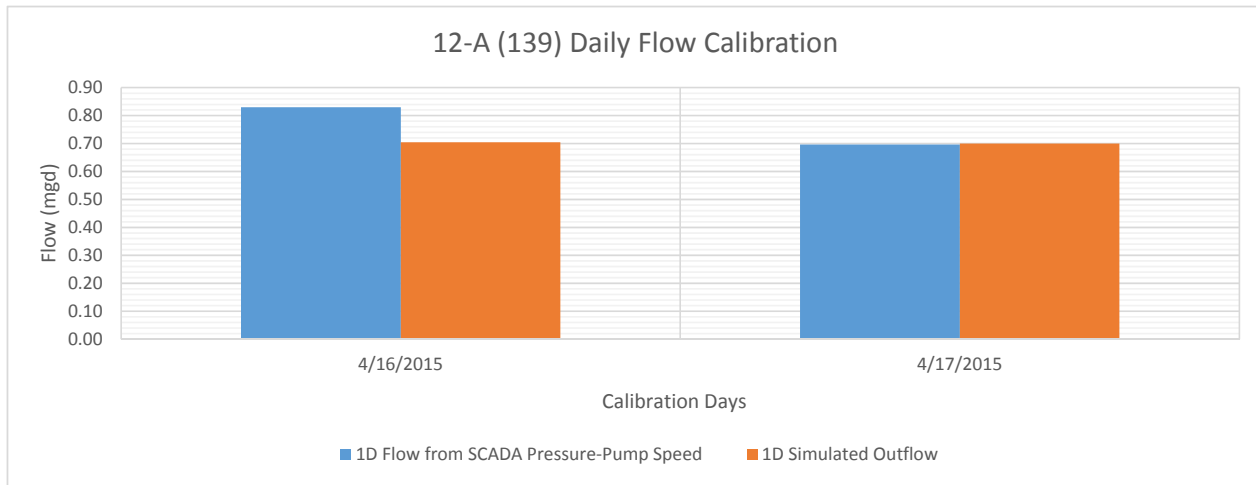

**vs. 16A 440 SC Derived Flow
16A 440 SC Simulated Flow**

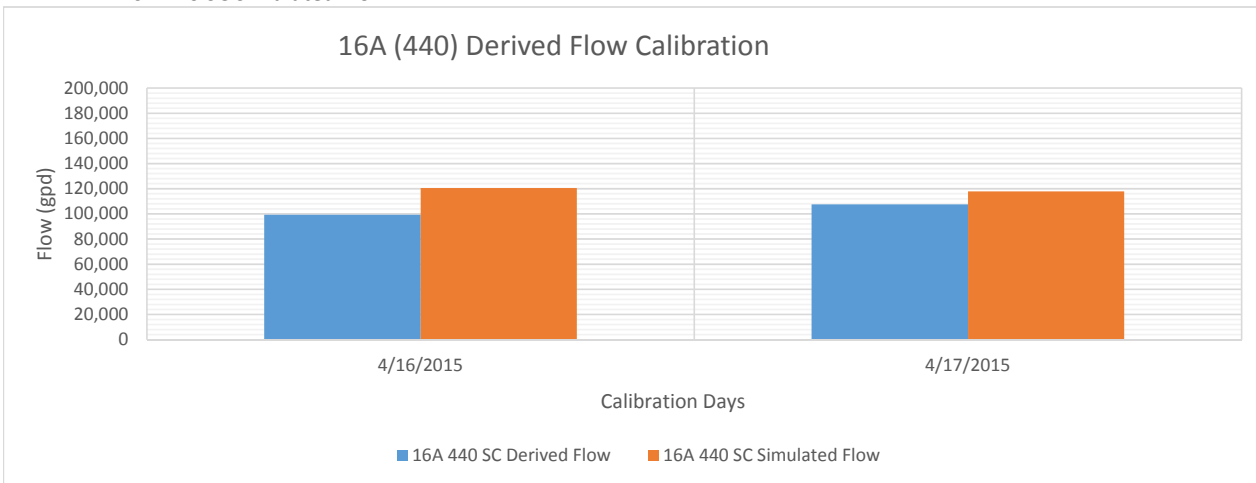

**vs. 2A 439SC Derived Flow
2A 439SC Simulated Flow**

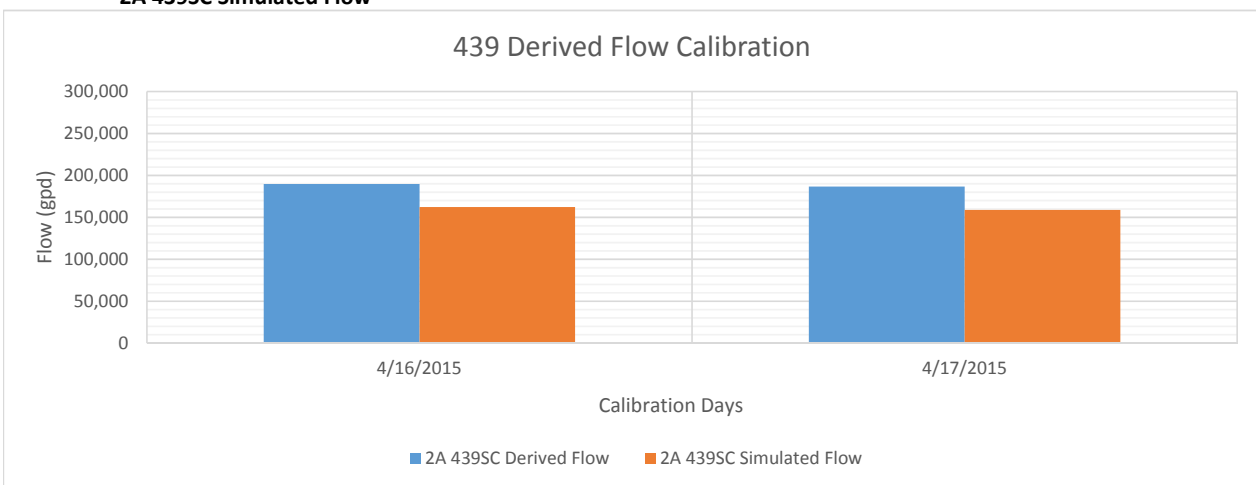

1A 135SC Derived Flow
vs.
1A 135SC Simulated Flow

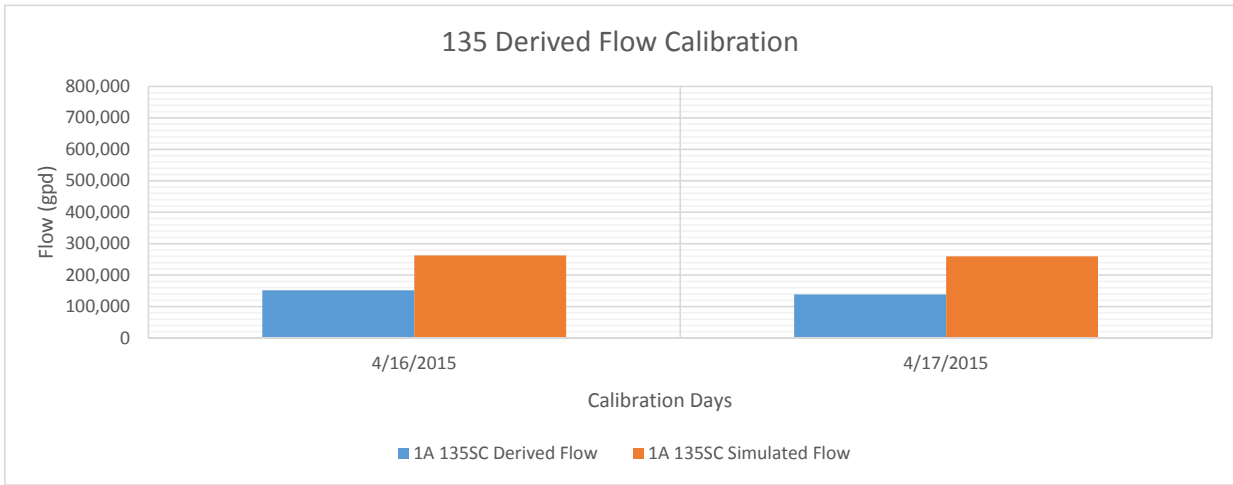

MLS 27-A Basin:

vs.
27-A Flow from SCADA Pressure-Pump Speed
27-A Simulated Flow

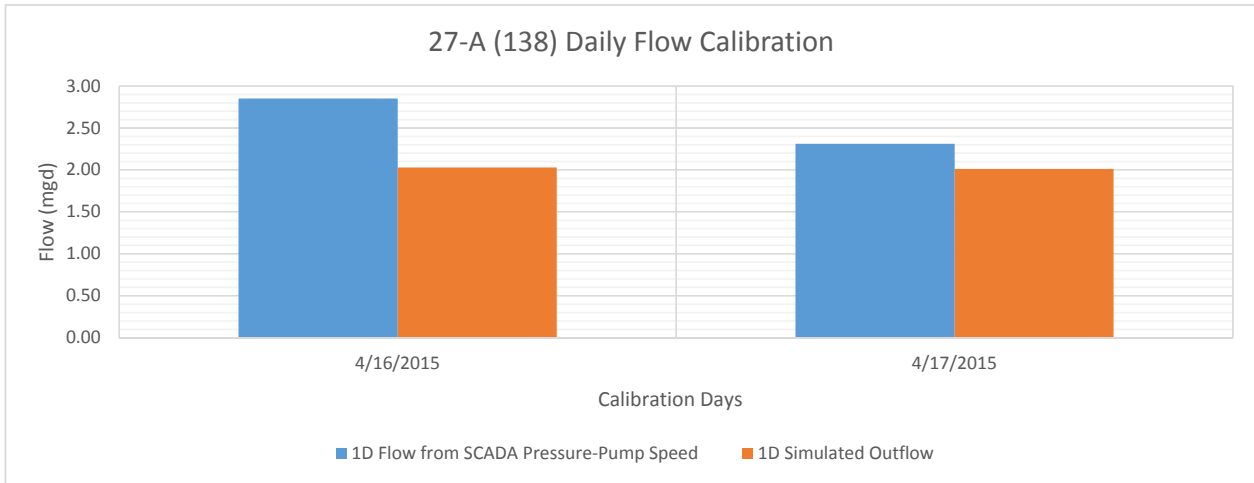

31A 126SC Derived Flow
vs.
31A 126SC Simulated Flow

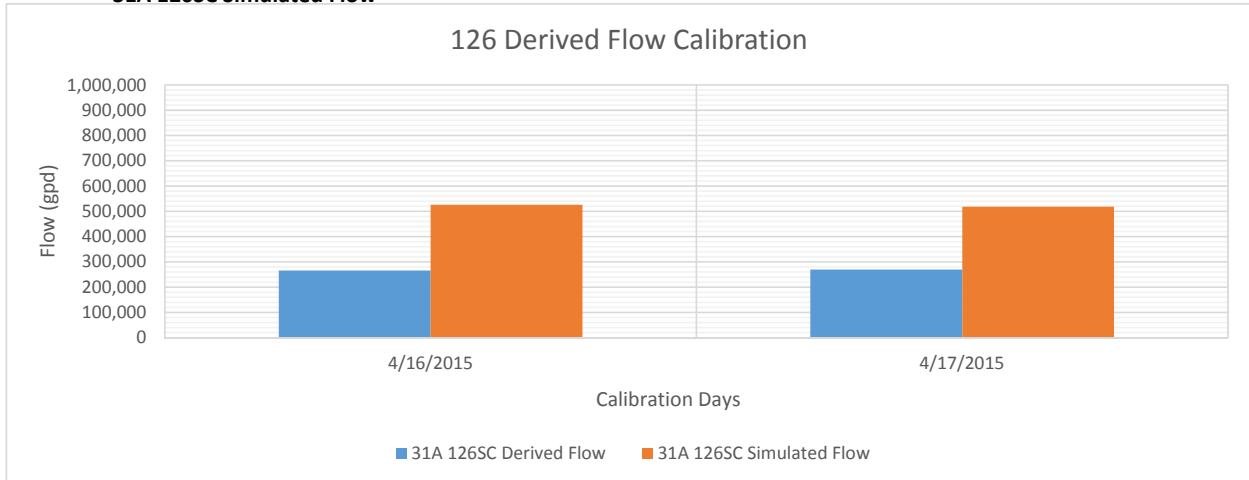

26A 418SC Derived Flow
vs.
26A 418SC Simulated Flow

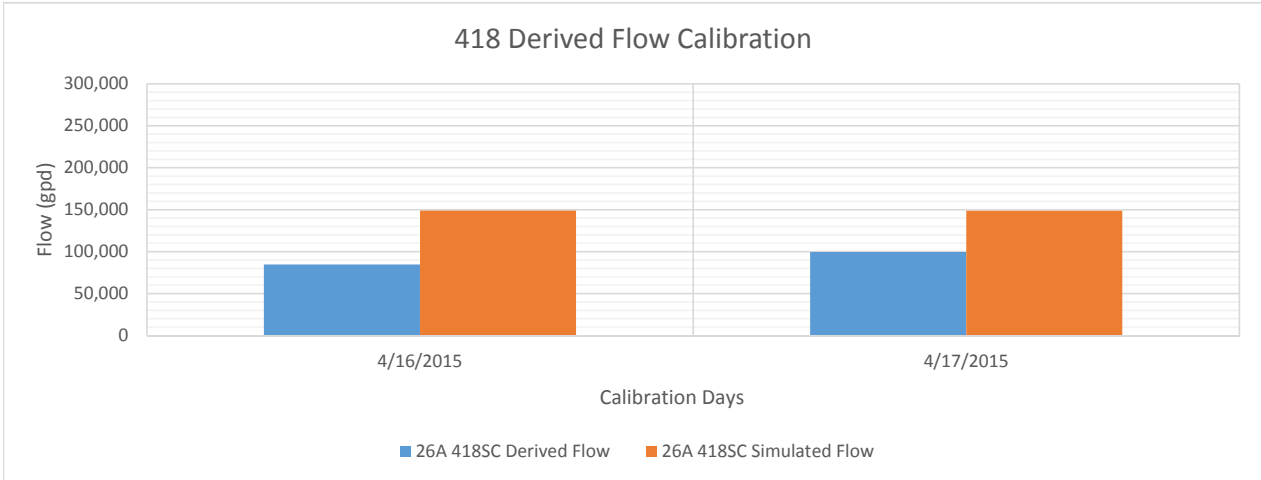

29A 129SC Derived Flow
vs.
29A 129SC Simulated Flow

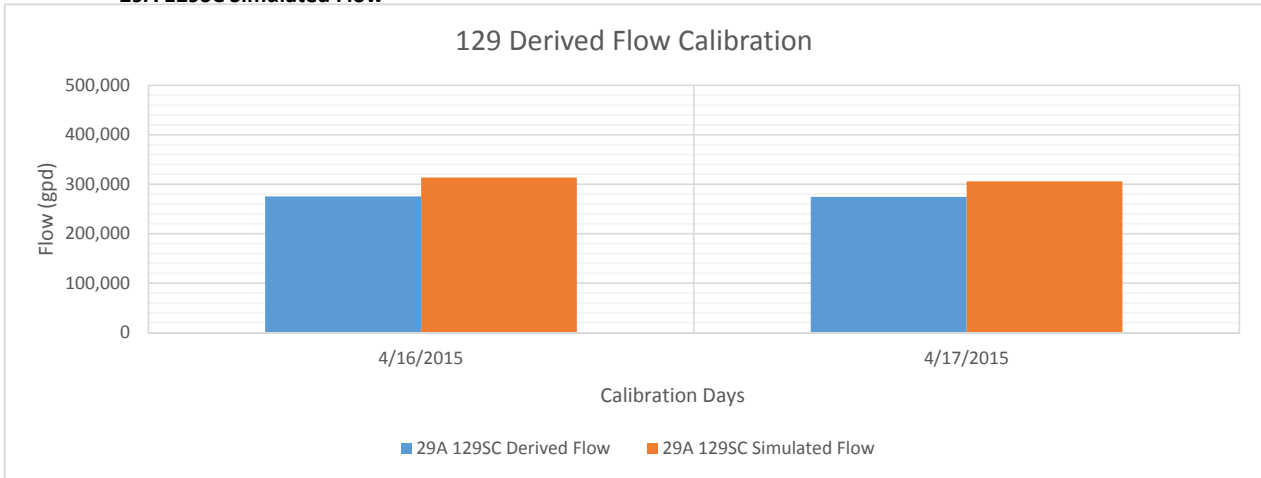

30AA 248SC Derived Flow
vs.
30AA 248SC Simulated Flow

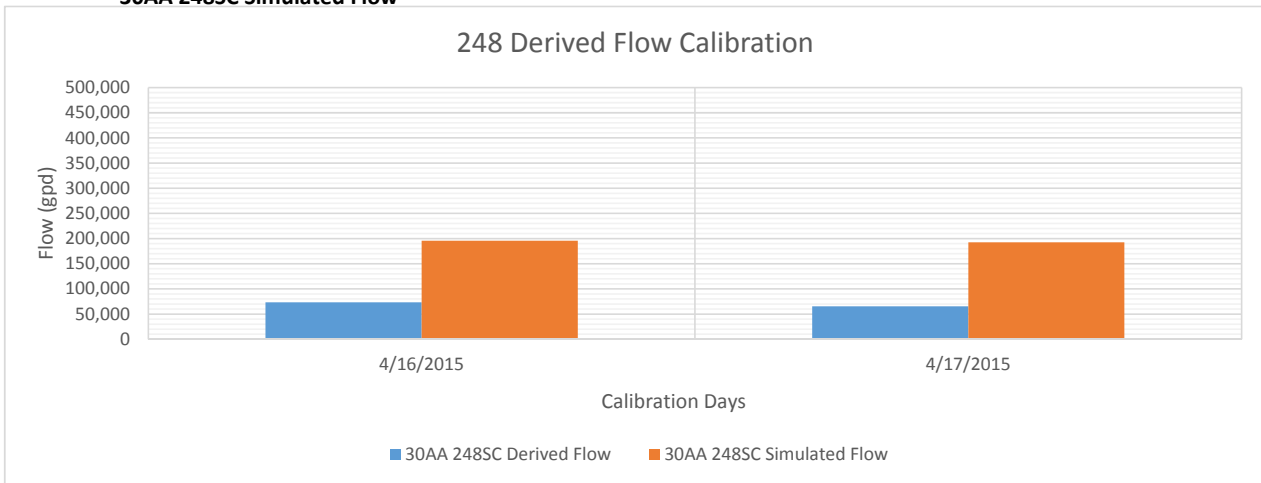

36A 241SC Derived Flow
vs.
36A 241SC Simulated Flow

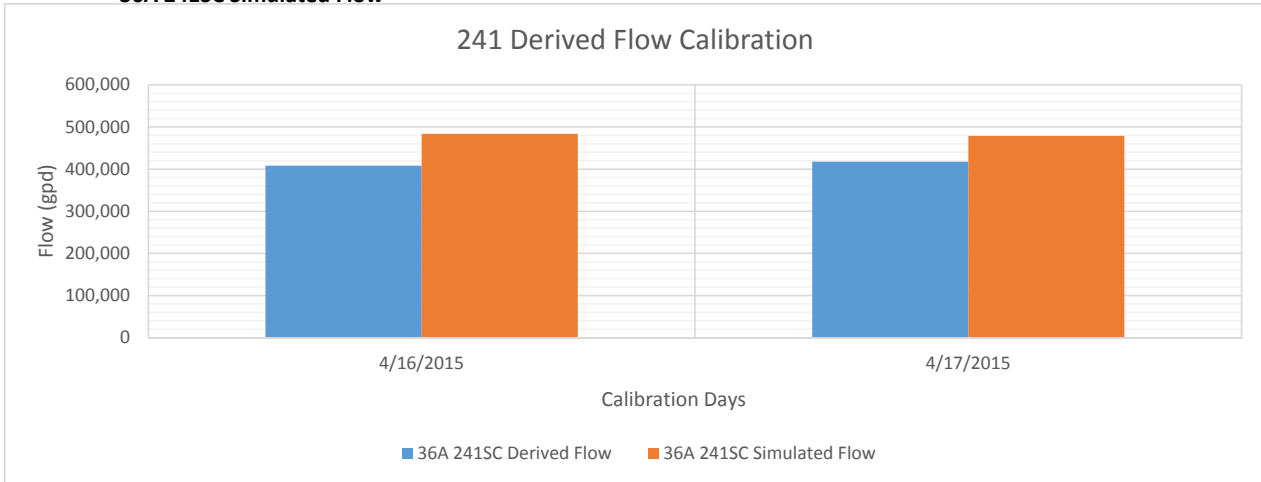

**Simulated flow for all lift stations with derived flow data within the 27-A basin are higher than the derived flow, while the simulated flow for 27-A is lower than derived flow. Since 27-A flow data is based on pump pressure and speed, it was deemed less reliable than the SCADA derived flow from the larger lift stations within the 27-A basin.

MLS 13-A Basin:

13-A Flow from SCADA Pressure-Pump Speed
13-A Flow from SCADA Pressure-Pump Speed
vs.
13-A Simulated Flow

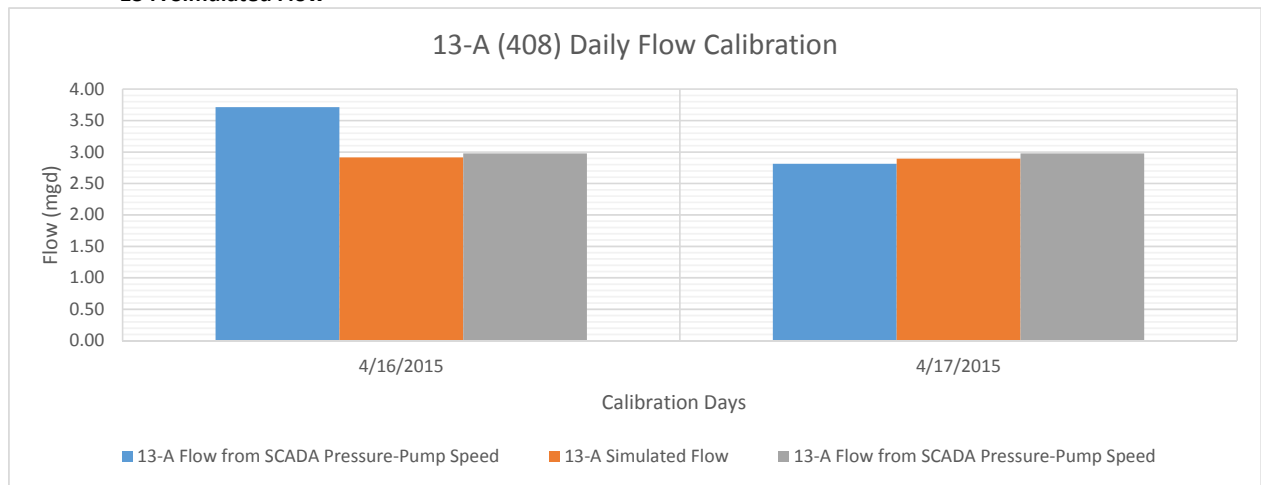

14A 434SE Derived Flow
vs.
14A 434SE Simulated Flow

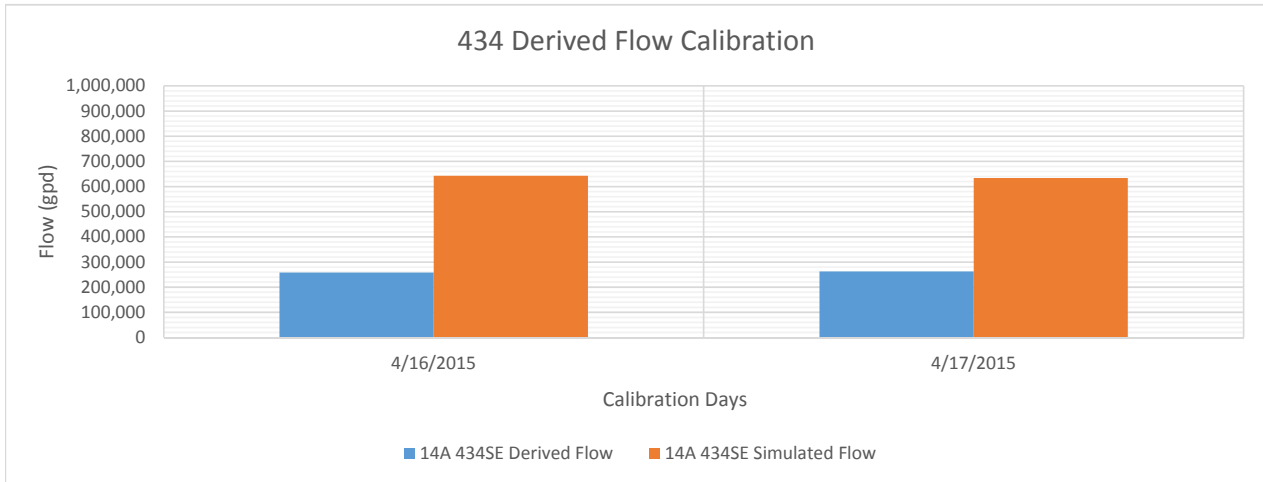

SAMOSET 1 308SE Derived Flow
vs.
SAMOSET 1 308SE Simulated Flow

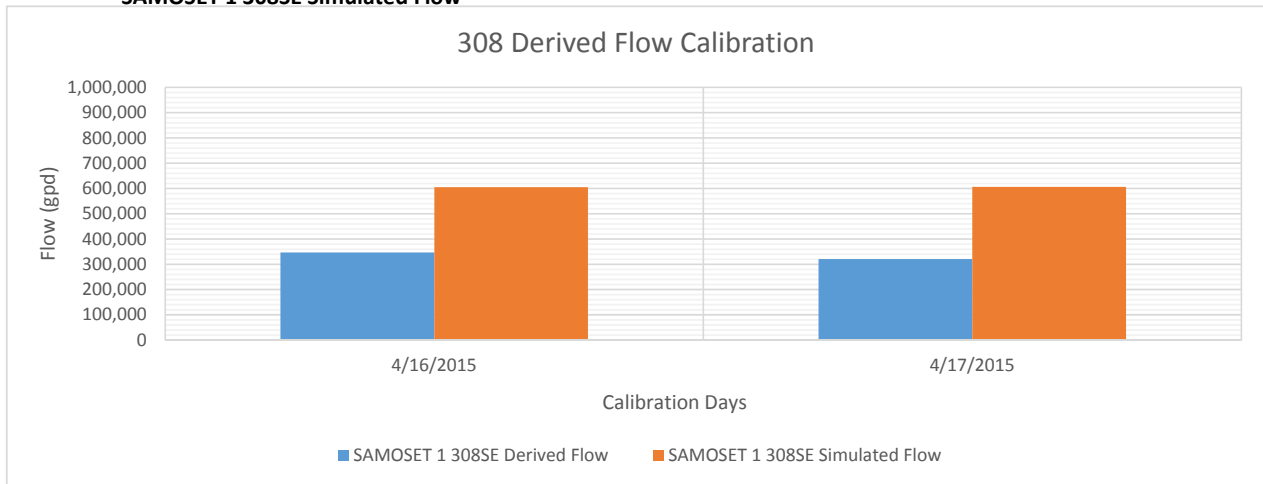

Other Lift Stations with Derived Flow:

vs. EL CONQUIS 1 104SC Derived Flow
EL CONQUIS 1 104SC Simulated Flow

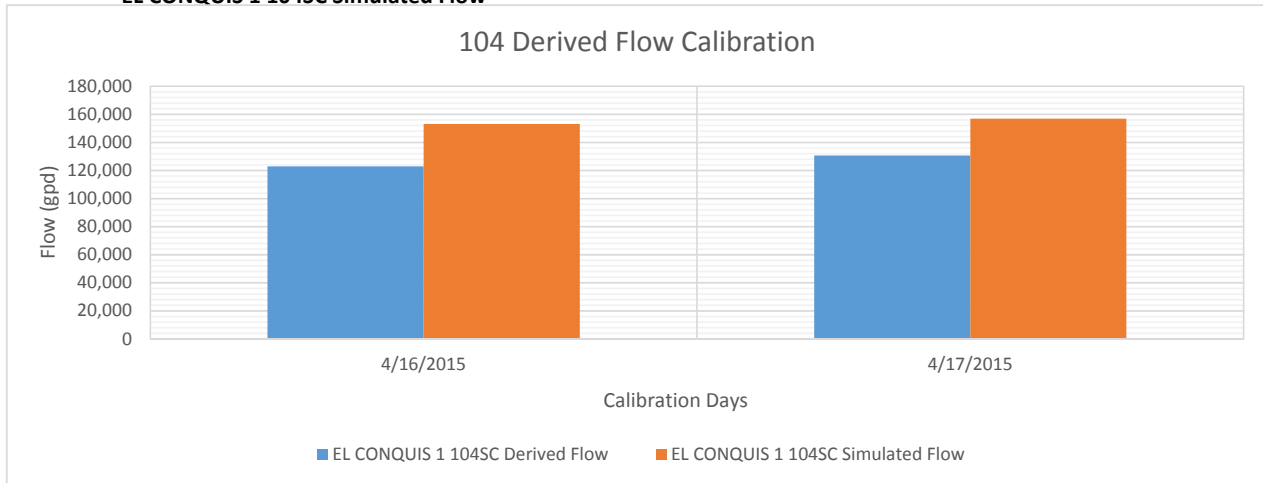

vs. BAYSHORE Y.B. 101SC Derived Flow
BAYSHORE Y.B. 101SC Simulated Flow

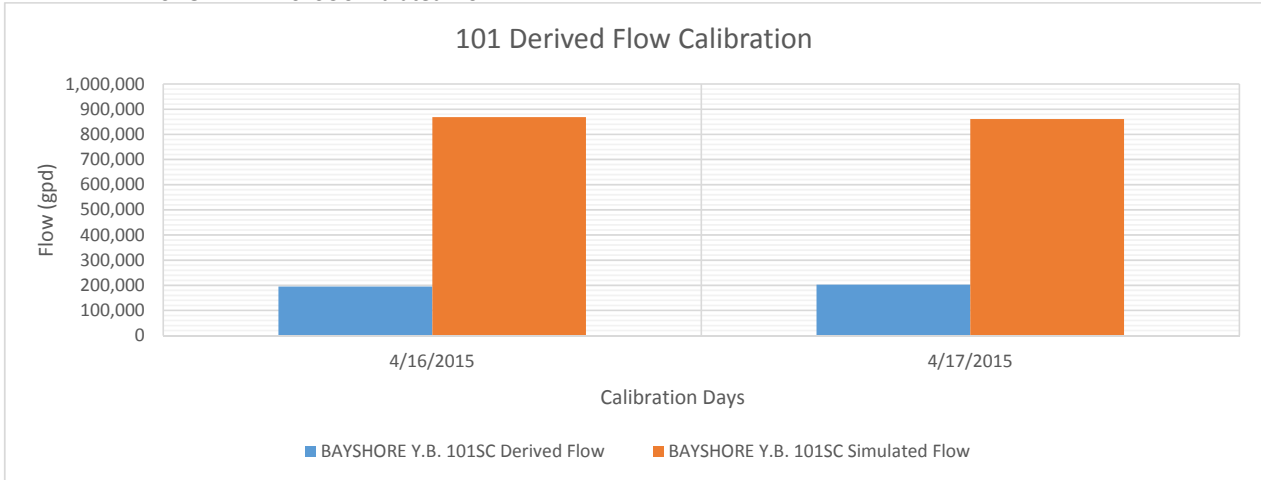

*This lift station is known to have higher flows, especially during rainfall events. The derived flow during the calibration period was considered inaccurate. We recommend the County install a flowmeter (temporary or permanent) in order to obtain more accurate flow data (including I&I) for this critical lift station.

Pressure Calibration:

vs. MLS 1M FM SCADA Pressure
MLS 1M FM Simulated Pressure

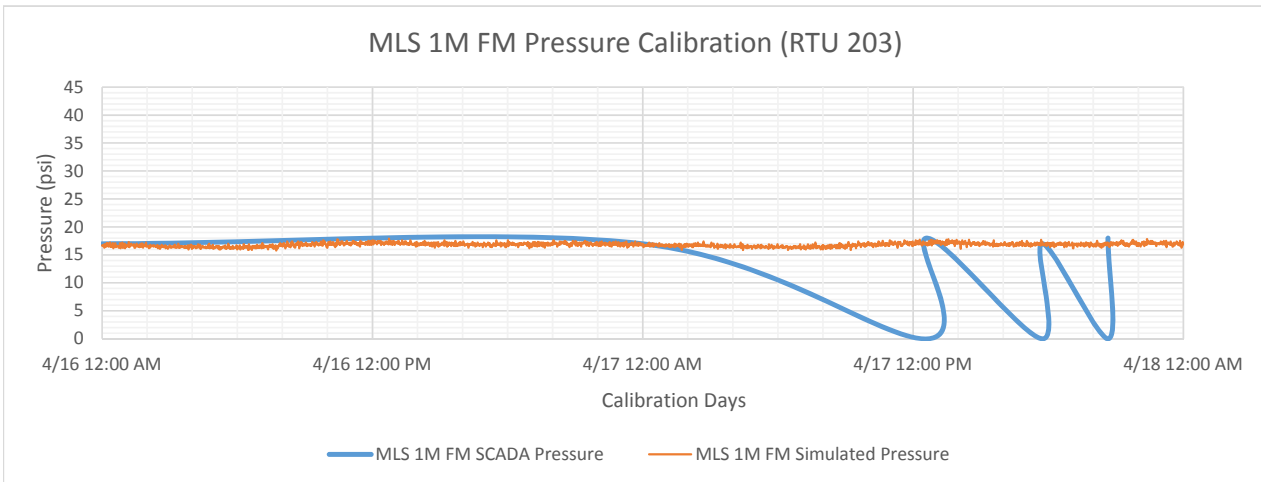

vs.
MLS 1D FM SCADA Pressure
MLS 1D FM Simulated Pressure

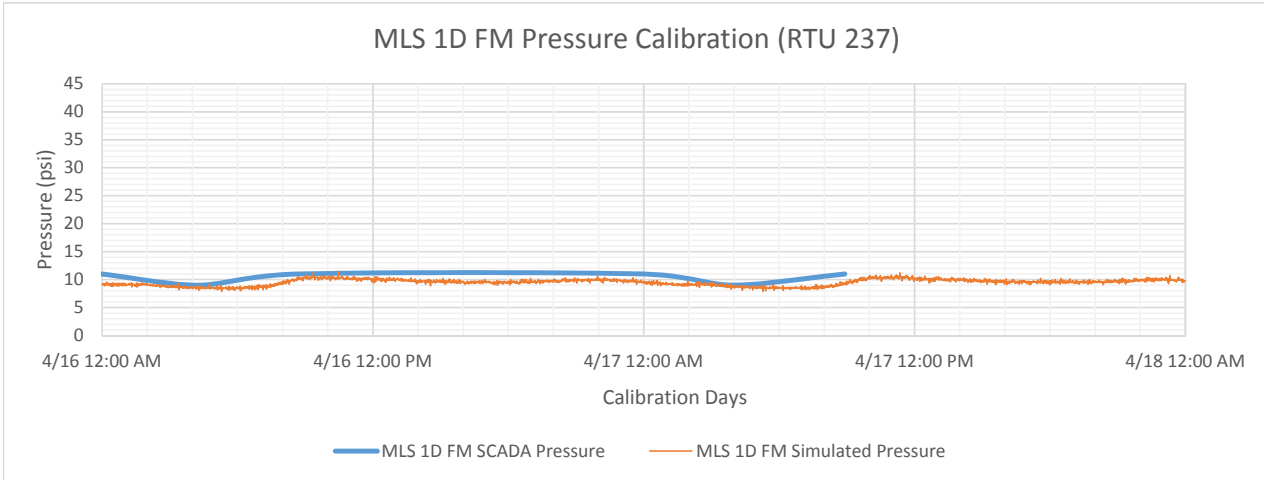

vs.
MLS 27-A FM SCADA Pressure
MLS 27-A FM Simulated Pressure

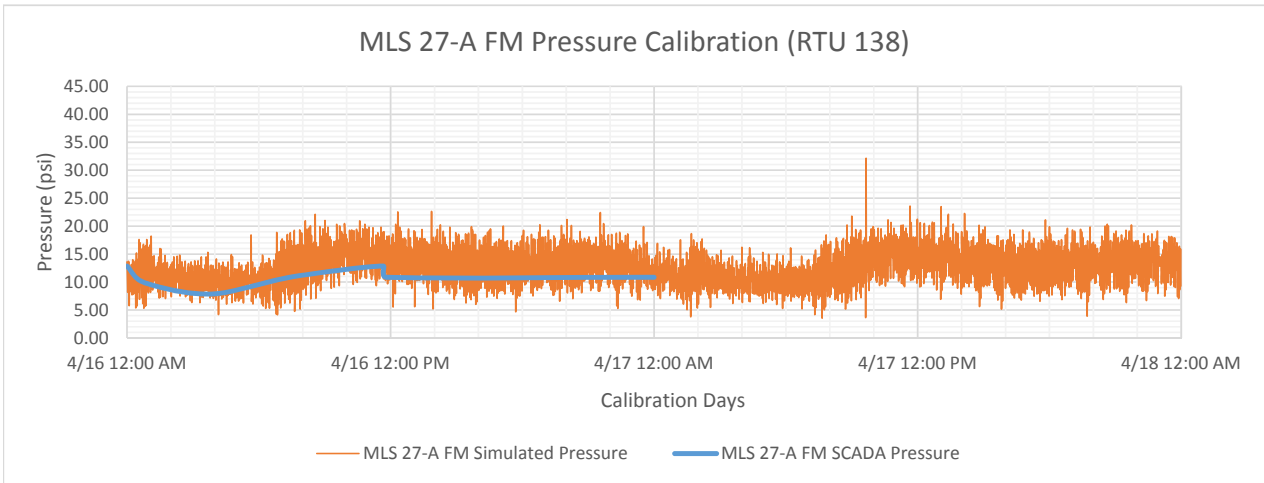

vs.
MLS 12-A FM SCADA Pressure
MLS 12-A FM Simulated Pressure

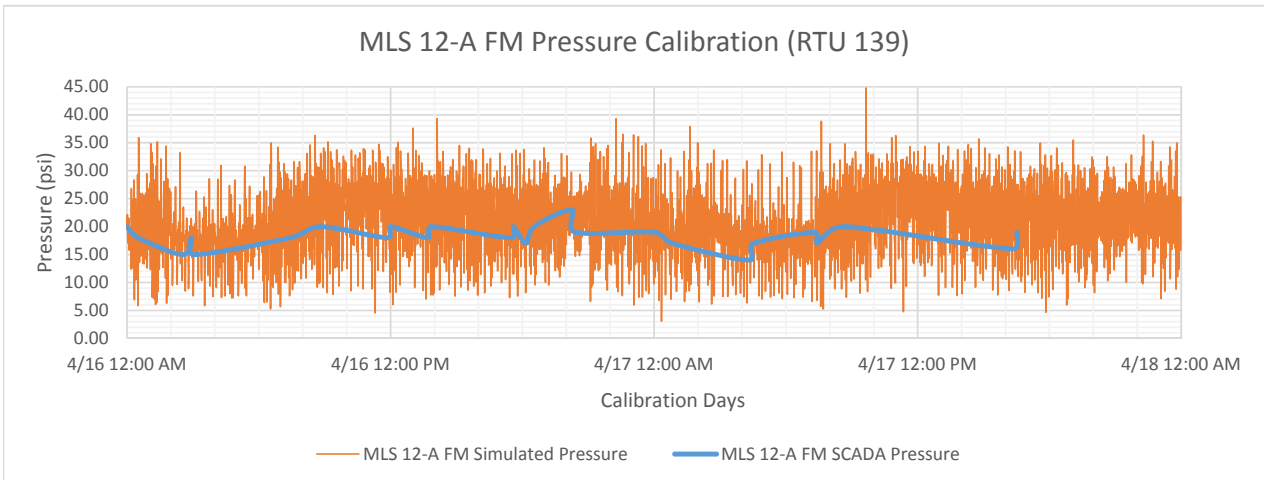

vs.
MLS 13-A FM SCADA Pressure
MLS 13-A FM Simulated Pressure

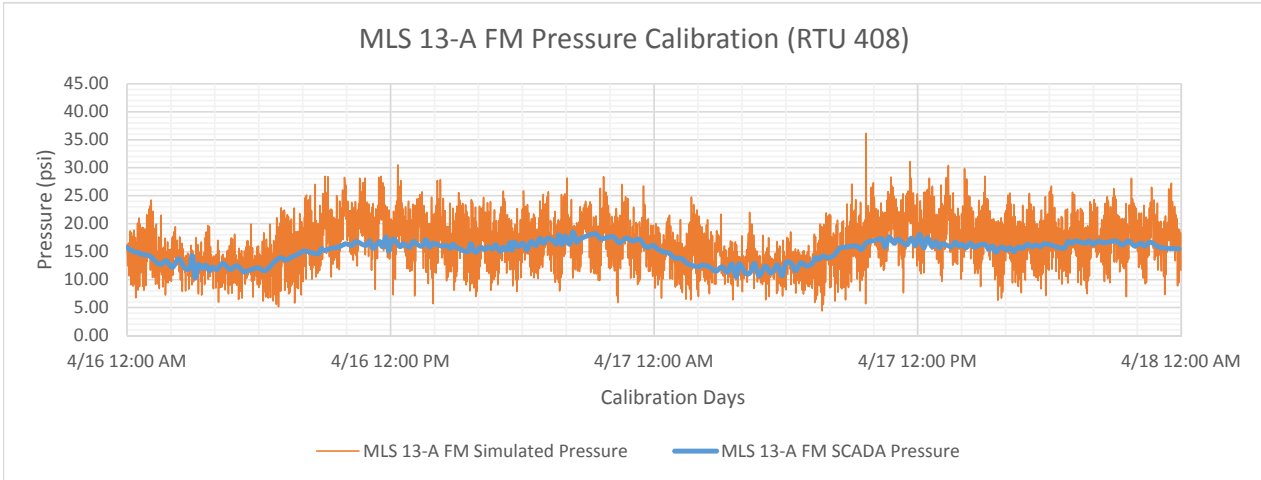

vs.
C-7 Field Pressure
C-7 Simulated Pressure

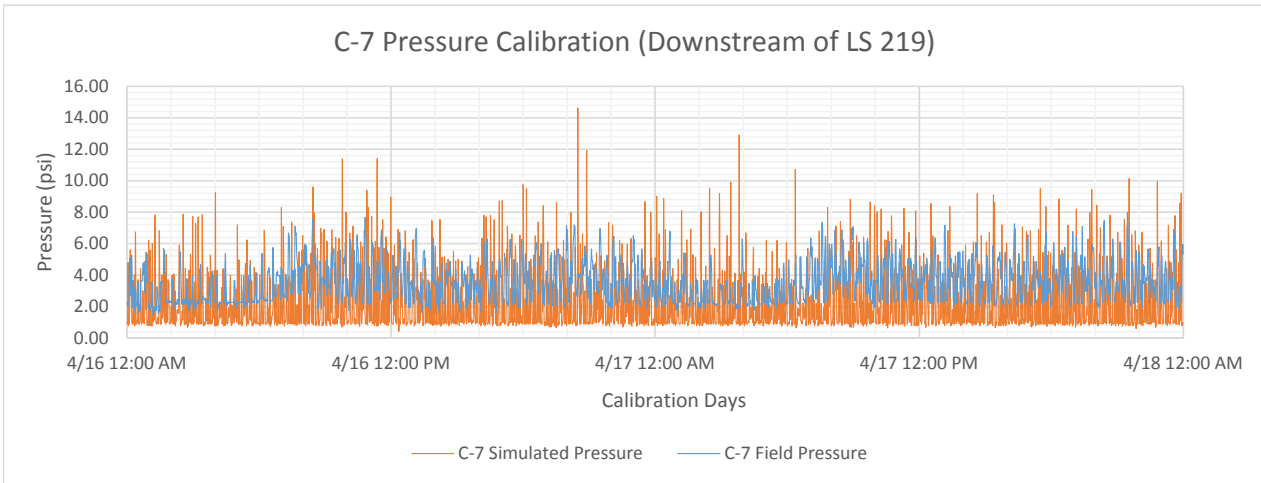

vs.
C-8 Field Pressure
C-8 Simulated Pressure

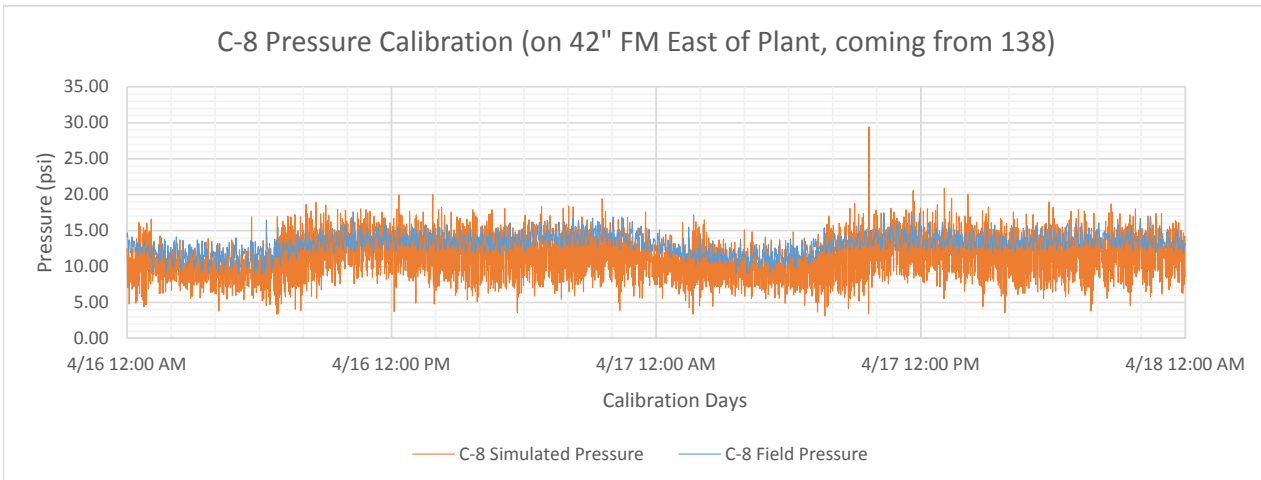

vs.
C-9 Field Pressure
C-9 Simulated Pressure

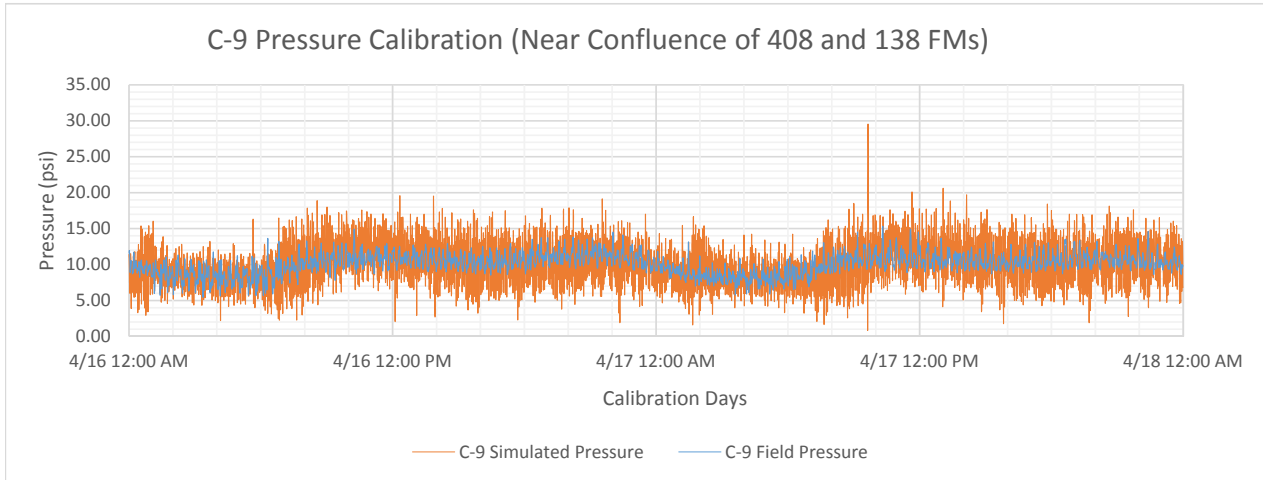

vs.
C-10 Field Pressure
C-10 Simulated Pressure

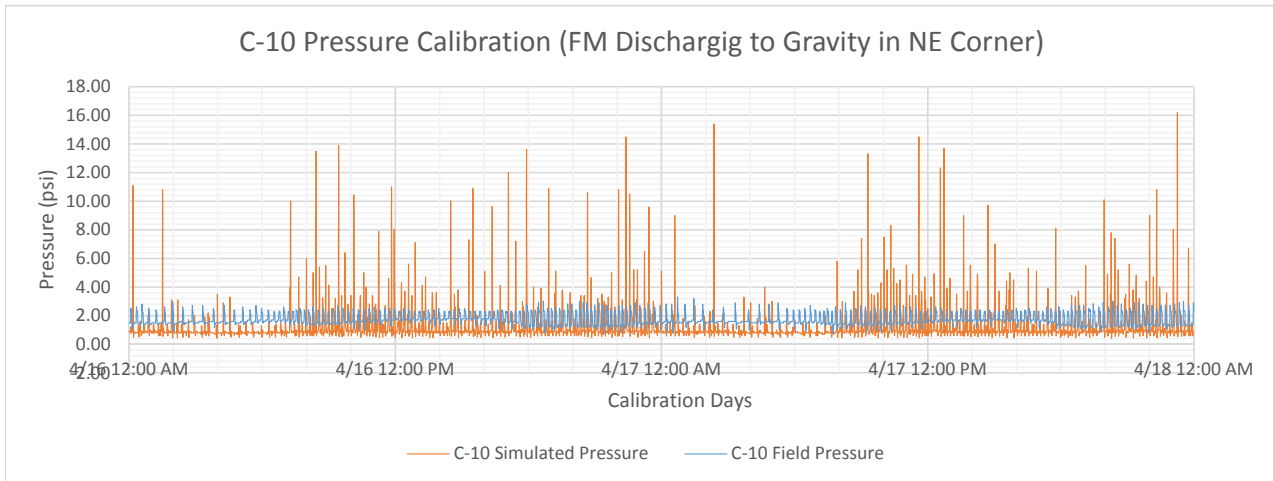

APPENDIX G – Wet Weather Calibration Scenario

Wet Weather Calibration Scenario

Hourly Flow Calibration:

vs. **SWWRF SCADA Flow**
vs. **SWWRF Simulated Flow**

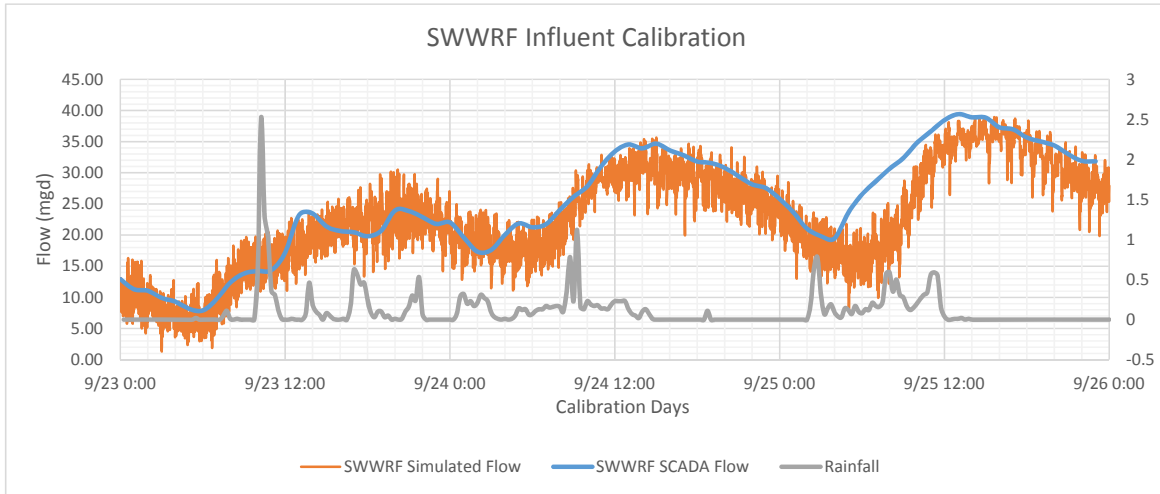

vs. **Wet Weather Calibration**
Flow from SCADA Pump Speed and Pressure

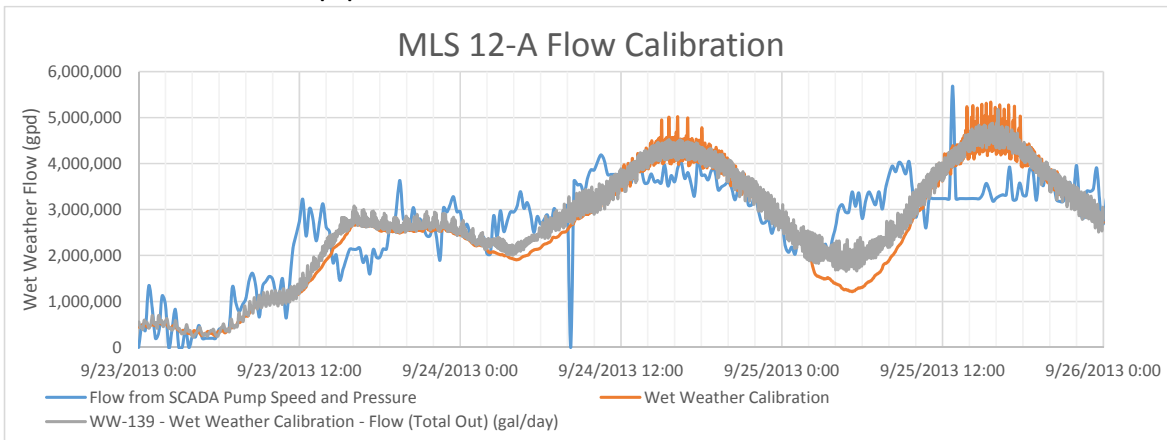

Daily & Derived Flow Calibration:

vs. **SWWRF SCADA Flow**
vs. **SWWRF Simulated Flow**

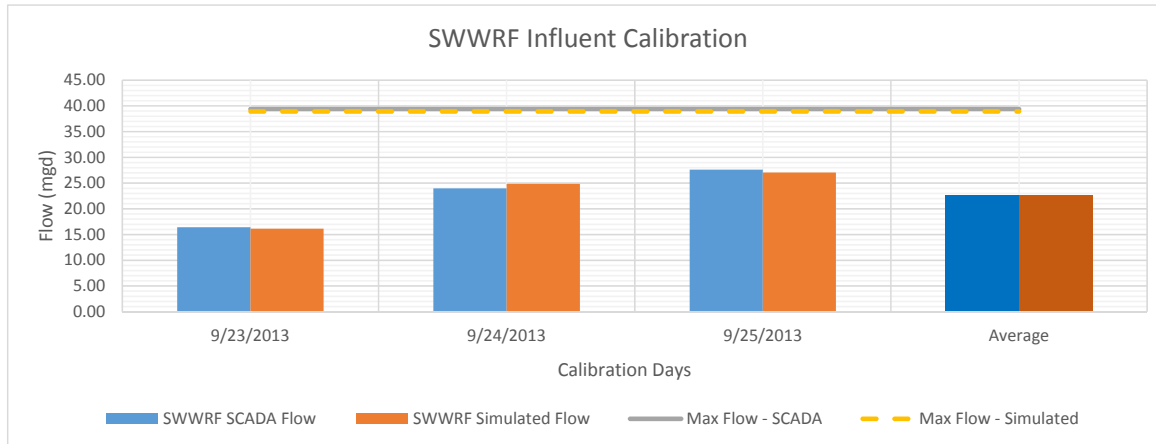

MLS 1MA RTU 203 Derived Flow
vs.
MLS 1MA RTU 203 Simulated Flow

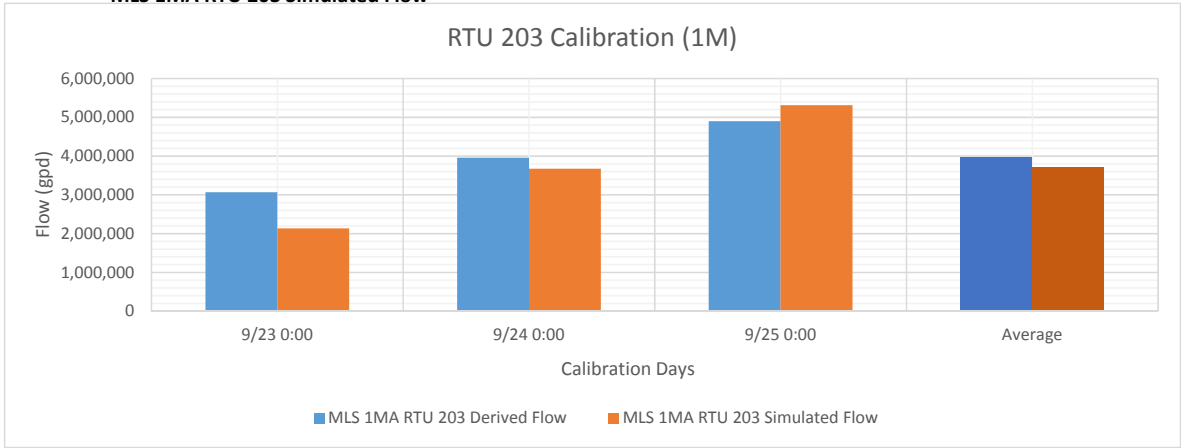

MLS 1D RTU 237 SCADA Flow
vs.
MLS 1D RTU 237 Simulated Flow

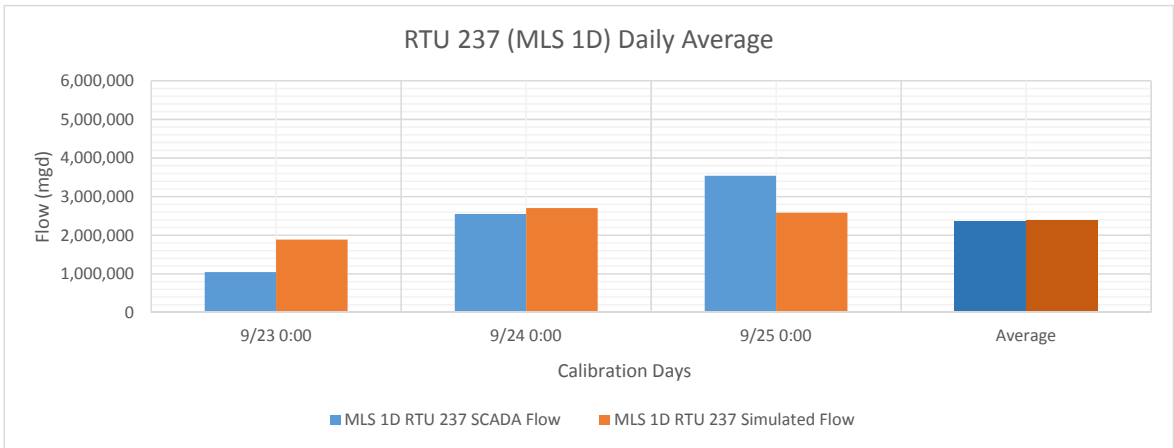

MLS 13A RTU 408 Derived Flow
vs.
MLS 13A RTU 408 Simulated Flow

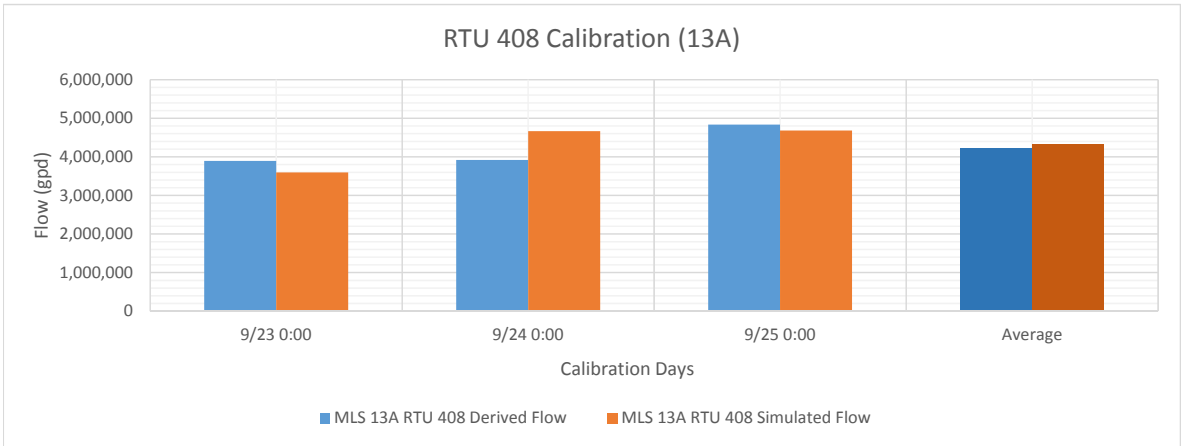

vs. MLS 12A RTU 139 Derived Flow
MLS 12A RTU 139 Simulated Flow

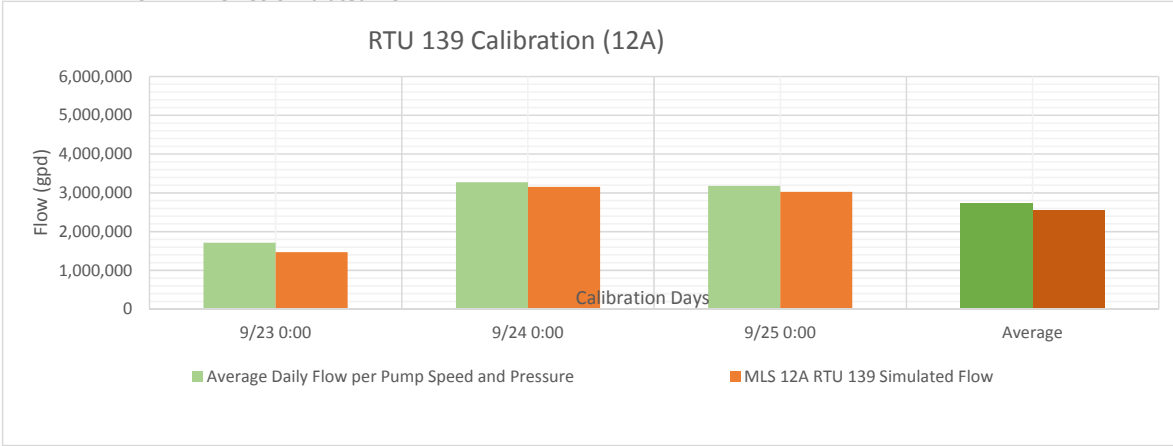

vs. MLS 27A RTU 138 Derived Flow
MLS 27A RTU 138 Simulated Flow

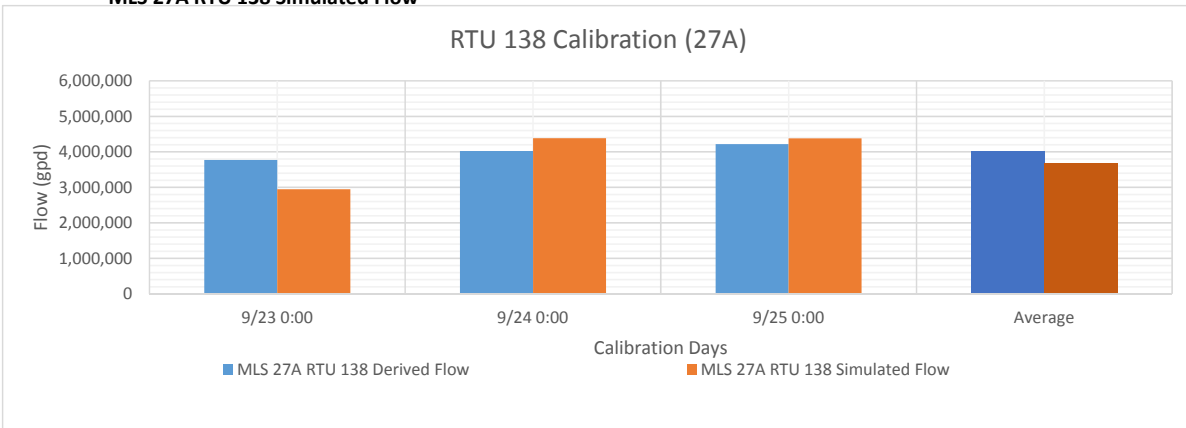

vs. RTU 226 SCADA Flow
RTU 226 Simulated Flow

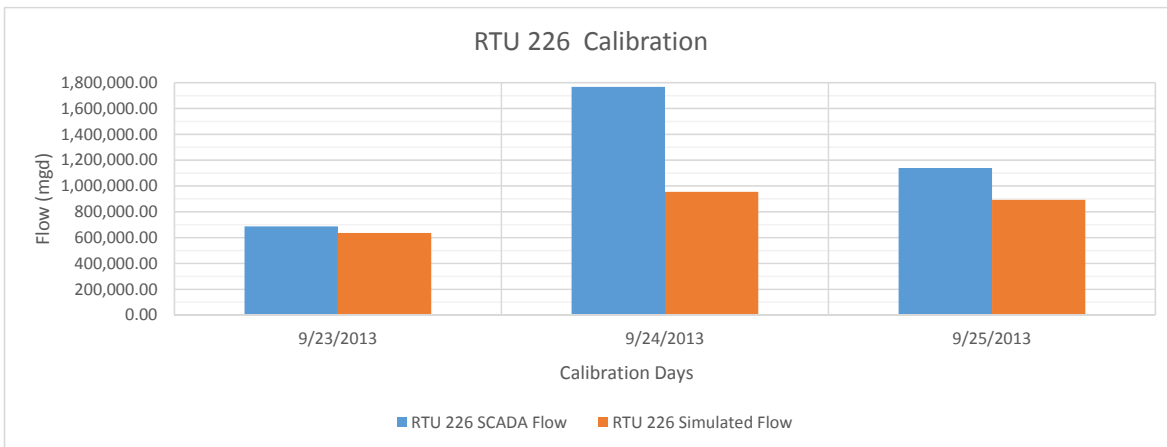

**RTU 211 SCADA Flow
vs.
RTU 211 Simulated Flow**

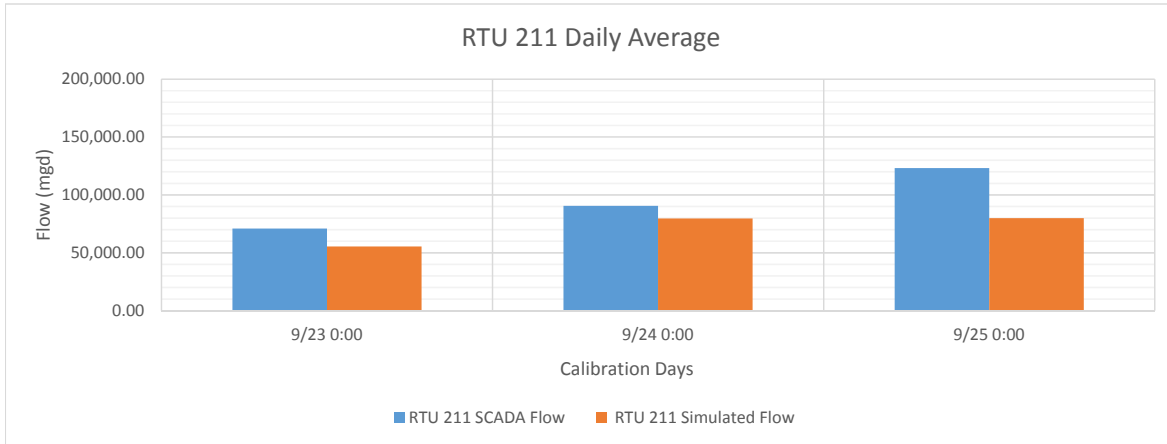

**RTU 220 Derived Flow
vs.
RTU 220 Simulated Flow**

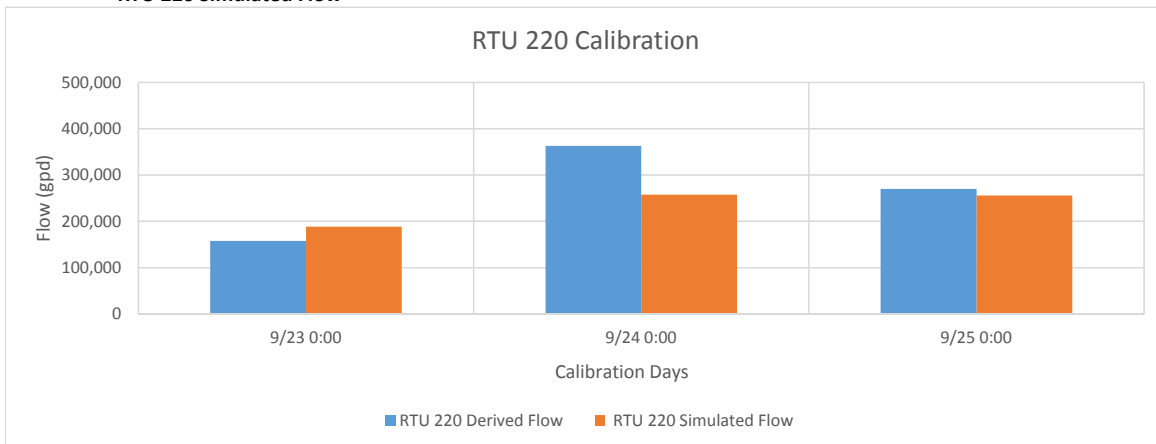

**RTU 104 Derived Flow
vs.
RTU 104 Simulated Flow**

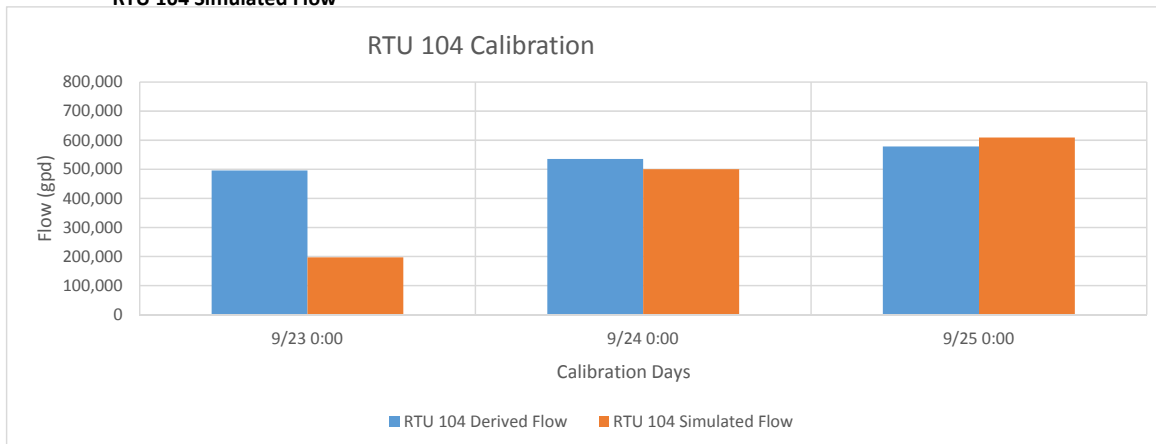

**vs. RTU 101 Derived Flow
RTU 101 Simulated Flow**

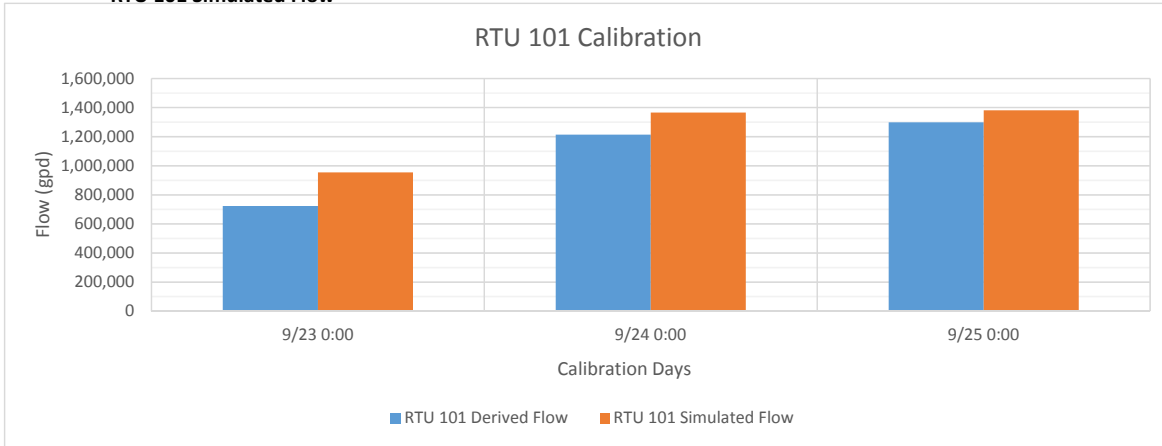

**vs. RTU 434 Derived Flow
RTU 434 Simulated Flow**

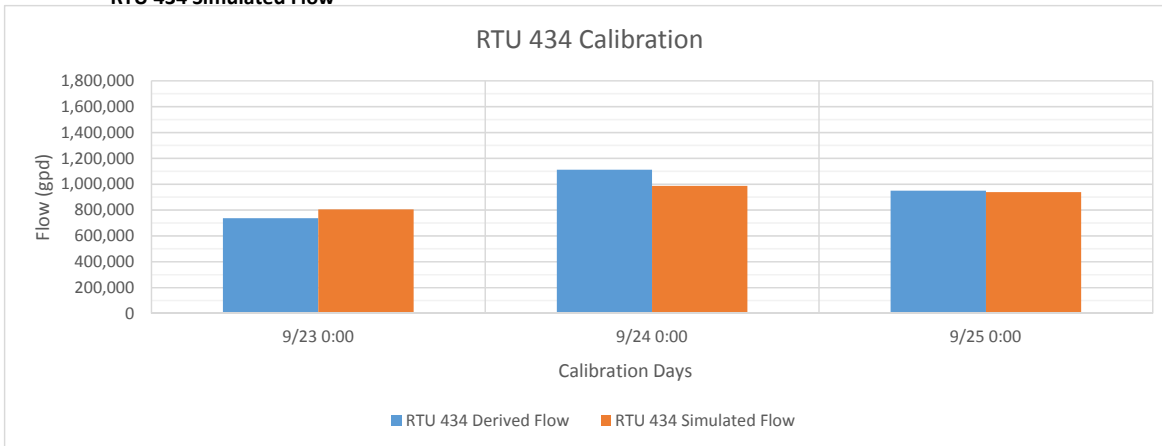

**vs. RTU 221 Derived Flow
RTU 221 Simulated Flow**

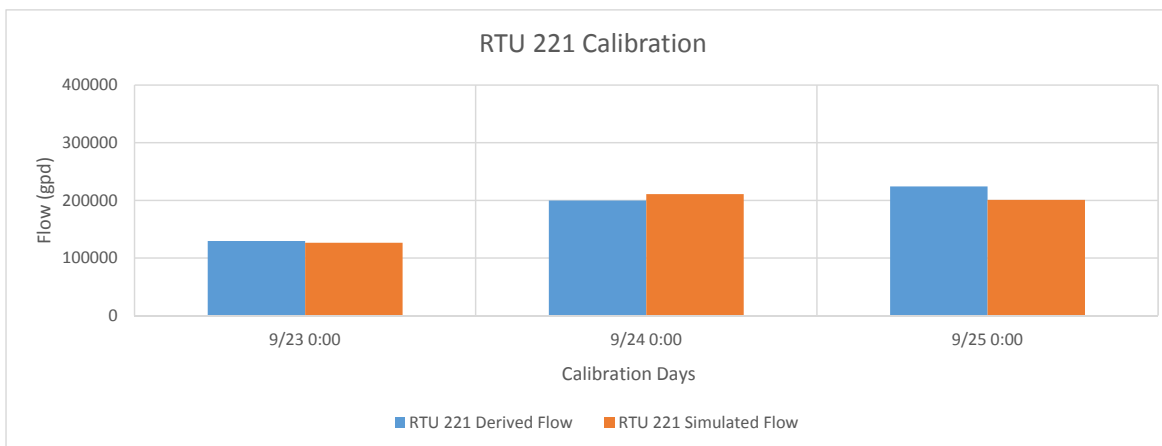

Southwest County Wastewater Collection System Master Plan Update

**APPENDIX H –LIFT STATION PERFORMANCE CRITERIA
EVALUATION**

Existing Lift Station Capacity and Wet Well Volume Performance Criteria
Southwest WWCS Master Plan Update
Manatee County

| Lift Station RTU | Lift Station Capacity | | | | Wet Well Volume | | |
|--------------------------------|---|---|--|--|--|---|---|
| | Lift Station Firm Capacity (gpm) ⁽¹⁾ | Max. Simulated Flow 2015 LOS Scenario (gpm) | Max. Simulated Flow -2015 Wet Weather Scenario (gpm) | Was Firm Capacity Ever Exceeded? (LOS, Wet, or Both) | Wet Well Volume between Pump Off and Influent Invert (gallons) | Required Wet Well Volume (gallons) ⁽²⁾ | Does Wet Well Size Meet or Exceed Criteria? |
| Master Lift Stations | | | | | | | |
| 71 | 3,660 | 843 | 1,534 | No | N/A | | |
| 138 | 5,900 | 2,675 | 4,218 | No | | | |
| 139 | 6,000 | 918 | 3,062 | No | | | |
| 203 | 6,786 | 1,661 | 3,485 | No | | | |
| 237 | 5,218 | 1,867 | 2,562 | No | | | |
| 408 | 6,638 | 3,905 | 4,409 | No | | | |
| Satellite Lift Stations | | | | | | | |
| 54 | 300 | 52 | 147 | No | 1,060 | 1,200 | No |
| 55 | 280 | 3 | 5 | No | 188 | 1,120 | No |
| 56 | 200 | 25 | 32 | No | 913 | 800 | Yes |
| 57 | 400 | 59 | 87 | No | 2,974 | 1,600 | Yes |
| 58 | 225 | 67 | 110 | No | 1,818 | 900 | Yes |
| 59 | 275 | 58 | 113 | No | 795 | 1,100 | No |
| 60 | 250 | 34 | 103 | No | 1,842 | 1,000 | Yes |
| 61 | 50 | 7 | 37 | No | 1,184 | 200 | Yes |
| 62 | 800 | 161 | 367 | No | 5,076 | 3,200 | Yes |
| 63 | 200 | 31 | 74 | No | 950 | 800 | Yes |
| 64 | 1,000 | 379 | 708 | No | 4,907 | 4,000 | Yes |
| 65 | 600 | 94 | 208 | No | 2,260 | 2,400 | No |
| 66 | 140 | 15 | 55 | No | 3,971 | 560 | Yes |
| 67 | 250 | 38 | 88 | No | 1,057 | 1,000 | Yes |
| 68 | 320 | 42 | 99 | No | 1,880 | 1,280 | Yes |
| 74 ⁽³⁾ | 40 | 39 | 67 | Yes (Wet) | 308 | 160 | Yes |
| 101 ⁽³⁾ | 950 | 1,295 | 1,361 | Yes (Both) | 7,918 | 3,800 | Yes |
| 102 ⁽⁴⁾ | 100 | 7 | 41 | No | -269 | 400 | No |
| 103 | 108 | 32 | 32 | No | 210 | 432 | No |
| 104 | 800 | 210 | 505 | No | 1,975 | 3,200 | No |
| 105 | 125 | 9 | 25 | No | 1,707 | 500 | Yes |
| 106 | 80 | 12 | 17 | No | 351 | 320 | Yes |
| 107 | 75 | 8 | 24 | No | 676 | 300 | Yes |
| 108 ⁽³⁾ | 50 | 141 | 125 | Yes (Both) | 934 | 200 | Yes |
| 109 | 105 | 17 | 14 | No | 155 | 420 | No |
| 110 | 125 | 4 | 4 | No | 647 | 500 | Yes |
| 111 | 150 | 23 | 19 | No | 274 | 600 | No |
| 112 | 150 | 8 | 6 | No | 204 | 600 | No |
| 113 | 100 | 50 | 41 | No | 934 | 400 | Yes |
| 114 | 325 | 80 | 67 | No | 1,218 | 1,300 | No |
| 115 | 190 | 28 | 23 | No | 347 | 760 | No |
| 116 ⁽³⁾ | 190 | 214 | 237 | Yes (Both) | 1,691 | 760 | Yes |
| 117 | 140 | 52 | 51 | No | 22 | 560 | No |
| 118 ⁽⁴⁾ | 150 | 81 | 84 | No | -482 | 600 | No |
| 119 | 300 | 17 | 15 | No | 743 | 1,200 | No |
| 120 ⁽⁴⁾ | 300 | 13 | 63 | No | -127 | 1,200 | No |
| 122 | 100 | 20 | 19 | No | 2,749 | 400 | Yes |
| 123 | 100 | 3 | 24 | No | 611 | 400 | Yes |
| 124 | 275 | 29 | 56 | No | 1,248 | 1,100 | Yes |
| 125 | 392 | 104 | 87 | No | 1,140 | 1,568 | No |
| 126 | 1,542 | 640 | 714 | No | 4,145 | 6,168 | No |
| 127 | 255 | 51 | 42 | No | 1,462 | 1,020 | Yes |
| 128 | 128 | 2 | 2 | No | 360 | 512 | No |
| 129 | 455 | 386 | 357 | No | 5,513 | 1,820 | Yes |
| 130 | 125 | 47 | 39 | No | 913 | 500 | Yes |
| 132 | 350 | 96 | 153 | No | 825 | 1,400 | No |
| 133 | 125 | 1 | 2 | No | 70 | 500 | No |
| 134 | 100 | 2 | 9 | No | 1,065 | 400 | Yes |
| 135 ⁽³⁾ | 637 | 397 | 898 | Yes (Wet) | 2,889 | 2,548 | Yes |
| 136 ⁽³⁾ | 453 | 332 | 666 | Yes (Wet) | 1,457 | 1,812 | No |
| 137 ⁽³⁾ | 280 | 22 | 327 | Yes (Wet) | 1,590 | 1,120 | Yes |

Notes:

- (1) Firm capacity is total pumping capacity with largest pump out of service. Based on data provided by the County (LS spreadsheet provided in Appendix D).
- (2) Required wet well volume (in gallons) is based on four times the firm capacity (in gpm).
- (3) Firm pump capacity exceeded in 2020 Wet Weather scenario.
- (4) Data provided by County yielded a negative wet well volume (Pump off elevation above the influent pipe invert). Pump on/off elevations and/or influent inverts were adjusted in model. Actual elevations should be confirmed to determine actual capacity.

Existing Lift Station Capacity and Wet Well Volume Performance Criteria
Southwest WWCS Master Plan Update
Manatee County

| Lift Station RTU | Lift Station Capacity | | | | Wet Well Volume | | |
|--------------------|---|---|--|--|--|---|---|
| | Lift Station Firm Capacity (gpm) ⁽¹⁾ | Max. Simulated Flow 2015 LOS Scenario (gpm) | Max. Simulated Flow -2015 Wet Weather Scenario (gpm) | Was Firm Capacity Ever Exceeded? (LOS, Wet, or Both) | Wet Well Volume between Pump Off and Influent Invert (gallons) | Required Wet Well Volume (gallons) ⁽²⁾ | Does Wet Well Size Meet or Exceed Criteria? |
| 140 | 150 | 11 | 9 | No | 338 | 600 | No |
| 141 ⁽³⁾ | 48 | 56 | 59 | Yes (Both) | 700 | 192 | Yes |
| 142 | 150 | 63 | 52 | No | 522 | 600 | No |
| 143 | 180 | 9 | 7 | No | 996 | 720 | Yes |
| 145 | 700 | 29 | 53 | No | 1,192 | 2,800 | No |
| 146 | 126 | 50 | 42 | No | 600 | 504 | Yes |
| 147 | 210 | 20 | 78 | No | 763 | 840 | No |
| 148 | 175 | 13 | 13 | No | 553 | 700 | No |
| 149 ⁽³⁾ | 35 | 24 | 39 | Yes (Wet) | 411 | 140 | Yes |
| 150 | 330 | 186 | 152 | No | 2,926 | 1,320 | Yes |
| 159 | 120 | 28 | 23 | No | 430 | 480 | No |
| 160 ⁽³⁾ | 0 | 3 | 2 | Yes (Both) | 411 | 0 | Yes |
| 161 | 31 | 4 | 13 | No | 105 | 124 | No |
| 201 | 100 | 32 | 59 | No | 656 | 400 | Yes |
| 202 | 200 | 35 | 56 | No | 988 | 800 | Yes |
| 204 | 240 | 53 | 88 | No | 725 | 960 | No |
| 205 | 275 | 78 | 118 | No | 882 | 1,100 | No |
| 206 | 180 | 43 | 86 | No | 1,136 | 720 | Yes |
| 207 | 165 | 59 | 63 | No | 482 | 660 | No |
| 208 | 320 | 6 | 29 | No | 1,292 | 1,280 | Yes |
| 209 | 108 | 2 | 2 | No | 282 | 432 | No |
| 210 | 175 | 65 | 161 | No | 1,015 | 700 | Yes |
| 211 | 200 | 54 | 74 | No | 1,654 | 800 | Yes |
| 212 | 100 | 54 | 53 | No | 171 | 400 | No |
| 213 | 180 | 177 | 131 | No | 846 | 720 | Yes |
| 214 | 20 | 11 | 17 | No | 136 | 80 | Yes |
| 215 | 26 | 7 | 12 | No | 179 | 104 | Yes |
| 216 | 200 | 34 | 50 | No | 958 | 800 | Yes |
| 217 ⁽³⁾ | 207 | 172 | 298 | Yes (Wet) | 1,396 | 828 | Yes |
| 218 | 600 | 137 | 199 | No | 2,669 | 2,400 | Yes |
| 219 | 250 | 128 | 150 | No | 1,079 | 1,000 | Yes |
| 220 | 400 | 183 | 247 | No | 3,967 | 1,600 | Yes |
| 221 | 500 | 172 | 258 | No | 1,470 | 2,000 | No |
| 222 | 100 | 4 | 8 | No | 656 | 400 | Yes |
| 223 | 275 | 34 | 60 | No | 584 | 1,100 | No |
| 224 | 80 | 7 | 18 | No | 742 | 320 | Yes |
| 225 | 750 | 130 | 176 | No | 2,451 | 3,000 | No |
| 226 | 1,000 | 623 | 939 | No | 3,962 | 4,000 | No |
| 227 | 105 | 9 | 13 | No | 262 | 420 | No |
| 228 | 98 | 19 | 26 | No | 292 | 392 | No |
| 229 | 100 | 24 | 38 | No | 1,093 | 400 | Yes |
| 230 | 465 | 220 | 296 | No | 4,068 | 1,860 | Yes |
| 231 | 120 | 53 | 76 | No | 1,502 | 480 | Yes |
| 232 | 128 | 25 | 37 | No | 931 | 512 | Yes |
| 233 | 170 | 114 | 152 | No | 1,918 | 680 | Yes |
| 234 | 134 | 27 | 41 | No | 2,238 | 536 | Yes |
| 235 | 184 | 44 | 72 | No | 1,079 | 736 | Yes |
| 236 | 500 | 171 | 202 | No | 1,918 | 2,000 | No |
| 238 ⁽³⁾ | 400 | 204 | 477 | Yes (Wet) | 1,598 | 1,600 | No |
| 239 | 963 | 374 | 898 | No | 3,397 | 3,852 | No |
| 240 | 250 | 26 | 151 | No | 973 | 1,000 | No |
| 241 | 1,719 | 571 | 1,508 | No | 3,535 | 6,876 | No |
| 242 | 88 | 4 | 8 | No | 1,206 | 352 | Yes |
| 243 | 125 | 11 | 15 | No | 761 | 500 | Yes |
| 245 | 80 | 30 | 55 | No | 952 | 320 | Yes |
| 246 | 124 | 30 | 45 | No | 749 | 496 | Yes |
| 247 | 70 | 4 | 6 | No | 265 | 280 | No |
| 248 | 1,000 | 242 | 209 | No | 1,466 | 4,000 | No |
| 249 | 200 | 30 | 44 | No | 2,451 | 800 | Yes |
| 250 | 146 | 23 | 33 | No | 374 | 584 | No |
| 251 | 122 | 14 | 21 | No | 863 | 488 | Yes |

Notes:

- (1) Firm capacity is total pumping capacity with largest pump out of service. Based on data provided by the County (LS spreadsheet provided in Appendix D).
- (2) Required wet well volume (in gallons) is based on four times the firm capacity (in gpm).
- (3) Firm pump capacity exceeded in 2020 Wet Weather scenario.
- (4) Data provided by County yielded a negative wet well volume (Pump off elevation above the influent pipe invert). Pump on/off elevations and/or influent inverts were adjusted in model. Actual elevations should be confirmed to determine actual capacity.

Existing Lift Station Capacity and Wet Well Volume Performance Criteria
Southwest WWCS Master Plan Update
Manatee County

| Lift Station RTU | Lift Station Capacity | | | | Wet Well Volume | | |
|--------------------|---|---|--|--|--|---|---|
| | Lift Station Firm Capacity (gpm) ⁽¹⁾ | Max. Simulated Flow 2015 LOS Scenario (gpm) | Max. Simulated Flow -2015 Wet Weather Scenario (gpm) | Was Firm Capacity Ever Exceeded? (LOS, Wet, or Both) | Wet Well Volume between Pump Off and Influent Invert (gallons) | Required Wet Well Volume (gallons) ⁽²⁾ | Does Wet Well Size Meet or Exceed Criteria? |
| 257 ⁽³⁾ | 35 | 32 | 61 | Yes (Wet) | 1,836 | 140 | Yes |
| 258 ⁽³⁾ | 8 | 23 | 0 | Yes (LOS) | 553 | 32 | Yes |
| 259 ⁽⁴⁾ | 8 | 3 | 4 | No | 461 | 32 | Yes |
| 260 | 705 | 98 | 81 | No | 3,662 | 2,820 | Yes |
| 262 | 20 | 3 | 5 | No | 351 | 80 | Yes |
| 263 | 118 | 12 | 24 | No | 596 | 472 | Yes |
| 264 | 30 | 1 | 2 | No | 594 | 120 | Yes |
| 265 | 30 | 1 | 2 | No | 5,287 | 120 | Yes |
| 298 | 205 | 23 | 65 | No | 761 | 820 | No |
| 301 | 250 | 4 | 19 | No | 632 | 1,000 | No |
| 302 ⁽³⁾ | 480 | 156 | 552 | Yes (Wet) | 1,930 | 1,920 | Yes |
| 303 ⁽³⁾ | 525 | 273 | 714 | Yes (Wet) | 2,781 | 2,100 | Yes |
| 304 | 310 | 30 | 82 | No | 372 | 1,240 | No |
| 305 | 300 | 56 | 163 | No | 1,698 | 1,200 | Yes |
| 308 | 1,150 | 770 | 981 | No | 4,991 | 4,600 | Yes |
| 318 | 200 | 50 | 114 | No | 1,774 | 800 | Yes |
| 319 ⁽³⁾ | 133 | 220 | 231 | Yes (Both) | 1,256 | 532 | Yes |
| 320 | 206 | 20 | 42 | No | 571 | 824 | No |
| 322 | 100 | 10 | 15 | No | 1,180 | 400 | Yes |
| 333 | 125 | 37 | 46 | No | 1,748 | 500 | Yes |
| 334 ⁽⁴⁾ | 200 | 42 | 119 | No | -301 | 800 | No |
| 336 | 75 | 37 | 46 | No | 634 | 300 | Yes |
| 338 | 342 | 128 | 174 | No | -94 | 1,368 | No |
| 339 | 250 | 144 | 166 | No | 132 | 1,000 | No |
| 340 | 100 | 64 | 77 | No | 381 | 400 | No |
| 341 ⁽⁴⁾ | 450 | 303 | 340 | No | -4,643 | 1,800 | No |
| 342 ⁽³⁾ | 85 | 163 | 209 | Yes (Both) | 282 | 340 | No |
| 343 ⁽³⁾ | 35 | 36 | 58 | Yes (Both) | 53 | 140 | No |
| 361 | 125 | 8 | 17 | No | 317 | 500 | No |
| 393 | 220 | 72 | 89 | No | 2,861 | 880 | Yes |
| 396 | 35 | 26 | 25 | No | 2,885 | 140 | Yes |
| 401 ⁽⁴⁾ | 255 | 14 | 49 | No | 417 | 1,020 | No |
| 402 ⁽³⁾ | 250 | 24 | 270 | Yes (Wet) | 1,550 | 1,000 | Yes |
| 403 | 155 | 21 | 56 | No | 942 | 620 | Yes |
| 404 ⁽³⁾ | 195 | 56 | 130 | No | 1,918 | 780 | Yes |
| 405 ⁽⁴⁾ | 184 | 22 | 105 | No | -3 | 736 | No |
| 406 | 250 | 108 | 101 | No | 1,202 | 1,000 | Yes |
| 407 | 150 | 27 | 35 | No | 245 | 600 | No |
| 409 | 200 | 36 | 51 | No | 470 | 800 | No |
| 410 | 350 | 199 | 200 | No | 2,312 | 1,400 | Yes |
| 411 | 250 | 27 | 23 | No | 3,799 | 1,000 | Yes |
| 412 | 105 | 7 | 53 | No | 249 | 420 | No |
| 413 | 286 | 29 | 36 | No | 1,628 | 1,144 | Yes |
| 414 | 115 | 22 | 41 | No | 282 | 460 | No |
| 415 | 150 | 100 | 121 | No | 546 | 600 | No |
| 416 | 200 | 113 | 190 | No | 287 | 800 | No |
| 417 | 120 | 3 | 24 | No | 316 | 480 | No |
| 418 | 780 | 187 | 356 | No | 1,385 | 3,120 | No |
| 419 | 170 | 11 | 13 | No | 97 | 680 | No |
| 420 | 220 | 30 | 35 | No | 765 | 880 | No |
| 421 | 200 | 12 | 36 | No | 462 | 800 | No |
| 422 | 100 | 24 | 57 | No | 266 | 400 | No |
| 423 | 150 | 8 | 18 | No | 166 | 600 | No |
| 424 | 250 | 89 | 90 | No | 1,244 | 1,000 | Yes |
| 425 | 125 | 10 | 42 | No | 441 | 500 | No |
| 426 | 525 | 91 | 110 | No | 994 | 2,100 | No |
| 431 | 200 | 23 | 35 | No | 1,057 | 800 | Yes |
| 432 | 550 | 138 | 146 | No | 1,939 | 2,200 | No |
| 433 | 651 | 229 | 241 | No | 2,908 | 2,604 | Yes |
| 434 | 1,400 | 886 | 921 | No | 4,188 | 5,600 | No |

Notes:

- (1) Firm capacity is total pumping capacity with largest pump out of service. Based on data provided by the County (LS spreadsheet provided in Appendix D).
- (2) Required wet well volume (in gallons) is based on four times the firm capacity (in gpm).
- (3) Firm pump capacity exceeded in 2020 Wet Weather scenario.
- (4) Data provided by County yielded a negative wet well volume (Pump off elevation above the influent pipe invert). Pump on/off elevations and/or influent inverts were adjusted in model. Actual elevations should be confirmed to determine actual capacity.

Existing Lift Station Capacity and Wet Well Volume Performance Criteria
Southwest WWCS Master Plan Update
Manatee County

| Lift Station RTU | Lift Station Capacity | | | | Wet Well Volume | | |
|--------------------|---|---|--|--|--|---|---|
| | Lift Station Firm Capacity (gpm) ⁽¹⁾ | Max. Simulated Flow 2015 LOS Scenario (gpm) | Max. Simulated Flow -2015 Wet Weather Scenario (gpm) | Was Firm Capacity Ever Exceeded? (LOS, Wet, or Both) | Wet Well Volume between Pump Off and Influent Invert (gallons) | Required Wet Well Volume (gallons) ⁽²⁾ | Does Wet Well Size Meet or Exceed Criteria? |
| 435 | 175 | 17 | 83 | No | 134 | 700 | No |
| 436 ⁽³⁾ | 225 | 196 | 426 | Yes (Wet) | 677 | 900 | No |
| 437 ⁽³⁾ | 180 | 77 | 400 | Yes (Wet) | 831 | 720 | Yes |
| 438 | 120 | 6 | 29 | No | 975 | 480 | Yes |
| 439 | 1,433 | 192 | 874 | No | 3,610 | 5,732 | No |
| 440 ⁽³⁾ | 345 | 129 | 647 | Yes (Wet) | 2,475 | 1,380 | Yes |
| 457 ⁽³⁾ | 110 | 209 | 205 | Yes (Both) | 639 | 440 | Yes |
| 458 ⁽³⁾ | 66 | 130 | 118 | Yes (Both) | 579 | 264 | Yes |
| 460 | 75 | 1 | 19 | No | 634 | 300 | Yes |
| 469 | 150 | 46 | 143 | No | 692 | 600 | Yes |
| 471 | 115 | 19 | 18 | No | 550 | 460 | Yes |
| 484 | 175 | 35 | 55 | No | 2,296 | 700 | Yes |
| 485 | 40 | 7 | 15 | No | 945 | 160 | Yes |
| 486 | 10 | 0 | 3 | No | 603 | 40 | Yes |
| 488 | 260 | 21 | 28 | No | 1,722 | 1,040 | Yes |
| 491 | 230 | 15 | 23 | No | 1,375 | 920 | Yes |

Notes:

- (1) Firm capacity is total pumping capacity with largest pump out of service. Based on data provided by the County (LS spreadsheet provided in Appendix D).
- (2) Required wet well volume (in gallons) is based on four times the firm capacity (in gpm).
- (3) Firm pump capacity exceeded in 2020 Wet Weather scenario.
- (4) Data provided by County yielded a negative wet well volume (Pump off elevation above the influent pipe invert). Pump on/off elevations and/or influent inverts were adjusted in model. Actual elevations should be confirmed to determine actual capacity.

Southwest County Wastewater Collection System Master Plan Update

APPENDIX I – EXCERPT OF FY2015 - 2019 WW CIP

MANATEE COUNTY GOVERNMENT
Fiscal Year 2015 - 2019 Capital Improvement Program
Sources and Uses of Funds Plan Summary by Category

Wastewater

| Source of Funds | Actual | Budget | FY2015 | FY2016 | FY2017 | FY2018 | FY2019 | Future | Total Budget |
|------------------------------|-------------------|-------------------|-------------------|-------------------|-------------------|-------------------|-------------------|----------|--------------------|
| All Sources | 51,936,453 | 92,495,249 | 0 | 0 | 0 | 0 | 0 | 0 | 92,495,249 |
| Debt Proceeds | 0 | 0 | 25,020,500 | 23,429,250 | 9,172,250 | 16,069,000 | 15,090,000 | 0 | 88,781,000 |
| Facility Investment Fees | 0 | 0 | 4,021,000 | 9,423,750 | 3,318,750 | 5,173,500 | 1,000,000 | 0 | 22,937,000 |
| Grants | 0 | 0 | 1,350,000 | 1,410,500 | 0 | 0 | 0 | 0 | 2,760,500 |
| Rates | 0 | 0 | 17,698,350 | 14,676,425 | 3,873,250 | 5,854,200 | 10,393,000 | 0 | 52,495,225 |
| Total Source of Funds | 51,936,453 | 92,495,249 | 48,089,850 | 48,939,925 | 16,364,250 | 27,096,700 | 26,483,000 | 0 | 259,468,974 |

Use of Funds

| | Actual | Budget | FY2015 | FY2016 | FY2017 | FY2018 | FY2019 | Future | Total Budget |
|--|-------------------|-------------------|-------------------|-------------------|-------------------|-------------------|-------------------|----------|--------------------|
| Wastewater Collections | 2,724,674 | 4,140,836 | 1,950,000 | 5,225,000 | 1,250,000 | 5,000,000 | 0 | 0 | 17,565,836 |
| Wastewater Growth Related Booster Static | 6,594,141 | 6,991,772 | 567,000 | 3,070,000 | 556,500 | 4,613,500 | 7,023,000 | 0 | 22,821,772 |
| Wastewater Restore/Rehab | 4,421,685 | 11,023,939 | 17,090,550 | 23,465,425 | 5,418,250 | 4,568,700 | 5,000,000 | 0 | 66,566,864 |
| Wastewater Transportation Related | 114,356 | 988,984 | 1,067,800 | 0 | 0 | 0 | 0 | 0 | 2,056,784 |
| Wastewater Treatment | 38,081,597 | 69,349,718 | 27,414,500 | 17,179,500 | 9,139,500 | 12,914,500 | 14,460,000 | 0 | 150,457,718 |
| Total Use of Funds | 51,936,453 | 92,495,249 | 48,089,850 | 48,939,925 | 16,364,250 | 27,096,700 | 26,483,000 | 0 | 259,468,974 |



MANATEE COUNTY GOVERNMENT
Fiscal Year 2015 - 2019 Capital Improvement Program
Uses of Funds by Project and Category

| Wastewater | | Actual | Budget | FY2015 | FY2016 | FY2017 | FY2018 | FY2019 | Future | Total Budget |
|-------------------------------|--|------------------|------------------|------------------|------------------|------------------|------------------|----------|----------|-------------------|
| Wastewater Collections | | | | | | | | | | |
| 1 | Force Main 41A Redirect to Tara 20 (WW00980 / Existing) | 0 | 0 | 0 | 0 | 1,250,000 | 5,000,000 | 0 | 0 | 6,250,000 |
| 2 | Force Main Tara Boulevard (6079880 / Existing) | 888,538 | 1,640,000 | 0 | 0 | 0 | 0 | 0 | 0 | 1,640,000 |
| 3 | Parrish Village Force Main and Master Lift Station (6069180 / Existing) | 1,281,897 | 1,281,898 | 150,000 | 4,500,000 | 0 | 0 | 0 | 0 | 5,931,898 |
| 4 | SR 64 from Carlton Arms to I-75 - Sewer Line Relocation (6059980 / Existing) | 524,744 | 713,938 | 0 | 0 | 0 | 0 | 0 | 0 | 713,938 |
| 5 | Tara 20 Force Main Parallel to Lena Road (6079881 / Existing) | 29,495 | 505,000 | 1,800,000 | 725,000 | 0 | 0 | 0 | 0 | 3,030,000 |
| Wastewater Collections | | 2,724,674 | 4,140,836 | 1,950,000 | 5,225,000 | 1,250,000 | 5,000,000 | 0 | 0 | 17,565,836 |

MANATEE COUNTY GOVERNMENT
Fiscal Year 2015 - 2019 Capital Improvement Program
Uses of Funds by Project and Category

| Wastewater | | Actual | Budget | FY2015 | FY2016 | FY2017 | FY2018 | FY2019 | Future | Total Budget |
|--|--|------------------|------------------|----------------|------------------|----------------|------------------|------------------|----------|-------------------|
| <u>Wastewater Growth Related Booster Stations</u> | | | | | | | | | | |
| 6 | North Water Reclamation Facility Expansion, Phase I (6011283 / Existing) | 6,572,559 | 6,931,772 | 0 | 0 | 0 | 0 | 0 | 0 | 6,931,772 |
| 7 | North Water Reclamation Facility Headworks Second Grit Removal System (WW01245 / Requested) | 0 | 0 | 0 | 0 | 0 | 252,000 | 1,430,000 | 0 | 1,682,000 |
| 8 | Southeast Water Reclamation Facility Dedicated Plan Drain Station (WW01248 / Requested) | 0 | 0 | 0 | 0 | 0 | 179,000 | 1,033,000 | 0 | 1,212,000 |
| 9 | Southeast Water Reclamation Facility Return Activated Sludge & Waste Activated Sludge System Upgrade (WW01249 / Requested) | 0 | 0 | 0 | 0 | 0 | 273,000 | 1,540,000 | 0 | 1,813,000 |
| 10 | Southeast Water Reclamation Facility Storage Lakes & Pump Back Station Improvements (WW01250 / Requested) | 0 | 0 | 0 | 0 | 556,500 | 3,576,500 | 3,020,000 | 0 | 7,153,000 |
| 11 | Southwest Water Reclamation Facility Class V Recharge Well & Aquifer Storage Recovery Well (6069081 / Existing) | 21,582 | 60,000 | 567,000 | 3,070,000 | 0 | 0 | 0 | 0 | 3,697,000 |
| 12 | Southwest Water Reclamation Facility New Roof Covering Bleach Tanks (WW01256 / Requested) | 0 | 0 | 0 | 0 | 0 | 333,000 | 0 | 0 | 333,000 |
| Wastewater Growth Related Booster Stations | | 6,594,141 | 6,991,772 | 567,000 | 3,070,000 | 556,500 | 4,613,500 | 7,023,000 | 0 | 22,821,772 |

MANATEE COUNTY GOVERNMENT
Fiscal Year 2015 - 2019 Capital Improvement Program
Uses of Funds by Project and Category

| Wastewater | Actual | Budget | FY2015 | FY2016 | FY2017 | FY2018 | FY2019 | Future | Total Budget |
|--|-----------|-----------|-----------|-----------|-----------|-----------|-----------|--------|--------------|
| Wastewater Restore/Rehab | | | | | | | | | |
| 13 51st Street Gravity Main Sewer Replacement (6035782 / Existing) | 40,926 | 170,000 | 1,800,000 | 0 | 0 | 0 | 0 | 0 | 1,970,000 |
| 14 Colony Cove 1 and 2 - Gravity Sewer Rehabilitation (6005680 / Existing) | 120,286 | 982,715 | 350,000 | 0 | 0 | 0 | 0 | 0 | 1,332,715 |
| 15 End of Service Life Collection Line Replacement (WW01259 / Requested) | 0 | 0 | 0 | 0 | 2,500,000 | 3,000,000 | 3,500,000 | 0 | 9,000,000 |
| 16 End of Service Life Lift Stations Replacement & Generators (WW01258 / Requested) | 0 | 0 | 0 | 0 | 0 | 0 | 1,500,000 | 0 | 1,500,000 |
| 17 Force Main 12A Rehabilitation (WW00975 / Existing) | 0 | 0 | 315,000 | 4,500,000 | 0 | 0 | 0 | 0 | 4,815,000 |
| 18 Force Main 13A Rehabilitation (WW00976 / Existing) | 0 | 0 | 1,060,000 | 4,400,000 | 875,000 | 0 | 0 | 0 | 6,335,000 |
| 19 Force Main 15D (6022381 / Existing) | 24,682 | 120,000 | 475,000 | 0 | 0 | 0 | 0 | 0 | 595,000 |
| 20 Force Main 17A Replacement (WW01036 / Existing) | 0 | 0 | 64,000 | 319,000 | 0 | 0 | 0 | 0 | 383,000 |
| 21 Force Main 18M Rehabilitation (6083780 / Existing) | 46,511 | 750,000 | 0 | 0 | 0 | 0 | 0 | 0 | 750,000 |
| 22 Force Main 1A Whitfield Subdivision (6052280 / Existing) | 1,543,183 | 2,241,099 | 0 | 0 | 0 | 0 | 0 | 0 | 2,241,099 |
| 23 Force Main 1D Rehabilitation (6035781 / Existing) | 237,983 | 470,000 | 2,350,000 | 3,000,000 | 0 | 0 | 0 | 0 | 5,820,000 |
| 24 Force Main 1M Rehabilitation (6085780 / Existing) | 112,656 | 800,000 | 2,750,000 | 2,715,000 | 0 | 0 | 0 | 0 | 6,265,000 |
| 25 Force Main 1MA Replacement (6085980 / Existing) | 19,548 | 204,000 | 0 | 0 | 0 | 0 | 0 | 0 | 204,000 |
| 26 Force Main 23A Replacement (WW01037 / Existing) | 0 | 0 | 328,000 | 0 | 0 | 0 | 0 | 0 | 328,000 |
| 27 Force Main 27A Rehabilitation (WW00978 / Existing) | 0 | 0 | 340,000 | 1,700,000 | 0 | 0 | 0 | 0 | 2,040,000 |
| 28 Force Main 27A from 51st Street West to the Southwest Water Reclamation Facility (6082980 / Existing) | 74,027 | 100,000 | 3,000,000 | 0 | 0 | 0 | 0 | 0 | 3,100,000 |
| 29 Force Main 31A Replacement (WW01038 / Existing) | 0 | 0 | 105,000 | 520,000 | 0 | 0 | 0 | 0 | 625,000 |
| 30 Force Main 35A Replacement (WW01039 / Existing) | 0 | 0 | 276,000 | 0 | 0 | 0 | 0 | 0 | 276,000 |
| 31 Force Main 5 Rehabilitation (Anna Maria Island) (WW00974 / Existing) | 0 | 0 | 834,000 | 3,500,000 | 670,000 | 0 | 0 | 0 | 5,004,000 |

MANATEE COUNTY GOVERNMENT
Fiscal Year 2015 - 2019 Capital Improvement Program
Uses of Funds by Project and Category

| Wastewater | Actual | Budget | FY2015 | FY2016 | FY2017 | FY2018 | FY2019 | Future | Total Budget |
|--|-----------|-----------|---------|---------|---------|---------|--------|--------|--------------|
| 32 Force Main Replacement 34A - 26th Street West from Heron Way to 53rd Avenue West (6081280 / Existing) | 1,448,593 | 2,382,683 | 0 | 0 | 0 | 0 | 0 | 0 | 2,382,683 |
| 33 Force Main Spanish Park Replacement (WW01040 / Existing) | 0 | 0 | 126,000 | 0 | 0 | 0 | 0 | 0 | 126,000 |
| 34 Force Main Windmill Village Replacement (WW01041 / Existing) | 0 | 0 | 204,000 | 0 | 0 | 0 | 0 | 0 | 204,000 |
| 35 MLS 12A Emergency Generator Replacement (WW01225 / Requested) | 0 | 0 | 0 | 457,750 | 0 | 0 | 0 | 0 | 457,750 |
| 36 MLS 12A Pumps & Variable Frequency Drive Replacement (WW01226 / Requested) | 0 | 0 | 0 | 0 | 0 | 522,900 | 0 | 0 | 522,900 |
| 37 MLS 12A Wet Well Rehab & Dimminutor Replacement (WW01227 / Requested) | 0 | 0 | 588,250 | 0 | 0 | 0 | 0 | 0 | 588,250 |
| 38 MLS 13A Emergency Generator Replacement (WW01228 / Requested) | 0 | 0 | 392,175 | 0 | 0 | 0 | 0 | 0 | 392,175 |
| 39 MLS 1D Wet Well Rehab & Dimminutor Replacement (WW01229 / Requested) | 0 | 0 | 0 | 588,250 | 0 | 0 | 0 | 0 | 588,250 |
| 40 MLS 1M Emergency Generator Replacement (WW01230 / Requested) | 0 | 0 | 457,750 | 0 | 0 | 0 | 0 | 0 | 457,750 |
| 41 MLS 1M Rehabilitation (6060783 / Existing) | 0 | 645,000 | 0 | 0 | 0 | 0 | 0 | 0 | 645,000 |
| 42 MLS 27A (6060782 / Existing) | 585,539 | 587,442 | 0 | 0 | 0 | 0 | 0 | 0 | 587,442 |
| 43 MLS 27A Emergency Generator Replacement (WW01231 / Requested) | 0 | 0 | 457,750 | 0 | 0 | 0 | 0 | 0 | 457,750 |
| 44 MLS 27A Pumps and Variable Frequency Drive Replacement (WW01232 / Requested) | 0 | 0 | 0 | 0 | 0 | 522,900 | 0 | 0 | 522,900 |
| 45 MLS 39A Emergency Generator Replacement (WW01233 / Requested) | 0 | 0 | 0 | 0 | 457,750 | 0 | 0 | 0 | 457,750 |
| 46 MLS 39A Pumps & Variable Frequency Drive Replacement (WW01234 / Requested) | 0 | 0 | 588,250 | 0 | 0 | 0 | 0 | 0 | 588,250 |
| 47 MLS 39A Rehabilitation (6017981 / Existing) | 0 | 420,000 | 0 | 0 | 0 | 0 | 0 | 0 | 420,000 |
| 48 MLS 5 Wet Well Rehabilitation (WW01236 / Requested) | 0 | 0 | 0 | 457,750 | 0 | 0 | 0 | 0 | 457,750 |

MANATEE COUNTY GOVERNMENT
Fiscal Year 2015 - 2019 Capital Improvement Program
Uses of Funds by Project and Category

| Wastewater | Actual | Budget | FY2015 | FY2016 | FY2017 | FY2018 | FY2019 | Future | Total Budget |
|--|-----------|------------|------------|------------|-----------|-----------|-----------|--------|--------------|
| 49 MLS Lakewood Ranch Emergency Generator Replacement (WW01237 / Requested) | 0 | 0 | 0 | 0 | 457,750 | 0 | 0 | 0 | 457,750 |
| 50 MLS Lakewood Ranch Wet Well Rehabilitation (WW01238 / Requested) | 0 | 0 | 0 | 0 | 457,750 | 0 | 0 | 0 | 457,750 |
| 51 MLS N1-B Dimminutor Replacement (WW01239 / Requested) | 0 | 0 | 229,375 | 0 | 0 | 0 | 0 | 0 | 229,375 |
| 52 MLS N1-B Emergency Generator Replacement (WW01240 / Requested) | 0 | 0 | 0 | 457,750 | 0 | 0 | 0 | 0 | 457,750 |
| 53 MLS N1-B Pumps & Variable Frequency Drive Replacement (WW01241 / Requested) | 0 | 0 | 0 | 0 | 0 | 522,900 | 0 | 0 | 522,900 |
| 54 MLS Tara 20 Wet Well Rehabilitation (WW01242 / Requested) | 0 | 0 | 0 | 392,175 | 0 | 0 | 0 | 0 | 392,175 |
| 55 MLS Tideview 4 Emergency Generator Replacement (WW01243 / Requested) | 0 | 0 | 0 | 457,750 | 0 | 0 | 0 | 0 | 457,750 |
| 56 MLS Tideview 4 Rehabilitation (6060784 / Existing) | 0 | 720,000 | 0 | 0 | 0 | 0 | 0 | 0 | 720,000 |
| 57 Trailer Estates Sewer Rehabilitation Phase III (6018081 / Existing) | 167,751 | 431,000 | 0 | 0 | 0 | 0 | 0 | 0 | 431,000 |
| Wastewater Restore/Rehab | 4,421,685 | 11,023,939 | 17,090,550 | 23,465,425 | 5,418,250 | 4,568,700 | 5,000,000 | 0 | 66,566,864 |

MANATEE COUNTY GOVERNMENT
Fiscal Year 2015 - 2019 Capital Improvement Program
Uses of Funds by Project and Category

| Wastewater | Actual | Budget | FY2015 | FY2016 | FY2017 | FY2018 | FY2019 | Future | Total Budget |
|--|----------------|----------------|------------------|----------|----------|----------|----------|----------|------------------|
| Wastewater Transportation Related | | | | | | | | | |
| 58 15th Street East at 301 Boulevard from US 41 to 53rd Avenue East - Sewer (6029980 / Existing) | 8,956 | 44,066 | 0 | 0 | 0 | 0 | 0 | 0 | 44,066 |
| 59 45th Street East from 44th Avenue East/SR 70 - Sewer (6025682 / Existing) | 11,797 | 150,000 | 260,000 | 0 | 0 | 0 | 0 | 0 | 410,000 |
| 60 53rd Avenue West (43rd Street West to 75th Street West) Reclaimed Water (6082990 / Existing) | 0 | 0 | 650,000 | 0 | 0 | 0 | 0 | 0 | 650,000 |
| 61 9th Street East From 53rd Avenue East to 57th Avenue East - Sewer (6040480 / Existing) | 15,704 | 160,000 | 0 | 0 | 0 | 0 | 0 | 0 | 160,000 |
| 62 US 301 at Fort Hamer Road Intersection - Sewer (6061980 / Existing) | 77,899 | 160,000 | 0 | 0 | 0 | 0 | 0 | 0 | 160,000 |
| 63 US 301 at Ft Hamer Road - Reclaimed (WW01260 / Existing) | 0 | 0 | 157,800 | 0 | 0 | 0 | 0 | 0 | 157,800 |
| 64 US 301/CR 675 to Moccasin Wallow Road - Reclaimed (6085490 / Existing) | 0 | 439,943 | 0 | 0 | 0 | 0 | 0 | 0 | 439,943 |
| 65 US301/CR 675 to Moccasin Wallow Road - Sewer (6085480 / Existing) | 0 | 34,975 | 0 | 0 | 0 | 0 | 0 | 0 | 34,975 |
| Wastewater Transportation Related | 114,356 | 988,984 | 1,067,800 | 0 | 0 | 0 | 0 | 0 | 2,056,784 |

MANATEE COUNTY GOVERNMENT
Fiscal Year 2015 - 2019 Capital Improvement Program
Uses of Funds by Project and Category

| Wastewater | Actual | Budget | FY2015 | FY2016 | FY2017 | FY2018 | FY2019 | Future | Total Budget |
|---|-----------|-----------|-----------|-----------|-----------|-----------|-----------|--------|--------------|
| Wastewater Treatment | | | | | | | | | |
| 66 Deep Injection Well Booster Station (WW01222 / Requested) | 0 | 0 | 0 | 0 | 662,000 | 3,600,000 | 0 | 0 | 4,262,000 |
| 67 Manatee Agricultural Reclaimed System Chlorination at Southwest Water Reclamation Facility (WW01224 / Requested) | 0 | 0 | 84,000 | 481,000 | 0 | 0 | 0 | 0 | 565,000 |
| 68 Manatee Agricultural Reuse Supply - Erie Road Main Tie-In (WW00994 / Existing) | 0 | 0 | 311,000 | 1,730,000 | 0 | 0 | 0 | 0 | 2,041,000 |
| 69 Manatee Agricultural Reuse Supply - Management Improvements (6082091 / Existing) | 111,118 | 815,000 | 2,445,000 | 1,630,000 | 0 | 0 | 0 | 0 | 4,890,000 |
| 70 North Water Reclamation Facility 4th Belt Filter Press & BFP Automation (WW01244 / Requested) | 0 | 0 | 0 | 0 | 0 | 347,000 | 2,000,000 | 0 | 2,347,000 |
| 71 North Water Reclamation Facility Automatic Backwash Filter Rehabilitation (WW00956 / Existing) | 0 | 0 | 425,000 | 0 | 0 | 0 | 0 | 0 | 425,000 |
| 72 North Water Reclamation Facility Class V Recharge Wells (6079480 / Existing) | 1,022,169 | 4,497,719 | 4,500,000 | 0 | 0 | 0 | 0 | 0 | 8,997,719 |
| 73 North Water Reclamation Facility Equalization Tank (WW01026 / Existing) | 0 | 0 | 0 | 780,000 | 2,340,000 | 1,560,000 | 0 | 0 | 4,680,000 |
| 74 North Water Reclamation Facility Fiber Optics (6084900 / Existing) | 48,915 | 315,000 | 0 | 0 | 0 | 0 | 0 | 0 | 315,000 |
| 75 North Water Reclamation Facility Recharge Wells Pump Station (WW01116 / Existing) | 0 | 0 | 3,000,000 | 1,600,000 | 0 | 0 | 0 | 0 | 4,600,000 |
| 76 North Water Reclamation Facility Reclaimed Water Transmission Line (WW01117 / Existing) | 0 | 0 | 1,500,000 | 4,137,500 | 4,137,500 | 0 | 0 | 0 | 9,775,000 |
| 77 North Water Reclamation Facility Secondary Clarifier 1 & 2 Refurbishment (WW01246 / Requested) | 0 | 0 | 0 | 0 | 0 | 336,000 | 1,861,000 | 0 | 2,197,000 |
| 78 North Water Reclamation Facility Sludge Holding Improvements (6050581 / Existing) | 305,764 | 4,595,000 | 0 | 0 | 0 | 0 | 0 | 0 | 4,595,000 |

MANATEE COUNTY GOVERNMENT
Fiscal Year 2015 - 2019 Capital Improvement Program
Uses of Funds by Project and Category

| Wastewater | Actual | Budget | FY2015 | FY2016 | FY2017 | FY2018 | FY2019 | Future | Total Budget |
|--|-----------|-----------|-----------|-----------|--------|---------|---------|--------|--------------|
| 79 North Water Reclamation Facility South Chlorine Contact Chamber Refurbishment (WW01247 / Requested) | 0 | 0 | 0 | 0 | 0 | 82,000 | 469,000 | 0 | 551,000 |
| 80 Southeast Water Reclamation Facility 10 Million Gallon Storage Tanks and Interconnection (6084880 / Existing) | 416,808 | 2,140,000 | 2,700,000 | 2,821,000 | 0 | 0 | 0 | 0 | 7,661,000 |
| 81 Southeast Water Reclamation Facility Dedicated Reject Line (6083680 / Existing) | 86,410 | 1,235,000 | 360,000 | 0 | 0 | 0 | 0 | 0 | 1,595,000 |
| 82 Southeast Water Reclamation Facility Headworks Rehabilitation (6083380 / Existing) | 237,521 | 2,250,000 | 0 | 0 | 0 | 0 | 0 | 0 | 2,250,000 |
| 83 Southeast Water Reclamation Facility Internal Recycle Pumps (6083580 / Existing) | 119,461 | 2,710,000 | 0 | 0 | 0 | 0 | 0 | 0 | 2,710,000 |
| 84 Southeast Water Reclamation Facility Lake Filtering System (6073780 / Existing) | 4,783,256 | 5,815,000 | 730,000 | 0 | 0 | 0 | 0 | 0 | 6,545,000 |
| 85 Southeast Water Reclamation Facility Maintenance Building (6085080 / Existing) | 169,256 | 1,070,000 | 1,500,000 | 0 | 0 | 0 | 0 | 0 | 2,570,000 |
| 86 Southeast Water Reclamation Facility North Reject Pond Lining (WW00959 / Existing) | 0 | 0 | 200,000 | 1,000,000 | 0 | 0 | 0 | 0 | 1,200,000 |
| 87 Southeast Water Reclamation Facility Septage Receiving Station (6083480 / Existing) | 217,628 | 600,000 | 3,000,500 | 0 | 0 | 0 | 0 | 0 | 3,600,500 |
| 88 Southeast Water Reclamation Facility Sludge Holding Tank Improvements (6041981 / Existing) | 171,927 | 1,785,000 | 0 | 0 | 0 | 0 | 0 | 0 | 1,785,000 |
| 89 Southwest Water Reclamation Facility Automatic Backwash Filter Rehabilitation (6016681 / Existing) | 33,336 | 800,000 | 1,659,000 | 0 | 0 | 0 | 0 | 0 | 2,459,000 |
| 90 Southwest Water Reclamation Facility Belt Filter Press Electrical Rehabilitation & Monitoring (WW01251 / Requested) | 0 | 0 | 0 | 0 | 0 | 103,500 | 600,000 | 0 | 703,500 |

MANATEE COUNTY GOVERNMENT
Fiscal Year 2015 - 2019 Capital Improvement Program
Uses of Funds by Project and Category

| Wastewater | Actual | Budget | FY2015 | FY2016 | FY2017 | FY2018 | FY2019 | Future | Total Budget |
|---|-------------------|-------------------|-------------------|-------------------|------------------|-------------------|-------------------|----------|--------------------|
| 91 Southwest Water Reclamation Facility Chlorine Contact Chamber (WW01252 / Requested) | 0 | 0 | 0 | 0 | 0 | 172,000 | 980,000 | 0 | 1,152,000 |
| 92 Southwest Water Reclamation Facility Clarifier 3 and 4 Rehabilitation (6078981 / Existing) | 1,001,069 | 3,250,000 | 0 | 0 | 0 | 0 | 0 | 0 | 3,250,000 |
| 93 Southwest Water Reclamation Facility Effluent Storage Tank 2 (6036083 / Existing) | 7,502,136 | 7,801,526 | 0 | 0 | 0 | 0 | 0 | 0 | 7,801,526 |
| 94 Southwest Water Reclamation Facility Equalization System Rehabilitation (WW01254 / Requested) | 0 | 0 | 0 | 0 | 0 | 714,000 | 3,950,000 | 0 | 4,664,000 |
| 95 Southwest Water Reclamation Facility Headworks Rehabilitation (6036084 / Existing) | 539,344 | 1,160,000 | 0 | 0 | 0 | 0 | 0 | 0 | 1,160,000 |
| 96 Southwest Water Reclamation Facility Lake Filtration, North Pond Lining and Reject Pond (6079180 / Existing) | 13,761,284 | 15,716,544 | 0 | 0 | 0 | 0 | 0 | 0 | 15,716,544 |
| 97 Southwest Water Reclamation Facility New Headworks (WW01255 / Requested) | 0 | 0 | 0 | 0 | 2,000,000 | 6,000,000 | 4,600,000 | 0 | 12,600,000 |
| 98 Southwest Water Reclamation Facility Process Modifications for Nitrogen Removal (6079080 / Existing) | 4,444,913 | 9,018,929 | 5,000,000 | 3,000,000 | 0 | 0 | 0 | 0 | 17,018,929 |
| 99 Southwest Water Reclamation Facility Roof Over Sludge Trailer (6047281 / Existing) | 9,860 | 275,000 | 0 | 0 | 0 | 0 | 0 | 0 | 275,000 |
| 100 Utility Operation Warehouse, Collections, Lift Station and Office Complex (6019205 / Existing) | 3,099,422 | 3,500,000 | 0 | 0 | 0 | 0 | 0 | 0 | 3,500,000 |
| Wastewater Treatment | 38,081,597 | 69,349,718 | 27,414,500 | 17,179,500 | 9,139,500 | 12,914,500 | 14,460,000 | 0 | 150,457,718 |

Southwest County Wastewater Collection System Master Plan Update

**APPENDIX J – RECOMMENDED CIP PROJECT SUMMARY
FORMS**

MANATEE COUNTY GOVERNMENT

Wastewater Collection System Master Plan Fiscal Year 2016-2020 Proposed Capital Improvement Program

| | | | | | |
|---------------|------------------------|-----------|------|-----------|--|
| Project Type: | Wastewater Collections | Project # | SW-1 | Location: | Bayshore Yacht Basin (RTU 101) Lift Station Improvements |
| Status: | Initial Year: | | | | |

Comprehensive Plan Information

| Scope | Project Map |
|---|--|
| <p>Project includes new building, new pumps with variable frequency drives, 16-foot square wet well, and 800 LF of 16-inch force main. For simplicity, the future lift station was modeled in the same location as the existing lift station. The future force main is estimated to be 800 linear feet based on the new location (at the southeast corner of 26th Street West and South Radcliffe Place).</p> | <p>The map shows a residential area with streets including Wesley Dr, California St, Florida Bl, Ohio Ave, Minnesota Ave, and Marina Dr. A legend identifies symbols for Master Lift Station (blue triangle), Active Wet Well (RTU #) (black circle), Force Main (green line), Gravity Main (dashed orange line), Recommended Force Main Improvements (pink line), and Recommended Gravity Main Improvements (orange line). The project location is marked with a pink square labeled '101' at the intersection of 26th Street West and South Radcliffe Place. Other RTU locations are marked with black circles and labeled 484, 139, and 13.</p> |

| Rationale |
|-----------------------------------|
| To correct capacity deficiencies. |

| Schedule of Activities | | | Estimated Cost | | | | | | |
|-----------------------------------|------|----|----------------|--------|--------|--------|--------|-----------------|-----------------|
| Activity | From | To | FY2016 | FY2017 | FY2018 | FY2019 | FY2020 | Future | Total |
| Engineering | | | | | | | | | \$ - |
| Construction | | | | | | | | | \$ - |
| Project Management/Administration | | | | | | | | | \$ - |
| | | | | | | | | | \$ - |
| Total: | | | \$ - | \$ - | | \$ - | \$ - | \$ 3,500,000.00 | \$ 3,500,000.00 |

MANATEE COUNTY GOVERNMENT

Wastewater Collection System Master Plan Fiscal Year 2016-2020 Proposed Capital Improvement Program

| | | | | | |
|---------------|------------------------|-----------|------|-----------|---|
| Project Type: | Wastewater Collections | Project # | SW-2 | Location: | Lift Station 9-A (RTU 436) Improvements |
| Status: | Initial Year: | | | | |

Comprehensive Plan Information

| Scope | Project Map |
|-------|-------------|
|-------|-------------|

Upsize Lift Station 9-A (RTU 436) force main (approximately 6,060 feet) to 12-inch pipe and evaluate and upsize wet well. Cost estimate based on a 12-foot diameter wet well. Actual wet well sizing should be determined by project design engineer.

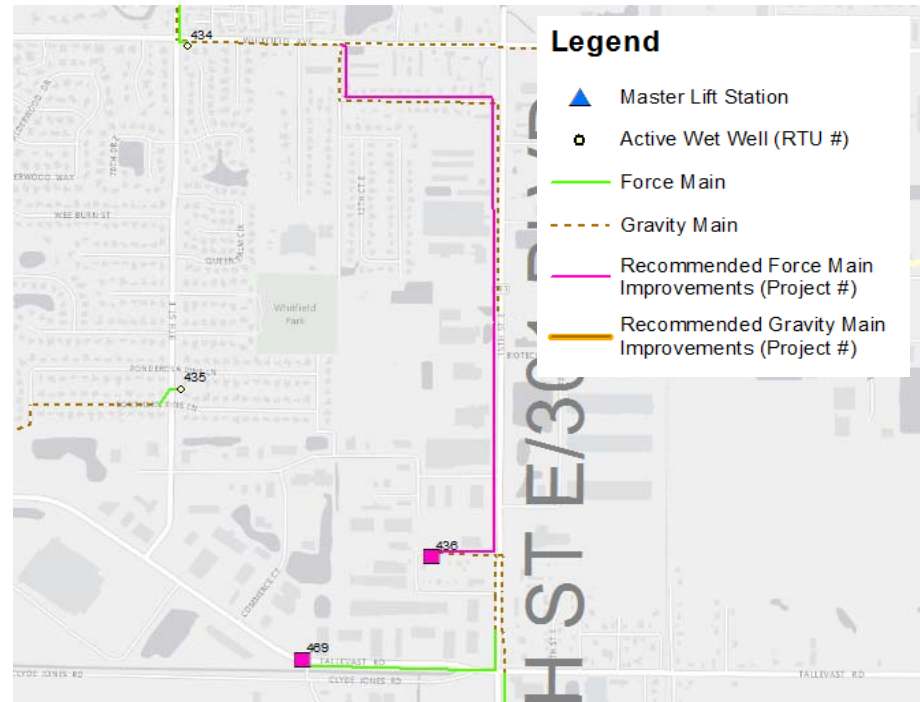

Rationale

To correct capacity deficiencies.

| Schedule of Activities | | | Estimated Cost | | | | | | |
|-----------------------------------|------|----|----------------|--------|--------|--------|--------|-----------------|-----------------|
| Activity | From | To | FY2016 | FY2017 | FY2018 | FY2019 | FY2020 | Future | Total |
| Engineering | | | | | | | | | \$ - |
| Construction | | | | | | | | | \$ - |
| Project Management/Administration | | | | | | | | | \$ - |
| | | | | | | | | | \$ - |
| Total: | | | \$ - | \$ - | | \$ - | \$ - | \$ 2,210,000.00 | \$ 2,210,000.00 |

MANATEE COUNTY GOVERNMENT

Wastewater Collection System Master Plan Fiscal Year 2016-2020 Proposed Capital Improvement Program

| | | | | | |
|---------------|------------------------|-----------|------|-----------|-----------------------------|
| Project Type: | Wastewater Collections | Project # | SW-3 | Location: | MLS #5 Force Main Extension |
| Status: | Initial Year: | | | | |

Comprehensive Plan Information

| Scope | Project Map |
|---|-------------|
| Extend MLS #5 (RTU 071) force main along Cortez Road to the MLS 1-M (RTU 203) wet well. | |
| <p align="center">Rationale</p> <p>To relieve capacity issues in the 24-inch gravity main on Cortez Road (upstream of MLS 1-M). Simulations of current and future conditions have shown that during wet weather this pipe is consistently surcharged (at maximum capacity) and has a high risk of causing overflows, preventing MLS 1-M from collecting the wastewater flow from MLS #5 and other tributary areas.</p> | |

| Schedule of Activities | | | Estimated Cost | | | | | | |
|-----------------------------------|------|----|----------------|--------|--------|--------|-----------------|--------|-----------------|
| Activity | From | To | FY2016 | FY2017 | FY2018 | FY2019 | FY2020 | Future | Total |
| Engineering | | | | | | | | | \$ - |
| Construction | | | | | | | | | \$ - |
| Project Management/Administration | | | | | | | | | \$ - |
| | | | | | | | | | \$ - |
| Total: | | | \$ - | \$ - | | \$ - | \$ 5,050,000.00 | | \$ 5,050,000.00 |

MANATEE COUNTY GOVERNMENT

Wastewater Collection System Master Plan Fiscal Year 2016-2020 Proposed Capital Improvement Program

| | | | | | |
|---------------|------------------------|-----------|------|-----------|---|
| Project Type: | Wastewater Collections | Project # | SW-4 | Location: | Force Main Connecting Lift Stations 2-A, 1-A, and 16-A to Collection System |
| Status: | Initial Year: | | | | |

Comprehensive Plan Information

Scope

Replacement of force main connecting Lift Stations 2-A, 1-A, and 16-A (RTUs 439, 135, and 440, respectively) to MLS 12-A influent gravity main. Project consists of replacing the existing pipeline with approximately 965 linear feet of 20-inch pipe.

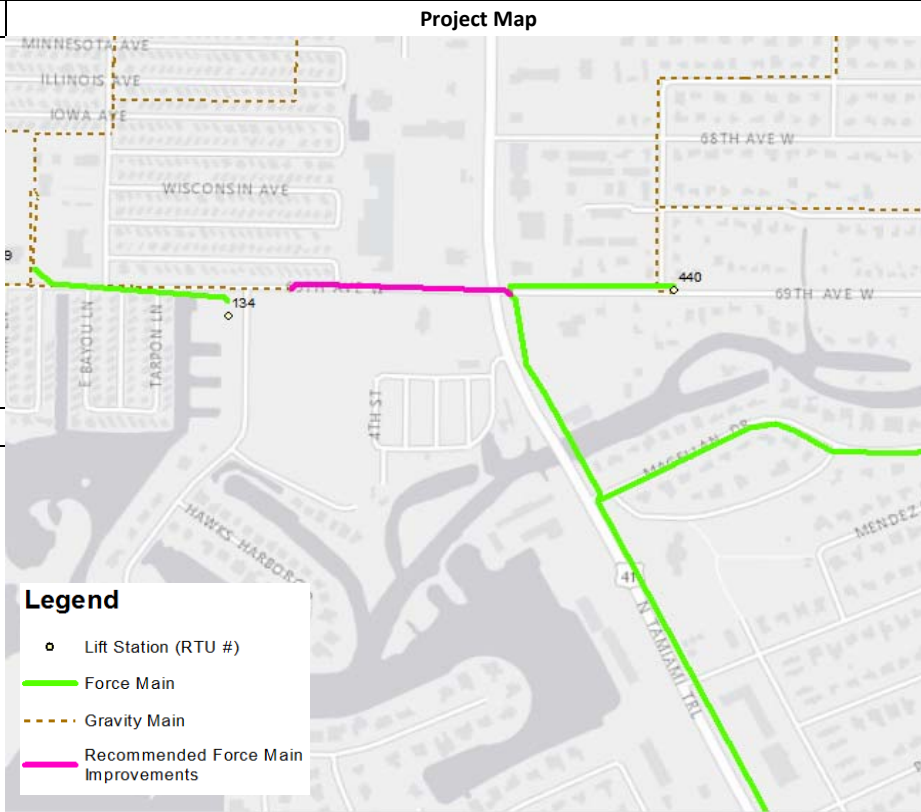

Rationale

Force main upsize due to high velocity.

| Schedule of Activities | | | Estimated Cost | | | | | | |
|-----------------------------------|------|----|----------------|--------|--------|--------|--------|---------------|---------------|
| Activity | From | To | FY2016 | FY2017 | FY2018 | FY2019 | FY2020 | Future | Total |
| Engineering | | | | | | | | | \$ - |
| Construction | | | | | | | | | \$ - |
| Project Management/Administration | | | | | | | | | \$ - |
| | | | | | | | | | \$ - |
| Total: | | | \$ - | \$ - | | \$ - | \$ - | \$ 480,000.00 | \$ 480,000.00 |

MANATEE COUNTY GOVERNMENT

Wastewater Collection System Master Plan Fiscal Year 2016-2020 Proposed Capital Improvement Program

| | | | | | |
|---------------|------------------------|-----------|------|-----------|--|
| Project Type: | Wastewater Collections | Project # | SW-5 | Location: | Upsize Lift Station 7-A (RTU 137) Force Main |
| Status: | Initial Year: | | | | |

Comprehensive Plan Information

| Scope | Project Map |
|--|---|
| Replace approximately 1,615 feet of 6-inch diameter force main with 8-inch diameter. | <p>Legend</p> <ul style="list-style-type: none"> ▲ Master Lift Station ○ Active Wet Well (RTU #) — Force Main --- Gravity Main — Recommended Force Main Improvements (Project #) — Recommended Gravity Main Improvements (Project #) |
| <p align="center">Rationale</p> <p>To accommodate additional flows from USF/Airport areas and prevent high velocity through force main.</p> | |

| Schedule of Activities | | | Estimated Cost | | | | | | |
|-----------------------------------|------|----|----------------|--------|--------|--------|--------|---------------|---------------|
| Activity | From | To | FY2016 | FY2017 | FY2018 | FY2019 | FY2020 | Future | Total |
| Engineering | | | | | | | | | \$ - |
| Construction | | | | | | | | | \$ - |
| Project Management/Administration | | | | | | | | | \$ - |
| | | | | | | | | | \$ - |
| Total: | | | \$ - | \$ - | | \$ - | \$ - | \$ 320,000.00 | \$ 320,000.00 |

MANATEE COUNTY GOVERNMENT

Wastewater Collection System Master Plan Fiscal Year 2016-2020 Proposed Capital Improvement Program

| | | | | | |
|---------------|------------------------|-----------|------|-----------|--|
| Project Type: | Wastewater Collections | Project # | SW-6 | Location: | Upsize Lift Station 6-A (RTU 136) Force Main |
| Status: | Initial Year: | | | | |

Comprehensive Plan Information

| Scope | Project Map |
|--|---|
| Replace approximately 1,902 feet of 8-inch pipe with 12-inch diameter. | <p>Legend</p> <ul style="list-style-type: none"> ▲ Master Lift Station ○ Active Wet Well (RTU #) — Force Main - - - Gravity Main — Recommended Force Main Improvements (Project #) — Recommended Gravity Main Improvements (Project #) |
| Rationale | |
| To prevent high velocity in force main and surcharging in upstream gravity system. | |

| Schedule of Activities | | | Estimated Cost | | | | | | |
|-----------------------------------|------|----|----------------|--------|--------|--------|--------|---------------|---------------|
| Activity | From | To | FY2016 | FY2017 | FY2018 | FY2019 | FY2020 | Future | Total |
| Engineering | | | | | | | | | \$ - |
| Construction | | | | | | | | | \$ - |
| Project Management/Administration | | | | | | | | | \$ - |
| | | | | | | | | | \$ - |
| Total: | | | \$ - | \$ - | | \$ - | \$ - | \$ 570,000.00 | \$ 570,000.00 |

MANATEE COUNTY GOVERNMENT

Wastewater Collection System Master Plan Fiscal Year 2016-2020 Proposed Capital Improvement Program

| | | | | | |
|---------------|------------------------|-----------|------|-----------|-------------------------------|
| Project Type: | Wastewater Collections | Project # | SW-7 | Location: | LS 36-A Influent Gravity Main |
| Status: | Initial Year: | | | | |

Comprehensive Plan Information

| Scope | Project Map |
|---|-------------|
| <p>Approximately 1,250 linear feet of 15-inch and 850 linear feet of 18-inch gravity main that connect 6,770 linear feet of force main to lift station 36-A (RTU 241) will be upsized to 21-inch and 24-inch, respectively. This segment experiences significant hydraulic challenges (a "bottleneck") when simulating flow from other lift stations.</p> | |

Rationale

To upsized the gravity mains that exceed capacity.

| Schedule of Activities | | | Estimated Cost | | | | | | |
|-----------------------------------|------|----|----------------|--------|--------|--------|--------|-----------------|-----------------|
| Activity | From | To | FY2016 | FY2017 | FY2018 | FY2019 | FY2020 | Future | Total |
| Engineering | | | | | | | | | \$ - |
| Construction | | | | | | | | | \$ - |
| Project Management/Administration | | | | | | | | | \$ - |
| | | | | | | | | | \$ - |
| Total: | | | \$ - | \$ - | | \$ - | \$ - | \$ 1,110,000.00 | \$ 1,110,000.00 |

MANATEE COUNTY GOVERNMENT

Wastewater Collection System Master Plan Fiscal Year 2016-2020 Proposed Capital Improvement Program

| | | | | | |
|---------------|------------------------|-----------|------|-----------|--------------------------------|
| Project Type: | Wastewater Collections | Project # | SW-8 | Location: | MLS 13-A Influent Gravity Main |
| Status: | Initial Year: | | | | |

Comprehensive Plan Information

Scope

Approximately 1,350 linear feet of existing 18-inch gravity main that connect 54,390 linear feet of force main (10.3 miles) to gravity just upstream of MLS 13-A (RTU 408) will be upsized to 24-inch. This segment was experiencing significant hydraulic challenges (a "bottleneck") when routing flow to the MLS.

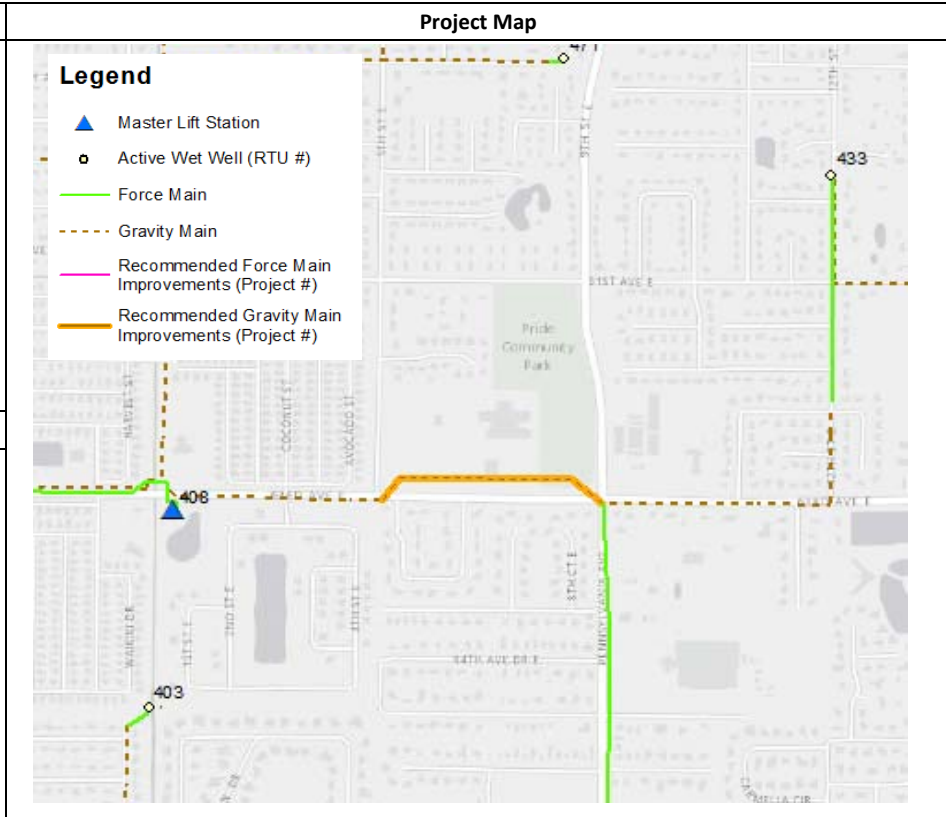

Rationale

To upsized the gravity mains that exceed capacity.

| Schedule of Activities | | | Estimated Cost | | | | | | |
|-----------------------------------|------|----|----------------|--------|--------|--------|--------|---------------|---------------|
| Activity | From | To | FY2016 | FY2017 | FY2018 | FY2019 | FY2020 | Future | Total |
| Engineering | | | | | | | | | \$ - |
| Construction | | | | | | | | | \$ - |
| Project Management/Administration | | | | | | | | | \$ - |
| | | | | | | | | | \$ - |
| Total: | | | \$ - | \$ - | | \$ - | \$ - | \$ 810,000.00 | \$ 810,000.00 |

MANATEE COUNTY GOVERNMENT

Wastewater Collection System Master Plan Fiscal Year 2016-2020 Proposed Capital Improvement Program

| | | | | | |
|---------------|------------------------|-----------|------|-----------|--|
| Project Type: | Wastewater Collections | Project # | SW-9 | Location: | Force Main Connecting Lift Stations 2-A and 1-A (RTUs 439 and 435) |
| Status: | Initial Year: | | | | |

Comprehensive Plan Information

| |
|--|
| Scope |
| Upsize the 1,027 linear feet force main that serves as a confluence for Lift Stations 1-A and 2-A (RTU 135 and RTU 439, respectively) from 14-inch to 16-inch. |

| |
|---|
| Rationale |
| Force main upsize due to high velocity. |

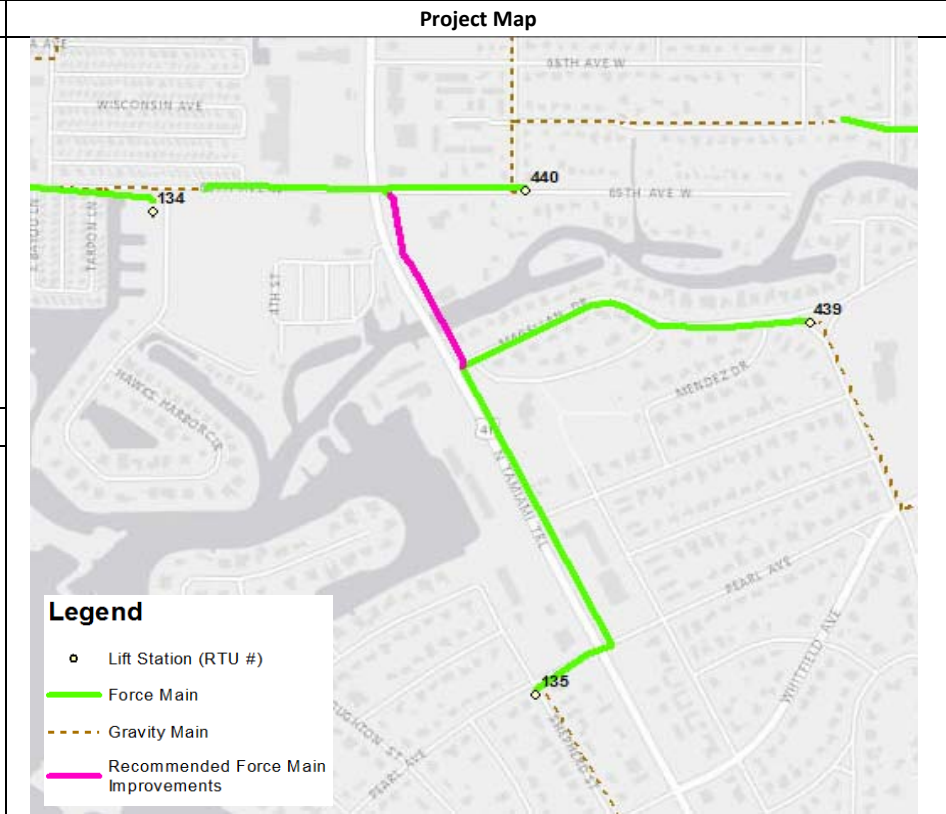

| Schedule of Activities | | | Estimated Cost | | | | | | |
|-----------------------------------|------|----|----------------|--------|--------|--------|--------|---------------|---------------|
| Activity | From | To | FY2016 | FY2017 | FY2018 | FY2019 | FY2020 | Future | Total |
| Engineering | | | | | | | | | \$ - |
| Construction | | | | | | | | | \$ - |
| Project Management/Administration | | | | | | | | | \$ - |
| | | | | | | | | | \$ - |
| Total: | | | \$ - | \$ - | | \$ - | \$ - | \$ 410,000.00 | \$ 410,000.00 |

MANATEE COUNTY GOVERNMENT

Wastewater Collection System Master Plan Fiscal Year 2016-2020 Proposed Capital Improvement Program

| | | | | | |
|---------------|------------------------|-----------|-------|-----------|--|
| Project Type: | Wastewater Collections | Project # | SW-10 | Location: | Gravity Main Improvement Upstream of MLS 1-M |
| Status: | Initial Year: | | | | |

Comprehensive Plan Information

| Scope | Project Map |
|---|-------------|
| Replace approximately 1,061 feet of 8-inch diameter gravity pipe with 12-inch diameter. | |
| <p align="center">Rationale</p> <p>To upsize the gravity mains that exceed capacity.</p> | |

| Schedule of Activities | | | Estimated Cost | | | | | | |
|-----------------------------------|------|----|----------------|--------|--------|--------|--------|---------------|---------------|
| Activity | From | To | FY2016 | FY2017 | FY2018 | FY2019 | FY2020 | Future | Total |
| Engineering | | | | | | | | | \$ - |
| Construction | | | | | | | | | \$ - |
| Project Management/Administration | | | | | | | | | \$ - |
| | | | | | | | | | \$ - |
| Total: | | | \$ - | \$ - | | \$ - | \$ - | \$ 320,000.00 | \$ 320,000.00 |

MANATEE COUNTY GOVERNMENT

Wastewater Collection System Master Plan Fiscal Year 2016-2020 Proposed Capital Improvement Program

| | | | | | | | | | |
|---------------|------------------------|---------------|-----------|-------|-----------|--------------------------|--|--|--|
| Project Type: | Wastewater Collections | | Project # | SW-11 | Location: | Pump Replacement Project | | | |
| Status: | | Initial Year: | | | | | | | |

Comprehensive Plan Information

| | | | | | | | | | |
|--------------|--|--|--------------------|--|--|--|--|--|--|
| Scope | | | Project Map | | | | | | |
|--------------|--|--|--------------------|--|--|--|--|--|--|

Replace pumps at the following lift station RTUs:

| RTU | HP | Number of Pumps |
|-----|----|-----------------|
| 136 | 15 | 2 |
| 457 | 10 | 2 |

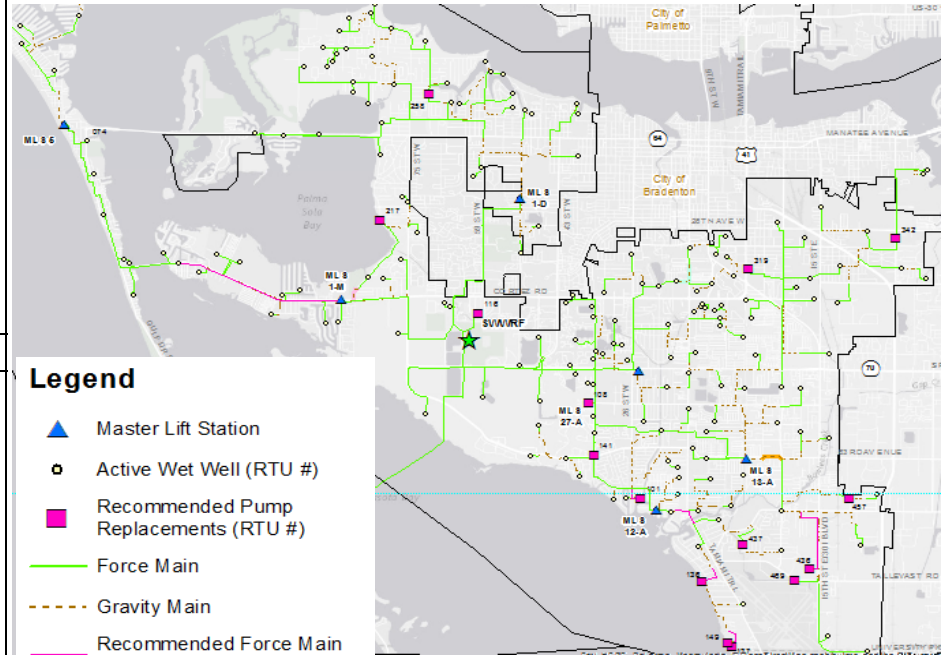

Legend

- ▲ Master Lift Station
- Active Wet Well (RTU #)
- Recommended Pump Replacements (RTU #)
- Force Main
- - - Gravity Main
- Recommended Force Main Improvements (Project #)
- Recommended Gravity Main Improvements (Project #)

| Schedule of Activities | | | Estimated Cost | | | | | | |
|-----------------------------------|------|----|----------------|--------|--------|--------|--------|--------------|--------------|
| Activity | From | To | FY2016 | FY2017 | FY2018 | FY2019 | FY2020 | Future | Total |
| Engineering | | | | | | | | | \$ - |
| Construction | | | | | | | | | \$ - |
| Project Management/Administration | | | | | | | | | \$ - |
| Total: | | | \$ - | \$ - | | \$ - | \$ - | \$ 80,000.00 | \$ 80,000.00 |

MANATEE COUNTY GOVERNMENT

Wastewater Collection System Master Plan Fiscal Year 2016-2020 Proposed Capital Improvement Program

| | | | | | | |
|---------------|------------------------|--|-----------|-------|-----------|--------------------------|
| Project Type: | Wastewater Collections | | Project # | SW-12 | Location: | Pump Replacement Project |
| Status: | Initial Year: | | | | | |

Comprehensive Plan Information

| Scope | | |
|---|----|-----------------|
| Replace pumps at the following lift station RTUs: | | |
| RTU | HP | Number of Pumps |
| 217 | 15 | 2 |
| 437 | 5 | 2 |

| Rationale |
|--|
| To prevent manhole overflows and surcharging in the upstream gravity system. |

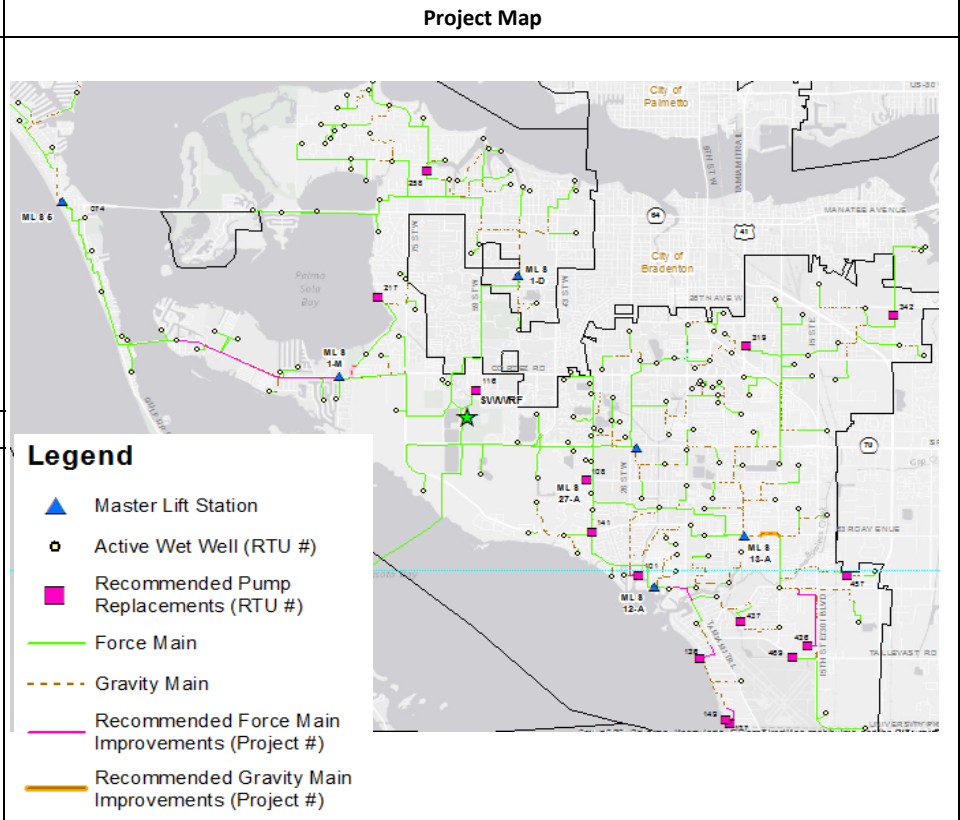

| Schedule of Activities | | | Estimated Cost | | | | | | |
|-----------------------------------|------|----|----------------|--------|--------|--------|--------|--------------|--------------|
| Activity | From | To | FY2016 | FY2017 | FY2018 | FY2019 | FY2020 | Future | Total |
| Engineering | | | | | | | | | \$ - |
| Construction | | | | | | | | | \$ - |
| Project Management/Administration | | | | | | | | | \$ - |
| | | | | | | | | | \$ - |
| Total: | | | \$ - | \$ - | | \$ - | \$ - | \$ 70,000.00 | \$ 70,000.00 |

MANATEE COUNTY GOVERNMENT

Wastewater Collection System Master Plan Fiscal Year 2016-2020 Proposed Capital Improvement Program

| | | | | | |
|---------------|------------------------|-----------|-------|-----------|--------------------------|
| Project Type: | Wastewater Collections | Project # | SW-13 | Location: | Pump Replacement Project |
| Status: | Initial Year: | | | | |

Comprehensive Plan Information

Scope

Replace pumps at the following lift station RTUs:

| RTU | HP | Number of Pumps |
|-----|----|-----------------|
| 217 | 5 | 2 |
| 437 | 2 | 2 |
| 436 | 40 | 2 |

Rationale

To accommodate additional flows from USF/Airport areas.

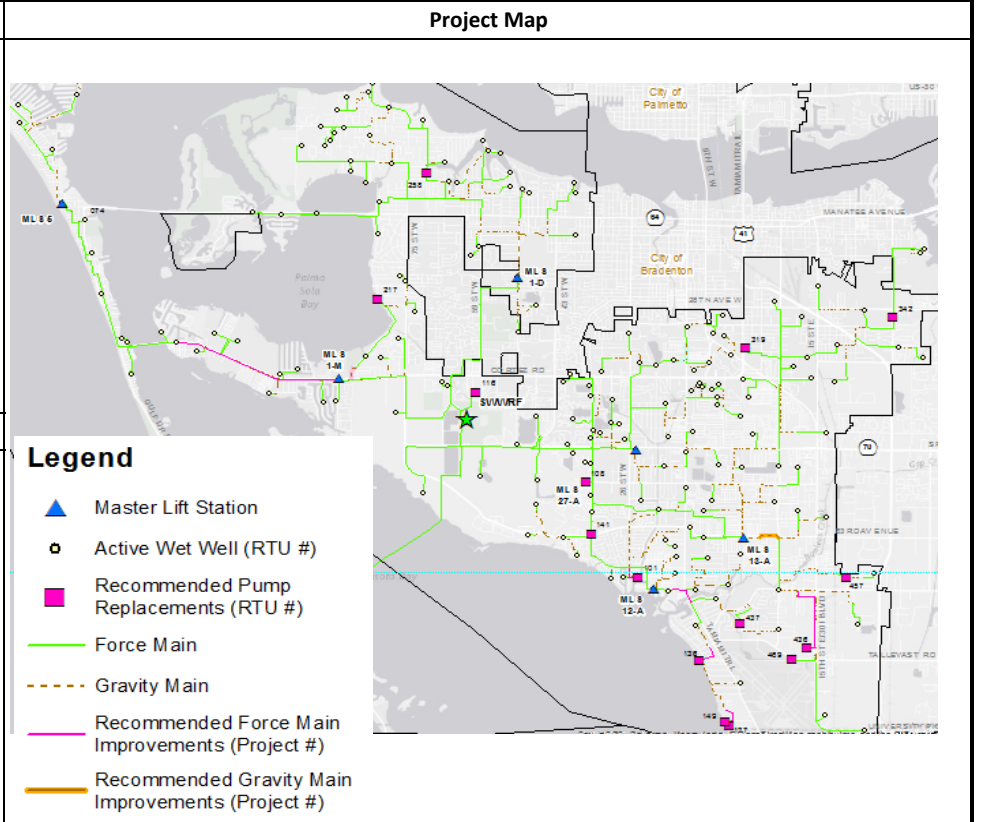

| Schedule of Activities | | | Estimated Cost | | | | | | |
|-----------------------------------|------|----|----------------|--------|--------|--------|--------|---------------|---------------|
| Activity | From | To | FY2016 | FY2017 | FY2018 | FY2019 | FY2020 | Future | Total |
| Engineering | | | | | | | | | \$ - |
| Construction | | | | | | | | | \$ - |
| Project Management/Administration | | | | | | | | | \$ - |
| Total: | | | \$ - | \$ - | | \$ - | \$ - | \$ 110,000.00 | \$ 110,000.00 |

MANATEE COUNTY GOVERNMENT

Wastewater Collection System Master Plan Fiscal Year 2016-2020 Proposed Capital Improvement Program

| | | | | | | |
|---------------|------------------------|---------------|-----------|-------|-----------|--------------------------|
| Project Type: | Wastewater Collections | | Project # | SW-14 | Location: | Pump Replacement Project |
| Status: | | Initial Year: | | | | |

Comprehensive Plan Information

| Scope | | | Project Map | |
|---|----|-----------------|---|--|
| Replace pumps at the following lift station RTUs: | | | | |
| RTU | HP | Number of Pumps | | |
| 108 | 15 | 2 | | |
| 116 | 20 | 2 | | |
| 141 | 15 | 2 | | |
| 258 | 2 | 2 | | |
| 319 | 15 | 2 | | |
| 342 | 30 | 2 | | |
| Rationale | | | <p>Legend</p> <ul style="list-style-type: none"> ▲ Master Lift Station ○ Active Wet Well (RTU #) ■ Recommended Pump Replacements (RTU #) — Force Main - - - Gravity Main — Recommended Force Main Improvements (Project #) — Recommended Gravity Main Improvements (Project #) | |
| To accommodate additional flows from USF/Airport areas. | | | | |

| Schedule of Activities | | | Estimated Cost | | | | | | |
|-----------------------------------|------|----|----------------|--------|--------|--------|--------|---------------|---------------|
| Activity | From | To | FY2016 | FY2017 | FY2018 | FY2019 | FY2020 | Future | Total |
| Engineering | | | | | | | | | \$ - |
| Construction | | | | | | | | | \$ - |
| Project Management/Administration | | | | | | | | | \$ - |
| | | | | | | | | | \$ - |
| Total: | | | \$ - | \$ - | | \$ - | \$ - | \$ 240,000.00 | \$ 240,000.00 |

MANATEE COUNTY GOVERNMENT

Wastewater Collection System Master Plan Fiscal Year 2016-2020 Proposed Capital Improvement Program

| | | | | | | |
|---------------|------------------------|--|-----------|-------|-----------|--------------------------|
| Project Type: | Wastewater Collections | | Project # | SW-15 | Location: | Pump Replacement Project |
| Status: | Initial Year: | | | | | |

Comprehensive Plan Information

| Scope | | |
|---|----|-----------------|
| Replace pumps at the following lift station RTUs: | | |
| RTU | HP | Number of Pumps |
| 469 | 2 | 2 |

| Rationale |
|---|
| To accommodate additional flows from USF/Airport areas. |

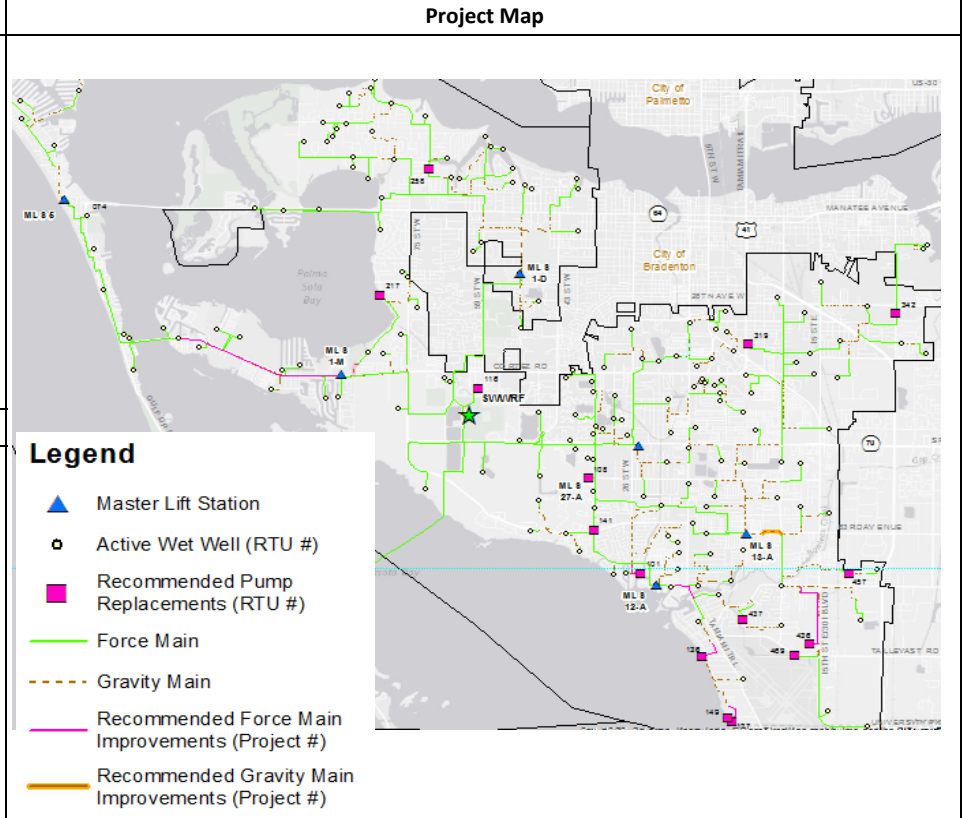

| Schedule of Activities | | | Estimated Cost | | | | | | |
|-----------------------------------|------|----|----------------|--------|--------|--------|--------|--------------|--------------|
| Activity | From | To | FY2016 | FY2017 | FY2018 | FY2019 | FY2020 | Future | Total |
| Engineering | | | | | | | | | \$ - |
| Construction | | | | | | | | | \$ - |
| Project Management/Administration | | | | | | | | | \$ - |
| | | | | | | | | | \$ - |
| Total: | | | \$ - | \$ - | | \$ - | \$ - | \$ 30,000.00 | \$ 30,000.00 |

Southwest County Wastewater Collection System Master Plan Update

**APPENDIX K – RESULTS OF THE EVALUATIONS OF
CURRENT CIP PROJECTS AS PLANNED
BY THE COUNTY**

FY 2015-2019 CIP Projects Evaluation
Southwest WWCS Service Area
Manatee County

The following CIP projects are currently part of the adopted FY 2015-2019 CIP. These projects were evaluated using the updated hydraulic model to determine if any potential modifications should be made to the projects. Recommendations were issued to the County ahead of the Master Plan report submission. These projects are either in design or planned for near future design. None have been constructed to date.

The following color scale was applied to the tables below where velocities of the pipe segments are shown:

| Velocity Range (fps) | Color |
|-----------------------------|--------------|
| Less than 2 | Blue |
| 2 - 6 | Green |
| Above 6 | Yellow |

1. Force Main MLS #5 Rehabilitation:

Description of Current FY 2015-2019 CIP Project: Replacement of approximately 12,000 linear feet of 20-inch ductile iron pipe with 24-inch high-density polyethylene (HDPE) force main.

Additional facts:

- The 12,000 feet include three force main segments. The first segment runs from MLS #5 to Lift Station 2-C (RTU 057). The second segment starts at the latter and ends at the discharge from Lift Station 1-C (RTU 056). The third segment ends right before the crossing of Sarasota Bay begins.
- The GIS database showed the existing force main as 18-inch DIP. The County confirmed that the force main is 18 inches, which means that the project, as planned by the County, included the upsizing of the force main.

Evaluations:

After running the model with the latest data/peaking factors, Carollo presented the County with three options:

- 1) Option 1: CIP as currently planned by County (24-inch).
- 2) Option 2: 16-inch for the first 2 segments, and 12-inch for the third segment.
- 3) Option 3: 18-inch for the first 2 segments, and 16-inch for the third segment.

While Option 2 meets the County's velocity performance criteria of 2-6 fps, the County may be more comfortable with the slightly larger size and resulting lower velocities of Option 3. Option 3 fits better within the performance range for the slight increase in cost. Option 3 still includes substantial savings by decreasing from the originally planned 24-inch pipe, as shown in Chapter 7.

| <u>MLS 5</u> | Length (feet) | Maximum Velocities (fps) | | | | | | | | | | | |
|--------------|---------------|--------------------------|----------|--------|--------|----------|----------|--------|--------|----------|----------|--------|--------|
| | | Option 1 | | | | Option 2 | | | | Option 3 | | | |
| | | 2020 LOS | 2020 Wet | BO LOS | BO Wet | 2020 LOS | 2020 Wet | BO LOS | BO Wet | 2020 LOS | 2020 Wet | BO LOS | BO Wet |
| FM Segment 1 | 8,781 | 1.22 | 1.94 | 1.2 | 1.91 | 3.91 | 5.61 | 5.85 | 5.7 | 2.85 | 4.24 | 2.95 | 4.25 |
| FM Segment 2 | 3,465 | 1.43 | 2.54 | 1.3 | 2.53 | 4.09 | 5.09 | 5 | 5.06 | 3.39 | 4.17 | 3.39 | 4.11 |
| FM Segment 3 | 1,311 | 1.45 | 2.57 | 1.43 | 2.61 | 4.08 | 5.25 | 5.01 | 5.15 | 3.4 | 4.4 | 3.4 | 4.25 |

2. Force Main MLS 1-M Rehabilitation

Description of Current FY 2015-2019 CIP Project: The CIP calls for the replacement of approximately 8,700 linear feet of 24-inch and 3,200 linear feet of 30-inch ductile iron pipe force main with 27-inch and 36-inch HDPE force main.

Additional Facts:

This project evaluation was split into two parts:

- Replacing/rerouting approximately 8,700 LF of 24-inch force main from MLS 1-M to the SWWRF (Segments 1, 2, and 3).
- Replacing the 30-inch force main along 66th Avenue from Cortez Road to the SWWRF (Segments 4, 5, and 6). This corresponds to the force main downstream of the current point of confluence of the MLS 1-D and 1-M force mains. After the planned reroute of the MLS 1-M force main, this pipe will no longer have to carry flow from both MLS (rather, only from MLS 1-D). Therefore, it is evaluated and described separately as Segments 4, 5, and 6.

Evaluations:

- 1) Option 1: Reroute and diameter of the first three segments as planned by the County (27-inch).
- 2) Option 2: Reroute as planned by the County, but diameter at 24-inch.

Simulations indicate that the design for the first three segments as planned by the County is appropriate and does not need to be revised.

| <u>MLS 1-M</u> <u>(Segments 1, 2,</u> <u>and 3)</u> | Length (feet) | Maximum Velocities (fps) | | | | | | | |
|---|------------------|--------------------------|----------|-----------|--------|----------|----------|-----------|--------|
| | | Option 1 | | | | Option 2 | | | |
| | | 2020 LOS | 2020 Wet | BO LOS | BO Wet | 2020 LOS | 2020 Wet | BO LOS | BO Wet |
| FM Segment 1 | 4,683 | 2.11 | 4.82 | 2.77 | 5.09 | 2.78 | 6 | 3.52 | 6.15 |
| FM Segment 2 | 3,108 | 2.12 | 4.81 | 2.78 | 5.1 | 2.78 | 5.95 | 3.56 | 6.14 |
| FM Segment 3 | 4,769 | 3.12 | 5.57 | 3.79 | 5.89 | 4 | 6.96 | 4.74 | 7.13 |

FM Segments 4, 5, and 6 (from MLS 1-D to SWWRF):

| | Length (feet) | Maximum Velocities (fps) | | | | | | | |
|--------------|------------------|---|----------|--------|--------|--|----------|--------|--------|
| | | As Currently Planned by County (36-inch HDPE) | | | | As Proposed (20-inch, 24-inch, and 36-inch for Segments 4, 5, and 6, respectively) | | | |
| | | 2020 LOS | 2020 Wet | BO LOS | BO Wet | 2020 LOS | 2020 Wet | BO LOS | BO Wet |
| FM Segment 4 | 900 | 0.85 | 1.18 | 1.01 | 1.29 | 2.69 | 3.67 | 3.20 | 3.99 |
| FM Segment 5 | 1,364 | 0.97 | 1.34 | 1.13 | 1.40 | 2.30 | 2.97 | 2.71 | 3.12 |
| FM Segment 6 | 977 | 1.16 | 1.47 | 1.32 | 1.55 | 2.72 | 4.06 | 3.29 | 4.70 |

3. Force Main MLS 1-D Rehabilitation:

Description of Current FY 2015-2019 CIP Project: The CIP calls for the replacement of up to 12,000 linear feet of 20-inch ductile iron pipe force main with 24-inch and 27-inch HDPE force main.

Evaluations:

- 1) Option 1: As planned by County (24-inch and 27-inch).
- 2) Option 2: Replace the existing pipe with 20-inch HDPE.

A 20-inch HDPE pipeline (Option 2) will result in optimal hydraulic conditions in the discharge force main of MLS 1-D under all scenarios through build-out. As such, the County may consider revising the existing design of the CIP from 24-inch and 27-inch HDPE to a 20-inch HDPE force main.

| <u>MLS 1-D</u> | Length (feet) | Maximum Velocities (fps) | | | | | | | |
|----------------|------------------|--------------------------|----------|-----------|--------|----------|----------|-----------|--------|
| | | Option 1 | | | | Option 2 | | | |
| | | 2020 LOS | 2020 Wet | BO LOS | BO Wet | 2020 LOS | 2020 Wet | BO LOS | BO Wet |
| FM Segment 1 | 4,637 | 1.77 | 2.47 | 2.04 | 2.68 | 2.51 | 3.48 | 2.88 | 3.78 |
| FM Segment 2 | 7,513 | 1.4 | 1.95 | 1.61 | 2.12 | 2.51 | 3.5 | 2.89 | 3.8 |

4. Force Main MLS 12-A Rehabilitation:

Description of Current FY 2015-2019 CIP Project: Replacement of the entire 20-inch DIP force main with 24-inch HDPE pipe.

Additional Facts:

- Bayshore Yatch Lift Station (RTU 101) connects after the first force main segment. Some deficiencies have been identified at this lift station. Any change made to the 27-A MLS force main alignment will affect the discharging head and pressure for Bayshore Yatch lift station. Therefore, this lift station should be evaluated once this CIP project is complete.
- Pump capacities at lift stations RTU 104, 106, 107, 108, 150, and 110 should be verified for compatibility with any major changes in the 27-A MLS force main alignment.

Evaluations:

1). Option 1: As planned by County (all 24-inch HDPE).

2). Option 2: Modification of pipeline diameters:

- 20-inch for Segment 1, which runs from MLS 12-A to the tie-in of LS 101.
- 24-inch for Segments 2-7, which run from the tie-in of LS 101 to the tie-in with the force main coming from MLS 13-A.

3). Option 3: Same as Option 2, but 27-inch for Segments 3-7, which run from the tie-in of LS 104 to the tie-in with the force main coming from MLS 13-A, instead of 24-inch.

Option 2 is recommended even though Segments 3-7 experience a velocity higher than 6 fps as shown in the table. Close observation throughout the 72-hour wet weather simulations show that these high velocities will only occur for a limited duration (no more than 2 hours), and therefore can be controlled by manual pump manipulation.

| MLS 12-A | Length (feet) | Maximum Velocities (fps) | | | | | | | | | | | |
|-----------------|---------------|--------------------------|----------|--------|--------|----------|----------|--------|--------|----------|----------|--------|--------|
| | | Option 1 | | | | Option 2 | | | | Option 3 | | | |
| | | 2020 LOS | 2020 Wet | BO LOS | BO Wet | 2020 LOS | 2020 Wet | BO LOS | BO Wet | 2020 LOS | 2020 Wet | BO LOS | BO Wet |
| FM Segment 1 | 3,393 | 1.18 | 3.44 | 1.3 | 3.52 | 1.8 | 4.88 | 2.05 | 5.1 | 1.74 | 4.89 | 2.01 | 4.99 |
| FM Segment 2 | 4,382 | 2.66 | 5.31 | 2.78 | 5.38 | 2.72 | 5.43 | 2.86 | 5.45 | 2.69 | 5.26 | 2.87 | 5.39 |
| FM Segments 3-7 | 2,522 | 3.91 | 6.39 | 4.07 | 6.34 | 3.93 | 6.33 | 4.18 | 6.34 | 3.22 | 5.08 | 3.3 | 5.07 |

5. Force Main MLS 13-A Rehabilitation

Description of Current FY 2015-2019 CIP Project: The CIP calls for the replacement of approximately 13,000 linear feet of 24-inch ductile iron pipe force main with 27-inch and 36-inch HDPE force main.

Additional Facts:

- The portion to be replaced with 27-inch is 97% of the length of the project (Segment 1).
- The portion that makes up the remaining 3% is currently 30-inch DIP (not 24-inch) and is called to be replaced with 36-inch HDPE (Segment 2).

Evaluations:

- 1). Option 1: As planned by the County (replace with 27- and 36-inch HDPE).
- 2). Option 2: Replace entire length (Segments 1 and 2) with 27-inch (don't upsize Segment 2).

The current plan and sizing for 13-A is correct, although we do not think it is necessary to upsize the last small segment of pipe. Since the flow in the small end segment is the same as the upstream segment, it is recommended that the diameter of the first 12,840 linear feet be extended to the full length of the project (Option 2).

| <u>MLS 13-A</u> | Length (feet) | Maximum Velocities (fps) | | | | | | | |
|-----------------|---------------|--------------------------|----------|--------|--------|----------|----------|--------|--------|
| | | Option 1 | | | | Option 2 | | | |
| | | 2020 LOS | 2020 Wet | BO LOS | BO Wet | 2020 LOS | 2020 Wet | BO LOS | BO Wet |
| FM Segment 1 | 12,950 | 3.06 | 4.01 | 3.74 | 4.35 | 3.06 | 4 | 3.74 | 4.34 |
| FM Segment 2 | 304 | 1.8 | 2.43 | 2.24 | 2.61 | | | | |

6. Force Main MLS 27-A Rehabilitation:

Description of Current FY 2015-2019 CIP Project: Replacement of approximately 3,200 linear feet of 20-inch ductile iron pipe force main with 24-inch high-density polyethylene (HDPE) force main.

Evaluations:

1) Option 1: As planned by County.

The CIP design was found consistent with all performance criteria and therefore it is recommended to proceed as currently planned by the County.

| <u>MLS 27-A</u> | Length (feet) | Maximum Velocities (fps) | | | |
|-----------------|------------------|--------------------------------|----------|--------|--------|
| | | As Currently Planned by County | | | |
| | | 2020 LOS | 2020 Wet | BO LOS | BO Wet |
| Segment 1 | 3,127 | 3.99 | 5.04 | 4.21 | 5.12 |

Other evaluated CIP projects recommended to proceed as planned by the County are:

- Force Main 27A - 53rd Avenue West from 43rd Street West to 75th Street West: Replacement of 30-inch DIP with 42-inch DIP.
- Lift Station 18-M (RTU 116) Rehabilitation: Replacement and reroute of approximately 3,000 linear feet of 6-inch ductile iron pipe force main with approximately 2,140 linear feet of 8-inch HDPE force main
- Lift Station 17-A (RTU 404) Force Main Reroute and Rehabilitation: Abandonment of 3,500 linear feet of 6-inch ductile iron pipe and reroute of the lift station discharge towards gravity tributary of MLS 13-A (RTU 408) using 1,600 linear feet of 6-inch PVC pipe
- Fiddler's Green Lift Station (RTU 250) Pumps Replacement: Pump replacement and force main reconnection

Other evaluated CIP projects with recommended changes to CIP:

- Lift Station 23-A (RTU 410) Force Main Rehabilitation: The CIP calls for the in-kind replacement of approximately 1300 linear feet of 6-inch ductile iron pipe. Carollo proposed and included in the model that the force main be replaced with 8-inch pipe rather than 6-inch, to comply with the velocity performance criteria.

In-kind replacements that were evaluated and are recommended to proceed as planned by the County are:

- 51st Street Gravity Main Sewer Replacement: In-kind replacement of approximately 3,300 linear feet of existing 30-inch gravity force main with 30-inch PVC pipe. Replace 11 manhole locations along the route from 8th Avenue to MLS 1-D, including reconnecting all laterals and associated appurtenances within the collection system.
- Lift Station 31-A (RTU 126) Force Main Renewal: In-kind replacement up to 2,750 linear feet of 14-inch cast iron pipe with PVC pipe.
- Spanish Park Lift Station (RTU 213) Force Main Renewal: In-kind replacement of 900 linear feet of 6-inch ductile iron pipe with PVC pipe.
- Windmill Village Lift Station (RTU 405) Force Main Renewal: In-kind replacement of up to 700 linear feet of 4-inch ductile iron pipe with PVC pipe.

HDPE Inner vs. Nominal Diameter:

The exact inner diameters of HDPE pipe depend on several parameters, such as fabrication method, the standard used in fabrication by each manufacturer, and the pressure rating. The numbers included in a design by external consultants may be from one manufacturer, or specified by the designer of the project, or actually measured from pipes in the field. The diameters used in the evaluation of the County's CIP projects came from the ANSI/ASME standards for HDPE for use in water, and follow the following relationship. It should be noted that while these specific CIP projects were evaluated using the associated internal diameter based on the County's CIP project description (when the CIP called for HDPE pipe), the Master Plan scenarios, model, and Master Plan submitted to the County are based on nominal diameter. The CIP projects should be evaluated in more detail by the design engineer for each project.

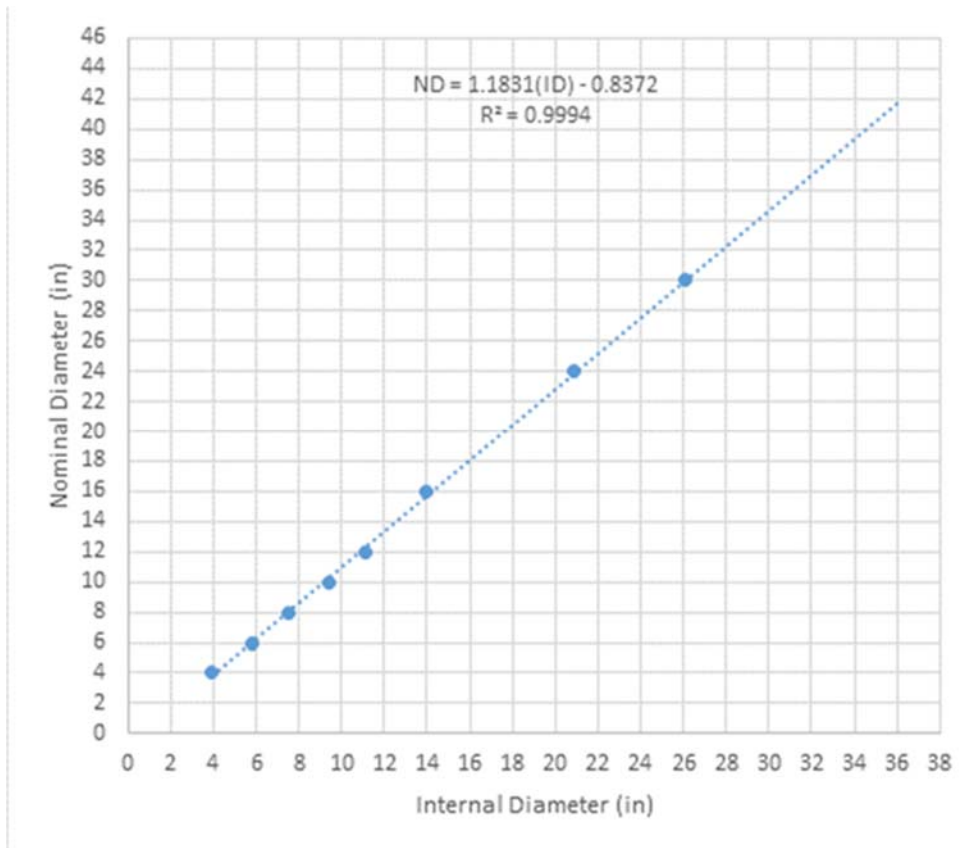

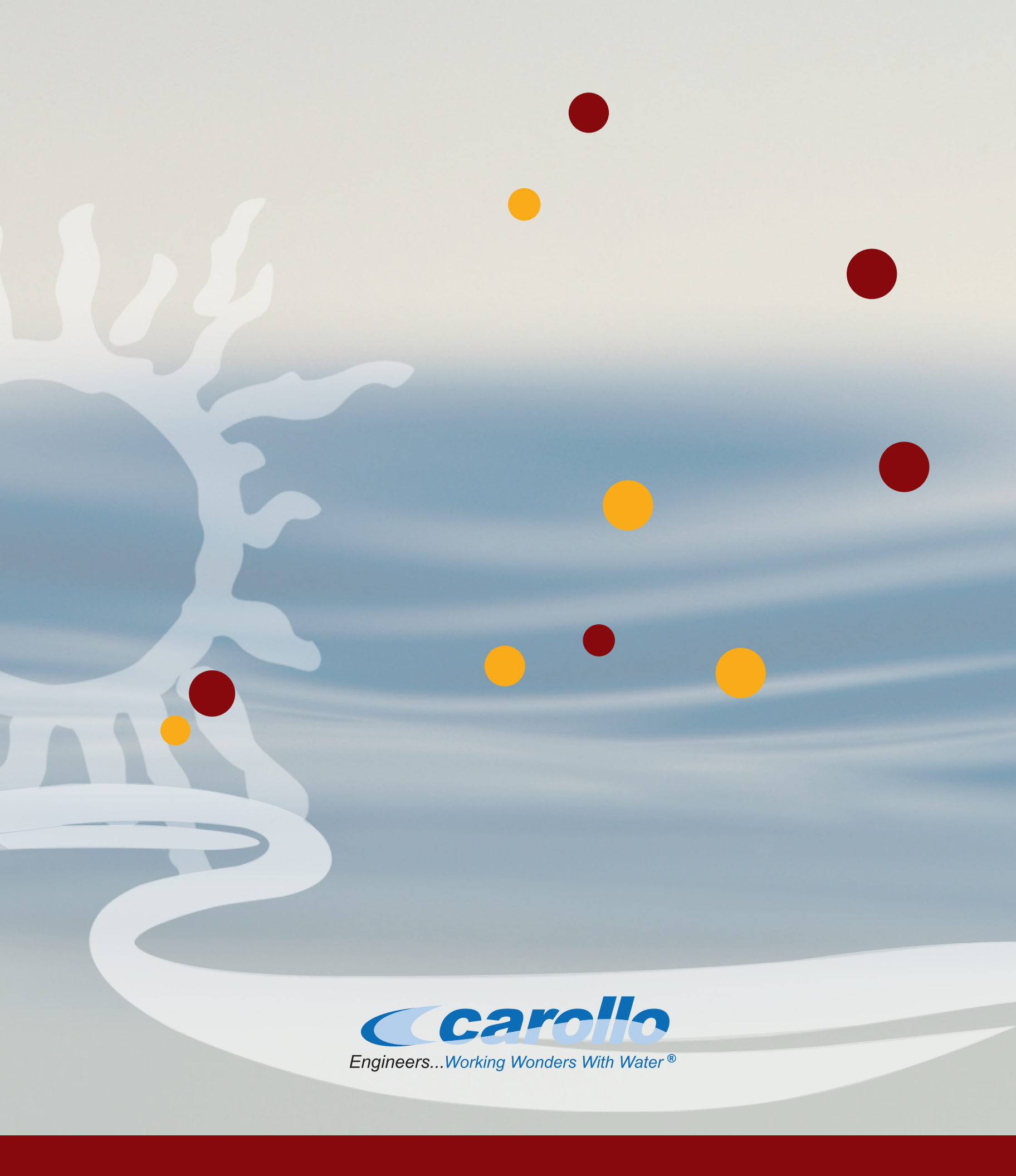

Engineers...Working Wonders With Water®