



1112 Manatee Avenue West
Bradenton, FL 34205
purchasing@mymanatee.org

Solicitation Addendum

Addendum No.: 1
Solicitation No.: 21-TA003841CD
Project No.: 6005685
Solicitation Title: Design-Build Services for Colony Cove Pipeline Replacements and Phase 1 Replacements
Addendum Date: January 3, 2022
Procurement Contact: Chris Daley, CPPO, CPPB- Procurement Project Manager

RFQ No. 21-TA003841CD is amended as set forth herein. Responses to questions posed by prospective proposers are provided below. This addendum is hereby incorporated in and made a part of RFQ No. 21-TA003841CD.

Change to:

ADVERTISEMENT, DATE, TIME AND PLACE DUE:

The Due Date and Time for submission of Proposals in response to this RFQ is ~~January 13, 2022~~ **February 1, 2022 by 3:00 P.M. ET.** Proposals must be delivered to the following location: Manatee County Administration Building, 1112 Manatee Ave. W., Suite 803, Bradenton, FL 34205 and time stamped by a Procurement representative by the Due Date and Time. Proposals will be opened immediately following the Due Date and Time at the Manatee County Administration Building, Suite 803.

Change to:

ADVERTISEMENT, DEADLINE FOR QUESTIONS AND CLARIFICATION REQUESTS:

The deadline to submit all questions, inquiries, or requests concerning interpretation, clarification or additional information pertaining to this Request for Qualifications to the Manatee County Procurement Division is ~~January 5, 2022~~ **January 18, 2022.** Questions and inquiries should be submitted via email to the Designated Procurement Contact shown below.

Change to:

INFORMATION FOR PROPOSERS, FIRST PARAGRAPH OF SECTION A.02 DUE DATE AND TIME:

The Due Date and Time for submission of Proposals in response to this Request for Qualifications (RFQ) is ~~January 13, 2022~~ **February 1, 2022 by 3:00 P.M. ET.** Proposals must be delivered to the following location: Manatee County Administration Building, 1112 Manatee Ave. W., Suite 803, Bradenton, FL 34205 prior to the Due Date and Time.

Change to:

INFORMATION FOR PROPOSERS, SECTION A.36 SOLICITATION SCHEDULE:

<u>Scheduled Item</u>	<u>Scheduled Date</u>
Non-Mandatory Information Conference	December 16, 2021 at 1:00 p.m.
Question and Clarification Deadline	January 5, 2022 <u>January 18, 2022</u>
Final Addendum Posted	January 6, 2022 <u>January 25, 2022</u>
Proposal Due Date and Time	January 13, 2022 <u>February 1, 2022</u> , by 3:00 p.m.
Technical Evaluation Meeting	January 31, 2022 <u>February 15, 2022</u>
Technical Evaluation Meeting	February 1, 2022 <u>February 16, 2022</u>
Interviews/Presentations/Demonstrations (if conducted)	February 7, 2022 <u>February 23, 2022</u>
Final Evaluation Meeting (if required)	February 8, 2022 <u>February 25, 2022</u>
Projected Award	March 2022 <u>April 2022</u>

Add:

EXHIBIT 10, PUBLIC WORKS STANDARDS – PART 1 UTILITIES STANDARDS MANUAL

Exhibit 10, Public Works Standards- Part 1 Utilities Standards Manual is issued with this Addendum No. 1 and hereby incorporated in and made part of the solicitation.

Add:

EXHIBIT 11, UTILITY APPROVED PRODUCTS LIST

Exhibit 11, Utility Approved Products List is issued with this Addendum No. 1 and hereby incorporated in and made part of the solicitation.

Add:

The following items are issued with this Addendum 1 for informational purposes only:

1. Attendance Record for Non-Mandatory Informational Conference held on December 16, 2021.
2. A non-mandatory informational conference with Equity Lifestyle Properties (ELS), to allow proposers to ask questions directly to ELS about their water system, has been scheduled as follows:
Date: Wednesday, January 12, 2022
Time: 10:00am
Location: Harmony Fitness Building, 8000 Lakeshore Dr. Ellenton Fl.

QUESTIONS AND RESPONSES:

Q1. In the RFQ's instructions for what to include in Tab 6. Respondent and Team's Experience, item 4. says to include a resume for key staff. May these resumes be included in an appendix at the end of Tab 6 and can they be omitted from the 20-page limit for Tab 6?

R1. No, the resumes are to be included in the page limits established. Proposers should submit resume information that is relevant to the project listed in the solicitation, and pages may be double-sided.

Q2. In the RFQ's instructions for what to include in Tab 8. Organizational Structure and Capacity, item 5. says to include an organizational diagram. May we submit this organizational diagram on 11" x 17" paper? This will be more legible for the review committee.

R2. Yes, this is acceptable.

Q3. In the RFQ's instructions for what to include in Tab 7, Approach, item 3. says to provide an implementation schedule for each component of services. May we submit a schedule using 11" x 17" paper? This will be more legible for the review committee.

R3. Yes, this is acceptable.

Q4. With many of our team members taking vacation time in conjunction with the Christmas and New Year's holidays at the end of the year, our team respectfully asks the County to consider a one to two-week extension on the proposal due date, so we have sufficient time to assemble a thorough response for the County for this important project.

R4. The Due Date has been changed with this Addendum 1.

Q5. Since the existing watermain is private and will not be taken over by Manatee County. What standards should be utilized to design and construct the watermain too?

R5. The watermain shall be designed and constructed using to meet all February 2020 Public Works Standards.

Q6. Does Manatee county own the roads within Colony Cove?

R6. No

Q7. Secondly, I would assume the roads would be designed and constructed to Manatee County Standards, please confirm.

R7. Yes, confirmed.

Q8. Does Manatee County own the storm system within Colony Cove?

R8. No.

Q9. Secondly, I would assume all storm drainage would be designed and constructed to FDOT standards, please confirm.

R9. Yes, confirmed.

Q10. Will easements and or right of ways will not be required as part of this project?

R10. ROW will not be needed. Easement will be needed.

NOTE:

Deleted items will be ~~struck through~~, added or modified items will be underlined. All other terms and conditions remain as stated in the RFQ.

INSTRUCTIONS:

Receipt of this addendum must be acknowledged as instructed in the solicitation document. Failure to acknowledge receipt of this Addendum may result in the response being deemed non-responsive.

END OF ADDENDUM

AUTHORIZED FOR RELEASE



PUBLIC WORKS STANDARDS

PART I. UTILITIES STANDARDS MANUAL

**Board Approved
FEBRUARY 25, 2020**

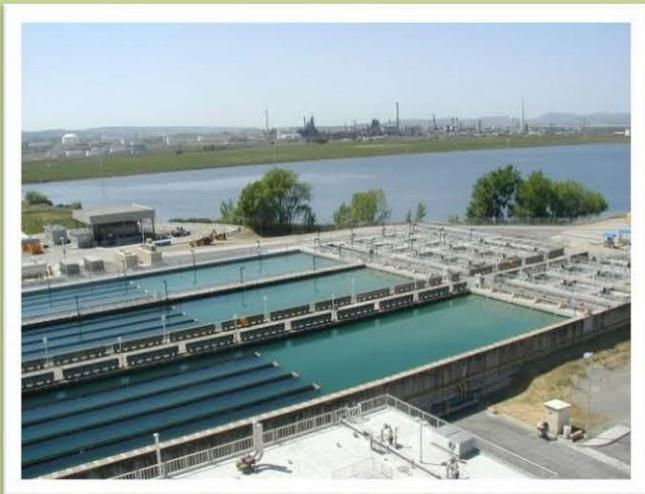



Public Works Standards

Part 1. Utilities Standards Manual

Board Approved
February 25, 2020

TABLE OF CONTENTS

Section 1.1	SITE DEVELOPMENT STANDARDS	1
1.1.1	Water.....	1
1.1.2	Sanitary Sewerage.....	1
1.1.3	Irrigation.....	2
1.1.4	Solid Waste Regulations.....	3
Section 1.2	MODIFICATIONS TO EXISTING STRUCTURES, PIPING AND EQUIPMENT	8
1.2.1	Description of Work	8
1.2.2	Products.....	8
1.2.3	General Modification Work.....	8
1.2.4	Connecting to Existing Piping and Equipment	9
1.2.5	Removal and Abandonment of Asbestos Cement Pipe and Appurtenances.....	9
1.2.6	In-Place Abandonment of Existing Pipe	10
1.2.7	Spray-Applied Liners.....	10
1.2.8	Connection to Existing Portland Concrete Manholes	11
1.2.9	Adjusting Existing Portland Concrete Manhole Frame and Cover	12
Section 1.3	TRENCHING AND EXCAVATION	13
1.3.1	Description of Work	13
1.3.2	Clearing and Grubbing.....	13
1.3.3	Dewatering	13
1.3.4	Protection of Existing Structures.....	13
1.3.5	Excavation	14
1.3.6	Backfill Materials	14
1.3.7	Backfill	15
1.3.8	Grading and Cleaning Up.....	16
Section 1.4	DUCTILE IRON PIPE AND FITTINGS.....	17
1.4.1	Description of Work	17
1.4.2	Products.....	17
1.4.3	Identification	18
Section 1.5	POLYETHYLENE (HDPE) PIPE AND FITTINGS.....	19
1.5.1	Description of Work	19
1.5.2	Products.....	19
1.5.3	Joints.....	19
1.5.4	Identification	19

Section 1.6	POLYVINYL CHLORIDE (PVC) PRESSURE PIPE.....	20
1.6.1	Description of Work.....	20
1.6.2	Products	20
1.6.3	Identification.....	21
Section 1.7	POLYVINYL CHLORIDE (PVC) GRAVITY SEWER PIPE.....	22
1.7.1	Description of Work.....	22
1.7.2	Products	22
1.7.3	Joining PVC Gravity Sewer Pipe and Fittings.....	22
1.7.4	Identification.....	22
Section 1.8	INSTALLATION OF PIPELINES	23
1.8.1	Required Easements	23
1.8.2	General.....	23
1.8.3	Handling and Storage.....	25
1.8.4	Cleaning	25
1.8.5	Installation	25
1.8.6	Pressure Taps	28
1.8.7	Final Flushing of Water Mains	29
1.8.8	Pipeline Alignments	29
1.8.9	Valve and Hydrant Placement	31
1.8.10	Minimum Pipe Flow Design Criteria	32
1.8.11	Detection	33
Section 1.9	TESTING AND INSPECTIONS.....	34
1.9.1	Description of Work.....	34
1.9.2	Field Visits	34
1.9.3	Pipeline Inspections	34
1.9.4	Compaction Testing	34
1.9.5	Materials Classification	34
1.9.6	Flow Tests	34
1.9.7	Hydrostatic Testing of Pressure Pipelines.....	35
1.9.8	Bacteriological Testing.....	37
1.9.9	Inspection of Precast Concrete Structures	37
1.9.10	Air Testing of Gravity Sewer Mains.....	37
1.9.11	Deflection Testing of Gravity Sewers (Mandrel Testing)	39
1.9.12	Television Inspection of Gravity Sewers	39
1.9.13	Lift Station Inspections	40

MANATEE COUNTY PUBLIC WORKS STANDARDS

PART 1 - UTILITY STANDARDS MANUAL

Section 1.10	CLEANING AND DISINFECTING WATER PIPELINES	42
1.10.1	Description of Work	42
1.10.2	Cleaning Water Mains	42
1.10.3	Disinfecting Potable Water PIPELINES	42
Section 1.11	VALVES AND APPURTENANCES.....	44
1.11.1	Description of Work	44
1.11.2	General Requirements	44
1.11.3	Directory.....	45
1.11.4	Gate Valves.....	45
1.11.5	Combination Pressure Reducing & Pressure Sustaining Valve with Check Valve Option.....	46
1.11.6	Ball Valves (see also general requirements)	46
1.11.7	Plug Valves.....	47
1.11.8	Valve Actuators and Torque Limiting Devices.....	48
1.11.9	Air Release Valves	51
1.11.10	Valve Boxes.....	51
1.11.11	Corporation Stops and Saddles (see also general requirements)	51
1.11.12	Plain End Couplings and Flanged Adapters	52
1.11.13	Hose Bibs	52
1.11.14	Swing Check Valves	52
1.11.15	Swing-Flex Check Valves (for water & reclaimed only)	53
1.11.16	Hydrants	53
1.11.17	Restrained Joints	54
1.11.18	Tapping Sleeves and Valves.....	54
1.11.19	Tracer Wire Boxes	55
1.11.20	Insertion Valve.....	55
Section 1.12	PRECAST PORTLAND CONCRETE MANHOLES AND WET WELLS	57
1.12.1	Description of Work	57
1.12.2	Precast Concrete Sections.....	57
1.12.3	Manhole Inverts	58
1.12.4	Resilient Pipe Connectors.....	58
1.12.5	Manhole and Wet well Joints.....	58
1.12.6	Manhole Rings and Covers	59
1.12.7	Manhole Inserts	59
1.12.8	Precast Concrete Manhole Installation	59
1.12.9	Setting Manhole Ring and Covers	59

1.12.10	Adjusting Manhole Cover	59
1.12.11	Spray-Applied Manhole Liners.....	60
1.12.12	Protection from Floodwater Inflow	60
Section 1.13	PRECAST POLYMER CONCRETE MANHOLES AND WET WELLS.....	61
1.13.1	Description of Work.....	61
1.13.2	Precast Concrete Sections	61
1.13.3	Manhole Inverts.....	63
1.13.4	Resilient Pipe Connectors	63
1.13.5	Grouting	64
1.13.6	Manhole and Wet well Joints	64
1.13.7	Manhole Rings and Covers	64
1.13.8	Setting Manhole Ring and Covers.....	64
1.13.9	Manhole Inserts	65
1.13.10	Polymer Concrete Structure Installation	65
1.13.11	Adjusting Manhole Cover	65
1.13.12	Backfill Procedures.....	65
1.13.13	Connections to Existing Polymer Concrete Manholes and Wet Wells	65
Section 1.14	LIFT STATIONS.....	66
1.14.1	Description of Work.....	66
1.14.2	Structures and Equipment	66
1.14.3	Electrical.....	70
1.14.4	Grinder Lift Stations.....	75
1.14.5	Flooding	77
1.14.6	Entrance Hatch Elevations	77
1.14.7	Water Service.....	77
1.14.8	Shop Drawings and Inspections	77
1.14.9	Required Easements	77
1.14.10	Siting	77
1.14.11	Landscaping and Irrigation.....	78
1.14.12	Accessibility and Security.....	80
1.14.13	Force Main Flow Meter.....	81
1.14.14	Auxiliary Backup Pump Set	81
1.14.15	Pump.....	82
1.14.16	Instrumentation and Control	82
1.14.17	Enclosure.....	83

MANATEE COUNTY PUBLIC WORKS STANDARDS

PART 1 - UTILITY STANDARDS MANUAL

1.14.18	Engine	84
1.14.19	Starting System - Engine.....	84
1.14.20	Fuel Supply System - Diesel Engine	85
1.14.21	Cooling System- Engine	86
1.14.22	Exhaust System- Engine.....	86
1.14.23	House Keeping Slab Foundation.....	86
1.14.24	Field Quality Control.....	87
1.14.25	Training and Demonstration	87
1.14.26	Notice of Delivery, Testing, Training and Demonstration	87
1.14.27	Record Drawing Requirements	87
Section 1.15	RECORD DRAWINGS – OFFICE/RETAIL/INDUSTRIAL SINGLE BUILDING & LOT	88
1.15.1	General Requirements	88
1.15.2	General	88
1.15.3	Requirements as to Form.....	88
1.15.4	Monumentation	89
1.15.5	Certifications	89
1.15.6	Record Information Within the Right-of-Way or Utility Easements	90
1.15.7	Record Information Outside of Right-of-Way or Utility Easements.....	92
1.15.8	Submittals.....	92
Section 1.16	RECORD DRAWINGS – ALL OTHERS	94
1.16.1	General	94
1.16.2	Requirements as to Form.....	94
1.16.3	Monumentation	95
1.16.4	Certifications	96
1.16.5	Record Information	96
1.16.6	Submittals.....	98
Section 1.17	APPENDIX	100

Note: Items not addressed by these standards shall provide a similar superior level of quality.

All items and/or materials furnished and installed shall conform to the Manatee County Utility Approved Products List (separate manual). If there is a conflict between this manual and the Utility Approved Products List, the Approved Products List shall take precedence.

MANATEE COUNTY PUBLIC WORKS STANDARDS MANUAL

PART 1 - UTILITY STANDARDS

SECTION 1.1 SITE DEVELOPMENT STANDARDS

This section 1.1 contains general standards for the construction of infrastructure in Manatee County. Subsequent sections contain more detailed standards. All improvements shall be subject to all the standards contained in this manual, including the Approved Product List (separate manual), and any Technical Bulletins issued.

1.1.1 WATER

- A. Individual private water distribution systems supplied by individual wells shall be constructed to facilitate independent connections to a public water distribution facility. All water wells constructed in Manatee County shall conform to Chapter 373 F.S., the requirements of the Southwest Florida Water Management District and the Manatee County Natural Resources Division, including all provisions in the interlocal agreement between Manatee County and the Southwest Florida Water Management District.
- B. The coordination and sharing of any water distribution system, excluding individual private well water supply systems, between developments shall be preferred, including installation of oversized facilities to serve a logical area. Such over sizing may be paid for, where appropriate, by the Utilities Department when designed to serve property other than that owned by the developers. All major water distribution lines provided by a developer, together with necessary easements for access and maintenance, shall be dedicated to Manatee County.
- C. All distribution water mains that enter private property become private mains and shall have a master meter and a certified backflow prevention assembly (BPA) installed at the right-of-way (property line) in accordance with Chapter 2-31, Article X of the Manatee County Code of Ordinances.

All distribution reclaimed water mains that enter private property become private mains and shall have a master meter installed at the right-of-way (property line).

- D. In the twenty-five (25) year and one hundred (100) year floodplain, all new and replacement water supply systems shall be located and designed to:
 - 1. Avoid impairment to the floodplain;
 - 2. Minimize contamination to the floodplain;
 - 3. Eliminate infiltration of flood waters; and
 - 4. Prevent contamination of the aquifers.
- E. All new construction, additions, including buried storage tanks, must be anchored as necessary to prevent flotation, collapse, or lateral movement of the structure.

1.1.2 SANITARY SEWERAGE

- A. General and individual sewerage systems including septic systems where allowed outside the defined EPA 201 service area or exempted by Chapter 2-31 of the Code of Ordinances and Resolution 89-70 shall be approved by the Manatee County Health Department, Environmental Health Services and the Public

Works Department. On-site sewerage systems shall be constructed in accordance with the Manatee County Health Department, Environmental Health Services regulations in such a manner as to facilitate later connection to a public collection facility including design and installation of septic systems so as to provide for eventual connection of this system to a public sewage collection system.

- B. The coordination and sharing of any portion of the sewerage system between developments shall be preferred, including installation of oversized facilities to serve a natural tributary area, with such oversizing paid for where appropriate, by the Manatee County Public Works Department when designed to serve property other than that owned by the developer. All major sewer collection lines provided by a developer, together with necessary easements for access and maintenance, shall be dedicated to Manatee County.
- C. All new and replacement sewerage and waste disposal systems located within the twenty-five (25) and one hundred (100) year floodplain, shall meet the requirements of Floodplain Management standards contained in this manual, the Stormwater Management Design Manual and the Land Development Code, and shall be located and designed to:
 - 1. Avoid impairment to the floodplain;
 - 2. Minimize contamination to the floodplain;
 - 3. Eliminate infiltration of flood waters; and
 - 4. prevent contamination of the aquifers.
- D. Additionally, all new parts of the system, including buried storage tanks, must be anchored as necessary to prevent flotation, collapse, or lateral movement.
- E. All industrial or commercial land uses which generate a wastewater load of a character not permitted for disposal in the County's system, shall be pretreated by the property owner and/or facility operator pursuant to Ordinance 88-01. This pretreatment shall occur prior to discharge of wastewater into any public or on-site sewage system.
- F. Lift Stations. All lift stations shall be landscaped in accordance with the Landscape & Irrigation requirements for Lift Stations of this Manual.

1.1.3 IRRIGATION.

- A. Irrigation shall be from a non-public water source. A suitable water supply is preferred to be reclaimed water, but is not limited to, lakes, ponds, stormwater retention areas, and wells. Design and use of wet stormwater facilities as sources of water for irrigation shall be required, as long as the use for irrigation does not adversely impact normal water levels in such a way that it impairs the viability of the biological treatment system. Suction lines from individual lots shall not be connected to or extend to sewer, stormwater drains, or catch basins to provide irrigation or non-potable water for any lot.
- B. The Department Director requires the use of drought resistant species and may specify operational schedules and practices for irrigation for water conservation. No water service shall be furnished to any person by a public or private utility or water well unless such person agrees to accept all the provisions of the Water Shortage Plan, the Water Shortage Emergency, and the Year-Round Water Conservation Measures. The acceptance of water service shall be in itself the acceptance of the above provisions. The use of reclaimed water or other alternative sources shall be required for sites located outside of the Watershed Overlay Districts and located in an area that either has the distribution system for reclaimed water or is programmed to have such system installed. Potable water shall not be used for landscape irrigation.

- C. Dual distribution systems for irrigation purposes may be required on all sites within an EPA 201 service area which are identified by the Department Director as being economically feasible for the Public Works Department to provide a connection to a public re-use water system at the periphery of the development. Such systems shall be connected to the approved reuse system when available. The determination of when the dual distribution system will be required will be made at the time the applicant submits the initial development application.
- D. Dual distribution systems with supplemental source or irrigation water is required, whenever a development covenant running with the land requires all lots to install irrigation systems.
- E. Dual distribution systems serving residential developments shall be installed in accordance with this manual.
- F. No private irrigation sprinkler line or sprinkler head shall be installed within the rights-of-way without the written approval of the Public Works Department. Sprinkler heads shall be installed so as not to distribute water onto the sidewalks and travel lanes or effect the safety of pedestrian and motorist's safety.
- G. All piping and outlets conveying re-use water shall be adequately and durably identified by a distinctive color coding so that it is readily distinguished from piping carrying potable water. The color coding shall comply with the American National Standards Institute ANSI Z53.1 and identified in accordance with ANSI A13.1.

1.1.4 SOLID WASTE REGULATIONS

- A. Purpose and Intent. These regulations are established to provide for the safe, efficient management of solid waste, the minimization of wastes generated, the recovery of recyclable materials and the reduction of wastes disposed of, in accordance with State and County mandates and regulations.
- B. Administration. The Utilities Department shall be responsible for the administration and enforcement of these regulations in conjunction with Chapter 2-16 Solid Waste and Recyclable Materials of the County Code of Ordinances and amendments thereto; and in coordination with Federal, State and other County and regulatory agencies.
- C. Construction Wastes.
 - 1. *Generation.* The applicant shall consider various waste management and waste minimization procedures to reduce the amount of wastes which will be generated during the construction phase of the proposed project. Waste materials are defined not only as those materials resulting directly from construction, but includes materials generated by construction crews during their occupation at the site.
 - 2. *Storage.* The applicant shall provide for approved temporary waste storage on the site. Any hazardous materials shall be stored and identified in appropriate containers as mandated by law and required by these Standards.
 - 3. *Transport.* The applicant shall remove all wastes from the site in an acceptable manner. Special wastes, including hazardous and biohazardous wastes, shall be delivered to approved processing site(s) for the specific waste involved. Construction and demolition material may be delivered to an approved recycling facility.
- D. Occupancy Wastes.
 - 1. *Storage.* The applicant shall make provisions for temporary on-site waste storage including the separate storage of all hazardous and biohazardous wastes in suitable containers on the site.

2. *Transport.* The applicant shall make arrangements with Manatee County Utilities Department to transport all waste generated to be transported to appropriate process and/or disposal sites.

E. Waste Storage Facilities.

1. All enclosures are to provide ample room for recycling containers per House Bill 7243 that became effective July 1, 2012.
2. Shopping centers and strip malls are to provide enclosures for the maximum number of stores and outbuildings the facility can accommodate.
3. Customers are responsible for keeping their dumpsters and enclosures clean.
4. Developers should be aware that additional monthly access fees could apply for certain ancillary services (Resolution 15-56).
5. All enclosures shall not be used for storage purposes. The enclosures shall only contain solid waste and recycling containers.
6. *Solid Waste and Recyclables Enclosure Requirements.* The County requires container storage and access in all new buildings in Manatee County. The Solid Waste and Recyclables enclosure information for a multi-family dwelling, commercial and industrial establishments requiring large containers, including but not limited to “dumpsters”, “compactors”, “roll off containers”, and “can enclosures” shall be specified within engineering drawings and specifications, and other written documentation submitted to the County required for site plan review. The submittal of the required materials shall be concurrent with the building permit application. Further specifications for each applicable large container is indicated in Sections 1.1.4.E.(7)-(10). Proposed future growth and phased development shall be considered in the site design with regard to sizing, location(s), and access of future solid waste and recyclables enclosures. Solid waste and recycling areas necessary for future growth shall be available for development, but need not be developed, nor enclosures constructed, until the future growth occurs.

Construction of enclosure(s) shall be completed prior to the issuance of a certificate of occupancy. Submittals to the County should include the minimum standards specified in the sections below:

- a. Drawings of solid waste and recyclables enclosure location(s) per scale on a site drawing as described in this section.
 - 1) Solid waste and recyclables enclosures must be placed in unobtrusive locations accessible by all collection vehicles. Parallel parked cars or other obstacles shall not prevent a collection vehicle from accessing containers.
 - 2) The siting for solid waste and recyclables enclosures and support pads shall not encroach upon a parking space, pedestrian walkway, landscaped area, fire lane, driveway entrance, public rights-of-way, visibility triangle, or easement. There must be a minimum of 16 feet of lateral clearance (width) in any narrow lane for a sufficient distance where a collection vehicle may drive through without obstruction. The turning radii for the collection vehicle at the solid waste and recyclables enclosure or support pad shall not encroach upon a parking space, pedestrian walkway, landscaped area, fire lane, driveway entrance, public rights-of-way, visibility triangle, or easement. For dumpsters, there needs to be a curb cut if containers are being moved from a sidewalk to the street for collection.
- b. Drawings delineating the ingress/ egress service pathway sufficient for the safe movement and travel of the solid waste and recyclables collection vehicles that will be used at the site. Vehicle

path analysis software showing the collection vehicle pathway specifications is required.

- 1) Collection vehicles picking up solid waste and recyclables must be able to exit the street or alley by driving forward (collection vehicles cannot back up out of a street or alley).
 - 2) Collection vehicles will require an adequate turning radius to enter the street or alley in order to access containers. A minimum turning radius of 45 feet must be maintained from the vehicular path or road to the collection location.
 - 3) The actual height clearance must allow for the safe and efficient access of the collection vehicle. A minimum 25-foot height clearance must be maintained within 25 feet of the enclosure. This allows overhead lifting of the container for servicing. The length of the unobstructed vehicular path from the gate of the enclosure must maintain a minimum 60-foot clearance.
 - 4) Utility wires and structure overhangs should have a minimum height clearance of 16 feet along the ingress and egress route. No utility wires shall extend over the enclosure approach and service area.
- c. Drawings containing enclosure construction specifications as described in this section.
- 1) Enclosure plans must specify that gates will open outwards a minimum of 130 degrees. A minimum entrance clearance of 10 feet per container is required for the safe and efficient access of collection vehicles. No obstructions within or outside of the gates shall prevent the gates from opening wide enough for clearance.
 - 2) The gate doors must be constructed with a pin stop mechanism that will provide a means of securing the gate doors in both an open and closed position. Locations of pin stops must be marked on drawings.
 - 3) Enclosures shall have two centered 4-inch diameter impact resistant bollards installed 1 ft from the interior walls of the enclosure area and 4 ft apart from each other to prevent damage to the walls. Impact resistant bollards shall have a minimum height of 5 ft not to exceed the height of the back-screen wall of the enclosure.
7. Dumpsters and Compactors, General. All multi-family and non-residential establishments of sufficient size shall require large containers, such as "dumpsters" and "compactors," for storing solid waste between collections. Because these large containers must be properly located and supported, the following minimum criteria shall be adhered to:
- a. *Support Pads.* All dumpsters and compactors shall be placed on concrete pads. All support pads shall be designed in accordance with detail US-14A, Compactor and Dumpster Pads.
 - b. *Siting.*
 - 1) No dumpster or compactor shall be located in the front yard of any lot. Exceptions may be made for corner lots where no reasonable alternative location is available, except that minimum district front yard setbacks shall be maintained.
 - 2) All dumpsters, support pads and associated screening shall be setback a minimum of ten (10) feet from side and rear lot lines. Support pads must be located to provide adequate maneuverability for the lift collection vehicle length of forty-five (45) feet and an additional forty-five (45) feet for backing and turning.
 - 3) Businesses that have canopies must provide direct access to the dumpsters no closer than ten (10) feet to the canopy. All dumpsters and associated screening which consist of

combustible fencing around the support pad shall have a minimum separation from the nearest building or building overhang of ten (10) feet. Large commercial/industrial dumpsters, such as 20 or 40 yard containers may require a larger separation due to Building and Fire Codes. This minimum separation may be reduced or waived if the dumpster is protected by one or more fire sprinkler heads of a fire sprinkler system designed in accordance with sound engineering practices and as approved by the Fire Marshall.

- 4) All dumpsters and compactors shall be screened from view with a minimum six (6) foot opaque fence. The contractor shall provide an accessible site that does not cause obstruction of or damage to existing County roads or rights-of-way.
8. Dumpsters and Compactors, Food Service. In addition to the foregoing, businesses serving food and utilizing a dumpster or compactor must also meet the following criteria:
 - a. *Support Pad Design.* The support pad must be equipped with a hose bib with a backflow prevention assembly in accordance with Chapter 2-31, Article X of the Manatee County Code of Ordinances. Discharge from the support pad shall be directed to the onsite stormwater management system, i.e. catch basins, swales, retention area, etc.
 - b. *Aerator.* Clean mist aerators shall be required at owner's expense on food service compactors if odors can be detected at the subject parcel's property line, complaints are received from neighboring residents or businesses, and as required by Manatee County Sewer Use Ordinance and State regulations.
 9. Roll Off Containers Placement. Roll off container(s) on-site placement shall be determined on case-by-case basis by the Utilities Department Director or designated staff.
 10. Can Enclosure Locations. Enclosures are required where cans are approved for containment of solid waste and recycling generated by any single use requiring a special permit, final site plan, or off-street parking application. Can enclosures must be screened on three sides by an opaque fence a minimum of three (3) feet high. The enclosure must be sized a minimum of 5' x 8'. If the enclosure is not located so that one side is a building wall, a gate is required as the fourth side to ensure containment.
- F. General and Specific Waste Handling.
- See Florida Administrative Code for additional specific requirements relative to certain types of trash removal (i.e., Beauty Salons, Doctor Offices, and Veterinarian Clinics).
- G. Hazardous and Biohazardous Waste.
- Any facility which will generate hazardous and/or biohazardous waste is obligated to handle it in compliance with the Florida Administrative Code Chapter 62-730 and other sections of the Land Development Code. Any application for a Development Permit where the facility or operation in which any hazardous and biohazardous wastes are to be handled; the method of storage, safety features, transport and disposal shall be indicated. A contingency plan must be provided along with a site and building plan indicating the areas in which specific types and amounts of wastes will be stored. The licensed hauler of the wastes and the disposal and/or processing sites must be identified. Evidence of insurance or a bond to cover accidents involving the wastes must be provided as part of the application. This evidence must be resubmitted to and approved by the Building and Development Services Department on a yearly basis as proof of continued coverage.
- H. County Ordinance.
- Chapter 2-16 Solid Waste and Recyclable Materials of the County Code of Ordinances provides for mandatory

collection and disposal of solid waste within the unincorporated area of Manatee County. Disposal is currently and for the foreseeable future, at the County-owned Lena Road Solid Waste Management Facility. In as much as this ordinance, including definitions, affects the design, construction and use of any development, building or structure, it shall be considered part of this manual and Land Development Code.

I. Enforcement.

The Utilities Department is responsible for the enforcement of this Section and shall investigate violations of this Section and shall process confirmed violations in accordance with the violations section of the Land Development Code or as otherwise allowed by law.

SECTION 1.2 MODIFICATIONS TO EXISTING STRUCTURES, PIPING AND EQUIPMENT

1.2.1 DESCRIPTION OF WORK

Modification or conversion of existing structures as required by the construction drawings. Existing piping and equipment removal, dismantling, and disposal, as required.

1.2.2 PRODUCTS

- A. Epoxy mortar shall be fiberglass fiber mixed with an epoxy filler.
- B. Non-shrink grout shall be a sand-cement, non-metallic formulation, having a 28-day strength of 4,000 psi and 0.0 percent shrinkage per ASTM C1090.
- C. Liners to be installed in existing manholes and wet wells shall be spray-applied, monolithic, reinforced urethane resin. Urethane resin-based manhole liner material shall be resistant to hydrogen sulfide gas, and other common contents found in a sanitary sewer environment.
- D. Protective liners: Please reference the Approved Product List for acceptable products.

1.2.3 GENERAL MODIFICATION WORK

- A. Cut, repair, reuse, excavate, demolish or otherwise remove parts of the existing structures or appurtenances, as indicated on the construction drawings, or as necessary to complete the work as required. Dispose of surplus materials resulting from the above work in an approved manner. The work shall include all necessary cutting and bending of reinforcing steel, structural steel, or miscellaneous metal work found embedded in the existing structures.
- B. Dismantle and remove all existing equipment, piping, and other appurtenances required for the completion of the work. Where called for or required, cut existing pipelines for the purpose of making connections thereto.
- C. Anchor bolts for equipment and structural steel to be removed shall be cut off one inch below the concrete surface. Surfaces shall then be refinished using non-shrink grout or epoxy mortar or as indicated on the construction drawings. Repairs to the interior surfaces of existing concrete structures in sanitary sewers shall be made with epoxy mortar. Repairs to be made on other existing concrete surfaces using non-shrink grout shall be made using a bonding agent. Remove all dirt, curing compounds, sealers, paint, rust or other foreign material, and etch with muriatic acid solution. Flush with clean water and while still damp, apply a coating of the bonding agent. Place the new grout patch onto the treated area immediately.
- D. At the time a new connection is made, the following shall be installed: additional new piping, extending to and including a new valve, shall be installed. Old valves shall be removed and replaced with a new valve on potable and reclaimed water mains. Pipe restraint devices shall also be installed as required. At the time when a new potable or reclaimed water main or service is installed, a pipe locator tracer wire shall be installed and connected to the tracer wire at the main.
- E. No existing pipes, structures, equipment, or appurtenances shall be shifted, cut, removed, or otherwise altered except with the express approval of and only to the extent approved by the County. All existing valve boxes, fire hydrants, air release valve cabinets, and manholes shall be relocated or adjusted to meet the new finished grade elevations after construction.
- F. When removing materials or portions of existing utility pipelines or structures or when making openings in walls and partitions, take all precautions and use all necessary barriers and other protective devices so as not to damage the structures beyond the limits necessary for the new work, and not to damage the

structures or contents by falling or flying debris. Unless otherwise approved by the County, saw-cutting, rotary core-boring, or line drilling will be required in removing material from existing concrete structures or pipes.

- G. Materials and equipment removed in the course of making alterations and additions shall remain the property of the County, except that items not salvageable, as determined by the County, shall be disposed of off the work site.
- H. All alterations to existing utility pipes and structures shall be done at such time and in such a manner as to comply with the approved time schedule. Before any part of the work is started, all tools, equipment, and materials shall be assembled and made ready so that the work can be completed without delays.
- I. All cutting of existing concrete or other material to provide suitable bonding to new work shall be done in a manner to meet the requirements of the respective section of these Standards covering the new work. When not covered, the work shall be carried on in the manner and to the extent directed by the County or per the construction drawings.
- J. Surfaces of seals visible in the completed work shall be made to match as nearly as possible the adjacent surfaces.
- K. Non-shrink cementitious grout shall be used for setting wall castings, sleeves, leveling pump bases, doweling anchors into existing concrete and elsewhere as shown on the construction drawings. The surface to which grout is to be applied shall be wetted to facilitate good bonding.
- L. Where necessary or required for the purpose of making connections; cut existing pipelines in a manner to provide an approved joint. Where required, use flanges, couplings, or adapters, all as required.
- M. Provide flumes, hoses, piping, pumps and well points, and other related items to divert or provide suitable plugs, bulkheads, or other means to hold back the flow of water or other liquids, all as required in the performance of the work.
- N. Care shall be taken not to damage any part of existing buildings or foundations or outside structures.
- O. Prior to entering confined spaces in sanitary sewer structures, conduct an evaluation of the atmosphere within, in accordance with local, state, and federal regulations. Provide ventilation equipment and other equipment as required to assure safe working conditions.

1.2.4 CONNECTING TO EXISTING PIPING AND EQUIPMENT

Verify exact location, material, alignment, joint, etc. of existing piping and equipment prior to making the connections called out in the construction drawings. The verifications shall be performed with adequate time to correct any potential alignment or other problems prior to the actual time of connection. Asbestos concrete nipples between tees and valves shall be replaced with currently accepted materials. The County Inspector must be present for all tie-ins for a visual inspection.

1.2.5 REMOVAL AND ABANDONMENT OF ASBESTOS CEMENT PIPE AND APPURTENANCES

- A. All work associated with the removal or abandonment of existing asbestos cement pipe and appurtenances shall be performed by a licensed asbestos removal contractor registered in the State of Florida.
- B. The asbestos contractor shall contact the appropriate regulatory agencies prior to removal or abandonment of any asbestos material and shall obtain all required permits and licenses and issue all

required notices. The cost for all fees associated with permits, licenses and notices to the governing regulatory agencies shall be borne by the asbestos Contractor.

- C. All work associated with removal or abandonment of asbestos cement pipe and appurtenances shall be performed in accordance with the standards listed below and all other applicable local, State, or Federal standards.
 - 1. Florida Administrative Code, Chapter 62-257, ASBESTOS PROGRAM
 - 2. Title 40 CFR, Part 61, Subpart M, NATIONAL EMISSION STANDARD FOR ASBESTOS
 - 3. Occupational Safety and Health Act, Title 29 CFR
 - 4. Title 40 CFR, Part 763, ASBESTOS
 - 5. Florida Statute Title XXXII, Chapter 469, ASBESTOS ABATEMENT
- D. All asbestos cement pipe sections indicated on the construction drawings to be removed, and all related valves, fittings and appurtenances shall be removed in their entirety and disposed of by the asbestos Contractor in accordance with this Section. After removal of the pipelines, all excavations shall be backfilled in accordance with the applicable provisions of the Trenching and Excavation Section of these Standards. The cost of disposing of the removed materials shall be borne by the asbestos Contractor.
- E. The cutting of existing asbestos-cement (A/C, a.k.a. "Transite") pipe shall be by hand tools only. No powered machine cutting is allowed. Removal of all fragments of pipe shall be double bagged prior to shipment. Longer sections of pipe removed may be shipped without double bagging. An asbestos manifest form must accompany each shipment of such pipe or pipe material waste to the Manatee County Lena Road Landfill. Prior to each shipment, a minimum of 24-hour notice to the Landfill field office (telephone (941) 748-5543) is required.

1.2.6 IN-PLACE ABANDONMENT OF EXISTING PIPE

- A. Where water and wastewater utility pipes are to be abandoned in place, they shall be filled with a non-shrink, sand-cement grout or cement slurry. When such pipes are made of asbestos-cement materials, the abandonment activities shall be performed by a licensed asbestos Contractor. It is completely the Contractor's responsibility to obtain all regulatory clearances and provide documentation in cases where they have determined that an asbestos-cement pipe abandonment activity by in-place grouting does not require a licensed asbestos Contractor.
- B. The ends of the pipe sections to be abandoned shall be capped or plugged with suitable pipe fittings. The material shall be of suitable properties and the pumping pressure shall be such that the pipe sections are filled completely. All above-ground features shall be completely removed: hydrants, meters, valve & meter boxes, pads, vaults, etc. Existing non-mechanical joint fittings (tees, crosses, etc.) and valves to be removed shall be replaced with a spool piece of pipe (match existing). Existing fittings and valves left in service shall be plugged and properly restrained.
- C. The County shall be given timely notice so that the County's representative may be present to monitor all pipe abandonment operations. Provide standpipes and/or additional means of visual inspection as required to determine if adequate material has filled the entire pipe sections.

1.2.7 SPRAY-APPLIED LINERS

- A. Use a high-pressure water spray to remove all foreign material from the walls and bench of the structure. Loose or protruding masonry materials shall be removed using a hammer and chisel. Fill any voids, holes

or cracks using a hand trowel with epoxy mortar to form a uniform surface. Place covers over all pipe openings to prevent extraneous material from entering the pipes. Block or divert sewer flow from entering the structure. Any infiltration leaks shall be completely stopped by using such methods as approved by the County.

- B. Install the coating systems per manufacturer's recommendation and completely protect the structure from corrosion. The liner or coating systems must extend and seal onto manhole ring, onto and around pipe openings and any other protrusions, and completely cover the inverts, bench, and wall areas.
- C. The sprayed-on material shall be applied such that the entire structure is lined with a structurally enhanced monolithic liner. The thickness of the wall liner material shall be such that it will withstand the hydraulic load generated by the surrounding groundwater table, using a factor of safety of two, and using the assumption that the groundwater table is at the level of the top of the structure. The invert and bench liner material shall be the same thickness as that required for the base of the wall.
- D. Special care shall be used to provide a smooth transition between the intersecting pipelines and the structure inverts such that flow is not impaired. Remove concrete material from the existing structure base channel in depth to the required thickness of the new liner material.
- E. No active sewer flow shall be allowed in the newly lined structure, nor shall any vacuum tests be performed, until the liner material has had adequate time to cure, as recommended by the liner material manufacturer.
- F. Provide a five (5)-year unlimited warranty on all workmanship and products. The work includes the surface preparation and application of the coating or liner system and shall protect the structure for at least five (5) years from all leaks and from failure due to corrosion from exposure to corrosive gases such as hydrogen sulfide.

1.2.8 CONNECTION TO EXISTING PORTLAND CONCRETE MANHOLES

- A. Where required or as indicated on the construction drawings, make connection of new pipelines to existing manhole structures. If pipe stub-outs of the correct size and position are not available, make connections by removing a portion of the manhole wall by mechanical rotary core boring. The connection between pipe and manhole shall be complete with a jack-in resilient seals meeting the requirements of ASTM C923. The external take down clamp and its hardware shall be 316 stainless steel. The internal expansion band and its hardware shall be minimum 304 stainless steel.
- B. A new channel shall be formed in the manhole bench by removing and reforming or by providing new concrete to convey the new flow into the existing channel in accordance with the standard requirements for new sewer manhole structures. Flow direction shall not change by more than 90 degrees within the manhole base.
- C. Repair internal coating of existing manholes cored during connection of new sewers by applying approved coating material as listed in the Approved Product List in accordance with the manufacturer's recommendations. If an existing manhole has an internal coating other than that listed in the approved material list, completely remove the existing liner from the existing manhole and apply an approved coating in accordance with the manufacturer's recommendations.
- D. When connecting a force main to an existing manhole, the force main termination manhole and the next two manholes downstream shall be rehabilitated and lined with an approved liner.
- E. For connections to polymer concrete manholes and wet wells, please refer to Section 1.13.13.

1.2.9 ADJUSTING EXISTING PORTLAND CONCRETE MANHOLE FRAME AND COVER

- A. Existing manhole covers, which must be adjusted to existing or new pavement surfaces, shall be adjusted by modifying the existing precast portland or polymer concrete adjustment rings to bring the entire existing ring and cover to grade.
- B. No manhole cover adjustment rings shall be allowed.
- C. For adjustments to polymer concrete manholes and wet wells, please refer to Section 1.13.11.

END OF SECTION

SECTION 1.3 TRENCHING AND EXCAVATION

1.3.1 DESCRIPTION OF WORK

Excavate for utility pipelines, valves and fittings, manholes, utility vaults and lift stations. Dewater underground soils to elevations as required to allow the installation of pipelines, beddings, foundations and structures. Store excavated soil materials that are suitable for use as backfill. Dispose of excavated soil materials that are either unsuitable for use as backfill or will not be required for fill on the project site. Import suitable soil materials or granular rock materials as required to provide suitable backfill, bedding or foundation materials. Place and compact bedding and foundation materials and install utility structures. Place and compact backfill materials to finished grades. Provide other materials and labor as required to complete the utility work as indicated on the construction drawings.

1.3.2 CLEARING AND GRUBBING

Clear and grub the areas within rights-of-way and utility easements where utility structures will be installed. Completely remove and dispose of all buildings, foundations, materials, rubbish, debris, trees, brush, stumps, roots, or any other obstructions on or buried near the surface of the ground. Remove roots and other obstructions to a depth of at least 12 inches below the surface.

1.3.3 DEWATERING

- A. The construction of pipelines, structures, foundations, beddings, and the placement of backfill materials shall be in dry or dewatered subsurface soil conditions. Where the existing groundwater piezometric elevation is higher than 18 inches below the bottom of the proposed excavation, use well points, wells, pumps and other approved methods to lower the groundwater level to 18 inches below the elevation of the proposed excavation bottom. Excavation for pipelines and structures shall not proceed unless or until the existing groundwater levels have been lowered to at least 18 inches below the intended lowest elevation of the digging operation.
- B. Dewatering operations shall continue while the pit is open and while structure placement and construction is taking place and while backfilling and compaction is accomplished. At all times during the construction operations, the groundwater levels shall be maintained at an elevation 18 inches below the lowest level where structures are being installed.
- C. Divert surface water flows as necessary to prevent surface water from entering the open excavations.
- D. Discharged flows from dewatering operations shall be disposed of in a manner consistent with US EPA, FDEP, and SWFWMD regulations.
- E. All dewatering well-points and kelly wells shall be completely abandoned when no longer in use. Methods for proper well abandonment shall be followed to ensure the well-points and/or kelly wells are completely filled from bottom to top. Contractor shall use a non-shrink hydraulic grout or flowable fill, and any equipment (i.e. tremie, etc.) to ensure complete abandonment.

1.3.4 PROTECTION OF EXISTING STRUCTURES

- A. Where excavations are made and underground utility structures are constructed in close proximity to existing structures, take all reasonable precautions and measures to prevent damage to such structures. Existing building foundations and existing utility structures shall be monitored during the construction operations and any movement of these structures shall be reported to the County's authorized

representative. When any movement of existing structures has been detected, immediately take any and all remedial measures required to affect the protection and prevent damage to the structures.

- B. Existing structure protection measures shall include, but shall not be limited to, the installation of sheet piling, bell restraints, or other shoring methods or materials as needed, maintenance of the groundwater piezometric elevation, and control of the vibrations from construction operations. Where existing utility pipelines or structures are situated vertically above a line from the base of the excavation pit or trench along an angle of repose of the soil, or where an existing utility crosses a trench transversely, take reasonable measures to protect and support these structures during the construction operations.

1.3.5 EXCAVATION

- A. Excavate trenches and pits for structures to the elevations indicated on the construction drawings. Take special care to avoid over-excavating or disturbing the bottom of the trench or pit, so that the soil at the bottom of the hole remains in a naturally compacted condition. Excavate to widths sufficient to provide adequate working room to install the required structures. Do not excavate the final layer of soil to the designed grade until just before placing the bedding, foundation, pipe, structure, or masonry work required. Remove boulders, rocks, logs or any unforeseen obstacles encountered.
- B. In case the foundation soil found at the bottom of the trench or pit is soft, predominantly clay or mucky, or does not conform to the soils classification specified as suitable foundation material, over-excavation to a greater depth will be required. Soils not meeting the classification required for foundation material shall be removed to a depth at least four inches below the bottom of the pipe, bedding or structure bottom elevation. Rock, boulders or other hard or lumpy material shall be removed to a depth 12 inches below the bottom of the pipe, bedding or structure bottom elevation. Remove muck, clay or other soft material to a depth as needed to establish a firm foundation.
- C. Where possible, the sides of trenches should be vertical up to at least the spring line of the installed pipe.
- D. Trench excavation shall be performed in accordance with Florida Statute Title XXXIII, Chapter 553, Part III, Trench Safety Act.

1.3.6 BACKFILL MATERIALS

- A. Bedding - shall conform to FDOT Standard Specifications for Road and Bridge Construction, Section 901 Coarse Aggregate, and shall be either coarse aggregate of Size No. 57 or coarse sand of Size No. 9. Washed shell size No.57 may be used as an alternate bedding material.
- B. Structural Fill - shall be either soil classification A-1, A-2 or A-3, per AASHTO M-145, and shall be free of organic matter, lumps of clay or marl, muck, compressible materials, and rock exceeding 2.5 inches in diameter. Broken concrete, masonry, rubble or other similar materials shall not be used as backfill.
- C. Selected Common Fill - shall have the same material classification and requirements as Structural Fill, as per Paragraph 1.3.6.B, above.
- D. Common Fill - shall be either soil classification A-1, A-2, A-3, A-4, A-5 or A-6, per AASHTO M-145, and shall be free of organic matter, lumps of clay or marl, muck, compressible materials and rock exceeding 2.5 inches in diameter. Broken concrete, masonry, rubble or other similar materials shall not be used as backfill.
- E. Unsuitable Material - soil classification A-7 and A-8, per AASHTO M-145, shall not be used as backfill material.

1.3.7 BACKFILL

- A. Backfill materials shall be placed on solid, firm, naturally compacted or compacted, dry or dewatered in-place soil foundations.
- B. Where over-excavation is required due to nonconforming soil classification or rocky, unstable, or otherwise undesirable soil conditions, place Structural Fill or Selected Common Fill in the over-excavated zone up to the base of the bedding material layer. Compact the over-excavated zone to a 98 percent of the maximum dry density as determined by AASHTO T-180.
- C. When backfilling in an over-excavated zone where moist or watery conditions exist, backfill shall be coarse No. 9 sand or a mixture of No. 57 coarse aggregate with either No. 9 coarse sand, A-1, or A-3 material.
- D. After compaction, backfill material in the over-excavation zone shall form a solid and firm foundation on which to build up successive layers of backfill and structures.
- E. Bedding materials shall be placed on solid, firm soil foundations and shall be compacted to a 98 percent of the maximum dry density as determined by AASHTO T-180. When #57 stone is used for bedding, density testing is not required, however, the stone shall be placed in lifts and consolidated using conventional compaction techniques. Visual inspection by County personnel is adequate to indicate when the stone is consolidated and locked into place.
- F. Concrete and masonry structures shall be backfilled using Structural Fill. Backfilling and compaction shall be underneath the structure and carried up evenly on all walls of an individual structure simultaneously. The maximum allowable difference in backfill elevations shall be two feet. No backfilling shall be allowed against concrete or masonry walls until the walls and their supporting slabs have been in place at least seven days or until the specified 28-day strength has been attained. Compaction of Structural Fill shall be 98 percent of the maximum dry density of the material as determined by AASHTO T-180. The Structural Fill shall be either dried or shall have water added so that the moisture content of the material is within a range that will allow the required density to be achieved.
- G. Trenching backfill for pipe installation shall be Selected Common Fill for the pipe bedding zone. The pipe bedding envelope shall begin at the level four inches, six inches, or nine inches, depending on pipe diameter, below the bottom of the pipe, and shall extend vertically up to a level 12 inches above the top of the pipe. Where the in-place soil material within the four inch, six inch, or nine inch pipe bedding zone beneath the bottom of the pipe meets the soil classification for Selected Common Fill, undercutting of the trench below the bottom of the pipe will not be required. In this case, loosen the soil in the bottom of the trench immediately below the middle third of the pipe diameter, and place the pipe upon it. Where the in-place soil material within the pipe bedding zone does not meet the soil classification for Selected Common Fill, undercutting shall be required, and the bedding zone shall be backfilled with Selected Common Fill. In this case, place the pipe bedding material and leave it in a moderately firm uncompacted condition under the middle third of the pipe diameter, and compact the outer portions of the trench bottom to 98 percent of the maximum dry density. Soils that were over-excavated due to rocky, soft or otherwise unsuitable soil foundation conditions shall also be replaced with Selected Common Fill. Compaction of Selected Common Fill shall be 98 percent of the maximum dry density as determined by AASHTO T-180. Such backfill material shall have an optimized moisture content that will allow the required density to be achieved.
- H. Pipe sections for gravity flow systems shall be laid with spigots downstream and bells upstream. Excavate for pipe bells before laying pipe. Lay pipe true to the lines and grades indicated on the construction plans. Place backfill material on both sides of the pipe and compact to 98 percent of the maximum dry density

as determined by AASHTO T-180. Take special care to effectively fill and compact the material in the haunch areas under the sides of the pipe.

- I. For pipes that are not installed under roadways or driveways, trenching backfill for pipe installation shall be Common Fill above the pipe envelope zone, and shall be compacted to 95 percent of the maximum dry density of the material as determined by AASHTO T-180, and shall have moisture content optimized to allow the required density. For pipes that are installed under roadways or driveways, trenching backfill for pipe installation shall be Selected Common Fill above the pipe envelope zone, and shall be compacted to 98 percent of the maximum dry density of the material as determined by AASHTO T-180, and shall have moisture content optimized to allow the required density. Selected Common Backfill shall be placed in layers not to exceed 6 inches. Common Backfill shall be placed in layers not to exceed 12 inches.
- J. Backfill compaction tests shall be performed every 500 feet for the full depth of bury in pressure and gravity pipe line trenches, at every structure, and performed every 100 feet for gravity pipe line trenches from the bottom of the haunch area up to 2 feet from the top of pipe every lift (12 inch maximum). Test reports shall be presented to the County Inspector.

1.3.8 GRADING AND CLEANING UP

- A. Surplus and unsuitable soil materials not used on-site shall be removed and disposed of off-site in a manner that is consistent with state and local regulations. In no case shall surplus or unsuitable material be deposited on-site or on adjacent lands.
- B. The surface of backfilled areas shall be graded smooth and true to the lines and grades indicated on the construction plans. No soft spots or uncompacted areas shall be allowed in the work.
- C. Upon completion of the work, leave the work areas and all adjacent areas in a neat and presentable condition, clear of all temporary structures, rubbish and surplus materials. Pile any salvageable materials that have been removed in neat piles for pickup by County crews, unless otherwise directed.

END OF SECTION

SECTION 1.4 DUCTILE IRON PIPE AND FITTINGS

1.4.1 DESCRIPTION OF WORK

- A. Furnish all labor, materials, equipment and incidentals required to install ductile iron pipe, restrained joint ductile iron pipe and ductile iron fittings, complete, as indicated on the construction drawings.
- B. Provide and install complete all fittings and appurtenances not noted specifically on the construction plans as required to complete the utility system in accordance with these Standards.
- C. Ductile iron pipe shall not be used in sewer applications, unless where agreed upon by the County based on economic benefit and/or construction feasibility. Approval shall be sought from the County prior to plan submittal.

1.4.2 PRODUCTS

- A. Ductile iron pipe shall conform to AWWA C150 and AWWA C151. Pipe shall be Pressure Class 350 for sizes 4" thru 16" and Pressure Class 250 for 18" and larger. All pipe materials used in potable water systems shall comply with NSF Standard 61.
- B. All flanged ductile iron pipe used in above ground applications (i.e. aerial crossings, master meter assemblies, backflow assemblies, etc.) shall be Special Thickness Class 53.
- C. Ductile iron pipe, 14 inches in diameter, shall not be used.
- D. Unrestrained joint pipe shall be supplied in lengths not to exceed 21 ft and shall be either the rubber-ring compression-type push-on joint or standard mechanical joint pipe.
- E. All mechanical joint fittings shall be pressure rated for 350 psi for sizes 4-16 inches and 250 psi for sizes 18 inches and larger. All flanged fittings shall be pressure rated for 250 psi for all sizes. All fittings shall meet the requirements of AWWA C110 or AWWA C153.
- F. Rubber gaskets shall conform to AWWA C111 for mechanical and push-on type joints and shall be Ethylene Propylene Diene Monomer (EPDM) rubber for potable water and reclaimed water pipelines. "EPDM" shall be embossed and/or etched into the gasket material. Acrylonitrile butadiene (NBR) gaskets shall be used for all ductile iron pressure pipe that are located in soil that is contaminated with low molecular-weight petroleum products or non-chlorinated organic solvents or non-aromatic organic solvents. Fluorocarbon (FKM) gaskets shall be used for all ductile iron pressure mains that are located in soil that is contaminated with aromatic hydrocarbons or chlorinated hydrocarbons. Fluorocarbon (FKM) gaskets shall be used where both classes of contaminants are found.
- G. Water Main and Reclaimed Water Main Coatings: All buried ductile iron pipe shall have a standard thickness cement lining on the inside in accordance with AWWA C104 and a standard 1-mil asphaltic exterior coating per AWWA C151 or as defined in the Approved Products List. All above-ground ductile iron pipe shall have a standard thickness cement lining on the inside in accordance with AWWA C104 and have an exterior coating factory-applied epoxy primer.

All ductile iron fittings shall have double the standard thickness cement linings on the inside per AWWA C104. Buried ductile iron fittings shall have a standard 1-mil asphaltic exterior coating per AWWA C151. Above-ground ductile iron fittings shall have a factory-applied epoxy primer.
- H. Wastewater Main Coatings:
 - 1. Interior: All ductile iron pipe and fittings used in wastewater sewer systems shall have a green, factory applied amine cured novalac ceramic epoxy or a modified polyamine ceramic epoxy

interior lining on the inside, dry film thickness shall be as defined in the Approved Products List. The interior lining application is to be based on the manufacturer's recommendation for long-term exposure to raw sewage. To ensure a holiday-free lining, documentation must be provided, at time of delivery, showing each section of lined pipe has passed holiday testing at the time of production per ASTM G62. The lining shall have a minimum three (3)-year warranty covering failure of the lining and bond failure between liner and pipe.

2. Exterior: All buried ductile iron pipe and fittings used in wastewater systems shall have a standard 1-mil asphaltic coating per AWWA C151 or as defined in the Approved Products List. Above-ground ductile iron pipe and fittings shall have a factory-applied epoxy primer.
- I. Lubricant furnished for lubricating the push-on joints in potable water pipes shall be nontoxic, water soluble, shall not support the growth of bacteria, shall have no deteriorating effects on the gasket or pipe material, and shall not impart color, taste, or odor to the water, and shall be an approved substance per NSF 61.
- J. Thrust restraint devices shall be provided at all horizontal and vertical bends and fittings, in casings under roads and railroads and at other locations specifically indicated on the construction drawings. Thrust restraint devices shall be either concrete thrust blocks or restraining glands.
- K. Manufacturer's restrained joints for ductile iron pipe where used, shall be installed at bend and fitting locations and at pipe joint locations both upstream and downstream from the bends or fittings at distances as required by these Standards. Restrained joint pipe fittings shall be designed and rated for the following pressures:
 - 350 psi for pipe sizes up to and including 16" diameter
 - 250 psi for pipe sizes 18" diameter and above
- L. All gaskets used in water and reclaimed water application shall be EPDM rubber. The word "EPDM" shall be embossed or formed into the gasket. Stamped or stickers shall be prohibited. All gaskets not clearly identified to be EPDM shall be rejected and removed from the job site.
- M. All restraining gasket shall have a color inherent with the rubber. Color shall not be attained by surface coating.

1.4.3 IDENTIFICATION

- A. Each length of pipe and each fitting shall be marked with the name of the manufacturer, size and class, lining type, and shall be clearly identified as ductile iron pipe. All gaskets shall be marked with the name of the manufacturer, size and proper insertion direction.
- B. All ductile iron pipe and/or fittings shall be entirely covered with a polyethylene sleeve; blue for water mains, purple for reclaimed water mains, and green for sewer mains, per AWWA C105.
- C. All above ground potable water mains and appurtenances shall be painted Scott Paints safety blue; purple (Pantone purple 522 C) for reclaimed water; or Hunter Green (Rustoleum 7538) for pressure sewer.

END OF SECTION

SECTION 1.5 POLYETHYLENE (HDPE) PIPE AND FITTINGS

1.5.1 DESCRIPTION OF WORK

Furnish all labor, materials, equipment and incidentals required to install high density polyethylene (HDPE) pressure pipe, tubing, fittings and appurtenances as indicated on the construction drawings.

1.5.2 PRODUCTS

- A. Polyethylene mains 4" diameter and larger shall be high-density bimodal PE 100/PE4710 polyethylene resin with a minimum cell classification of 445574 per ASTM D3350, Class 200, DR 11, meeting the requirements of AWWA C906. All pipe materials used in potable water systems shall comply with NSF Standard 61. Outside diameters of water, reclaimed water and pressure sewer HDPE pipes shall be ductile-iron sizing system (DIPS).
- B. High density polyethylene (HDPE) shall not be placed within the roadways in water and reclaimed applications, unless in a casing.
- C. High density polyethylene (HDPE) pipe, 14 inches in diameter, shall not be used.
- D. Polyethylene tubing 2 inches in diameter and smaller for potable water and reclaimed water services shall be high-density PE4710 polyethylene resin per ASTM D2737, Pressure Class 200, Copper Tube Size (CTS), DR 9, meeting the requirements of AWWA C901. Butt fusion or CTS brass connections shall be used. All pipe materials used in potable water systems shall comply with NSF Standard 61.
- E. Polyethylene pipe 3 inches in diameter (for wastewater grinder lift force mains) shall be high-density PE4710 polyethylene, per ASTM D2737, Pressure Class 200, iron pipe size (IPS) outside diameter, DR 11, meeting the requirements of ASTM D3350 and AWWA C906. 3 inch diameter pipe shall only be used with written authorization from the County.

1.5.3 JOINTS

- A. Where PE pipe is joined to PE pipe, it shall be by thermal butt fusion. Thermal fusion shall be accomplished in accordance with the written instructions of the pipe manufacturer and fusion equipment supplier. The installer of the thermal butt fused PE pipe shall have received training in heat fusion pipe joining methods and shall have had experience in performing this type of work.
- B. Flanged joints, mechanical joints and molded fittings for 4" and larger pipe shall be in accordance with AWWA C906. Mechanical joints and fittings for 2" and smaller pipe & tubing shall meet the requirements of: AWWA C901, ASTM D 3350 and ASTM D 3140.

1.5.4 IDENTIFICATION

- A. Mains and tubing shall bear identification markings in accordance with AWWA C906 or C901.
- B. All pressure mains shall have color coded embedded striping on 3 sides (120 degree apart); blue for water, purple for reclaimed water or green for pressure sewer.
- C. All pressure service tubing shall be solid color coded pipe; blue for water or purple for reclaimed water.

END OF SECTION

SECTION 1.6 POLYVINYL CHLORIDE (PVC) PRESSURE PIPE

1.6.1 DESCRIPTION OF WORK

- A. Furnish all labor, materials, equipment and incidentals required to install the PVC piping, iron fittings and other appurtenances complete and ready for use as indicated on the construction drawings.
- B. Provide and install complete all fittings and appurtenances not noted specifically on the construction plans as required to complete the utility system in accordance with these Standards.

1.6.2 PRODUCTS

- A. Polyvinyl chloride (PVC) pressure pipe, 4 - 12 inches in diameter, shall be Class 235, DR 18, meeting the requirements of AWWA C900-16 and used for water, reclaimed water, and sewer force mains. Mains shall have cast-iron-pipe-equivalent outside diameters (also known as ductile iron pipe size (DIPS)). Each length of pipe shall be hydrostatically tested to two times its pressure class of the pipe by the manufacturer in accordance with AWWA C900-16. Pipe shall be furnished in standard lengths of approximately 20 feet.
- B. Polyvinyl chloride (PVC) pressure pipe shall not be placed within the roadways in water and reclaimed applications, unless in a casing.
- C. Polyvinyl chloride (PVC) pressure pipe, 14 inches in diameter, shall not be used.
- D. Water and reclaimed water mains greater the 16" are to be ductile iron (or may be HDPE with prior County written approval).
- E. Polyvinyl chloride (PVC) pressure pipe C900-16 DR 18, 16 inches thru 36 inches, can be used in force main applications.
- F. Polyvinyl chloride (PVC) pressure pipe, 2 inches in diameter, used solely for sewer grinder lift station application only, shall be Pressure Rated 200, SDR21, conforming to ASTM D2241, and shall have Iron Pipe Size (IPS) outside diameters. SDR 21 PVC pipe 2-3 inches in diameter shall not be used for working pressures greater than 125 psi. PVC pipe shall not be used in applications which require pipes that are less than 2 inches in diameter for wastewater force mains. PVC Pipe shall not be used in applications which require pipes that are less than 4 inches in diameter for potable water piping and reclaimed water piping.
- G. Standard PVC pressure pipe joints shall be bell and spigot push-on type with elastomeric ring seals. Ring seal gaskets used at push-on joints shall conform to ASTM F 477 and shall be EPDM rubber for potable and reclaimed water pipes. "EPDM" shall be embossed and/or etched into the gasket material.
- H. Lubricant furnished for lubricating the push-on joints in potable water pipes shall be nontoxic, water soluble, shall not support the growth of bacteria, shall have no deteriorating effects on the gasket or pipe material, and shall not impart color, taste, or odor to the water, and shall be an approved substance per NSF 61.
- I. Thrust restraint devices shall be provided at all horizontal and vertical bends and fittings, in casings under roads and railroads and at other locations as indicated on the construction drawings. Thrust restraint devices for PVC pipe and fittings shall be restraining glands. Restrained joints, shall be installed at bend and fitting locations and at pipe joint locations both upstream and downstream from bends or fittings at distances as required by these Standards.
- J. All fittings for PVC pipe shall be ductile iron with mechanical joints and shall conform to AWWA C153 and to the applicable sections of these Standards for ductile iron.

- K. All pipe materials used in potable water systems shall comply with NSF Standard 61.

1.6.3 IDENTIFICATION

- A. PVC pipe shall bear identification markings in accordance with AWWA C900-16 or ASTM D2241.
- B. PVC pipe shall be color coded blue for water, purple for reclaimed water or green for pressure sewer using a solid pipe color pigment.

END OF SECTION

SECTION 1.7 POLYVINYL CHLORIDE (PVC) GRAVITY SEWER PIPE

1.7.1 DESCRIPTION OF WORK

Furnish all labor, equipment, materials, testing and incidentals required to install the gravity sewers, complete, as indicated on the construction drawings.

1.7.2 PRODUCTS

- A. Polyvinyl chloride (PVC) gravity sewer pipe and fittings, 4-15 inches in diameter, shall be SDR 26, meeting the requirements of ASTM D 3034. Joining of pipe sections and fittings shall be by water-tight push-on joints using elastomeric gaskets in accordance with ASTM D 3212.
- B. Polyvinyl chloride (PVC) pipe, 16-48 inches in diameter, for gravity sewers, shall be DR 25, with cast-iron (CI) outside diameter (also known as ductile iron pipe size (DIPS)), meeting the requirements of AWWA C900-16.
- C. All PVC sewer pipe bell ends shall be field inspected for out-of-roundness and spigot ends shall be field inspected for out-of-roundness and for squareness of the pipe end. Any materials not in conformance with the tolerances of ASTM D 3212 or AWWA C900-16 shall be removed from the work site.
- D. All PVC sewer pipe sections shall also be field inspected for excessive cross-section deflection. Any pipe section visually found to have a pipe deflection, before installation, of 2 percent of the Base Inside Diameter or greater shall be removed from the work site.
- E. After installation and backfill, pipe deflection shall not be allowed to be 5 percent or greater of the Base Inside Diameter. Any length of pipe found installed having excessive deflection shall be dug up and either reinstalled or removed from the work site.
- F. Six inch PVC fittings for sewer laterals shall also be SDR 26, molded in one piece, with elastomeric joints in accordance with ASTM D-3034. Fittings not currently available in molded form may be fabricated in accordance with ASTM D-3034 with manufacturer's standard pipe bells and gaskets.

1.7.3 JOINING PVC GRAVITY SEWER PIPE AND FITTINGS

- A. The PVC joints shall be of the push-on type with a single rubber gasket conforming to ASTM F 477.
- B. Wyes and riser fittings shall be gasketed connections. Rubber doughnuts are not to be used.
- C. Joints between pipes of different materials shall be made using stainless steel shielded couplings or coated mechanical joints connections. Metal piping shall not be threaded into plastic fittings, valves, or couplings, nor shall plastic piping be threaded into metal valves, fittings, or couplings.

1.7.4 IDENTIFICATION

- A. PVC gravity sewer pipe shall bear identification markings in accordance with ASTM D 3034 or AWWA C900-16.
- B. PVC gravity sewer pipe shall be color coded green using a solid pipe color pigment.

END OF SECTION

SECTION 1.8 INSTALLATION OF PIPELINES

1.8.1 REQUIRED EASEMENTS

A. Master Meter and/or Backflow Prevention Assemblies:

1. All assemblies shall be encompassed by a public utility easement that shall extend from the public right-of-way (or other public access) to 5 feet past the downstream edge of the assembly's concrete pad. The easement shall also extend a minimum of 3 feet from the side edges of the concrete pad;
2. No landscaping and irrigation shall be installed within the easement or protrude into the easement boundaries and trees shall be a minimum of 10 feet from the easement;
3. No structures shall be installed at or within the easement and shall include but not be limited to buildings, foundations, footers, fencing, etc.;
4. All easements shall be coordinated with and recorded through Property Acquisitions.

B. Pipelines:

1. All publicly owned and maintained pipelines that are on private property shall have a minimum 20 or 10-foot wide plus pipe diameter public utility easement, centered on the pipeline;
2. No landscaping and irrigation shall be installed within the easement or protrude into the easement boundaries and trees shall be a minimum of 10 feet from the easement;
3. No structures shall be installed at or within the easement and shall include but not be limited to buildings, foundations, footers, fencing, etc.;
4. All easements shall be coordinated with and recorded through Property Acquisitions.

1.8.2 GENERAL

- A. Furnish and install pipe, fittings, valves, fire hydrants, services, and all other appurtenances and incidentals complete and in-place as required by the construction drawings.
- B. All pipe crossings of federal or state roads; or local arterials & thoroughfares; or railroads shall be installed in a casing pipe (steel, PVC, or HDPE).
- C. Potable and reclaimed water mains shall be ductile iron or protected by a casing pipe in the following instances:
 1. mains that are installed under and run parallel with a paved roadway shall be ductile iron only;
 2. mains that cross under more than 48 LF of paved roadway (as measured from outer most edge of pavement to outer most edge of pavement of the entire right-of-way cross-section) shall be in a casing; less than 48 LF shall be ductile iron pipe;
 3. mains that are installed under paved areas, (i.e. parking lots, etc.) shall be ductile iron only;
 4. the above criteria shall be implemented and enforced to replace and/or protect existing mains when the above conditions are created by new development or site improvements.
- D. Force mains shall be protected by a casing pipe in the following instances:
 1. mains that cross under more than 48 LF of paved roadway (as measured from outer most edge of pavement to outer most edge of pavement of the entire right-of-way cross-section) shall be in a

casing; less than 48 LF shall be determined on a case-by-case basis (i.e. cul-de-sacs, dead-end roads, etc.);

2. the above criteria shall be implemented and enforced to replace and/or protect existing mains when the above conditions are created by new development or site improvements.
- E. Force main aerial crossings shall be PVC pipe in a steel casing. Alternate solutions may be considered by the County prior to plan submittal.
 - F. In situations where mains have been designed, but not limited to, near or between buildings, pass under structures (i.e. walls, fences, etc.), or pass under decorative landscaping (i.e. planters, berms, etc.), the mains shall be placed in a casing with ends that extend well past the edges to allow for excavation during operation and maintenance practices and prevent adverse conditions to the above. The clearance shall be based on the review and approval of the County.
 - G. When the main(s) is located under any kind of pavement, the water or reclaimed water service line shall be Type "L or K " copper or Schedule 40 stainless steel.
 - H. Water mains 16-inches and larger shall be ductile iron (or high-density polyethylene with Manatee County Utilities written approval).
 - I. Ductile iron pipe, with gasket materials as required in these Standards, shall be used in soil that is contaminated with low molecular-weight petroleum products, aromatic hydrocarbons, chlorinated hydrocarbons or organic solvents.
 - J. Trees shall not be planted or located within 10 feet of any potable water main, reclaimed water main, sanitary force main, gravity sanitary sewer main, sanitary cleanouts, or potable/reclaimed/force main appurtenances such as meters, hydrants, backflow prevention assemblies, etc. that are owned and maintained by Manatee County. An approved root barrier shall be used where trees are planted closer than 10 feet.
 - K. All distribution waterlines that enter private property become private lines and shall have a backflow prevention assembly installed at the right-of-way in accordance with Chapter 2-31, Article X of the Manatee County Code of Ordinances.
 - L. No line stops shall be used in potable water or reclaimed water mains.
 - M. Water mains installed on short cul-de-sacs or permanent dead-ends, where future growth is not feasible (or expected), shall be reduced in diameter to 4-inch and/or 2-inch based on the hydraulic needs of the distribution system. On longer cul-de-sacs, the water main shall be reduced to 4-inch and/or 2-inch after the fire hydrant; also based on the hydraulic needs of the distribution systems. In all cases, dead-end mains shall require a manual blow-off assembly.

Generally, not more than 4, or the equivalent of 4, residences shall be connected to a 2-inch diameter water line, unless the main is looped or otherwise supplied from two connections with mains of adequate capacities. A looped 2-inch main shall serve no more than 40 residences, or the equivalent water demand of 40 residences. A 2-inch diameter main shall not exceed 1,000 feet in length.

The hydraulic calculations and distribution design shall produce a system that limits the need for constant regular flushing of water to ensure water-quality levels are met.

Dead-end public mains, with more than a 4-day water turn-over rate, shall require the installation of a metered blow-off assembly with an auto-flusher.

1.8.3 HANDLING AND STORAGE

- A. Prior to installation, all pipe and fittings shall be inspected. Cracked, broken, or otherwise defective materials not in compliance with these standards shall not be used and shall be removed from the project site.
- B. The pipeline installer shall take care in the handling, storage and installation of the pipe and fittings to prevent injury to the materials or coatings. Use proper implements, tools and facilities for the safe and proper protection of the work. Lower the pipe and fittings from the truck to the ground and from the ground into the trench in a manner to avoid any physical damages. Under no circumstances shall the pipe or fittings be dropped onto the ground or into the trenches.
- C. The pipeline installer shall not distribute material on the job site faster than it can be used to good advantage. Unless otherwise approved by the County, installer shall not distribute more than one week's supply of material in advance of laying. Any materials not to be installed within two weeks of delivery shall be protected from the sunlight, atmosphere and weather by suitable enclosures or protective wrapping until ready for installation. Stored PVC pipe shall be placed on suitable racks with bottom tiers raised above the ground to avoid damage. Storage of pipe on the job site shall be done in accordance with the pipe manufacturer's written instructions.

1.8.4 CLEANING

The interior of pipe, fittings, valves and other appurtenances shall be thoroughly cleaned of all dirt, debris and obstructions before being lowered into the trenches. All pipelines shall be kept clean during and after installation and shall be protected from dirt or foreign matter entering the pipe at all times. All open pipe ends shall be securely plugged or capped water-tight when construction stops during the day, or during lunch, or overnight or during longer periods of inactivity.

1.8.5 INSTALLATION

- A. Pipe, fittings, valves and other appurtenances shall be installed in accordance with the manufacturer's written installation instructions and with the provisions of "Recommended Standards for Water Works" report as incorporated by reference in Chapter 62-555, F.A.C., and with the provisions of "Recommended Standards for Wastewater Facilities" report as incorporated by reference in Chapter 62-604, F.A.C.
- B. In general, all pressure pipe, (water, reclaimed water and force main sewer), shall be designed with no less than three feet of cover, but not more than six feet of cover from final grade, unless otherwise shown on the plans and approved by Utilities.
- C. In all cases, all pipe shall be laid to such lines, gradients and levels as shown on the construction drawings. Gravity sewer pipe shall be laid on grade with bell upgrade and spigot downgrade.
- D. It is the Contractor's responsibility to preserve uniform gradients and correct alignment. If it is determined the pipe is incorrect in size, level or grade, then all deficiencies shall be corrected.
- E. Where shown on the construction drawings, special bends shall be provided for horizontal or vertical changes of direction. Where such bends are not shown on the construction drawings, changes of direction shall be affected by angling the joints.
- F. No joint shall be angled to such an extent as to impair its effectiveness and tightness.

- G. When making a joint, pipes should always be in line and if required, deflection made after making the joint. The deflection shall not be greater than the maximum value recommended by the pipe manufacturer.
- H. Installation tolerances:
 - 1. Direct Bury:
 - a. Vertical Alignment = ± 0.5 feet
 - b. Horizontal Alignment = ± 1.0 feet
 - 2. Horizontal Directional Drill (Trenchless Technologies):
 - a. Vertical Alignment:
 - 1) max. slope shall not exceed 2% (2.0 feet within a length of 100 feet).
 - 2) No reverse curvature within 200 feet
 - 3) No vertical deviation greater than ten (10) percent of the proposed depth of cover at that specific station.
 - b. Horizontal Alignment:
 - 1) max. rate of deviation shall not exceed 1.5% (1.5 feet within a length of 100 feet
 - 2) No reverse curvature
 - 3) Total deviation not to exceed 2.0 feet
- I. The trenches and bedding for the pipe installations shall be prepared according to Section 1.3, Trenching and Excavation, of these standards. Pipe sections shall be laid in full contact with the prepared pipe bedding, with bell holes dug out, to provide a continuous and uniform bearing and support for the pipe barrel between joints. Blocking under the pipe shall not be permitted (except through casing sleeves).
- J. While laying pipe in gravity sewer installations, the pipe alignment shall not deviate by more than 1/2 inch for line and 1/4 inch for grade, as measured at the pipe inverts at the manhole, from the design line and grade established on the construction drawings, provided that such variance does not result in a level or a reverse sloping pipe invert. Line and grade of gravity sewer pipelines shall be measured at the pipe invert and shall be controlled during installation by laser beam method. Other methods of controlling line and grade may be approved by the County if the laser beam method is shown to be unworkable. A "Caution - Laser Light" placard shall be displayed in a conspicuous place while laser beam pipe laying equipment is in use. Pipe grade between manholes shall not deviate by more than 1 inch from the design grade line, as measured with the television (TV) camera's depth gauge during the mandatory pre-acceptance TV inspection, provided that such deviation does not result in a level or a reverse sloping pipe invert.
- K. Joining of pipe sections shall be done in strict accordance with the pipe manufacturer's written instructions. The joining surfaces of the bell and spigot and the rubber seal ring shall be thoroughly cleaned and lubricated immediately prior to joining the pipe per the written instructions. After the joint has been made, the pipe alignment shall be checked. Place sufficient compacted backfill material around and over the pipe to secure the pipe from movement before installing the next joint to assure proper pipe alignment and joint makeup.
- L. When cutting or machining pipe in the field is necessary, the pipe installer shall use only the tools and methods recommended by the manufacturer in the written instructions. Care shall be taken to not damage the pipe coating or linings. Damage to linings shall be cause for rejections of the complete section of pipe, or for the rejection of a fitting or valve. Damage to exterior coatings shall be corrected to the original standard material specification.

- M. At connections to manholes or other concrete structures, the pipe joint shall be located a minimum of 18-inches outside of the edge of the structure.
- N. At stub-outs from new structures to future pipelines, the pipe stub-out length shall be the same as the standard pipe length being laid. Stub-out pipes shall be closed off with standard restrained plug or cap fittings.
- O. Thrust restraint devices shall be either cast-in-place concrete thrust blocks or other approved restrained joint devices. Cast-in-place concrete for thrust blocks shall have a 28-day strength of 3,000 psi. The concrete shall be placed between undisturbed soil and the fittings or appurtenance to be supported. Concrete shall not be placed on or around the pipe, bells, flanges, or other joints.
- P. All ductile iron pipe(s) and fitting(s) shall be protected with a polyethylene sleeve(s), thickness as defined by the Approved Products List.
- Q. At all fire hydrant laterals, the lateral pipe from tee to fire hydrant shoe shall have all joints restrained. The lateral shall also be restrained from side movement by concrete thrust blocks placed at the fire hydrant shoe and at the lateral tee.
- R. Place and secure a black bag over all fire hydrants not yet placed into service to designate them as such and to serve as a warning that the water is not safe to drink.
- S. All pressure water, reclaimed water and force main sewer pipelines laid in trenches shall have a continuous, solid copper clad steel wire with a polyethylene insulation rated UF or USE by Underwriter's Laboratories, as defined in the Approved Products List, attached to the pipe. The polyethylene insulation shall be color coded blue (water), purple (reclaimed water) or green (sanitary sewer). The wire shall be placed on top of the pipe and secured in place at every joint and at 5 foot intervals with color coded 6 mil thick PVC marking tape.
- T. All mains which are installed by the open-trench method, regardless of piping material, shall also include the installation of a continuous, 6--inch wide, color-coded, electrically detectable path marking tape buried directly over the pipe. The path marking tape shall be placed between 12-inches and 24--inches below finished grade; with 48-inch being the maximum. The top of the tape shall be boldly labeled every eighteen to thirty-two (18-32) inches as follows "CAUTION WATER LINE BURIED BELOW", "CAUTION SEWER LINE BURIED BELOW", OR "CAUTION RECLAIMED WATER LINE BURIED BELOW" and shall be color-coded blue (water), green (sewer), or purple (reclaimed water).
- U. Trenching, backfilling and compaction for the newly laid pipelines shall be accomplished in accordance with Section 1.3, Trenching and Excavation.
- V. In directional bore applications, one extra high strength copper clad steel tracer wire with a polyethylene insulation rated UF or USE by Underwriter's Laboratories, as defined by the Approved Products List. The wire shall be pulled and secured to the top of the pipe with color coded PVC marking tape or 10-mil thickness polyethylene pressure sensitive tape at every joint and at 24-inch intervals. The tracer wire shall be color coded blue (water), purple (reclaimed water) or green (sanitary sewer).
- W. Underground splice connections shall be minimized and shall be rated for direct burial service. Spliced tracer wire connections shall be underground water-proof wire connectors meeting UL 486D test standards. The wire shall terminate at fire hydrants, backflow prevention assemblies, and at each meter box with a underground water-proof terminal connector. The wire shall also terminate at valve boxes for gate valves, plug valves, tapping valves, air release valves and blow-off valves. The tracer wire shall also terminate at gate valve boxes that are not located within 200 feet of a fire hydrant, backflow prevention assembly, meter box, plug valve, air release valve or blow-off valve. Meter boxes shall have at least 12

inches of wire looped into the boxes. The looped termination shall allow for the connection of an electronic locator transmitter.

- X. Prior to construction of any pressure main, the Contractor shall propose a flushing/pigging plan to the County Inspector showing on the drawings each location where each pig will be placed in the pipe and each location that the pig will be retrieved. A pig (with a 2 lb/cu-ft density) one diameter larger than the inside diameter for the type of pipe installed, shall be run through the pressure main(s) until clear and free of debris. Inspectors must be notified 48 hours in advance of any pigging and flushing operations. With the County Inspector present, all new pressure mains 4 inches and larger shall be pigged and then flushed. All new pressure mains less than 4 inches shall be flushed to clean all parts of the system and to remove any accumulation of construction debris, rocks, sand, gravel, silt and other foreign material. If necessary, also make use of mechanical rodding or bucketing equipment. Short pipe lengths (i.e. stubs) may be flushed without pigs with prior approval from County. For flushing, a minimum velocity of at least 3.0 ft/sec, preferably 3.5 ft/sec, shall be obtained in the pipe. This velocity shall be maintained long enough to allow three (3) complete pipe volume changes of water for proper flushing action. Successful flushing shall be determined visually by the County Inspector and may be deemed acceptable when the water is clear and free of debris.
- Y. During the installation of pipelines using the horizontal directional drilling (HDD) method, the pulling force and downhole mud pressure shall be digitally monitored and recorded. Pulling force shall be limited to the maximum allowed by the pipe manufacturer. A mandrel based on 80% of the inside diameter of the pulled pipe shall be pulled through the final installed pipe by hand to confirm no elongations (necking) have occurred.
- Z. As a marker for the Surveyor, a PVC pipe marker or 2" x 4" marker shall be inserted by the Contractor on the top of pipe for potable water mains, reclaimed water mains and sanitary force mains at intervals no greater than 200 feet apart; at all fittings, and at locations where there is a substantial grade change. The pipe markers shall indicate the pipe diameter and/or fitting type with orientation (H or V) and shall be labeled PWM in "safety" blue for potable water mains, RWM in purple for reclaimed water mains, and FM in green for sanitary force mains, respectively. The Contractor is responsible for making the aforementioned markers available to the Surveyor. The Contractor shall field locate (expose) the mains and fittings when markers are not made available to the Surveyor.
- AA. A PVC pipe marker or 2" x 4" marker shall be inserted by the Contractor at the beginning and end of each horizontal directional drill (HDD). The HDD Contractor shall provide a certified report and bore log indicating the horizontal and vertical location every 25 linear feet or less along the pipe. The horizontal locations on the bore log shall also indicate the location per the stationing of the construction baseline.

1.8.6 PRESSURE TAPS

- A. Pressure taps for connection of new water, reclaimed water or sewer systems to existing County pressure mains shall be made by a County crew for tap sizes up to and including 12 inches diameter. For each pressure tap performed by the County, the pipeline installer shall provide excavation to unearth the existing pipe and provide a dry, safe tapping pit, and shall provide and install the tapping sleeve and tapping valve with an EPDM full-face 1/8-inch rubber gasket. Prior to the tapping of the pipe, the pipeline installer shall pressure test the sleeve and the valve to the satisfaction of the County Tapping Crew or the County Inspector. After the tap has been made, the pipeline installer shall backfill and compact the excavation, and provide all other materials and labor required to complete the work.
- B. Pressure taps shall not be used to make pipeline connections in new work except to make a connection to an existing County main, and then only if it is deemed to be inconvenient or unworkable to make the

connection by another method using standard fittings. Where a new phase of the system will be connected to a future phase or future subdivision, standard fittings will be assembled which shall include a line valve and stub-out and cap where the future system will be connected without need for making another pressure tap. All pressure tap installations shall be subject to approval by the County.

- C. All pressure taps greater than 12 inches in diameter and all tap sizes on concrete mains, shall be made by a Manatee County approved tapping company.
- D. When installations are made under pressure, the flow of water through the existing main shall be maintained at all times. The diameter of the tap shall be at least two inches smaller than the inside diameter of the through main. No same size taps shall be allowed.
- E. The Contractor shall confirm the location(s) of the existing main to be tapped by visually inspecting the proposed location(s) of the tapping sleeve(s) and ensure the locations will be satisfactory and no interference will be encountered; such as the occurrence of existing utilities or of a joint or fitting at the location proposed for the connection. No tap will be made closer than 30 inches from a pipe joint or a fitting.
- F. Adequate support shall be provided under the sleeve and valve during the tapping operation. Thrust blocks shall be provided underneath the valve and behind all tapping sleeves. Proper tamping of supporting earth around and under the valve and sleeves is mandatory. After completing the tap, the valve shall be flushed to ensure that the valve seat is clean.

1.8.7 FINAL FLUSHING OF WATER MAINS

After disinfection and prior to final acceptance, all new potable water mains shall receive a final flush to clean all parts of the system and to remove all remaining concentrations of heavily chlorinated water.

1.8.8 PIPELINE ALIGNMENTS

- A. Water, sewer and reclaimed water pipelines to be installed within new roadway rights-of-way shall be situated along typical uniform alignments that minimize the number of interferences or obstructions between the different utilities. Appendix A has a matrix of separation requirements for most installed utility mains. Water mains shall be designed to cross over sanitary and storm utilities.
- B. Potable water pipelines shall typically be located along the southerly and easterly sides of the roadways 5 feet away from the back-of-curb line. Fire hydrants shall be installed on the same side of the roadways as the potable water mains. Potable water mains shall be on the opposite side of the street from sidewalks, sanitary force mains and reclaimed water mains.
- C. Force main sewer pipelines shall typically be located on the opposite side of the road from the water mains, generally along the northerly and westerly sides of the roadways and 5 feet away from the back-of-curb line when no reclaimed water pipeline is present; or no closer than 3 feet to the right-of-way line when this side of the road is shared with a reclaimed water main.
- D. Reclaimed water pipelines shall be typically located on the same side of the roads as the force mains (on the northerly and westerly sides) and 3 feet away from the back of curb and 3 feet away from the force mains, when force mains are present; when no force main is present, the reclaimed water main shall be located 5 feet away from the back-of-curb. Fire hydrants on reclaimed water mains shall be on the same side of the roadway as the main.
- E. Where it is demonstrated that it is not technically feasible or economically practical for the sanitary force mains or the reclaimed water mains to be on the opposite side of the street from the potable water mains;

a minimum horizontal separation from the potable water mains shall be 6 feet for force mains and 3 feet for reclaimed water mains, respectively.

- F. Gravity-flow sanitary sewer pipelines shall typically be located under the roadway pavement along the centerline of the right-of-way, and may vary from side to side under curved roadways, but shall be no closer to a potable water main than 6 feet; or no closer to a reclaimed water main than 3 feet; or no closer to a force mains than 3 feet, respectively.
- G. Depth of bury for potable water mains, reclaimed water mains and force mains shall typically be no less than 3 feet and no more than 6 feet of cover at final grade.
- H. Potable water mains, when crossing sewer, reclaimed water mains, and storm pipe, shall cross over the top of the other mains with a minimum of 12 inches of vertical clearance. See Separation Matrix in Appendix A.

Where approved by the County, potable water, reclaimed water or force mains may be buried less than 3 feet deep to avoid an obstruction or another pipeline, provided the potable water mains or reclaimed water mains are constructed of ductile iron pipe or the potable water mains or reclaimed water mains or force mains are enclosed in ductile iron or steel encasement pipes. Increased thrust restraint shall be provided for pipes with less depth of cover. Prior written approval from the County is required before submitting design construction plans for all mains with less than 3 feet; or more than 6 feet of cover, except where short runs are necessary to avoid existing infrastructure; unnecessarily deep mains shall be prohibited.

- I. For preferred horizontal and vertical separation, please refer to the matrix “Manatee County Utility Required Separations” located in the Appendix at the back of this manual.
 - 1. Where it is technically feasible and economically practical, the standard minimum horizontal separations between pipelines shall be practiced.
 - 2. Where it is demonstrated and the County agrees that standard separations are not realistic, the County may approve reductions of the standard separations.
- J. Standard force mains are to be 4 inches and larger in diameter and shall be designed to minimize the adverse effects of air pocket entrapment by either the use of air release valves (ARV’s) or by designing the overall force main system to exceed the minimum air-scouring fluid velocity within the pipeline.
 - 1. Where ARV’s are used, long upward or downward sloping runs of pipeline should be used – rather than laying-to-cover of 3 feet minimum bury, or rather than dipping up and down under other utility structures – and the vertical alignment should be designed such that the number of ARV’s required is limited to the minimum.
 - a. ARV’s shall be placed at high points along the pipeline and where air would otherwise become entrapped.
 - b. For vertical alignments requiring ARV’s, such alignments shall be fully defined and depicted on the construction plans with use of elevation notations at each station or with use of elevations given for all vertical points of intersection and slopes given on the pipeline in between all vertical points of intersection from the lift station to the termination of the force main.
 - c. Any proposed significant deviation from the vertical alignment of the approved construction plans must be resubmitted for checking and re-approval by the Manatee

County Utility Engineering Division representative before such revised vertical alignments may be constructed.

2. Where an air-scouring design is proposed, and air is to be transported downstream along the pipeline by the sufficiently rapid movement of the fluid, no ARV's are required and no strict definition of the alignment by means of elevation and slope notations are required on the plans.

Air-scouring velocity to move air pockets downstream at various downward slopes shall be as determined by Wheeler in Table B-9 of Pumping Station Design, by Robert L. Sanks, 1998, (see Appendix) or as determined by an equally credible source or calculation.

1.8.9 VALVE AND HYDRANT PLACEMENT

- A. In-line potable or reclaimed water valves shall generally be installed at intervals no greater than 1,600 LF on transmission mains, where systems serve widely scattered customers and where future development is not expected; and at intervals of no greater than 800 LF on main distribution loops and feeders, and on all primary branches connected to these lines.
- B. In residential, commercial and industrial subdivisions, water valves shall be installed at intervals no greater than 800 feet.
- C. Valves shall be located on all sides of tees and crosses, unless there is another in-line valve on that leg within 200 feet. At the discretion of the County, valving may be reduced on dead-end streets, where mains have no possibility of being "looped" or connected to other mains.
- D. In-line sewer valves shall be installed at intervals of no greater than 1,200 LF on sewer force mains.
- E. In all instances, for both water and pressure sewer pipes, valves shall be placed to maximize the effectiveness of isolation of the pipelines during maintenance and repairs. Valves shall not be placed in curbs or gutters, blow-off valve assemblies shall not be placed in driveways or sidewalks. In-line water and sewer valves shall be installed near each side of a canal crossing, major road crossing, at all jack and bore crossings, and/or railroad crossings.
- F. An approved backflow prevention assembly shall be placed on private property at the right-of-way line where a public water distribution system crosses over onto private property and becomes a privately maintained system. All valves shall be noted and depicted on the construction and record drawings.
- G. A sewer control valve shall be placed at the property line, where a private sewer force main enters the right-of-way. All valves shall be noted and depicted on the construction and record drawings.
- H. Valves that are located in fields or open spaces shall have a 4" PVC pipe marker inserted by the Contractor adjacent to the concrete pad. The markers shall be a 6 foot length of PVC pipe inserted 2 feet into the ground and shall indicate the type of valve. The marker shall be labeled PWM in "safety" blue for potable water mains, RWM in purple for reclaimed water mains, and FM in green for sanitary force mains, respectively.
- I. Fire hydrants shall be located no more than 800 feet apart and within 400 feet of the main entrance of all non-residential buildings as measured along normal access routes, on the same side of the roadway as the water main. Hydrants shall be placed no closer than 400 feet from the end of the water main as depicted in UW-20 and located on the side property lot lines, unless within 500 feet of another hydrant. Dead-end water mains shall be installed with a blow-off assembly to help address any possible water quality issues. Hydrants shall not be located within 40 feet of any building, except within a right of way or within one-story single-family residential areas.

1.8.10 MINIMUM PIPE FLOW DESIGN CRITERIA

- A. Gravity Sewer Design. A minimum design velocity of 2.0 feet per second and a maximum design velocity of 10.0 feet per second shall be used for the design of gravity-flow pipelines. Maximum design flow depths for peak design flow rates shall not exceed 80 percent of the pipe inside diameter.
- B. Minimum slopes required to achieve a velocity of at least 2.0 feet per second are provided below:

Sewer Pipe Diameter in Inches, I.D.	Minimum Slope in Feet per 100 Feet, Manning's $n = 0.013$
8	0.42 **
10	0.28
12	0.22
14	0.17
15	0.15
16	0.14
18	0.12
21	0.10
24	0.08
27	0.067
30	0.058
36	0.046

** All gravity sewer mains shall meet ten state standards including minimum slopes except for 8" gravity sewer mains. Sewer main 8 inch in diameter shall be laid at a minimum slope of 0.42%, except for terminal runs. Terminal runs shall be laid at 0.50% for the equivalent of 4 single family dwelling units or greater. Anything less shall be laid at 1.00%.

- C. Sewer Force Main Design. Sewer force main velocities shall not be less than 2 feet per second, with one/smallest pump running (at minimum flow) and not exceed 6 feet per second at peak-hour flow conditions. Hazen-William's roughness coefficient of a maximum of 120 will be used in the calculations.
- D. Gravity Sewer, Sewer Force Main, and Lift Station Design. Construction drawings that are submitted to Manatee County for approval shall include engineering calculations, which may include computer hydraulic modeling. Gravity sewer, sewer force main, and lift station design shall be based on peak-hour flow rate. Unless the Engineer of Record provides credible documentation and/or data to support peaking factors used in his or her calculations, peaking factors for peak hour flow rate shall be based on the following equation:

$$\text{Peak-Hour Flow/Average Daily Flow} = (18 + \sqrt{VP}) / (4 + \sqrt{VP})$$

(where \sqrt{VP} = square root of the population in thousands)

(Peak hour factor not to exceed 4)

- E. Water Distribution Main Design. Water mains shall be designed with velocities no greater than 5 feet per second at peak-hour flow conditions and no greater than 10 feet per second at maximum-day plus required fire flow conditions. Hazen-William's roughness coefficient of a maximum of 130 shall be used in the calculations for plastic pipe and lined ductile iron pipe. Delivered flows for pressure water mains shall meet the required fire flow rate plus a background water demand equivalent to the maximum-day demand with a residual gauge pressure not less than 20 pounds per square inch (psi). A residual gauge pressure not less than 20 psi shall be maintained at the peak-hour water demand. Construction drawings

that are submitted to Manatee County for approval shall include engineering calculations, which may include computer hydraulic modeling. Unless the Engineer of Record provides credible documentation and/or data to support peaking factors used in his or her calculations, peaking factors for peak-hour and maximum-day flow rates in potable water main design shall be based on the following equations:

$$Q\text{-Peak} = 2.2 \times \text{Average Daily Flow}$$

$$Q\text{-Max Day} = 1.5 \times \text{Average Daily Flow}$$

1.8.11 DETECTION

- A. All direct buried mains shall have a continuous 6-inch wide, color-coded, electronically detectable path marking tape buried over the main. The path marking tape shall be placed between 12-inches and 24-inches below finished grade, with a 48-inch maximum depth.
- B. All direct buried (excluding gravity sewer) pressure pipe shall have a tracer wire installed along the pipe alignment. The tracer wire to be used shall be a solid, high strength, copper clad steel wire with a polyethylene jacket of appropriate color, as defined in the Approved Products List.
- C. All horizontal directional drilled pipe shall have a tracer wire installed along the pipe alignment. The tracer wire to be used shall be a solid, extra high strength, copper clad steel wire with a polyethylene jacket of appropriate color, as defined in the Approved Products List.
- D. Prior to acceptance of pressure pipe by the County, the Contractor shall demonstrate that the electrically detectable path marking tape and the locator tracer wire functions properly. During the tracer wire testing, the Contractor shall also demonstrate that the wire is connected to all services at meter boxes, hydrants, backflow prevention assemblies, valves, air release valves, and blow-off valves. The Contractor shall use one of several commercially available utility locating instruments to energize and trace the electrically detectable path marking tape and/or locator wire for continuity. Direct signal locate method shall directly apply the current from the transmitter to the tracer wire and the signal shall be detected and followed with a receiver. Submit to the County Inspector for approval the method and equipment to be used. Testing of the electrically detectable path marking tape and locator wire shall be done prior to or concurrent with the hydrostatic pressure test.
- E. A 2" PVC pipe marker with a painted end cap shall be inserted by the Contractor at the ROW line indicating each individual new service location or stub out. The marker shall be a 6 foot length of PVC pipe inserted 2 feet into the ground and shall be painted "safety" blue for potable water, purple for reclaimed water, and green for sewer.

END OF SECTION

SECTION 1.9 TESTING AND INSPECTIONS

1.9.1 DESCRIPTION OF WORK

Timely notice shall be given to the County Inspector of approvals or observations which may be required, and a time and date for a field visit shall be scheduled. Provide all materials, equipment, supplies and labor as required to complete the testing or inspection operations. Should any test fail, the causes of failure shall be corrected, and the work shall be retested until all test requirements have been successfully met.

1.9.2 FIELD VISITS

Field tests or observations which require the presence of a County Inspector shall be scheduled on weekdays during normal working hours. A minimum of two full days' notice, not counting weekends, shall be provided to the inspector in advance of when the test is to be conducted. Any requests for emergency test scheduling must be made in writing, stating why the test should be scheduled ahead of tests for other jobs.

1.9.3 PIPELINE INSPECTIONS

- A. During the County Inspector's routine inspections of construction, the County Inspector shall observe that the pipe interior, fittings, valves and other appurtenances are thoroughly cleaned of all dirt, debris and obstructions before being lowered into the trenches; and that the interior of all pipelines are kept clean during and after installation; and that all open pipe ends are securely plugged or capped water-tight when construction stops during the day, or during lunch, or overnight or during long periods of inactivity.
- B. All thrust restraint devices on pressure pipelines shall be checked and approved by the County Inspector before backfilling.
- C. The County Inspector shall be present during the flushing and pigging operations and verify that final discharges are clear and free of debris.

1.9.4 COMPACTION TESTING

- A. Compaction testing shall be performed per Section 1.3 Trenching and Excavation, 1.3.7 - Backfill.

1.9.5 MATERIALS CLASSIFICATION

Soils and soil-aggregate mixtures used as backfill materials shall be identified according to the AASHTO system, designation M-145.

1.9.6 FLOW TESTS

Measurements of static, pitot, and residual pressures and available fire flow, for use in the design of water distribution systems, shall be made using the two-hydrant method (or additional hydrants as required) as described in AWWA Publication M17, "Installation, Field Testing, and Maintenance of Fire Hydrants". Flow tests obtained and utilized as boundary condition for hydraulic modeling must be performed no later than within a year of the initial construction plan submittal.

1.9.7 HYDROSTATIC TESTING OF PRESSURE PIPELINES

- A. After the water mains, reclaimed water mains or sewer force mains are installed complete, and the fire hydrants, valves, fittings, blow-offs and restraining devices are permanently installed, and the trenches are backfilled, the new pipelines shall be tested hydrostatically for leakage.
- B. The County Inspector shall have been notified and shall be present during hydrostatic testing procedures. The Contractor and an Engineer of Record representative shall also be present during the tests.
- C. All excavations for any utility pipes or cables within the rights-of-way or easements must be complete before a hydrostatic test is performed. Any subsequent digging or boring across the water, sewer or reclaimed pipelines after they have been tested shall result in a requirement for the pipelines to be retested.
- D. All mains to be tested shall be cleaned as specified in these Standards to remove all dirt, stones, pieces of wood or any other material which may have entered the lines during construction. Any obstructions remaining shall be removed.
- E. Pipelines to be tested shall have been allowed to remain in place undisturbed for at least 24 hours to allow time for all joints to develop a complete seal. All potable water services and reclaimed water services are to be installed complete with curb stops, resetters and meter boxes prior to beginning the test. Gate valves on fire hydrant laterals shall be opened so that the test pressure bears against the closed hydrant valve.
- F. Discharged flows from cleaning or flushing operations shall be disposed of in a manner consistent with US EPA, FDEP, and SWFWMD regulations.
- G. Only one connection to the existing water supply system shall be allowed prior to acceptance of the main. Connection shall be made through an approved backflow prevention assembly. Air shall be expelled completely from the section of pipeline to be tested. If air can not be fully expelled, ARV's shall be required at the high points to ensure proper function of the mains. After the hydrostatic test has been successfully completed, the corporation stops, located at the temporary jumper connection, are to be closed and plugged with brass or PVC stops.
- H. The hydrostatic test duration shall be at least two hours. The test pressure at the beginning of the test shall be 180 psi for water mains and reclaimed water mains and shall be 150 psi for sewer force mains. The water supply, and the water supply pump, shall be disconnected during the test. The test pressure shall not vary by more than plus or minus 5 psi during the test. If the pressure drops 5 psi, makeup water shall be pumped into the test pipeline section during the test duration to maintain the pressure to within 5 psi of the test pressure and the amount of leakage measured. The total amount of makeup water added shall be measured and shall be compared to the allowable leakage.
- I. The allowable leakage measured during the test duration for DI and PVC pipe shall be as determined by the following formula:

$$L = \frac{SD\sqrt{P}}{148,000}$$

where,

L = testing allowance (makeup water), gallons per hour

S = length of pipe tested, feet

D = nominal pipe diameter, inches

P = test pressure, psi (gage)

or, as determined by Table 5A of the Hydrostatic Testing section of AWWA C600.

- J. The maximum length of pipe to be hydrostatically tested shall be 2,600 feet. If an exception to this rule is granted by the County's authorized representative, and a length of pipeline greater than 2,600 feet is tested, the allowable leakage will still be figured for a 2,600-foot length of pipeline.
- K. Force mains shall be pressurized for testing between the above-ground valve assembly at the lift station and the valve at the termination to the existing force main system or at the termination to the gravity system manhole.
- L. Any exposed pipe sections, valves, fittings, hydrants, services and pipe joints shall be carefully observed during the test duration. All visible leaks shall be repaired, regardless of the amount of leakage.
- M. Any damaged or defective pipeline components that are discovered after the hydrostatic testing shall be repaired or replaced with standard materials, and the test shall be repeated until a satisfactory test result is achieved. Any modifications to the new pipeline made after a successful hydrostatic test has been performed shall be cause for a new hydrostatic test of the same pipeline to be performed again.
- N. No pipeline installation shall be accepted if the amount of make-up water is greater than the allowable leakage. In the event of a failed test result, locate all leaks and make repairs or replacements as required, and retest the pipeline until the leakage is within the allowable limit.
- O. When the test has been completed successfully, blow off the pressure from the opposite end of the line from the water supply connection, to demonstrate the limits of the length of pipeline subjected to testing. Also, flush water from all hydrants, services and blow-offs, to demonstrate that they were on-line during the test.
- P. The section of pipeline being tested shall be identified on the Charge Sheet Inspection Report. The stationing numbers from the construction survey shall be used to describe the extent of the tested pipelines, if available. The exact lengths and sizes, and the precise extents of the tested pipelines, and the particular valves being tested against, must all be identified clearly on the Charge Sheet. A copy of the Charge Sheet shall be provided to the Engineer of Record's and the Contractor's representative.
- Q. A punch list shall be made at the end of all tests.
- R. Hydrostatic Testing for HDPE Pipelines:
 - 1. For pressure pipelines laid wholly using HDPE pipe, a modified hydrostatic test is required. In the modified test, the pipeline shall be cleaned, flushed, filled and vented, and otherwise prepared for testing similar to other types of pipeline materials; but, prior to the test, an initial expansion period at test pressure shall be allowed, during which the HDPE pipe shall be allowed to stretch and assume an equilibrium volume against the applied pressure. During the expansion period, make-up water shall be added to the pipeline to maintain the test pressure. If pressure testing dissimilar materials (PVC and HDPE, etc.) the test shall use the PVC standard for allowable leakage. Otherwise test the HDPE individually.
 - 2. After the initial expansion period, the test shall commence, and shall proceed in accordance with the methods presented in Chapter 2, "Inspections, Tests and Safety Considerations" of the Handbook of Polyethylene Pipe, Plastics Pipe Institute, or using information provided by the pipe manufacturer for the material and class of pipe installed and conducted in accordance with ASTM F2164, unless otherwise approved by the County. In the event of a test failure, locate and repair

the cause of the leakage and retest the pipeline. Repair all visible leaks regardless of the amount of leakage.

1.9.8 BACTERIOLOGICAL TESTING

- A. After the new potable water pipelines have been hydrostatically tested, or after existing potable water pipelines have been modified or repaired, they shall be cleaned, disinfected and sampled and tested for the presence of coliform organisms in accordance with AWWA C651.
- B. See Section 1.10 Cleaning and Disinfecting Water Pipelines.

1.9.9 INSPECTION OF PRECAST CONCRETE STRUCTURES

- A. Precast portland or polymer concrete manhole bases, sections and tops, utility vaults, and wet wells shall be subject to inspection and approval by the County.
- B. The County Inspector will carefully examine the structures for compliance with ASTM C 478, these Standards, and the manufacturer's shop drawings. All structures will be inspected for dimensions, cracks, voids, blisters, roughness, soundness, scratch strength, and general appearance. After installation, there shall be no visible leaks within the manholes, utility vaults and wet wells.
- C. Structures with minor imperfections may be repaired, subject to the approval of the County's Representative, after demonstration by the manufacturer that such repairs will result in strong and permanent restorations. All visible leaks in the manhole structures shall be repaired. Repair leaks by injecting a moisture activated polyurethane type injection resin grout. The County Inspector shall have been notified and shall be present during the repair and retesting. Repairs shall be carefully examined by the County Inspector before final approval by the County.

1.9.10 AIR TESTING OF GRAVITY SEWER MAINS

- A. Gravity sewer pipes shall be tested for leakage by performing the low-pressure air test. The County Inspector shall have been notified and shall be present during the pressure test.
- B. All excavations for any utilities or cables within the rights-of-way or easements must be complete before a low-pressure air test is performed. Any subsequent digging or boring across the gravity sewer pipes after they have been tested shall result in a requirement for the sewer system to be retested.
- C. The sewer pipes to be tested shall be flushed and cleaned prior to the test to remove dirt, debris or obstructions.
- D. Each pipe section tested shall be the length of pipe between two manholes. The ends of all branches, laterals, tees, wyes and stub-outs included in a test section, as well as the ends of the pipe section to be tested, shall be plugged to prevent any air leakage, and all plugs shall be secured in place to prevent blowouts due to the internal test pressure.
- E. The test pressure shall be no less than 3.5 psi and no more than 9 psi. The specific test pressure shall be determined by the average height of the natural ground water table above the pipe springline. The elevation of the ground water table shall be measured by using a test well, or by digging a test pit, or by other approved methods, or the County Inspector may accept an assumption of the surface of the ground or pavement for the ground water table elevation. The height of the ground water table above the test pipe section shall be the average of the height above the inlet of the pipe and the height above the outlet of the pipe.

- F. The test pressure shall be calculated individually for each test section of pipe and shall be as determined by the following formula:

$$P = 3.5 + 0.43H \quad P \leq 9$$

where,

P = test pressure, psi (gage)

H= average height of ground water table above pipe springline, feet

- G. Air shall be pumped into the test section of pipe until the pressure inside reaches the test pressure. After the pressure has been stabilized at the test pressure, remove the connection from the pressurized air source and begin the test duration. The test duration shall be as indicated in the following table:

**LOW PRESSURE AIR TEST
SPECIFICATION TIME REQUIRED FOR A 1.0 PSIG PRESSURE DROP
FOR SIZE AND LENGTH OF PIPE INDICATED FOR Q = 0.0015**

L = length of test section, feet.

1. Pipe Diameter (in.)	2. Minimum Time (min: sec)	3. Length for Minimum Time (ft.)	4. Time for Longer Length (sec)	Specification Time for Length (L) Shown (min: sec)								
				100 ft	150 ft	200 ft	250 ft	300 ft	350 ft	400 ft	450 ft	
4	3:46	597	.380 L	3:46	3:46	3:46	3:46	3:46	3:46	3:46	3:46	3:46
6	5:40	398	.854 L	5:40	5:40	5:40	5:40	5:40	5:40	5:40	5:42	6:24
8	7:34	298	1.520 L	7:34	7:34	7:34	7:34	7:36	8:52	10:08	11:24	
10	9:26	239	2.374 L	9:26	9:26	9:26	9:53	11:52	13:51	15:49	17:48	
12	11:20	199	3.418 L	11:20	11:20	11:24	14:15	17:05	19:56	22:47	25:38	
15	14:10	159	5.342 L	14:10	14:10	17:48	22:15	26:42	31:09	35:36	40:04	
18	17:00	133	7.692 L	17:00	19:13	25:38	32:03	38:27	44:52	51:16	57:41	
21	19:50	114	10.470 L	19:50	26:10	34:54	43:37	52:21	61:00	69:48	78:31	
24	22:40	99	13.674 L	22:47	34:11	45:34	56:58	68:22	79:46	91:10	102:33	
27	25:30	88	17.306 L	28:51	43:16	57:41	72:07	86:32	100:57	115:22	129:48	
30	28:20	80	21.366 L	35:37	53:25	71:13	89:02	106:50	124:38	142:26	160:15	
33	31:10	72	25.852 L	43:05	64:38	86:10	107:43	129:16	150:43	172:21	193:53	
36	34:00	66	30.768 L	51:17	76:55	102:34	128:12	153:50	179:29	205:07	230:46	

Source: Uni-Bell Handbook of PVC Pipe.

- H. No more air shall be added to the test section during the test duration. The allowable drop in pressure during the test duration shall be 1 psi or less. No gravity sewer main installation shall be accepted if the pressure drop during the test duration is greater than 1 psi.
- I. In the event of a failed test result, locate all leaks and make repairs or replacements as required, and retest the sewer main until the leakage is within the allowable limit. All visible leaks in sewer pipes or at connections to manholes shall be repaired regardless of the results of the low-pressure air tests.

- J. Any damaged or defective sewer main or service lateral components that are discovered after the low-pressure air testing shall be repaired or replaced with standard materials, and the test shall be repeated until a satisfactory test result is achieved. Any modifications to the new sewer collection system made after a successful test has been performed shall be cause for a new low-pressure air test of the same sewer main to be performed again.

1.9.11 DEFLECTION TESTING OF GRAVITY SEWERS (MANDREL TESTING)

- A. The Contractor shall perform a pipe ring deflection test on all new gravity sanitary sewer mains. The rigid ball or mandrel used for the ring deflection test shall have a diameter not less than 95 percent of the base inside diameter or average inside diameter of the pipe depending on which is specified in the ASTM C 3034, to which the pipe is manufactured. The test shall be performed without mechanical pulling devices.
- B. The allowable ring deflection is 5 percent of the inside pipe diameter. Pipes that have a ring deflection that exceeds this amount shall not be accepted.

1.9.12 TELEVISION INSPECTION OF GRAVITY SEWERS

- A. TV inspection of the entire length of the inside of new gravity sewer mains shall be conducted by the Contractor. The County Inspector shall have been notified and shall be present during the TV inspection.
- B. The sewer pipelines shall be thoroughly cleaned of all dirt, debris or obstructions before the TV inspection. Water shall be added to the upstream manhole until it is seen flowing from the most downstream point of the system to be inspected.
- C. The TV camera shall be a self-propelled, 360-degree pan-head, color type and shall have dual DVD recording capability. The camera shall be equipped with a depth gauge calibrated to 1/4-inch increments to accurately record the depth of the water in the pipeline. A calibration report shall be submitted with each digital video disk (DVD), which shall include a drawing of the depth gauge, indicating the marks on the gauge, and what depth each mark represents.
- D. The County Inspector shall be present and will observe the TV monitor along with the camera operator as the camera progresses through the pipe. All pipelines will be inspected with the camera progressing in an upstream direction when possible. The camera operator shall record the manhole numbers and the distance the camera has progressed from the downstream manhole as the inspection proceeds. The operator shall stop the progress of the camera and record the distance at all locations along the pipeline where unusual or defective features are encountered. The operator shall record the distance and depth of the water in the pipe at all locations where the depth is greater than or equal to 3/4 inch. The camera operator shall make records where cracked, dented or deformed pipe is found, or at joints that are not properly installed, or where infiltration is observed, or at any other abnormality or where any other defective feature is encountered.
- E. At the end of the inspections, or at the end of the day, one original digital video disk (DVD) of the TV record shall be submitted to the County Inspector along with the written inspection report and depth gauge calibration for evaluation. The County's representative shall be the sole judge of whether any information imparted by the TV test DVD will cause the County to accept or reject the pipe test section.
- F. Pipe grade between manholes shall not deviate ("dip") by more than 1 inch from the design grade line, as measured with the television (TV) camera's depth gauge during the TV inspection, provided that such deviation does not result in a level or a reverse slope in the mains or service laterals. Joint deflection and longitudinal pipe deflection between manholes that exceeds 1 inch; or more than two deflections that

exceed 3/4 inch, as measured with the television camera’s depth gauge during the TV inspection, shall not be accepted.

	Water Holding Depth (inches)
Pipe Size	Maximum
8 inch – 15 inch	1.00
18 inch – 21 inch	2.00
24 inch and greater	2.50

1.9.13 LIFT STATION INSPECTIONS

- A. Prior to placing a sanitary sewer lift station into service, the new facility will be inspected for general compliance with the County’s standards and for conformance to the pump performance required by the construction drawings.
- B. The County Inspector shall have been notified and shall be present during the pump start-up tests. When calling for inspection, the lift station Contractor shall have ready the approved shop drawings, pump sheet, manufacturer’s information and maintenance manuals for the facility and he shall present them to the County at the time of the inspection. The manufacturer’s information shall include the model number, serial number, impeller diameter, motor horsepower, voltage, speed and certified performance curve for each pump installed. Provide County’s Lift Station Maintenance Section with one copy of the lift station information described above at startup.
- C. The total dynamic head for each pump shall be found by direct measurement. The performance of each pump shall be in substantial conformance with the design performance requirement as indicated on the construction drawings. The Contractor shall perform a “draw down” test and a “dead head” test for each pump.
- D. Any materials or installation found not in compliance with the County standards shall be reinstalled or removed and replaced with standard materials. Any pumps found to be not conforming to the performance required by the construction drawings shall be removed and replaced with conforming pumps. Replacement pumps shall be retested until a satisfactory result is achieved. Manatee County Public Works Department and Utilities Department representatives shall be the sole judges of the suitability and acceptability of the pumps.
- E. Fiberglass Wet wells And Valve Vaults
 - 1. Wet wells and valve vaults for privately owned and maintained grinder lift stations may be fiberglass. The manufacture, dimensions, material and construction methods shall be made available for review by the County and shall be approved by the Engineer of Record in advance of construction.
 - 2. The quality of all materials, the process of manufacture and the finished wet wells and valve vaults shall be subject to inspection and approval by the Engineer of Record and the County Inspector. Such inspection may be made at the place of manufacture, on site, or both locations. The fiberglass wet wells and utility vaults may be inspected prior to unloading from the delivery truck and marked by the inspector showing acceptance or rejection. Discovery of failure at any time to meet the requirements of these Specifications is cause for rejection.

3. Wet wells and valve vaults rejected after delivery to the job shall be marked for identification and shall be removed from the job at once. All wet wells and valve vaults which are damaged after delivery as determined by the Engineer of Record or County Inspector shall be rejected and shall be removed and replaced entirely at the Contractor's expense.
 4. Fiberglass wet wells and valve vaults shall be fabricated in compliance with ASTM D3753, and constructed in accordance with the manufacturer's shop drawings and the approved construction drawings. Structures shall be inspected for general appearance, correct dimensions, blisters, cracks, holes, roughness, and soundness and must be free of defects.
 5. Minor imperfections may be repaired subject to the approval of the Engineer of Record and County Inspector and after demonstration by the manufacturer that repairs will be strong and permanent.
 6. There shall be no leaks in the fiberglass structures.
- F. Lift stations will not be accepted for County ownership and maintenance until all punch list items are resolved. This includes security fence and driveways, landscaping when required, irrigation, water meter, and an FDEP acceptance letter.

END OF SECTION

SECTION 1.10 CLEANING AND DISINFECTING WATER PIPELINES

1.10.1 DESCRIPTION OF WORK

Furnish all labor, materials, equipment and incidentals required to clean and disinfect portable water pipelines. This work is required to place all potable water pipes into service.

1.10.2 CLEANING WATER MAINS

- A. With the County Inspector present, all new potable and reclaimed water mains shall be preliminarily cleaned (pigged or flushed) in accordance with Paragraph 1.8.5.X of this Manual.
- B. Fire hydrants may be used to perform flushing. A blowoff connection, if one has been installed, may also be used if diameter is determined to be large enough to flush debris. A velocity of at least 3.0 ft/sec, preferably 3.5 ft/sec, should be obtained in the pipe without causing the County's main pressure to fall below 35 psi. This velocity should be maintained long enough to allow three complete changes of water for proper flushing action and follow the requirements in Sections 1.8.5.X and 1.8.6.

1.10.3 DISINFECTING POTABLE WATER PIPELINES

- A. Prior to being placed in service, all potable water pipelines shall be chlorinated in accordance with AWWA C651. The location of the chlorination and sampling points shall be determined by the Engineer of Record, FDEP, and Manatee County's representative. Taps for sampling shall be uncovered and backfilled by the pipeline installer as required.
- B. The general procedure for chlorination shall be to flush or pig all dirty or discolored water from the lines, then introduce chlorine at 25 mg/L of free chlorine through a tap at one end while water is being withdrawn at the other end of the line. The chlorine concentration shall be measured at regular intervals to ensure that it is fed at a constant rate of not less than 25 milligrams per liter (mg/L) of free chlorine. The chlorine solution shall remain in the pipeline for 24 hours.
- C. At the end of the chlorine contact period, the chlorine residual shall be determined by sampling and testing, and the results shall be reported to the regulatory agencies with the County and State. The pipelines shall then be flushed thoroughly with clean potable water until chlorine measurements show that the concentration is no higher than the chlorine concentration that is acceptable for domestic use.
- D. Water for flushing, pigging, filling and disinfecting the new lines must be obtained without contaminating existing pipelines. Water obtained from existing pipelines for this purpose shall pass through an approved backflow prevention assembly. See UW-23, Temporary Jumper Connection Detail.
- E. Following the chlorination period, all concentrations of heavily chlorinated water shall be flushed from the lines at their extremities and replaced with water from the distribution system. Bacteriological sampling and analysis of the replacement water shall then be made by an approved laboratory in full accordance with the AWWA Manual C651. The line shall not be placed in service until the requirements of the State are met. Results of the bacteriological tests together with certified record drawings must be submitted to FDEP within 60 days of the tests. Pipelines that are tested and return an unsatisfactory test result shall be reflushed and resampled, or re-disinfected, or otherwise reconditioned, until a satisfactory result is attained.
- F. Discharge flows from cleaning or flushing operations, and heavily chlorinated water from disinfecting operations, shall be disposed of in a manner consistent with US EPA, FDEP and SWFWMD regulations. Chapter 62-302 F.A.C. water quality standard for residual chlorine in Class III waters is <0.01 mg/L (ppm).

- G. Special disinfecting procedures, when approved by the County, may be used where the method outlined above is not practical.
- H. No potable water main shall be placed into service until the results of the bacteriological tests are satisfactory and the FDEP has provided the County with a written letter of acceptance. Potable water services, fire service, and fire hydrant leads that are exempt from a permit from the FDEP but still require bacteriological sampling in accordance with Chapter 62-555, Florida Administrative Code, shall not be placed into service until the results of the bacteriological tests are satisfactory and the Manatee County Public Works Engineering Department has provided written acceptance

END OF SECTION

SECTION 1.11 VALVES AND APPURTENANCES

1.11.1 DESCRIPTION OF WORK

Furnish all labor, materials, equipment and incidentals required and install complete and ready for operation all valves and appurtenances as indicated on the construction drawings and as specified herein.

1.11.2 GENERAL REQUIREMENTS

- A. All of the types of valves and appurtenances shall be products of well-established reputable firms who are fully experienced and qualified in the manufacture of the particular equipment to be furnished. The equipment shall be designed, constructed and installed in accordance with the best practices and methods and shall comply with these standards as applicable. Valves used in waterworks applications shall comply with Section 8 of NSF Standard 61 for mechanical devices.
- B. The brass alloy used for all surfaces coming in contact with potable water shall meet the requirements of UNS/CDA number C89833 as listed in ANSI/AWWA C800 Standard and the products produced with this alloy shall meet the ANSI/NSF Standard 61 and/or ANSI NSF Standard 372 as applicable, complying with the Safe Drinking Water Act. These products shall have the letters "NL" cast into the main body for proper identification.
- C. All of the equipment and materials specified herein are intended to be standard for use in controlling the flow of potable water, reclaimed water, wastewater, etc., depending on the applications.
- D. All valves and appurtenances shall be of the size shown on the drawings and, to the extent possible, all equipment of the same type on the project shall be from a single manufacturer.
- E. All valves and appurtenances shall have the name of the manufacturer, year, and the working pressure for which they are designed cast in raised letters upon some visible part of the body.
- F. Special tools, if required for the normal operation or maintenance, shall be supplied with the equipment.
- G. All valves are to have a 2-inch square cast or ductile iron AWWA operating nut and shall open left (counter-clockwise) and shall be located at the bonnet or actuator. Provide 304 stainless steel extension stems and alignment rings where needed to bring the operating nut to within 4 feet below the valve box lid.
- H. All hand actuated buried valves shall have two-piece adjustable valve box.
- I. Water and reclaimed water system isolation valves shall be gate valves.
- J. Force main system isolation valves shall be plug valves up to 20-inch diameter and gate valves greater than 20-inch diameter. Taps shall only use tapping valves no matter what size.
- K. All bonnet bolts, gland bolts, flange connection bolts, nuts, washers, and other trim hardware exposed to the outside environment shall be 316 stainless steel. Above-ground thrust collar tie-rod bolts shall be 316 stainless steel. All underground mechanical joint-type bolts, nuts, washers, tie-rod bolts, etc. shall be high strength low alloy steel per AWWA C111 and shall be certified fluoropolymer coated or shall be 316 stainless steel.
- L. All valves shall have a factory applied, fusion bonded epoxy coating on the interior and exterior unless otherwise noted in the plans or the following specification. Valves shall meet AWWA C550 fusion bonded epoxy 8 mils, unless otherwise stated in the Approved Material List. All other painted items exposed to sunlight, including field painted box lids, etc., shall be painted the appropriate color with an epoxy type paint.

- M. No valves with a break-away stem shall be allowed.
- N. All valves shall have concrete blocking to ensure against settlement. All shall be protected with a double wrap of 8-mil polyethylene film to allow for disassembly and repair of the fitting or appurtenance.
- O. A holiday-free certification letter shall be provided to the County, at time of delivery, stating the internal coating of the valve has passed the Holiday testing in accordance with ASTM G62, Method A (Low Voltage). The Contractor shall take extreme consideration when handling valves to ensure coating does not get damaged during construction activities or installation. County representative shall have the right to deny the installation of the valve, if the coatings are damaged.

1.11.3 DIRECTORY

The following valves and appurtenances are specified herein:

<u>Equipment</u>	<u>Paragraph</u>
Gate Valves	1.11.4
Combination Pressure Reducing and Pressure Sustaining with Check Valve Option	1.11.5
Ball Valves	1.11.6
Plug Valves	1.11.7
Valve Actuators	1.11.8
Air Release Valves	1.11.9
Valve Boxes	1.11.10
Corporation Stops and Saddles	1.11.11
Flanged Adapters and Plain End Couplings	1.11.12
Hose Bibs	1.11.13
Swing Check Valves	1.11.14
Swing-Flex Check Valves (for water & reclaimed only)	1.11.15
Hydrants	1.11.16
Restrained Joints	1.11.17
Tapping Sleeves, Saddles, and Valves	1.11.18
Tracer Wire Boxes	1.11.19

1.11.4 GATE VALVES

- A. Where indicated on the drawings or necessary due to locations, size, or inaccessibility, chain wheel operators shall be furnished with the valves. Such operators shall be designed with adequate strength for the valves with which they are supplied and provide for easy operation of the valve. Chains for valve operators shall be galvanized.
- B. Gate valves installed underground shall be provided with a box cast in a concrete pad and a box cover. 304 stainless steel valve extension stems shall be provided to place the valve operating nut no more than 4 feet deep. One valve wrench, 6 feet in length, shall be provided for every 15 valves installed.
- C. Gate valves 2 inches to 30 inches in diameter shall be resilient seated, manufactured to meet or exceed the requirements of AWWA C515 and shall be UL listed and FM approved where applicable. Valves shall have an unobstructed waterway equal to or greater than the full nominal diameter of the valve.
- D. Gate valves 16 inches and larger shall be provided with torque limiters.
- E. All valves shall be NSF 61 listed.

- F. All buried valves shall have a non-rising 304 stainless steel stem. All exterior bolts, nuts and washers on buried valves shall be 304 stainless steel. Aboveground valves at lift stations shall be of the non-rising type with 316 stainless steel stems. Aboveground valves used in potable water and reclaimed water systems shall be OS&Y type with flanged joints and 316 stainless steel stems. All aboveground valves shall have 316 stainless steel exterior bolts, nuts and washers. Manufacturer shall use Never-Seez or equivalent during assembly of bolt and nut sets to prevent galling of similar metals. Stem seals shall be provided and shall be of the O-ring type, two above and one below the thrust collar.
- G. The wedge shall be ductile iron fully encapsulated with an EPDM rubber. The Elastomer type shall be permanently indicated on the disc or body of the valve. The resilient sealing mechanism shall provide zero leakage at the water working pressure when installed with the line flow in either direction.
- H. The valve body, bonnet, and bonnet cover shall meet or exceed all the requirements of AWWA C515. All valves shall have "DI" cast into the body of the bonnet.
- I. Gate valves meeting AWWA C515 requirements shall be rated for an operating pressure of 250 psi and shall be tested in accordance with AWWA C515.
- J. The valves shall be covered by a Manufacturer's 10-year warranty on manufacturer's defects and reasonable labor costs for replacement. Warranty shall become effective from the date of purchase by the end user and delivered within 30 days from the receipt of the purchase order. For publicly owned and maintained utilities, the end user is Manatee County Government.
- K. Gate valves shall be assembled and tested in a certified ISO 9001:2000 manufacturing facility within the United States and provide their certification of meeting internationally recognized quality control procedures.

1.11.5 COMBINATION PRESSURE REDUCING & PRESSURE SUSTAINING VALVE WITH CHECK VALVE OPTION

- A. Pressure sustaining and check valve shall be pilot operated diaphragm actuated valve with cast iron body, bronze trim, and 125-pound flanged ends. The valve shall be hydraulically operated, diaphragm type globe valve. The main valve shall have a single removable seat and a resilient disc, of rectangular cross section, surrounded on three and a half sides. No external packing glands are permitted and there shall be no pistons operating the main valve or any controls. The valve shall be equipped with isolation valves to service the pilot system while permitting flow if necessary. Main valve and all pilot controls shall be manufactured in the United States of America. Valve shall be single chamber type, with stainless steel stem.
- B. Valve shall automatically reduce pressure for the downstream distribution network and sustain a minimum pressure in the high pressure main regardless of distribution demand, and as an option, shall also close when a pressure reversal occurs for check valve operations. The pilot system shall consist of two direct acting, adjustable, spring loaded diaphragm valves.
- C. Valve shall be ductile iron with main valve trim of brass and bronze. The pilot control valves shall be cast brass with 303 stainless steel trim.

1.11.6 BALL VALVES (SEE ALSO GENERAL REQUIREMENTS)

- A. Ball valves for water and reclaimed water, in sizes 3/4-inch through 2-inch, shall be lead-free (NL), 1-piece brass body, stem and ball per ASTM B 62, full port, full flow, 1/4-turn check w/ padlock wings, ball curb valves, rated for 300 psi, with compression, pack joint, flare, threaded or flanged ends as required. These products shall have the letters "NL" cast into the main body for proper identification.

- B. Ball valves for wastewater, 2-inch through 3-inch, shall be 316 stainless steel 2-piece body, cap, stem and ball per ASTM A351, full port, full flow, 1/4-turn check, ball valves, steam rated for 150 psi, pressure rating 1,000 psi CWT, with threaded or flanged ends as required
- C. All valves shall be mounted in such a position that valve position indicators are plainly visible. Above grade ball valves shall have a vinyl coated lever handle. Lever handle, handle nut, and lever packing gland shall be 304 or 316 stainless steel.
- D. Potable plastic service pipe material and compression and pack joint connectors shall not be used in soil that is contaminated with low molecular-weight petroleum products, aromatic hydrocarbons, chlorinated hydrocarbons or organic solvents. Appropriate service tubing (copper "K or L" or min. 304 stainless steel) shall apply.

1.11.7 PLUG VALVES

- A. Plug valves shall be eccentric, non-lubricating type with integral plug and shafts and shall be furnished with end connections and with actuating mechanisms as called for on the construction plans or as otherwise required. Valves shall seal bubble-tight or water drop-tight in both directions when tested according to the Leakage Test method of AWWA C517-16 with a hydrostatic pressure of 175 psi for 2"-12" diameter; and 150 psi for larger than 12" diameter.
- B. Plug valves shall have a full-port (full-bore), round/circular cross-sectional area of the nominal pipe size area. The internal opening shall have an unobstructed waterway equal to the full circular cross-sectional area of the inside diameter of the pipe it is attached.
- C. Plug valves shall also be subjected, at the factory, to the Hydrostatic Testing specified in AWWA C517-16. The shell test shall be performed at a hydrostatic pressure of 1-1/2 times the design pressure of the valve. The seat test shall be at least 2 times the design pressure of the valve. During the test, there shall be no leakage through the metal, or through the end joints or shaft seal, nor shall any part of the valve be deformed.
- D. Flanged valve ends shall be faced and drilled according to ANSI B 16.1, Class 125. Mechanical joint valve ends shall conform to AWWA C111. Threaded ends shall conform to the NPT requirements of ANSI B1.20.1.
- E. The plug valve body, bonnet and gland shall be cast iron per ASTM A126, Class B or ductile iron grade 65-45-12 per ASTM A526 in accordance with AWWA C517-16. The integral plug and shaft shall be ductile iron grade 65-45-12 per ASTM A526, or 316 stainless steel. The entire plug and stem shall be covered with nitrile (Buna N) rubber. Per AWWA C517-16, the rubber compound shall have been vulcanized to the metal plug/stem and shall have a minimum strength of not less than 250 psi when tested according to ASTM D429, Method A or shall have a peel strength of not less than 75 psi when tested according to ASTM D 429, Method B. Valve seats for sizes 3-inch and larger shall be at least 95 percent pure nickel, welded-in overlay into the cast iron or ductile iron body. The top and bottom shaft bearings shall be sintered, oil impregnated 316 stainless steel.
- F. Below grade valves shall have a manufacturer standard heavy-duty worm gear type actuator with 2-inch square operating nut. The gearbox shall be externally adjustable and totally enclosed to prevent water infiltration. Actuators for buried service valves shall be not less the 90% grease packed and totally sealed by means of gaskets or o-rings. Actuators shall be self-locking and designed to transmit twice the required actuator torque without damage to the faces of the gear teeth. Gearboxes shall be certified to meet ISO 9001 standards. The gearbox worm gear shall be hardened steel or ductile iron ASTM A536 Class

65-45-12. Gearbox shaft shall be manufactured of hardened steel. Gearbox bearings shall be high efficiency, oil impregnated, manufactured of bronze or hardened steel.

- G. Plug valves shall be installed side-ways with plug shaft horizontal so that the plug rotates upward when it opens, with the flow entering the seat end of the valve.
- H. All plug valves shall be internally and externally coated with a factory applied, two-part high solids epoxy conforming to AWWA C550, dry film thickness as defined in the Approved Products List.

1.11.8 VALVE ACTUATORS AND TORQUE LIMITING DEVICES

Gate, Tapping, and Plug Valve Torque-Limiting Devices:

- A. Gate, tapping, and plug buried valves that are furnished with a gearbox shall also require a valve torque-limiting device to prevent valve and actuator damage caused by excessive operating torque.
- B. The overtorque protection mechanism enclosed in a hermetically sealed cast iron housing and permanently lubricated with molydisulfide-bearing, water-resistance, high pressure synthetic grease.
- C. The housing shall have integrally cast, 2-inch AWWA operating nut and matching socket to operate and to fit over the actuator or extension shaft nut, respectively. The socket shall be provided with a set screw to fit to the device.
- D. The torque limiting device shall transmit sufficient torque to free up and operate the valve and shall be factory set to 1.5 times the input torque of the valve provided that the trip limit is at least 100 ft-lb less than the valve breaking torque. For the torque limiting device setting, refer to the Approved Products List.
- E. The torque limiting device shall be internally and externally coated with a fusion-bonded epoxy and enamel top-coat conforming to AWWA C-213.
- F. All hardware shall be minimum 304 stainless steel.
- G. The torque limiting device shall be furnished per the latest edition of the County's Approved Products List.

Manual Actuators:

- A. Manual actuators shall be of the traveling nut, self-locking type or of the worm gear type and shall be designed to hold the valve in any intermediate position between fully open and fully closed without creeping or fluttering.
- B. Actuators shall be capable of seating and unseating the disc against the full design pressure and velocity, as specified for each class, into a dry system downstream, and shall transmit a minimum torque to the valve. Actuators shall be rigidly attached to the valve body.
- C. Actuators shall be equipped with mechanical stop-limiting locking devices to prevent over travel of the disc in the open and closed positions. They shall turn counter-clockwise to open valves.
- D. Valves located above grade shall have handwheel and position indicator, and valves located below grade shall be equipped with a 2-inch square AWWA operating nut located at ground level and cast iron extension type valve box.
- E. Manual actuators shall have permanently lubricated, totally enclosed gearing with handwheel and gear ratio sized on the basis of actual line pressure and velocities.

Motor Actuators (Modulating):

- A. The motor actuated valve controller shall include the motor, actuator unit gearing, limit switch gearing, limit switches, position transmitter which shall transmit a 4-20 mA DC signal, control power transformer,

electronic controller which will position the valve based on a remote 4-20 milliamp signal, torque switches, bored and key-wayed drive sleeve for non-rising stem valves, declutch lever and auxiliary handwheel as a self-contained unit.

- B. The motor shall be specifically designed for valve actuator service using 480-volt, 60 Hertz, three phase power as shown, on the electrical drawings. The motor shall be sized to provide an output torque and shall be the totally enclosed, non-ventilated type. The power gearing shall consist of helical gears fabricated from heat treated alloy steel forming the first stage of reduction. The second reduction stage shall be a single stage worm gear. The worm shall be of alloy steel with carburized threads hardened and ground for high efficiency. The worm gear shall be of high tensile strength bronze with hobbed teeth. All power gearing shall be grease lubricated. Ball or roller bearings shall be used throughout. Preference will be given to units having a minimum number of gears and moving parts. Spur gear reduction shall be provided as required.
- C. Limit switches and gearing shall be an integral part of the valve control. The limit switch gearing shall be made of bronze and shall be grease lubricated, intermittent type and totally enclosed to prevent dirt and foreign matter from entering the gear train. Limit switches shall be of the adjustable type capable of being adjusted to trip at any point between fully opened valve and fully closed valve.
- D. The speed of the actuator shall be the responsibility of the system supplier with regard to hydraulic requirements and response compatibility with other components within the control loop. Each valve controller shall be provided with a minimum of two rotor type gear limit switches, one for opening and one for closing. The rotor type gear limit switch shall have two normally open and two normally closed contacts per rotor. Gear limit switches must be geared to the driving mechanism and in step at all times whether in motor or manual operation. Provision shall be made for two additional rotors as described above, each to have two normally open and two normally closed contacts. Each valve controller shall be equipped with a double torque switch. The torque switch shall be adjustable and will be responsive to load encountered in either direction of travel. It shall operate during the complete cycle without auxiliary relays or devices to protect the valve, should excessive load be met by obstructions in either direction of travel. The torque switch shall be provided with double-pole contacts.
- E. A permanently mounted handwheel shall be provided for manual operation. The handwheel shall not rotate during electric operations, but must be responsive to manual operation at all times except when being electrically operated. The motor shall not rotate during hand operation nor shall a fused motor prevent manual operation. When in manual operating position, the unit will remain in this position until motor is energized at which time the valve operator will automatically return to electric operation and shall remain in motor position until handwheel operation is desired. This movement from motor operation to handwheel operation shall be accomplished by a positive declutching lever which will disengage the motor and motor gearing mechanically, but not electrically. Hand operation must be reasonably fast. It shall be impossible to place the unit in manual operation when the motor is running. The gear limit switches and torque switches shall be housed in a single easily accessible compartment integral with the power compartment of the valve control. All wiring shall be accessible through this compartment. Stepping motor drives will not be acceptable.
- F. The motor with its control module must be capable of continuously modulating over its entire range without interruption by heat protection devices. The system, including the operator and control module must be able to function, without override protection of any kind, down to zero dead zone.
- G. All units shall have strip heaters in both the motor and limit switch compartments.
- H. The actuator shall be equipped with open-stop-close push buttons, an auto-manual selector switch, and indicating lights, all mounted on the actuator or on a separate locally mounted power control station.

- I. The electronics for the electric operator shall be protected against temporary submergence.
- J. Actuators shall be Flowserve Limitorque L120 with Mudotronic Control System. Actuator shall contain a position transmitter with a 4-20MA output signal.

Motor Actuators (Open-Close):

- A. The electronic motor-driven valve actuator shall include the motor, actuator gearing, limit switch gearing, limit switches, torque switches, fully machined drive sleeve, declutch lever, and auxiliary handwheel as a self-contained unit.
- B. The motor shall be specifically designed for valve actuator service and shall be of high torque totally enclosed, nonventilated construction, with motor leads brought into the limit switch compartment without having external piping or conduit box.
- C. The motor shall be of sufficient size to open or close the valve against maximum differential pressure when voltage to motor terminals is 10% above or below nominal voltage.
- D. The motor shall be prelubricated and all bearings shall be of the anti-friction type.
- E. The power gearing shall consist of helical gears fabricated from heat treated steel and worm gearing. The worm shall be carburized and hardened alloy steel with the threads ground after heat treating. The worm gear shall be of alloy bronze accurately cut with a hobbing machine. All power gearing shall be grease lubricated. Ball or roller bearings shall be used throughout.
- F. Limit switches and gearing shall be an integral part of the valve actuator. The switches shall be of the adjustable rotor type capable of being adjusted to trip at any point between fully opened valve and fully closed valve. Each valve controller shall be provided with a minimum of two rotor type gear limit switches, one for opening and one for closing (influent valves require additional contacts to allow stopping at an intermediate position). The rotor type gear limit switch shall have two normally open and two normally closed contacts per rotor. Additional switches shall be provided if shown on the control and/or instrumentation diagrams. Limit switches shall be geared to the driving mechanism and in step at all times whether in motor or manual operation. Each valve actuator shall be equipped with a double torque switch. The torque switch shall be adjustable and will be responsive to load encountered in either direction of travel. It shall operate during the complete cycle without auxiliary relays or devices to protect the valve should excessive load be met by obstructions in either direction of travel. Travel and thrusts shall be independent of wear in valve disc or seat rings.
- G. A permanently mounted handwheel shall be provided for manual operation. The handwheel shall not rotate during electric operation except when being electrically operated. The motor shall not rotate during hand operation, nor shall a fused motor prevent manual operation. When in manual operating position, the unit will remain in this position until motor is energized at which time the valve actuator will automatically return to electric operation and shall remain in motor position until handwheel operation is desired. Movement from motor operation to handwheel operation shall be accomplished by a positive declutching lever which will disengage the motor and motor gearing mechanically, but not electrically. Hand operation must be reasonably fast. It shall be impossible to place the unit in manual operation when the motor is running.
- H. Valve actuators shall be equipped with an integral reversing controller and three phase overload relays, Open-Stop-Close push buttons, local-remote-manual selector switch, control circuit transformer, three-phase thermal overload relays and two pilot lights in a NEMA 4X enclosure. In addition to the above, a close coupled air circuit breaker or disconnect switch shall be mounted and wired to the valve input power terminals for the purpose of disconnecting all underground phase conductors.

- I. The valve actuator shall be capable of being controlled locally or remotely via a selector switch integral with the actuator. In addition, an auxiliary dry contact shall be provided for remote position feedback.
- J. Valve A.C. motors shall be designed for operation on a 480 volt, 3-phase service. Valve control circuit shall operate from a fuse protected 120-volt power supply.
- K. Motor operators shall be Flowserve Limitorque L120 with Mudotronic Control System.

1.11.9 AIR RELEASE VALVES

- A. Air release valves shall be automatic float operated, with inlet size, working pressure ratings, and with NPT connections as required in the Approved Product List
- B. Valve bodies shall be ductile iron per ASTM A 126, Class B. The orifice, float and linkage shall be 316 stainless steel. The seat shall be (Buna N) nitrile elastomer. The external fasteners including bolts, washers, and nuts shall be 316 stainless steel.
- C. Air release valves installed over waterways shall have body and cover made of 316 stainless steel, with inlet size, working pressure rating, and NPT connections as required in the Approved Products List. Diaphragm, debris shield, float, debris screen, diaphragm holder, and upper air valve part shall be made of homopolymer (PP) or Delrin (POM). The external fasteners including bolts, washers, and nuts shall be made of 316 stainless steel.

1.11.10 VALVE BOXES

- A. Buried valves shall have adjustable cast iron or HDPE valve boxes. Lids shall be cast iron drop type, and shall have "WATER", "SEWER", or "RECLAIM", as applicable, cast into the top. Lids will be painted "safety" blue for potable, purple for reclaimed, and green for sanitary sewer.
- B. Valve lids in roadways shall be 24 lbs lids.
- C. Cast iron boxes shall be two-piece, or three-piece, as required, screw type, with extensions, as required to make the desired box length. Bottom barrel shall be 5-1/4 inches inside diameter, with a flanged bottom with sufficient bearing area to prevent settling.
- D. Reclaimed Valve Boxes shall be square 9-inch x 9-inch load bearing marked "Reclaimed Water" and painted Pantone 522C purple.
- E. All valves shall have an operating nut no more than 4 feet below the top of the lid and shall have extension stems with centering guides. Extension stems shall be 304 stainless steel fixed to the valve operating nut with a 304 stainless steel fastener and limited to only one extension per valve.
- F. All potable water, sewer, and reclaimed water grade-adjustment risers shall be cast iron material just like the valve box. No plastic adjustment riser rings or asphalt coated steel shall be allowed.
- G. A non-load bearing centering device shall be installed under the valve operating nut.
- H. Standpipe shall match color code of the system being installed, (blue for potable, purple for reclaimed, and green for sanitary sewer).

1.11.11 CORPORATION STOPS AND SADDLES (SEE ALSO GENERAL REQUIREMENTS)

- A. Corporation stops for connections to potable and reclaimed water mains shall be all lead-free (NL), red brass per ASTM B 62, and shall conform to AWWA C800. 1-inch through 2-inch corporation stops shall be ball type, 300 psi working pressure rated, with AWWA MIP threaded inlets and compression, pack joint,

flare, or FIP threaded joint outlets. All joints made to CTS size HDPE tubing shall use min 304 stainless steel insert stiffeners.

- B. Potable plastic service pipe material and compression and pack joint connectors shall not be used in soil that is contaminated with low molecular-weight petroleum products, aromatic hydrocarbons, chlorinated hydrocarbons or organic solvents. Appropriate service tubing (copper "K or L" or min. 304 stainless steel) shall apply.
- C. Water and reclaimed water service connections shall be made using lead-free (NL), red brass saddles (alloy 85-5-5-5) or 304 S.S. per ASTM B 62. Straps, washers and nuts shall be brass or 304 stainless steel. No ductile iron, cast iron or steel saddles will be allowed. Saddles shall have 304 stainless steel or brass extra wide strap.
- D. Connections to sanitary force mains for services up to 2 inches shall be made using 316 stainless steel saddles, straps, and hardware.
- E. Service and air release valve (ARV) connections to HDPE water, reclaimed water and sewer mains may be made using an approved tapping saddle. All saddles shall be properly sized per the manufacturer product information and be installed according to the manufacturer's written instructions.
- F. All sewer force main saddles shall be 316 stainless steel.

1.11.12 PLAIN END COUPLINGS AND FLANGED ADAPTERS

- A. Plain end couplings and adapters shall be fusion-bonded epoxy coated carbon steel with fluoropolymer or 316 stainless steel nuts, bolts, spacers, etc. EPDM rubber gaskets shall be required in potable water and reclaimed water systems. In contaminated soils, refer to Ductile Iron Pipe Section 1.4 for gasket materials.
- B. Flange adapters shall have a plain end compression seal, with an ANSI 125 Class flange on the opposite end. 316 stainless steel backup rings shall be used for force mains and lift station discharge that are located in corrosive environments including wet wells and valve vaults.

1.11.13 HOSE BIBS

Hose bibs shall be 3/4-inch or 1-inch brass, polished chromium plated brass, with vacuum breaker as noted on the drawings.

1.11.14 SWING CHECK VALVES

- A. Check valves shall be swing type, weighted lever, conforming to AWWA C508. Valves shall be iron-body, bronze-mounted, single disk, 175 psi working pressure for 2- through 12-inch, 150 psi for 14- through 30-inch, with ANSI B16.1 Class 125 flanged ends.
- B. When there is no flow through the line, the disc shall hang lightly against its seat in practically a vertical position. When open, the disc shall swing clear of the waterway.
- C. Check valves shall have bronze seat and body rings, extended bronze or 316 stainless steel hinge pins and 316 stainless steel nuts and bolts on bolted covers.
- D. Valves shall be so constructed that disc and body seat may easily be removed and replaced without removing the valve from the line. Valves shall be fitted with an extended hinge arm with outside lever and weight. The hinge arm and weight, along with hardware, shall be suitable for use in a corrosive environment.

- E. All check valves shall be internally and externally coated with a factory applied, two-part high solids epoxy conforming to AWWA C550, dry film thickness as defined in the Approved Products List.

1.11.15 SWING-FLEX CHECK VALVES (FOR WATER & RECLAIMED ONLY)

- A. Certified to NSF/ANSI 61, NSF/ANSI 372 certified lead-free, AWWA C508 certified.
- B. Available in 2 inch through 48 inch.
- C. Ductile iron construction for 250 psi service, manufactured under a certified ISO 9001 quality system.
- D. All check valves shall be internally and externally coated with a factory applied, two-part high solids epoxy conforming to AWWA C550, dry film thickness as defined in the Approved Products List.
- E. Dome access cover.
- F. 25-Year Disc Warranty

1.11.16 HYDRANTS

- A. Hydrants shall be dry barrel, nostalgic style, and shall conform to AWWA C502 and be UL/FM certified, and shall in addition meet the specific requirements and exceptions which follow:
- B. Hydrants shall be according to manufacturer's standard pattern or nostalgic style and of standard size, and shall have one 5-inch Storz connection with two 2-½ inch hose nozzles.
- C. Hydrant inlet connections shall have mechanical joints for 6-inch pipe.
- D. Hydrant valve opening shall have an area at least equal to that area of a 5 1/4-inch minimum diameter circle and be obstructed only by the valve rod. Each hydrant shall be able to deliver 500 gpm minimum through its two 2 1/2 -inch hose nozzles when opened together with a loss of not more than 3 psi in the hydrant per AWWA C502.
- E. The upper and lower stem rod shall be 304 stainless steel and shall have a breakable stem-rod coupling of stainless steel, or cast iron or ductile iron with a fusion bonded epoxy coating, with 316 stainless steel pins and clips.
- F. Hydrants shall be hydrostatically tested as specified in AWWA C502 and shall be rated at 250 psi minimum.
- G. The operating nut shall be 1 ½ -inch pentagon shaped with a protective weather cover, and open counter-clockwise.
- H. All nozzle threads shall be American National Standard.
- I. Each nozzle cap shall be provided with a Buna N rubber washer.
- J. All hydrants shall be traffic break away type and allow for 360-degree rotation to position the Storz connection/nozzle in the desired direction after installation.
- K. Hydrants must be capable of being extended without removing any operating parts.
- L. Hydrant extensions shall be coated as typical ductile iron pipe with a 304 stainless steel stem. The breakaway coupling can be fusion bonded epoxy coated or 304 stainless steel. Only one hydrant extension is allowed per hydrant.
- M. Weepholes shall be excluded from fire hydrants.

- N. Hydrant main valve closure shall be of the compression type opening against the pressure and closing with the pressure. The main valve shall be faced or covered with EPDM elastomer, which shall seat on a bronze ring.
- O. Exterior nuts, bolts and washers shall be 316 stainless steel. Bronze nuts may be used below grade.
- P. All internal operating parts shall be removable without requiring excavation.
- Q. Hydrant bonnets, weather cover, nozzle section, caps and shoe shall be cast iron or ductile iron. Hydrant shoe shall be fusion bonded epoxy coated inside and outside. Hydrant standpipe shall have interior and exterior coatings as required by Section 1.4.2.G or be factory-applied fusion bonded epoxy. Hydrant bonnets, weather cover, nozzle section, caps shall have interior and exterior epoxy primer. Above-ground parts shall have a UV-resistant external top coat of minimum 4-mil DFT; color Safety Yellow for fire hydrants that are connected to the public potable water system or Pantone 522C purple for fire hydrants that are connected to the public reclaimed water system. Private potable fire hydrants shall have a top coat of acrylic polyurethane; color red.

1.11.17 RESTRAINED JOINTS

- A. Pipe joints shall be restrained by poured-in-place concrete thrust blocks or by other mechanical methods. Flanged joints may be used above ground.
- B. For thrust blocks, the concrete shall be placed between undisturbed soil and the fittings or appurtenance to be supported. Concrete shall not be placed on or around the pipe, bells, flanges, or other joints. If contact with concrete is unavoidable, these areas shall be protected with a double wrap of 8-mil polyethylene film to allow for disassembly and repair of the fitting or appurtenance.
- C. Approved color-coded restraining gaskets are acceptable for use. The gasket color shall be consistent throughout the entire cross section of the gasket. The colors shall not be attained by surface coating; the color shall be inherent within the rubber.
- D. All below ground restraints; T-bolts, bolts, nuts, washers, and all thread rods shall be high strength low alloy steel conforming to AWWA C111 / ANSI A21.11-17 or ASTM A242 and all shall be coated with a certified fluoropolymer coating. Alternatively, all hardware can be 316 stainless steel.
- E. All above ground restraints; T-bolts, bolts, nuts, washers, and all thread rods shall be 316 stainless steel. The use of rebar with welded thread is prohibited.

1.11.18 TAPPING SLEEVES AND VALVES

- A. Tapping sleeves and straps shall be made of 316 stainless steel, shall seal to the pipe by the use of a confined "O" ring gasket, and shall be able to withstand a pressure test of 180 psi for water lines or 150 psi for sewer force mains for one hour with no leakage in accordance with AWWA C110. A 316 stainless steel 3/4-inch NPT test plug shall be provided for pressure testing. All hardware joining the two halves shall be 316 stainless steel and shall be included with the sleeve.
- B. The entire area of the flange surface shall be covered by a 1/8-inch minimal thick full-face, rubber gasket. EPDM rubber gaskets shall be required in potable water and reclaimed water systems. In contaminated soils, refer to Ductile Iron Pipe Section 1.4 for gasket materials.
- C. Tapping valves shall meet the requirements of AWWA C515 with ductile iron body and shall be rated for a pressure of 250 psi. The valves shall be flanged with alignment ring by mechanical joint with a non-rising 304 stainless steel stem. All bolts, nuts and washers shall be 304 stainless steel. Manufacturer shall use Never-Seez or equivalent during assembly of bolt and nut sets to prevent galling of similar metals. Stem

seals shall be provided and shall be of the O-ring type, two above and one below the valve's thrust collar. Valve shall be designed for vertical burial and shall open counterclockwise. Operating nut shall be AWWA standard 2-inch square for valves 2 inches and up. Valves shall have an unobstructed waterway equal to or greater than the full nominal diameter of the valve to accommodate full size shell cutter. The wedge shall be ductile iron fully encapsulated with EPDM rubber. All bolts, nuts and washers between the sleeve and valve shall be 316 stainless steel. Torque limiter on 16-inch diameter gate valves are required.

1.11.19 TRACER WIRE BOXES

- A. Tracer wire test station boxes shall be provided at plug valves, blowoff valves, gate valves, fire hydrants and backflow prevention assemblies as indicated in these Standards. Tracer wire test station boxes for yard service shall be 2-1/2 inch diameter, 15 inch length, ABS plastic with a cast iron rim and lid. Where test boxes will be in streets or subject to vehicular traffic, 5-1/4 inch diameter or equal, centered in a separate concrete pad similar to a valve box pad.
- B. Where possible, locate the tracer wire testing station outside of travel lanes, in medians, or in grassy areas adjacent to the travel lanes. All tracer wire(s) shall be attached to the lid, allowing testing to be performed without removing the lid.

1.11.20 INSERTION VALVE

- A. Insertion valves shall be resilient wedge gate valves, manufactured to meet or exceed the requirements AWWA C515 and shall be UL listed and FM approved where applicable. Valves shall have an unobstructed waterway equal to or greater than the full nominal diameter of the valve.
- B. Buried gate valves shall have a non-rising min. 304 stainless steel stem. Buried gate valve bolts, nuts and washers shall be min. 304 stainless steel. Manufacturer shall use anti-seize lubricant during assembly of bolt and nut sets to prevent corrosion and galling of metals. Stem seals shall be provided and shall be of the O-ring type, two above and one below the thrust collar.
- C. The wedge shall be ductile iron that is fully encapsulated with an EPDM rubber. The Elastomer type shall be permanently embossed or formed on the valve body or wedge. The resilient sealing mechanism shall provide zero leakage at the water working pressure when installed with the line flow in either direction.
- D. The valve body and bonnet shall be ductile iron meeting or exceeding all the requirements of AWWA C515.
- E. Valves shall be rated for an operating pressure of 250 psi and shall be tested in accordance with AWWA C515.
- F. The valves are to have 2-inch cast or ductile iron AWWA operating nuts and shall open left or counterclockwise. The wedge nut shall be bronze.
- G. The valves shall be covered by a Manufacturer's 10-year warranty on manufacturer's defects and reasonable labor costs for replacement. Warranty shall become effective from the date of purchase by the end user and delivered within 30 days from the receipt of the purchase order. For publicly owned and maintained utilities, the end user is Manatee County Government.
- H. Gate valves shall be assembled and tested in a certified ISO 9001 manufacturing facility within the United States and provide their certification of meeting internationally recognized quality control procedures.
- I. Contractor shall be qualified to perform the installation and shall provide written certification by valve manufacturer guaranteeing the Contractor is qualified to perform the Work.

- J. Sizes 12" and smaller must be capable of working on ductile iron pipe, PVC IPS and C900-16, Asbestos Clay without having to change either the top or bottom portion of split valve body.
- K. Valve shall have a factory applied fusion bonded epoxy on the interior and exterior, thickness as defined in the Approved Products List.

END OF SECTION

SECTION 1.12 PRECAST PORTLAND CONCRETE MANHOLES AND WET WELLS

1.12.1 DESCRIPTION OF WORK

- A. Furnish all materials, labor and equipment to construct manholes and wet wells consisting of precast concrete sections as indicated on the construction drawings.
- B. Precast portland concrete manholes are only to be used in non-turbulent flow conditions and shall not be used in turbulent flow conditions, outside drop manholes, manholes with opposing flow, manholes upstream of a lift station (see US-17A), manholes with 12-inch and greater gravity sewer pipes, manholes receiving force main flow and the next two downstream manholes.

1.12.2 PRECAST CONCRETE SECTIONS

- A. Precast concrete manhole grade rings, flat slab tops, conical tops, risers and base sections shall be fabricated in accordance with the material and design standards of ASTM C478, except as modified herein.
- B. Portland cement shall conform to ASTM C150, Type II, and concrete shall have a minimum compressive 28-day strength of 4,000 psi.
- C. The manufacturer shall make a minimum of four standard test cylinders for each 100 cubic yards of concrete (or part thereof) that is cast each day. These test cylinders, along with sections cast that day, shall be marked in such a way that the test results can be matched with the appropriate castings. Two cylinders shall be cured with the product until the forms are stripped. At this time, one cylinder shall be broken to ascertain that a minimum strength of 2,000 psi has been reached prior to moving the product from the forming location. The remaining two cylinders shall be cured and tested in accordance with ASTM C192 and C39. The average compressive strength for each day's production shall be greater than 4,000 psi with no more than 10% of the tested cylinders falling below 4,000 psi. In no case shall any cylinder strength fall below 3,500 psi. All cylinder strengths shall be certified by a Florida Licensed Professional Engineer. Failure to meet these requirements for any day's production is cause for rejection of all sections cast that day.
- D. Minimum wall thickness for manholes shall be 8 inches or 1/12 the inside diameter of the manhole, whichever is greater. The minimum thickness for the bottom of the base section shall be 8 inches.
- E. Reinforcing steel shall be as specified in ASTM C478.
- F. Precast manhole structures shall be free of cracks, holes, voids, blisters or rough surfaces. Manholes shall be water-tight and shall be generally sound and free of defects of any sort. Lift holes shall not penetrate through the wall of any manhole tops, risers or base sections. Holes passing part-way through the manhole section walls for lifting devices shall be filled with cement or epoxy grout after the manhole has been set in place.
- G. All sections shall meet the manufacturing tolerance requirements of ASTM C478 or the following casting tolerances, whichever are more severe:

Wall Thickness	+/- 3/8 inches
Inside Diameter	+/- 3/8 inches
Outside Diameter	+/- 1/2 inches
Height or Length	+/- 3/8 inches

- H. Pipe openings shall meet the recommended tolerances of the individual manufactured pipe to manhole connectors; however, the horizontal location shall be within +/- 2 degrees of arc of that detailed on the shop drawings.

1.12.3 MANHOLE INVERTS

- A. Benched inverts shall be provided and shall be monolithically cast or shall be a secondary casting in a cured base section as per ASTM C478.
- B. The width of the invert channel shall be the same as the inside diameter of the connected sewer pipes and shall have a "U" - shaped cross-section with the bottom of the channel shaped to correspond with the lower half of the pipe. The depth of the channel shall be a minimum of half the inside diameter of the connected pipes.
- C. The channel shall be formed smooth and streamlined, and, where the flow changes directions, shall have true curves of the largest radius possible within the manhole base. The maximum change of direction of flow within a manhole shall be 90 degrees.
- D. The channel invert slope shall be uniform through the manhole and shall have a minimum vertical drop of 1 inch from the inlet(s) to the outlet.

1.12.4 RESILIENT PIPE CONNECTORS

- A. Connections of manholes to pipes shall be made using resilient boot or seal connectors manufactured in accordance with ASTM C923 and shall maintain a resilient, hydrostatic seal between the pipe and the connector and between the connector and the manhole structure. All external hardware and connector bands shall be 316 stainless steel.
- B. Connectors shall be installed in strict accordance with the written installation instructions of the manufacturer. Non-shrink grout shall be placed in the gap between the boot or seal and the manhole invert channel, to make a smooth transition, unless otherwise directed by the manufacturer's instructions.

1.12.5 MANHOLE AND WET WELL JOINTS

- A. Joints between manhole sections and wet well sections shall be modified tongue and groove, or modified bell and spigot, with a continuous elastomeric ring gasket joint conforming to the requirements of ASTM C443. In addition to the ring gasket, an additional sealing device shall be provided as follows:
 - 1. A minimum of 12-inches wide elastomeric based plastic joint wrap shall be centered over the joint, on the outside of the manhole, or
 - 2. A minimum of ½-inch x ¾-inch bead of hydrophilic urethane paste applied to the joint just before manhole section assembly.
- B. Fill the joint at the inside face with non-shrink grout and strike the joint smooth and uniform with the manhole interior walls.
- C. For manholes with concrete grade-adjustment rings, joints between the top section and the grade ring, and between grade rings, and between the grade ring and the cast-iron ring frame shall be made with butyl rubber sealant strips and non-shrink cement mortar.

1.12.6 MANHOLE RINGS AND COVERS

Rings and covers shall be gray iron castings, conforming to ASTM A48, Class 30B, with the words "MANATEE COUNTY", "SANITARY SEWER", and "(YEAR)" cast into them. Frame and cover castings shall be dense and even grained, and shall be free of blowholes, warping, or any other defects not true to pattern. Seating surfaces of covers and frames shall be machined true to prevent rocking. Castings shall be designed and tested to bear an AASHTO H-20 wheel loading with and added 30 percent impact factor and shall be Class Heavy Duty traffic bearing.

1.12.7 MANHOLE INSERTS

Watertight manhole inserts are required for all sanitary sewer manholes installed. Neoprene gaskets shall be installed under the insert lip to ensure a leak-proof seal.

1.12.8 PRECAST CONCRETE MANHOLE INSTALLATION

- A. Manholes shall be installed at the end of each main run; at all changes in grade, size, or alignment; at all intersections; at distances not greater than 400 feet for sewers 15 inches or less and 500 feet for sewers 18 inches or larger, and at a distance no greater than 50 feet from a lift station wet well. Cleanouts may be used only for special conditions with prior written approval by the County and shall not be substituted for manholes.
- B. Invert drops less than 24 inches shall have an elevated U-channel to prevent solids disposition. Where sewers enter a manhole at an elevation 24 inches or more above the lowest invert, then an outside drop polymer concrete manholes shall be provided. The entire outside drop connection shall be encased in portland concrete.
- C. Precast concrete sections shall be set vertical and in true alignment as indicated by the construction plans. Excavation, bedding foundation and backfill shall be done in accordance with the Trenching and Excavation section of these Standards. All manholes shall meet the following installation tolerances:
 1. The finished manholes shall not be out of plumb by more than 3/8 inch per 10 feet of height.
 2. Any jog or offset of the inside wall surface at a joint shall not exceed 1/2 inch.
 3. Variation in the joint width around the circumference of the manhole shall not exceed 1/4 inch.

1.12.9 SETTING MANHOLE RING AND COVERS

Manhole rings and covers shall be set to conform accurately to the finished ground or pavement grade as indicated on the construction drawings or as directed by the County. Rings on manholes shall be set concentric with the precast concrete adjusting rings and sealed with butyl rubber strips; 3" wide x 1/2" thick so that the space between the top of the adjustment rings and the bottom flanges of the rings will be made watertight. A ring of mortar shall be placed around the outside of the bottom flange at least one inch thick and pitched to shed water away from the frame. Mortar shall be extended to the outer edge of the masonry and finished smooth and flush with the top of the flange.

1.12.10 ADJUSTING MANHOLE COVER

- A. Existing manhole covers, which must be adjusted to existing or new pavement surfaces, shall be adjusted by modifying the existing precast concrete adjustment rings to bring the entire ring and cover to grade.
- B. No manhole cover adjustment rings shall be allowed.

1.12.11 SPRAY-APPLIED MANHOLE LINERS

Existing concrete or brick and mortar manhole structures that are to be modified or rehabilitated by adding a manhole liner shall have an approved spray-applied liner installed.

1.12.12 PROTECTION FROM FLOODWATER INFLOW

- A. Wastewater sewer systems shall be designed to prevent flood or surface waters from entering the collection system. Manhole rims and clean-out tops shall be elevated 4 inches above the 100-year flood level, or 8 inches above the 25-year flood level, or 4 inches above the surrounding unpaved ground surface within a 20-foot radius, whichever is highest, or the manhole covers and clean-out lids shall be designed and installed with factory-made watertight, tamper proof, sealing devices.
- B. Manholes with rims less than the above required elevations shall have a water-tight, bolt-down lid to prevent water infiltration.
- C. Cleanouts not at or above the required elevations shall have the clean-out adapter solvent welded watertight to the clean-out riser. Plugs are to be recessed square key with Teflon plumber's tape wrapped on threads to make a watertight seal.

END OF SECTION

SECTION 1.13 PRECAST POLYMER CONCRETE MANHOLES AND WET WELLS

1.13.1 DESCRIPTION OF WORK

- A. Furnish all materials, labor and equipment to construct water-tight manholes and wet wells consisting of precast polymer concrete sections as indicated on the construction drawings.
- B. Precast polymer concrete manholes shall be used in turbulent flow conditions, outside drop manholes, manholes with opposing flow, manholes upstream of a lift station (see US-17A), manholes with 12-inch and greater gravity sewer pipes, manholes receiving force main flow and the next two downstream manholes.
- C. Precast polymer concrete shall be used in the construction of all wet wells. Traditional lined portland concrete wet wells may be accepted, when the required diameter exceeds the diameters available by the authorized manufacturers of the polymer concrete wet well.
- D. On sanitary sewer systems that are to be publicly owned and maintained, as a basis of acceptance, the manufacturer shall provide an independent certification consisting of a copy of the manufacturer's test reports along with a copy of the test results certifying that representative manhole samples have been tested, and inspected in accordance with the provisions of this Specification and meet all requirements of same, to include but not limited to the load and strength requirements of ASTM C478 and ASTM C857.

1.13.2 PRECAST CONCRETE SECTIONS

- A. Polymer concrete manholes and wet wells shall be manufactured from chemical-resistant polymer concrete with fiber-reinforced polymer (FRP) or steel reinforcement bars. Manholes and wet wells shall be manufactured by an established national manufacturer producing polymer concrete sanitary manholes and wet wells.
- B. Marking and Identification - Each manhole and/or wet well shall be marked on the inside and outside with the following information:
 - 1. Manufacturer's name or trademark.
 - 2. Manufacturer's factory location.
 - 3. Manufacturer's serial number.
 - 4. Total length.
 - 5. Production Date.
- C. Precast polymer concrete manhole grade rings, flat slab tops, conical tops, risers and base sections shall be designed by the manufacturer to meet loading requirements of ASTM C478, ASTM C857, and ACI 350-06 as modified for polymer concrete manhole and wet well design as follows:
 - 1. Polymer Concrete Mix Design shall consist of thermosetting resin, sand, and aggregate. No Portland cement shall be allowed as part of the mix design matrix. All sand and aggregate shall be inert in an acidic environment.
 - 2. Reinforcement – Shall use acid resistant reinforcement (FRP Bar) in accordance with ACI 440.1R-06 or steel in accordance with ASTM C478 as applicable for polymer concrete design.
 - 3. The wall thickness of polymer concrete structures shall not be less than that prescribed by the manufacturer's design by less than 95% of stated design thickness.

4. Thermosetting Resin - The resin shall have a minimum deflection temperature of 158° F when tested at 264 psi (1.820 mPa) following Test Method D648. The resin content shall not be less than 7% of the weight of the sample as determined by test method D2584. Resin selection shall be suitable for applications in the corrosive conditions to which the polymer concrete manhole structures will be exposed.
 5. AASHTO HS-20 or HL-93 design or as required loading applied to manhole cover and transition and base slabs.
 6. Polymer manholes shall be designed based upon live and dead load criteria in ASTM C857 and ACI 350-06.
 7. Unit soil weight of 130 pcf located above portions of manhole, including base slab projections.
 8. Internal liquid pressure based on unit weight of 63 pcf.
 9. Dead load of manhole sections fully supported by transition and base slab.
- D. ASTM C478 and ASTM C857 material and manufacturing is allowed compositional and dimensional differences required by a polymer concrete product.
- E. Polymer concrete shall have a minimum unconfined compressive strength of 9,000 psi at 28-days when measured in accordance with ASTM C497.
- F. Minimum Wall Thickness for Manholes and Wet Wells:
1. Shall be designed to resist hydrostatic pressures with a minimum safety factor of 2.0 for full depth conditions from grade to invert.
 2. The wall thickness of risers and conical tops shall not be less than that prescribed by the manufacturer's design by more than 5%. A wall greater than the prescribed design shall not be cause for rejection.
 3. Wall thickness shall be as required by structural design performed by the manufacturer. Wall thickness design calculations shall be provided, signed and sealed by a licensed Professional Engineer in the State of Florida.
 4. Manhole riser walls shall have a minimum thickness of 2-inches and the cone walls shall have a minimum thickness of 5-inches. Wet well section walls shall have a minimum thickness of 4--inches.
- G. Precast structures shall be free of all defects, including indentations, cracks, holes, voids, blisters or rough surfaces, foreign inclusions and resin starved areas that, due to their nature and degree or extent, detrimentally affect the strength and serviceability of the component part.
- H. The nominal internal diameter of the structure shall not vary more than 1%.
- I. Variations in height of two opposite sides of risers and cones shall not be more than 5/8 inch. The under run in height of a riser or cone shall not be more than 1/4 in/ft of height with a maximum of 1/2 inch in any one section.
- J. Structures shall have engineered and rated lifting devices that shall not penetrate through the wall of any tops, risers or base sections. Holes passing part-way through the section walls for lifting devices shall be filled with polyester mortar compound or non-shrink epoxy grout after the structure has been set in place.
- K. All sections shall meet the manufacturing tolerance requirements of ASTM C478 or the following casting tolerances, whichever are more severe:

Wall Thickness	+/- 3/8 inches
Inside Diameter	+/- 3/8 inches
Outside Diameter	+/- 1/2 inches
Height or Length	+/- 3/8 inches

- L. Provide riser sections joined with tongue and groove / bell and spigot design seamed with butyl mastic and joint lubricated rubber gaskets, so that on assembly, the base, riser and top section make a water-tight continuous and uniform structure.
- M. Construct riser sections for polymer concrete structures from standard polymer concrete sections of the diameter indicated on drawings. Use various lengths of polymer concrete sections in combination to provide correct height with the fewest practical joints.
- N. Pipe openings shall meet the recommended tolerances of the individual manufactured pipe to structure connectors; however, the horizontal location shall be within +/- 2 degrees of arc of that detailed on the shop drawings.
- O. Minimum clear distance between two wall penetrations shall be a minimum of 6" on 48" to 72" diameter manholes and a minimum of 8" on larger diameter manholes. A clearance of 3" is required between wall penetration and joint.
- P. All structure penetrations shall be made in the factory, unless otherwise specified in the plans.

1.13.3 MANHOLE INVERTS

- A. Polymer bench and channels are to be factory constructed with all resin aggregate material. All precast base sections to be cast monolithically. Extended ballast slab requirements for buoyancy concerns can be addressed with exterior cementitious concrete material.
- B. The width of the invert channel shall be the same as the inside diameter of the connected sewer pipes and shall have a "U" - shaped cross-section with the bottom of the channel shaped to correspond with the lower half of the pipe. The depth of the channel shall be a minimum of half the inside diameter of the connected pipes.
- C. The channel shall be formed smooth and streamlined, and, where the flow changes directions, shall have true curves of the largest radius possible within the manhole base. The maximum change of direction of flow within a manhole shall be 90 degrees.
- D. The channel invert slope shall be uniform through the manhole and shall have a minimum vertical drop of 1 inch from the inlet(s) to the outlet.

1.13.4 RESILIENT PIPE CONNECTORS

- A. Connections of structures to pipes shall be made using a cast-in resilient connectors manufactured in accordance with ASTM C923 and shall maintain a resilient, hydrostatic water-tight seal between the pipe and the connector and between the connector and the manhole structure. All external hardware and connector bands shall be 316 stainless steel.
- B. Connectors shall be installed in strict accordance with the written installation instructions of the manufacturer. Non-shrink grout shall be placed in the gap between the boot or seal and the manhole invert channel, to make a smooth transition, unless otherwise directed by the manufacturer's instructions.
- C. Cold joint pipe stub grouting shall not be allowed.

1.13.5 GROUTING

All materials needed for grouting and patching shall be a polyester mortar compound or non-shrink epoxy grout provided by the manufacturer. All holes in sections used for handling and annular spaces, around influent and effluent pipes, shall be filled using the materials listed above.

1.13.6 MANHOLE AND WET WELL JOINTS

- A. Joints between sections shall be modified tongue and groove, or modified bell and spigot, with a continuous joint lubricated elastomeric ring gasket conforming to the requirements of ASTM C443. Joint sealing surfaces shall be free of dents, gouges and other surface irregularities that would affect joint integrity.
- B. In addition to the ring gasket, an additional sealing device shall be provided as follows:
 - 1. An internal joint sealant:
 - a. butyl rubber sealant shall be applied to the interior of the tongue and groove / bell and spigot joints per manufacturer's recommendations and joint lubricated rubber gaskets.
 - 2. An external joint wrap:
 - a. If the structure joint design has the risers' outer walls offset from each other, an 18-inch wide heat shrinkable joint wrap shall be centered over all these joints including the chimney to frame section per the manufacturer's recommendations
 - b. If the structure joint design has the risers' outer walls flush with each other, a 12-inch non-shrink elastomeric plastic joint wrap shall be centered over all these joints including chimney to frame section per the manufacturer's recommendations
- C. Fill the joint at the inside face with non-shrink epoxy grout and strike the joint smooth and uniform with the structure interior walls.

1.13.7 MANHOLE RINGS AND COVERS

- A. Rings and covers shall be heavy duty composite with a gasket seal and a minimum three (3) 316 stainless steel locking bolts; (camlock or quarter-turn locking mechanisms are prohibited). All frames and covers shall be water-tight, designed to withstand an HS-20 wheel loading as defined by AASHTO specifications with the words "MANATEE COUNTY", "SANITARY SEWER", and "(YEAR)" cast into them. Frame and cover molding shall be free of blowholes, warping, or any other defects not true to pattern. Seating surfaces of covers and frames shall be properly faced to prevent rocking. Rings and covers shall be designed and tested to bear an AASHTO H-20 wheel loading with and added 30 percent impact factor and shall be Class Heavy Duty traffic bearing.
- B. Manhole composite frames shall be adjusted to grade with polymer concrete corrosion proof grade rings set on top of the manhole slabs and polymer concrete manhole cones to provide grade adjustment in setting manhole frames. Contractor shall use manufacturer recommended sealant between rings. Contractor shall ensure a watertight seal by removing debris, stones, and dirt between rings.

1.13.8 SETTING MANHOLE RING AND COVERS

Manhole rings and covers shall be set to conform accurately to the finished ground or pavement grade as indicated on the construction drawings or as directed by the County. Rings on manholes shall be set concentric with the precast polymer concrete adjusting rings and sealed with butyl rubber sealant strips;

3" wide x 1/2" thick, so that the space between the top of the adjustment rings and the bottom flanges of the rings will be made watertight. A ring of mortar shall be placed around the outside of the bottom flange at least one inch thick and pitched to shed water away from the frame. Mortar shall be extended to the outer edge of the masonry and finished smooth and flush with the top of the flange.

1.13.9 MANHOLE INSERTS

Watertight manhole inserts are required for all sanitary sewer manholes installed. Neoprene gaskets shall be installed under the insert lip to ensure a leak-proof seal.

1.13.10 POLYMER CONCRETE STRUCTURE INSTALLATION

- A. Precast concrete sections shall be set vertical and in true alignment as indicated by the construction plans. Excavation, bedding foundation and backfill shall be done in accordance with the Trenching and Excavation section of these Standards. All structures shall meet the following installation tolerances:
 - 1. The finished structures shall not be out of plumb by more than 3/8 inch per 10 feet of height.
 - 2. Any jog or offset of the inside wall surface at a joint shall not exceed 1/2 inch.
 - 3. Variation in the joint width around the circumference of the structure shall not exceed 1/4 inch.
- B. Invert drops less than 24 inches shall have an elevated U-channel to prevent solids disposition. Where sewers enter a manhole at an elevation 24 inches or more above the lowest invert, then an outside drop polymer concrete manholes shall be provided. The entire outside drop connection shall be encased in portland concrete.

1.13.11 ADJUSTING MANHOLE COVER

- A. Existing manhole covers, which must be adjusted to existing or new pavement surfaces, shall be adjusted by modifying the existing precast polymer concrete adjustment rings to bring the entire existing ring and cover to grade.
- B. No manhole cover adjustment rings shall be allowed.

1.13.12 BACKFILL PROCEDURES

- A. Excavation, dewater, and backfilling shall be in accordance with Section 1.3.
- B. Backfill shall be placed in such a manner as to prevent any wedging action against the manhole structure.

1.13.13 CONNECTIONS TO EXISTING POLYMER CONCRETE MANHOLES AND WET WELLS

- A. All penetrations shall be mechanically rotary core-bore.
- B. All piping entering existing manholes shall have a jack-in resilient pipe to manhole seals per ASTM C923.
- C. The external take down clamp and its hardware shall be 316 stainless steel. The internal expansion band and its hardware shall be minimum 304 stainless steel.
- D. Bench shall be modified with a new U-channel and finished with polymer concrete/grout per the manufacturer's recommendations.

END OF SECTION

SECTION 1.14 LIFT STATIONS

1.14.1 DESCRIPTION OF WORK

Furnish all labor, materials, equipment and incidentals required to install complete automatic, underground lift stations with all required equipment installed in a polymer concrete wet well, adjacent above-ground valve assembly (and above-ground meter, as determined by County). The principal items of equipment shall include, at a minimum, two submersible motor-driven sewage pumps, valves, internal piping, automatic pumping level controls, complete control panel and telemetry (most current model). All materials shall be new, without defects and of the best quality. All materials furnished and all work done shall be in strict accordance with the National Electrical Code and all local requirements and codes.

All lift stations that re-pump sewage from four (4) other upstream lift stations or has a discharge flow 500 gpm or greater shall have an on-site back-up diesel pump equipped with a transducer level controls, and backup float switches. The sub-base type fuel tank shall not exceed 540 gallons.

Re-pump station may require an in-line submersible magnetic flow meter (as determined by County), and a force main pressure transducer.

Alternatively, at the sole-discretion of the County, an electric generator equipped with an automatic power transfer switch may be installed in lieu of the back-up diesel pump.

1.14.2 STRUCTURES AND EQUIPMENT

- A. Lift Station Wet Well. All wet wells 6 feet diameter and larger, and all lift stations that are owned and maintained by Manatee County, shall be precast polymer concrete (or portland concrete and lined, if the polymer concrete wet well diameter is not available), in accordance with section 1.13, designed to accommodate the peak hour development flow from all contributing areas. The wet well shall have a minimum of 4 feet from the lowest invert to the wet well bottom. In no cases shall the lowest influent pipe invert of the wet well be deeper than 25 feet, nor shall the bottom of the wet well be deeper than 32 feet
- B. The lift station wet well size shall be determined using the following formula to determine the minimum volume between the off-level elevation and the influent invert elevation:

$$\text{MIN. VOLUME (GALS.)} = \text{PUMP CAPACITY (G.P.M.)} \times 4$$

Wet well diameters shall be 6 feet or larger. 4-foot and 5-foot diameter wet wells shall be used only for special grinder pump applications as approved by the County on a case by case basis.

Polymer Concrete wet wells shall have a minimum wall thickness per Section 1.13.2.F.

Portland Concrete wet wells shall have a minimum wall thickness as follows:

<u>DIAMETER</u>	<u>WALL THICKNESS</u>	<u>DIAMETER</u>	<u>WALL THICKNESS</u>
4' - 0"	8"	8' - 0"	8"
5' - 0"	8"	10' - 0"	10"
6' - 0"	8"	12' - 0"	12"

The lift station wet well size and control equipment shall be designed to limit the pumping cycles of each pump to a maximum of 5 starts per hour for duplex stations and 3 starts per hour for triplex stations. Lift stations discharging through pipes 12 inches or larger shall have more than two variable speed pumps. The pump cycle off level shall be no lower than the top of the sewage pumps. The lead pump on level

shall be no higher than 18 inches below the invert elevation of the influent pipe for duplex stations, and no higher than 24 inches below the invert for triplex stations.

All lift stations shall have a single gravity-flow influent pipe discharging into the wet well. Multiple gravity pipelines and force mains upstream shall all terminate at a separate polymer concrete manhole before flowing into the lift station wet well. This separate polymer concrete manhole shall be located no further than 50 feet from the wet well. The influent gravity sewer shall be aligned, so that the inflowing stream drops into the front side of the wet well, opposite from the riser pipes.

- C. Above-ground Valve Assembly. An above-ground valve assembly and 3,000 psi concrete pad with three gate valves, two weighted lever swing check valves, and a pump-out connection shall be constructed adjacent to the wet well. Tri-plex stations have four gate valves and three check valves. The pump-out connection shall be equipped with a gate valve and a male aluminum quick-coupler w/ cap; 4-inch for 4-inch or smaller valve assemblies; 6-inch for all others, unless otherwise specified on the plans. All valves shall have factory applied, fusion bonded epoxy coating on the interior and exterior. All fittings shall have a factory applied epoxy coating inside and outside. All bolt, nuts & washers in or on the wet well or valve assembly shall be 316 stainless steel.

The valve assembly shall be supported by 316 stainless steel adjustable, flange-type, pipe supports anchored to the structure/valve pad. 6-#5 rebar shall be epoxy doweled into the wet well 3-4 inches and cast into the valve assembly slab 3-4 feet.

- D. Entrance Hatches. The lift station wet well shall be equipped with an aluminum access cover of adequate size to permit easy removal and installation of sewage pumps and equipment. The wet well access cover shall be a minimum 36" x 48" single (preferred) or double door. The dimensions of the hatch will vary depending on the internal discharge pipe size and internal configuration, the actual required dimensions of the hatch shall be confirmed with the pump manufacturer prior to ordering. The access covers shall be constructed of aluminum with a minimum load rating of 300 lbs/sq. ft. and equipped with 316 stainless steel hinges, a recessed lifting handle which lies flush with the door surface, and a 316 stainless steel staple which may be used to secure the door with a padlock when closed. The doors shall have a raised diamond thread pattern to provide a skid-resistant surface and shall open to 90 degrees and lock automatically in that position, with a handle to release the doors for closing.
- E. Sewage Pump Assemblies. Each lift station shall have a minimum of two identical, totally submersible sewage pump assemblies which are rated and suitable for continuous duty, underwater operation. These units and their associated power and signal cables shall have watertight integrity to a depth of 65 feet. The pump, pump motor and associated components shall all be the products of the same manufacturer. Pump assemblies shall be painted after assembly with an approved air dry enamel which will adequately protect the exterior housings from the corrosive environment in the wastewater sewer system. Coating thickness shall be a minimum of 4 mils.

Pumps shall be selected to operate within 10 percent of the Best Efficiency Point (BEP). The overall lift station system shall be designed to allow for the selected pumps to operate within 10 percent of their BEP.

Factory testing of the pump assemblies shall be required and as a minimum, shall include:

1. All tests recommended by the manufacturer.
2. Verify the integrity of assembly and connections (no leaks, tightness of hardware, proper alignment, assembly, etc.) and that the nameplate and specified pump and pump motor (HP, Voltage, Phase and HZ) correspond.

3. The motor windings and seal housing chambers shall be hi-potted to test for insulation defects and moisture content. Check the resistance of the stator windings with a bridge to verify that the readings of all three phases are basically equal and within tolerance.
4. Energize pump motor, verify direction of rotation and that it corresponds to the nameplate.
5. Provide a written report of all testing with the shipped pump.

All pump assemblies shall be warranted against defects in workmanship and materials for whichever is the greater of: a 5 year pro-rated warranty from the date of purchase or as provided in the Defect Security Agreement with the County.

Month 0 –18 = 100% Month 19-31 = 75% Month 32-45 = 50% Month 46-60 = 25%

Pump motors shall have the following electrical characteristics: 230 -volt for 20 HP and lower or 460 -volt for greater than 20 HP, 3 phase, 60 hertz, minimum service factor of 1.15, continuous duty, maximum NEMA LRA/HP code of J, and NEMA Design B. Pump motors shall be non-overloading throughout the entire range of operation. The pump motors are to be induction motors which are built with moisture resistant Class F insulation. Each motor shall be capable of a minimum of 10 starts per hour without degradation of the windings. The pump motor shaft shall be made from a single, solid, forging of 303 (or better grade) stainless steel, tapered, keyed, and supported by a minimum of one heavy duty upper radial ball bearing and a minimum of one heavy duty lower thrust bearing. The bearings shall have a minimum B-10 life rating of 60,000 hours. The shaft and shaft extension shall be of minimum length and maximum diameter to reduce shaft deflection and prolong bearing life. The pump motor shall be designed for pumping at a maximum sump ambient of 40 degrees C (104 degrees F). The stator of the pump motor shall be copper wound (aluminum stator windings are not permitted) and equipped with at least two heat sensors (klixons installed in the stator end turns) which will shut the motor off in case of excessive heat built up. The heat sensors shall be connected in series with the motor starter coil, so the starter is tripped if the heat sensor opens. The pump motor housing shall be oil or air-filled type for cooling purposes. Oil filled motors shall use pure dielectric insulating oil. The pump motor shall be capable of operating at +/- 10% of rated voltage and +/- 5% of rated frequency without excessive heating. The pump motor shall not exceed a rise by resistance of 90 degrees C at full load over the entire performance curve. It shall be able to operate intermittently a full load while unsubmerged without damage. Power cables and signal cables shall be continuous (without splices from the pump motor to the power supply). Power cables shall be sized for operation at the rated service factor. The power cable shall be a single, multi-conductor, STW-A type that is epoxy potted and compression fitted for watertight sealing into the pump cable entry. As a minimum, the nameplate for the pump motor shall include: MODEL/SERIAL NUMBER, HORSEPOWER, VOLTAGE, FULL LOAD AMPS, FULL LOAD RPM, PHASES, FREQUENCY, NEMA LRA CODE, NEMA DESIGN, INSULATION CLASS, AMBIENT TEMPERATURE, LEAD CONNECTIONS FOR DIRECTION OF ROTATION, TYPE OF DUTY, TYPE OF BEARINGS, and PUMP IMPELLER SIZE. All electrical components used in or in conjunction with the sewage pump assembly shall be UL approved when UL approval is available for that type component.

The pumps shall be capable of pumping raw, unscreened sewage and able to pass a minimum 3-inch solid. Each pump shall have an enclosed cast iron or ductile iron impeller and shall be equipped with a bronze wear ring. The pump lifting cover, stator housing, and volute casing shall be gray cast iron, ASTM A48, Class 30. Castings shall have smooth surfaces that are devoid of blow holes or other casting defects. The pump lifting bail shall have a minimum of 4-inch diameter clear opening and shall be cast as part of the motor cover or fabricated from 316 stainless steel. All fasteners exposed to raw sewage shall be series 316 stainless steel. The backside of the impeller shall have pump-out vanes to keep contaminants out of the seal area. The impeller shall be dynamically balanced, and shall be single - or multi-vaned, with an

enclosed or recessed, non-clogging design. There shall be a maximum clearance of .125 inches between the seal housing and the top of the impeller. The pump shall have a minimum of two mechanical seals mounted in tandem with an oil chamber between the two seals. The oil chamber of each pump shall be equipped with an electric seal fail sensor which shall be connected to an indicating light at the control panel to annunciate a seal failure and a set of relay contacts for purposes of remote notification via the County RTU system. The unit shall be designed so that when the outer seal fails, the contaminates that enter shall not enter the bearing housing and cause damage to the bearings. The inner seal shall be replaceable without disassembly of the motor housing and without the need for special tools. As a minimum, the rotating seal faces shall be carbon and the stationary seal faces shall be ceramic.

All pumps shall be center-line discharge type constructed so that the discharge flange supports the full weight of the pump. Pump assemblies shall be complete with ductile iron BPIU discharge base elbows that are bolted directly to a base plate which is bolted directly to the wet well floor, guide flange adapter and guide rails. The discharge elbow shall have an automatic coupling end facing the pump and an ANSI Class 125 flanged end ready for connection to the flange of the riser pipe. The design of the pump assembly installation shall be such that the pump will be automatically connected to the discharge piping when lowered into place along the guide rails and shall seal leak-tight to the discharge base elbow by the weight of the pump assembly resting in the installed position. The pump base elbow shall be mounted on an ASTM A588 (COR-TEN) steel mounting plate that is level and is bolted to the wet well floor using 3/4-inch 316 stainless steel threaded rods with Hilti HVA anchors or approved equal anchors and shall have base ell mounting bolts of 3/4-inch 316 stainless steel that are mounted in place and welded to the plate. The pump guide rails for each pump shall be constructed of two separate whole length sections of 2-inch Schedule 40, 316 stainless steel pipes, set 4 inches on center.

The pump assemblies shall be easily removed for inspections or service, requiring no fasteners to be removed or disconnected, and no need for personnel to enter the confined space of the wet well, by simply hauling up on the lift chains. The lifting chains shall be type 316 stainless steel, and shall be 1/4-inch for pumps less than 25 HP and 3/8-inch for pumps 25 HP and greater, or as required by the pump assembly weight. Chains shall be attached to the pump lifting bails using 316 stainless steel shackles and shall extend to the inside top of the wet well. All rails and mounting hardware shall be 316 stainless steel.

- F. Riser and Fittings. All force main piping and fittings within the wet well from the pump base elbow to the check valve, shall be DR-11 HDPE; only molded HDPE fittings shall be used upstream of the check valves. The HDPE discharge piping from the pump base ells (in the wet well) and to the valve assembly check valves shall be connected using HDPE flange adapters with 316 stainless steel backup rings. No ductile iron bodied fittings shall be located between the pump base elbow and the check valves. A HDPE eccentric reducer shall be used when increasing pipe diameter from the base elbow to the discharge piping. All HDPE connections shall be thermal fused. All piping downstream of the tee/cross in the valve assembly to the first underground fitting shall be ductile iron pipe, after which PVC DR-18 shall be used.

All flanged fittings shall use 316 stainless steel bolts, nuts and washers. All threads shall be treated with Bostik Never-Seez anti-seizing compound or approved equal. All bolts on the flange connection at the pump base ells shall have two nuts with a lock washer between them or a nylon lock nut.

All stainless steel fasteners shall be treated with Never-Seez prior to assembly and torque according to the fitting manufacturer's recommendation.

The riser pipes shall be attached to riser pipe brackets by cushioned 316 stainless steel U-bolt clamps. The cushion design shall distribute the total load allowing the U-bolt to become a full contact hanger. The U-bolts shall be tightened to secure the riser pipe as to grip the pipe without deforming the pipe when bolted to the brackets. The riser pipe brackets shall be constructed of 316 stainless steel 2 inch tubing (or

2 inch 316 stainless steel angle) with 6"x6"x1/4" 316 stainless steel plates welded to each end and attached to the wet well walls by two (min) 316 stainless steel anchors.

- G. Hardware. A multi hook stainless steel hanger shall be installed inside the wet well access opening for supporting the float switches and pump electric cables. The multi hook hanger shall be constructed from 1/4-inch x 2-inch type 316 stainless steel flat stock with individual hooks constructed of 1/4" type 316 stainless steel rod stock. Individual hangers shall be installed on each side of the upper guide rail bracket for each pump to support the pump lifting chain and power cable. The lifting chain hook shall be constructed from 3/8-inch type 316 stainless steel rod stock. The pump power cable hook shall be constructed from 1/4-inch x 1-inch type 316 stainless steel flat stock.
- H. Painting and Coating. All paint and other coatings shall be applied in accordance with the product manufacturer's specifications for the surfaces being coated. All ductile iron body valves shall have a factory applied fusion bonded epoxy coating inside and outside. A holiday free factory certification per ASTM G62, Method A, (Low Voltage) shall be provided for the interior coating at the time of delivery. No field-applied paintings or coatings shall be applied to the valves.

All ductile iron pipe and fittings shall have an approved interior green, factory applied amine cured novalac ceramic epoxy or a modified polyamine ceramic epoxy interior lining, dry film thickness shall be as defined in the Approved Products List. All buried ductile iron pipe and fittings shall have a standard 1-mil asphaltic exterior coating per AWWA C151, or as defined in the Approved Products List. All above-ground ductile iron pipe and fittings shall have a factory-applied epoxy primer. All above-ground pipe and fittings shall be painted Hunter Green (Rustoleum 7538).

- I. Stilling Well. The stilling well shall be a 6" PVC stilling well mounted such that the top is available to an open hatch cover. The bottom of the stilling well shall have two 316 stainless steel bolt all the way through both sides, passing through the center of the pipe, approximately 4" from the base of the pipe. It shall have 1/2" diameter holes drilled around the circumference at a rate of one hole per inch of length for at least the full wetted height. All mounting hardware shall be 316 stainless steel.
- J. Magnetic Flow Meter (where required). A flow meter may be required, and if so, shall be rated for continuous submergence, 0.05% accuracy with a polyurethane liner, flush electrodes, FM Class 1, Division 2, Groups A, B, C & D and shall be constructed for a flanged mount. Meter shall be supplied with a like size spool piece. The exterior control module/transmitter shall be mounted either inside or adjacent to the lift station control panel on the same support structure per the Lift Station Supervisor.

1.14.3 ELECTRICAL

- A. Service and Metering. The Contractor shall be responsible and shall pay for any permits, fees, and inspections required by the local power company for service installations. Three phase power shall be used unless otherwise approved by the County. Service for pump motors of 20 horsepower or smaller shall be 230 volts. For motors greater than 20 horsepower, the service voltage shall be 460. No phase converters will be accepted. All lift stations shall be equipped with a knife-type fused safety switch in a NEMA 4X 316 stainless steel enclosure, lockable in the ON and OFF position, between the service meter and the control panel to permit servicing of the main breaker without removing the service meter. All meter bases shall be aluminum. Minimum service size shall be 100 amp. Conduit connections to the disconnect shall be sealed using Myers conduit hub connectors (disconnect side).
- B. Conductors. All power conductors shall be single conductor, 600-volt, type THW or THHN stranded copper. Minimum conductor size shall be #12 AWG. ALUMINUM WIRE IS NOT PERMITTED. All control wiring shall be single conductor #14 AWG, 600-volt, type THHN stranded copper. All terminations and interconnections of control wiring shall be by means of compression-type lugs of the nylon self insulated

type with an inner bronze insulation grip sleeve on identified terminal strips. All control wiring shall be color coded as indicated on the standard details.

- C. Conduit. All power conductors from the utility source to the service meter shall be enclosed in PVC Schedule 80 conduit below ground and aboveground. All lift stations shall be equipped with one conduit to the wet well for each pump power cables and a separate conduit to the wet well for the control (floatball) and signal cables. In lift stations with large horsepower pumps and pumps equipped with sensor cables, the conduit size and quantity shall be determined by the County. All conduit to the lift station wet well shall be minimum 2" Schedule 80 PVC and shall be run by the shortest route possible. All terminations shall be made inside the electrical control panel. All flexible conduit shall be non-metallic.
- D. Control Panel. All lift stations shall have one automatic control panel, one telemetry control unit enclosure with specified TCU (most current model) with assigned radio frequency and one junction control box for motor control, floats, seal fail and transducer. The control panel will be ordered through Barney's Pump of Lakeland, FL. The telemetry control cabinet will be ordered through Data Flow Systems (DFS), part# RJ1816HPL. Specify if 480V 3 phase is needed. Enclosure must be ordered with 'NO" tower mounting brackets.

All cabinets shall be white in color unless specified otherwise. The 304 S.S. control cabinet and junction box shall be powder coated white.

The Order Numbers and specification are listed below.

Barney's Pumps approved panels by Manatee County

Part#	STD. FLA	MCB/ECB	PCB	Starter	Size	Note:
ManCoCP240_1_3_VFD	11A Max	100	40	FRN003E1S-7U	N/A	11A Max Pump FLA (VFD)
ManCoCP240_1_5_VFD	19A Max	125	70	FRN010E1S-2U	N/A	19A Max Pump FLA (VFD)
ManCoCP240_3_2_FVNR	8.3	100	15	14DUC32AF	1	
ManCoCP240_3_3_FVNR	9.5	100	15	14DUD32AF	1	
ManCoCP240_3_5_FVNR	15.3	100	25	14DUE32AF	1	
ManCoCP240_3_7.5_FVNR	25.2	100	40	14DUE32AF	1	
ManCoCP240_3_10_FVNR	29.5	100	50	14EUE32AF	1.75	
ManCoCP240_3_15_FVNR	44.2	125	70	14FUF32AF	2	
ManCoCP240_3_20_FVNR	54.4	175	90	14HUG32AF	3	
ManCoCP240_3_25_FVNR	68	200	100	14HUG32AF	3	
ManCoCP480_3_2_FVNR	4.1	100	15	14DUC32AF	1	
ManCoCP480_3_3_FVNR	4.8	100	15	14DUC32AF	1	
ManCoCP480_3_5_FVNR	7.8	100	15	14DUC32AF	1	
ManCoCP480_3_7.5_FVNR	12.6	100	20	14DUD32AF	1	
ManCoCP480_3_10_FVNR	14.7	100	25	14DUD32AF	1	
ManCoCP480_3_15_FVNR	22.1	100	40	14EUE32AF	1.75	
ManCoCP480_3_20_FVNR	27.2	100	50	14FUF32AF	2	

MANATEE COUNTY PUBLIC WORKS STANDARDS

PART 1 - UTILITY STANDARDS MANUAL

ManCoCP480_3_25_FVNR	34	100	60	14FUF32AF	2	
ManCoCP480_3_30_FVNR	40.1	110	60	14HUG32AF	3	
ManCoCP480_3_40_FVNR	52.2	125	80	14HUG32AF	3	
ManCoCP480_3_50_FVNR	70.5	175	110	14HUG32AF	3	
ManCoCP480_3_75_FVNR	99.4	250/200	150	14IUH32AF	4	
<p>All part numbers include junction box Fuji Inverters/VFD's only Part number for cabinets that are single phase does not include inverters - sold separately.</p>						

The control panel, telemetry control cabinet, and motor cable junction box along with the safety switch box and electric utility power meter, shall be attached to horizontal support channels with stainless steel fastening systems designed for use with the support channel. The horizontal channels shall be 1-5/8 inch, 12 gage (or thicker) solid stainless steel channels attached (flat side out) with 3/8-inch 316 stainless steel all thread rod with 316 stainless steel flat washers and nuts to two vertical 3 inch diameter 316 stainless steel, schedule 40 posts. The horizontal channel ends shall be covered with plastic caps to prevent injury to personnel. The 3-inch vertical posts shall have plastic end caps or 316 stainless steel end caps at the top and shall be anchored in concrete adjacent to the lift station wet well. See County Standard, "Sewage Lift Station Meter & Electrical Details". No fittings shall enter from the top or back of the control panel. All fittings shall enter the side or bottom of the control panel and shall penetrate the control panel with Myers Hubs.

The overall control panel shall be a minimum of 30"x 36"x 12" deep and of adequate size to completely cover (without crowding) all wiring and components mounted inside it. It shall have provisions for the mounting of all basic and optional controls and instrumentation. Install engraved nameplates defining door mounted hardware. The electrical control panel shall have a complete wiring schematic which is laminated in plastic and attached to the inside of the outer control panel door.

All components shall be installed per the most current NEMA and NEC regulations and standards. The components shall be industrial NEMA rated (I.E.C. is not acceptable) and UL approved when UL approval is available for that particular type component. The components of the panel shall be held in place with stainless steel, slotted, plan head machine screws with star type washers. The panel shall be tapped to accept the mounting screws of the components and no self-tapping type screws shall be used. The control panel shall have the following items installed on the back plane or on aluminum "high hats" attached to the back plane, so the body of the component is flush with the dead front door to allow operation and reset of the components without opening the dead front door: main power breaker, emergency power circuit breaker, individual pump circuit breakers, control circuit breaker and G.F.I. duplex receptacle circuit breaker. The control panel shall have the following items installed directly to the back plane: individual motor starters, power distribution blocks, neutral bar assembly, grounding bar/lugs, terminal strips, 2-inch PVC conduit for control and telemetry wiring and fuses, and surge suppressor. The control panel shall have one G.F.I. duplex receptacle installed on the dead front door. The exterior of the control panel shall have one emergency generator receptacle and one flashing red light. The individual placement of all the components of the control panel shall be installed as indicated in the standard details.

- E. Ratings. The controls shall be rated for the supply voltage (230- or 460-volts), 3 phase, 60-hertz. In the event that three phase power is not available at the location of the control panel, the cabinet shall be either ManCoCP240 1 3 VFD (3 hp) or ManCoCP240 1 5 VFD (5 hp) inverters. All control voltage to the wet well shall not exceed 24 volts DC.

- F. Wiring Method. All power conductors from the main circuit breaker to all other circuit breakers shall be connected via a Square D model LBA363206, Marathon #1333555, or equal power distribution block. All electrical panel components shall have individual neutral wires. All neutral wiring shall be connected via a Square D model SN12-125 neutral assembly. Wiring is to be continuous with no splices between connections. Provide a Square D model PK9GTA grounding bar at the bottom of the backplate. This grounding bar will be the central connection point of all ground wires for the system with the exception of the pump power cords and surge arresters. The pump power cords and surge arresters shall be grounded via individual ground lugs that are to be attached to the control panel back plane. Provide two 12 terminal, Ideal Model 89-208 terminal strips to make electrical connections in the control panel. One terminal strip shall be used exclusively for 24-volt connections (TB-1) and the other shall be used exclusively for 120-volt connections (TB-2). The power distribution block, neutral assembly, grounding bar and terminal strips shall be located as indicated in the standard details. Use 316 stainless steel screws and fasteners for all wiring connections.
- G. Circuit Breakers. The panels shall be equipped with main and emergency circuit breakers for a minimum size of service of 100 amps. The main and emergency circuit breakers shall be interlocked so that when one is in the open position, the other circuit breaker must be in the closed position. There shall also be an individual circuit breaker for each pump, a control circuit breaker, a 20 amp circuit breaker for site lighting, a 20 amp circuit breaker for the flow meter (re-pump stations only) and a minimum 20 amp circuit breaker for the 120 volt GFI protected convenience outlet that is mounted on the inner control panel door. All circuit breakers shall be mounted in the control panel per the standard details. The circuit breakers shall be of the heavy duty thermal magnetic trip variety. For circuit breakers up to 100 amps, use Square D series QOU or County approved equal. For circuit breakers greater than 100 amps, use Square D "Mag Guard" series with adjustable trip for the pumps, main and emergency breakers shall be Square D QBL, HGL, or JGL.
- H. Motor Starters. Pump motors shall each have a NEMA-rated, magnetic starter sized as called for on the construction plans. No starter smaller than NEMA size 1 shall be used. Starters shall be full voltage, non-reversing type. These starters shall be Siemens series ESP-100 or County approved equal with special phase loss protection and a special factory coating of the circuit boards which prevents hydrogen sulfide damage. The starters shall be equipped with under voltage release and overload protection on all three phases. The motor starter contacts (if used) shall be constructed so that they may be easily replaced without removing the starter unit from its mounted position. The overload reset device shall be operable without having to open the inner swing panel.
- I. Lightning Arresters. There shall be a Ditek DTK Series lightning arrester/surge suppressor installed on the incoming power source. It shall be mounted on the bottom exterior or placed inside of the safety switch enclosure and connected to the LOAD SIDE of the safety switch and overload reset.
- The main circuit breaker and the RTU circuit breaker shall also each have a Ditek CM+Series lightning arrester/surge suppressor connected to the load side of the breaker wiring. These lightning arresters/surge suppressors shall be mounted with the supplied adhesive strip on the back of the "high hat" supporting the breakers. The exact model lightning arresters/surge suppressors shall be based on the voltage and number of phases of the protected circuits.
- J. Liquid Level Switches and Sensors. A minimum of four float switches are to be installed in the wet well to monitor and control liquid level height. The switches shall be an approved single pole mechanical type switch. They shall be designed to actuate when the longitudinal axis of the float is horizontal, and deactuate when the liquid level falls one inch below the actuation elevation. The switching arrangement shall be normally open when deactivated. The output leads shall be connected in the control panel as shown in the standard details. The control voltage to the level switches shall be 24 volts DC and the

switches shall be sized to operate at that voltage. In addition to the above, lift stations that re-pump sewage flows (directly or indirectly) from other lift stations shall have a pressure transducer mounted inside a stilling well as the primary level sensor.

The wiring connecting the cable junction box to the wet well floats shall be a continuous length (no splices) of flexible rate 600-volt, minimum diameter of #18, type S.O. cable. The float switches shall have all connections made inside the junction box using crimp on spade terminals that are landed to the terminal strip. The wiring shall be installed so there is a minimum of four feet, and a maximum of 6 feet, of excess cable in the wet well for relocation of the float switches.

- K. Alarms. Each lift station shall have one flashing red light to signal high level conditions. A flasher unit shall be installed and mounted in the control panel enclosure to operate the led flashing light attached to the unistrut.
- L. Generator Receptacle. A generator receptacle to permit the installation of a portable emergency generator as the power source when the local utility power company power supply is lost shall be installed on the outside of the control panel as indicated on the standard details. It shall be directly connected to the emergency circuit breaker inside the control panel. The emergency and main circuit breakers shall have a mechanical interlink between them which shall allow only one source to supply power to the control panel at any given period of time. The generator receptacles shall be:

<u>Power Supply</u>	<u>Required Receptacle</u>
0-100 Amp, 230 Volt	Russell Stoll JRSB1044FR
100-200 Amp, 230 Volt	Russell Stoll JRSB2044FR
0-200 Amp, 460 Volt	Russell Stoll JRSB2034HR

- M. Seal Leak Moisture Detector. Provide for each pump a moisture sensing sensor which will detect when moisture has penetrated the seal chamber. The moisture seal detector shall be connected to the County RTU system to notify lift station maintenance personnel when a seal has allowed moisture to enter the oil chamber of the pump. An indicating lamp is to be mounted in the control panel as illustrated in the standard details to also signal the seal failure.
- N. Telemetry Control Unit. The remote terminal/pump control unit shall be a complete TAC Pack TCU system (most current model) as manufactured by Data Flow Systems, Inc. The unit is to be a fully programmable, dual function device. It shall be used to monitor and control SCADA equipment and it shall have all the necessary hardware and software to control three pump motor starters. Its operation is based on level inputs from a minimum of four float ball switches in the wet well. It shall have the ability to control pump alternation, activate and deactivate remote and local alarms, and communicate with the HT3 SCADA System. It shall be equipped with RTU surge protection and a transient filter shield. The unit shall have an uninterruptible power source and contain all the components and be electrically connected as indicated in the standard details. It shall be equipped with an antenna tower with supporting mast and coaxial cable that is required by the manufacturer for that particular system. The battery backup will be contained with the TCU in its own enclosure. The installation shall include the required FCC licensing. The antenna and mast shall be rated for 150 MPH winds. Tower heights above 20 feet shall be as defined by the Approved Product List.

Lift stations that re-pump sewage flows (directly or indirectly) from other lift stations with 3-pumps or less will require a Telemetry Control Unit (TCU) to receive input from the force main pressure transducer and flow meter. Lift station with 4-pumps will require a Remote Telemetry Unit (RTU) with a Programmable Logic Controller (PLC) that needs an Analog Monitor Module (AMM).

Telemetry control and remote terminal/pump control units are not required for privately owned and maintained lift stations.

- O. Grounding. Install a 5/8" x 10' copper-clad ground rod for each electrical service. Connect to the ground rod a #6 bare copper wire to connect with the electrical panel grounding bar. Provide another, separate ground rod, tower clamp, and #6 bare copper wire to connect directly to the antenna tower, control cabinet/TCU cabinet, polyphaser, and ground. The ground rods and #6 bare copper wires shall be connected by an exothermic weld (cad weld).
- P. Site Lighting. A minimum 6000 lumens LED shall be mounted on the system tower for illumination of the lift station area. The manually operated light shall be mounted on 3/4-inch aluminum rigid conduit connected to the RTU tower using 90-degree korns clamps.

1.14.4 GRINDER LIFT STATIONS

- A. Grinder pumps shall be used where the required discharge rate is low and the discharge pipe is required to be smaller than 4-inch diameter. Grinder lift stations shall be constructed essentially to the same standards as the larger standard lift stations, with full plastic liners, dual pumps with guide rails, control panels, RTUs, antennas and masts, etc., but sized smaller to accommodate the lesser capacity. Wet well diameters may be smaller than 6 feet, but shall be no smaller than 4 feet. Riser pipes shall be no smaller than 1.25 inches diameter, and force mains shall be no smaller than 2 inches diameter. Ball check valves shall not be used.
- B. Grinder pumps will not be required to pass a 3-inch solid, but shall rather be capable of grinding all materials normally found in domestic raw wastewater into a pumpable slurry. The grinder cutters shall be made of 440C stainless steel hardened to Rockwell 60C. Motors shall be 230-volt, 3 phase, 60 hertz, 3450 or 1750 RPM speed, and shall otherwise meet the same requirements as for the larger standard sewage pump motors. Minimum hatch cover sizes for grinder lift station wet wells shall be 30 x 36 inches.
- C. There shall be an approved shut-off valve (tapping gate valve) installed at the connection of a grinder lift station pipeline to a County force main, and where the grinder lift station is maintained by a private entity, there shall be another approved shut-off valve (plug valve) installed at the point where the grinder pump pipeline enters the public right-of-way or public utility easement. The force main shall be at least 18 inches below the top slab within the valve vault. A 90-degree bend, which is turned down, shall be installed 18 inches outside of the valve vault to lower the force main to obtain a minimum 3 feet of cover.

Wet wells and valve vaults for grinder lift stations may be fiberglass or HDPE plastic. If fiberglass, the resins used shall be a commercial grade unsaturated polyester or vinyl ester resin. The reinforcing materials shall be commercial Grade "E" type glass in the form of continuous roving and chop roving, and shall have a coupling agent that will provide a suitable bond between the glass reinforcement and the resin. The inner surface exposed to the chemical environment shall be a resin-rich layer of 0.010 to 0.020 inches thick. The inner surface layer exposed to the corrosive environment shall be followed with a minimum of two passes of chopped roving of minimum length 0.5 inch (13 mm) to maximum length of 2.0 inches (50.8 mm) and shall be applied uniformly to an equivalent weight of 3 oz/ft². Each pass of chopped roving shall be well-rolled prior to the application of additional reinforcement. The combined thickness of the inner surface and interior layer shall not be less than 0.10 inch (2.5 mm). The interior surface shall be free of crazing, delamination, blisters larger than 0.5-inch in diameter and wrinkles of 0.125-inch or greater in depth. Surface pits may be permitted if they are less than 0.75-inch in diameter and less than 0.0625-inch deep. Voids that may not be broken with finger pressure and that are entirely below the resin surface shall be permitted if they are less than 0.5-inch in diameter and less than 0.0625-inch thick. After inner layer has been applied, the wet well and valve vault wall shall be

constructed with chop and continuous strand filament wound manufacturing process which insures continuous reinforcement and uniform strength and composition. Wet well and valve vaults may require resin fiber-reinforced bottoms.

Wet well bottom shall have a minimum 3-inch anti-flotation ring. Wet well and valve vault bottom shall be designed to resist all pressures induced by water, soil and wheel loads with a maximum deflection of 1/4-inch.

No hardware shall penetrate the wet well walls. The wet well wall shall include built / molded in channel supports for every 8 feet of vertical discharge piping for mounting pipe support braces and for mounting both guide rails and hooks to hang float balls, pump lifting chains, etc. at the top of the wet well. All pipe openings shall have resilient pipe to wet well seals.

The 1:1 bottom fillet may be molded or formed fiberglass or plastic or concrete. Concrete also may be used on the top of anti-flotation ring and as required to resist buoyancy. The wet well and valve vault shall resist flotation with ground water level assumed to be at finished grade. The Engineer of Record shall submit flotation calculations to Manatee County when submitting Construction Drawing approval.

All fiberglass and plastic wet wells and valve vaults located such that a vehicle may run over it shall have a minimum dynamic-load rating of 16,000 lbs. when tested in accordance with ASTM D3753. To establish this rating, the complete wet well and valve vault shall not leak, crack, or suffer other damage when load tested to 40,000 lbs. and shall not deflect vertically downward more than 0.25 in. at the point of load application when loaded to 24,000 lbs. Thickness of fiberglass and plastic wet wells and valve vaults shall be determined by calculations submitted when submitting construction drawings for approval. The Engineer of Record shall perform the calculations or shall submit a certification that he or she reviewed calculations prepared by others and that the aforementioned requirements have been met.

The wet well cylinder shall have the minimum pipe-stiffness values shown in table below when tested in accordance with ASTM D3753 Table 1.

WET WELL LENGTH (FT.)	PIPE-STIFFNESS F/AY, [PSI (k Pa)]
3 - 6.5	0.72 (4.96)
7 - 12.5	1.26 (8.69)
13 - 20.5	2.01 (13.86)
21 - 25.5	3.02 (20.82)
26 - 35	5.24 (36.13)

The exterior surface shall be relatively smooth with no sharp projections, free of blisters larger than 0.5-inch in diameter, delamination or fiber show.

Each wet well and valve vault shall be designed and built to meet all required ASTM D3753 designations for dimensional requirements, hardness, chemical resistance, and workmanship. Test records shall be provided to the Owner/Engineer of Record and to the County Inspector.

The Contractor shall set sections vertical and in true alignment. The finished wet well and valve vault shall not be out of plumb by more than 3/8-inch per 10 feet of height.

Each wet well and valve vault shall be marked on the inside and outside with the following information: Manufacturer's name or trademark, factory location, serial or model number and total length.

1.14.5 FLOODING

Wastewater lift station structures and electrical and mechanical equipment shall be fully protected from physical damage from flood water intrusion by the 100-year flood. Wastewater lift stations shall remain fully operational and accessible during the 25-year flood. Regulations of state and federal agencies regarding obstructions of the lift station site by flood waters shall be observed during the design of the development.

1.14.6 ENTRANCE HATCH ELEVATIONS

The wet well entrance hatch and valve assembly slab shall be set at least 4 inches above the 100-year flood plain elevation, or 8 inches above the 25-year flood plain elevation, or 4 inches above the surrounding grade, or 12 inches above the adjacent roadway crown elevation, whichever is highest. Where this is not practical, deviation from the above must be approved by the County on a case-by-case basis.

1.14.7 WATER SERVICE

All lift stations shall be equipped with a 1-inch water service. Each water service shall be equipped with a minimum 5/8-inch water meter, a 3/4-inch reduced-pressure principle backflow prevention assembly (Wilkins 975XL2 or Apollo RPLF4A), and a 3/4-inch brass hose bib. The water meter and backflow prevention assembly shall be located within two feet of the lift station easement (or property) line. All water meters shall be obtained from the Manatee County Water Meter Department.

Reclaimed water shall not be used.

1.14.8 SHOP DRAWINGS AND INSPECTIONS

When calling for inspection, the Contractor shall have the approved shop drawings available on-site for review by the inspectors. The Contractor shall also deliver to the Lift Station Section inspector, the pump manufacturer's technical manual with the model number, serial number, and certified pump curve, for each pump prior to acceptance by Manatee County for maintenance.

1.14.9 REQUIRED EASEMENTS

An easement for ingress and egress to the lift station and an easement for the lift station must be granted and recorded before the lift station can be accepted by Manatee County for operation and maintenance.

1.14.10 SITING

- A. The siting of all lift station facilities shall be subject to review and approval by Manatee County. All lift stations shall be located on a separate parcel of land or within a utility easement in common open space. The station shall be properly sited with due consideration of the neighborhood, surrounding site features, landscaping, aesthetics, safety and security. The station and associated landscaping shall not be sited on a right-of-way, private road, median, front yard of a residence, or within a visibility triangle. The lift station wet well, valve assembly, control panel, and telemetry antenna shall not be sited within 20 feet of overhead power lines.
- B. Each lift station site shall have a vehicular access drive paved with a concrete surface course over a base course. The drive shall be designed to allow a service truck to park off of the right-of-way or roadway easement and to also allow the service truck to back up to the wet well such that the wet well is directly to the rear of the truck or adjacent to the side of the truck. The lift station control panel, telemetry

antenna and hose bib shall not be located between the vehicular access driveway and the wet well, valve assembly, and/or valve vault.

- C. There shall be at least a 20-foot easement in all directions from the lift station site equipment. There shall be no obstructions within the easement such as buildings, walls, fences, etc., other than those that are part of the lift station and identified in these standards. A minimum setback of 5 ft shall be provided between lift station structures/equipment and the security fence. Lift station easement shall extend a minimum of 15 ft beyond all four sides of the security fence. If the lift station is adjacent to the street's right-of way, the lift station easement shall extend to the ROW line. The lift station site shall be made accessible with a minimum 30 ft wide corridor/easement.
- D. Surface stormwater flow shall be directed around the lift station site. The site shall be graded to provide sheet flow of site runoff away from the equipment and direct it to a suitable swale or drainage outfall. The construction drawings shall include a lift station site plan with a grading and drainage plan, along with a landscaping plan.

1.14.11 LANDSCAPING AND IRRIGATION

- A. **Landscaping trees and shrubs.** The lift station site shall have shrubs planted around the perimeter of the lift station security fence in a hedge-like placement. Shrubs shall have a minimum spacing of 3 feet between the centers of the shrub's base stem. For private lift stations that are located in non-residential areas, shrubs are optional for the sides that are not adjacent to thoroughfare roads, non-thoroughfare roads, and residential areas. For lift stations that are located adjacent to thoroughfare roads and non-thoroughfare roads, a minimum of two small understory trees or palm trees shall be planted between the lift station security fence and the right of way line. For lift stations within residential areas or located adjacent to residential areas, a minimum of two additional understory trees or palm trees; for a total of at least four understory trees or palm trees shall be planted around the lift station (these landscaping requirements are not applicable to lift stations that only serve one single family residence.) A minimum setback of 5 feet shall be provided between the shrub's base stem and the security fence to provide an access way for service personnel. A minimum setback of 10 feet shall be provided between the trunk of understory trees/palm trees and the security fence.

Understory trees shall not have a mature height exceeding 30 feet. Small understory trees, palm trees and shrubs shall not have evasive roots. The minimum height of understory trees shall be six (6') feet at time of placement. The minimum height of palm trees shall be fifteen (15') feet at time of placement. The minimum height of shrubs shall be two (2') feet at time of placement. Shrubs shall have three gallon root balls. Shrub growth habits shall be upright, globose, or columnar. Shrub growth habits shall not be spreading or broad spreading. The understory trees and palm trees shall be planted to accent the shrub placement. Tops of root balls of plants shall be set at or slightly above existing grade. All plant material to be Florida Grade #1 or better, as defined in "Grades and Standards for Nursery Plants," State of Florida Dept. of Agriculture. Plants shall be sound, healthy, vigorous, and free from plant diseases, insects, pests, or their eggs and shall have healthy normal root systems. Plants shall be nursery grown stock, freshly dug. No heeled in, cold storage, or collected stock shall be accepted. Ground covers shall have sturdy fibrous root systems. Staking and bracing shall be done on all trees using Arbor tape and the Duckbill anchor system, in accordance with sound nursery practices.

The shrubs, understory trees and palm trees shall be of the drought tolerant, low maintenance varieties. Plant selection shall be based on soil water retention as well as soil pH.

Examples of acceptable vegetation are as follows:

PLANT NAME	SOIL CONDITIONS WHERE PLANT WILL GROW		pH RANGE	
	Damp to poorly drained soils w/ low percolation	Well drained sands w/ high percolation	Plant tolerates acidic & alkaline soils	Plant tolerates acidic soils only
UNDERSTORY TREES (Mature height not exceeding 30 feet)				
Little Gem Magnolia (Magnolia grandiflora)	X			X
Southern Wax Myrtle (Myrica cerifera)	X	X	X	
Peregrina (Jatropha intergerrima)		X	X	
Bottle Brush Tree (Callistemon citrinus)		X		X
Crape Myrtle Tree (Lagerstroemia Indica)		X		X
Feijoa (Feijoa sellowiana)		X	X	
PALMS				
Cabbage Palms (Sabal palmetto)	X	X	X	
Pindo Palms (Butia capitata)		X	X	
Dwarf Royal (aka Christmas) Palm (Veitchia merrillii)		X	X	
SHRUBS & BUSHES				
Cocoplum (Chrysobalanus icaco)		X	X	
Pipestem (Agarista Populafollia)	X	X	X	
Sweet Viburnum (Viburnum odoratisimum)		X	X	
Yew podocarpus (Podocarpus macrophyllus)		X	X	

The following plant species shall not be planted at the lift station site:

Melaleuca quinquenervia (commonly known as Punk tree, Malaleuca); Schinus terebinthefolius (commonly known as Brazilian Pepper); Casuarina species (commonly known as Australian Pine); Rhodomyrtus tomentosa (commonly known as Downy Rose Myrtle); Mimosa pigra (commonly known as the Catclaw Mimosa); Dalbergia sissoo (commonly known as the Indian Rosewood); and Cupaniopsis anacardioides (commonly known as the Carrotwood).

- B. Ground cover. There shall be no vegetation within the lift station fencing. Site shall include a polypropylene weed barrier fabric that is covered with a minimum of 2-inches of washed shell, or rock within lift station fencing. Landscaping stones shall be inert and nonleaching. Crushed lime rock shall not be acceptable. Site shall include a polypropylene weed barrier fabric that is covered with 3 to 4-inches of shredded wood-type mulch that is located under the shrubs and up to the outside of the security fence. Polypropylene weed barrier fabric that is covered with 3 to 4-inches of shredded wood-type mulch shall be located under the trees for a minimum distance of 3 feet from the tree. Bahia, St. Augustine or Floritam sod or shredded wood-type mulch with a polypropylene weed barrier fabric shall be extended from the shrubs to the lift station easement line.
- C. Irrigation. An irrigation system shall be connected to a non-potable water source. A weather-tight time clock with built-in transformer, minimum of four zones (Rainbird ESP-4M, Toro CC-M-9, or equal) and a rain sensor (Mini-Clik, or equal) shall be furnished and installed. The irrigation controller shall be in a lockable control panel and attached with 316 stainless steel two piece pipe clamps or 316 stainless steel U-bolts to two vertical 3 inch diameter 316 stainless steel, schedule 40 pipes. The pipe clamp or U-bolt ends shall be covered with plastic caps to prevent injury to personnel. The 3-inch vertical pipe shall have 316 stainless steel at the top and shall be anchored in concrete. The irrigation system control panel recommended location is outside of the fence and behind the shrubs. The Contractor shall furnish the County a padlock with a set of two keys for the irrigation control panel. The number of zones shall be based on the proposed site, planting configuration, watering distribution, irrigation system demand, and type of vegetation to be irrigated.

The irrigation system shall be installed to irrigate the trees, shrubs and grassed areas; and designed to provide three-fourths (3/4") to one (1") inch of water per week and be in conformance with irrigation restrictions established by the Southwest Florida Water Management District (not restricted if using reclaimed water). The irrigation system shall adhere to the requirements of the Manatee County Land Development Code and to the "Standards and Specifications for Turf and Landscape Irrigation Systems", latest edition, as published by the Florida Irrigation Society, Inc. A permanent sprinkler system with distribution lines underground with mist and/or bubbler nozzles, as appropriate, above the ground are acceptable. A micro-irrigation system located within the planting beds of shrubs and trees is acceptable for that type of installation. In each accent, isolated or separate tree planting bed, a tree bubbler (Toro 514-20 or equal), shall be installed at each tree. In addition, a four (4') foot section of flexible PVC shall be provided for the tree bubbler at each tree. Drip line hoses shall have built-in emitters (Toro DL2000 or equal).

- D. Radio signal interference. Landscape buffer plantings are to be field adjusted in coordination with the siting of the lift station's radio antenna to eliminate signal interference. The antenna for the existing or proposed radio telemetry unit at the lift station requires direct line-of-sight signaling capability to the Utilities Department office that will receive the signal. There shall be an unobstructed horizontal angle of fifteen (15°) degrees from the antenna mast (7 1/2 degrees on both sides of the direct line-of-sight azimuth). No tree shall be planted within the designated unobstructed angle for a twenty (20') foot horizontal distance measured from the mast.

1.14.12 ACCESSIBILITY AND SECURITY

The lift station shall be readily accessible by maintenance vehicles during all weather conditions. A fully functional paved travelway shall be provided to the lift station driveway. The facility shall be located off the traffic way of streets and alleys. All hatches, electrical panel and irrigation panel doors shall be provided with lockable hasps or staples. Security fences with lockable gates shall be provided for all lift stations that are owned and maintained by Manatee County. Lift stations shall have a 6-foot high vinyl

coated chain link security fence with privacy decorative slats (color matched). Chain link security fencing shall be #9 gauge core, galvanized with vinyl coating, with 1 5/8 inch top rails, 2 3/8 inch Schedule 40 line posts, 2 1/2 inch Schedule 40 corner posts and 3 1/2 inch Schedule 40 gate posts for swing gates. Gate posts and track line posts shall be 4-inch Schedule 40 for cantilever slide gates. Maximum line posts spacing shall be equally spaced, not to exceed 8 feet. For private lift stations, the Engineer of Record shall evaluate the location of the proposed lift station and determine whether a security fence is necessary.

1.14.13 FORCE MAIN FLOW METER

Lift stations that re-pump sewage flows (directly or indirectly) from other lift stations shall be equipped with a submersible electromagnetic flow meter. The flow meter shall be mounted on an above-ground force main. The meters, gauges and all connections and wiring shall be rated fully submersible. The flow meter shall transmit 4-20 mA signals to the telemetry system via the Analog Monitor Module mounted inside the control panel. The signal cables and ground wire shall be installed through two separate 1-inch PVC conduits (signal cables in one; ground in the other) from the meter to the control panel and both conduits shall be sealed with a liquid-tight cord connector at the meter. The meter display unit shall be weather-proof and mounted on top of the meter for above ground installations; for belowground meter installations, the meter display shall be mounted on an aluminum stand adjacent to the meter vault or as directed by the County.

1.14.14 AUXILIARY BACKUP PUMP SET

- A. Equipment shall be new, factory and field tested, installed, and ready for operation. The pump set shall diesel powered and shall be provided by an approved manufacturer.
- B. Pump is to be built with the following characteristics/conditions:
 - 1. The pump should come on automatically when the wet well reaches a high-level condition.
 - 2. Primary level control shall be a level transmitter.
 - 3. Secondary level control shall be with backup floats (“high level” & “off”).
 - 4. Programmable controller that allows both scheduled & manual exercising.
 - 5. Pump and controls to have contacts for the telemetry system.
 - 6. Pump should have the capability to pass a 3” spherical solid.
 - 7. Pump has compressor assisted automatic priming.
 - 8. Pump to have a sound attenuated enclosure.
- C. The complete package, engine, pump, fuel tank, controller and other auxiliary components specified in this section shall be provided from a single supplier. The supplier shall be the manufacturer’s authorized distributor who shall maintain a service center capable of emergency maintenance and repairs with a maximum of four hours response time. The supplier shall have 24 hour/365 days per year service availability and factory trained service technicians authorized and capable to perform warranty service on all warrantable products.
- D. The supplier shall have satisfactorily provided and installed similar size / design pumping systems for at least 2 other municipalities.

1.14.15 PUMP

- A. Each pump shall be:
 - 1. Used for raw wastewater.
 - 2. Able to pass a 3" spherical solid.
 - 3. Be compressor-assisted self priming
 - 4. Initially start at primary rpm/capacity, with the ability to automatically ramp up to maximum capacity of double the primary capacity to keep up with flow, as required.
- B. The complete intake and discharge piping, fittings, and layout shall be sized and designed by the pump supplier to ensure the most efficient design and operation as possible. Site constraints shall be taken into account and coordinated with County personnel, as necessary.

1.14.16 INSTRUMENTATION AND CONTROL

- A. Each pump is to be capable of being started and shutdown through an automatic level control or manually. Level sensing shall be by two installation contractor installed systems: transducer as the primary indicator, and float balls as the secondary indicator.
- B. The controller shall start the pump automatically when the wet well reaches a high level condition. The controller shall be able to automatically ramp up the pump speed incrementally to the maximum pump capacity of double the primary capacity, if the wet well level continues to rise.
- C. The controller shall be programmable to exercise the pump automatically, and have the program adjusted by County personnel, if needed.
- D. An emergency stop button will also be installed to shut the system down. This button should be a minimum of two inches in diameter, painted red, labeled "STOP" and installed in a conspicuous location on the pump set. It shall be reusable and resettable.
- E. The control shall shut down and lock out upon: failing to start (overcrank), overspeed, low engine oil pressure, high engine coolant temperature, or operation of a remote manual stop station. A panel mounted switch shall reset the engine monitor and test all the lamps. Lamp indications on the control panel shall include as a minimum:
 - 1. Overcrank Shutdown - Red
 - 2. Overspeed Shutdown - Red
 - 3. High Coolant Temperature - Red
 - 4. Low Engine Oil Pressure - Red
 - 5. High Engine Coolant Temperature Prealarm - Yellow
 - 6. Low Engine Oil Pressure Prealarm - Yellow
 - 7. Low Fuel - Yellow
 - 8. Run - Green
- F. Each pump set is to be set up by the manufacturer to indicate to a remote location through the County's telemetry system:
 - 1. When pump set is in operation.

2. When pump fails (fails to start).
 3. When the fuel tank is low on fuel.
- G. The contractor shall install four wires from the pump control panel to the RTU control panel; wire type shall be 16 AWG, 16 strand flexing type MTW or TFFN 600 volt. The County's RTU system uses discrete- type signals with N/O type contacts. County shall make the actual connections to the RTU system.
- H. The wire coloring scheme shall be:
1. Brown - pump run
 2. Red - pump fail
 3. Yellow - low fuel
 4. Orange - common to alarms and connected to control panel power either 24 volt DC or AC.
- I. All penetrations in any enclosure shall be properly sealed from the weather.
- J. All wiring shall be installed in Schedule 80 PVC conduit sized according to the National Electrical Code for the number and size of conductors contained within. All trenches for underground installation of conduit shall be hand dug. Any electrical wiring that is installed between the lift station's structures shall be installed in a carrier pipe that is strapped to a structure.
- K. Install the electrical components per Manatee County Standards (see typical wiring layouts in the latest Manatee County Public Works Utility Standards).

1.14.17 ENCLOSURE

- A. The pump set and all the equipment supplied in this contract, shall be operated in a stationary outdoor environment. At each site, it shall:
1. Require weather protected enclosures. These enclosures shall protect the unit and all equipment and devices from the elements of the weather to include rain and winds.
 2. The enclosure shall meet all federal, state, and local regulations.
 3. All enclosures, boxes, trays, etc. shall have weep holes for condensation or water intrusion drainage. Any oil containment / catchment areas shall have provision to completely drain off water. The enclosure shall provide adequate ventilation for cooling and operation under full load conditions.
 4. The enclosure shall be constructed of aluminum with a minimum thickness of 14 gauge. The enclosure shall have an electrostatically applied, baked on, powder coated enamel or polyester finish a minimum of 2.5 mil thick. The color of the powder coating shall be similar to "Buff" or Pantone Green 5545 C, as noted on the drawings, and must be approved by Manatee County prior to installation of the product.
 5. The housing shall have hinged side access doors and a rear control door that are easy to remove. The side panels shall be easy to remove to allow access to all areas of the generator. All doors shall be provided with padlock hasps so that the County can install a standard padlock(s).
 6. All exterior assembly hardware, bolts and/or screws, handles, hinges, and hasps shall be 316 stainless steel. All exterior bolts and/or screws shall be tamper-proof. All tamper-proof screws

shall utilize the 6 lobe pin TX or Torx® pin-head security fasteners. A neoprene washer shall be installed between all bolts/nuts/washers and the enclosure's exterior finish.

7. The housing shall be factory assembled to the pump set skid base. The skid base shall be firmly fastened to a concrete foundation pad which is to be provided and installed as part of this contract. The connections shall be adequate to avoid movement from both wind and vibration loading. The skid base / framing surface protection coating shall be per the fuel tank coating requirements. All metal surfaces coming in contact with concrete or grout shall be coated with coal tar epoxy equal to Koppers 300M or a 1/32-inch neoprene gasket between the metal surface(s) and the concrete or masonry may also be used. The neoprene gasket shall be installed along the entire perimeter, not just at the fastening hardware.
8. The engine and pump shall be removable from the base for maintenance purposes.
9. The skid is to have adequate strength and rigidity to maintain alignment of mounted components without depending on the concrete foundation. Lifting attachments shall be arranged to facilitate lifting with slings without damaging any components.
10. The base shall incorporate a battery tray with battery hold down clamps within the rails. Provisions for stub up of electrical conduits shall be within the footprint of the set. Vibration isolation shall be integral between the pump set and base.
11. The enclosure shall be a low noise or sound attenuated enclosure. The noise level at any load operating condition, in any direction from the enclosure, shall not exceed 75 dBA at a distance of five (5) meters from the enclosure unless noted otherwise on the plans.

1.14.18 ENGINE

- A. The engine shall be a 4-cycle, direct injection diesel with forged steel crankshaft and connecting rods suitable for continuous operation. It shall be designed for stationary applications and shall be complete with all necessary auxiliaries needed for operation of the pump. The engine block shall be cast iron construction.
- B. The engine shall have an electronic governor which shall provide isochronous frequency regulation.
- C. The engine shall have an electric starter and battery(ies). See the Starting System section for further details.
- D. The engine shall have a mechanical, positive displacement, engine driven, lubrication oil pump. Provide full flow lubrication oil filters with replacement spin-on canister elements. Provide a dipstick for oil level indication and an easily accessible fill location.
- E. Supply a replaceable dry element air cleaner with restriction indicator.
- F. Provide an engine mounted thermostatically controlled water jacket heater. The heater(s) wattage size shall be determined by the manufacturer. The heater voltage shall be single phase, 120V, 60HZ.

1.14.19 STARTING SYSTEM - ENGINE

- A. The battery(ies) used for cranking the engine shall be the lead acid type, 12- or 24-volt, sized as recommended by the engine manufacturer. The battery(ies) shall have sufficient capacity to crank the engine for at least three cycles of 15 seconds on - 15 seconds off, for a total of 75 seconds. They shall be provided as new with the entire manufacturer's warranty.

- B. The battery(ies) shall be fastened securely in its(their) own tray within the footprint of the skid. The tray shall be acid resistant.
- C. Include all interconnecting conductors and connection accessories.
- D. A battery charger of appropriate rating which is voltage regulated, shall be provided for the engine. It shall be sized for the proper current, input AC voltage and output DC voltage. The charger shall be equipped with float, taper and equalize charge settings.
- E. A meter on the charger shall provide a visual output reading of the charger.
- F. On the engine, provide a factory mounted alternator with solid state voltage regulation and 35 Amp minimum continuous rating.

1.14.20 FUEL SUPPLY SYSTEM - DIESEL ENGINE

- A. Provide a sub-base type, double walled fuel tank, made of heavy gauge construction that is designed for full weather exposure. There is to be visual tank to foundation clearance. The tank is to have the following features:
 - 1. Tank shall be UL 142 listed.
 - 2. The capacity of the fuel tank shall be sufficient to run the generator continuously for 24 hours, but not to exceed a maximum of 540 gallons.
 - 3. Equipped with a mechanical fuel gage and low fuel level alarm that may be monitored from a remote location by a RTU which uses N/O type contacts.
 - 4. Two inch NPT fuel opening with spill protection and a lockable lid that is easily accessible.
 - 5. Emergency pressure relief vent opening on the inner and outer tanks.
 - 6. Inner tank leak alarm kit and low fuel alarm that may be monitored in some remote location by an RTU.
 - 7. Basin drain.
 - 8. Overfill protection / containment.
 - 9. Provide an integral fuel pump of sufficient capacity to sufficiently charge the fuel lines under any start or run condition.
- B. The overall fuel system is to comply with all applicable NFPA regulations as well as those required by the Florida Department of Environmental Regulation. This includes NFPA compliant labels for the fuel shut-off location and application of Diesel HAZMAT symbol stickers.
- C. Provide an anti-siphon valve in the fuel line at the output of the tank.
- D. A fuel filter shall be installed between the fuel tank and fuel inlet to the engine. It shall have a fuel water separator. The filter element shall be disposable and be easily removed and installed for maintenance purposes.
- E. Provide supply and return fuel lines of sufficient diameter for all load requirements, flexibility for maximum resistance to fatigue due to component operation and made of material which has maximum resistance to corrosion due to environment and fuel supply.
- F. The skid base for the fuel tank shall be firmly fastened to a concrete foundation which is to be provided and installed as part of this contract. The fuel tank & skid assembly shall be removable from the base.

Lifting points shall be provided for the tank skid. All metal surfaces coming in contact with concrete or grout shall be coated with coal tar epoxy equal to Koppers 300M or provide a 1/32-inch neoprene gasket between the metal surface(s) and the concrete or masonry may also be used. The neoprene gasket shall be installed along the entire perimeter, not just at the fastening hardware.

- G. The exterior coating of the fuel tank and skid base shall be Sherwin Williams SherGlass FF glass flake reinforced amine epoxy (formulated for immersion service) or equal. Color shall be haze grey, two coats of 12-15 mils on top of a stripe coat over all welds, crevices, edges and sharp angles, per manufacturer's recommendations.
- H. The fuel tank shall be full and topped off by the contractor when it is accepted by the County.

1.14.21 COOLING SYSTEM- ENGINE

- A. The engine shall be cooled by a unit mounted closed loop radiator system rated for full load operation in 50° C ambient condition with the ambient temperature as measured at the air inlet to the radiator. Radiator shall be provided with a duct adapter flange. The cooling system shall use a 50/50 (Prestone, Xerex or equivalent coolant and water) mixture provided by the supplier.
- B. Provide drain cocks or plugs in the engine block and radiator for easy changing and flushing of the coolant. Provide coolant drain extensions where necessary for easy access to the drainage device.
- C. Protection from rotating parts (fan, fan belt) shall be provided.
- D. Install a self contained thermostat module to automatically regulate coolant flow to maintain optimum constant coolant temperature as recommended by the engine manufacturer.
- E. Provide a coolant heater which is thermostatically controlled in the jacket of the engine.

1.14.22 EXHAUST SYSTEM- ENGINE

- A. The muffler for the engine shall be the critical grade made from aluminized steel of thickness and design as recommended by the manufacturer. The muffler shall be housed within the enclosure.
- B. All exhaust piping shall be stainless steel. Vertical discharge exhaust shall be equipped with a rain cap, appropriate condensation drains in the piping, and the outlet, and shall be designed so no external rain or moisture may enter the engine from the outside even if the rain cap fails.
- C. Rain Skirt - At the point where the exhaust pipe tubing penetrates the roof or side of the enclosure, a suitable "rain skirt" and collar shall be provided by the MANUFACTURER. It shall be designed to prevent the entrance of rain and allow for expansion and vibration of the exhaust piping without chafing or stress to the exhaust system. This detail must appear on the drawings submitted for approval. Care must be exercised so there is no recirculation of exhaust gases into the intake system.
- D. The connection of the engine to the exhaust system shall be a flexible section of corrugated stainless steel pipe. The connection of the exhaust pipe to the muffler shall be a stainless steel expansion joint with liners. The connection of the muffler to the end of the system shall be stainless steel pipe.
- E. The exhaust emissions shall fall within the guidelines of the EPA and other state and governmental agencies.

1.14.23 HOUSE KEEPING SLAB FOUNDATION

- A. The reinforced concrete slab for the pump and fuel tank is to be suitable to fully support the complete load under all load conditions with a reasonable safety factor, min. 8" thick. The top of the slab shall be

a minimum of two inches above the surrounding grade and extend a minimum of six inches past the footprint of the generator set.

- B. The Manatee County Building Department will require the contractor to submit a plan for the poured-in-place concrete slab being installed. The Building Department will accept a slab designed by the manufacturer for their respective pump set, provided the back-up information accompanies each plan. If the manufacturer does not provide a slab design, then the contractor shall submit a slab design that is signed and sealed by a Professional Engineer and meets the Florida Building Code.

1.14.24 FIELD QUALITY CONTROL

- A. Upon completion of installation, a factory authorized service representative of the product supplied, is to inspect all field assembled and installed components and make any necessary corrections to insure proper equipment operation. Any cost associated with this procedure shall be borne by the contractor.

1.14.25 TRAINING AND DEMONSTRATION

- A. A factory representative of the product is to provide the County's maintenance personnel with a thorough period of instruction and hands-on session regarding the operation, trouble shooting and maintenance of all components of the product. Typical training period: one hour for each site.

1.14.26 NOTICE OF DELIVERY, TESTING, TRAINING AND DEMONSTRATION

- A. At least seven business days of notice is to be given by the contractor to the County for delivery, installation, testing, training and demonstration of the product.

1.14.27 RECORD DRAWING REQUIREMENTS

Prior to the County's acceptance of the emergency backup pump system(s), the Contractor shall submit the following for each site(s):

1. Field test results showing compliance with the specifications.
2. A single O&M manual shall be provided that covers all parts of the generator system and controls for all installations contained in this contract. It shall be tabbed for each different size or type of equipment. The cover page shall indicate the manufacturer, date and contract number as well as listing all pump station sites it applies to.
3. Signed and sealed final RECORD DRAWING prepared from the site plan by a Professional Surveyor registered in the State of Florida showing all existing and new above ground facilities / improvements, new underground conduit locations, and/or property corners. A CAD file of the project survey can be requested from the County, if available.

The following information shall be provided on the record drawing site plans:

Location X, Y, & Z	Back-up Pump concrete slab, all new underground conduit pipes and conduits, control panel, & control panel bottom elevation.
Location in Z (elevations)	top of fuel tank and bottom of engine.
Call outs	Back-up pump details information, conduit size, fuel tank size in gallons

END OF SECTION

SECTION 1.15 RECORD DRAWINGS – OFFICE/RETAIL/INDUSTRIAL SINGLE BUILDING & LOT

1.15.1 GENERAL REQUIREMENTS

This section applies to all record drawings for a single business on a single lot with a single building with the following designations: Warehouse (not Warehouse, Mini); Retail Sales, General; Retail Sales, Neighborhood Convenience; Office; Office, Medical and Dental; Industrial, Light; Office, Professional; Restaurant; Restaurant, Drive-Through.

1.15.2 GENERAL

When construction is complete, record drawings, indicating the locations and elevations of the improvements that have been built, shall be provided to Manatee County Public Works Department. The record drawings shall be a special revision of the approved construction drawings and shall reflect all of the below requirements in content.

1.15.3 REQUIREMENTS AS TO FORM

- A. Every set of record drawings shall have a cover sheet with a vicinity map, which shows where the project is located, and the address of the property.
- B. Each sheet of the record drawings shall have the title “RECORD DRAWING” printed on it in large, bold lettering, near the title block. Each sheet shall also have the words “COUNTY MAINTAINED - WATER”, “- SEWER” and/or “- RECLAIMED”, or “PRIVATELY MAINTAINED - WATER”, “- SEWER”, and/or “- RECLAIMED” in large, bold lettering near the title block, and shall clearly define the separation between Public and Private via a text box with a leader arrow.

The Cover Sheet shall include a list of all contractors/subcontractors that performed work to complete the project and their specific role(s).

- C. Record information notes shall be positioned individually on the drawings near the depictions of the item to which each note corresponds.
- D. Record information notes shall be bold, italics, or boxed ([X]) to identify them as record information.
- E. Record drawings shall have a revision note such as “Record Drawing” in the revision block and a date corresponding to the date the record drawing was issued.
- F. Record information shall be presented in a clear and comprehensible form.
- G. The drawing scales used in the record drawings shall be the same as were used in the construction drawings, and the sheet number of each record drawing sheet shall be the same as the sheet numbers that were used on the construction drawings from which the record drawings originate. If additional sheets need to be added shall be numbered with a letter following the preceding sheet number: a sheet added between sheet 4 and 5 would be labeled 4a.
- H. All plan, profile, and detail sheets that were used to depict locations and elevations of utility structures in the construction drawings shall be included in the record drawing set.
- I. Record drawings shall accurately depict all existing improvements within the immediate vicinity of the constructed utilities. Existing improvements shall include, but not be limited to:
 - 1. Sidewalks, walls, fences, road surfaces, buildings, and other utilities,
 - 2. Areas within utility easements and areas within rights of way,

3. Areas within 15 feet of potable water mains, reclaimed water mains, sanitary force mains, and gravity sewer mains,
 4. Areas within 10 feet of potable water meters, reclaimed water meters, backflow prevention assemblies, and fire hydrants.
- J. Rights of way, easements, and property corners shall be shown and shall be of sufficient detail as to determine if the constructed utilities are within the easements or rights of way. A reference to the recording document (O.R. Book or Plat Book and Page) shall be included with any depiction of a right-of-way or easement. O.R. Book or Plat Book and Page are not required to be shown on the record drawings of a project for proposed rights of way or proposed easements that will be identified on the proposed final plat for the said project.
- K. Each roadway depicted on the drawings shall have the correct roadway name noted on it.
- L. Horizontal locations required for valves, fittings, services, and other utility structures shall be to the center of each installation.
1. Horizontal locations of all features shall be reported to the nearest 0.1 feet.
- M. Vertical elevations of required valves, fittings, services, and other utility structures shall be reported as follows:
1. Top of ground or pavement elevations required along pipelines shall be reported to the nearest 0.1 feet.
 2. Top of pipe elevations shall be to the nearest 0.1 feet.
 3. Elevations of manhole rims and manhole pipe inverts shall be reported to the nearest 0.01 feet.
- N. Computer drawing files submitted shall be AutoCAD 2016 or later release date versions. All CAD files and referenced CAD files, fonts, plot styles, etc. used to create the signed and sealed record drawings shall be provided and are required to be included in the submitted digital files. Computer drawing files' format submitted shall be compatible with the County's current version of AutoCAD, shall be in a .DWG format only, and shall be Windows 10 compatible. (*Tip: Use the e-transmit function of the AutoCad program.*)

1.15.4 MONUMENTATION

- A. Record information within the right-of-way shall be referenced by State Plane coordinates and swing-ties.
- B. A minimum of one on-site benchmark shall be described including datum. All benchmarks shall be based upon NAVD88. All record drawings shall be in NAVD88.
- C. All locations and elevations shall be field located by or under the direct supervision of a Florida Licensed Surveyor and Mapper.

1.15.5 CERTIFICATIONS

- A. Record Drawings shall be certified by a Florida Licensed Surveyor and Mapper. The certification shall state that the Record Locations and Elevations depicted on the Record Drawing are true and correct and were collected in the field by the Surveyor and Mapper or by a representative under the direct supervision of the Surveyor and Mapper.
- B. Record Drawings shall be certified by the Engineer-of-Record. The certification must state that the improvements have been constructed in substantial conformance with the approved plans.

- C. All visible record features, including sewer inverts, must be measured and located by the Surveyor or by personnel under his or her direct supervision. The certifying Surveyor shall be fully responsible for the accuracy of the record locations and elevations shown on the record drawings. However, the Surveyor may include statements on the record drawings indicating the following:
1. With the exception of the beginning, ending and the surface locations of the Horizontal Directional Drilling (HDD) log readings, the Horizontal Directional Drilling (HDD) locations and elevations provided by the HDD Contractor have not been field verified.
 2. State Plane coordinates and offset of pipe fittings are based on PVC pipe markers or 2" x 4" markers inserted by the Contractor on the top of pipe fittings.
 3. State Plane coordinates and elevation of potable water mains, reclaimed water mains, and sanitary force mains are based on PVC pipe markers or 2" x 4" markers inserted by the Contractor on the top of pipe.

1.15.6 RECORD INFORMATION WITHIN THE RIGHT-OF-WAY OR UTILITY EASEMENTS

- A. Water distribution utility systems, reclaimed water (or irrigation) utility systems, and sanitary sewer collection utility systems shall be located and the locations shall be depicted and noted on the record drawings by Northing and Easting (NAD83 Florida State Planes, West Zone, US Foot), and by Swing-ties, with Elevations relative to established benchmarks. For "single point" installations, swing ties rather than station and offset may be allowed.
1. Elements of the utility systems that shall be located and noted by State Plane Northing and Easting and Swing-ties:
 - a. water services (center of meter or meter box),
 - b. reclaimed water (or irrigation) services (center of meter or meter box),
 - c. backflow prevention assembly (directly beneath the assembly),
 - d. other miscellaneous utility structures with features at or above the surface of the ground.
 2. Elements of the utility systems that shall be located and noted by State Plane Northing and Easting, Swing-ties, and Elevation:
 - a. center of valve cover lids,
 - b. top of nut elevation,
 - c. center of sanitary sewer manhole covers (top of rim for elevations),
 - d. center of lift stations along with quadrant points of round tops / corners of rectangular tops (top of slab for elevations),
 - e. center of above-ground valve assembly slab, along with corners of slab (top of slab for elevation),
 - f. bottom center elevation of the lowest control panel cabinet,
 - g. all fittings, including water and reclaimed water service saddles (other than sanitary sewer service wyes),
 - h. center of sanitary sewer service clean-out cover (invert of 45° wye that is located directly below the clean-out cover for elevation),

- i. center of fire hydrants, (center of 5-inch Storz connection nozzle for elevation).
 3. At locations where a top-of-pipe elevation is required for pipeline, a top-of-ground or top-of-pavement elevation shall also be measured and noted on the drawings.
 4. Elements of the utility systems that shall be located and noted by elevation only: sanitary sewer manhole inverts of individual sewer pipes where they enter and exit the manhole.
- B. On record drawings, the actual positions of the pipelines or structures shall be measured, and they shall be depicted in their actual installed positions on the record drawings in all plan and profile views.
- C. Record information shall include:
 1. A thorough description of the pipes and all appurtenances that have been installed, including type of material or casing, size, class, diameter ratio, and other basic information, i.e., 45° Bend DI, or 6" PVC (DR18), etc.).
 2. The recalculated slopes of gravity sewer mains, based on the record survey of manhole inverts and lengths of pipes. Rounding up shall not be allowed.
 3. A bold notation shall be placed on each sheet, near the title block, indicating the status of the electrically detectable path marking tape and/or tracer wire installations. "Electrically detectable path marking tape and tracer wire were installed and successfully tested"; and/or "No electrically detectable path marking tape was required"; and/or "No tracer wire was required." The notation shall also include the date of the successful test"
- D. For new valves, the manufacture type (as in gate, plug, etc.), size (pipe nominal diameter) and make (manufacturer) of each valve shall be noted on the record drawings.
- E. Lift station control and equipment elevations that were shown on the original construction drawing lift station detail sheet shall be measured and the record survey elevations shall be shown on the record drawing revision of the detail sheet. Record pump information, including pump make, model, year of manufacture, serial number, impeller diameter, voltage, horsepower and speed, shall be shown on the record drawing revision of the lift station detail sheet.
- F. Also included shall be the "Lift Station Start-up Information Sheet" provided by the pump manufacturer shall be included in the record drawings.
- G. Horizontal Directional Drilling (HDD) and Jack-and-Bore locations and elevations shall be shown on the Record Drawing. The Surveyor shall locate the beginning, ending and the surface tracking locations of the driller's log readings, and these locations shall be indicated on the record drawings. The HDD Contractor shall provide a certified report and bore log indicating the horizontal and vertical location at least every 25 lineal feet along the pipe. The horizontal locations on the bore log shall also indicate the location per the stationing of the construction baseline. The information provided by the HDD Contractor shall be depicted on the Record Drawing and identified as having been provided by the HDD Contractor.
- H. Abandoned infrastructure shall also be depicted as record information and noted as "abandoned".
- I. See Section 1.14.27 for additional record drawing requirements for the auxiliary backup pump set, as applicable.

1.15.7 RECORD INFORMATION OUTSIDE OF RIGHT-OF-WAY OR UTILITY EASEMENTS

- A. Water distribution utility systems, reclaimed water (or irrigation) utility systems, and sanitary sewer collection utility systems shall be located and the locations shall be depicted and noted on the record drawings with the following information:
 - 1. utility pipes shall have all bends and fittings labeled with size and type.
 - 2. utility pipes shall have labels showing length, size, and type
 - 3. lift stations along with quadrant points of round tops / corners of rectangular tops (top of slab for elevations) shall be shown at approximate locations on plans,
 - 4. approximate depths shall be shown for all pipes and cleanouts, valves, and lift station,
 - 5. approximate location of fire hydrants, (center of 5-inch Storz connection nozzle for elevation).
- B. On record drawings, the actual positions of the pipelines or structures shall be measured, and they shall be depicted in their actual installed positions on the record drawings in all plan and profile views.
- C. Record information shall include:
 - 1. A thorough description of the pipes and all appurtenances that have been installed, including type of material or casing, size, class, diameter ratio, and other basic information, i.e., 45° Bend DI, or 6" PVC (DR18), etc.).
 - 2. The recalculated slopes of gravity sewer mains, based on the record survey of manhole inverts and lengths of pipes. Rounding up shall not be allowed.
- D. Lift station control and equipment elevations that were shown on the original construction drawing lift station detail sheet shall be measured and the record survey elevations shall be shown on the record drawing revision of the detail sheet. Record pump information, including pump make, model, year of manufacture, serial number, impeller diameter, voltage, horsepower and speed, shall be shown on the record drawing revision of the lift station detail sheet.
- E. Also included shall be the "Lift Station Start-up Information Sheet" provided by the pump manufacturer shall be included in the record drawings.
- F. Abandoned infrastructure shall also be depicted as record information and noted as "abandoned".

1.15.8 SUBMITTALS

- A. Record drawing submittal materials shall be attached to a transmittal letter, which shall list the following information:
 - 1. Submittal date.
 - 2. Project Title.
 - 3. Planning Department Final Site Plan number (if applicable).
 - 4. Title and sheet number of each record drawing sheet submitted.
- B. The following materials shall be submitted for review:
 - 1. Transmittal letter,
 - 2. Signed and sealed Record Drawing Checklist,
 - 3. Two signed, dated and sealed sets of the record drawings,

4. Final plats and/or easements when applicable,
 5. Final breakdown of construction quantities and final costs when applicable,
 6. Performance bond, defect security bond, warranties and associated cost estimates when applicable,
 7. A copy of the bacteriological test results,
 8. A copy of all the infrastructure inspection reports (i.e. pressure tests, electrically detectable path marking tape tests, tracer wire tests, etc.);
 9. A copy of all horizontal directional drill bore logs;
 10. Up to three copies each of the water and wastewater Completion of Construction forms, fully signed, sealed and dated by the owner and engineer, of which one of each will be retained for the County's records.
- C. Once the submitted documents have been accepted, notification will be given to the engineer to submit the official record drawing package, which shall consist of the following materials:
1. Transmittal letter,
 2. One set original Mylar record drawings,
 3. One paper copy of the record drawings, signed, dated and sealed by the Engineer of Record and the Surveyor,
 4. One electronic copy of the record drawings in CAD (.dwg file) and PDF on a DVD or CD. The DVD or CD file shall have all images, x-refs, and/or data shortcut files linked to the record drawings. Preferably, the record drawing CAD file shall be zipped via the e-Transmit function of AutoCAD, if applicable.
 5. One electronic copy of the complete record drawing points PNEZD comma delineated CSV file on the DVD or CD.
 6. Additional information such as SUE locations and findings, if previously done and readily available.

END OF SECTION

SECTION 1.16 RECORD DRAWINGS – ALL OTHERS**1.16.1 GENERAL**

When construction is complete, record drawings, indicating the locations and elevations of the improvements that have been built, shall be provided to Manatee County Public Works Department. The record drawings shall be a special revision of the approved construction drawings and shall reflect all of the below requirements in content.

1.16.2 REQUIREMENTS AS TO FORM

- A. Every set of record drawings shall have a cover sheet with a vicinity map, which shows where the project is located, and a key map, which shows where each sheet in the record drawing set is located inside the project boundaries.
- B. Each sheet of the record drawings shall have the title "RECORD DRAWING" printed on it in large, bold lettering, near the title block. Each sheet shall also have the words "COUNTY MAINTAINED - WATER", "- SEWER" or "- WATER AND SEWER", or "PRIVATELY MAINTAINED - WATER", "- SEWER", or "- WATER AND SEWER" in large, bold lettering, near the title block, depending on which entity will be responsible for maintaining the utilities. If the project includes a new reclaimed water system, each sheet shall also have the words "COUNTY MAINTAINED - RECLAIMED WATER", or "PRIVATELY MAINTAINED - RECLAIMED WATER", in large, bold lettering, near the title block, depending on which entity will be responsible for maintaining the utilities.

The Cover Sheet shall include a list of all contractors/subcontractors that performed work to complete the project and their specific role(s).

- C. Record information notes shall be positioned individually on the drawings near the depictions of the item to which each note corresponds. Record drawing information submitted in tabular form shall not be accepted.
- D. Record information notes shall be bold, italics, or boxed ([X]) to identify them as record information.
- E. Record drawings shall have a revision note such as "Record Drawing" in the revision block and a date corresponding to the date the record drawing was issued.
- F. Record information shall be presented in a clear and comprehensible form.
- G. The drawing scales used in the record drawings shall be the same as were used in the construction drawings, and the sheet number of each record drawing sheet shall be the same as the sheet numbers that were used on the construction drawings from which the record drawings originate. If additional sheets need to be added shall be numbered with a letter following the preceding sheet number: a sheet added between sheet 4 and 5 would be labeled 4a.
- H. All plan, profile, and detail sheets that were used to depict locations and elevations of utility structures in the construction drawings shall be included in the record drawing set.
- I. Record drawings shall accurately depict all existing improvements within the immediate vicinity of the constructed utilities. Existing improvements shall include, but not be limited to:
 - 1. Sidewalks, walls, fences, road surfaces, buildings, and other utilities,
 - 2. Areas within utility easements and areas within rights of way,

3. Areas within 15 feet of potable water mains, reclaimed water mains, sanitary force mains, and gravity sewer mains,
 4. Areas within 10 feet of potable water meters, reclaimed water meters, backflow prevention assemblies, and fire hydrants.
- J. Private irrigation mains that are located within ten (10') feet of the right-of-way shall also be located on the record drawings.
- K. Rights of way, easements, and property corners shall be shown and shall be of sufficient detail as to determine if the constructed utilities are within the easements or rights of way. A reference to the recording document (O.R. Book or Plat Book and Page) shall be included with any depiction of a right-of-way or easement. O.R. Book or Plat Book and Page are not required to be shown on the record drawings of a project for proposed rights of way or proposed easements that will be identified on the proposed final plat for the said project.
- L. Each roadway depicted on the drawings shall have the correct roadway name noted on it. Provisional roadway names, such as "Street A", shall not be allowed on the record drawings. Each new lot of a new subdivision shall have its street address number noted on the record drawings.
- M. Horizontal locations required for valves, fittings, services, and other utility structures shall be to the center of each installation.
1. Horizontal locations of all features shall be reported to the nearest 0.1 feet.
- N. Vertical elevations of required valves, fittings, services, and other utility structures shall be reported as follows:
1. Top of ground or pavement elevations required along pipelines shall be reported to the nearest 0.1 feet.
 2. Top of pipe elevations shall be to the nearest 0.1 feet.
 3. Elevations of manhole rims and manhole pipe inverts shall be reported to the nearest 0.01 feet.
- O. Computer drawing files submitted shall be AutoCAD 2016 or later release date versions. All CAD files and referenced CAD files, fonts, plot styles, etc. used to create the signed and sealed record drawings shall be provided and are required to be included in the submitted digital files. Computer drawing files' format submitted shall be compatible with the County's current version of AutoCAD, shall be in a .DWG format only, and shall be Windows 10 compatible. (*Tip: Use the e-transmit function of the AutoCad program.*)

1.16.3 MONUMENTATION

- A. Record information shall be referenced by station and offset to a monumented baseline.
- B. The monumentation for the baseline shall be shown or described on the record drawing (i.e. iron rod & cap, nail & disk or other durable and identifiable monument).
- C. For each baseline, there shall be at least two monuments described and referenced. State Plane Coordinates for the monuments shall be shown in NAD 83 (99 adjustment) in feet. Developments not within existing or proposed subdivisions and not within 1.5 miles from existing Manatee County Primary Control Points or platted State Plane Coordinates may be exempted from the requirement for monuments to be based on State Plane Coordinates.
- D. The alignment of the baseline shall be along the centerline or edge of one of the following: an existing paved road, recorded right-of-way, recorded easement, face of an existing building, existing sidewalk or

other existing, identifiable reference line. Offsets from the baseline shall not exceed 150 feet. All elevations shown on record drawings shall be referenced to a minimum of two described benchmarks. A minimum of two on-site benchmarks shall be described including datum. All benchmarks shall be based upon NAVD88. All record drawings shall be in NAVD88.

- E. All locations and elevations shall be field located by or under the direct supervision of a Florida Licensed Surveyor and Mapper.

1.16.4 CERTIFICATIONS

- A. Record Drawings shall be certified by a Florida Licensed Surveyor and Mapper. The certification shall state that the Record Locations and Elevations depicted on the Record Drawing are true and correct and were collected in the field by the Surveyor and Mapper or by a representative under the direct supervision of the Surveyor and Mapper.
- B. Record Drawings shall be certified by the Engineer-of-Record. The certification must state that the improvements have been constructed in substantial conformance with the approved plans.
- C. All visible record features, including sewer inverts, must be measured and located by the Surveyor or by personnel under his or her direct supervision. The certifying Surveyor shall be fully responsible for the accuracy of the record locations and elevations shown on the record drawings. However, the Surveyor may include statements on the record drawings indicating the following:
 - 1. With the exception of the beginning, ending and the surface locations of the Horizontal Directional Drilling (HDD) log readings, the Horizontal Directional Drilling (HDD) locations and elevations provided by the HDD Contractor have not been field verified.
 - 2. Station and offset of pipe fittings are based on PVC pipe markers or 2" x 4" markers inserted by the Contractor on the top of pipe fittings.
 - 3. Station, offset, and elevation of potable water mains, reclaimed water mains, and sanitary force mains are based on PVC pipe markers or 2" x 4" markers inserted by the Contractor on the top of pipe.

1.16.5 RECORD INFORMATION

- A. Water distribution utility systems, reclaimed water (or irrigation) utility systems, and sanitary sewer collection utility systems shall be located and the locations shall be depicted and noted on the record drawings by Northing and Easting (NAD83 Florida State Planes, West Zone, US Foot), and by Station and Offset from an established baseline, with Elevations relative to established benchmarks. For "single point" installations, swing ties rather than station and offset may be allowed.
 - 1. Elements of the utility systems that shall be located and noted by Northing and Easting and Station and Offset:
 - a. water services (center of meter or meter box),
 - b. reclaimed water (or irrigation) services (center of meter or meter box),
 - c. backflow prevention assembly (directly beneath the assembly),
 - d. other miscellaneous utility structures with features at or above the surface of the ground.
 - 2. Elements of the utility systems that shall be located and noted by Northing and Easting, Station, Offset and Elevation:

- a. center of valve cover lids,
 - b. top of nut elevation,
 - c. center of sanitary sewer manhole covers (top of rim for elevations),
 - d. center of lift stations along with quadrant points of round tops / corners of rectangular tops (top of slab for elevations),
 - e. center of above-ground valve assembly slab, along with corners of slab (top of slab for elevation),
 - f. bottom center elevation of the lowest control panel cabinet,
 - g. top of pipe on potable water mains, reclaimed water mains and sanitary force mains at intervals no greater than 200 feet apart for open cut, no greater than 25 feet apart for HDD, the beginning and ending of all jack-and-bores, and at locations where there is a substantial grade change,
 - h. all fittings, including water and reclaimed water service saddles (other than sanitary sewer service wyes),
 - i. center of sanitary sewer service clean-out cover (invert of 45° wye that is located directly below the clean-out cover for elevation),
 - j. center of fire hydrants, (center of 5-inch Storz connection nozzle for elevation).
3. At locations where a top-of-pipe elevation is required for pipeline, a top-of-ground or top-of-pavement elevation shall also be measured and noted on the drawings.
 4. Elements of the utility systems that shall be located and noted by elevation only: sanitary sewer manhole inverts of individual sewer pipes where they enter and exit the manhole.
- B. On record drawings, the actual positions of the pipelines or structures shall be measured, and they shall be depicted in their actual installed positions on the record drawings in all plan and profile views.
- C. Record information shall include:
1. A thorough description of the pipes and all appurtenances that have been installed, including type of material or casing, size, class, diameter ratio, and other basic information, i.e., 45° Bend DI, or 6" PVC (DR18), etc.).
 2. The recalculated slopes of gravity sewer mains, based on the record survey of manhole inverts and lengths of pipes. Rounding up shall not be allowed.
 3. A bold notation shall be placed on each sheet, near the title block, indicating the status of the electrically detectable path marking tape and/or tracer wire installations. "Electrically detectable path marking tape and tracer wire were installed and successfully tested"; and/or "No electrically detectable path marking tape was required"; and/or "No tracer wire was required." The notation shall also include the date of the successful test"
- D. For new valves, the manufacture type (as in gate, plug, etc.), size (pipe nominal diameter) and make (manufacturer) of each valve shall be noted on the record drawings.
- E. Lift station control and equipment elevations that were shown on the original construction drawing lift station detail sheet shall be measured and the record survey elevations shall be shown on the record drawing revision of the detail sheet. Record pump information, including pump make, model, year of

manufacture, serial number, impeller diameter, voltage, horsepower and speed, shall be shown on the record drawing revision of the lift station detail sheet.

- F. Also included shall be the "Lift Station Start-up Information Sheet" provided by the pump manufacturer shall be included in the record drawings.
- G. Horizontal Directional Drilling (HDD) and Jack-and-Bore locations and elevations shall be shown on the Record Drawing. The Surveyor shall locate the beginning, ending and the surface tracking locations of the driller's log readings, and these locations shall be indicated on the record drawings. The HDD Contractor shall provide a certified report and bore log indicating the horizontal and vertical location at least every 25 lineal feet along the pipe. The horizontal locations on the bore log shall also indicate the location per the stationing of the construction baseline. The information provided by the HDD Contractor shall be depicted on the Record Drawing and identified as having been provided by the HDD Contractor.
- H. Abandoned infrastructure shall also be depicted as record information and noted as "abandoned".
- I. See Section 1.14.27 for additional record drawing requirements for the auxiliary backup pump set, as applicable.

1.16.6 SUBMITTALS

- A. Record drawing submittal materials shall be attached to a transmittal letter, which shall list the following information:
 - 1. Submittal date.
 - 2. Project Title.
 - 3. Planning Department Final Site Plan number (if applicable).
 - 4. Title and sheet number of each record drawing sheet submitted.
- B. The following materials shall be submitted for review:
 - 1. Transmittal letter,
 - 2. Signed and sealed Record Drawing Checklist,
 - 3. Two signed, dated and sealed sets of the record drawings,
 - 4. Final plats and/or easements when applicable,
 - 5. Final breakdown of construction quantities and final costs when applicable,
 - 6. Performance bond, defect security bond, warranties and associated cost estimates when applicable,
 - 7. A copy of the bacteriological test results,
 - 8. A copy of all the infrastructure inspection reports (i.e. pressure tests, electrically detectable path marking tape tests, tracer wire tests, etc.);
 - 9. A copy of all horizontal directional drill bore logs;
 - 10. Up to three copies each of the water and wastewater Completion of Construction forms, fully signed, sealed and dated by the owner and engineer, of which one of each will be retained for the County's records.

- C. Once the submitted documents have been accepted, notification will be given to the engineer to submit the official record drawing package, which shall consist of the following materials:
1. Transmittal letter,
 2. One set original Mylar record drawings,
 3. One paper copy of the record drawings, signed, dated and sealed by the Engineer of Record and the Surveyor,
 4. One electronic copy of the record drawings in CAD (.dwg file) and PDF on a DVD or CD. The DVD or CD file shall have all images, x-refs, and/or data shortcut files linked to the record drawings. Preferably, the record drawing CAD file shall be zipped via the e-Transmit function of AutoCAD, if applicable.
 5. One electronic copy of the complete record drawing points PNEZD comma delineated CSV file on the DVD or CD.
 6. Additional information such as SUE locations and findings, if previously done and readily available.

END OF SECTION

SECTION 1.17 APPENDIX

MANATEE COUNTY UTILITY REQUIRED SEPARATIONS	WATER (POTABLE) (water mains shall cross above all conflicts)	SANITARY SEWER (GRAVITY)	FORCE MAIN (SANITARY)	RECLAIMED (pipelines regulated under Part III of Chpt 62-610, F.A.C.)	STORM
WATER (POTABLE) (water mains shall cross above all conflicts)	—	std. horizontal: 6-ft (preferably 10-ft) - std. vertical: 6-in above (preferably 12-in); or 12-in below	std. horizontal: 6-ft (preferably 10-ft) - std. vertical: 12-in	std. horizontal: 3-ft** - std. vertical: 12-in	std. horizontal: 3-ft & gaskets shall be NBR or FKM *5-ft min from roadside underdrains - std. vertical: 6-in above (preferably 12-in); or 12-in below gaskets shall be NBR or FKM
SANITARY SEWER (GRAVITY)	std. horizontal: 6-ft (preferably 10-ft) - std. vertical: 6-in above (preferably 12-in); or 12-in below	—	std. horizontal: 3-ft - std. vertical: 12-in	std. horizontal: 3-ft - std. vertical: 12-in (reclaimed preferably above)	std. horizontal: 6-ft (preferably 10-ft) *5-ft min from roadside underdrains - std. vertical: 12-in
FORCE MAIN (SANITARY)	std. horizontal: 6-ft (preferably 10-ft) - std. vertical: 12-in	std. horizontal: 3-ft - std. vertical: 12-in	—	std. horizontal: 3-ft - std. vertical: 12-in (reclaimed preferably above)	std. horizontal: 3-ft *5-ft min from roadside underdrains - std. vertical: 12-in
RECLAIMED (pipelines regulated under Part III of Chpt 62-610, F.A.C.)	std. horizontal: 3-ft** - std. vertical: 12-in	std. horizontal: 3-ft - std. vertical: 12-in (reclaimed preferably above)	std. horizontal: 3-ft - std. vertical: 12-in (reclaimed preferably above)	—	std. horizontal: 3-ft *5-ft min from roadside underdrains - std. vertical: 12-in (reclaimed preferred above)
STORM	std. horizontal: 3-ft & gaskets shall be NBR or FKM *5-ft min from roadside underdrains - std. vertical: 6-in above (preferably 12-in); or 12-in below gaskets shall be NBR or FKM	std. horizontal: 6-ft (preferably 10-ft) *5-ft min from roadside underdrains - std. vertical: 12-in	std. horizontal: 3-ft *5-ft min from roadside underdrains - std. vertical: 12-in	std. horizontal: 3-ft *5-ft min from roadside underdrains - std. vertical: 12-in (reclaimed preferred above)	—

1. All dimensions are from outside edge of pipe to outside edge of pipe
2. All new construction shall adhere to the standard horizontal and vertical required separations; non-standard separations may be considered when avoiding existing utilities.
3. All mains shall be a minimum of 3 feet from sewer and storm structures. A minimum of one (1) full standard length of pipe shall be centered on the structure. Conflict box may be considered for water main passing through storm structures only with prior written approval from the County & FDEP. Refer to 62-555 for exception, in regards to storm sewer manholes or inlet structures.
4. One (1) standard full length of pipe shall be centered above or below the other pipeline so the pipe joints will be as far as possible from the other pipeline. Alternatively, at such crossings, the pipes shall be arranged so that all water main joints are at least 3 ft from all joints in a vacuum-type sanitary sewers, storm sewers, stormwater force mains, or pipelines conveying reclaimed water regulated under Part III or Chapter 62-610, and at least 6 ft from all joints in gravity- or pressure-type sanitary sewers, wastewater force mains, or pipelines conveying reclaimed water not regulated under Part III of Ch 62-610 FAC.

*Horizontal distance of at least six feet, and preferably ten feet, between the outside of the water main and the outside of any existing or proposed pipeline conveying reclaimed water **not** regulated under Part III of Chapter 62-610, F.A.C.

INTENTIONALLY LEFT BLANK

MANATEE COUNTY UTILITY REQUIRED SEPARATIONS	WATER (POTABLE) (water mains shall cross above all conflicts)	SANITARY SEWER (GRAVITY)	FORCE MAIN (SANITARY)	RECLAIMED (pipelines regulated under Part III of Chpt 62-610, F.A.C.)	STORM
WATER (POTABLE) (water mains shall cross above all conflicts)		min. horz. separation: <6- ft (3-ft min) - min. vert. separation: <12-in (6-in min)-water is DI	min. horz. separation: <6-ft (3-ft min) - min. vert. separation: 6-in (FM is below)	min. horz. separation: <3-ft - min. vert. separation: <12-in (6-in min); reclaimed is below	horz. separation: <3-ft min.; gaskets shall be NBR or FKM *5-ft min from roadside underdrains - min. vert. separation: <12-in (6-in min)-water is DI & gaskets shall be NBR or FKM
SANITARY SEWER (GRAVITY)	min. horz. separation: <6- ft (3-ft min) - min. vert. separation: <12-in (6-in min)-water is DI		min. vert.: 6-in (12-in preferred)	min. horz. separation: <3-ft - min. vert. separation: <12" (6" min) (reclaimed preferably above)	min. horz. separation: <6-ft (3-ft min*)-sewer in watertight casing pipe *5-ft min from roadside underdrains
FORCE MAIN (SANITARY)	min. horz. separation: <6-ft (3-ft min) - min. vert. separation: 6-in (FM is below)	min. vert.: 6-in (12-in preferred)		min. horz. separation: <3-ft - min. vert. separation: <12-in (6-in min); force is below	min. vert. separation: <12-in (force is above)
RECLAIMED (pipelines regulated under Part III of Chpt 62-610, F.A.C.)	min. horz. separation: <3-ft - min. vert. separation: <12-in (6-in min); reclaimed is below	min. horz. separation: <3-ft - min. vert. separation: <12" (6" min) (reclaimed preferably above)	min. horz. separation: <3-ft - min. vert. separation: <12-in (6-in min); force is below		min. horz. separation: <3-ft min *5-ft min from roadside underdrains - min. vert. separation: <12-in (6-in min)-reclaimed is DI (reclaimed preferred above)
STORM	horz. separation: <3-ft min.; gaskets shall be NBR or FKM *5-ft min from roadside underdrains - min. vert. separation: <12-in (6-in min)-water is DI & gaskets shall be NBR or FKM	min. horz. separation: <6-ft (3-ft min*)-sewer in watertight casing pipe *5-ft min from roadside underdrains	min. vert. separation: <12-in (force is above)	min. horz. separation: <3-ft min *5-ft min from roadside underdrains - min. vert. separation: <12-in (6-in min)-reclaimed is DI (reclaimed preferred above)	

- All dimensions are from outside edge of pipe to outside edge of pipe
- All new construction shall adhere to the standard horizontal and vertical required separations; non-standard separations may be considered when avoiding existing utilities.
- All mains shall be a minimum of 3 feet from sewer and storm structures. A minimum of one (1) full standard length of pipe shall be centered on the structure. Conflict box may be considered for water main passing through storm structures only with prior written approval from the County & FDEP. Refer to 62-555 for exception, in regards to storm sewer manholes or inlet structures.
- One (1) standard full length of pipe shall be centered above or below the other pipeline so the pipe joints will be as far as possible from the other pipeline. Alternatively, at such crossings, the pipes shall be arranged so that all water main joints are at least 3 ft from all joints in a vacuum-type sanitary sewers, storm sewers, stormwater force mains, or pipelines conveying reclaimed water regulated under Part III or Chapter 62-610, and at least 6 ft from all joints in gravity- or pressure-type sanitary sewers, wastewater force mains, or pipelines conveying reclaimed water not regulated under Part III of Ch 62-610 FAC.
- Where an underground water main is being laid less than the required minimum horizontal distance from another pipeline and where an underground water main is crossing another pipeline and joints in the water main are being located less than the required minimum distance from joints in the other pipeline:
 - Use of pressure-rated pipe conforming to the American Water Works Association standards incorporated into Rule 62-555.330, F.A.C., for the other pipeline if it is a gravity- or vacuum-type pipeline,
 - Use of welded, fused, or otherwise restrained joints for either the water main or the other pipeline, or
 - Use of watertight casing pipe or concrete encasement at least four inches thick for either the water main or the other pipeline.

INTENTIONALLY LEFT BLANK

Table B-9. Velocities Required^a to Scour Air Pockets from Pipelines. Values computed by Wheeler [4] using Equation B-1 developed by Wisner, Mohsen, and Kouwen [5].

Pipe diameter, mm	Velocities, m/s					Velocities, ft/s					Pipe diameter, in.
	Slope					Slope					
	0%	5%	25%	45°	90°	0%	5%	25%	45°	90°	
25	0.4	0.4	0.5	0.5	0.5	1.4	1.4	1.6	1.7	1.8	1
50	0.6	0.6	0.7	0.7	0.8	1.9	2.0	2.2	2.4	2.5	2
75	0.7	0.8	0.8	0.9	0.9	2.3	2.5	2.7	2.9	3.1	3
100	0.8	0.9	0.9	1.0	1.1	2.7	2.9	3.1	3.4	3.5	4
150	1.0	1.1	1.2	1.3	1.3	3.3	3.5	3.8	4.2	4.3	6
200	1.2	1.2	1.3	1.5	1.5	3.8	4.1	4.4	4.8	5.0	8
250	1.3	1.4	1.5	1.6	1.7	4.3	4.6	4.9	5.4	5.6	10
300	1.4	1.5	1.6	1.8	1.9	4.7	5.0	5.4	5.9	6.1	12
350	1.6	1.6	1.8	1.9	2.0	5.1	5.4	5.8	6.3	6.6	14
375	1.6	1.7	1.8	2.0	2.1	5.2	5.6	6.0	6.6	6.8	15
400	1.6	1.8	1.9	2.1	2.1	5.4	5.8	6.2	6.8	7.0	16
450	1.7	1.9	2.0	2.2	2.3	5.7	6.1	6.6	7.2	7.5	18
500	1.8	2.0	2.1	2.3	2.4	6.0	6.5	6.9	7.6	7.9	20
525	1.9	2.0	2.2	2.4	2.5	6.2	6.6	7.1	7.8	8.1	21
600	2.0	2.2	2.3	2.5	2.6	6.6	7.1	7.6	8.3	8.6	24
675	2.1	2.3	2.5	2.7	2.8	7.0	7.5	8.1	8.8	9.2	27
750	2.3	2.4	2.6	2.8	2.9	7.4	7.9	8.5	9.3	9.6	30
825	2.4	2.5	2.7	3.0	3.1	7.8	8.3	8.9	9.7	10.1	33
900	2.5	2.7	2.8	3.1	3.2	8.1	8.7	9.3	10.2	10.6	36
1050	2.7	2.9	3.1	3.4	3.5	8.8	9.4	10.1	11.0	11.4	42
1200	2.9	3.0	3.3	3.6	3.7	9.4	10.0	10.8	11.8	12.2	48
1500	3.2	3.4	3.7	4.0	4.1	10.5	11.2	12.0	13.1	13.6	60
1800	3.5	3.7	4.0	4.4	4.5	11.5	12.2	13.2	14.4	14.9	72

^aSee first page of Appendix B.

Practical considerations:

- Air problems do not occur where the pipe gradient is positive in the direction of flow [5].
- Avoid excessive headloss by using smaller diameter pipe (to obtain higher velocities) only where gradient is flat or slopes downward.
- For air scouring to be effective, the tabular velocities must occur frequently (e.g., daily or more often).
- Air release valves in small pipes may be of little or no value.
- Blowback from clearing air in large pipes may cause surges that cannot be estimated. See Wisner, Mohsen, and Kouwen [5].

Before designing piping systems for air scouring, it is advisable to read “Air binding in pipes” by Edmunds [6], the chapter on closed conduit flow in Falvey [14], and, for wastewater, “Hydraulics of corrosive gas pockets in force mains” by Walski *et al.* [13].

INTENTIONALLY LEFT BLANK



MANATEE COUNTY PUBLIC WORKS UTILITY STANDARDS

FEBRUARY 2020

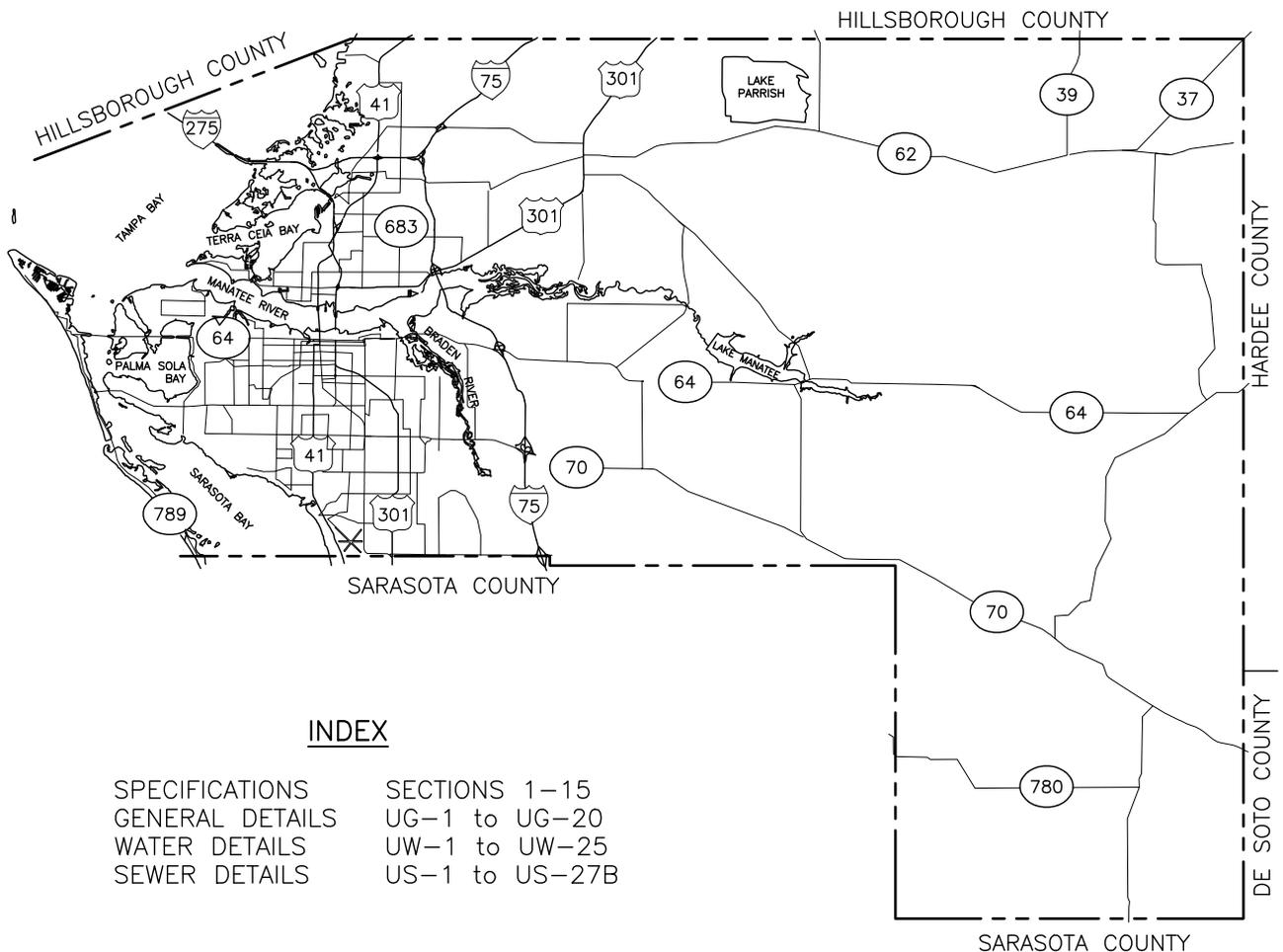

INDEX

SPECIFICATIONS	SECTIONS 1-15
GENERAL DETAILS	UG-1 to UG-20
WATER DETAILS	UW-1 to UW-25
SEWER DETAILS	US-1 to US-27B

INTENTIONALLY
LEFT
BLANK

TABLE OF CONTENTS

UTILITY STANDARDS—GENERAL CONSTRUCTION

UG-1 TABLE OF CONTENTS—GENERAL UTILITY CONSTRUCTION

UG-2 TYPICAL WATER/SEWER CROSSING

UG-3 CASING CROSSING

UG-4 DIRECTIONAL BORE ROADWAY CROSSING

UG-5 DIRECTIONAL BORE SUBAQUEOUS CROSSING

UG-6 HDPE TO PVC OR DI PIPE ADAPTER

UG-7 CONCRETE THRUST BLOCKS

UG-8 RESTRAINED LENGTHS FOR PVC PIPE

UG-9 RESTRAINED LENGTHS FOR DIP

UG-10 RESTRAINED LENGTHS FOR PIPE

UG-11 TRENCH WITH UNIMPROVED SURFACE TYPE A-1 PIPE BEDDING

UG-12 TRENCH WITH ASPHALT PAVEMENT SURFACE TYPE A-1 PIPE BEDDING
(CROSSING)

UG-12B TRENCH WITH ASPHALT PAVEMENT SURFACE TYPE A-1 PIPE BEDDING
(LONGITUDINAL)

UG-13 TRENCH WITH CONCRETE PAVEMENT SURFACE TYPE A-1 PIPE BEDDING

UG-14 TRENCH WITH CONCRETE DRIVEWAY SURFACE TYPE A-1 PIPE BEDDING

UG-15 TRENCH WITH TYPE A-2 PIPE BEDDING

UG-16 TRENCH WITH TYPE A-3 PIPE BEDDING

UG-17 UTILITY LAYOUT FOR 50' R/W

UG-18 PRESSURE PIPE DEFLECTION AT UTILITY CROSSING

UG-19 SMALL TREE OR PALM TREE WITH ROOT BARRIER

UG-20 CANOPY TREE, LARGE PALM, OR EXOTIC TREE WITH ROOT BARRIER

MANATEE COUNTY		TABLE OF CONTENTS GENERAL UTILITY CONSTRUCTION	UG-1
PUBLIC WORKS DEPARTMENT			
REV. BY	DATE	<u>February 25, 2020</u> DATE OF APPROVAL	

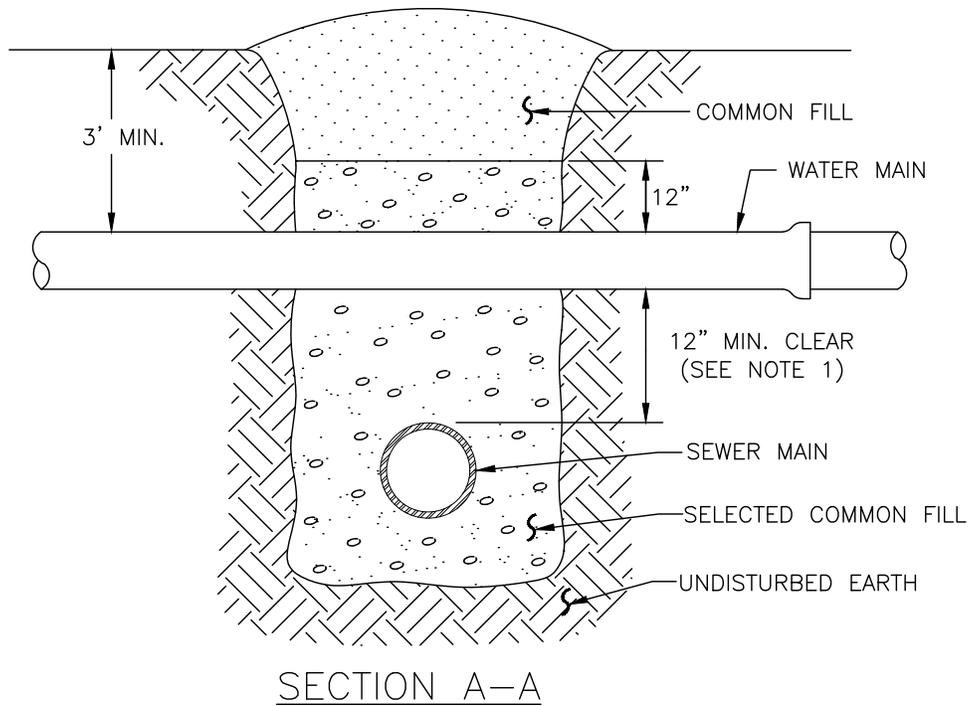
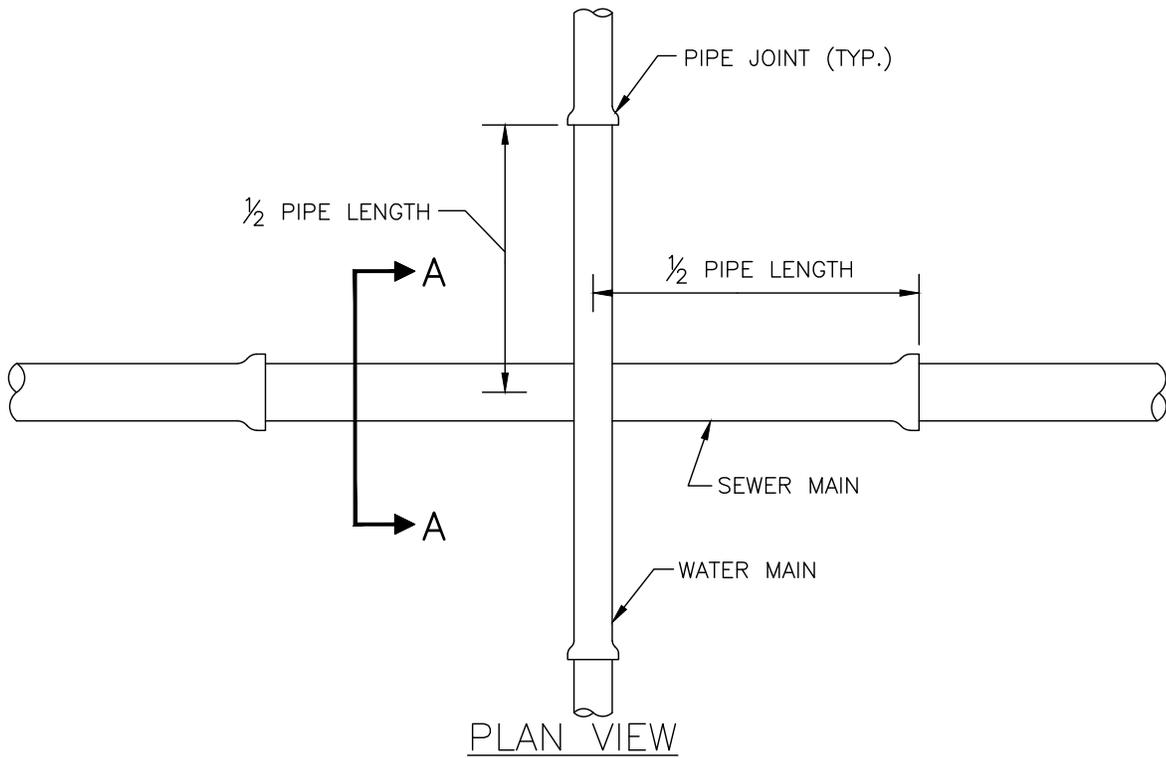

NOTES:

1. CLEARANCE MAY BE REDUCED TO 6" FOR GRAVITY SEWER WHERE WATER MAIN IS DUCTILE IRON.
2. PIPE SECTIONS SHALL BE FULL-LENGTH AND SHALL BE ADJUSTED HORIZONTALLY, SO THAT THE CROSSING IS AT EACH PIPE SECTION'S MIDPOINT REGARDLESS OF THE VERTICAL CLEARANCE.

MANATEE COUNTY
PUBLIC WORKS DEPARTMENT

TYPICAL NEW WATER &
SEWER LINE CROSSING

UG-2

REV. BY	DATE

February 25, 2020
DATE OF APPROVAL

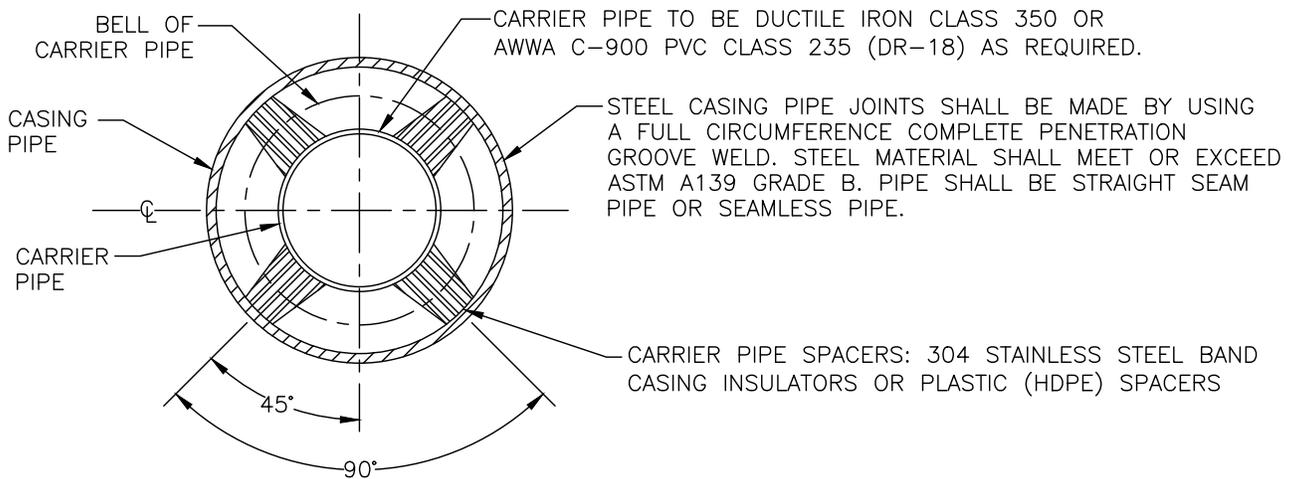
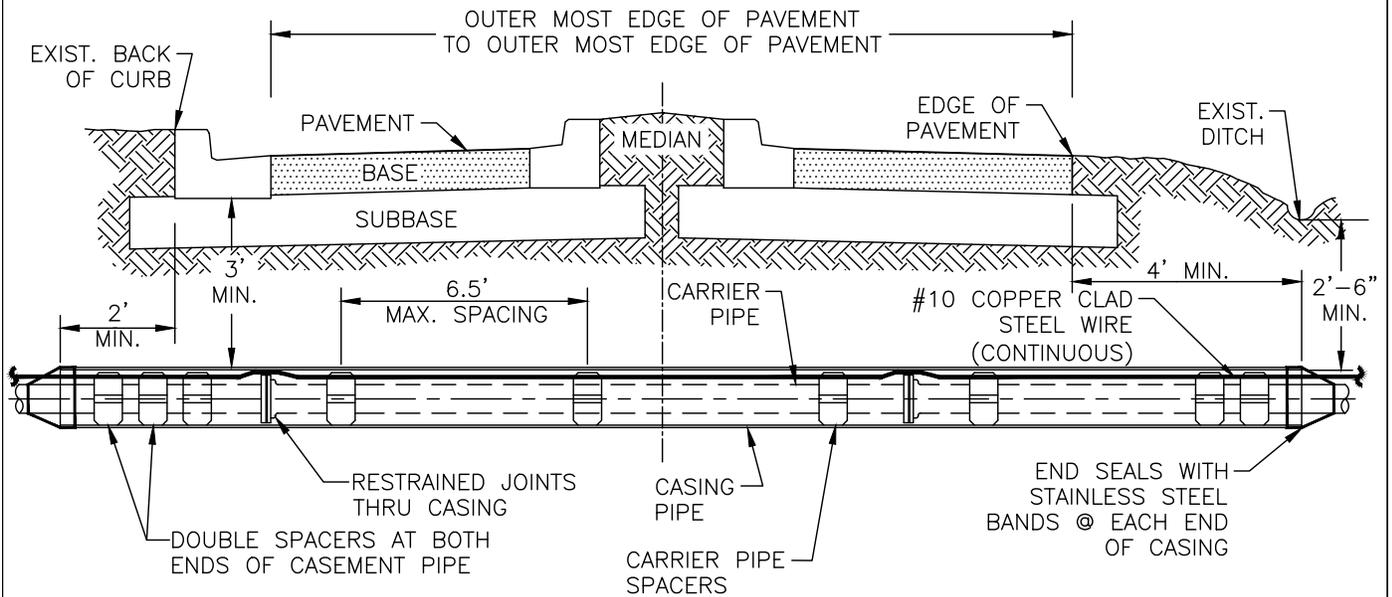

CARRIER SIZE & MINIMUM CASING SIZE									
CARRIER	4"	6"	8"	10"	12"	X	16"	18"	20"
CASING	12"	14"	18"	20"	24"	X	30"	36"	36"
CASING / WALL THICKNESS	0.188	0.188	0.250	0.250	0.344	X	0.406	0.406	0.406

STEEL CASING SIZES

CARRIER SIZE & MINIMUM CASING SIZE									
CARRIER	4"	6"	8"	10"	12"	X	16"	18"	20"
CASING	8"	12"	16"	20"	24"	X	30"	36"	36"

PVC/HDPE CASING SIZES

NOTES:

1. THE ENGINEER OF RECORD MAY SELECT A LARGER CASING DIAMETERS, INCREASE WALL THICKNESS, AND/OR INCREASE DEPTH OF BURY DUE TO EXTERNAL LOADS WITH COUNTY APPROVAL PRIOR TO PERFORMING THE WORK.
2. ALL PIPES CROSSINGS OF FEDERAL OR STATE ROADS; OR RAILROADS SHALL BE INSTALLED IN A CASING PIPE.
3. ALL PIPES CROSSINGS OF COUNTY LOCAL ARTERIAL AND THOROUGHFARE ROADWAYS SHALL BE IN A CASING PIPE.
4. SPLIT-STEEL CASINGS MAY BE USED ON EXISTING COUNTY MAINS ONLY.
5. FOR JACK & BORE SPECIFICATIONS UNDER STATE ROADS AND RAILROADS, REFER TO THE F.D.O.T. UTILITY ACCOMMODATION MANUAL, LATEST EDITION.
6. HDPE CASING SHALL HAVE ALL WELD BEADS REMOVED FROM THE INSIDE SURFACE SUCH THAT THE JOINT SURFACES SHALL BE SMOOTH.
7. *14-INCH DIAMETER MAINS ARE NOT TO BE INSTALLED.

MANATEE COUNTY PUBLIC WORKS DEPARTMENT		CASING CROSSING	UG-3
REV. BY	DATE		
	February 25, 2020		
	DATE OF APPROVAL		

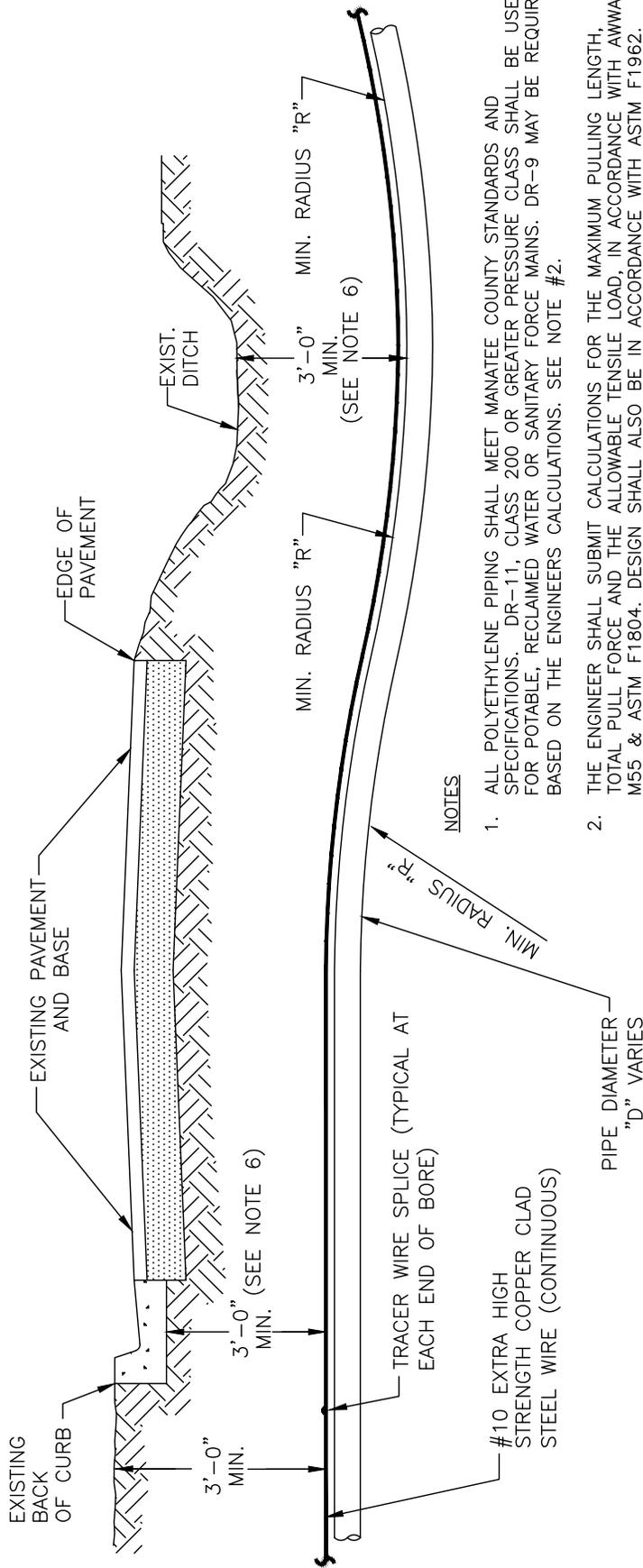

NOTES

1. ALL POLYETHYLENE PIPING SHALL MEET MANATEE COUNTY STANDARDS AND SPECIFICATIONS. DR-11, CLASS 200 OR GREATER PRESSURE CLASS SHALL BE USED FOR POTABLE, RECLAIMED WATER OR SANITARY FORCE MAINS. DR-9 MAY BE REQUIRED BASED ON THE ENGINEERS CALCULATIONS. SEE NOTE #2.
2. THE ENGINEER SHALL SUBMIT CALCULATIONS FOR THE MAXIMUM PULLING LENGTH, TOTAL PULL FORCE AND THE ALLOWABLE TENSILE LOAD, IN ACCORDANCE WITH AWWA M55 & ASTM F1804. DESIGN SHALL ALSO BE IN ACCORDANCE WITH ASTM F1962.
3. A MANDREL BASED ON 80% OF THE INSIDE DIAMETER OF THE PULLED PIPE SHALL BE HAND-PULLED THROUGH THE FINAL INSTALLED PIPE WITH A COUNTY INSPECTOR PRESENT, TO CONFIRM NO ELONGATION(S) (NECKING) HAS OCCURRED.
4. ONE #10 GAUGE EXTRA HIGH STRENGTH COPPER CLAD STEEL TRACER WIRE SHALL BE SECURED TO THE PIPE FOR ALL TYPES OF PIPELINE INSTALLATIONS. TRACER WIRES SHALL HAVE A MINIMUM 45-MILS OF POLYETHYLENE INSULATION.
5. TRACER WIRE TO BE COLOR CODED: BLUE FOR POTABLE WATER MAINS; PURPLE FOR RECLAIMED WATER MAINS; AND GREEN FOR SANITARY FORCE MAINS.
6. PIPE DEPTHS MAY NEED TO BE DEEPER TO AVOID FRACKOUTS. PIPE ALIGNMENT SHALL BE AS SHOWN ON THE CONSTRUCTION DRAWINGS. THE ENGINEER SHALL BE NOTIFIED PRIOR TO ANY DEVIATIONS.
7. PIPES CROSSING FEDERAL OR STATE ROADS; OR RAILROADS SHALL BE INSTALLED IN A CASING PIPE.
8. FOR COUNTY LOCAL ARTERIAL OR THOROUGHFARE ROADWAYS; AND ON A CASE BY CASE BASIS, STEEL, PVC, OR HDPE CASING PIPE MAY BE ALLOWED. HDPE CASING PIPE SHALL BE INSTALLED FIRST, TESTED, AND THEN THE CARRIER PIPE MAY BE PULLED THRU THE CASING PIPE AS A SEPARATE OPERATION.
9. MANATEE COUNTY DIRECTIONAL DRILL CRITERIA SHALL BE MET FOR PIPES UNDER LOCAL ARTERIALS & THOROUGHFARES.
10. FDOT DIRECTIONAL DRILL CRITERIA SHALL BE MET FOR PIPES UNDER STATE, & FEDERAL ROADS.

PIPE DIAMETER "D" IN INCHES	MIN. RADIUS FOR PE PIPE IN FEET	
	MIN. RADIUS "R" FOR DR-11	MIN. RADIUS "R" FOR DR-9
2	4	5.5
3	6	8.3
4	8	11.0
6	12	16.5
8	16	22.0
10	20	27.5
12	24	33.0
16	32	44.0
18	36	49.5
20	40	55.0

MANATEE COUNTY
PUBLIC WORKS DEPARTMENT

REV. BY	DATE

February 25, 2020
DATE OF APPROVAL

DIRECTIONAL BORE
ROADWAY CROSSING

UG-4

DIRECTIONAL BORE
SUBAQUEOUS
CROSSING

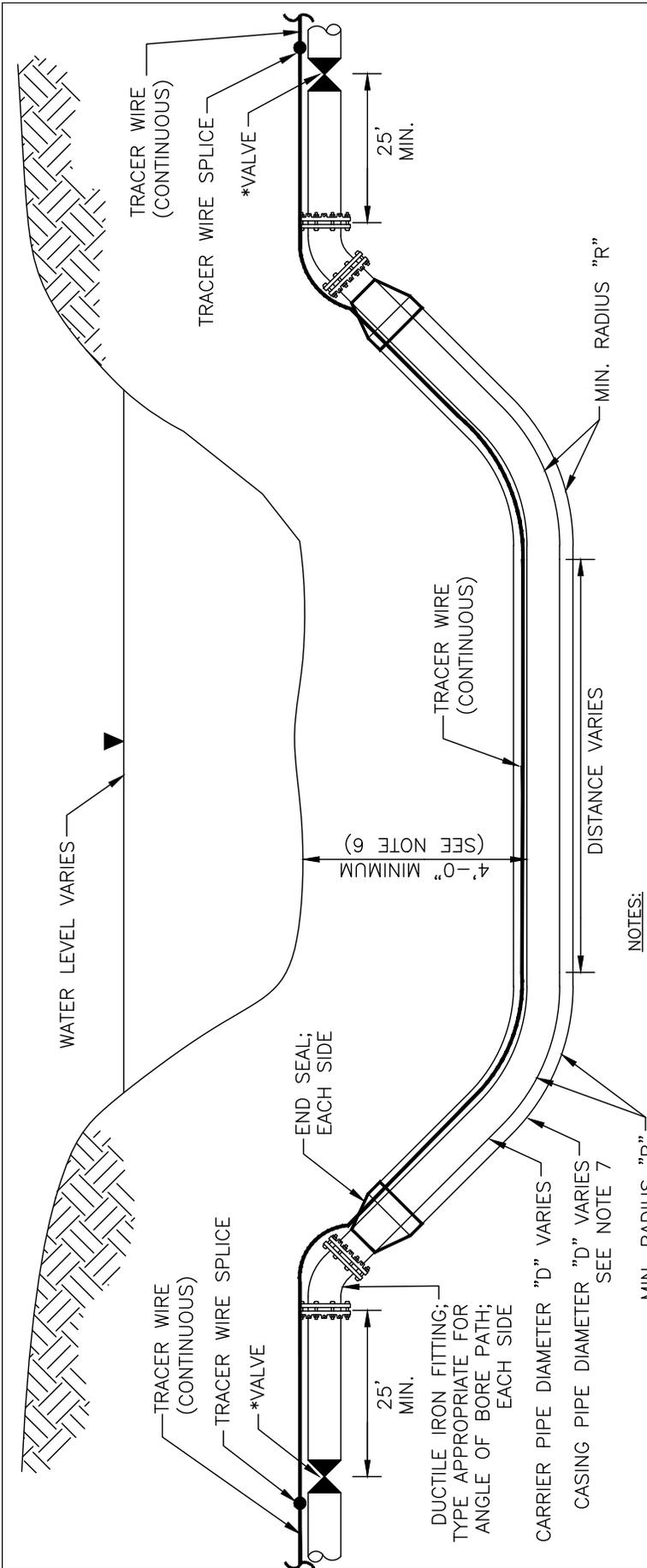

NOTES:

1. ALL POLYETHYLENE PIPING SHALL MEET MANATEE COUNTY STANDARDS AND SPECIFICATIONS. DR-11, CLASS 200 OR GREATER PRESSURE CLASS SHALL BE USED FOR POTABLE, RECLAIMED WATER OR SANITARY FORCE MAINS. DR-9 MAY BE REQUIRED BASED ON THE ENGINEERS CALCULATIONS. SEE NOTE #2.
2. THE ENGINEER SHALL SUBMIT CALCULATIONS FOR THE MAXIMUM PULLING LENGTH, TOTAL PULL FORCE AND THE ALLOWABLE TENSILE LOAD, IN ACCORDANCE WITH AWWA M55 & ASTM F1804. DESIGN SHALL ALSO BE IN ACCORDANCE WITH ASTM F1982.
3. A MANDREL BASED ON 80% OF THE INSIDE DIAMETER OF THE PULLED PIPE SHALL BE HAND-PULLED THROUGH THE FINAL INSTALLED PIPE WITH A COUNTY INSPECTOR PRESENT, TO CONFIRM NO ELONGATION(S) (NECKING) HAS OCCURRED.
4. ONE #10 GAUGE EXTRA HIGH STRENGTH COPPER CLAD STEEL TRACER WIRE SHALL BE SECURED TO THE PIPE FOR ALL TYPES OF PIPELINE INSTALLATIONS. TRACER WIRES SHALL HAVE A MINIMUM 45-MILS OF POLYETHYLENE INSULATION.
5. TRACER WIRE TO BE COLOR CODED: BLUE FOR POTABLE WATER MAINS; PURPLE FOR RECLAIMED WATER MAINS; AND GREEN FOR SANITARY FORCE MAINS.
6. PIPE DEPTHS MAY NEED TO BE DEEPER TO AVOID FRACKOUTS.
7. ALL SUBAQUEOUS; WETLAND; OR CONSERVATION AREA PIPE CROSSINGS SHALL BE INSTALLED IN A CASING PIPE. PVC AND HDPE CASINGS MAY BE ALLOWED PROVIDED THE CASING PIPE IS INSTALLED FIRST AND THEN THE CARRIER PIPE IS PULLED THRU THE CASING PIPE AS A SEPARATE OPERATION. HDPE CASINGS SHALL HAVE THE INTERNAL BEAD REMOVED.
8. REFER TO 1.8.5, IF THE CASING IS INSTALLED USING HORIZONTAL DIRECTIONAL DRILLING METHOD.

***NOTES:**

1. FOR SANITARY FORCE MAIN USE PLUG VALVE.
2. FOR POTABLE AND RECLAIMED WATER USE GATE VALVE.

PIPE DIAMETER "D" IN INCHES	MIN. RADIUS FOR DR-11	MIN. RADIUS FOR PE PIPE IN FEET	MIN. RADIUS "R" FOR DR-9
2	4	5.5	5.5
3	6	8.3	8.3
4	8	11.0	11.0
6	12	16.5	16.5
8	16	22.0	22.0
10	20	27.5	27.5
12	24	33.0	33.0
16	32	44.0	44.0
18	36	49.5	49.5
20	40	55.0	55.0

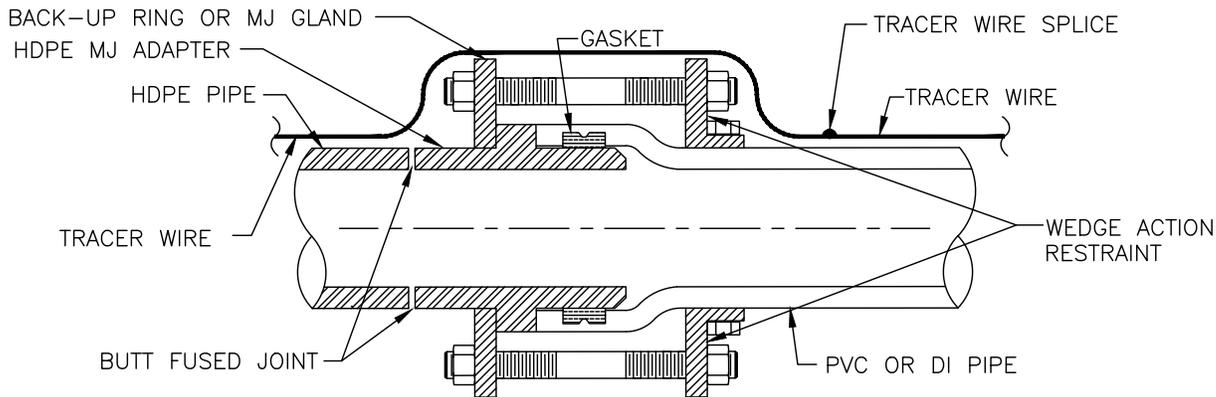

HDPE PIPE TO PVC PIPE / SPIGOT TO BELL CONNECTION

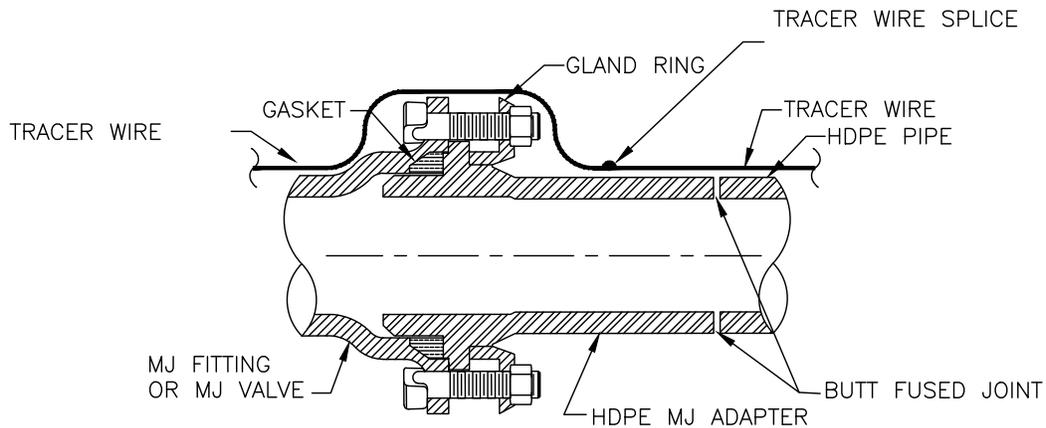

NOTE: SCHEMATIC SHOWN FOR STANDARD MJ FITTINGS AND GATE VALVES.

HDPE PIPE TO MJ FITTING TRANSITION

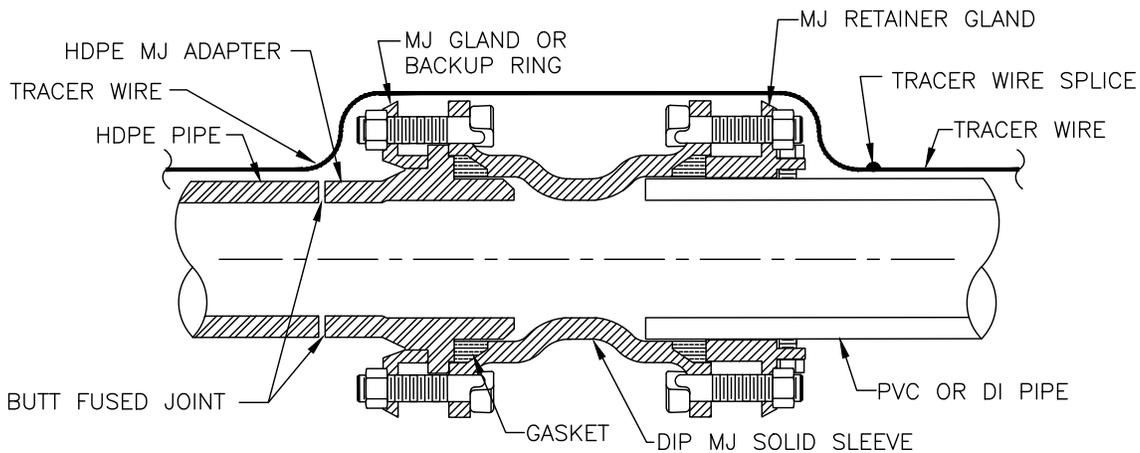

HDPE PIPE TO PVC PIPE SPIGOT TO SPIGOT CONNECTION

1. ONE TRACER WIRE SHALL BE SECURED TO THE PIPE FOR ALL TYPES OF PIPELINE INSTALLATIONS.

MANATEE COUNTY
 PUBLIC WORKS DEPARTMENT

REV. BY DATE

February 25, 2020
 DATE OF APPROVAL

HDPE TO PVC OR
 DI PIPE ADAPTER

UG-6

THRUST BLOCK DIMENSIONS B ft. x d inches

PIPE SIZE (IN.)	90°BEND		45°BEND		22.5°BEND		11.25°BEND		DEAD END & TEE		45° WYE	
	B	d	B	d	B	d	B	d	B	d	B	d
4	1.5	3 1/2	1.1	3 1/2	0.8	3 1/2	0.6	3 1/2	1.3	3 1/2	1.1	3 1/2
6	2.2	5 1/4	1.6	3 3/4	1.2	3 1/2	0.8	3 1/2	1.9	4 1/2	1.6	3 3/4
8	2.9	7	2.1	5	1.5	3 1/2	1.1	3 1/2	2.4	5 3/4	2.0	4 3/4
10	3.5	8 1/2	2.6	6 1/4	1.9	4 1/2	1.3	3 1/2	3.0	7 1/4	2.5	6
12	4.2	10	3.1	7 1/2	2.2	5 1/4	1.6	3 3/4	3.5	8 1/4	3.0	7 1/4
14	4.9	11 3/4	3.6	8 3/4	2.6	6 1/4	1.8	4 1/4	4.1	9 3/4	3.4	8 1/4
16	5.5	13 1/4	4.1	9 3/4	2.9	7	2.1	5	4.7	11 1/4	3.9	9 1/4
18	6.2	15	4.6	11	3.3	8	2.3	5 1/2	5.2	12 1/2	4.4	10 1/2
20	6.9	16 1/2	5.0	12	3.6	8 3/4	2.6	6 1/4	5.8	14	4.9	11 3/4
24	8.2	19 3/4	6.0	14 1/2	4.3	10 1/4	3.1	7 1/2	6.9	16 1/2	5.8	14
30	10.1	24 1/4	7.5	18	5.3	12 3/4	3.8	9	8.5	20 1/2	7.2	17 1/4
36	12.1	29	8.9	21 1/4	6.4	15 1/4	4.5	10 3/4	10.2	24 1/2	8.6	20 3/4

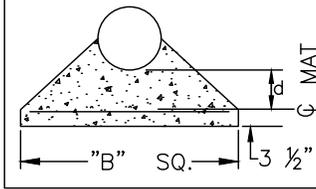

REINFORCEMENT MAT SCHEDULE

FOR DIM. "B" BETWEEN 5.75' & 12.5' USE #4 @ 8" EACH WAY
 FOR DIM. "B" LESS THAN 5.75' USE #3 @ 8" EACH WAY

NOTES:

1. ALL THRUST BLOCKS SHALL BE CAST IN PLACE. FITTINGS ADJACENT TO THRUST BLOCKS SHALL BE WRAPPED IN POLYETHYLENE.
2. THIS TABLE IS BASED ON WATER PRESSURE=180 PSI WITH AN ALLOWABLE SOIL BEARING PRESSURE=2000 PSF, CONCRETE STRENGTH f_c =3000 PSI, REINFORCEMENT f_y =60.0 KSI. THRUST BLOCK SHALL BE CAST AGAINST FIRM UNDISTURBED SOIL.
3. FOR LARGER "B" DIMENSIONS IT IS NECESSARY TO CHECK THAT PIPE IS SUFFICIENTLY DEEP TO ALLOW 15" MIN. SOIL COVER OVER TOP EDGE OF THRUST BLOCK.
4. RESTRAINED JOINTS MAY BE USED IN LIEU OF THRUST BLOCKS TO SAVE SPACE. HOWEVER, WHERE THRUST BLOCKS AND RESTRAINED JOINTS ARE CALLED OUT/ILLUSTRATED IN THE DETAILS, BOTH SHALL BE INSTALLED.

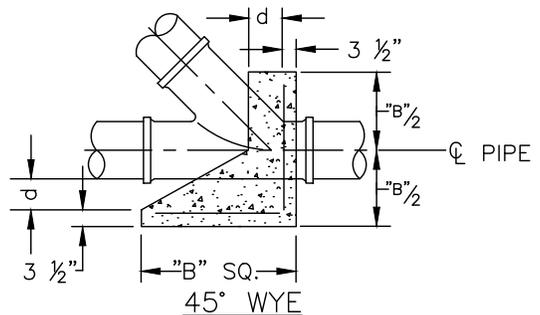
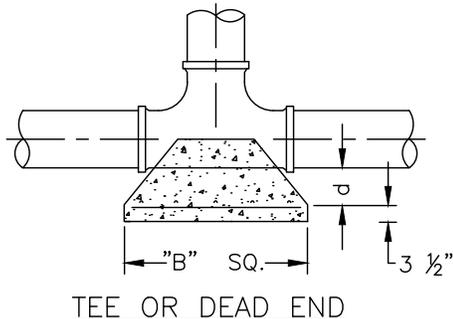
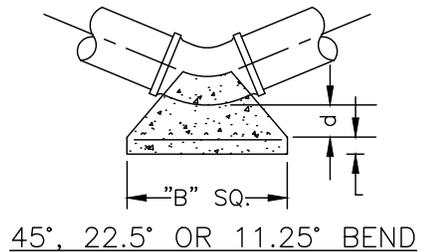
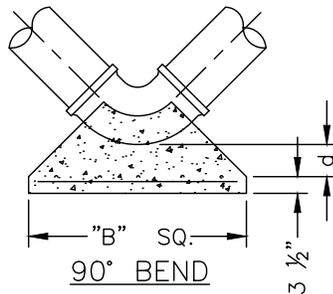

MANATEE COUNTY
PUBLIC WORKS DEPARTMENT

REV. BY	DATE

February 25, 2020
DATE OF APPROVAL

CONCRETE THRUST
BLOCKS

UG-7

REQUIRED LENGTH OF RESTRAINED JOINT PIPE FOR C900-16 PVC PIPE (DR-18)

MAIN PIPE SIZE	HORIZ. BENDS			TEES					REDUCERS			PLUGS & VALVES
	90°	45°	22.5°	SIZE / LENGTH					SIZE / LENGTH			
24	90	38	18	X24 / 169	X20 / 132	X16 / 90	X12 / 38	X10 / 6	X20 / 64	X16 / 117	X12 / 158	214
20	78	32	16	X20 / 141	X16 / 101	X12 / 53	X10 / 24	X8 / 1	X16 / 65	X12 / 115	X10 / 149	184
16	66	27	13	X16 / 111	X12 / 67	X10 / 41	X8 / 12		X12 / 64	X10 / 107	X8 / 111	151
12	52	22	10	X12 / 80	X10 / 56	X8 / 31	X6 / 1		X10 / 58	X8 / 62	X6 / 86	118
10	44	18	9	X10 / 63	X8 / 40	X6 / 7			X8 / 33	X6 / 61	X4 / 81	100
8	37	15	7	X8 / 49	X6 / 18	X4 / 1			X6 / 35	X4 / 60		83
6	29	12	6	X6 / 29	X4 / 1				X4 / 33			63
4	21	8	4	X4 / 12								45

NOTES:

1. RESTRAIN 11.25° BENDS 50% OF LENGTH FOR 22.5° BENDS.
2. ALL VALVES AND FITTINGS SHALL BE RESTRAINED TO THE CONNECTING SECTIONS OF PIPE.
3. ALL ISOLATION VALVES MUST BE PROPERLY ANCHORED OR RESTRAINED TO RESIST A 180 PSI TEST PRESSURE IN EITHER DIRECTION.
4. PIPE SIZES ARE GIVEN IN INCHES.
5. RESTRAINED PIPE LENGTHS ARE GIVEN IN FEET.
6. LENGTHS SHOWN ARE FOR A TEST PRESSURE OF 180 PSI.
7. THE RESTRAINED LENGTHS SHOWN IN THESE TABLES ARE BASED ON SOIL CLASSIFICATION SP WITH AWWA TYPE 3 TRENCH CONDITIONS, 180 PSI TEST PRESSURE, 3 FEET OF COVER AND 1.5 FACTOR OF SAFETY. ACTUAL BURY CONDITIONS MUST BE DETERMINED BY THE ENGINEER OF RECORD AND THE RESTRAINED LENGTHS MODIFIED ACCORDINGLY.
8. RESTRAINED LENGTHS TO BE APPLIED TO PIPELINES PER DETAIL UG-10 RESTRAINED LENGTHS FOR PIPE.
9. ALL RESTRAINED JOINT HARDWARE SHALL CONFORM TO 1.11.17 OF THE PUBLIC WORKS UTILITIES STANDARDS MANUAL.
10. ALL THREE "LEGS" OF TEES SHALL BE RESTRAINED PER THE STATED LENGTH IN THE TABLE.

MANATEE COUNTY
PUBLIC WORKS DEPARTMENT

RESTRAINED
LENGTHS FOR PVC
PIPE

UG-8

February 25, 2020
DATE OF APPROVAL

REV. BY	DATE

REQUIRED LENGTH OF RESTRAINED JOINT PIPE FOR DIP (POLY-WRAPPED)

MAIN PIPE SIZE	HORIZ. BENDS			TEES							REDUCERS				PLUGS & VALVES
	90°	45°	22.5°	SIZE / LENGTH							SIZE / LENGTH				
				X36	X30	X24	X20	X16	X12	X10	X8	X30	X24	X20	
36	142	59	28	393	318	232	165	84	1	137	247	309	359	453	
30	124	51	25	333	252	189	115	23	1	137	213	276		391	
24	106	44	21	270	211	143	61	10	1	98	178	241		327	
20	92	38	18	225	161	85	39	1		98	176	227		280	
16	77	32	15	177	107	65	19	1		98	163	169		231	
12	61	25	12	127	89	50	1			88	96	131		181	
10	52	22	10	101	64	11				51	94	125		153	
8	44	18	9	78	30	1				54	92			128	
6	34	14	7	46	1					50				98	
4	24	10	5	19										69	

NOTE:

- SEE UG-8, RESTRAINED LENGTHS FOR PVC PIPE DETAIL FOR NOTES 1 THROUGH 9 THAT ARE ALSO APPLICABLE TO RESTRAINED LENGTHS FOR DIP.

MANATEE COUNTY PUBLIC WORKS DEPARTMENT		RESTRAINED LENGTHS FOR DIP	UG-9
REV. BY	DATE		
February 25, 2020 DATE OF APPROVAL			

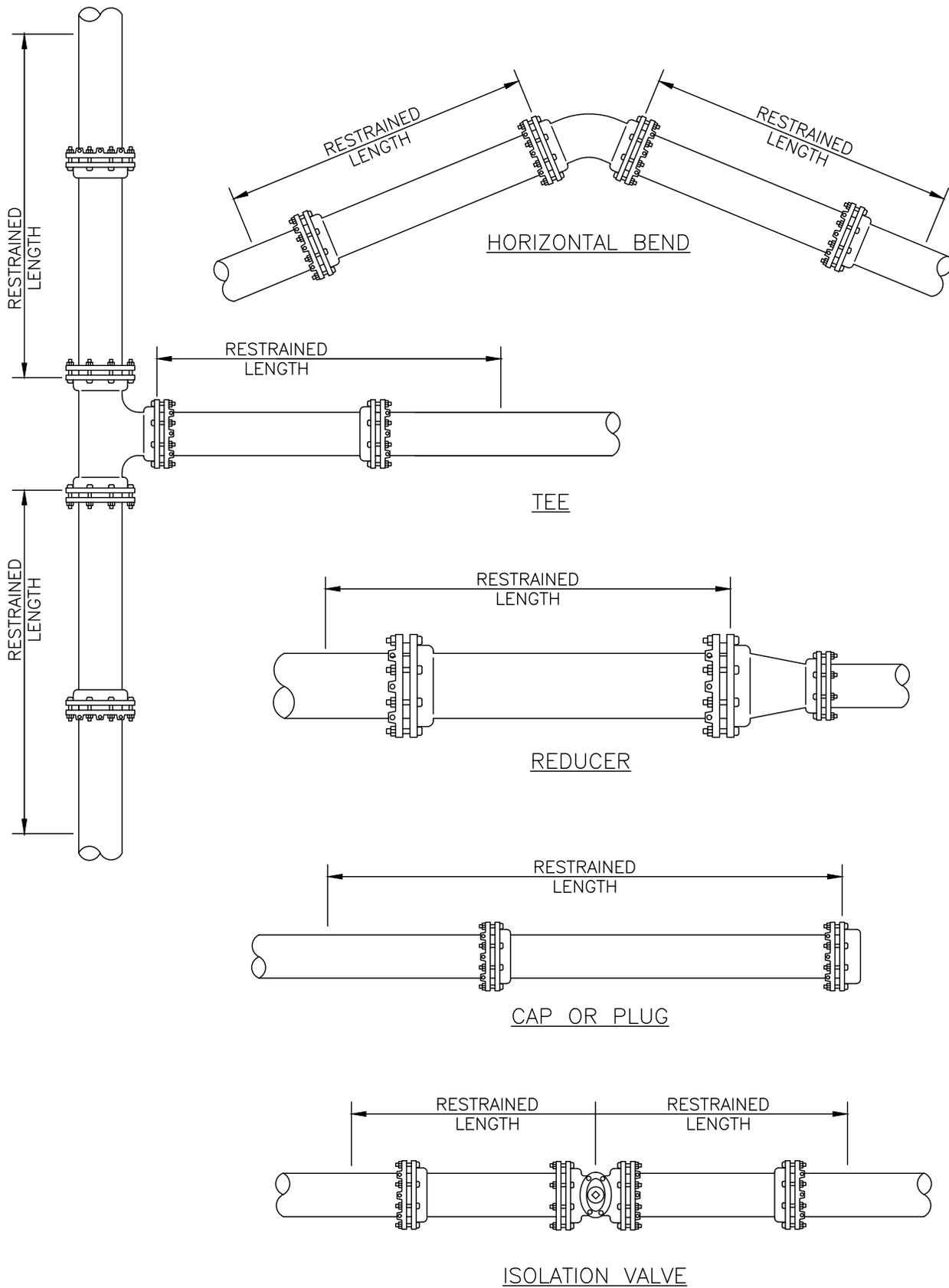

NOTE:

- SEE DETAIL UG-8 RESTRAINED LENGTHS FOR PVC PIPE FOR NOTES 1 THROUGH 9 THAT ARE ALSO APPLICABLE TO RESTRAINED LENGTHS FOR PIPE.

MANATEE COUNTY
PUBLIC WORKS DEPARTMENT

REV. BY DATE

February 25, 2020
DATE OF APPROVAL

RESTRAINED
LENGTHS FOR PIPE

UG-10

NOTES:

1. USE OF TYPE A-2 AND A-3 PIPE BEDDING TO BE DETERMINED IN THE FIELD BY THE ENGINEER.
2. PROVIDE ADEQUATE CLEARANCE TO PLACE AND COMPACT STAGE 1 BEDDING MATERIAL IN TRENCH AREA BELOW PIPE SPRINGLINE. PIPE EMBEDMENT MUST BE COMPACTED OUT TO THE TRENCH WALL OR 2.5 TIMES THE PIPE OD, WHICHEVER IS LESS.
3. PIPE INSTALLATION SHALL BE IN ACCORDANCE WITH THE MANUFACTURER'S WRITTEN INSTRUCTIONS.
4. TRACER WIRE NOT REQUIRED FOR GRAVITY SEWERS.

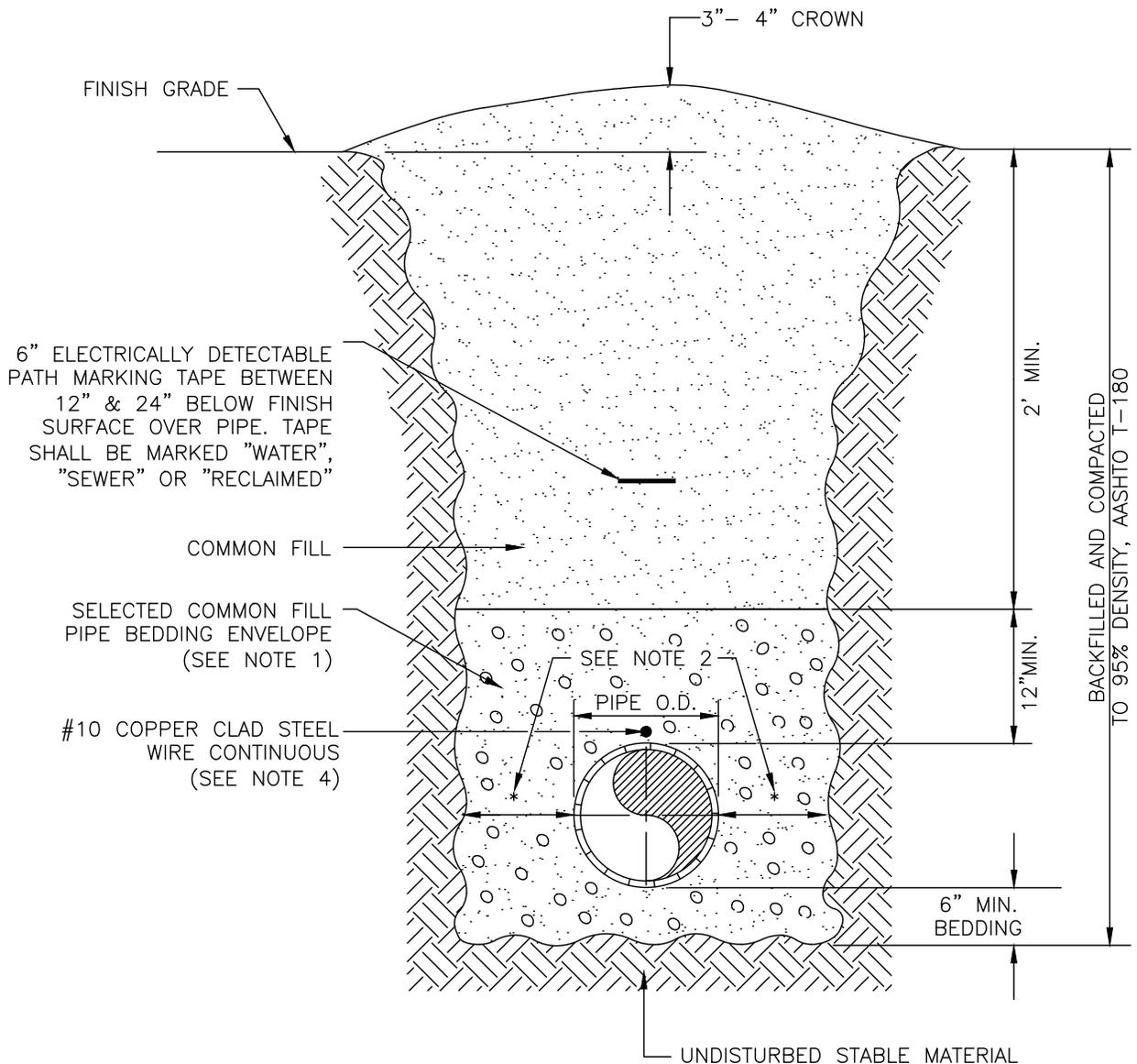

MANATEE COUNTY PUBLIC WORKS DEPARTMENT		TRENCH WITH UNIMPROVED SURFACE TYPE A-1 PIPE BEDDING	UG-11
REV. BY	DATE		
	February 25, 2020		
	DATE OF APPROVAL		

NOTES:

1. BITUMINOUS PAVEMENT SHALL BE REMOVED IN CLEAN STRAIGHT LINES BY SAW CUTTING. WHERE BITUMINOUS PAVEMENT ADJOINS A TRENCH, THE EDGES ADJACENT TO THE TRENCH SHALL BE TRIMMED TO A NEAT STRAIGHT LINES BEFORE RESURFACING TO ENSURE THAT ALL AREAS TO BE RESURFACED ARE ACCESSIBLE TO ROLLERS OR TAMPERS USED TO COMPACT THE SUB-GRADE OR PAVING MATERIALS.
2. USE OF TYPE A-2 AND A-3 PIPE BEDDING TO BE DETERMINED IN THE FIELD BY THE ENGINEER.
3. PROVIDE ADEQUATE CLEARANCE TO PLACE AND COMPACT STAGE 1 BEDDING MATERIAL IN TRENCH AREA BELOW PIPE SPRINGLINE. PIPE EMBEDMENT MUST BE COMPACTED OUT TO THE TRENCH WALL OR 2.5 TIMES THE PIPE OD, WHICHEVER IS LESS.
4. PIPE INSTALLATION SHALL BE IN ACCORDANCE WITH THE MANUFACTURER'S WRITTEN INSTRUCTIONS.
5. ASPHALTIC CONCRETE STRUCTURE COURSE WITH PRIME COAT SHALL BE THE SAME DEPTH AND TYPE AS EXISTING OR A MINIMUM OF 1-1/4 INCH S-I, WHICHEVER IS GREATER.
6. MILL 25' BACK FROM TRENCH CROSSING SAW CUTS. ADJUST MILLING PER INDIVIDUAL SITE TO NOT IMPACT BASE. BUTT JOINT TO EXIST ASPHALT. FINAL OVERLAY TO MATCH EXISTING WITH NO DISCERNABLE "BUMP" AT JOINT. MILLING LIMITS THAT IMPACT INTERSECTION SHALL BE ADDRESSED ON A CASE BY CASE BASIS AND APPROVED BY MANATEE COUNTY.
7. SHEETING ORDERED LEFT IN PLACE TO BE CUT OFF 24" BELOW FINISHED GRADE OR 12" BELOW SUBGRADE.
8. NEW BASE SHALL MATCH EXISTING; OR BE CRUSHED CONCRETE, 8" MIN. THICKNESS, LBR ≥150, WHICHEVER IS GREATER.
9. TEMPORARY PATCHES WILL BE INSTALLED TO PROVIDE A SMOOTH ALL WEATHER SURFACE AT ALL TIMES. PERMANENT REPLACEMENT TO BE MADE AS SOON AS POSSIBLE.
10. RESTORE SIGNAGE & MARKING WITH THERMOPLASTIC PER FDOT STANDARDS, LATEST EDITION.
11. TRACER WIRE NOT REQUIRED FOR GRAVITY SEWERS.
12. NOTES 5. THRU 10. ARE MINIMUM REQUIREMENTS FOR A TRENCH IN A LOCAL ROAD. REFER TO LATEST EDITION OF MANATEE COUNTY HIGHWAY AND TRAFFIC STANDARDS FOR ADDITIONAL REQUIREMENTS.

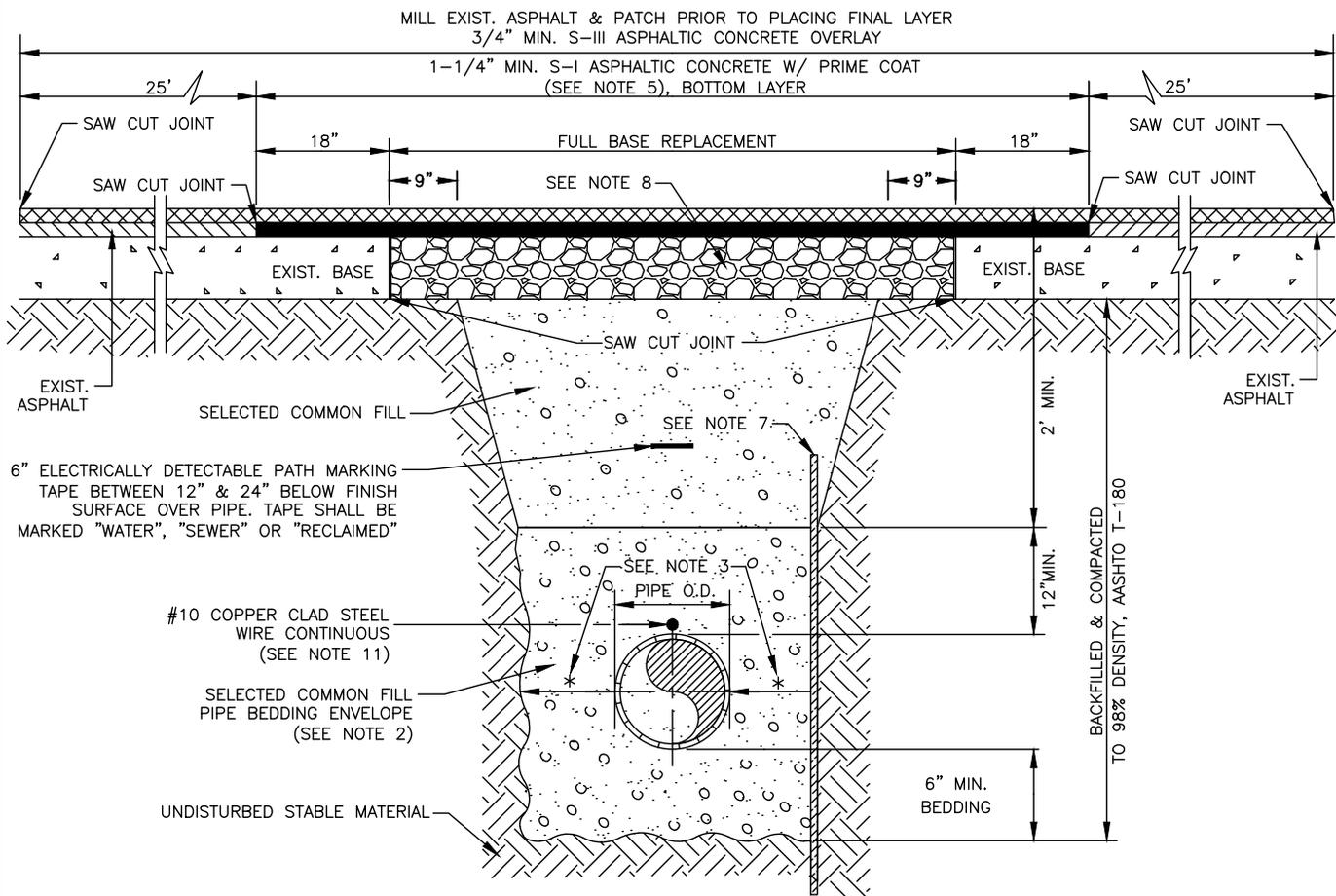

MANATEE COUNTY
PUBLIC WORKS DEPARTMENT

TRENCH WITH ASPHALT
PAVEMENT SURFACE
TYPE A-1 PIPE
BEDDING (CROSSING)

UG-12

REV. BY	DATE

February 25, 2020
DATE OF APPROVAL

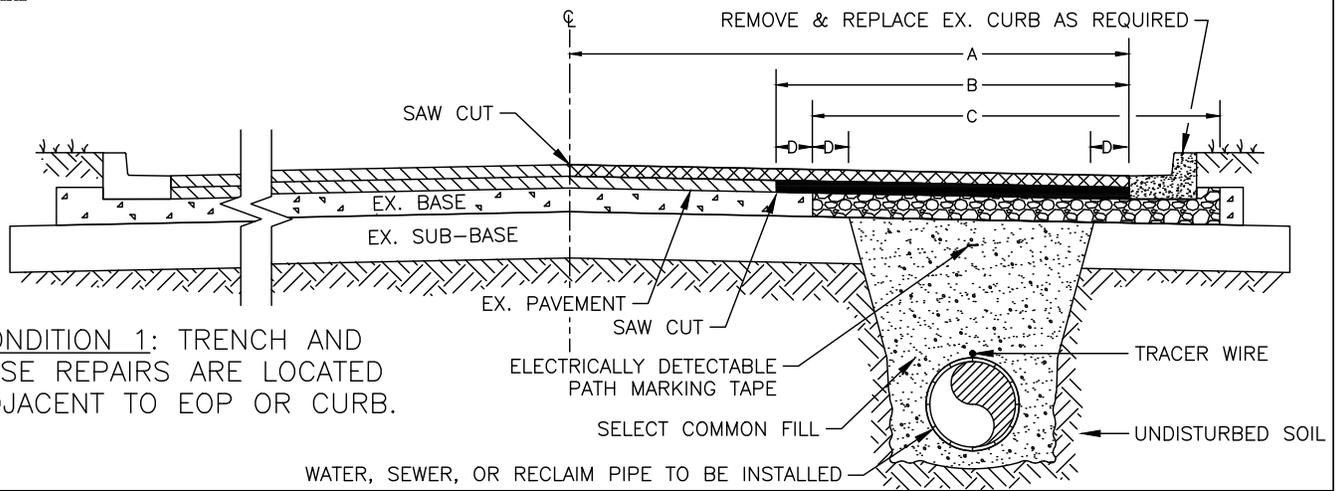

CONDITION 1: TRENCH AND BASE REPAIRS ARE LOCATED ADJACENT TO EOP OR CURB.

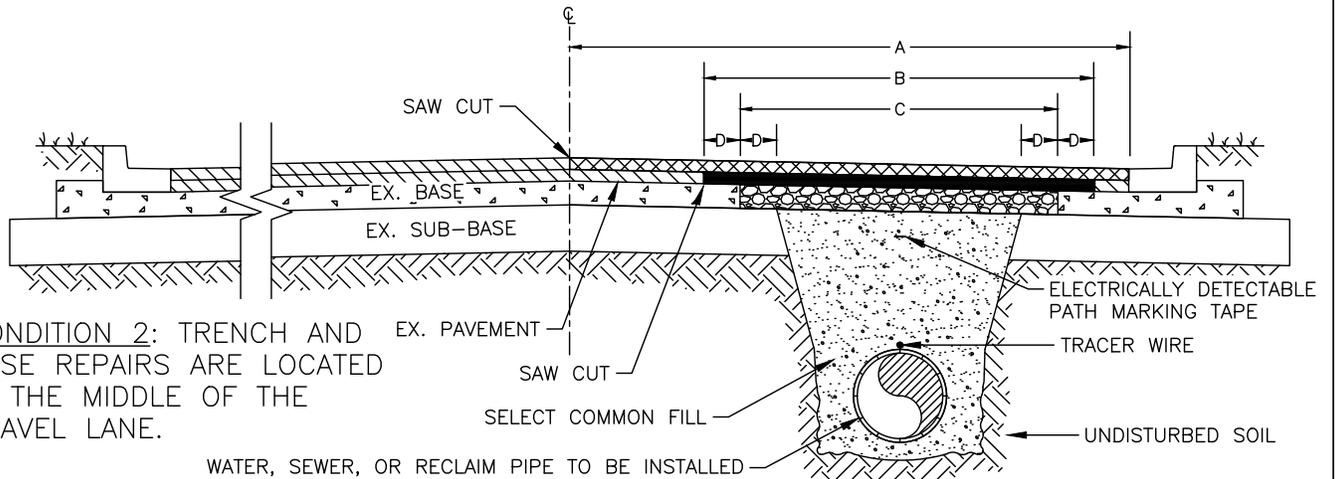

CONDITION 2: TRENCH AND BASE REPAIRS ARE LOCATED IN THE MIDDLE OF THE TRAVEL LANE.

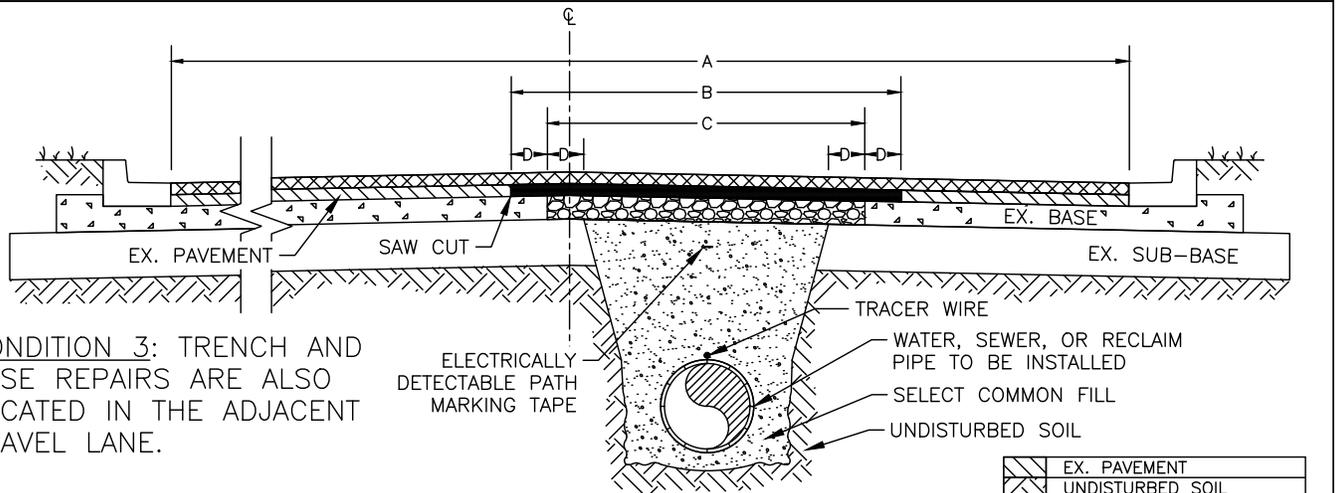

CONDITION 3: TRENCH AND BASE REPAIRS ARE ALSO LOCATED IN THE ADJACENT TRAVEL LANE.

A = MILL EXIST. ASPHALT & PLACE 3/4" MIN. S-III ASPHALTIC CONCRETE OVERLAY.
 B = 1-1/4" MIN. S-I ASPHALTIC CONCRETE W/ PRIME COAT.
 C = FULL BASE REPLACEMENT.
 D = 9 INCHES

NOTE:

1. THIS DETAIL IS BASED ON A TWO-LANE ROADWAY AND SHALL BE FOLLOWED WHEN A PIPE IS INSTALLED WITHIN THE LIMITS OF A ROADWAY AND RUNS PARALLEL WITH THE EDGE OF PAVEMENT. THIS DETAIL CAN ALSO BE UTILIZED FOR RESTORATION NEEDS OF ROADWAYS WITH ADDITIONAL LANES. CONDITION 3 ONLY EXTENDS TO NEXT ADJACENT LANE ON MULTI-LANE ROADS.
2. THE MILL AND OVERLAY SHALL BE FIELD ADJUSTED TO MEET THE NEEDS FOR PAVEMENT RESTORATION DUE TO CONSTRUCTION ACTIVITIES AND SHALL BE COORDINATED WITH THE COUNTY.
3. SEE TRENCH WITH ASPHALT PAVEMENT TYPE A-1 PIPE BEDDING (CROSSING) DETAIL FOR NOTES 1 TO 12 THAT ARE ALSO APPLICABLE TO ASPHALT PAVEMENT RESTORATION.

	EX. PAVEMENT
	UNDISTURBED SOIL
	EX. BASE
	SELECT COMMON FILL
	BASE REPLACEMENT
	S-I
	S-III
	NEW CURB

MANATEE COUNTY PUBLIC WORKS DEPARTMENT	
REV. BY	DATE
February 25, 2020 DATE OF APPROVAL	

TRENCH WITH ASPHALT
PAVEMENT SURFACE
TYPE A-1 PIPE
BEDDING (LONGITUDINAL)

UG-12B

NOTES:

1. CONCRETE PAVEMENT SHALL BE REMOVED WITH SAWEDED EDGES AND CUT AT A MINIMUM DEPTH OF ONE AND ONE-HALF (1-1/2"). IF A SAW CUT IN CONCRETE PAVEMENT FALLS WITHIN THREE FEET (3') OF A CONTRACTION JOINT, COLD JOINT, EXPANSION JOINT OR EDGE, THE CONCRETE SHALL BE REMOVED TO THE JOINT OR EDGE. THE EDGES OF EXISTING CONCRETE PAVEMENT ADJACENT TO TRENCHES, WHICH HAD BEEN DAMAGED SUBSEQUENT TO SAW CUTTING OF PAVEMENT, SHALL BE SAW CUT TO NEAT STRAIGHT LINES FOR THE PURPOSE OF REMOVING THE DAMAGED PAVEMENT AREAS.
2. USE OF TYPE A-2 AND A-3 PIPE BEDDING TO BE DETERMINED IN THE FIELD BY THE ENGINEER.
3. PROVIDE ADEQUATE CLEARANCE TO PLACE AND COMPACT STAGE 1 BEDDING MATERIAL IN TRENCH AREA BELOW PIPE SPRINGLINE. PIPE EMBEDMENT MUST BE COMPACTED OUT TO THE TRENCH WALL OR 2.5 TIMES THE PIPE OD, WHICHEVER IS LESS.
4. PIPE INSTALLATION SHALL BE IN ACCORDANCE WITH THE MANUFACTURER'S WRITTEN INSTRUCTIONS.
5. THICKNESS TO MATCH EXISTING OR BE 8" MINIMUM, WHICHEVER IS GREATER.
6. SHEETING ORDERED LEFT IN PLACE TO BE CUT OFF 24" BELOW FINISHED GRADE OR 12" BELOW SUBGRADE.
7. BASE SHALL BE CRUSHED CONCRETE, 8" MIN. THICKNESS, LBR ≥150.
8. TEMPORARY PATCHES WILL BE INSTALLED TO PROVIDE A SMOOTH ALL WEATHER SURFACE AT ALL TIMES. PERMANENT REPLACEMENT TO BE MADE AS SOON AS POSSIBLE.
9. TRACER WIRE NOT REQUIRED FOR GRAVITY SEWERS.
10. NOTES 5 THRU 8 ARE MINIMUM REQUIREMENTS. REFER TO MANATEE COUNTY HIGHWAY AND TRAFFIC STANDARDS FOR ADDITIONAL REQUIREMENTS.

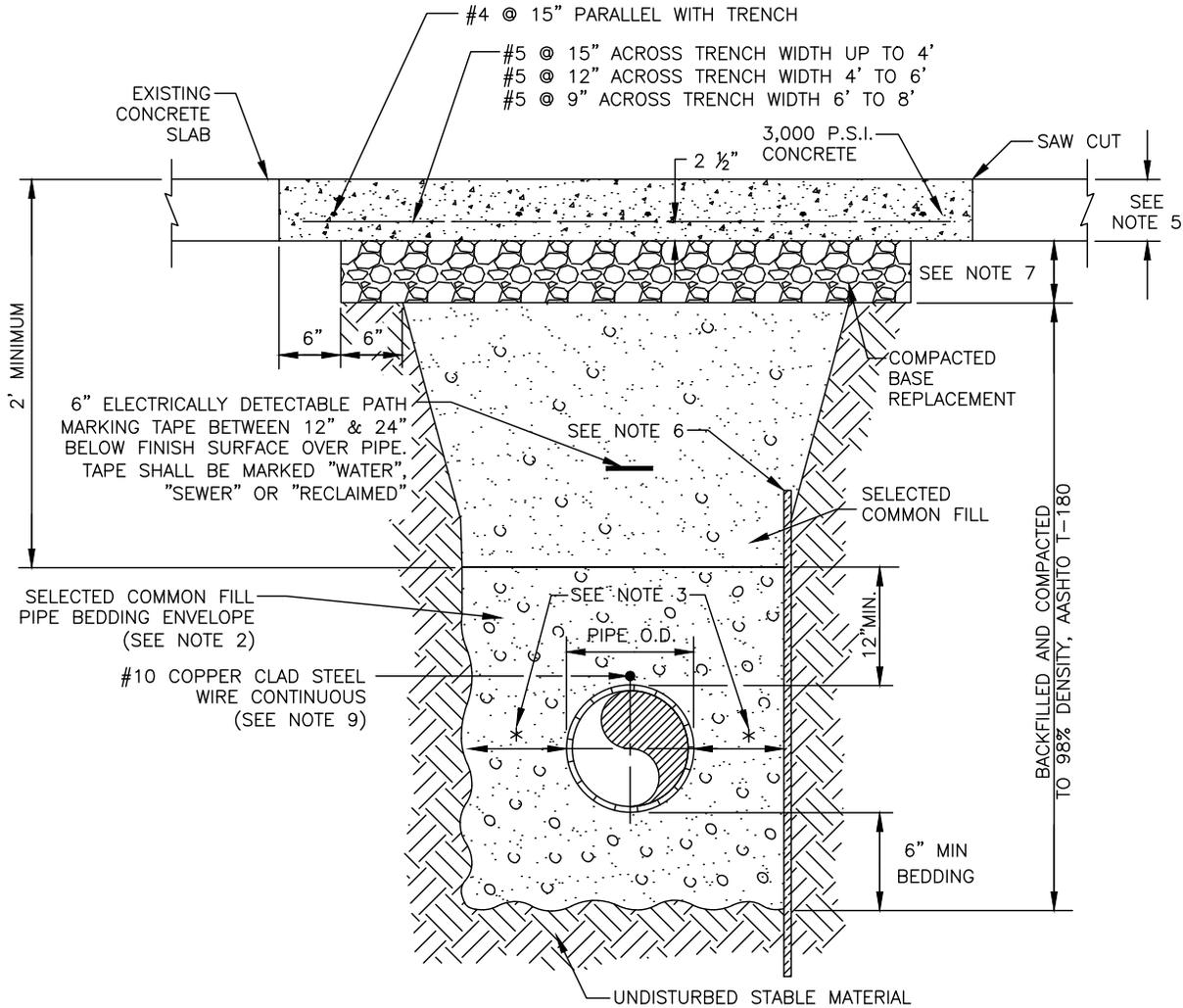

MANATEE COUNTY
PUBLIC WORKS DEPARTMENT

REV. BY	DATE

February 25, 2020
DATE OF APPROVAL

TRENCH WITH CONCRETE
PAVEMENT SURFACE TYPE
A-1 PIPE BEDDING

UG-13

NOTES:

1. PROVIDE ADEQUATE CLEARANCE TO PLACE AND COMPACT STAGE 1 BEDDING MATERIAL IN TRENCH AREA BELOW PIPE SPRINGLINE. PIPE EMBEDMENT MUST BE COMPACTED OUT TO THE TRENCH WALL OR 2.5 TIMES THE PIPE OD, WHICHEVER IS LESS.
2. PIPE INSTALLATION SHALL BE IN ACCORDANCE WITH MANUFACTURER'S WRITTEN INSTRUCTIONS.
3. TRACER WIRE NOT REQUIRED FOR GRAVITY SEWERS.

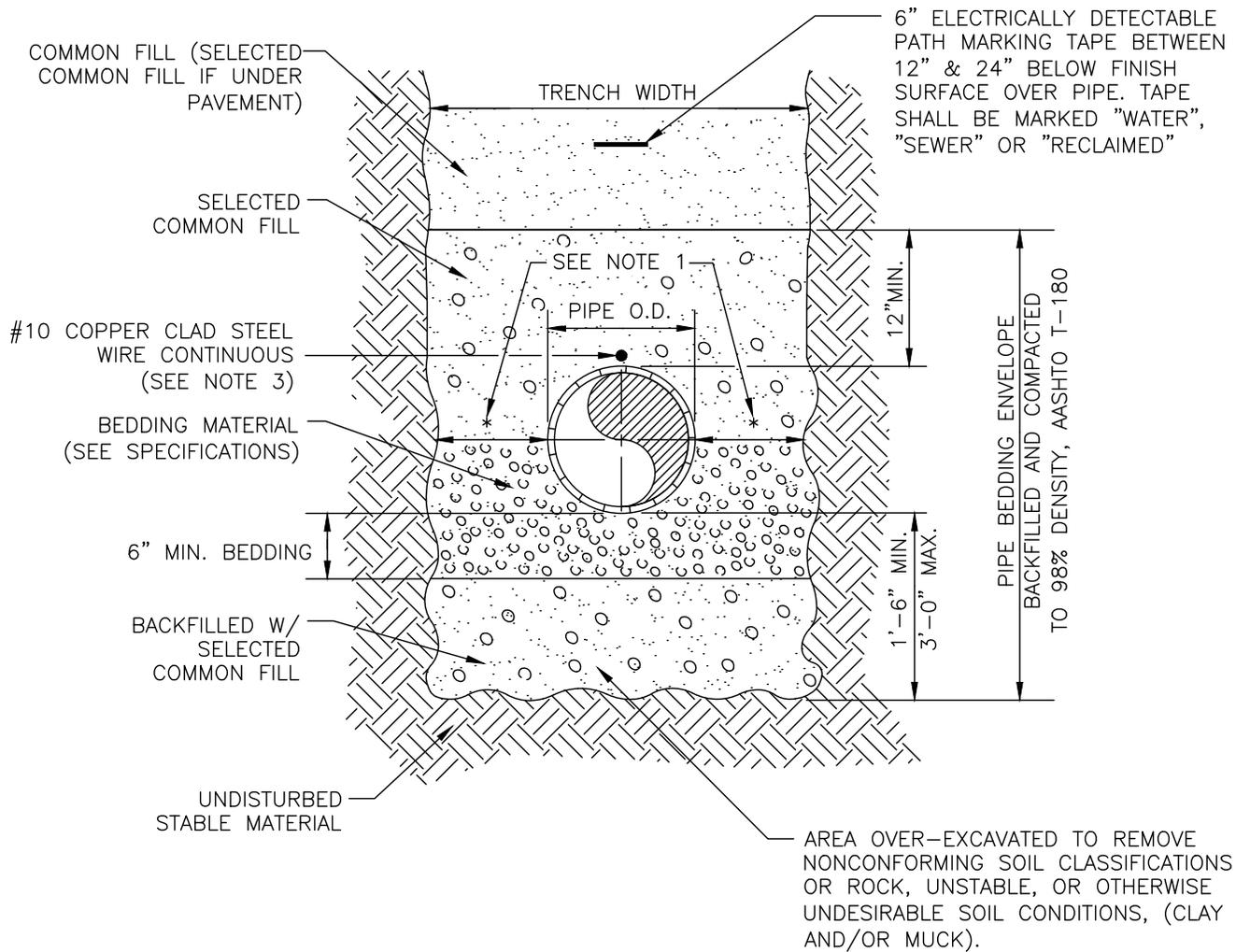

MANATEE COUNTY PUBLIC WORKS DEPARTMENT		TRENCH WITH TYPE A-3 PIPE BEDDING	UG-16
REV. BY	DATE		
	February 25, 2020		
	DATE OF APPROVAL		

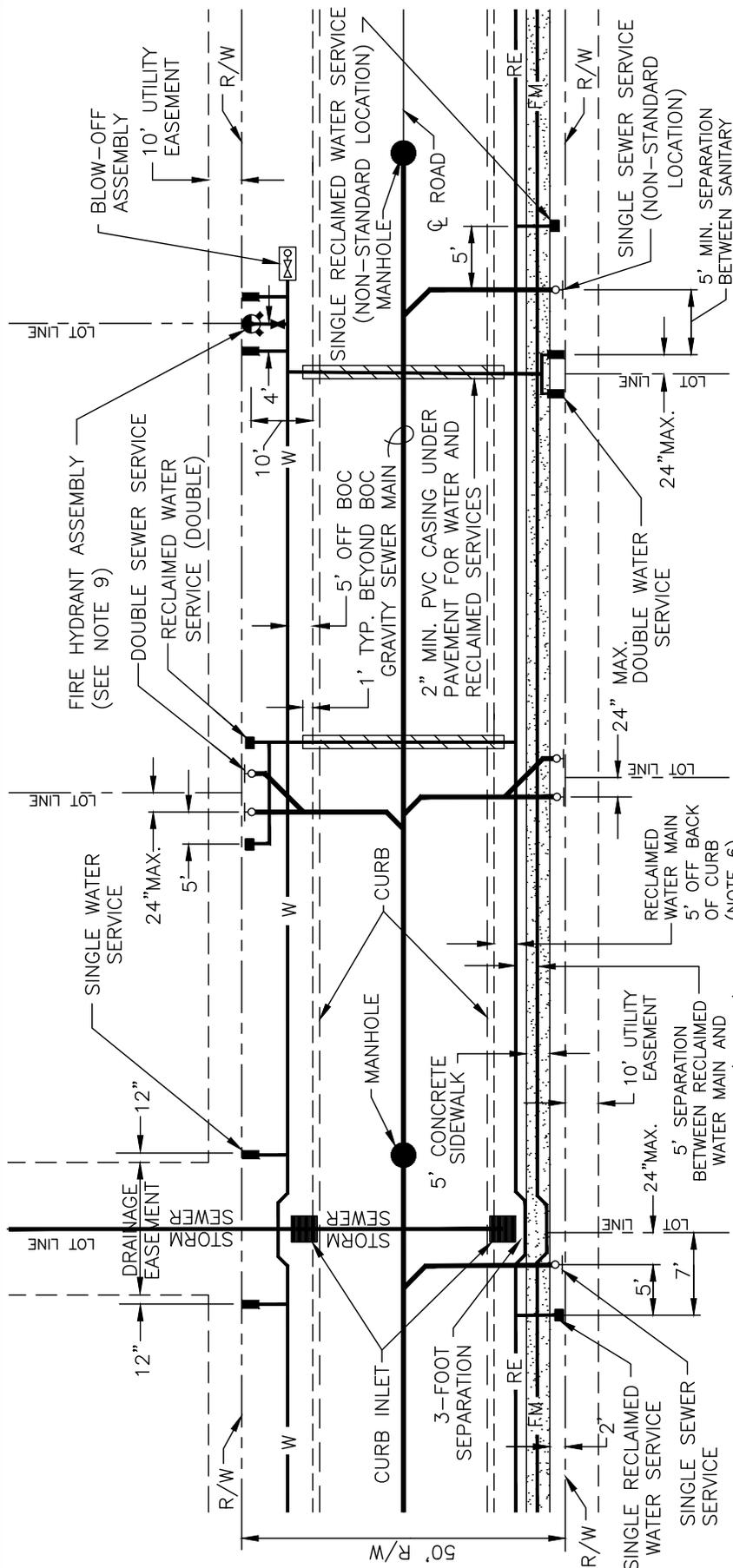

NOTES:

1. 5' WIDE SIDEWALK TO BE LOCATED 2' OFF RIGHT-OF-WAY LINE (4' SEPARATION FROM SIDEWALK TO BACK OF CURB). SEE PLAN FOR SIDEWALK LOCATION.
2. WATER SERVICES TO BE 24" MAX. OFF LOT LINE, 12" MAX. AT DRAINAGE EASEMENTS. SANITARY CLEAN-OUTS TO BE 12" OFF RIGHT-OF-WAY LINE AND 24" MAX. OFF LOT LINE, 12" MAX. AT DRAINAGE EASEMENTS. RECLAIMED WATER SERVICES TO BE 7' MAX. OFF LOT LINE (5' AWAY FROM SANITARY SERVICES), 6' MAX. AT DRAINAGE EASEMENTS.
3. ALL PRESSURE MAINS SHALL BE MIN. 3 FEET FROM STRUCTURES.
4. POTABLE WATER MAIN TO BE 5' OFF BACK OF CURB, ON OPPOSITE SIDE OF ROAD FROM SIDEWALK.
5. SEWER MAIN TO BE ALONG CENTERLINE OF ROADWAY, EXCEPT IN CURVES, AND SHALL IN NO CASE BE CLOSER THAN 10' AWAY FROM POTABLE WATER MAINS AND 5' AWAY FROM RECLAIMED WATER MAINS. MANHOLE COVERS SHALL BE IN CENTERLINE OF ROADWAY, OR CENTER OF TRAVELED LANE.
6. RECLAIMED WATER MAIN TO BE 5' OFF BACK OF CURB (OPPOSITE SIDE OF ROAD FROM POTABLE WATER MAIN), EXCEPT WHEN INSTALLED ON SAME SIDE OF ROAD AND PARALLEL TO FORCE MAIN, IN WHICH CASE RECLAIMED WATER MAIN TO BE 3' OFF BACK OF CURB. 10' UTILITY EASEMENT SHALL BE IN THE FRONT OF THE LOTS IN LIEU OF THE BACK OF THE LOTS.
7. FORCE MAIN TO BE 5' OFF BACK OF CURB (OPPOSITE SIDE OF ROAD FROM POTABLE WATER MAIN), EXCEPT WHEN INSTALLED ON SAME SIDE OF ROAD AND PARALLEL TO RECLAIMED WATER MAIN, IN WHICH CASE FORCE MAIN TO BE 8' OFF BACK OF CURB.
8. POTABLE WATER, RECLAIMED WATER AND FORCE MAINS TO DEFLECT BEHIND AND DO NOT TOUCH CURB INLETS. MAXIMUM OBTAINABLE SEPARATION OF POTABLE WATER, RECLAIMED WATER AND FORCE MAINS TO CURB INLETS SHALL BE PROVIDED WHILE MAINTAINING ALL OTHER SETBACK REQUIREMENTS.
9. FIRE HYDRANTS TO BE 10' OFF BACK OF CURB, ON SAME SIDE OF ROAD AS WATER MAIN, AT LOT LINES (TYPICALLY AT PROPERTY CORNERS WHERE WATER SERVICES ARE LOCATED).
10. PVC OR HDPE CASINGS FOR WATER AND RECLAIMED WATER SERVICE ROADWAY CROSSINGS TO HAVE 36" MINIMUM COVER.
11. ALL OTHER R.O.W. WIDTHS SHALL CONFORM TO THE ABOVE MINIMUM SETBACKS FOR FORCEMAINS, POTABLE & RECLAIMED WATERMAINS. NO SEWER LATERAL CLEANOUTS SHALL BE LOCATED IN THE SIDEWALK OR DRIVEWAYS.

MANATEE COUNTY
PUBLIC WORKS DEPARTMENT

February 25, 2020
DATE OF APPROVAL

UTILITY LAYOUT
FOR 50' R/W

UG-17

REV. BY	DATE

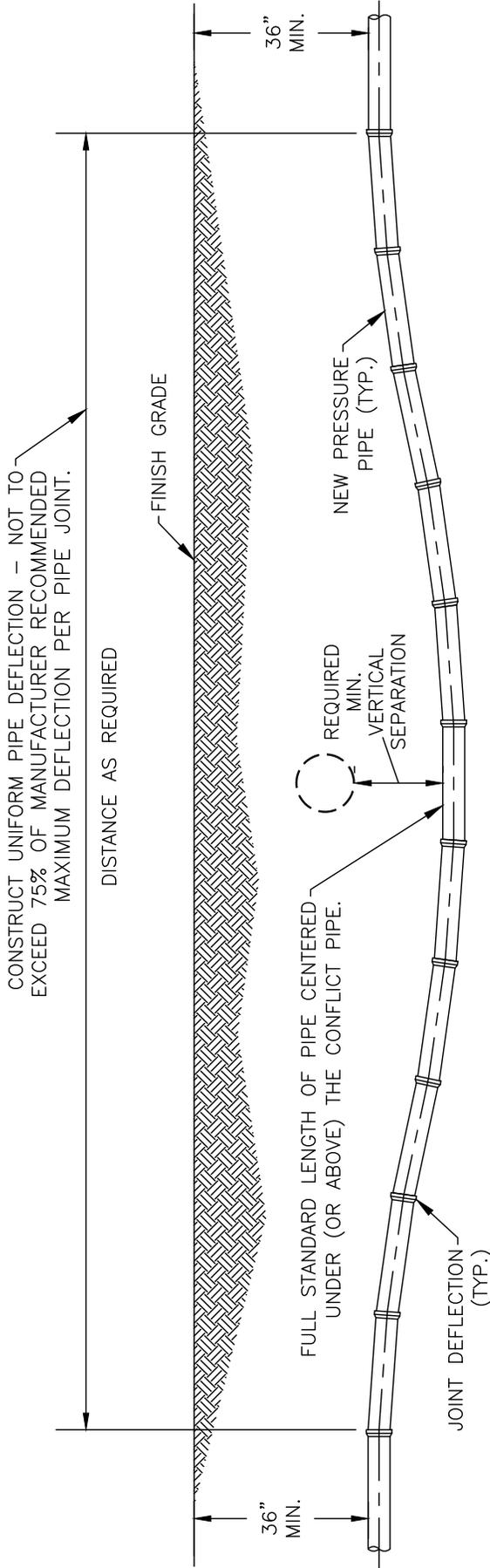

DEFLECTION TYPE

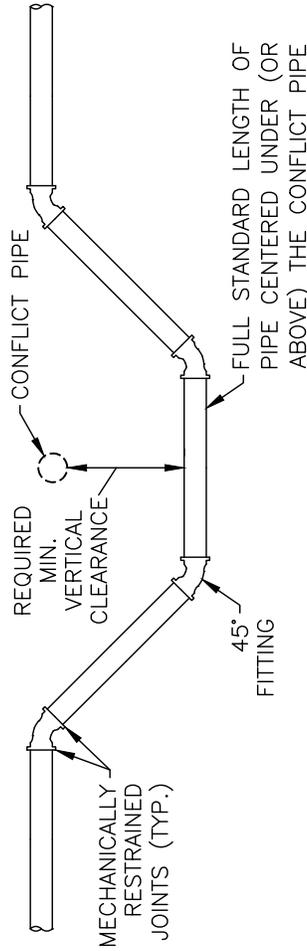

FITTING TYPE

NOTES:

1. AT ALL TIMES, PIPE SHALL CROSS ABOVE CONFLICT WHEN POSSIBLE.
2. THESE METHODS ARE TO BE USED WHEN INSUFFICIENT COVER EXISTS TO ALLOW PRESSURE PIPE TO CROSS ABOVE CONFLICT PIPE WITH 6" VERTICAL SEPARATION AND MAINTAIN REQUIRED COVER TO FINISHED GRADE.
3. THE DEFLECTION TYPE CROSSING IS PREFERRED.
4. DO NOT EXCEED 75% OF MANUFACTURER'S RECOMMENDED MAXIMUM JOINT DEFLECTION.
5. FITTINGS SHALL BE RESTRAINED AS SPECIFIED IN DETAIL UG-8 "RESTRAINED LENGTH FOR PVC PIPE" OR UG-9 "RESTRAINED LENGTH FOR DIP".

MANATEE COUNTY
PUBLIC WORKS DEPARTMENT

REV. BY	DATE

February 25, 2020
DATE OF APPROVAL

PRESSURE PIPE
DEFLECTION AT
UTILITY CROSSING

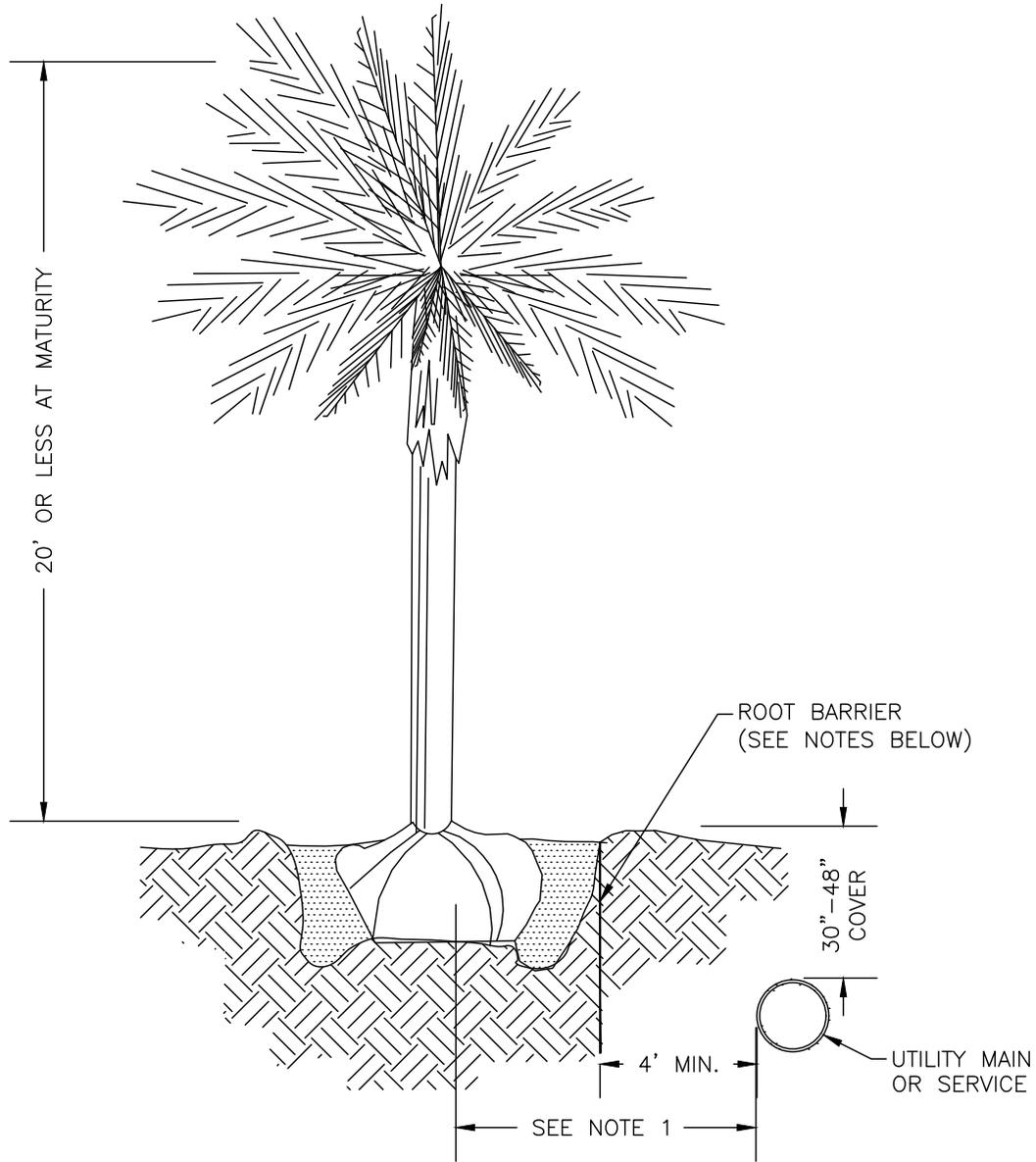

NOTES:

1. THIS DISTANCE SHALL BE 7' MINIMUM WITH ROOT BARRIER AND 10' MINIMUM IF NO ROOT BARRIER IS USED.
2. ALL ROOT BARRIERS SHALL BE 4' MINIMUM FROM ALL MAINS AND SERVICES.
3. THE INSTALLATION OF ROOT BARRIERS SHALL BE COORDINATED WITH MANATEE COUNTY AND INSPECTED BY MANATEE COUNTY PRIOR TO BACKFILLING. ALL ROOT BARRIERS SHALL EXTEND UP TO FINISHED GRADE
4. ROOT BARRIERS SHALL BE A FLEXIBLE PANEL BARRIER, A MINIMUM 36" DEEP.
5. ALL ROOT BARRIERS SHALL BE INSTALLED IN ACCORDANCE WITH MANUFACTURES WRITTEN INSTRUCTIONS.

MANATEE COUNTY
PUBLIC WORKS DEPARTMENT

TYP. SMALL TREE
OR PALM TREE WITH
ROOT BARRIER

UG-19

REV.BY	DATE

February 25, 2020
DATE OF APPROVAL

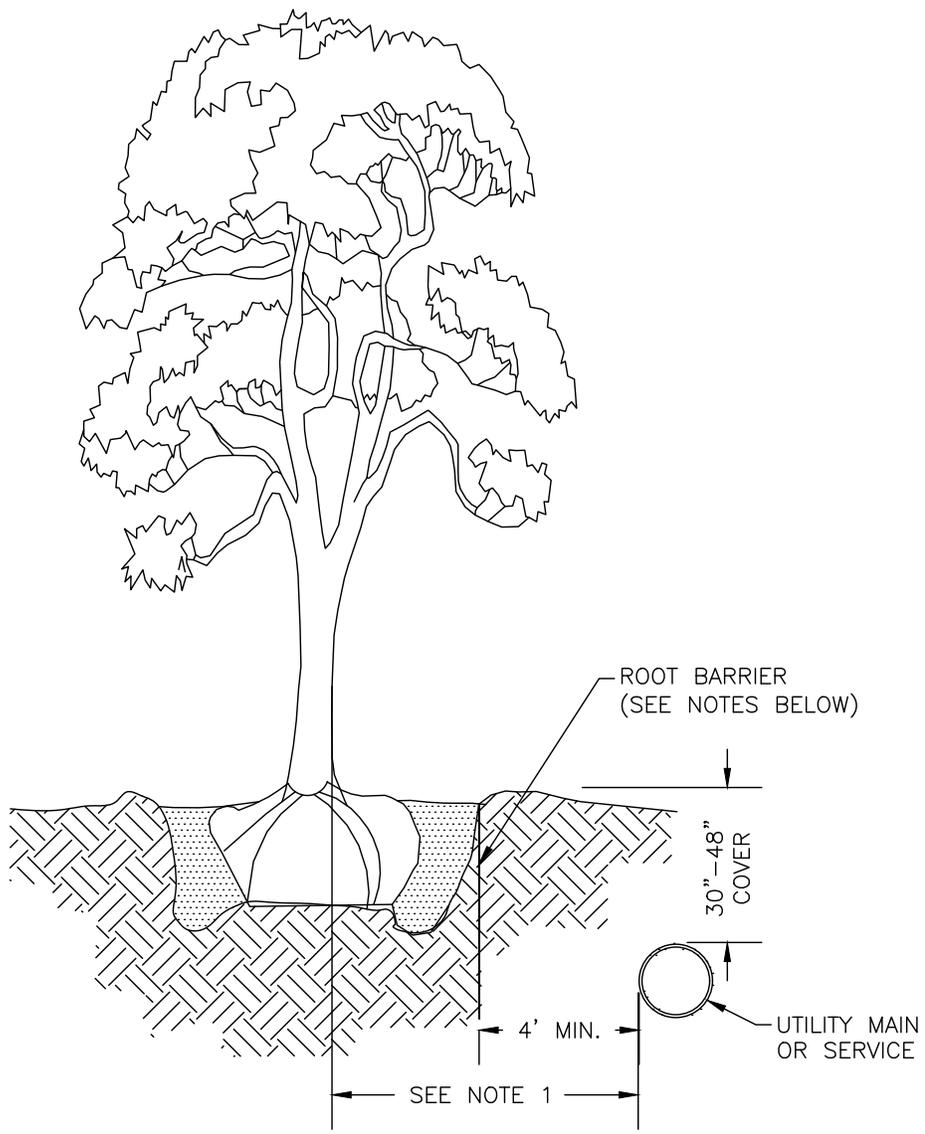

NOTES:

1. THIS DISTANCE SHALL BE 10' MINIMUM WITH ROOT BARRIER AND 15' MINIMUM IF NO ROOT BARRIER IS USED.
2. ALL ROOT BARRIERS SHALL BE 4' MINIMUM FROM ALL MAINS AND SERVICES.
3. THE INSTALLATION OF ROOT BARRIERS SHALL BE COORDINATED WITH MANATEE COUNTY AND INSPECTED BY MANATEE COUNTY PRIOR TO BACKFILLING. ALL ROOT BARRIERS SHALL EXTEND UP TO FINISHED GRADE
4. ROOT BARRIERS SHALL BE MINIMUM 36" DEEP. FLEXIBLE BARRIERS SHALL BE 36" PANELS.
5. ALL ROOT BARRIERS SHALL BE INSTALLED IN ACCORDANCE WITH MANUFACTURES WRITTEN INSTRUCTIONS.
6. LARGE PALM TREES INCLUDE ROYAL, WASHINGTONIAN, BISMARCK AND SIMILAR SIZED SPECIES.

MANATEE COUNTY PUBLIC WORKS DEPARTMENT		TYP. CANOPY TREE, LARGE PALM OR EXOTIC TREE WITH ROOT BARRIER	UG-20
REV. BY	DATE		
	February 25, 2020		
	DATE OF APPROVAL		

INTENTIONALLY
LEFT
BLANK

TABLE OF CONTENTS

UTILITY STANDARDS—WATER DISTRIBUTION SYSTEM

UW-1 TABLE OF CONTENTS—GENERAL UTILITY CONSTRUCTION
 UW-2 GATE VALVE, BOX, LID AND TAG
 UW-3 TAPPING SLEEVE & VALVE (WATER/RECLAIM)
 UW-4 CUT-IN TEE
 UW-5 FIRE HYDRANT ASSEMBLY
 UW-6 HYDRANT LOCATION MARKER
 UW-7 FIRE HYDRANT WITH LOCKED 90° BEND
 UW-8 2” BLOW-OFF ASSEMBLY FOR 10” MAINS AND SMALLER
 UW-9 FIRE HYDRANT BLOW-OFF ASSEMBLY FOR 12” MAINS AND LARGER
 UW-10 AIR RELEASE ASSEMBLY FOR 12” AND SMALLER MAINS
 UW-11 AIR RELEASE ASSEMBLY FOR 16” AND LARGER MAINS
 UW-12 BELOW GRADE MANUALLY OPERATED AIR RELEASE VALVE
 UW-13 ¾” & 1” BACKFLOW PREVENTER
 UW-14 1½” & 2” METER AND BACKFLOW PREVENTER
 UW-15 2” AND ABOVE FIRE LINE BACKFLOW PREVENTER
 UW-16 3” AND ABOVE MASTER METER
 UW-16A 4”-10” MASTER FIRE/POTABLE COMBINATION METER
 UW-17 REPLACEMENT FOR 3” AND ABOVE MASTER METER
 UW-17A REPLACEMENT FOR 4”-10” MASTER FIRE/POTABLE COMBINATION METER
 UW-18 METER BOX ASSEMBLY FOR ⅝”x ¾”; ¾”; AND 1” METERS
 UW-19 TEMPORARY RESIDENTIAL DIRECT CONNECTION
 UW-20 MULTIPLE METER VAULT
 UW-21 TYPICAL SERVICE CONNECTION
 UW-22 CUL-DE-SAC MAINS
 UW-23A TEMPORARY JUMPER CONNECTION—HYDRANT AVAILABLE
 UW-23B TEMPORARY JUMPER CONNECTION—NO HYDRANT AVAILABLE
 UW-24 TEMPORARY JUMPER CONNECTION NOTES
 UW-25 INTERCONNECT TO MANATEE COUNTY

MANATEE COUNTY		TABLE OF CONTENTS WATER DISTRIBUTION	UW-1
PUBLIC WORKS DEPARTMENT			
REV. BY	DATE	<u>February 25, 2020</u> DATE OF APPROVAL	

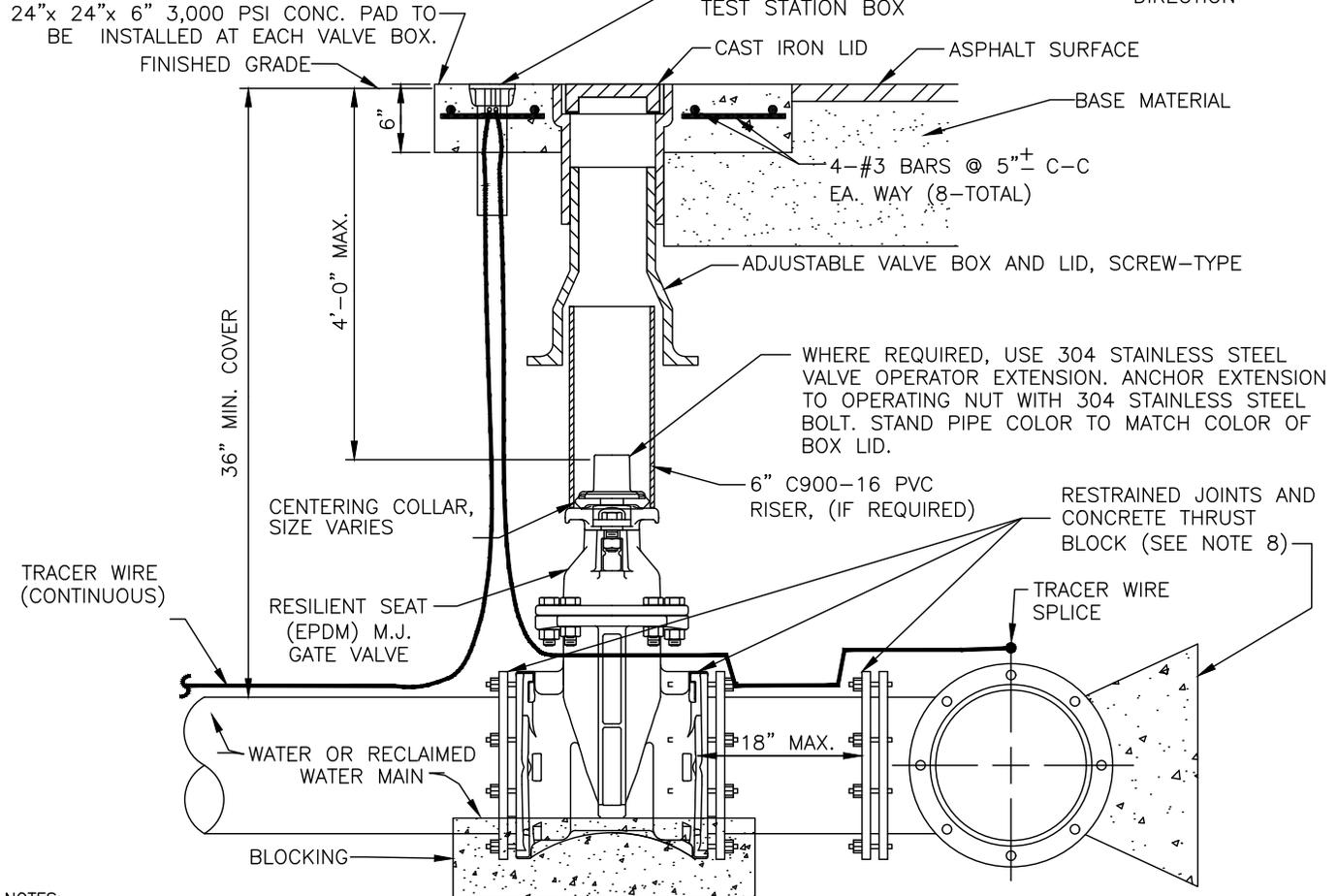
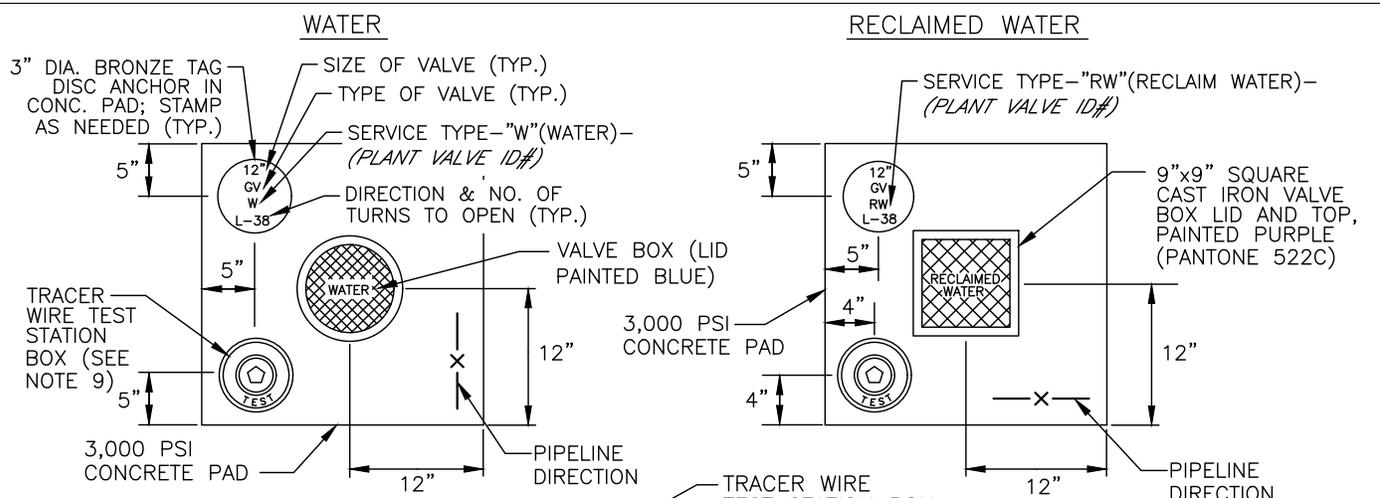

- NOTES:**
- "WV" OR "RWV" TO BE IMPRESSED INTO THE NEWLY-POURED CONCRETE CURB, ALONG WITH DISTANCE IN FEET TO THE VALVE. IF NO CURB, INSTALL A BLUE DISC WITH "WV" OR PURPLE DISC WITH "RWV" USING A 1/8" x 1" GALVANIZED STEEL SCREW IN THE EDGE OF PAVEMENT WITH THE FOOTAGE FROM THE DISC TO THE VALVE.
 - ALL EXISTING AND PROPOSED VALVE BOXES SHALL BE ADJUSTED TO FINISHED GRADES AS DETERMINED IN THE FIELD.
 - VALVES SHALL NOT BE PLACED IN HANDICAPPED RAMPS, CURBS, OR GUTTERS.
 - PRECAST CONCRETE PADS SHALL NOT BE USED.
 - ALL EXPOSED EDGES OF CONCRETE SHALL BE CHAMFERED 1/2".
 - PIPELINE DIRECTION TO BE IMPRESSED INTO NEWLY POURED CONCRETE PAD.
 - TRACER WIRE TEST STATION BOX IS NOT REQUIRED IN VALVE BOX PAD IF THE GATE VALVE IS LOCATED WITHIN 200 FEET OF A WATER SERVICE, BLOW-OFF, BACKFLOW PREVENTER OR FIRE HYDRANT THAT HAS A TRACER WIRE BOX.
 - WHERE THRUST BLOCK NOT USED, RESTRAINED JOINTS MUST THEN EXTEND FROM TEE FULL LENGTH SPECIFIED FOR "TEES."
 - USE NON-TRAFFIC RATED BOXES FOR NORMAL YARD SERVICE. WHERE VALVE WILL BE IN STREET OR PARKING UNDER VEHICLE TRAFFIC, USE TRAFFIC RATED BOXES. WHERE POSSIBLE, LOCATE TRACE WIRE TESTING STATION OUTSIDE OF TRAVEL LANE OR IN MEDIAN, CENTERED IN SEPARATE CONCRETE PAD SIMILAR TO STANDARD VALVE BOX PAD.
 - THE BRASS TAG SHALL HAVE A "PLANT VALVE ID#" WHEN VALVES ARE INSTALLED WITHIN THE COUNTY TREATMENT PLANT LIMITS. THE PLANT VALVE ID# SHALL BE SHOWN ON THE CONSTRUCTION PLANS AND RECORD DRAWINGS.
 - REFER TO SECTION 1.11 GATE VALVES IN THE PUBLIC WORKS UTILITY STANDARDS MANUAL FOR FURTHER DETAILS.

MANATEE COUNTY	
PUBLIC WORKS DEPARTMENT	
REV. BY	DATE
February 25, 2020	
DATE OF APPROVAL	

GATE VALVE, BOX,
LID AND TAG

UW-2

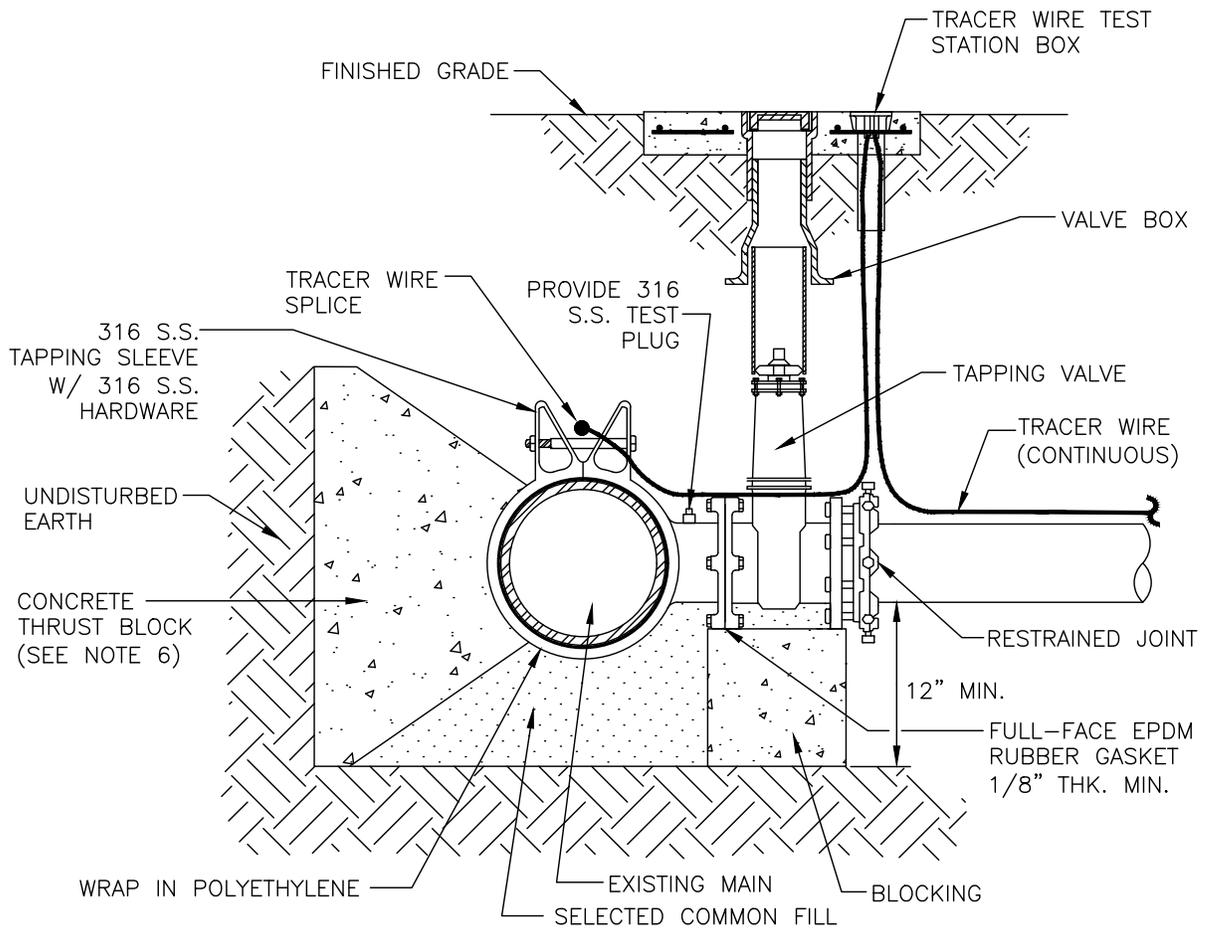

ELEVATION

NOTES:

1. PRIOR TO TAPPING, CONTRACTOR TO DEMONSTRATE 60 MINUTE HYDROSTATIC TEST OF THE TAPPING SLEEVE AND VALVE WITH NO LOSS OF 180 PSI PRESSURE FOR WATER AND RECLAIMED WATER.
2. ALL FITTINGS TO BE WRAPPED WITH 20 MIL POLYETHYLENE WRAP AT THRUST BLOCK.
3. ALL TAPS ON CONCRETE WATER MAINS AND LARGER THAN 12" ARE TO BE MADE BY A MANATEE COUNTY APPROVED TAPPING COMPANY. ALL MATERIALS TO BE SUPPLIED BY THE CONTRACTOR.
4. ALL TAPS MUST BE OF A SMALLER SIZE THAN THE MAIN BEING TAPPED & PLACED NO CLOSER THAN 30" OR A DISTANCE EQUAL TO (1) MAIN PIPE DIAMETER PLUS (2) TAP PIPE DIAMETERS (WHICHEVER IS GREATER) FROM A JOINT OR FITTING.
5. CONTRACTOR TO SUPPLY A DRY HOLE FOR TAPPING CREW TO WORK IN AND A BACK-HOE TO LOWER TAPPING MACHINE INTO THE HOLE.
6. WHERE THRUST BLOCK NOT USED, RESTRAINED JOINTS MUST THEN EXTEND FROM TEE FULL LENGTH SPECIFIED FOR "TEES."
7. TRACER WIRE TEST STATION BOX IS REQUIRED AT CONNECTIONS TO EXISTING MAINS.
8. SEE SECTION 1.11 TAPPING SLEEVES AND VALVES IN THE PUBLIC WORKS UTILITY STANDARDS MANUAL FOR FURTHER DETAILS.

MANATEE COUNTY PUBLIC WORKS DEPARTMENT		TAPPING SLEEVE AND VALVE (WATER/RECLAIM)	UW-3
REV. BY	DATE		
	February 25, 2020		
	DATE OF APPROVAL		

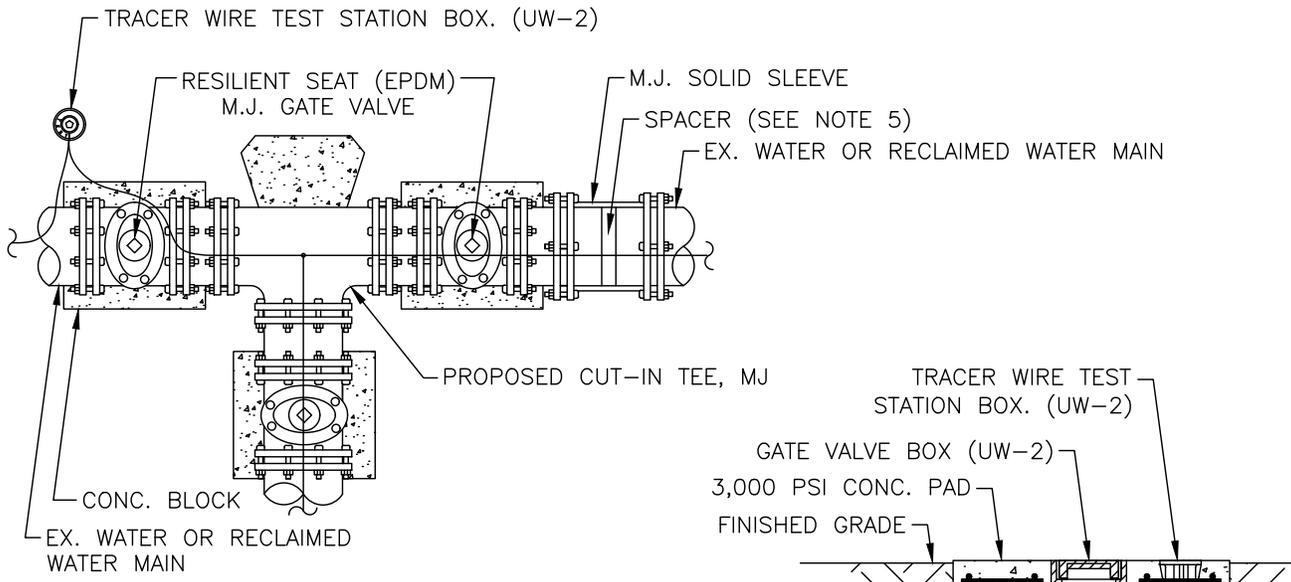

PLAN

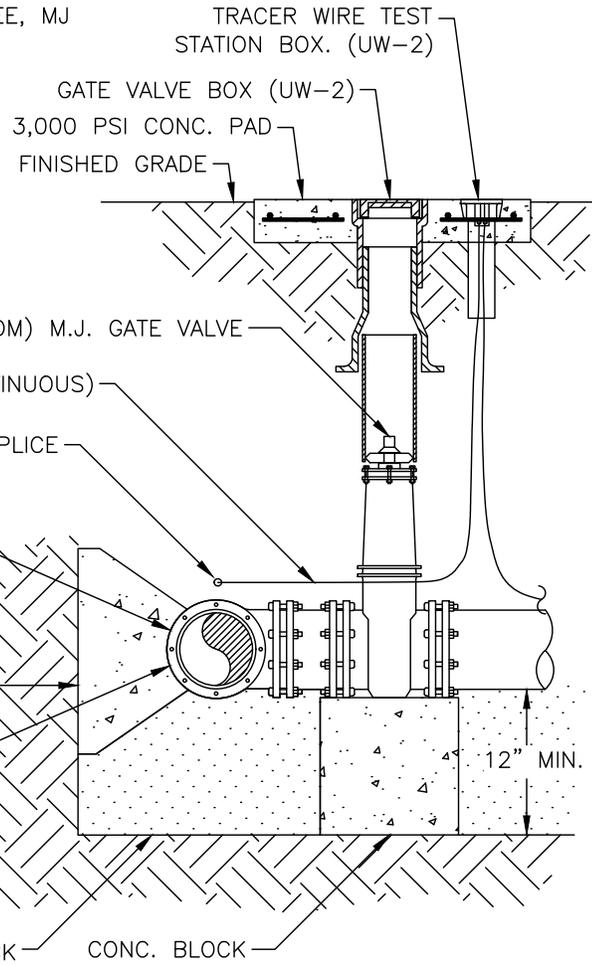

PROFILE

NOTES:

1. ALL FITTINGS TO BE WRAPPED WITH 20 MIL POLYETHYLENE WRAP AT THRUST BLOCK.
2. TRACER WIRE TEST STATION BOX IS REQUIRED AT CONNECTIONS TO EXISTING MAINS.
3. WATER VALVES SHALL BE INSTALLED ON ALL SIDES OF TEES AND CROSSES, UNLESS INLINE VALVES ON THAT LEG WITHIN 200 FEET.
4. RESTRAINED JOINTS MUST EXTEND FROM TEE FULL LENGTH SPECIFIED FOR VALVES.
5. SPACER IS REQUIRED IF A GAP EXISTS. SPACER NOT TO EXCEED OVER 30% OF SLEEVE WIDTH.
6. IN ASBESTOS CONCRETE PIPE (AC) APPLICATIONS: TWO COUPLINGS ARE REQUIRED. ALL FITTINGS INCLUDING COUPLINGS SHALL BE SUPPORTED WITH CONCRETE BLOCKING TO PREVENT SETTLEMENT.
7. ALL EXISTING RESTRAINING SHALL BE MODIFIED AND OR RE-INSTATED AS NECESSARY, TO MEET THE RESTRAINT REQUIREMENT FOR VALVES.
8. WHERE THRUST BLOCK NOT USED, RESTRAINED JOINTS MUST THEN EXTEND FROM TEE FULL LENGTH SPECIFIED FOR "TEES".

MANATEE COUNTY
PUBLIC WORKS DEPARTMENT

REV. BY	DATE

February 25, 2020
DATE OF APPROVAL

CUT-IN TEE

UW-4

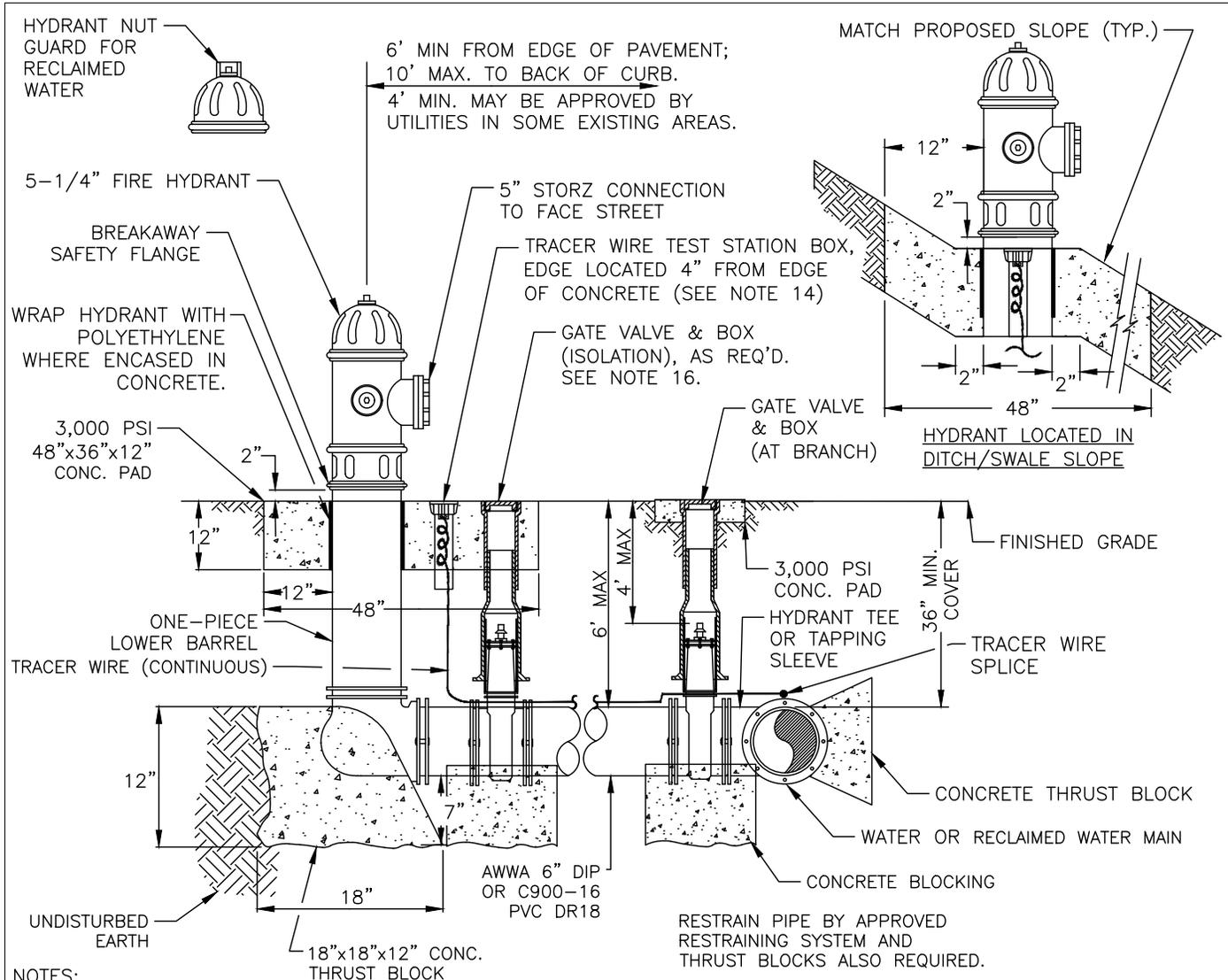

NOTES:

1. WEEPHOLES SHALL BE EXCLUDED FROM THE FIRE HYDRANT.
2. FIRE HYDRANTS SHALL BE A MINIMUM OF 6' OFF EDGE OF PAVEMENT AND 10' MAX. FROM BACK OF CURB. WHERE POSSIBLE AND WHERE SIDEWALK IS TO BE INSTALLED, FIRE HYDRANT SHALL BE LOCATED BETWEEN SIDEWALK AND RIGHT-OF-WAY LINE.
3. HYDRANT SHALL BE DUCTILE IRON CONSTRUCTION. HYDRANTS SHALL BE FUSION BONDED EPOXY COATED SAFETY YELLOW FOR WATER; PURPLE (PANTONE 522C) FOR RECLAIMED WATER; AND RED FOR PRIVATE.
4. FIRE HYDRANTS SHALL BE PLACED SO THAT STORM WATER FLOWS AWAY FROM THE HYDRANT.
5. FIRE HYDRANTS SHALL BE CONSTRUCTED WITH "GROUND LINE" SET TO FINISHED GRADES AS ESTABLISHED IN THE FIELD. NORMAL BURY IS 3 FEET OF COVER FOR ALL WATER LINES.
6. FIRE HYDRANTS MAY BE CONSTRUCTED WITH "GRADELOK" OFFSET FITTING.
7. RAISED REFLECTIVE PAVEMENT MARKER(S) (BLUE) FOR POTABLE WATER (PURPLE) FOR RECLAIMED WATER SHALL BE INSTALLED ON THE PAVEMENT DIRECTLY ACROSS FROM THE HYDRANT IN ACCORDANCE WITH THE FDOT TRAFFIC ENGINEERING MANUAL, CHAPTER 4, SECTION 4.3 OR MOST CURRENT ADDITION.
8. ALL EXPOSED EDGES OF CONCRETE SHALL HAVE 1/2" CHAMFER.
9. FIRE HYDRANT VALVE SHALL BE FASTENED DIRECTLY TO TEE.
10. IN-LINE VALVES SHOULD BE LOCATED AT HYDRANT TEES.
11. HYDRANTS SHALL BE LOCATED ON SAME SIDE OF ROAD AS WATER OR RECLAIMED MAIN.
12. THERE MUST BE A CLEARANCE OF 7 1/2 FEET FROM FRONT AND BOTH SIDES, AND FOUR FEET TO THE REAR OF THE HYDRANT, TO ABOVE GRADE OBSTRUCTIONS INCLUDING POSTS, FENCES, TREES, ETC, PER THE FLORIDA FIRE PREVENTION CODE.
13. SEE STANDARD DETAIL UW-2 GATE VALVE, BOX, LID AND TAG.
14. SHOULD THE FIRE HYDRANT'S CONCRETE PAD OVERLAP A SIDEWALK, THE TRACER WIRE TEST STATION BOX SHALL NOT BE LOCATED WITHIN THE SIDEWALK.
15. IF A HYDRANT IS LOCATED ON THE SLOPE OF A DITCH OR SWALE; THE CONCRETE PAD SHALL CONFORM TO THE FINISH GRADE/SLOPE. THE CONCRETE PAD SHALL BE LEVEL 2-INCHES BEHIND & IN FRONT OF THE HYDRANT.
16. AT THE DISCRETION OF THE COUNTY AN ADDITIONAL ISOLATION GATE VALVE SHALL BE ADDED, WHEN A PHYSICAL BARRIER IS PRESENT, (I.E. ROADWAY, FENCE, WALL, BERM ETC), BETWEEN THE BRANCH GATE VALVE AND THE HYDRANT.
17. SEE SECTION 1.11 HYDRANTS IN THE PUBLIC WORKS UTILITY STANDARDS MANUAL FOR FURTHER DETAILS.

MANATEE COUNTY		FIRE HYDRANT ASSEMBLY	UW-5
PUBLIC WORKS DEPARTMENT			
REV. BY	DATE		
		February 25, 2020	
		DATE OF APPROVAL	

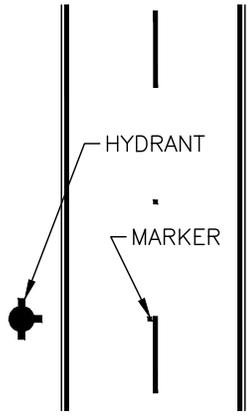

FIG 4.3-1
TWO-LANE STREET

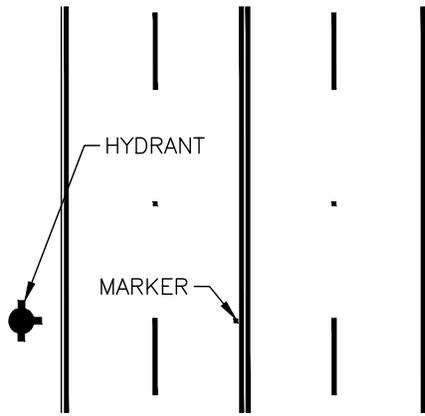

FIG 4.3-2
MULTI-LANE STREET

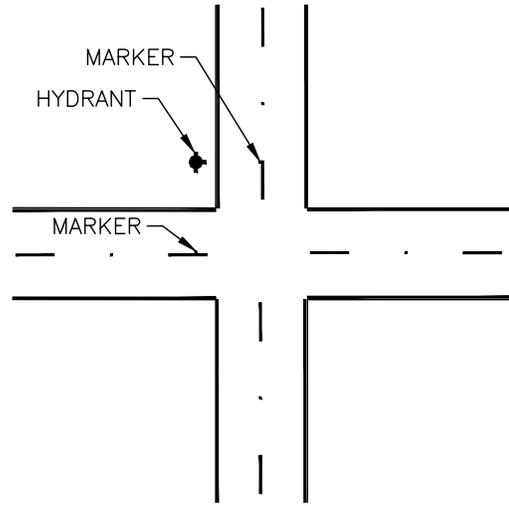

FIG 4.3-3
TWO-LANE STREET
AT INTERSECTION

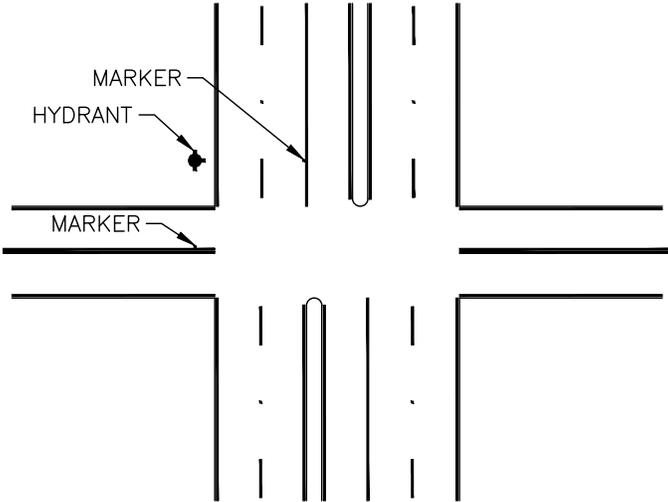

FIG 4.3-4
FOUR-LANE STREET WITH
TURN LANE AT INTERSECTION

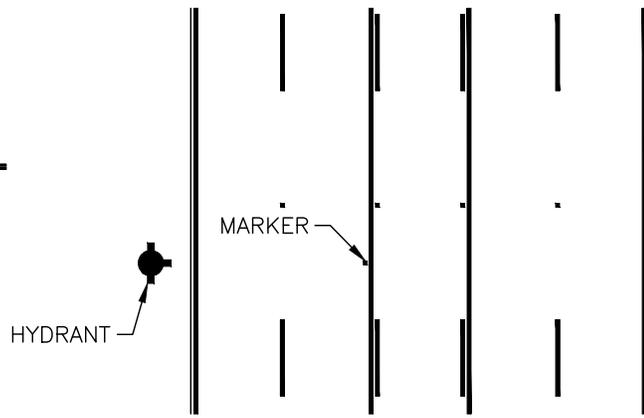

FIG 4.3-5
MULTI-LANE STREET
WITH TURN LANE

NOTES:

1. TWO-WAY STREETS OR ROADS: MARKER SHOULD BE PLACED 6 INCHES FROM EDGE OF PAINTED CENTERLINE ON THE SIDE NEAREST THE FIRE HYDRANT. IF THE STREET HAS NO CENTERLINE, THE MARKER SHOULD BE PLACED 6 INCHES FROM APPROXIMATE CENTER OF THE ROADWAY ON THE SIDE NEAREST THE HYDRANT. SEE FIGURE 4.3-1, 4.3-2, AND 4.3-3.
2. STREETS WITH LEFT TURN LANE AT INTERSECTION: MARKER SHOULD BE PLACED 6 INCHES FROM EDGE OF PAINTED WHITE CHANNELIZING LINE OF THE SIDE NEAREST THE FIRE HYDRANT. SEE FIGURE 4.3-4.
3. STREETS WITH CONTINUOUS TWO-WAY TURN LANE: MARKER SHOULD BE PLACED 6 INCHES FROM THE EDGE OF THE PAINTED YELLOW BARRIER LINE ON THE SIDE NEAREST THE FIRE HYDRANT. SEE FIGURE 4.3-5.
4. MARKER SHALL BE BLUE/BLEU RAISED RETROREFLECTIVE PAVEMENT MARKER.

MANATEE COUNTY
PUBLIC WORKS DEPARTMENT

HYDRANT LOCATION
MARKERS – BLUE
(RPMs)

UW-6

REV.BY	DATE

February 25, 2020
DATE OF APPROVAL

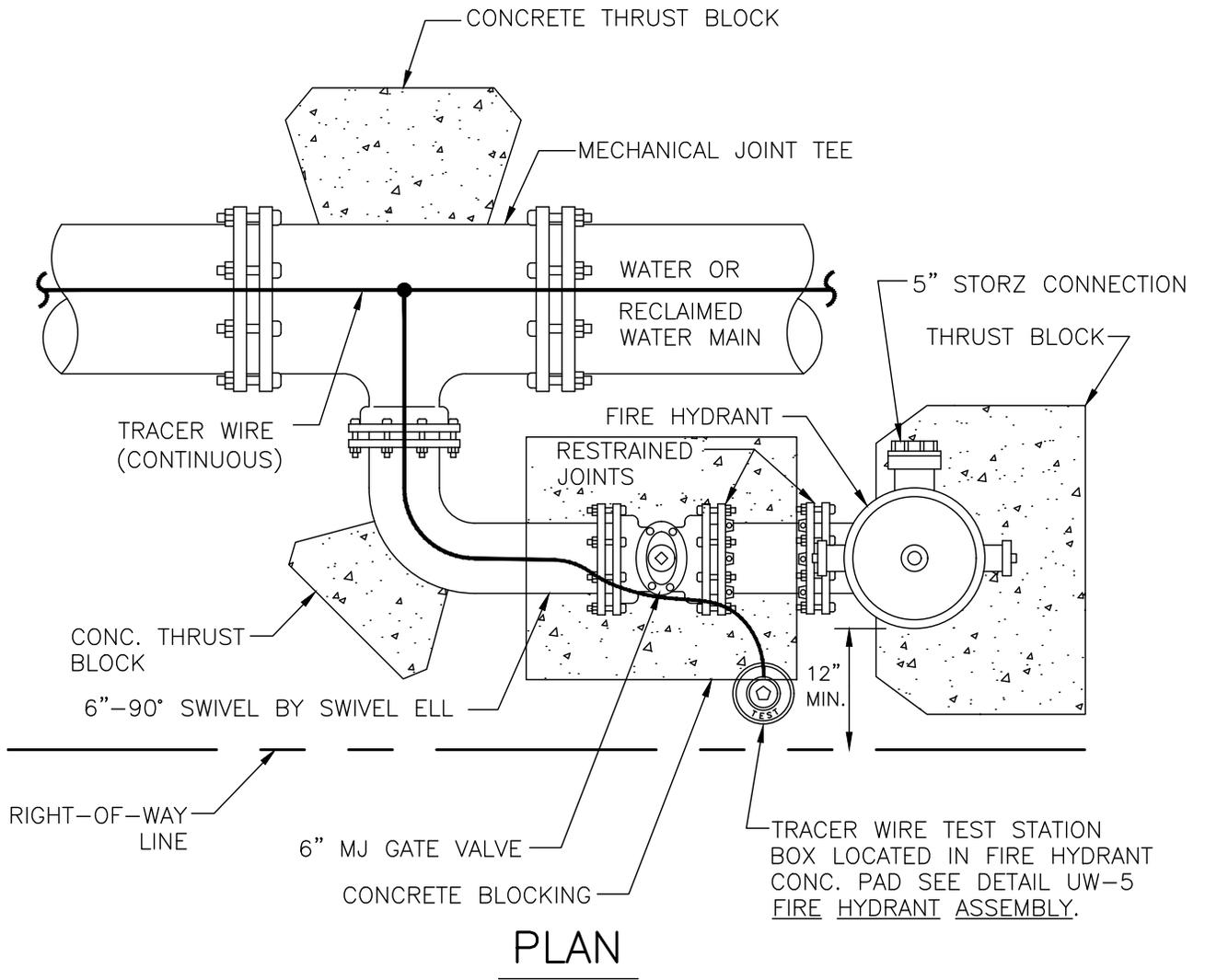

NOTES:

1. THIS DETAIL FOR USE ONLY WHEN THE WATER MAIN IS LOCATED TOO CLOSE TO THE RIGHT-OF-WAY LINE TO USE THE FIRE HYDRANT ASSEMBLY DETAIL.
2. SEE STANDARD DETAIL UW-2 GATE VALVE, BOX, LID AND TAG.

MANATEE COUNTY PUBLIC WORKS DEPARTMENT		FIRE HYDRANT WITH LOCKED 90° BEND	UW-7
REV. BY	DATE		
February 25, 2020 DATE OF APPROVAL			

NOTES:

1. ALL DEAD-END WATER MAINS REQUIRE A BLOW-OFF AT THE END, WHETHER TEMPORARY OR PERMANENT.
2. BLOW-OFF VALVE ASSEMBLIES, METER BOXES, AND/OR AUTOMATED FLUSHING DEVICES SHALL NOT BE LOCATED IN DRIVEWAYS OR SIDEWALKS, AND SHALL BE INSTALLED AS CLOSE TO THE LOT LINES AS POSSIBLE.
3. DEAD-END PUBLIC MAINS, WITH MORE THAN A 4-DAY WATER VOLUME TURN-OVER RATE, SHALL REQUIRE A COUNTY-METERED, PRIVATELY OWNED & MAINTAINED AUTOMATIC FLUSHING SYSTEM TO BE INSTALLED WITH AN APPROVED METER BOX/LID, COUNTY METER, AND AN AUTOMATED FLUSHING DEVICE.
4. THE DEVELOPMENT SHALL FURNISH AND MAINTAIN THE FLUSHING DEVICE, INCLUDING ALL ASSOCIATED ITEMS. THE DEVELOPMENT SHALL COORDINATE WITH MANATEE COUNTY LABORATORY PERSONNEL TO ESTABLISH AN APPROVED FLUSHING PLAN TO MAINTAIN WATER QUALITY. ONCE WATER QUALITY CAN BE SUSTAINED BY THE PROPOSED DEVELOPMENT WATER USAGE, THE FLUSHING DEVICE AND ASSOCIATED ITEMS SHALL BE REMOVED. ALL COSTS ASSOCIATED WITH THE FLUSHED WATER SHALL BE THE RESPONSIBILITY OF THE DEVELOPMENT.
5. WHEN EXTENDING A WATER MAIN, REMOVE ALL ITEMS RELATING TO THE BLOW-OFF ASSEMBLY AND INSTALL A NEW GATE VALVE (SIZED FOR MAIN). ALL ITEMS SHALL BE RETURNED TO THE COUNTY, UNLESS OTHERWISE NOTED.

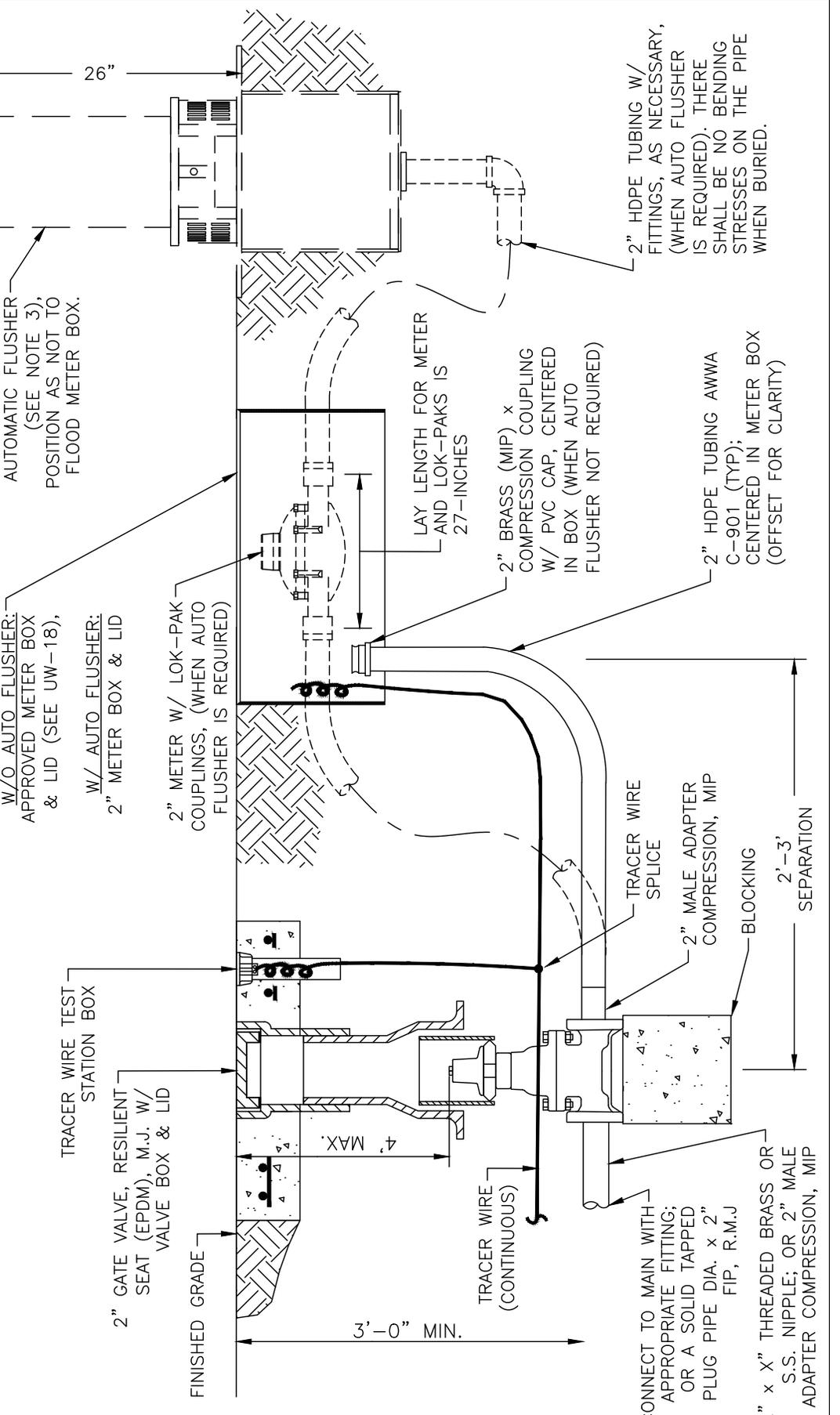

MANATEE COUNTY	
PUBLIC WORKS DEPARTMENT	
REV. BY	DATE
February 25, 2020	
DATE OF APPROVAL	

2" BLOW-OFF
ASSEMBLY

UW-08

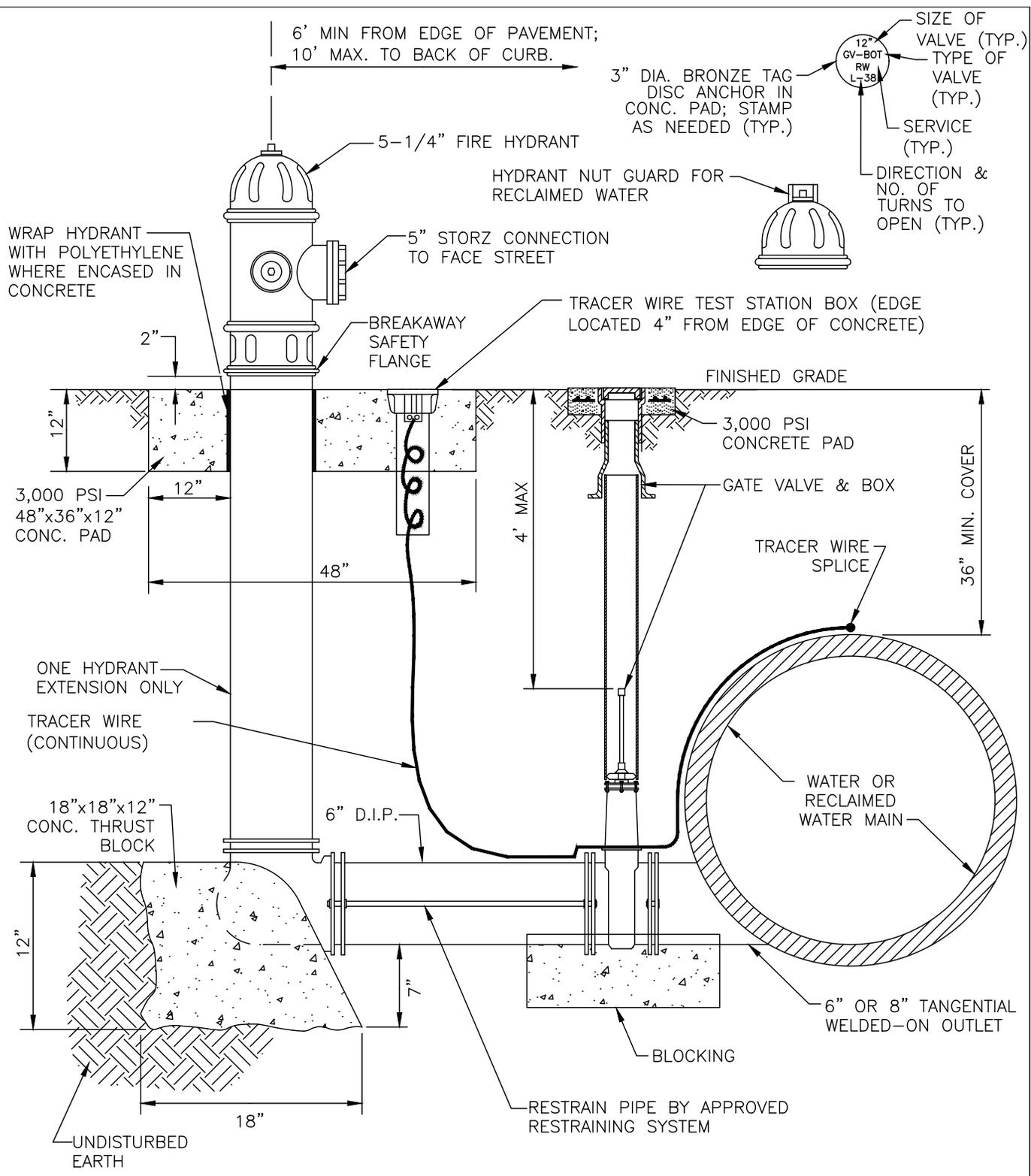

NOTES:

1. FIRE HYDRANT BLOW-OFF ASSEMBLY TO COMPLY WITH NOTES 1-15 OF DETAIL UW-5 FIRE HYDRANT ASSEMBLY DETAIL.
2. TYPICAL LOCATION FOR TANGENTIAL OUTLET IS AT LOW POINT ALONG THE MAIN WHERE SEDIMENTS ACCUMULATE.
3. SEE UW-2 GATE VALVE, BOX, LID AND TAG DETAIL.
4. BRASS TAG SHALL INDICATE FEED IS FROM THE BOTTOM OF THE MAIN, "B.O.T" (BLOW-OFF TANGENT)

MANATEE COUNTY PUBLIC WORKS DEPARTMENT		FIRE HYDRANT BLOW-OFF ASSEMBLY FOR 12" MAINS AND LARGER	UW-9
REV. BY	DATE		
February 25, 2020 DATE OF APPROVAL			

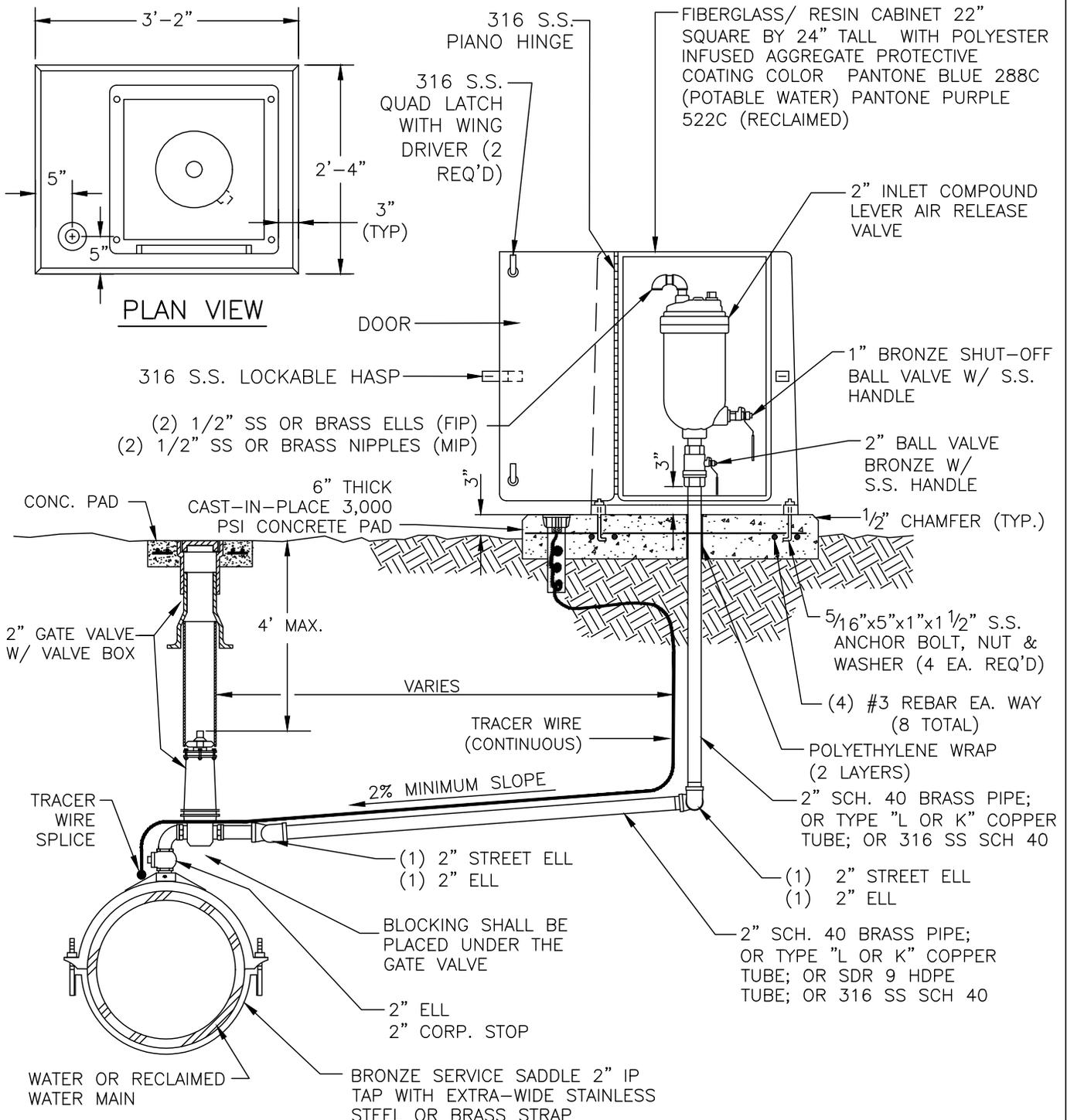

- NOTES:**
1. AIR RELEASE VALVES TO BE INSTALLED AT HIGH POINTS ALONG THE MAINS, WHERE ARE COULD BE TRAPPED.
 2. ARV VENT ORIFICE TO BE SIZED IN ACCORDANCE WITH MANUFACTURER'S RECOMMENDATION FOR WATER MAIN SIZE.
 3. ALL INCIDENTAL FITTINGS AND HARDWARE TO BE STAINLESS STEEL, BRASS OR COPPER.
 4. ALL PIPE THREADS TO BE SEALED AIR TIGHT.
 6. VENT PIPE TO BE LAID ACCURATELY ON SLOPE, WITHOUT HIGH OR LOW POINTS.
 7. ARV SHALL BE INSTALLED MINIMUM 6 FT FROM EDGE OF PAVEMENT; 10 FT MAXIMUM FROM BACK OF CURB; 4 FT MIN. MAY BE APPROVED BY UTILITIES IN SOME EXISTING AREAS.
 8. SEE UW-2 GATE VALVE, BOX, LID AND TAG STANDARD DETAIL. CENTERING COLLAR IS NOT REQUIRED ON 2" GATE VALVES.

MANATEE COUNTY PUBLIC WORKS DEPARTMENT		ABOVE-GROUND AIR RELEASE VALVE ASSY. FOR 16-INCH AND LARGER MAINS	UW-11
REV. BY	DATE		
February 25, 2020 DATE OF APPROVAL			

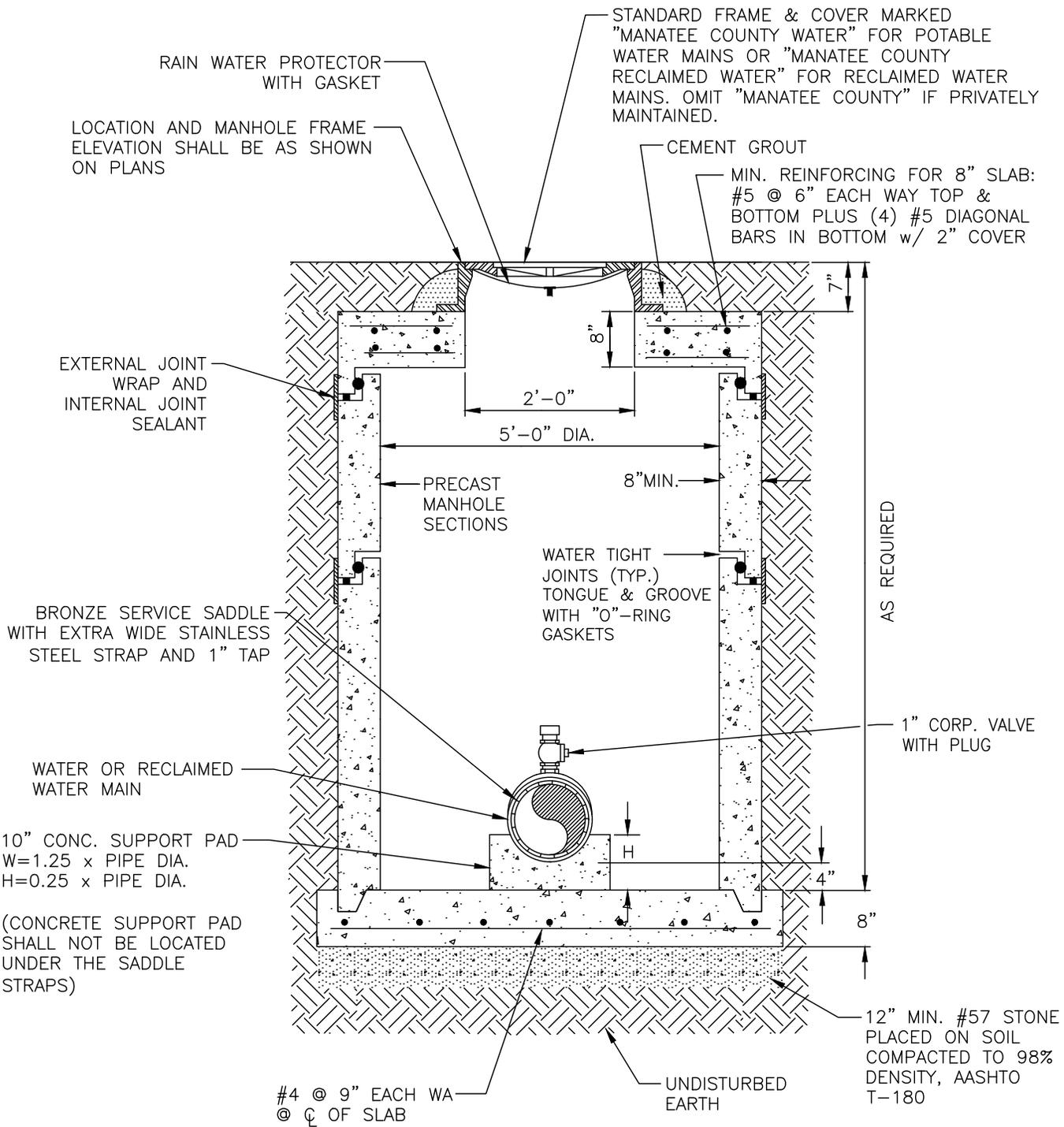

NOTES:

1. AUTOMATIC AIR RELEASE VALVES SHALL NOT BE INSTALLED BELOW GRADE.
2. SADDLE STRAPS, NUTS, BOLTS AND WASHERS TO BE 316 STAINLESS STEEL.
3. MANUALLY OPERATED AIR RELEASE VALVES ARE TO BE INSTALLED AT HIGH POINTS ALONG THE MAINS, WHERE AIR COULD BE TRAPPED.
4. ALL PIPE PENETRATING MANHOLE SHALL HAVE RESILIENT PIPE TO MANHOLE SEALS PER ASTM C-923.

MANATEE COUNTY
PUBLIC WORKS DEPARTMENT

BELOW GRADE
MANUALLY OPERATED
AIR RELEASE VALVE

UW-12

REV. BY	DATE

February 25, 2020
DATE OF APPROVAL

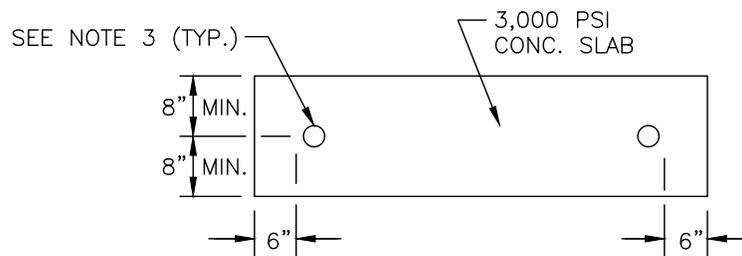
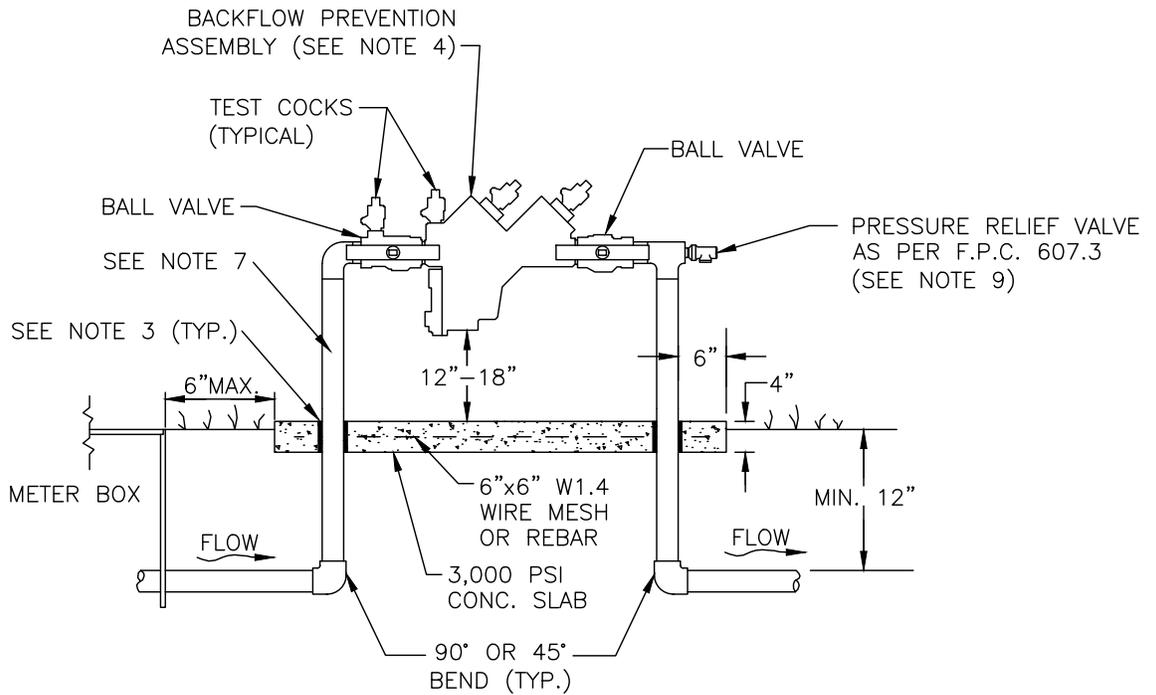

NOTES:

1. BACKFLOW PREVENTION ASSEMBLY MUST BE INSTALLED IMMEDIATELY DOWNSTREAM OF METER, AS SHOWN ABOVE
2. COPPER PIPE TYPE "L" (OR "K") OR BRASS PIPE MINIMUM SCHEDULE 40 SHALL BE USED TO A MINIMUM DEPTH OF 12" BELOW GRADE.
3. PIPES PASSING THROUGH CONCRETE SLAB SHALL BE PROPERLY PROTECTED; POLYETHYLENE WRAPPED OR PVC SLEEVED. COPPER SHALL NOT COME IN CONTACT WITH THE CONCRETE.
4. THE SYSTEM MUST MEET ALL REQUIREMENTS OF THE FLORIDA PLUMBING CODE (LATEST EDITION) AND CHAPTER 2-31, ARTICLE X OF THE MANATEE COUNTY CODE OF ORDINANCES.
5. ALL EXPOSED EDGES OF CONCRETE SHALL BE CHAMFERED 1/2".
6. BACKFLOW PREVENTER SHALL BE TESTED AT THE TIME OF INSTALLATION.
7. PRESSURE REDUCING VALVE IS REQUIRED UPSTREAM OF BACKFLOW PREVENTION ASSEMBLY, IF SYSTEM PRESSURE EXCEEDS 80 PSI.
8. 3' MINIMUM CLEARANCE FROM LANDSCAPING PLANTS AND 10' MIN. CLEARANCE FROM TREES TO EDGE OF CONCRETE SLAB AND CLEAR OPENING FOR ACCESS FROM STREET.
9. IN ADDITION TO THE PRV, THE BUILDING DEPT. MAY REQUIRE AN APPROVED DEVICE FOR THERMAL EXPANSION CONTROL DOWNSTREAM OF THE ASSEMBLY.
10. FITTINGS AND CONNECTIONS FOR ABOVE-GROUND INSTALLATIONS SHALL NOT ALLOW ANY MOVEMENT OR ROTATION OF BACKFLOW PREVENTION ASSEMBLY.
11. REFER TO DETAIL US-15 WATER METER & BACKFLOW PREVENTER FOR LIFT STATIONS FOR WATER SERVICE AT SEWAGE PUMPING STATION.
12. BACKFLOW PREVENTION ASSEMBLIES USED FOR POTABLE APPLICATIONS SHALL BE LEAD FREE AS DEFINED IN THE REDUCTION OF LEAD IN DRINKING WATER ACT, SECTION 1417 OF THE SAFE DRINKING WATER ACT, 42 U.S.C. 300g-6, AS MAY BE AMENDED, AND IN COMPLIANCE WITH ALL APPLICABLE REGULATIONS

MANATEE COUNTY PUBLIC WORKS DEPARTMENT		3/4" & 1" BACKFLOW PREVENTION ASSEMBLY	UW-13
REV. BY	DATE		
February 25, 2020 DATE OF APPROVAL			

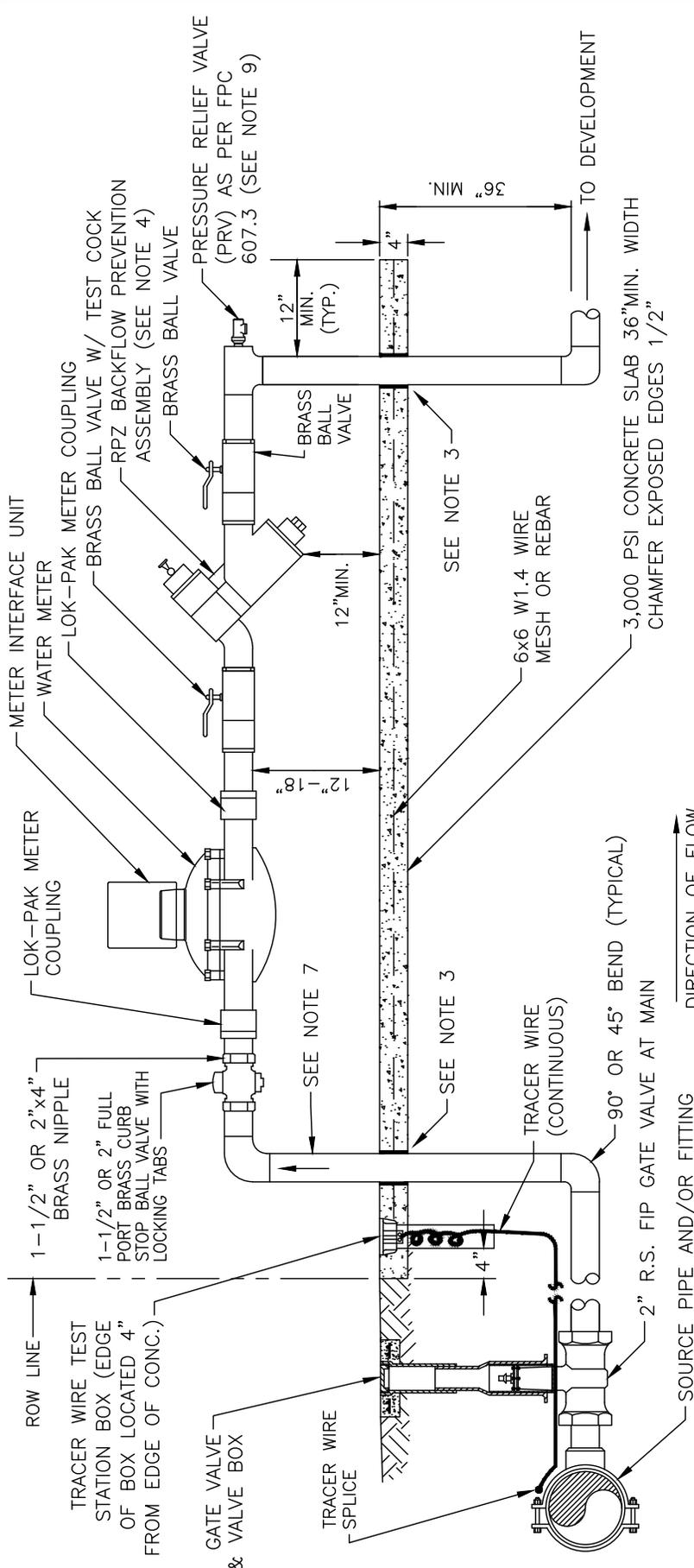

NOTES:

1. BACKFLOW PREVENTION ASSEMBLY MUST BE INSTALLED DOWNSTREAM OF METER, AS CLOSE TO METER AS POSSIBLE.
2. COPPER PIPE TYPE "L" (OR "K") OR BRASS PIPE MINIMUM SCHEDULE 40 SHALL BE USED TO A MINIMUM DEPTH OF 36" BELOW GRADE.
3. PIPES THROUGH SLAB AND ALL BELOW-GROUND D.I. PIPE AND FITTINGS SHALL BE POLYETHYLENE WRAPPED.
4. THE SYSTEM MUST MEET ALL REQUIREMENTS OF THE FLORIDA PLUMBING CODE (LATEST EDITION) AND CHAPTER 2-31, ARTICLE X OF THE MANATEE COUNTY CODE OF ORDINANCES.
5. METER, LOCK PACKS AND BRASS NIPPLES WILL BE PROVIDED BY MANATEE COUNTY. INSERT NIPPLES INTO LOCK PACKS HALF WAY.
6. DO NOT PAINT METER OR LOCK PACKS. ALL ABOVE GROUND PIPING SHALL BE PAINTED SAFETY BLUE BY SCOTT PAINT (POTABLE WATER) OR PANTONE PURPLE 522C (RECLAIMED WATER).
7. PRESSURE REDUCING VALVE IS REQUIRED UPSTREAM OF BACKFLOW PREVENTION ASSEMBLY, IF SYSTEM PRESSURE EXCEEDS 80 PSI.
8. 3' MINIMUM CLEARANCE FROM LANDSCAPING PLANTS AND 10' MIN. CLEARANCE FROM TREES TO EDGE OF CONCRETE SLAB AND CLEAR OPENING FOR ACCESS FROM STREET.
9. IN ADDITION TO THE PRV, THE BUILDING DEPT. MAY REQUIRE AN APPROVED DEVICE FOR THERMAL EXPANSION CONTROL DOWNSTREAM OF THE ASSEMBLY.
10. BACKFLOW PREVENTION ASSEMBLY IS ONLY REQUIRED ON RECLAIMED WATER LINE WHEN IRRIGATION SYSTEM INCLUDES CHEMICAL OR FERTILIZER INJECTION METHODS. WHEN BACKFLOW PREVENTION ASSEMBLY IS NOT REQUIRED, A 12" MINIMUM NIPPLE AND A BALL VALVE SHALL BE INSTALLED.
11. ALL ABOVE-GROUND ANCILLARY BOLTS, NUTS, WASHERS, & FASTENERS SHALL BE 316 STAINLESS STEEL. ALL BURIED SHALL BE MIN. 304 STAINLESS STEEL.
12. FITTINGS AND CONNECTION FOR ABOVE-GROUND INSTALLATIONS SHALL NOT ALLOW ANY MOVEMENT OR ROTATION OF THE BACKFLOW PREVENTION ASSEMBLIES.
13. SEE UW-2 GATE VALVE, BOX, LID AND TAG DETAIL. CENTERING COLLAR NOT REQUIRED ON 2" OR SMALLER VALVES.
14. BACKFLOW PREVENTION ASSEMBLIES USED FOR POTABLE APPLICATIONS SHALL BE LEAD FREE AS DEFINED IN THE REDUCTION OF LEAD IN DRINKING WATER ACT, SECTION 1417 OF THE SAFE DRINKING WATER ACT, 42 U.S.C. 300g-6, AS MAY BE AMENDED, AND IN COMPLIANCE WITH ALL APPLICABLE REGULATIONS.
15. FOR USE WHERE BACKFLOW PREVENTION ASSEMBLY IS REQUIRED WITH METER.
16. WHERE MULTIPLE METER AND BACKFLOW PREVENTION ASSEMBLIES ARE INSTALLED, A BELOW GRADE ISOLATION VALVE SHALL BE PROVIDED FOR EACH ASSEMBLY.

MANATEE COUNTY	
PUBLIC WORKS DEPARTMENT	
REV. BY	DATE
February 25, 2020	
DATE OF APPROVAL	

1 1/2" & 2" METER AND BACKFLOW PREVENTION ASSEMBLY

UW-14

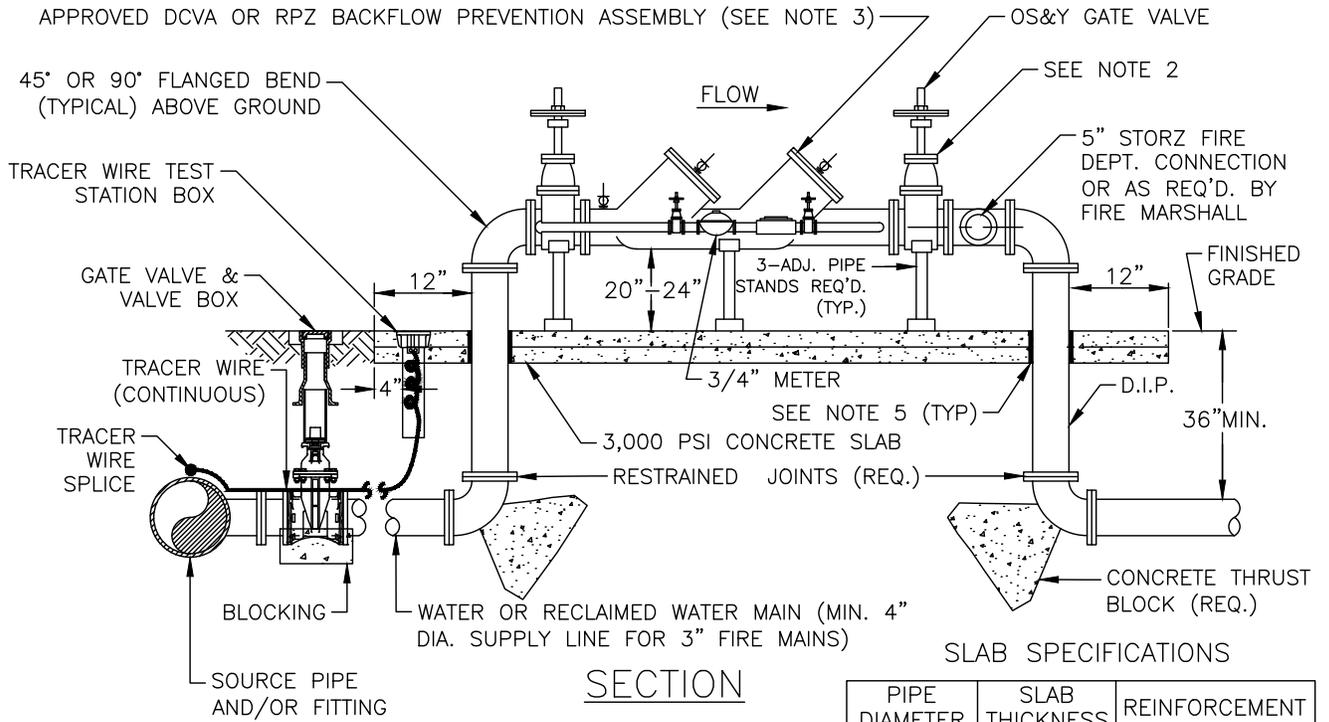
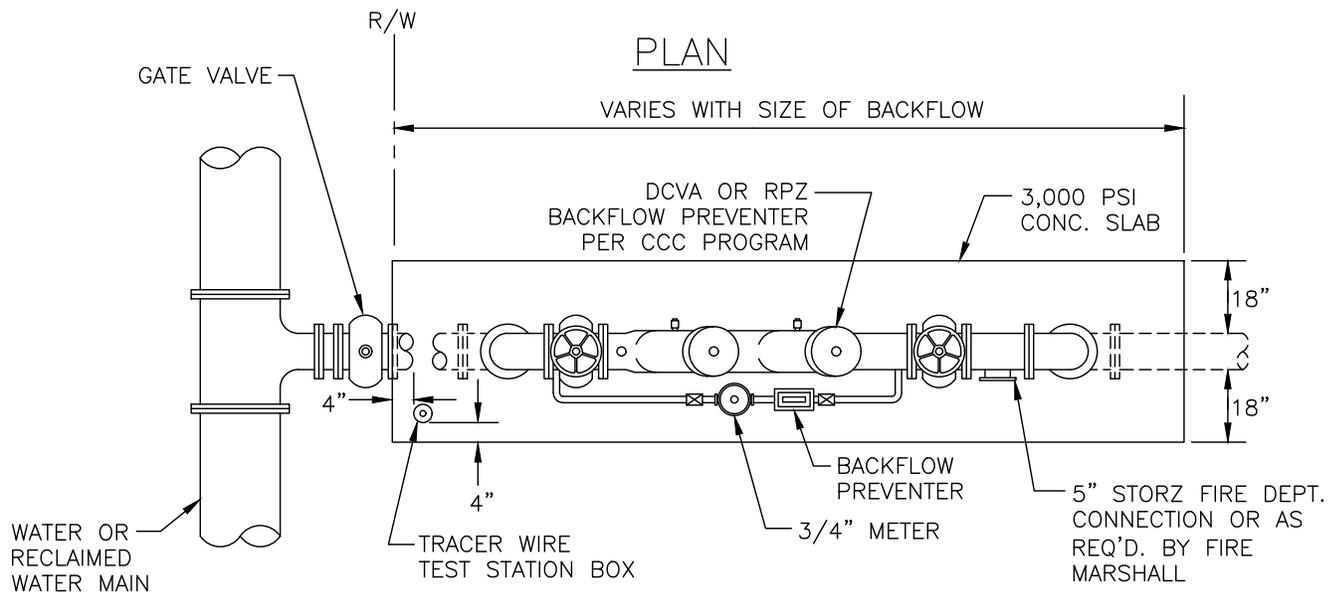

SLAB SPECIFICATIONS

PIPE DIAMETER	SLAB THICKNESS	REINFORCEMENT
2" TO 10"	4"	6x6 W1.4 WIRE MESH*
12" TO 18"	4"	6x6 W3 WIRE MESH*

* REBAR MAY BE USED.

NOTES:

- THIS DETAIL FOR FIRE PROTECTION ONLY.
- WHEN PRESSURE TESTING FIRE LINE, TEST AGAINST DOWNSTREAM GATE VALVE.
- THE SYSTEM MUST MEET ALL REQUIREMENTS OF THE FLORIDA PLUMBING CODE (LATEST EDITION), CHAPTER 2-31, ARTICLE X OF THE MANATEE COUNTY CODE OF ORDINANCES, AND THE MANATEE COUNTY FIRE MARSHALL REQUIREMENTS.
- ABOVE GROUND PIPING SHALL BE FLANGED DUCTILE IRON CLASS 53.
- PIPE THROUGH SLAB AND ALL BELOW-GROUND D.I. PIPE AND FITTINGS SHALL BE POLYETHYLENE WRAPPED.
- ALL EXPOSED EDGES OF CONCRETE SHALL HAVE 1/2" CHAMFER.
- THE EDGE OF THE CONCRETE SLAB SHALL BE 6 FEET MIN. FROM LANDSCAPE VEGETATION AND ABOVEGROUND OBJECTS; AND 10 FEET FROM TREES. STREET SIDE OF ASSEMBLY SHALL REMAIN OPEN.
- ALL ABOVE-GROUND ANCILLARY BOLTS, NUTS, WASHERS, & FASTENERS SHALL BE 316 STAINLESS STEEL. ALL BURIED SHALL BE MIN. 304 STAINLESS STEEL.
- SEE UW-2 GATE VALVE, BOX, LID AND TAG DETAIL.
- PIPE STANDS SHALL BE BOLTED TO SLAB.
- ABOVE GROUND PIPING SHALL BE PAINTED SAFETY RED
- REFER TO 1.1.1.C IN THE PUBLIC WORKS UTILITY STANDARDS MANUAL FOR FURTHER DETAILS.
- WHERE MULTIPLE AND BACKFLOW PREVENTION ASSEMBLIES ARE INSTALLED, A BELOW GRADE ISOLATION VALVE SHALL BE PROVIDED FOR EACH ASSEMBLY.

MANATEE COUNTY
PUBLIC WORKS DEPARTMENT

REV. BY	DATE
February 25, 2020	
DATE OF APPROVAL	

2" AND ABOVE FIRE
LINE BACKFLOW
PREVENTION
ASSEMBLY

UW-15

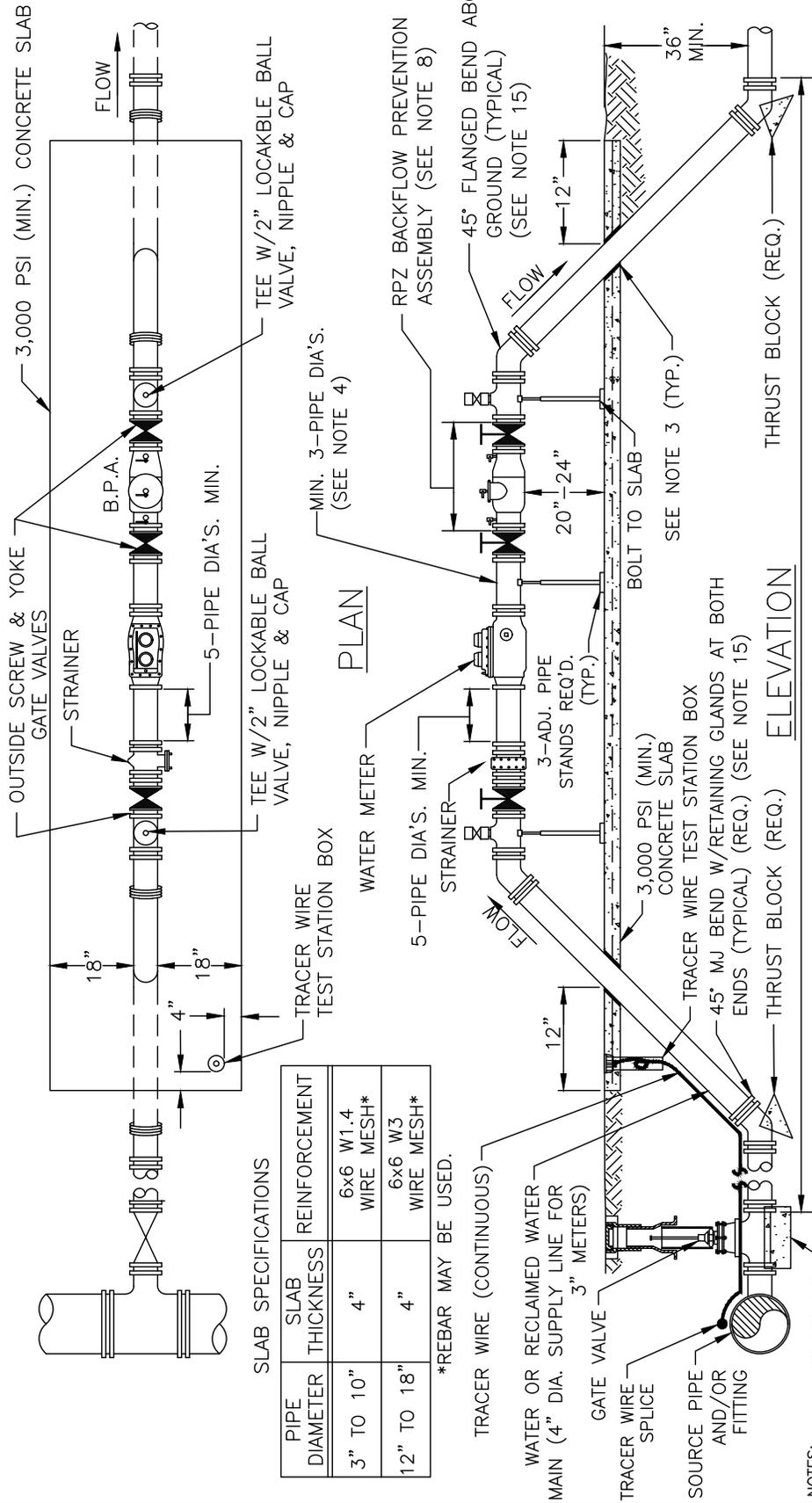

SLAB SPECIFICATIONS

PIPE DIAMETER	SLAB THICKNESS	REINFORCEMENT
3" TO 10"	4"	6x6 W1.4 WIRE MESH*
12" TO 18"	4"	6x6 W3 WIRE MESH*

*REBAR MAY BE USED.

NOTES:

1. ABOVE GROUND PIPING SHALL BE FLANGED DUCTILE IRON CLASS 53, PAINTED SAFETY BLUE BY SCOTT PAINT FOR POTABLE WATER OR PANTONE 522C FOR RECLAIMED WATER.
2. METER ASSEMBLY SHALL BE INSTALLED LEVEL AND PRESSURE TESTED AGAINST UPSTREAM GATE VALVE.
3. PIPE THROUGH SLAB AND ALL BELOW GROUND D.I. PIPE AND FITTINGS SHALL BE POLYETHYLENE WRAPPED.
4. TEE & 2" BALL VALVE (POINTING UP) RIGHT AFTER METER IS REQUIRED ON IRRIGATION TURBINE METERS. TEE IS NOT REQUIRED ON COMPOUND METERS.
5. FIRE SERVICE METER TO BE USED ONLY WHEN POTABLE WATER AND FIRE PROTECTION ARE SUPPLIED THROUGH A SINGLE POTABLE WATER LINE. SEE UW-16A 6"-10" FIRE/POTABLE COMBINATION METER.
6. ALL EXPOSED EDGES OF CONCRETE SHALL HAVE 1/2" CHAMFER.
7. THE EDGE OF THE CONCRETE SLAB SHALL BE 6 FEET MIN. FROM LANDSCAPE VEGETATION AND ABOVEGROUND OBJECTS; AND 10 FEET FROM TREES. STREET SIDE OF ASSEMBLY SHALL REMAIN OPEN.
8. A BACKFLOW PREVENTION ASSEMBLY IS NOT REQUIRED ON RECLAIMED WATER MASTER METER ASSEMBLY, EXCEPT WHERE FERTILIZER OR CHEMICAL INJECTION METHODS WILL BE IN USE. BACKFLOW PREVENTION ASSEMBLY SHALL MEET REQUIREMENTS OF CHAPTER 2-31, ARTICLE X OF THE MANATEE COUNTY CODE OF ORDINANCES.
9. ALL ABOVE-GROUND ANCILLARY BOLTS, NUTS, WASHERS, & FASTENERS SHALL BE 316 STAINLESS STEEL. ALL BURIED SHALL BE MIN. 304 STAINLESS STEEL.
10. BALL VALVES SHALL BE FULL PORT WITH LOCKING TABS.
11. COUNTY WILL PROVIDE STRAINER AND METER. ALL OTHER VALVES, PIPE, FITTINGS AND BACKFLOW PREVENTER TO BE PROVIDED BY SITE CONTRACTOR.
12. BACKFLOW PREVENTION ASSEMBLY USED FOR POTABLE APPLICATIONS SHALL BE LEAD FREE AS DEFINED IN THE REDUCTION OF LEAD IN DRINKING WATER ACT, SECTION 1417 OF THE SAFE DRINKING WATER ACT, 42 U.S.C. 300g-6, AS MAY BE AMENDED, AND IN COMPLIANCE WITH ALL APPLICABLE REGULATIONS.
13. REFER TO 1.1.1.C IN THE PUBLIC WORKS UTILITY STANDARDS MANUAL FOR FURTHER DETAILS.
14. WHERE MULTIPLE METER AND BACKFLOW PREVENTION ASSEMBLIES ARE INSTALLED, A BELOW GRADE ISOLATION VALVE SHALL BE PROVIDED FOR EACH ASSEMBLY.
15. SHOULD THERE BE INSUFFICIENT ROOM TO INSTALL THE METER ASSEMBLY, 90° BENDS AND TEES MAY BE USED AS SHOWN IN UW-17 REPLACEMENT FOR 3" AND ABOVE MASTER METER

MANATEE COUNTY
PUBLIC WORKS DEPARTMENT

REV. BY	DATE

February 25, 2020
DATE OF APPROVAL

3" AND ABOVE
MASTER METER

UW-16

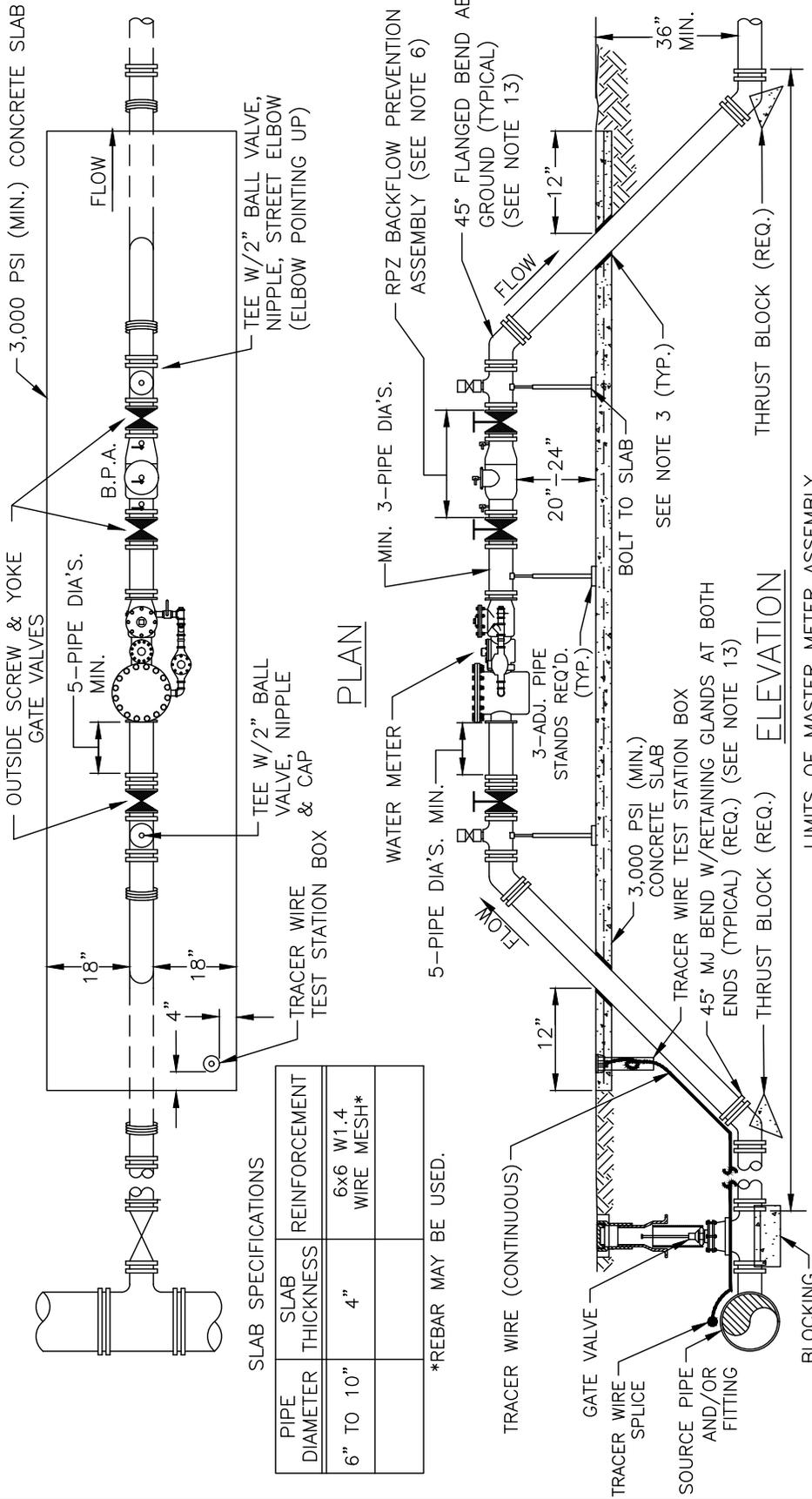

SLAB SPECIFICATIONS

PIPE DIAMETER	SLAB THICKNESS	REINFORCEMENT
6" TO 10"	4"	6x6 W1.4 WIRE MESH*

*REBAR MAY BE USED.

- NOTES:
- ABOVE GROUND PIPING SHALL BE FLANGED DUCTILE IRON CLASS 53, PAINTED SAFETY BLUE BY SCOTT PAINT FOR POTABLE WATER OR PANTONE 522C FOR RECLAIMED WATER.
 - METER ASSEMBLY SHALL BE INSTALLED LEVEL AND PRESSURE TESTED AGAINST UPSTREAM GATE VALVE.
 - PIPE THROUGH SLAB AND ALL BELOW GROUND D.I. PIPE AND FITTINGS SHALL BE POLYETHYLENE WRAPPED.
 - ALL EXPOSED EDGES OF CONCRETE SHALL HAVE 1/2" CHAMFER.
 - THE EDGE OF THE CONCRETE SLAB SHALL BE 6 FEET MIN. FROM LANDSCAPE VEGETATION AND ABOVEGROUND OBJECTS; AND 10 FEET FROM TREES. STREET SIDE OF ASSEMBLY SHALL REMAIN OPEN.
 - A BACKFLOW PREVENTION ASSEMBLY IS NOT REQUIRED ON RECLAIMED WATER MASTER METER ASSEMBLY, EXCEPT WHERE FERTILIZER OR CHEMICAL INJECTION METHODS WILL BE IN USE. BACKFLOW PREVENTION ASSEMBLY SHALL MEET REQUIREMENTS OF CHAPTER 2-31, ARTICLE X OF THE MANATEE COUNTY CODE OF ORDINANCES.
 - ALL ABOVE-GROUND ANCILLARY BOLTS, NUTS, WASHERS, & FASTENERS SHALL BE 316 STAINLESS STEEL. ALL BURIED SHALL BE MIN. 304 STAINLESS STEEL.
 - BALL VALVES SHALL BE FULL PORT WITH LOCKING TABS.
 - COUNTY WILL PROVIDE METER. ALL OTHER VALVES, PIPE, FITTINGS AND BACKFLOW PREVENTER TO BE PROVIDED BY SITE CONTRACTOR.
 - BACKFLOW PREVENTION ASSEMBLY USED FOR POTABLE APPLICATIONS SHALL BE LEAD FREE AS DEFINED IN THE REDUCTION OF LEAD IN DRINKING WATER ACT, SECTION 1417 OF THE SAFE DRINKING WATER ACT, 42 U.S.C. 300g-6, AS MAY BE AMENDED, AND IN COMPLIANCE WITH ALL APPLICABLE REGULATIONS.
 - REFER TO 1.1.1.c IN THE PUBLIC WORKS UTILITY STANDARDS MANUAL FOR FURTHER DETAILS.
 - WHERE MULTIPLE METER AND BACKFLOW PREVENTION ASSEMBLIES ARE INSTALLED, A BELOW GRADE ISOLATION VALVE SHALL BE PROVIDED FOR EACH ASSEMBLY.
 - SHOULD THERE BE INSUFFICIENT ROOM TO INSTALL THE METER ASSEMBLY, 90° BENDS AND TEES MAY BE USED AS SHOWN IN UW-17A REPLACEMENT FOR 3" AND ABOVE MASTER METER.

MANATEE COUNTY
PUBLIC WORKS DEPARTMENT

REV. BY	DATE
February 25, 2020	
DATE OF APPROVAL	

6" - 10" MASTER
FIRE/POTABLE
COMBINATION METER

UW-16A

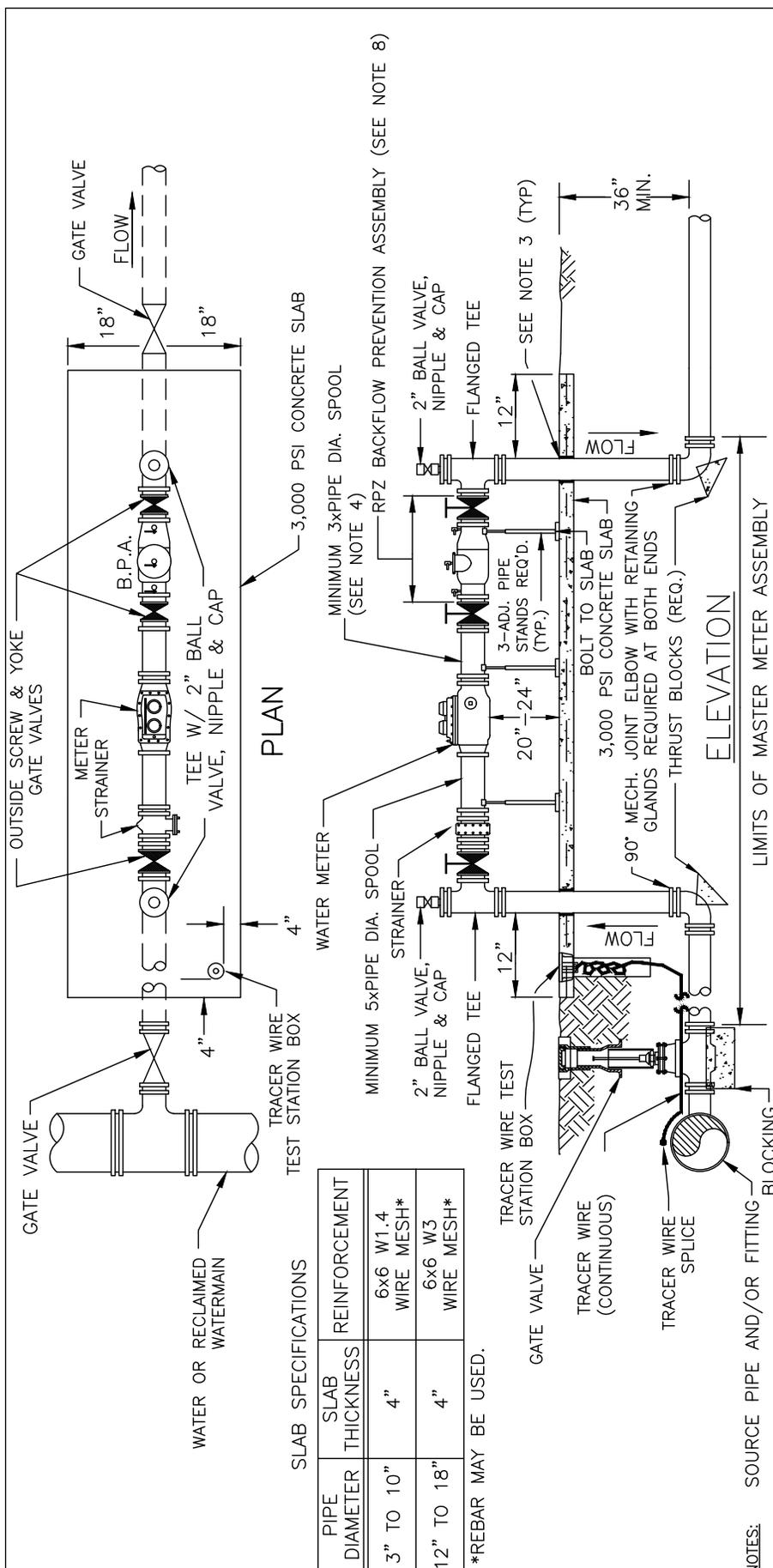

SLAB SPECIFICATIONS

PIPE DIAMETER	SLAB THICKNESS	REINFORCEMENT
3" TO 10"	4"	6x6 W1.4 WIRE MESH*
12" TO 18"	4"	6x6 W3 WIRE MESH*

*REBAR MAY BE USED.

NOTES: SOURCE PIPE AND/OR FITTING

1. ABOVE GROUND PIPING SHALL BE FLANGED DUCTILE IRON CLASS 53, PAINTED SAFETY BLUE BY SCOTT PAINT FOR POTABLE WATER OR PANTONE 522C PURPLE FOR RECLAIMED WATER.
2. METER ASSEMBLY SHALL BE INSTALLED LEVEL AND PRESSURE TESTED AGAINST UPSTREAM GATE VALVE.
3. PIPE THROUGH SLAB AND ALL BELOW GROUND D.I. PIPE AND FITTINGS SHALL BE POLYETHYLENE WRAPPED.
4. TEE & 2" BALL VALVE (POINTING UP) RIGHT AFTER METER IS REQUIRED ON IRRIGATION TURBINE METERS. TEE IS NOT REQUIRED ON COMPOUND METERS.
5. FIRE SERVICE METER TO BE USED ONLY WHEN POTABLE WATER AND FIRE PROTECTION ARE SUPPLIED THROUGH A SINGLE POTABLE WATER LINE. SEE UW-17A REPLACEMENT FOR 6"-10" FIRE/POTABLE COMBINATION METER.
6. ALL EXPOSED EDGES OF CONCRETE SHALL HAVE 1/2" CHAMFER.
7. THE EDGE OF THE CONCRETE SLAB SHALL BE 6 FEET MIN. FROM LANDSCAPE VEGETATION AND ABOVEGROUND OBJECTS; AND 10 FEET FROM TREES. STREET SIDE OF ASSEMBLY SHALL REMAIN OPEN.
8. BACKFLOW PREVENTER IS NOT REQUIRED ON RECLAIMED WATER MASTER METER ASSEMBLY, EXCEPT WHERE FERTILIZER OR CHEMICAL INJECTION METHODS WILL BE IN USE. WHEN BACKFLOW PREVENTION ASSEMBLY IS NOT REQUIRED, A SPOOL PIECE OF SAME LAY LENGTH AND AN OS&Y VALVE SHALL BE INSTALLED. BACKFLOW PREVENTION ASSEMBLIES SHALL MEET REQUIREMENTS OF CHAPTER 2-31, ARTICLE X OF THE MANATEE COUNTY CODE OF ORDINANCES.
9. ALL ABOVE-GROUND ANCILLARY BOLTS, NUTS, WASHERS, & FASTENERS SHALL BE 316 STAINLESS STEEL. ALL BURIED SHALL BE MIN. 304 STAINLESS STEEL.
10. BALL VALVES SHALL BE FULL PORT WITH LOCKING TABS.
11. COUNTY WILL PROVIDE STRAINER AND METER. ALL OTHER VALVES, PIPE, FITTINGS AND BACKFLOW PREVENTER TO BE PROVIDED BY SITE CONTRACTOR.
12. BACKFLOW PREVENTION ASSEMBLIES USED FOR POTABLE APPLICATIONS SHALL BE LEAD FREE AS DEFINED IN THE REDUCTION OF LEAD IN DRINKING WATER ACT, SECTION 1417 OF THE SAFE DRINKING WATER ACT, 42 U.S.C. 3009-6, AS MAY BE AMENDED, AND IN COMPLIANCE WITH ALL APPLICABLE REGULATIONS.
13. REFER TO 1.1.1.C IN THE PUBLIC WORKS UTILITY STANDARDS MANUAL FOR FURTHER DETAILS.
14. WHERE MULTIPLE METER AND BACKFLOW PREVENTION ASSEMBLIES ARE INSTALLED, A BELOW GRADE ISOLATION VALVE SHALL BE PROVIDED FOR EACH ASSEMBLY.
15. TRACER WIRE TEST STATION BOX NOT REQUIRED FOR REPLACEMENT MASTER METER IF THE EXISTING PIPING TO THE EXISTING METER ASSEMBLY DID NOT HAVE A TRACER WIRE.

MANATEE COUNTY
PUBLIC WORKS DEPARTMENT

REV. BY	DATE

February 25, 2020
DATE OF APPROVAL

REPLACEMENT FOR
3" AND ABOVE
MASTER METER

UW-17

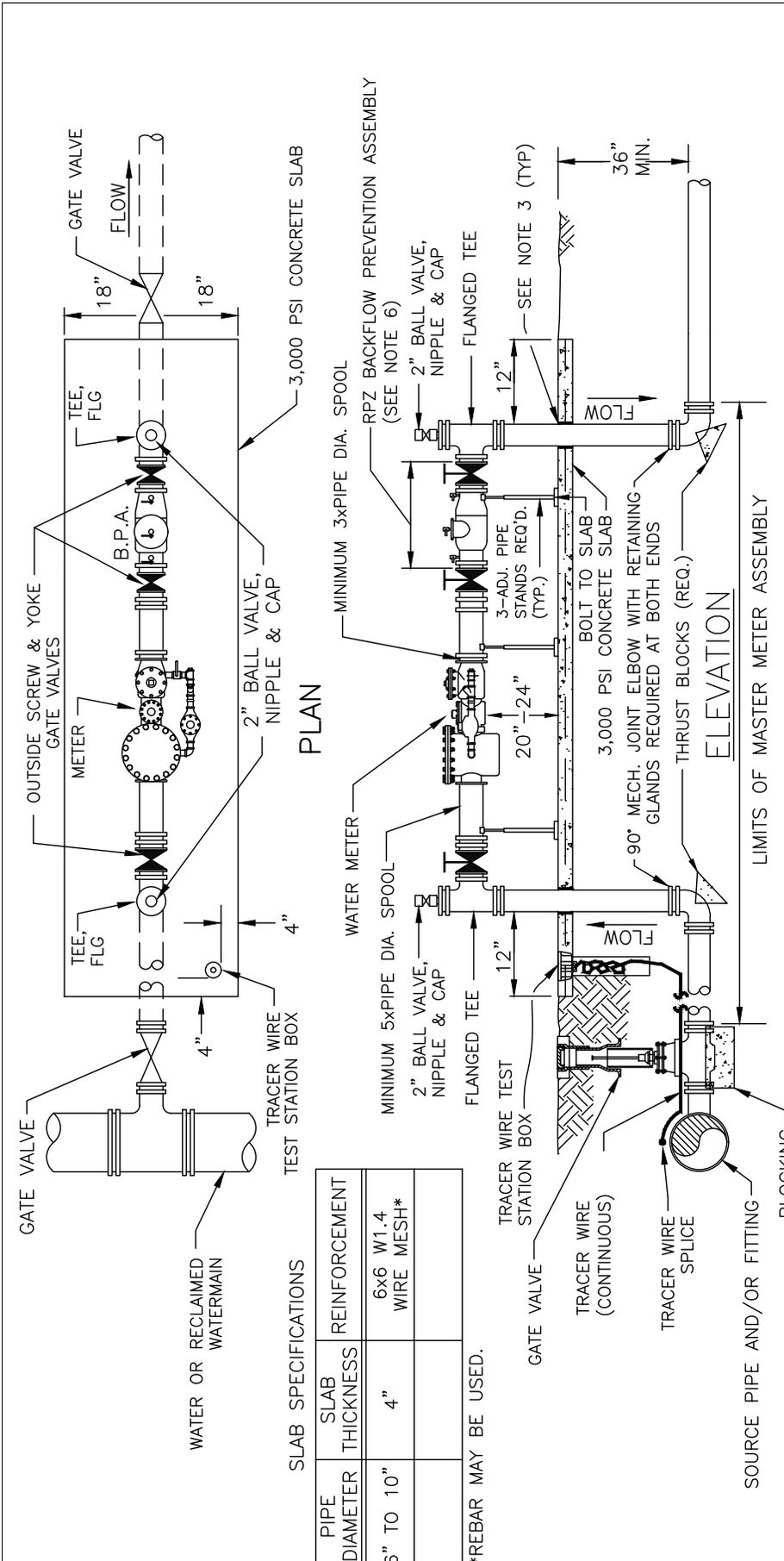

SLAB SPECIFICATIONS

PIPE DIAMETER	SLAB THICKNESS	REINFORCEMENT
6" TO 10"	4"	6x6 W1.4 WIRE MESH*

*REBAR MAY BE USED.

NOTES:

- ABOVE GROUND PIPING SHALL BE FLANGED DUCTILE IRON CLASS 53, PAINTED SAFETY BLUE BY SCOTT PAINT FOR POTABLE WATER OR PANTONE 522C PURPLE FOR RECLAIMED WATER.
- METER ASSEMBLY SHALL BE INSTALLED LEVEL AND PRESSURE TESTED AGAINST UPSTREAM GATE VALVE.
- PIPE THROUGH SLAB AND ALL BELOW GROUND D.I. PIPE AND FITTINGS SHALL BE POLYETHYLENE WRAPPED.
- ALL EXPOSED EDGES OF CONCRETE SHALL HAVE 1/2" CHAMFER.
- THE EDGE OF THE CONCRETE SLAB SHALL BE 6 FEET MIN. FROM LANDSCAPE VEGETATION AND ABOVEGROUND OBJECTS; AND 10 FEET FROM TREES. STREET SIDE OF ASSEMBLY SHALL REMAIN OPEN.
- BACKFLOW PREVENTER IS NOT REQUIRED ON RECLAIMED WATER MASTER METER ASSEMBLY, EXCEPT WHERE FERTILIZER OR CHEMICAL INJECTION METHODS WILL BE IN USE. WHEN BACKFLOW PREVENTION ASSEMBLY IS NOT REQUIRED, A SPOOL PIECE OF SAME LAY LENGTH AND AN OS&Y VALVE SHALL BE INSTALLED. BACKFLOW PREVENTION ASSEMBLIES SHALL MEET REQUIREMENTS OF CHAPTER 2-31, ARTICLE X OF THE MANATEE COUNTY CODE OF ORDINANCES.
- ALL ABOVE-GROUND ANCILLARY BOLTS, NUTS, WASHERS, & FASTENERS SHALL BE 316 STAINLESS STEEL. ALL BURIED SHALL BE MIN. 304 STAINLESS STEEL.
- BALL VALVES SHALL BE FULL PORT WITH LOCKING TABS.
- COUNTY WILL PROVIDE METER. ALL OTHER VALVES, PIPE, FITTINGS AND BACKFLOW PREVENTER TO BE PROVIDED BY SITE CONTRACTOR.
- BACKFLOW PREVENTION ASSEMBLIES USED FOR POTABLE APPLICATIONS SHALL BE LEAD FREE AS DEFINED IN THE REDUCTION OF LEAD IN DRINKING WATER ACT, SECTION 1417 OF THE SAFE DRINKING WATER ACT, 42 U.S.C. 300g-6, AS MAY BE AMENDED, AND IN COMPLIANCE WITH ALL APPLICABLE REGULATIONS.
- REFER TO 1.1.1.C IN THE PUBLIC WORKS UTILITY STANDARDS MANUAL FOR FURTHER DETAILS.
- WHERE MULTIPLE METER AND BACKFLOW PREVENTION ASSEMBLIES ARE INSTALLED, A BELOW GRADE ISOLATION VALVE SHALL BE PROVIDED FOR EACH ASSEMBLY.
- TRACER WIRE TEST STATION BOX NOT REQUIRED FOR REPLACEMENT MASTER METER IF THE EXISTING PIPING TO THE EXISTING METER ASSEMBLY DID NOT HAVE A TRACER WIRE.

MANATEE COUNTY
PUBLIC WORKS DEPARTMENT

REV. BY	DATE
February 25, 2020	
DATE OF APPROVAL	

REPLACEMENT FOR
6" - 10" MASTER
FIRE/POTABLE
COMBINATION METER

UW-17A

CAST IRON OVAL METER BOX, PAINTED BLUE AND MARKED "WATER METER" FOR POTABLE WATER OR PURPLE (PANTONE 522C) FOR RECLAIMED WATER AND MARKED "RECLAIMED METER"

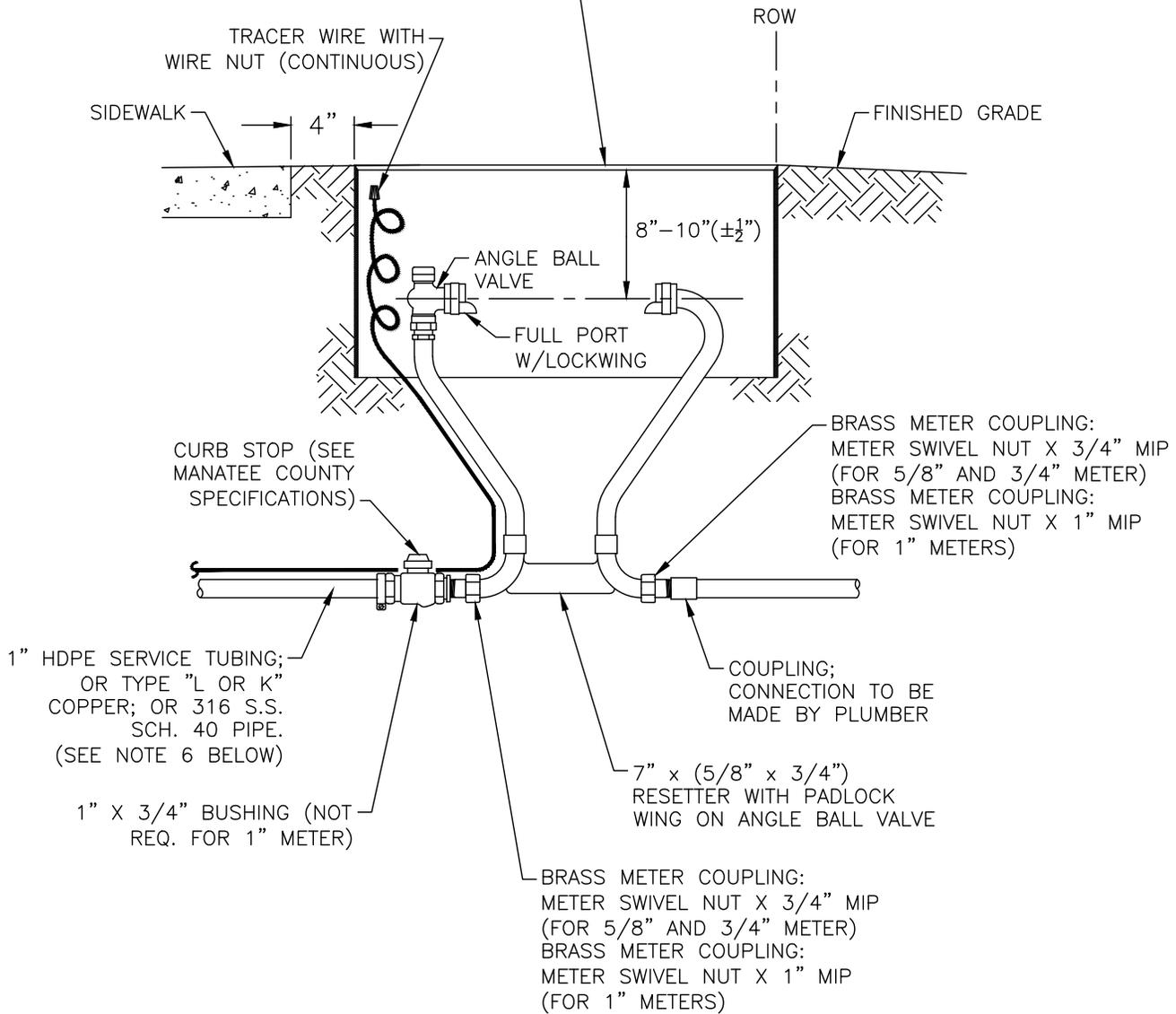

NOTES:

1. METER BOX AND RESETTER ARE TO BE INSTALLED BY THE INFRASTRUCTURE CONTRACTOR AND SHALL NOT BE SET IN DRAINAGE SWALES, SIDEWALKS OR DRIVEWAYS. WITH PRIOR APPROVAL BY COUNTY, METER BOXES WITH LOCKABLE LIDS MAY BE LOCATED IN SIDEWALKS.
2. THE METER RESETTER SHALL BE INSTALLED IN SUCH A MANNER AS TO ALLOW REMOVAL AND REPLACEMENT WITHOUT DISTURBING THE STRUCTURAL INTEGRITY OF THE PIPING SYSTEM, THE SHUTOFF VALVES, OR THE RESETTER.
3. FOR COMPLETE SERVICE CONNECTION ASSEMBLY, SEE DETAIL UW-21 TYPICAL SERVICE CONNECTION.
4. WHEN THE DISTANCE BETWEEN THE EDGE OF THE SIDEWALK AND THE R/W IS ONE FOOT (CUL-DE-SAC W/ MEDIAN) A 10-FOOT-WIDE PUBLIC UTILITY EASEMENT SHALL BE LOCATED IN THE FRONT OF THE LOTS, ADJACENT TO THE ROW.
5. 3' MINIMUM CLEARANCE FROM LANDSCAPING PLANTS AND 10' MIN. CLEARANCE FROM TREES TO EDGE OF METER, CLEAR ACCESS OPENING TO STREET.
6. SERVICE TUBING SHALL NOT BE CRIMPED OR KINKED TO RE-ADJUST CURB STOP LOCATION.

MANATEE COUNTY PUBLIC WORKS DEPARTMENT		METER BOX ASSEMBLY FOR 5/8" X 3/4"; 3/4"; AND 1" METERS	UW-18
REV. BY	DATE		
	February 25, 2020		
	DATE OF APPROVAL		

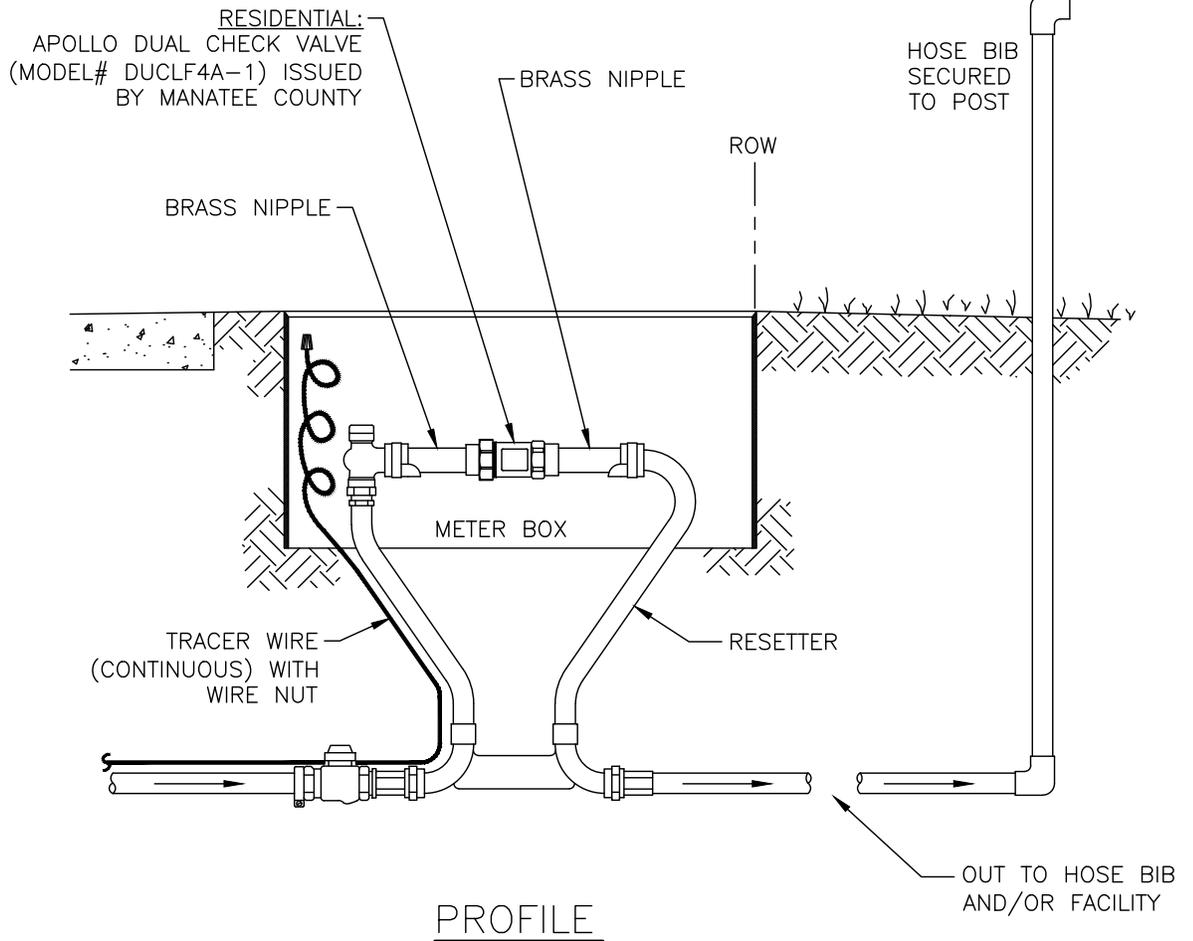

NOTES:

SEC. 2-31-253 – GENERAL REQUIREMENTS

(a) DIRECT CONNECTION.

- (1) THE BOARD MAY ADOPT, BY REGULATION, FEES AND CHARGES FOR DIRECT CONNECTION, INCLUDING, BUT NOT LIMITED TO, AN INITIAL PERIOD AND ANY ADDITIONAL PERIODS.
- (2) DURING CONSTRUCTION OF NEW SINGLE-FAMILY RESIDENCES, CONTRACTORS SHALL BE REQUIRED TO USE POTABLE WATER THROUGH UNMETERED DIRECT CONNECTION TO POTABLE WATER DISTRIBUTION LINES. EXCEPTIONS TO THE REQUIREMENT FOR DIRECT CONNECTION MAY BE GRANTED BY THE COUNTY ADMINISTRATOR FOR GOOD CAUSE SHOWN.
- (3) AN APPROVED BACKFLOW PREVENTION ASSEMBLY SHALL BE INSTALLED PRIOR TO ANY DIRECT CONNECTION.
- (4) A DIRECT CONNECTION SHALL CONTINUE UNTIL INSTALLATION OF A PERMANENT METER AND ISSUANCE OF A CERTIFICATE OF OCCUPANCY FOR THE RESIDENCE. THE PERMANENT METER SHALL NOT BE INSTALLED UNTIL THE RESIDENCE IS READY FOR THE METER AND ALL REQUIRED FEES AND CHARGES ARE PAID. IF A PERMANENT METER IS NOT INSTALLED WITHIN ONE YEAR FROM THE COMMENCEMENT DATE OF A DIRECT CONNECTION, INSPECTION OF THE DIRECT CONNECTION BY THE COUNTY IS REQUIRED PRIOR TO EXTENSION FOR ANY ADDITIONAL PERIOD. AT THE DISCRETION OF THE COUNTY ADMINISTRATOR, A DIRECT CONNECTION MAY BE EXTENDED FOR ADDITIONAL PERIODS UNTIL THE RESIDENCE MEETS THE REQUIREMENTS OF THE PARAGRAPH.
- (5) CONTRACTOR SHALL CONTACT UTILITY CUSTOMER SERVICE, 4410 66TH STREET WEST, BRADENTON, FL 34210, 941.792.8811 FOR DUAL CHECK VALVE ISSUANCE.

MANATEE COUNTY PUBLIC WORKS DEPARTMENT		TEMPORARY RESIDENTIAL DIRECT CONNECTION	UW-19
REV. BY	DATE		
		<u>February 25, 2020</u> DATE OF APPROVAL	

BRASS DISC (1" MIN. DIA.) INDICATING UNIT NUMBER OR ADDRESS SHALL BE INSTALLED AT EACH WATER METER BY DEVELOPER/APPLICANT. THE BRASS DISC SHALL BE HUNG FROM THE RESETTER.

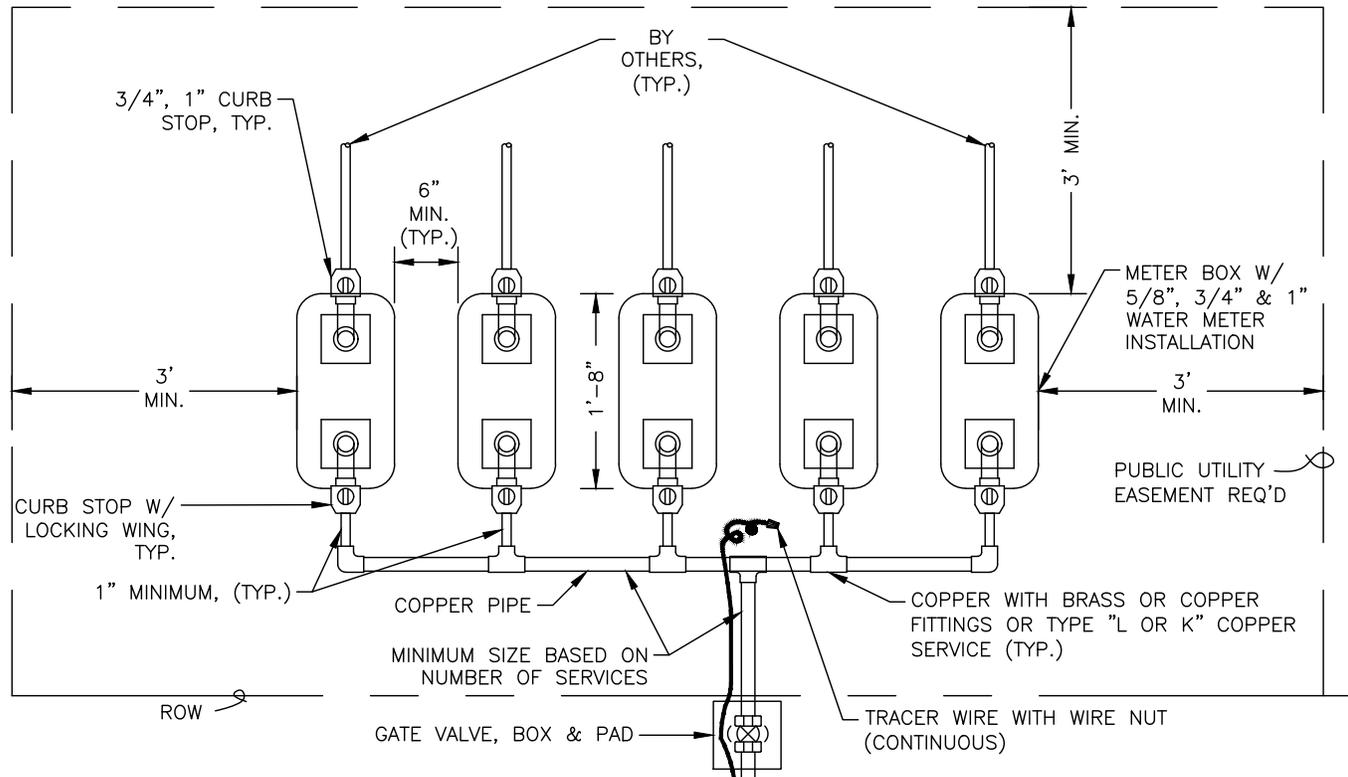
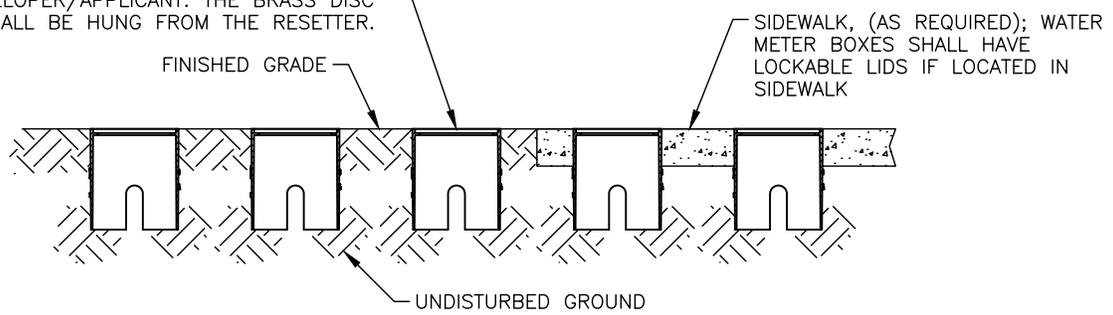

SERVICE PIPE SHALL BE POLYETHYLENE MEETING AWWA C-901 HDPE; OR TYPE ("K" OR "L") COPPER; OR STAINLESS STEEL SCHEDULE 40 PIPE. PIPE SHALL BE BLUE OR ENCASED IN A BLUE SLEEVE FOR POTABLE; PURPLE OR ENCASED IN A PURPLE SLEEVE FOR RECLAIMED WATER.

- NOTES:**
1. A PUBLIC UTILITY EASEMENT IS REQUIRED FOR METER READING AND MAINTENANCE.
 2. BACKFLOW PREVENTION ASSEMBLIES MAY BE REQUIRED DOWNSTREAM OF METERS. IF BACKFLOW PREVENTION ASSEMBLIES ARE REQUIRED, THE BACKFLOW PREVENTION ASSEMBLIES SHALL BE LOCATED OUTSIDE OF THE UTILITY EASEMENT.

MANATEE COUNTY PUBLIC WORKS DEPARTMENT	
REV. BY	DATE
February 25, 2020 DATE OF APPROVAL	

MULTIPLE METER LAYOUT

UW-20

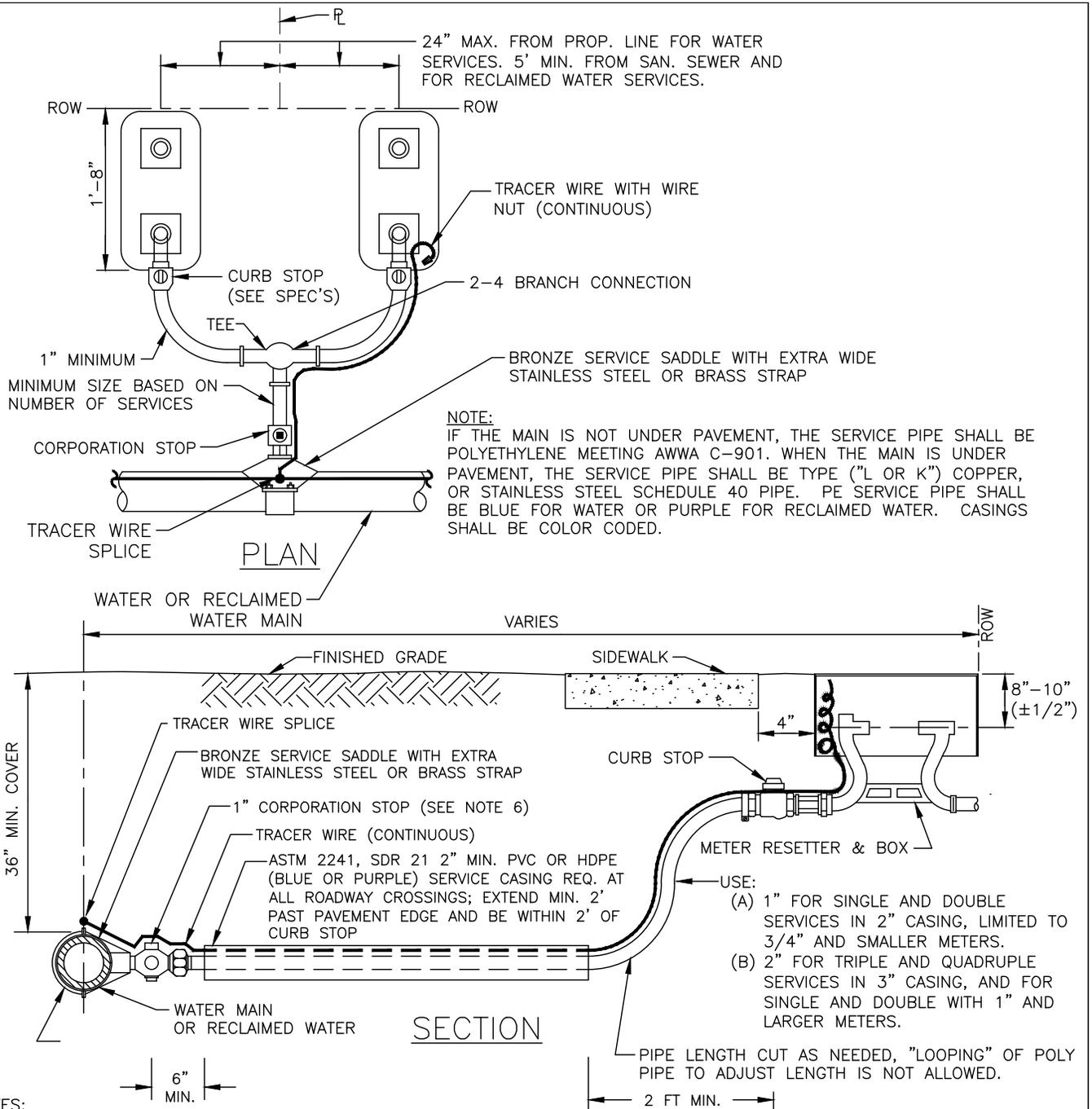

NOTES:

1. ALL SERVICE TAPS TO BE LOCATED IN THE FIELD. TAPS SHALL BE NO CLOSER THAN 2'-0" STAGGERED INTERVALS OR WITHIN 2'-0" FROM BELL OR SPIGOT ENDS.
2. METER BOXES & RESETTERS ARE TO BE INSTALLED BY THE INFRASTRUCTURE CONTRACTOR AND SHALL NOT BE SET IN DRAINAGE SWALES, SIDEWALKS OR DRIVEWAYS. WITH PRIOR APPROVAL BY COUNTY, METER BOXES WITH LOCKABLE LIDS MAY BE LOCATED IN SIDEWALKS.
3. "WM" OR "RWM" TO BE IMPRESSED INTO THE NEWLY POURED CONCRETE CURB ALONG WITH DISTANCE IN FEET TO THE METER. IF NO CURB, INSTALL A BLUE DISC WITH "WM" OR A PURPLE DISC WITH "RWM" AND A 1/8"x 1" GALVANIZED STEEL SCREW IN THE EDGE OF PAVEMENT WITH THE DISTANCE (IN FEET) FROM THE DISC TO THE METER.
4. COLOR CODED TRACER WIRE SHALL BE INSTALLED WITH WATER AND RECLAIMED MAIN AND ALL SERVICES. SERVICE WIRE SHALL BE CONNECTED TO THE TRACER WIRE ALONG THE MAIN. ON DOUBLE SERVICES, WHEN SECOND METER IS OVER 8 FT APART, TWO TRACER WIRES SHALL BE INSTALLED; ONE FOR EACH METER.
5. WATER AND RECLAIMED WATER SERVICE LINES TO BE 5' MINIMUM FROM SEWER SERVICE PIPES.
6. FOR 2" SERVICES REPLACE CORPORATION STOP WITH 2" RESILIENT WEDGE FIP GATE VALVE W/BOX, LID & TAG.
7. WHEN THE DISTANCE BETWEEN THE EDGE OF THE SIDEWALK AND THE ROW IS ONE FOOT (CUL-DE-SAC W/MEDIAN) A 10-FOOT-WIDE PUBLIC UTILITY EASEMENT SHALL BE LOCATED IN THE FRONT OF THE LOTS, ADJACENT TO THE ROW.
8. TEMPORARY RESIDENTIAL USE CAN BE PROVIDED BY CONTACTING THE UTILITY CUSTOMER SERVICE. SEE DETAIL UW-19.
9. SERVICE TUBING SHALL NOT BE CRIMPED OR KINKED TO RE-ADJUST CURB STOP LOCATION.

MANATEE COUNTY		TYPICAL SERVICE CONNECTION	UW-21
PUBLIC WORKS DEPARTMENT			
REV. BY	DATE		
		February 25, 2020	
		DATE OF APPROVAL	

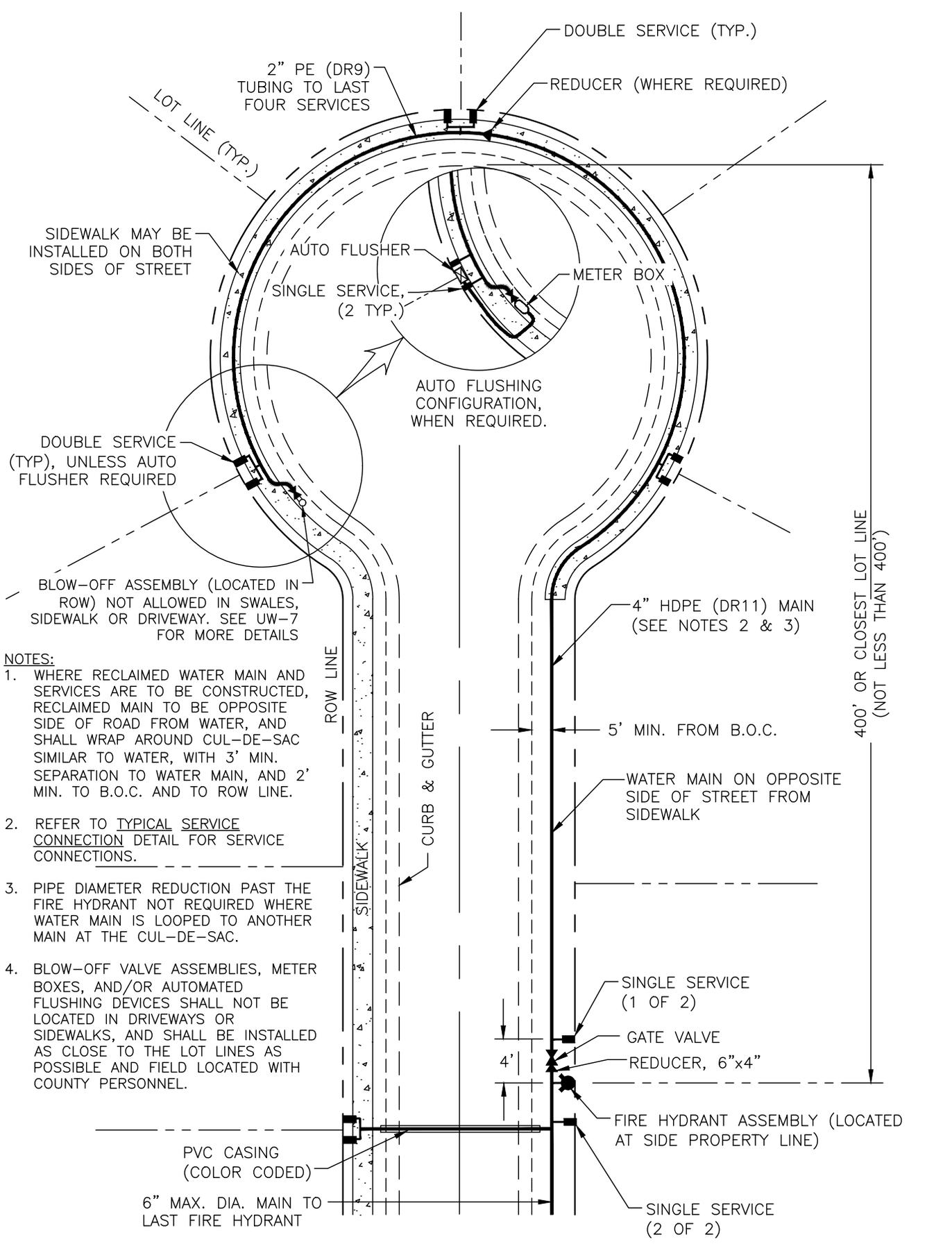

- NOTES:**
1. WHERE RECLAIMED WATER MAIN AND SERVICES ARE TO BE CONSTRUCTED, RECLAIMED MAIN TO BE OPPOSITE SIDE OF ROAD FROM WATER, AND SHALL WRAP AROUND CUL-DE-SAC SIMILAR TO WATER, WITH 3' MIN. SEPARATION TO WATER MAIN, AND 2' MIN. TO B.O.C. AND TO ROW LINE.
 2. REFER TO TYPICAL SERVICE CONNECTION DETAIL FOR SERVICE CONNECTIONS.
 3. PIPE DIAMETER REDUCTION PAST THE FIRE HYDRANT NOT REQUIRED WHERE WATER MAIN IS LOOPED TO ANOTHER MAIN AT THE CUL-DE-SAC.
 4. BLOW-OFF VALVE ASSEMBLIES, METER BOXES, AND/OR AUTOMATED FLUSHING DEVICES SHALL NOT BE LOCATED IN DRIVEWAYS OR SIDEWALKS, AND SHALL BE INSTALLED AS CLOSE TO THE LOT LINES AS POSSIBLE AND FIELD LOCATED WITH COUNTY PERSONNEL.

MANATEE COUNTY	
PUBLIC WORKS DEPARTMENT	
REV. BY	DATE
February 25, 2020	
DATE OF APPROVAL	

CUL-DE-SAC MAINS

UW-22

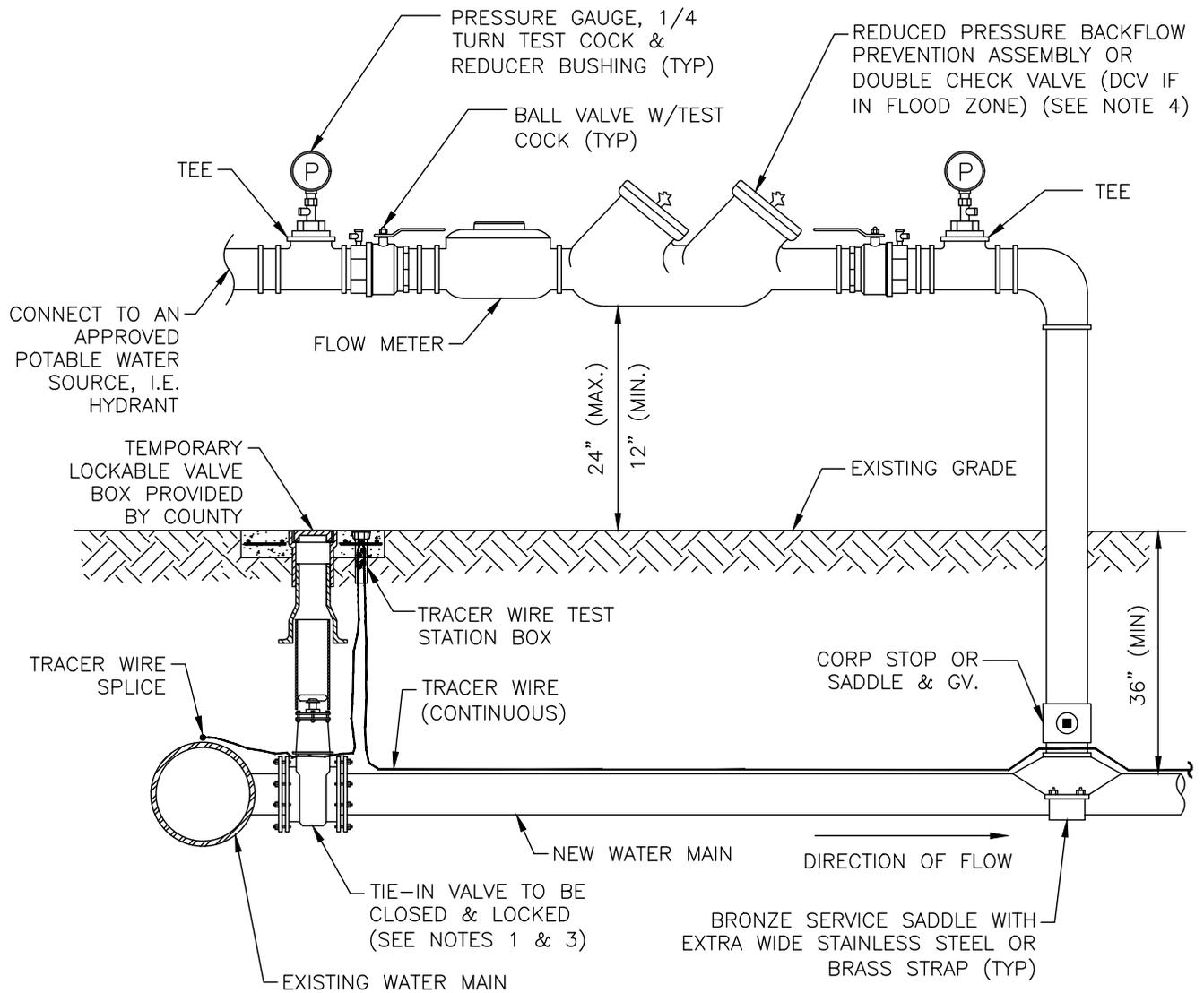

PROFILE

NOTES:

1. FOR TIE-IN VALVE, SEE DETAIL UW-3 FOR TAPPING SLEEVE VALVE AND UW-2 FOR GATE VALVE.
2. CORPORATION STOP CONNECTIONS TO WATER MAINS SHALL BE AT A SUFFICIENT DISTANCE FROM NEW TAPPING SLEEVE & VALVE (TIE-IN VALVE). ALL CORPORATION STOP TAPS SHALL BE PLACED NO CLOSER THAN 30" OR A DISTANCE EQUAL TO (1) MAIN PIPE DIAMETER PLUS (2) TAP DIAMETERS (WHICHEVER IS LARGER) FROM THE NEW TIE-IN VALVE (TAPPING VALVE & SLEEVE). SIZE-ON-SIZE TAPS ARE NOT ALLOWED. A CUT-IN TEE SHALL BE USED.
3. IF THE EXISTING WATER MAIN IS LOCATED UNDER PAVEMENT OR CLOSE TO THE ROADWAY, BOTH JUMPER CORPORATION STOPS MAY CONNECT TO THE NEW WATER MAIN LOCATED OUTSIDE OF THE PAVEMENT. AN ADDITIONAL GATE VALVE SHALL BE INSTALLED AND THE VALVE MAY BE LOCATED AT THE ROW LINE. PIPING AND APPURTENANCES BETWEEN THE EXISTING MAIN AND ISOLATION VALVE AND JUMPER SHALL BE DISINFECTED BY SPRAYING OR SWABBING.
4. BACKFLOW PREVENTION ASSEMBLY SHALL BE STRUCTURALLY SUPPORTED.
5. THE TIE-IN VALVE SHALL REMAIN CLOSED AND THE LOCKABLE VALVE BOX SHALL BE LOCKED BY MANATEE COUNTY. THE TIE-IN VALVE SHALL REMAIN CLOSED AND LOCKED UNTIL THE NEW SYSTEM HAS BEEN CLEARED FOR USE BY THE FDEP AND ALL OTHER PERTINENT AGENCIES. AFTER CLEARANCE IS OBTAINED, THE LOCKABLE VALVE BOX SHALL BE REMOVED, RETURNED TO THE COUNTY, AND REPLACED WITH A STANDARD VALVE BOX.
6. IN THE EVENT THE LOCKED TIE-IN VALVE MUST BE OPENED, THE VALVE SHALL ONLY BE OPERATED BY MANATEE COUNTY PERSONNEL.
7. SEE DETAIL UW-24 FOR ADDITIONAL JUMPER CONNECTION NOTES.

MANATEE COUNTY PUBLIC WORKS DEPARTMENT		TEMPORARY JUMPER CONNECTION—HYDRANT AVAILABLE	UW-23A
REV. BY	DATE		
	February 25, 2020		
	DATE OF APPROVAL		

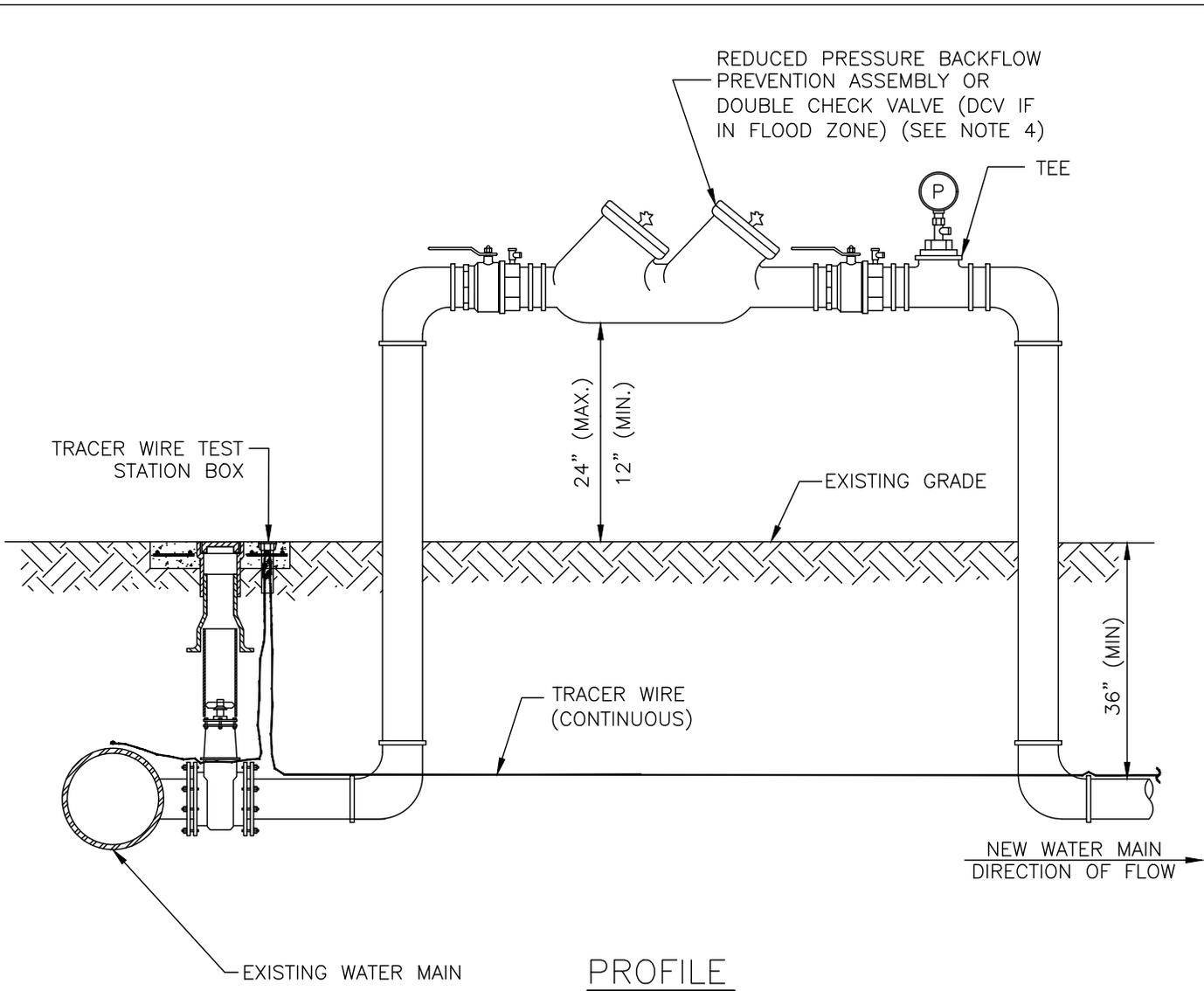

PROFILE

NOTES:

1. FOR TIE-IN VALVE, SEE DETAIL UW-3 FOR TAPPING SLEEVE VALVE AND UW-2 FOR GATE VALVE.
2. CORPORATION STOP CONNECTIONS TO WATER MAINS SHALL BE AT A SUFFICIENT DISTANCE FROM NEW TAPPING SLEEVE & VALVE (TIE-IN VALVE). ALL CORPORATION STOP TAPS SHALL BE PLACED NO CLOSER THAN 30" OR A DISTANCE EQUAL TO (1) MAIN PIPE DIAMETER PLUS (2) TAP DIAMETERS (WHICHEVER IS LARGER) FROM THE NEW TIE-IN VALVE (TAPPING VALVE & SLEEVE). SIZE-ON-SIZE TAPS ARE NOT ALLOWED. A CUT-IN TEE SHALL BE USED.
3. IF THE EXISTING WATER MAIN IS LOCATED UNDER PAVEMENT OR CLOSE TO THE ROADWAY, BOTH JUMPER CORPORATION STOPS MAY CONNECT TO THE NEW WATER MAIN LOCATED OUTSIDE OF THE PAVEMENT. AN ADDITIONAL GATE VALVE SHALL BE INSTALLED AND THE VALVE MAY BE LOCATED AT THE ROW LINE. PIPING AND APPURTENANCES BETWEEN THE EXISTING MAIN AND ISOLATION VALVE AND JUMPER SHALL BE DISINFECTED BY SPRAYING OR SWABBING.
4. BACKFLOW PREVENTION ASSEMBLY SHALL BE STRUCTURALLY SUPPORTED.
5. SEE DETAIL UW-24 FOR ADDITIONAL JUMPER CONNECTION NOTES.

MANATEE COUNTY
PUBLIC WORKS DEPARTMENT

TEMPORARY JUMPER
CONNECTION —
NO HYDRANT
AVAILABLE

UW-23B

REV. BY	DATE

February 25, 2020
DATE OF APPROVAL

1. A 2-INCH MINIMUM TEMPORARY JUMPER CONNECTION IS REQUIRED AT ALL CONNECTIONS BETWEEN EXISTING ACTIVE POTABLE WATER MAINS AND PROPOSED NEW WATER MAIN IMPROVEMENTS WITH THE FOLLOWING EXCEPTIONS:
 - a. PROJECTS THAT INCLUDE A PERMANENT BACKFLOW PREVENTER AT THE RIGHT-OF-WAY WHICH IS ADJACENT TO THE EXISTING WATER MAIN;
 - b. PROJECTS THAT INCLUDE NEW WATER MAINS THAT ARE LESS THAN OR EQUAL TO 18 LINEAR FEET IN LENGTH; OR
 - c. OTHER PROPOSED CASES THAT ARE APPROVED BY MANATEE COUNTY AND THE CONSTRUCTION DRAWINGS SPECIFICALLY STATE THAT A TEMPORARY JUMPER CONNECTION IS NOT REQUIRED.
2. A TEMPORARY JUMPER SHALL BE USED AND BE CONNECTED TO AN APPROVED POTABLE WATER SOURCE (E.G., EXISTING FIRE HYDRANT, EXISTING MAIN, EXISTING SERVICE TAP OR TANK TRUCK, ETC.) AS SHOWN IN THE STANDARD TEMPORARY JUMPER DETAIL UW-23A OR UW-23B.

A TEMPORARY JUMPER SHALL BE USED FOR FILLING, FLUSHING AND FOR DISINFECTION OF ANY NEW MAIN OF ANY SIZE. THE TEMPORARY JUMPER CONNECTION SHALL BE MAINTAINED UNTIL AFTER THE FILLING, FLUSHING, TESTING AND DISINFECTION OF THE NEW MAIN HAS BEEN SUCCESSFULLY COMPLETED AND CLEARANCE FOR USE FROM THE FLORIDA DEPARTMENT OF ENVIRONMENTAL PROTECTION (FDEP) HAS BEEN OBTAINED.

3. THE LOCATION AND ORIENTATION OF TEMPORARY JUMPERS ASSOCIATED WITH CONNECTIONS TO EXISTING WATER MAINS THAT ARE LOCATED UNDER THE ROADWAY PAVEMENT SHALL BE APPROVED ON A CASE-BY-CASE BASIS.
4. PIPE AND FITTINGS USED FOR CONNECTING THE NEW PIPE TO THE EXISTING PIPE SHALL BE DISINFECTED PRIOR TO INSTALLATION IN ACCORDANCE WITH AWWA C651, LATEST EDITION. UNLESS APPROVED OTHERWISE, THE TAPPING SLEEVE, AND EXTERIOR OF THE EXISTING MAIN TO BE TAPPED, PIPING WITHIN THE JUMPER, AND NEW PIPING SHOWN ON STANDARD TEMPORARY JUMPER DETAIL UW-23A OR UW-23B SHALL BE DISINFECTED BY SPRAYING OR SWABBING PER SECTION 4.6 OF AWWA C651.
5. THE JUMPER SHALL INCLUDE A FLOW METER TO ENSURE THAT THE FLOW FROM THE SUPPLY SOURCE IS AT A CONSTANT MEASURED RATE WHILE CHLORINATING THE NEW MAIN. THE CHLORINE CONCENTRATION SHALL BE MEASURED AT REGULAR INTERVALS TO ENSURE THAT IT IS FED AT A CONSTANT RATE OF NOT LESS THAN 25 MILLIGRAMS PER LITER (MG/L) OF FREE CHLORINE.
6. THE JUMPER CONNECTION SHALL ALSO BE USED TO MAINTAIN A MINIMUM PRESSURE OF 20 PSI IN THE NEW MAINS CONTINUOUSLY AFTER DISINFECTION AND UNTIL FDEP CLEARANCE LETTER IS OBTAINED.
7. ALL TEMPORARY BACKFLOW PREVENTION ASSEMBLY OR "JUMPERS" UTILIZED DURING PIPELINE CONSTRUCTION MUST SHOW CERTIFICATION THAT THEY HAVE BEEN TESTED ANNUALLY AND PASSED ACCORDING TO THE FLORIDA BUILDING CODE, PLUMBING SECTION, CHAPTER 3, SECTION 312.9.1, 312.9.2, CHAPTER 6, SECTION 608, AND RESOLUTION R87-125. ANNUAL CERTIFICATION MUST BE VALID AT TIME OF INSTALLATION AND PROVIDED TO THE MANATEE COUNTY INSPECTOR UPON REQUEST.
8. ALL INSTALLATION AND MAINTENANCE OF THE TEMPORARY JUMPER CONNECTION AND ASSOCIATED BACKFLOW PREVENTION ASSEMBLY, FLOW METER, FITTINGS, VALVES, ETC., SHALL BE THE RESPONSIBILITY OF THE CONTRACTOR.
9. TEMPORARY JUMPER SIZE DEPENDS ON THE SITUATION: JUMPERS LARGER THAN 2-INCHES MAY BE USED FOR FLUSHING PURPOSES OR IF PARTIAL FIRE PROTECTION IS REQUIRED DURING INITIAL CONSTRUCTION, AS DETERMINED BY THE ENGINEER OF RECORD OR FIRE DEPARTMENT.
10. PRIOR TO REMOVAL OF THE TEMPORARY JUMPER, THE NEWLY-CONSTRUCTED WATER SYSTEM SHALL HAVE RECEIVED CLEARANCE FROM THE FDEP.
11. AFTER RECEIPT OF CLEARANCE FOR USE BY FDEP, MANATEE COUNTY, AND ALL OTHER PERTINENT AGENCIES, THE CONTRACTOR SHALL REMOVE THE TEMPORARY JUMPER CONNECTION AND COMPLETE THE WATER MAIN. ALL CORPORATION STOPS LEFT-IN-PLACE ARE TO BE CLOSED AND PLUGGED WITH 2-INCH BRASS.
12. IF THE TEMPORARY JUMPER IS LOCATED WITHIN A STANDARD PIPE LENGTH AWAY FROM THE PROPOSED TIE-IN AND A SINGLE STANDARD LENGTH OF PIPE IS USED FOR COMPLETING THE CONNECTION, THEN THE COUNTY WILL PERFORM A VISUAL INSPECTION AND A SEPARATE HYDROSTATIC TEST MAY NOT BE REQUIRED.

IF MULTIPLE LENGTHS OF PIPES ARE USED TO COMPLETE THE CONNECTION, THEN A SEPARATE HYDROSTATIC TEST WILL BE REQUIRED. THE HYDROSTATIC TEST SHALL BE PERFORMED BETWEEN THE PROPOSED TIE-IN VALVE AND THE FIRST DOWNSTREAM VALVE FROM THE TEMPORARY JUMPER LOCATION.

MANATEE COUNTY		TEMPORARY JUMPER CONNECTION NOTES	UW-24
PUBLIC WORKS DEPARTMENT			
REV. BY	DATE		
February 25, 2020			
DATE OF APPROVAL			

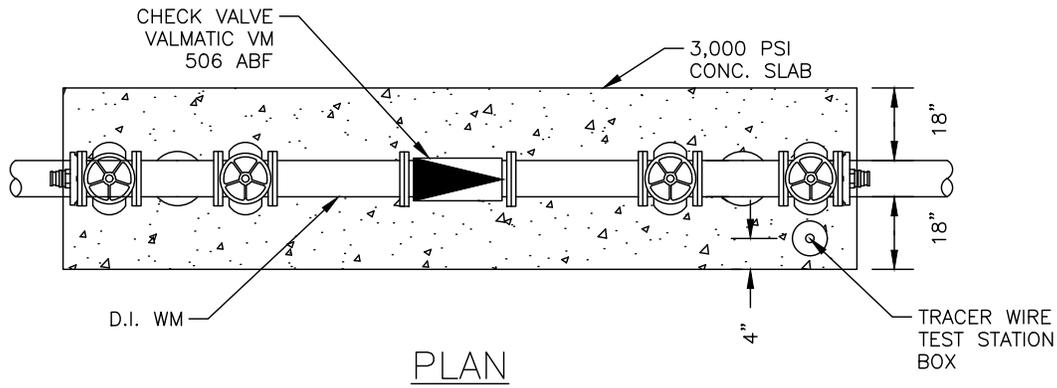

FLOW →

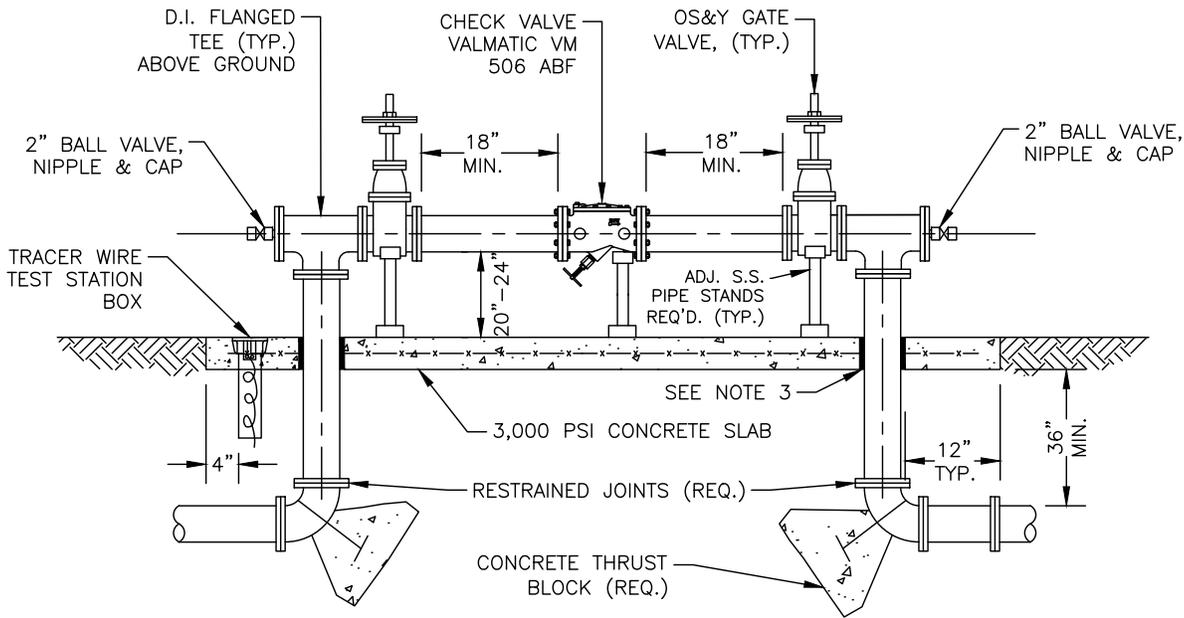

SLAB SPECIFICATIONS

PIPE DIAMETER	SLAB THICKNESS	REINFORCEMENT
3" TO 10"	4"	6x6 W1.4 WIRE MESH OR REBAR

NOTES:

1. WHEN PRESSURE TESTING, TEST AGAINST DOWNSTREAM GATE VALVE.
2. THE SYSTEM MUST MEET ALL REQUIREMENTS OF THE FLORIDA PLUMBING CODE (LATEST ED.).
3. PIPE THROUGH SLAB AND ALL BELOW GROUND D.I. PIPE AND FITTINGS SHALL BE POLYETHYLENE WRAPPED.
4. ABOVE GROUND PIPING SHALL BE FLANGED DUCTILE IRON CLASS 53 AND PAINTED SAFETY BLUE BY SCOTT PAINT.
5. ALL EXPOSED EDGES OF CONCRETE SHALL BE 1/2" CHAMFER.
6. LANDSCAPE VEGETATION SHALL BE 6' MIN. AND TREES SHALL BE 10' MIN. FROM EDGE OF CONCRETE SLAB. STREET SIDE OF ASSEMBLY SHALL REMAIN OPEN.
7. ALL ABOVE-GROUND ANCILLARY BOLTS, NUTS, WASHERS, & FASTENERS SHALL BE 316 STAINLESS STEEL. ALL BURIED SHALL BE MIN. 304 STAINLESS STEEL.
8. SEE UW-2 GATE VALVE, BOX, LID AND TAG DETAIL.
9. ADJUSTABLE 316 S.S. PIPE STANDS SHALL BE BOLTED TO SLAB WITH 316 S.S. HARDWARE.

MANATEE COUNTY
PUBLIC WORKS DEPARTMENT

REV. BY	DATE

February 25, 2020
DATE OF APPROVAL

INTERCONNECT TO
MANATEE COUNTY

UW-25

TABLE OF CONTENTS

UTILITY STANDARDS—SANITARY SEWER

US-1	TABLE OF CONTENTS – SANITARY SEWER
US-2	STANDARD PRE-CAST SANITARY SEWER MANHOLE FOR UNDISTURBED FLOW
US-3	STANDARD PRE-CAST POLYMER CONCRETE SANITARY SEWER MANHOLE FOR TURBULENT FLOW
US-4	STANDARD PRE-CAST SHALLOW MANHOLE
US-5	SANITARY SEWER MANHOLE CONSTRUCTED OVER EXISTING SEWER LINE
US-6	GRAVITY SEWER STANDARD DROP CONNECTION
US-7A	FORCE MAIN CONNECTION TO EX. PORTLAND CEMENT MANHOLE (3-6 FT DEEP)
US-7B	FORCE MAIN CONNECTION TO EX. PORTLAND CEMENT MANHOLE (>6 FT DEEP)
US-8	BELOW GRADE AIR RELEASE VALVE FOR FORCE MAINS
US-9	ABOVE-GROUND AIR RELEASE VALVE ASSY. FOR FORCE MAINS
US-10	MANHOLE COVER & CONCRETE COLLAR FOR UNPAVED ROADWAYS
US-11	VALVE, BOX, COVER AND TAG
US-12	TAPPING SLEEVE AND VALVE (FORCE MAINS)
US-13A	SINGLE AND DOUBLE SERVICE CONNECTION
US-13B	CUT-IN SINGLE AND DOUBLE SERVICE WYES
US-13C	EXISTING SERVICE CONNECTION (BUILDING DEMOLITION)
US-14A	COMPACTOR AND DUMPSTER PADS
US-14B	MODIFICATIONS TO EX. FOOD SERVICE COMPACTOR & DUMPSTER PADS
US-15	WATER METER & BACKFLOW PREVENTION ASSEMBLY FOR LIFT STATIONS
US-16	MIN. ACCESS/EGRESS & LANDSCAPING REQUIREMENTS FOR LIFT STATIONS
US-17	SECURITY FENCING
US-17A	POLYMER CONCRETE MANHOLES UPSTREAM FROM LIFT STATION
US-18	SEWAGE LIFT STATION PLAN VIEW
US-19	SEWAGE LIFT STATION SECTION VIEW
US-20	LIFT STATION NOTES
US-21	LIFT STATION, PIPE BRACING, & STILLING WELL DETAILS
US-22	PUMP BASE ELL MOUNTING PLATE
US-23	SEWAGE LIFT STATION METER & ELECTRICAL DETAILS
US-24	SEWAGE LIFT STATION CONTROL PANEL
US-25A-E	SEWAGE LIFT STATION CONTROL PANEL (230V)
US-26A-E	SEWAGE LIFT STATION CONTROL PANEL (460V)
US-27A	GRINDER LIFT STATION
US-27B	GRINDER LIFT STATION NOTES

NOTE:

SEWAGE WORKS SHALL BE DESIGNED IN ACCORDANCE WITH F.D.E.P. REGULATIONS AND "RECOMMENDED STANDARDS FOR WASTEWATER FACILITIES" BY THE GREAT LAKES-UPPER MISSISSIPPI RIVER BOARD OF STATE AND PROVINCIAL PUBLIC HEALTH AND ENVIRONMENTAL MANAGERS – LATEST EDITION.

MANATEE COUNTY PUBLIC WORKS DEPARTMENT		TABLE OF CONTENTS SANITARY SEWER	US-1
REV. BY	DATE		
February 25, 2020			
DATE OF APPROVAL			

RING & COVER (ASTM A-48), COVER TO BE MARKED "MANATEE COUNTY SANITARY SEWER & YEAR"; OMIT "MANATEE" COUNTY IF PRIVATELY MAINTAINED.

RIM ELEVATION INDICATED ON PLAN

RAINWATER INSERT WITH GASKET

1'-6" MAX.

2"

FINISH GRADE

PRE-CAST CONCRETE RINGS SET IN BUTYL RUBBER SEALANT STRIPS; MIN. 3" WIDE x 1/2" THICK

2'-0"

ENCASE RIBS IN CEMENT MORTAR COLLAR ALL AROUND

PRE-CAST M.H. SHALL CONFORM TO ASTM C-478 LATEST REV, TYPE II CONCRETE, 4,000 P.S.I. 28 DAY COMPRESSIVE STRENGTH

TONGUE & GROOVE JOINT WITH RING GASKET. ALL JOINTS SHALL MEET THE REQUIREMENTS FOR CONCRETE SEWER AND CULVERT PIPE USING RUBBER GASKETS (ASTM C-443)

FOR JOINTS USING RUBBER GASKETS, APPLY AN ADDITIONAL SEALING DEVICE, SUCH AS AN EXTERNAL JOINT WRAP OR AN INTERNAL JOINT SEALANT. THE INTERNAL JOINT SEALANT SHALL BE APPLIED TO THE INTERIOR OF JOINT BEFORE MANHOLE SECTION ASSEMBLY.

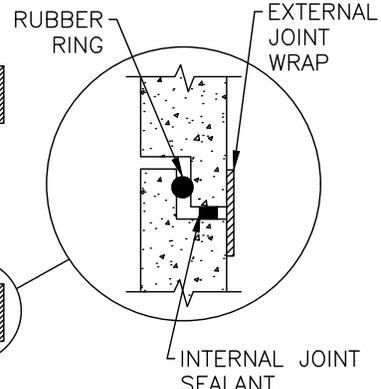

8" MIN.

4'-0" DIA. (8"-16" PIPE)

5'-0" DIA. (LARGER THAN 16")

8" MIN.

LIFT HOLES OR INSERTS SHALL NOT PENETRATE MANHOLE WALL

CHANNEL FLOW DETAILS

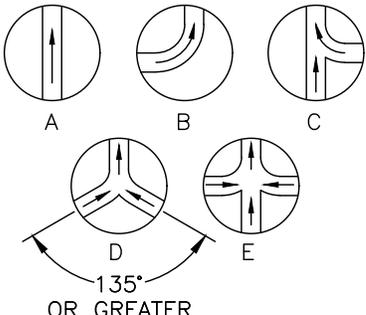

PIPES 16" AND ABOVE SEE STANDARD SPECIFICATIONS FOR BENCH AND INVERT

FLOW

ALL PIPE OPENINGS SHALL HAVE CAST-IN RESILIENT PIPE TO MANHOLE SEALS PER ASTM C-923, W/ 316 S.S. HARDWARE & CONNECTOR BANDS.

#4 @ 9"C.C. EACH WAY CENTERED

8"

12" MIN. #57 STONE PLACED ON SOIL COMPACTED TO 98% DENSITY, AASHTO T-180

12" MIN.

NOTE:

DROP MANHOLES, MANHOLES WITH OPPOSING FLOW (DETAILS D & E), MANHOLES UPSTREAM OF A LIFT STATION WET WELL (SEE US-17A), MANHOLES WITH GRAVITY SEWERS GREATER THAN 12 INCHES IN DIAMETER, MANHOLES RECEIVING A FORCE MAIN AND THE FIRST TWO GRAVITY MANHOLES DOWNSTREAM OF MANHOLES RECEIVING A FORCE MAIN SHALL BE A POLYMER CONCRETE MANHOLE (SEE US-3); OR EXISTING PORTLAND CONCRETE MANHOLE SHALL RECEIVE AN APPROVED LINER.

MANATEE COUNTY PUBLIC WORKS DEPARTMENT

STANDARD PRE-CAST SANITARY SEWER MANHOLE FOR UNDISTURBED FLOW

US-2

REV. BY	DATE

February 25, 2020
DATE OF APPROVAL

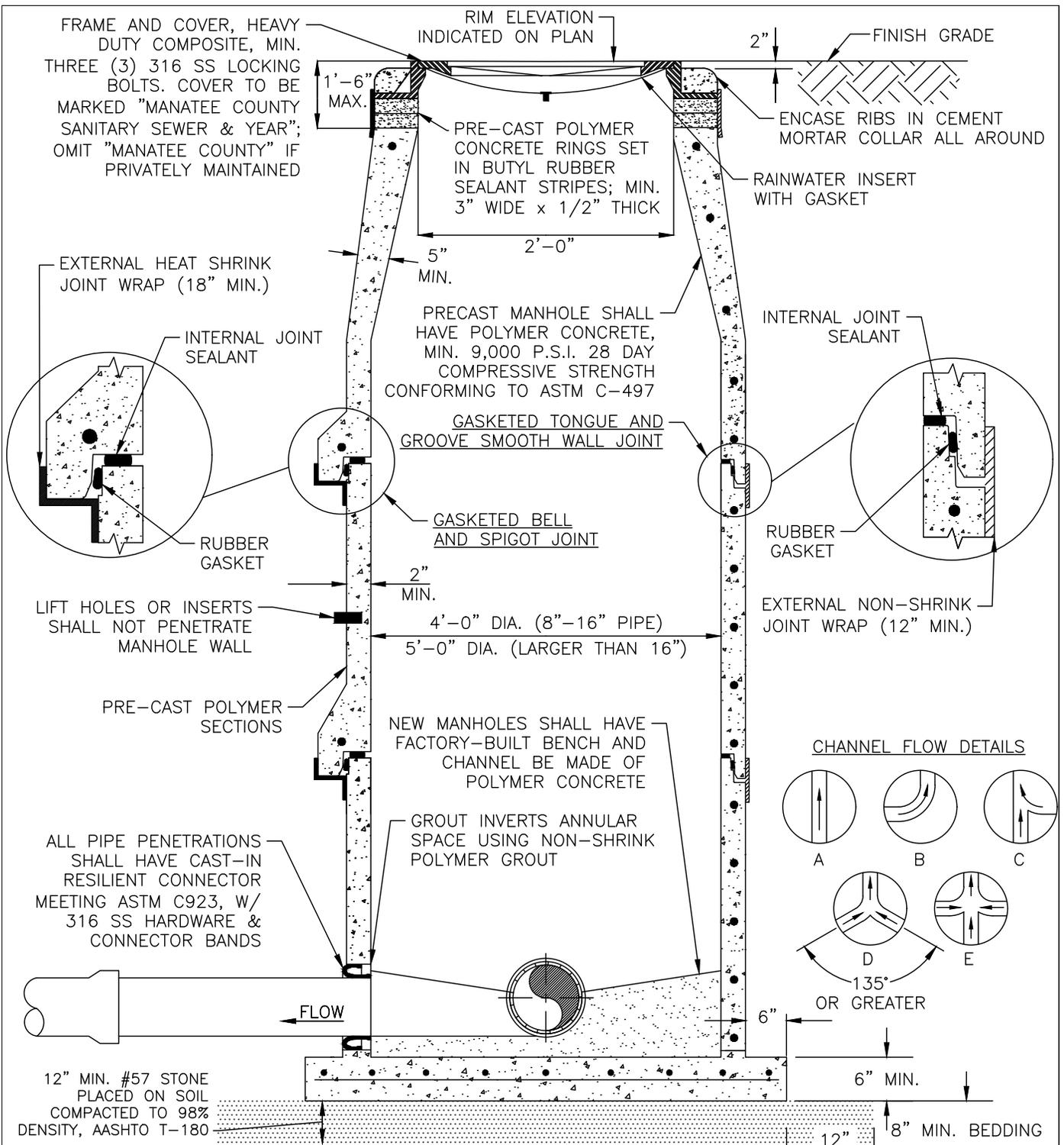

NOTE:

1. DROP MANHOLES, MANHOLES WITH OPPOSING TURBULENT FLOW (DETAILS D & E), MANHOLES UPSTREAM OF A LIFT STATION WET WELL (SEE US-17A), MANHOLES WITH GRAVITY SEWERS GREATER THAN 12 INCHES IN DIAMETER, FORCE MAIN TERMINAL MANHOLE AND THE NEXT TWO DOWNSTREAM MANHOLES SHALL BE MADE OF POLYMER CONCRETE.
2. MANHOLES SHALL HAVE A GASKETED BELL & SPIGOT OR TONGUE & GROOVE SMOOTH WALL JOINT DESIGN.
3. ALL JOINTS SHALL MEET THE REQUIREMENTS OF ASTM C-443 AND ASTM C-990 FOR CONCRETE SEWER AND CULVERT PIPE USING RUBBER GASKETS AND FLEXIBLE JOINT SEALANTS.
4. ALL FRP/STEEL REINFORCEMENT, MANHOLE RISERS, CONES, BASES, AND FLAT LIDS SHALL BE DESIGNED BY MANUFACTURER TO MEET LOADING REQUIREMENTS OF ASTM C-478, ASTM C-857, ACI 350, AND ACI 440.1R AS MODIFIED FOR POLYMER CONCRETE MANHOLES.

MANATEE COUNTY		STANDARD PRE-CAST POLYMER CONCRETE SANITARY SEWER MANHOLE FOR TURBULENT FLOW	US-3
PUBLIC WORKS DEPARTMENT			
REV. BY	DATE		
		February 25, 2020	
		DATE OF APPROVAL	

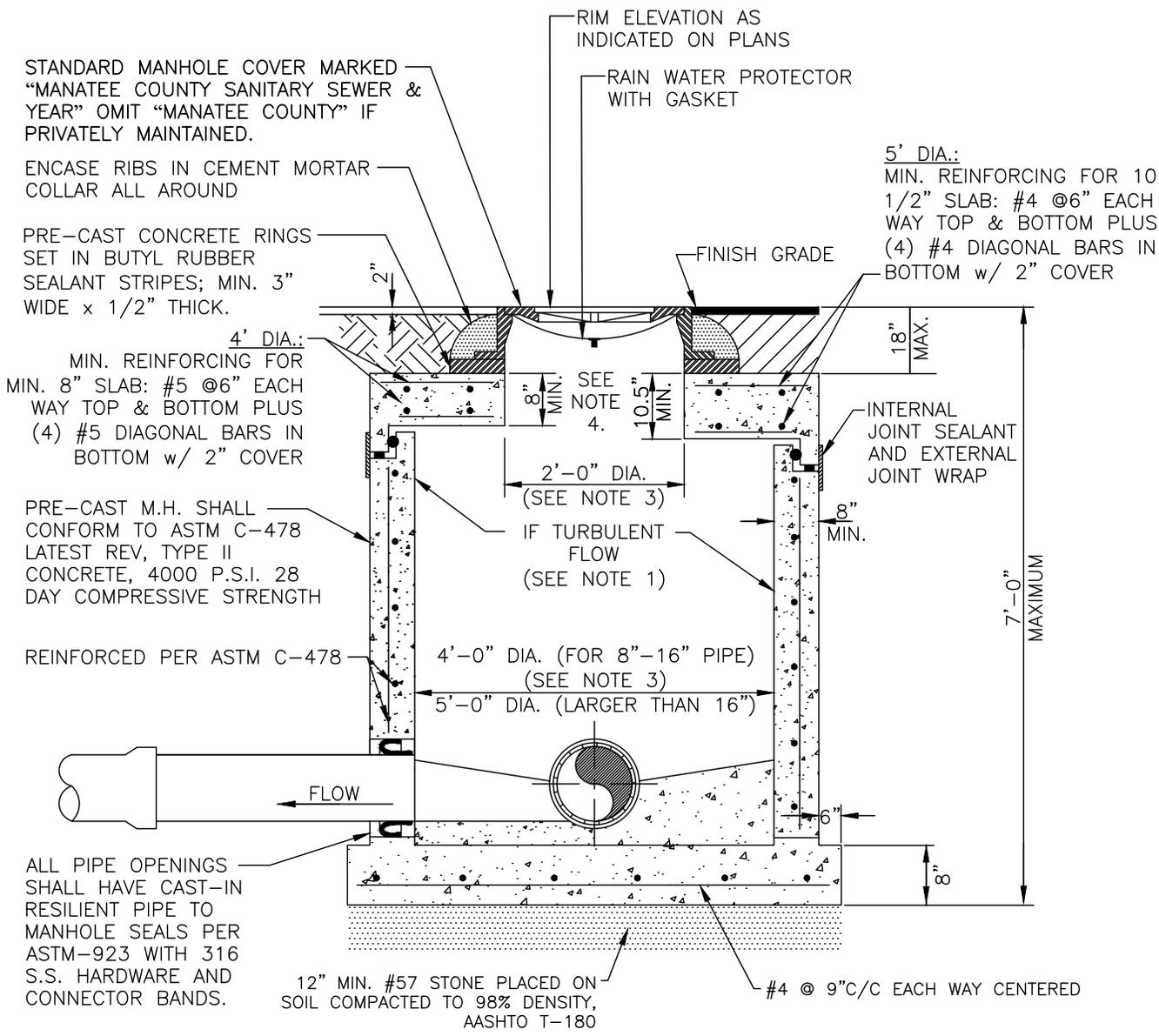

STANDARD MANHOLE COVER MARKED "MANATEE COUNTY SANITARY SEWER & YEAR" OMIT "MANATEE COUNTY" IF PRIVATELY MAINTAINED.

ENCASE RIBS IN CEMENT MORTAR COLLAR ALL AROUND

PRE-CAST CONCRETE RINGS SET IN BUTYL RUBBER SEALANT STRIPES; MIN. 3" WIDE x 1/2" THICK.

4' DIA.: MIN. REINFORCING FOR MIN. 8" SLAB: #5 @6" EACH WAY TOP & BOTTOM PLUS (4) #5 DIAGONAL BARS IN BOTTOM w/ 2" COVER

PRE-CAST M.H. SHALL CONFORM TO ASTM C-478 LATEST REV, TYPE II CONCRETE, 4000 P.S.I. 28 DAY COMPRESSIVE STRENGTH

REINFORCED PER ASTM C-478

ALL PIPE OPENINGS SHALL HAVE CAST-IN RESILIENT PIPE TO MANHOLE SEALS PER ASTM-923 WITH 316 S.S. HARDWARE AND CONNECTOR BANDS.

RIM ELEVATION AS INDICATED ON PLANS

RAIN WATER PROTECTOR WITH GASKET

5' DIA.: MIN. REINFORCING FOR 10 1/2" SLAB: #4 @6" EACH WAY TOP & BOTTOM PLUS (4) #4 DIAGONAL BARS IN BOTTOM w/ 2" COVER

8" MIN. SEE NOTE 4. 10.5" MIN.

2'-0" DIA. (SEE NOTE 3)

IF TURBULENT FLOW (SEE NOTE 1)

4'-0" DIA. (FOR 8"-16" PIPE) (SEE NOTE 3)
5'-0" DIA. (LARGER THAN 16")

CHANNEL FLOW DETAILS

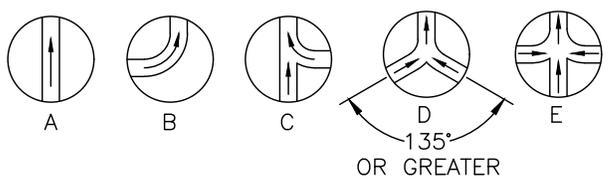

NOTES:

1. DROP MANHOLES, MANHOLES WITH OPPOSING FLOW (DETAILS D & E), MANHOLES UPSTREAM OF A LIFT STATION WET WELL (SEE US-17A), MANHOLES WITH GRAVITY SEWERS GREATER THAN 12 INCHES IN DIAMETER, MANHOLES RECEIVING A FORCE MAIN AND THE FIRST TWO GRAVITY MANHOLES DOWNSTREAM OF MANHOLES RECEIVING A FORCE MAIN SHALL HAVE BE A POLYMER CONCRETE MANHOLE (SEE US-3); OR EXISTING PORTLAND CONCRETE MANHOLE SHALL RECEIVE AN APPROVED LINER.
2. LIFT HOLES OR INSERTS SHALL NOT PENETRATE THE WALLS OF THE MANHOLES.
3. A MINIMUM COVER OF 3' OVER THE GRAVITY SEWER SHALL BE PROVIDED. FOR MANHOLES WITH LESS THAN 4' OF COVER OVER THE GRAVITY SEWER, THE MANHOLE INSIDE DIAMETER SHALL BE 5'-0" AND THE FRAME AND COVER SHALL BE 32" OPENING.
4. MANHOLE SHALL BE AASHTO H-20 RATED, WHEN LOCATED WITHIN THE RIGHT OF WAY.

MANATEE COUNTY	
PUBLIC WORKS DEPARTMENT	
REV. BY	DATE
February 25, 2020	
DATE OF APPROVAL	

STANDARD PRE-CAST PORTLAND CEMENT SHALLOW MANHOLE

US-4

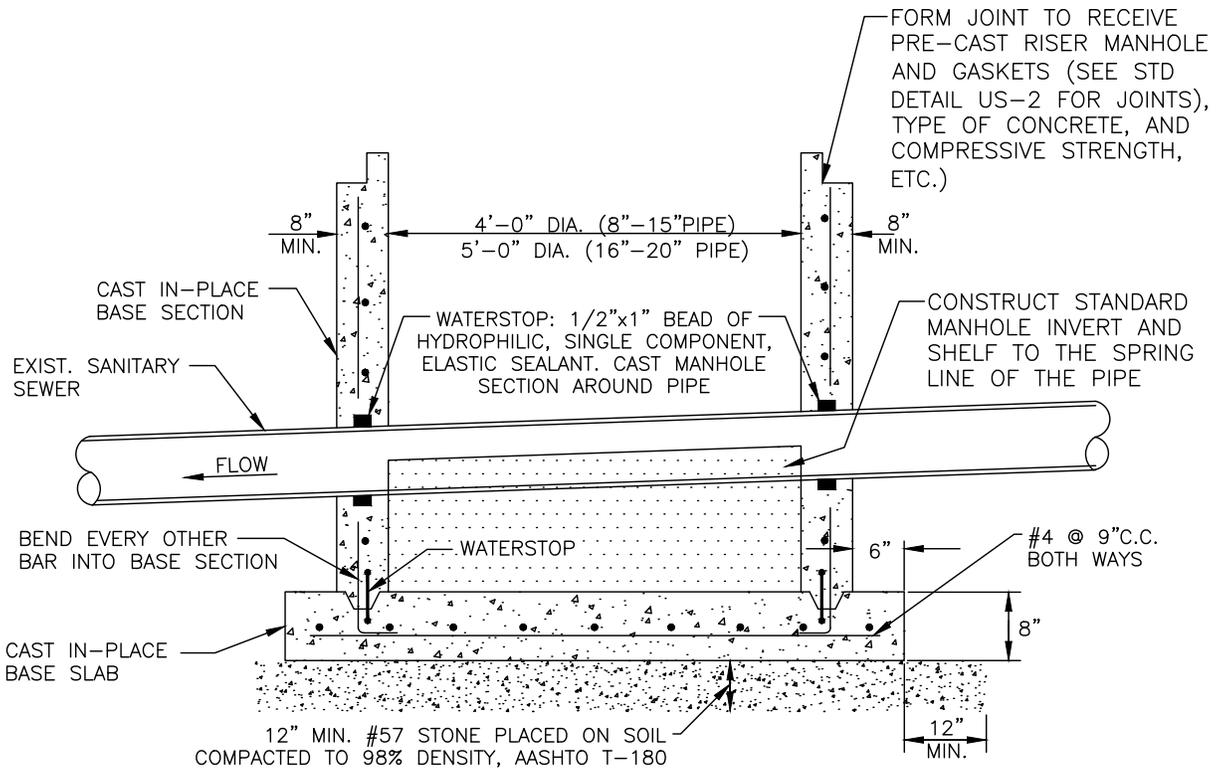

NOTES:

1. PREFERRED CONSTRUCTION IS BY "CUTTING-IN" A STANDARD SANITARY SEWER MANHOLE WITH A TEMPORARY FLOW BY-PASS SYSTEM.
2. PRIOR TO ANY EXCAVATION OVER THE PIPE, A TV RECORDING OF THE EXISTING SEWER MAIN SHALL OCCUR BETWEEN THE UPSTREAM AND DOWNSTREAM MANHOLES WHILE THE COUNTY INSPECTOR IS PRESENT.
3. THE CONTRACTOR SHALL CAREFULLY EXCAVATE AROUND AND PROPERLY SUPPORT THE EXISTING PIPE.
4. SEWER LINES GREATER THAN 20" REQUIRE SPECIAL DESIGN AND APPROVAL BY MANATEE COUNTY UTILITIES ENGINEERING.
5. ALLOW SUFFICIENT CURING TIME, 24-36 HOURS, FOR THE HYDROPHILIC, SINGLE COMPONENT, ELASTIC SEALANT, BEFORE POURING CONCRETE.
6. FOLLOWING SATISFACTORY CURING OF THE INVERT CHANNEL AND SHELF, THE CONTRACTOR SHALL CUT AND REMOVE THE TOP HALF OF THE EXISTING PIPE WITHIN THE MANHOLE, TAKING CARE NOT TO ALLOW ANY PIECES TO BE WASHED DOWN STREAM IN THE PIPE. CUTTING OF THE PIPE SHALL BE IN A WORKMAN LIKE MANNER, PROVIDING A SMOOTH AND EVEN FINISHED PRODUCT.
7. A TV RECORDING OF THE SEWER MAIN SHALL ALSO OCCUR AFTER CONSTRUCTION WHILE THE COUNTY INSPECTOR IS PRESENT. PIPE DEFLECTION SHALL NOT DEVIATE BY MORE THAN 1 INCH FROM THE DESIGN LINE.
8. THERE SHALL BE NO VISIBLE LEAKS IN THE MANHOLE.

MANATEE COUNTY PUBLIC WORKS DEPARTMENT		SANITARY SEWER MANHOLE CONSTRUCTED OVER EXISTING SEWER LINE	US-5
REV. BY	DATE	February 25, 2020 DATE OF APPROVAL	

NOTES:

1. A PRECAST CONCRETE OUTSIDE DROP MAY BE USED IN LIEU OF THE CAST IN PLACE ENCASUREMENT SHOWN BELOW.

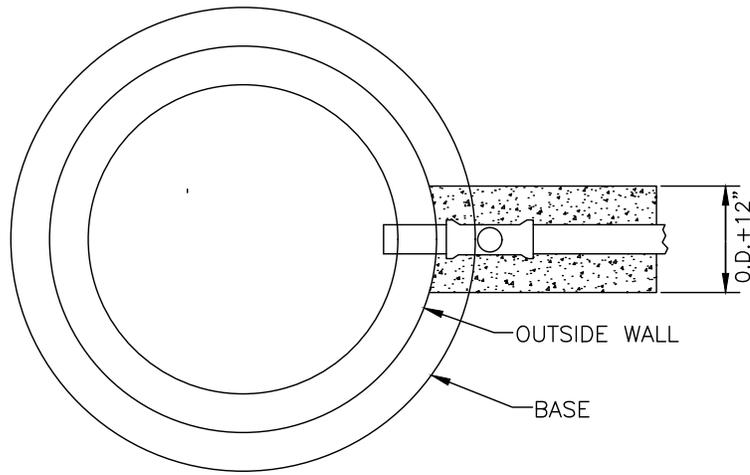

PLAN

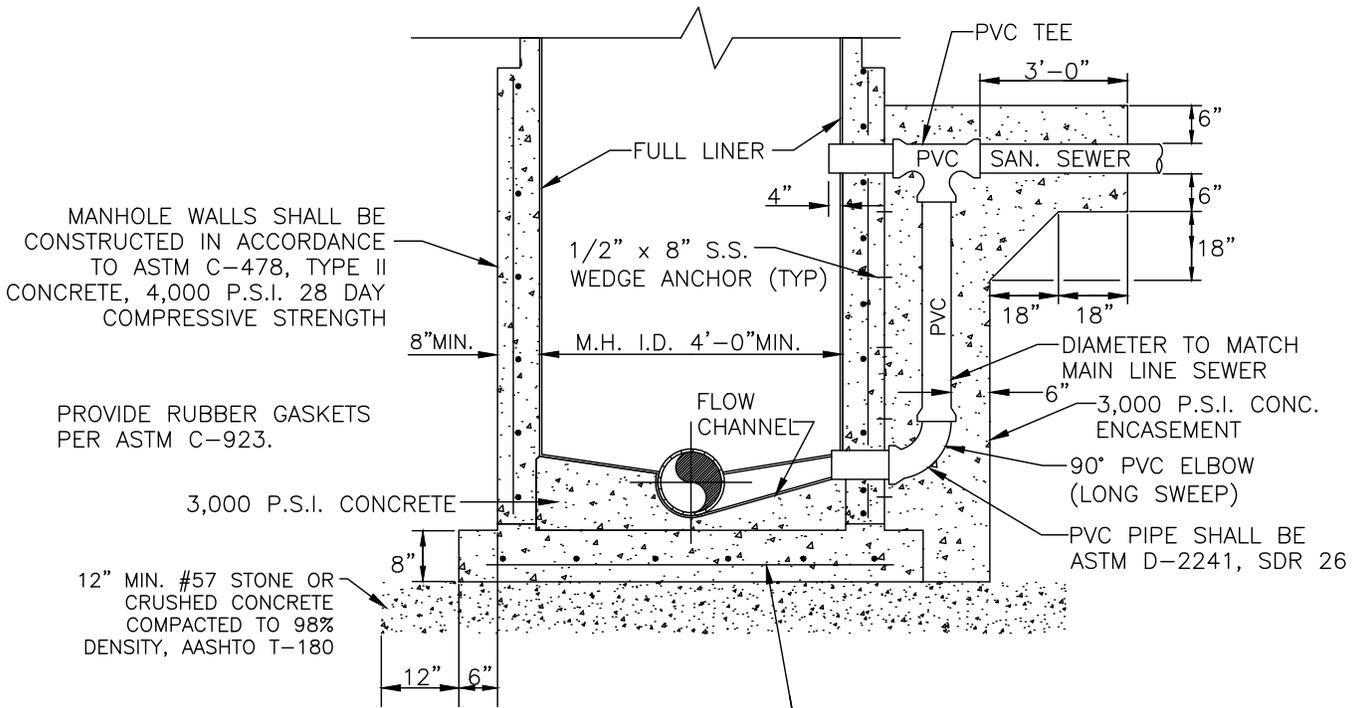

SECTION

NOTES:

1. THIS IS A TURBULENT FLOW MANHOLE AND SHALL BE LINED WITH AN APPROVED LINER. IN NEW CONSTRUCTION, THIS MANHOLE SHALL BE MADE OF POLYMER CONCRETE, SEE US-3.
2. DROP MANHOLES ARE REQUIRED WHEN THE VERTICAL DISTANCE BETWEEN THE LOWEST EXISTING MANHOLE INVERT AND THE HIGHEST PIPE INVERT IS 2'-0" OR GREATER.
3. MANHOLE SHALL BE AASHTO H-20 RATED, WHEN LOCATED WITHIN THE RIGHT OF WAY.

MANATEE COUNTY
PUBLIC WORKS DEPARTMENT

OUTSIDE DROP
CONNECTION TO EX.
PORTLAND CEMENT
MANHOLE

US-6

REV. BY	DATE

February 25, 2020
DATE OF APPROVAL

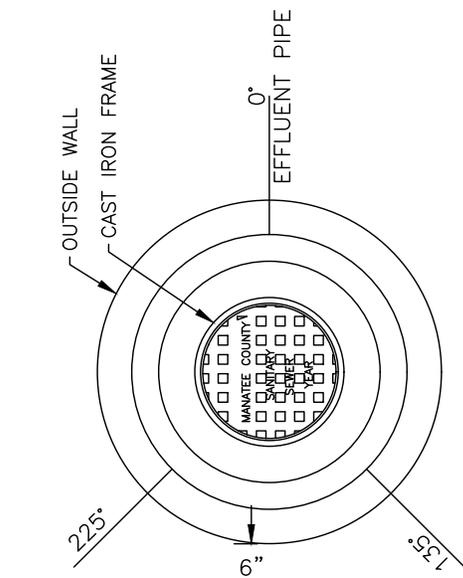

PLAN

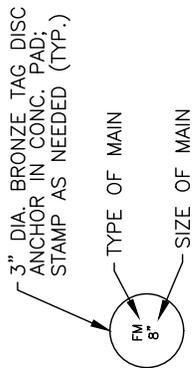
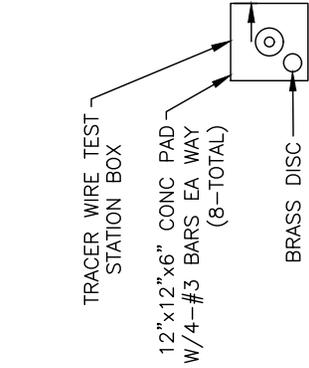

NOTES:

1. PIPE FITTINGS TO BE PVC AWWA C907, CLASS 235.
2. APPROVED PVC RESTRAINERS SHALL BE USED.
3. FORCE MAIN CONNECTION SHALL BE AT THE BOTTOM OF THE MANHOLE.
4. BUILD FLOW CHANNEL PER DETAIL US-3 SEWER MANHOLE FOR TURBULENT FLOW, AND FINISH SMOOTH WITH GROUT.
5. THIS IS AN INTERCEPT MANHOLE WITH TURBULENT FLOW; THIS MANHOLE AND THE NEXT TWO DOWNSTREAM MANHOLES SHALL BE COMPLETELY LINED WITH AN APPROVED LINER. ALL THREE MANHOLES SHALL BE REHABILITATED AS NECESSARY.
6. IN NEW CONSTRUCTION, THIS MANHOLE AND THE NEXT TWO DOWNSTREAM MANHOLES SHALL BE POLYMER CONCRETE, SEE US-3.
7. FORCE MAIN SHALL CONNECT TO THE BOTTOM OF THE MANHOLE 0.1 FT ABOVE EXISTING PIPE. DISCHARGE SHALL BE DIRECTED TO THE EXITING PIPE BY A CONSTRUCTED U-CHANNEL.

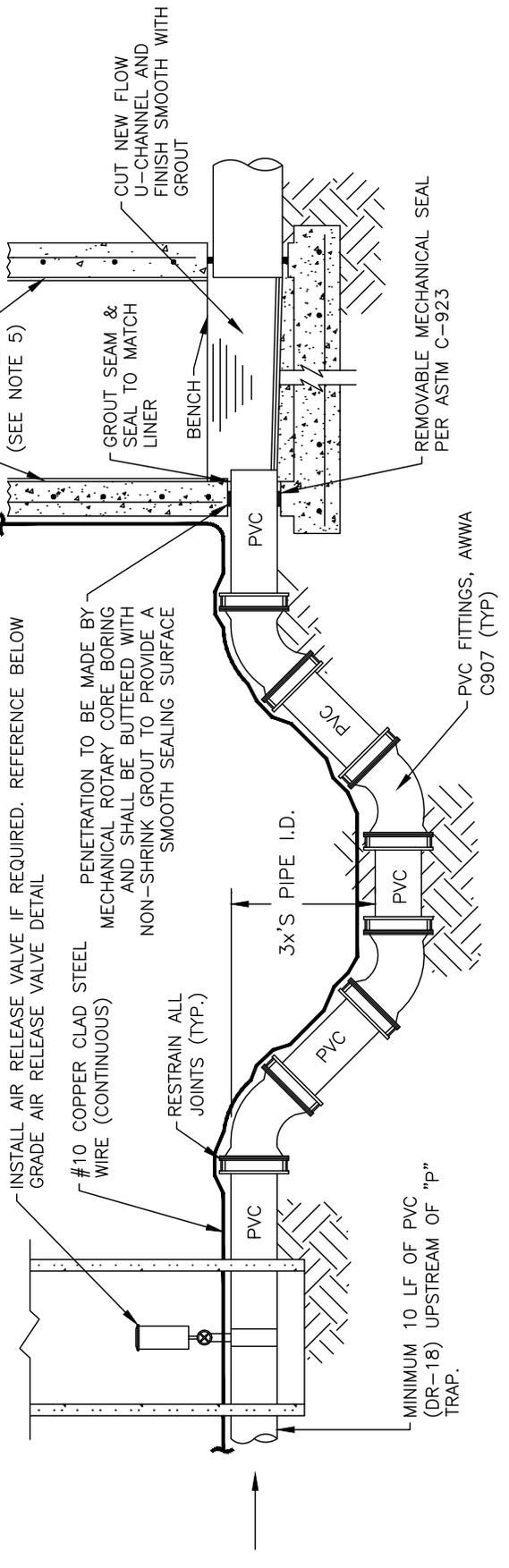

MANATEE COUNTY
PUBLIC WORKS DEPARTMENT

REV. BY	DATE

February 25, 2020
DATE OF APPROVAL

FORCE MAIN CONNECTION
TO EX. PORTLAND
CONCRETE MANHOLE
(3-6 FEET DEEP)

US-7A

NOTES:

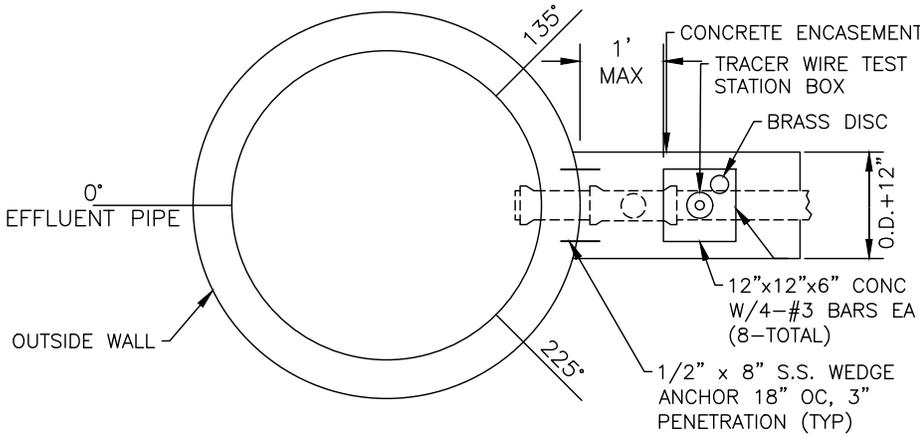

1. SEE US-2 THRU US-4 FOR DETAILED INFORMATION ABOUT PRECAST CONCRETE MANHOLES.
2. A PRE-CAST CONCRETE OUTSIDE DROP MAY BE USED IN LIEU OF THE CAST IN PLACE ENCASUREMENT SHOWN BELOW.

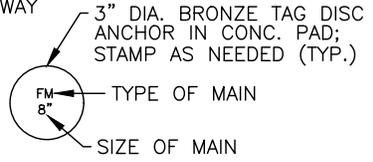

PLAN

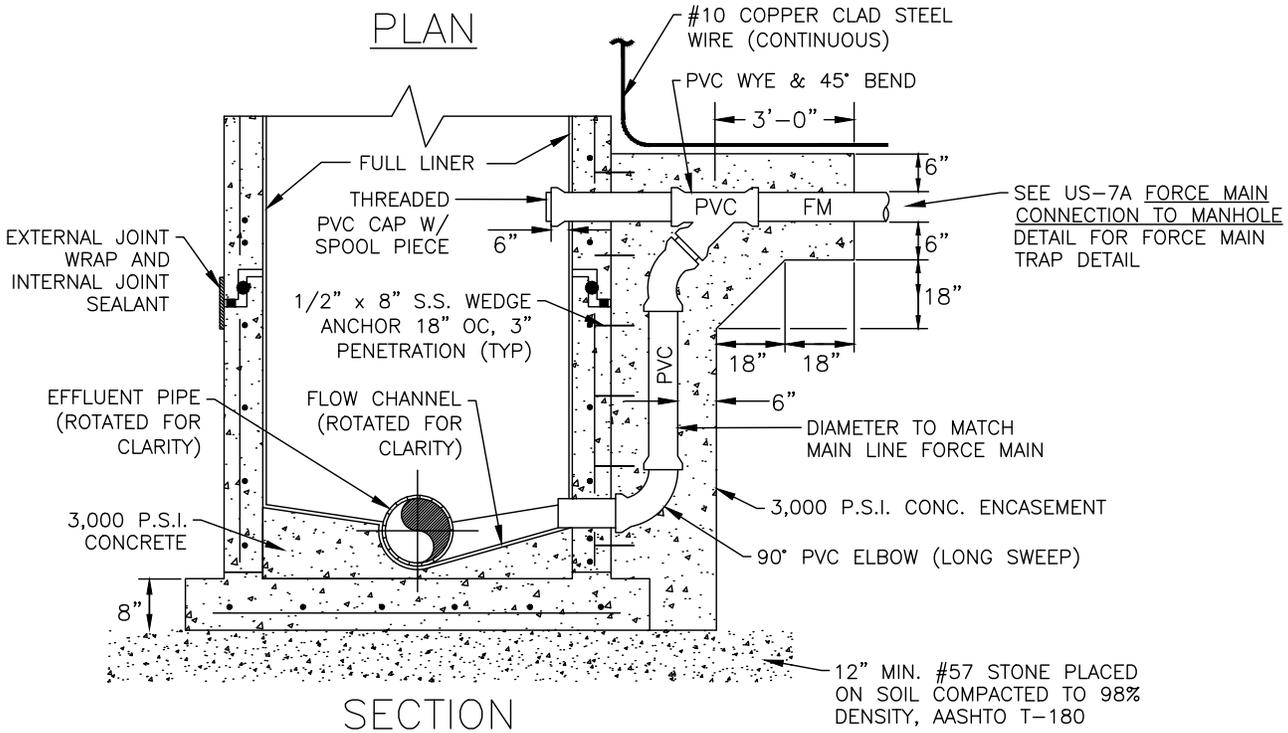

SECTION

NOTES:

1. THIS IS AN INTERCEPT MANHOLE WITH TURBULENT FLOW; THIS MANHOLE AND THE NEXT TWO DOWNSTREAM MANHOLES SHALL BE COMPLETELY LINED WITH AN APPROVED LINER. ALL THREE MANHOLES SHALL BE REHABILITATED AS NECESSARY.
IN NEW CONSTRUCTION, THIS MANHOLE AND THE NEXT TWO DOWNSTREAM MANHOLES SHALL BE POLYMER CONCRETE, SEE US-3.
2. ALL FITTINGS SHALL BE PVC AWWA C-907, CLASS 235 MIN. FORCE MAIN DROP PIPE SHALL BE AWWA C900-16 (CLASS 235, DR 18). APPROVED PVC RESTRAINTS SHALL BE USED.
3. A TRAP IS REQUIRED IN THE FORCE MAIN BEFORE THE DROP.
4. FORCE MAIN SHALL CONNECT TO THE BOTTOM OF THE MANHOLE 0.1 FT ABOVE EXITING PIPE. DISCHARGE SHALL BE DIRECTED TO THE EXITING PIPE BY A CONSTRUCTED U-CHANNEL.
5. BUILD FLOW CHANNEL PER DETAIL SEWER MANHOLE FOR TURBULENT FLOW, AND FINISH SMOOTH WITH GROUT.
6. ANGLE BETWEEN INFLUENT FORCE MAIN AND GRAVITY EFFLUENT PIPE IS PREFERRED TO BE BETWEEN 135°-225°. IF OUTSIDE THE ACCEPTED ANGLES, ADDITIONAL PVC FITTINGS MAY BE REQUIRED INSIDE THE MANHOLE TO DIRECT EFFLUENT TO EXITING PIPE.

MANATEE COUNTY
PUBLIC WORKS DEPARTMENT

FORCE MAIN CONNECTION
TO EX. PORTLAND
CONCRETE MANHOLE
(>6 FEET DEEP)

US-7B

REV. BY	DATE

February 25, 2020
DATE OF APPROVAL

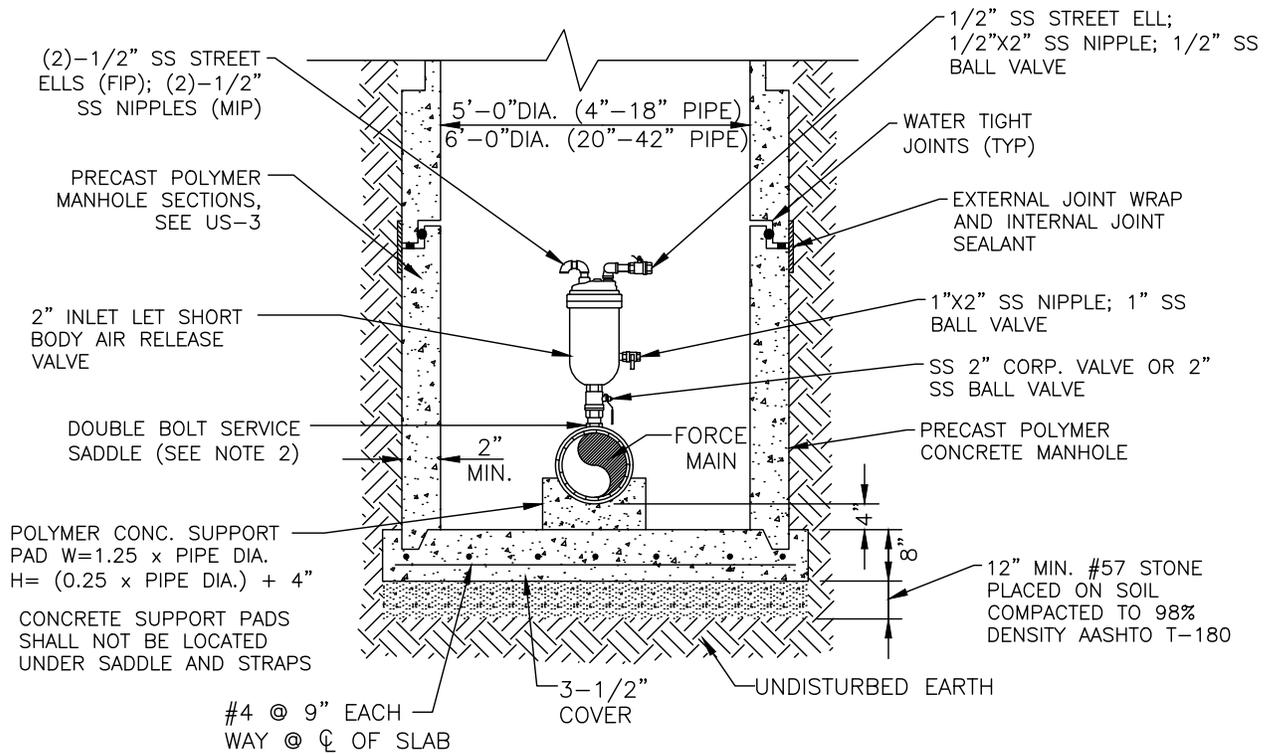
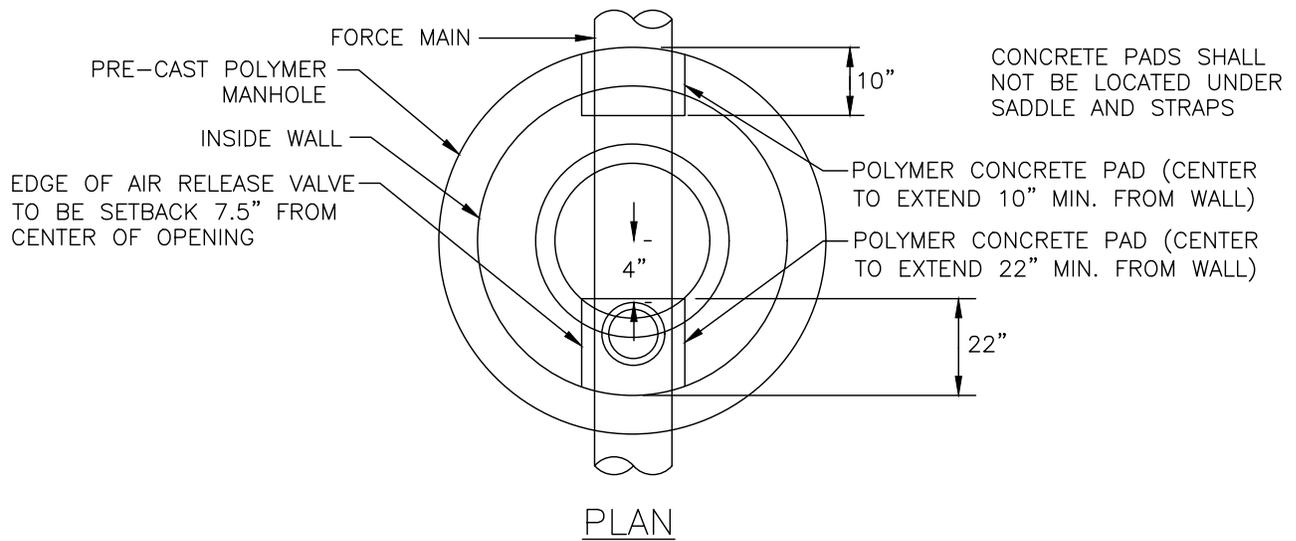

NOTES:

1. AIR RELEASE VALVES WHERE REQUIRED ON 4" AND LARGER FORCE MAINS.
2. ARV TO BE SIZED ACCORDING TO MANUFACTURER'S RECOMMENDATION FOR FORCE MAIN SIZE, MINIMUM 2" ARV REQUIRED.
3. SERVICE SADDLE, NIPPLES AND CORPORATION BALL VALVE SHALL BE 316 STAINLESS STEEL.
4. FOR MANHOLES WITH LESS THAN 44 INCHES OF COVER FROM TOP-OF-PIPE TO TOP-OF-FRAME, FRAME & COVER TO HAVE A 32-INCH OPENING. MINIMUM ALLOWABLE COVER IS 36 INCHES.
5. ALL PIPE PENETRATING MANHOLE SHALL HAVE RESILIENT PIPE TO MANHOLE SEALS PER ASTM-923.
6. FINAL GRADE TO BE SLOPED AWAY FROM MANHOLE.
7. MANHOLE SHALL BE AASHTO H-20 RATED, WHEN LOCATED WITHIN THE RIGHT OF WAY.
8. ALL STAINLESS STEEL SHALL BE 316 STAINLESS STEEL.

MANATEE COUNTY PUBLIC WORKS DEPARTMENT		BELOW GRADE AIR RELEASE VALVE FOR FORCE MAINS	US-8
REV. BY	DATE		
	February 25, 2020		
	DATE OF APPROVAL		

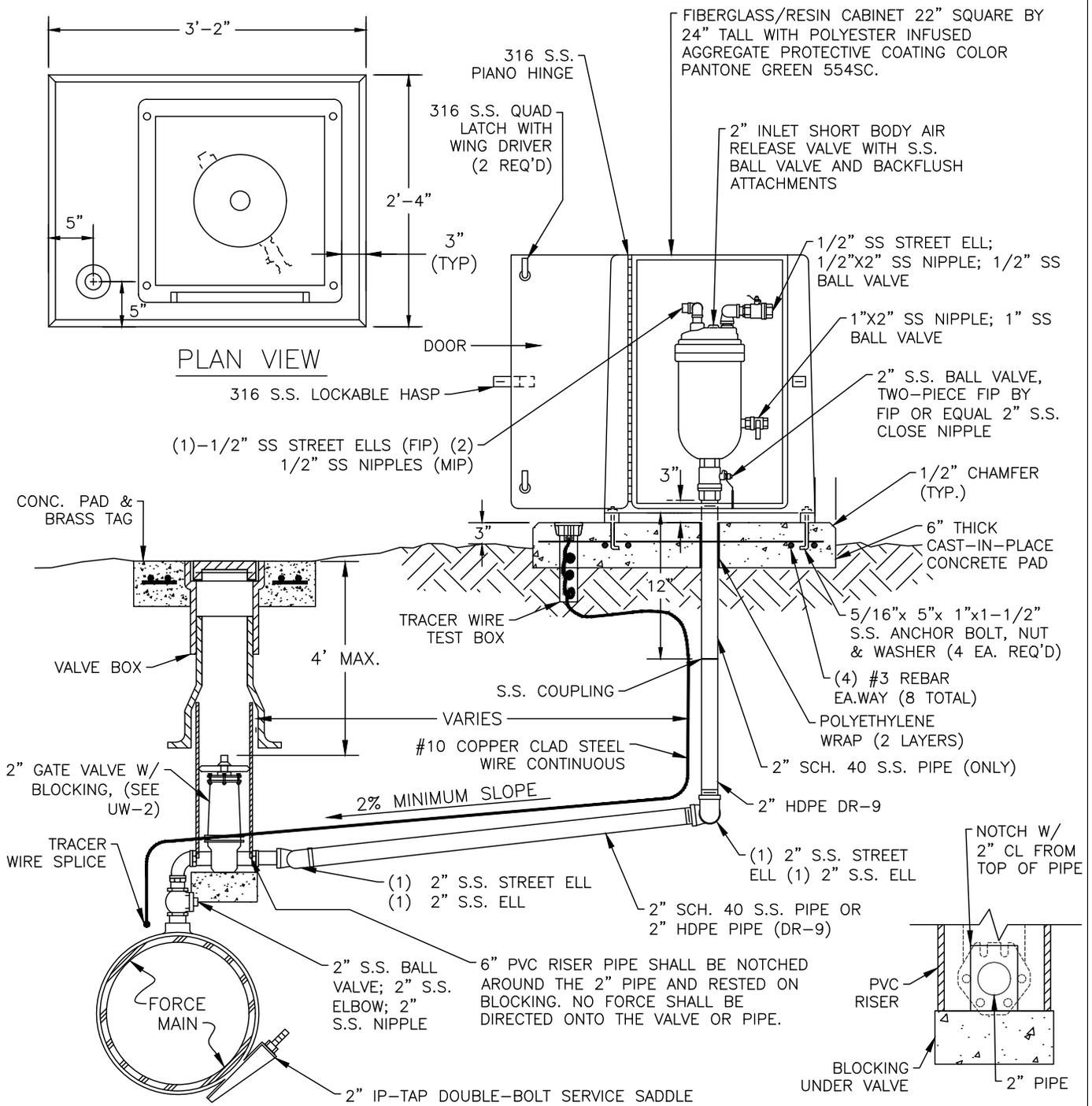

- NOTES:
1. AIR RELEASE VALVES TO BE ABOVE-GROUND INSTALLATIONS, UNLESS IMPRACTICAL. INSTALLATIONS MAY BE BELOW-GROUND ONLY WHERE APPROVED AND SPECIFICALLY INDICATED ON THE PLAN.
 2. AIR RELEASE VALVES TO BE INSTALLED AT HIGH POINTS, OR WHERE AIR WOULD BE ENTRAPPED, ALONG 4" AND LARGER FORCE MAINS.
 3. FORCE MAIN VERTICAL ALIGNMENT TO BE DESIGNED SUCH THAT THE MINIMUM NUMBER OF REQUIRED AIR RELEASE VALVES ARE INSTALLED.
 4. ALL INCIDENTAL FITTINGS AND HARDWARE TO BE 316 STAINLESS STEEL.
 5. ALL PIPE THREADS TO BE SEALED AIR TIGHT.
 6. VENT PIPE TO BE LAID ACCURATELY ON SLOPE, WITHOUT HIGH OR LOW POINTS.
 7. CONCRETE PAD SHALL BE TYPE I CONCRETE W/ 3,000 P.S.I., 28 DAY COMPRESSIVE STRENGTH.
 8. ARV SHALL BE INSTALLED MINIMUM 6 FT FROM EDGE OF PAVEMENT; 10 FT MAXIMUM FROM BACK OF CURB; 4 FT MIN. MAY BE APPROVED BY UTILITIES IN SOME EXISTING AREAS.
 9. SEE UW-2 GATE VALVE, BOX, LID AND TAG STANDARD DETAIL. CENTERING COLLAR IS NOT REQUIRED ON 2" GATE VALVES.

MANATEE COUNTY	
PUBLIC WORKS DEPARTMENT	
REV. BY	DATE
February 25, 2020	
DATE OF APPROVAL	

ABOVE-GROUND AIR
RELEASE VALVE ASSY.
FOR FORCE MAINS

US-9

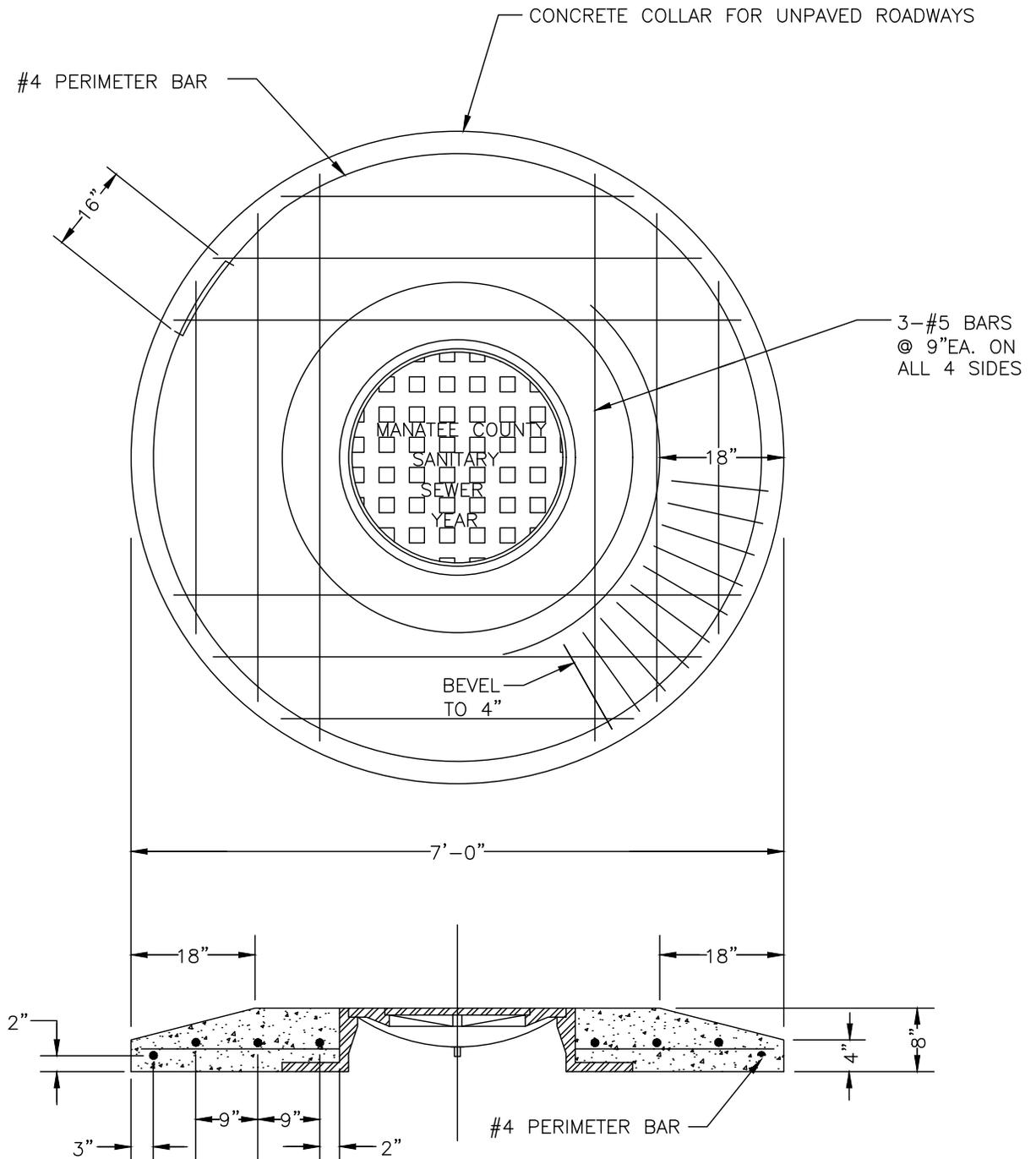

NOTES:

1. OMIT "MANATEE COUNTY", IF PRIVATELY MAINTAINED.
2. PORTLAND CEMENT SHALL CONFORM TO ASTM C150, TYPE 1, AND CONCRETE SHALL HAVE A MINIMUM COMPRESSIVE STRENGTH OF 4,000 P.S.I.

MANATEE COUNTY PUBLIC WORKS DEPARTMENT		MANHOLE COVER & CONCRETE COLLAR FOR UNPAVED ROADWAYS	US-10
REV. BY	DATE		
February 25, 2020 DATE OF APPROVAL			

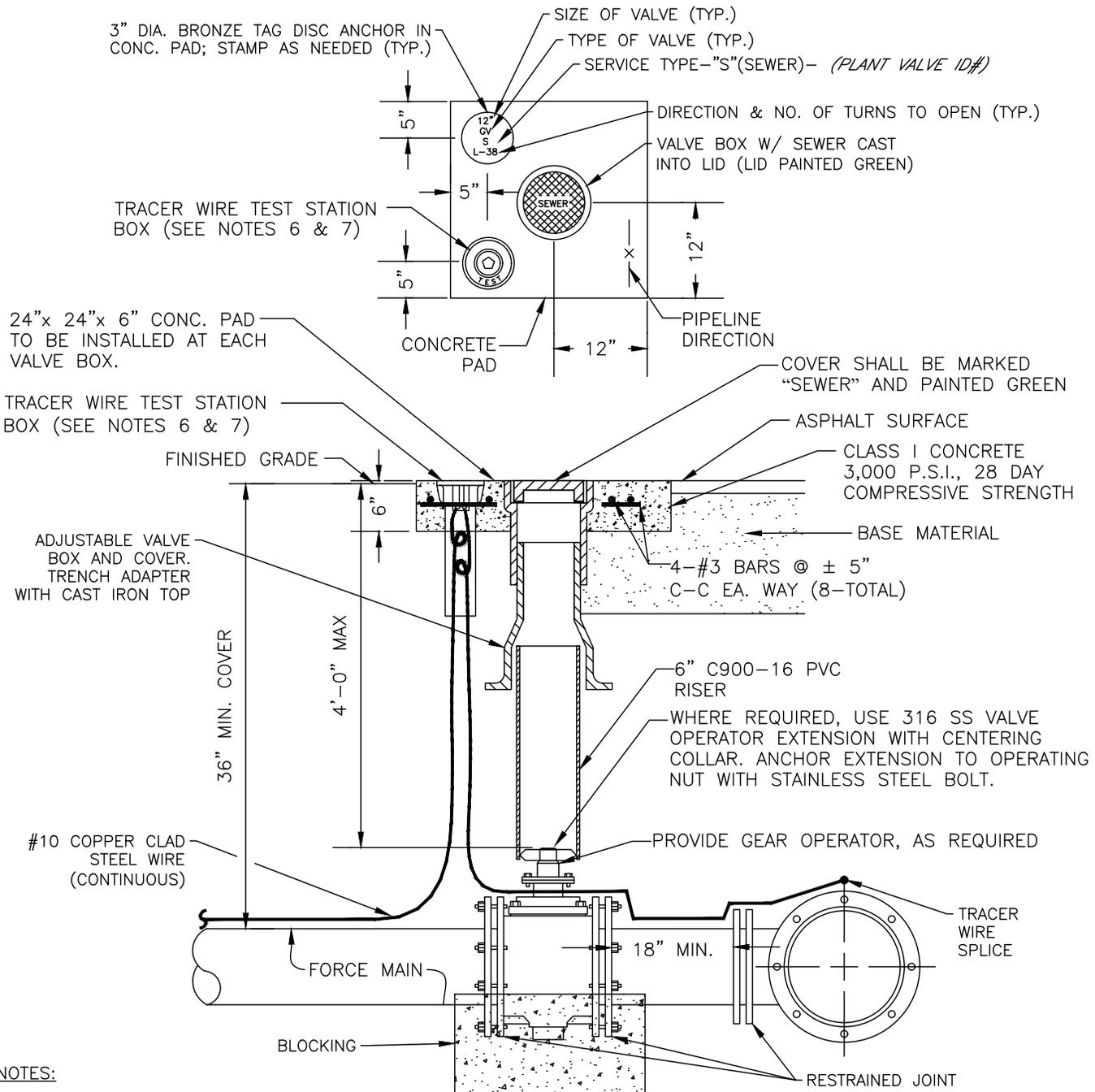

NOTES:

1. "SV" TO BE IMPRESSED INTO THE NEWLY-POURED CONCRETE CURB, ALONG WITH DISTANCE IN FEET TO THE VALVE. IF NO CURB, INSTALL A GREEN DISC WITH "SV" AND A 1/8" x 1" GALVANIZED STEEL SCREW IN THE EDGE OF PAVEMENT WITH THE FOOTAGE FROM THE DISC TO THE VALVE.
2. ALL EXISTING AND PROPOSED VALVE BOXES SHALL BE ADJUSTED TO FINISHED GRADES AS DETERMINED IN THE FIELD.
3. VALVES SHALL NOT BE PLACED IN HANDICAPPED RAMPS, CURBS OR GUTTERS.
4. PRECAST CONCRETE PADS AND THRUST BLOCKS SHALL NOT BE USED.
5. ALL EXPOSED EDGES OF CONCRETE SHALL BE CHAMFERED 1/2".
6. USE NON-TRAFFIC RATED BOXES FOR NORMAL YARD SERVICE. WHERE VALVE WILL BE IN STREET OR PARKING UNDER VEHICLE TRAFFIC, USE TRAFFIC RATED BOXES. WHERE POSSIBLE, LOCATE TRACE WIRE TESTING STATION OUTSIDE OF TRAVEL LANE OR IN MEDIAN, CENTERED IN SEPARATE CONCRETE PAD SIMILAR TO STANDARD VALVE BOX PAD.
7. TRACER WIRE BOX SHALL BE LOCATED OUTSIDE THE ROADWAY ON THOROUGHFARES, LOCAL ARTERIAL AND STATE ROADWAYS.
8. THE BRASS TAG SHALL HAVE A "PLANT VALVE ID#" WHEN VALVES ARE INSTALLED WITHIN THE COUNTY TREATMENT PLANT LIMITS. THE PLANT VALVE ID# SHALL BE SHOWN ON THE CONSTRUCTION PLANS AND RECORD DRAWINGS.
9. REFER TO SECTION 1.11 IN THE PUBLIC WORKS UTILITY STANDARDS MANUAL FOR FURTHER DETAILS.

MANATEE COUNTY	
PUBLIC WORKS DEPARTMENT	
REV. BY	DATE
February 25, 2020	
DATE OF APPROVAL	

VALVE, BOX,
COVER AND TAG

US-11

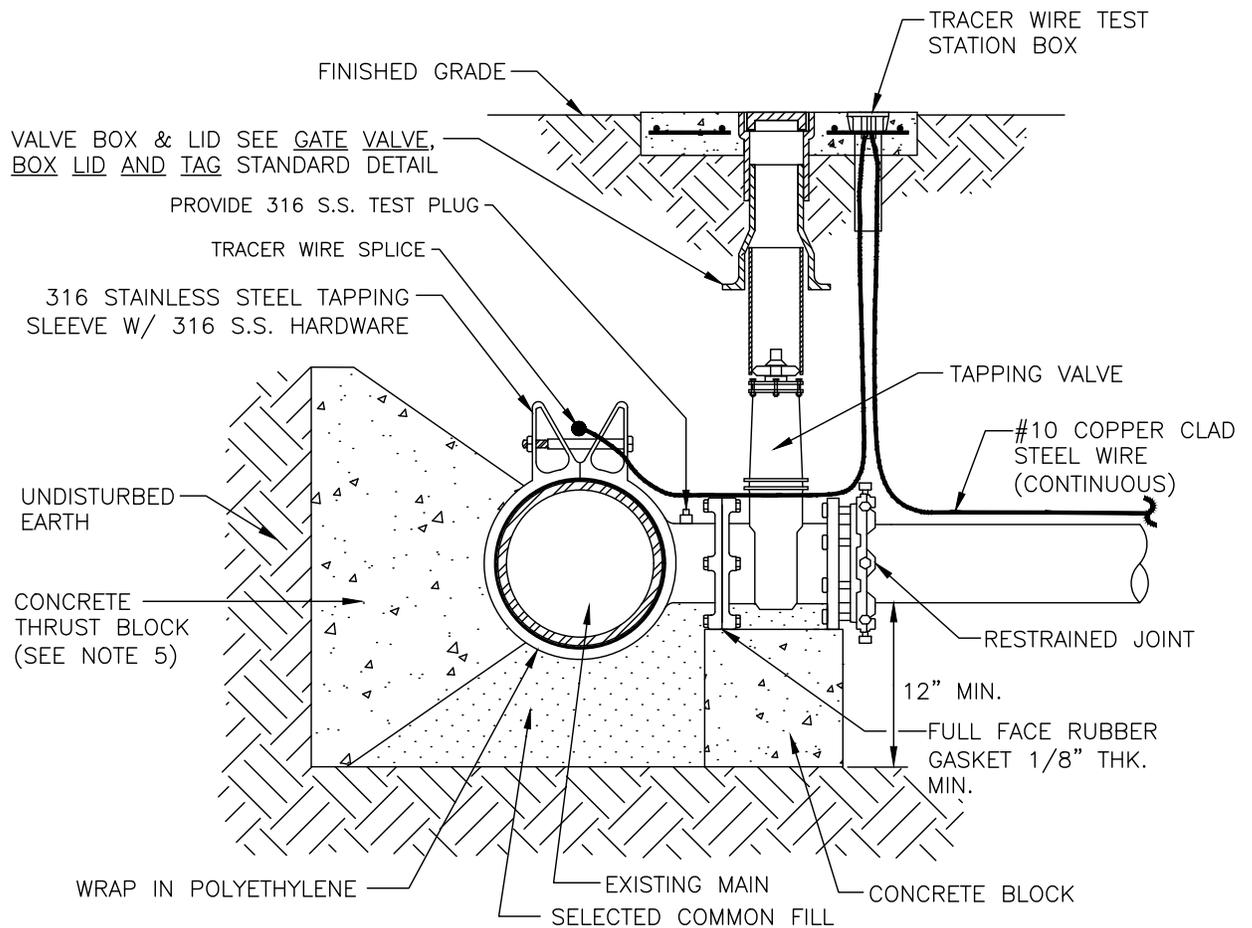

ELEVATION

NOTES:

1. PRIOR TO TAPPING, CONTRACTOR TO DEMONSTRATE 60 MINUTE HYDROSTATIC TEST OF THE TAPPING SLEEVE AND VALVE WITH NO LOSS OF 150 PSI FOR FORCE MAIN.
2. ALL FITTINGS TO BE WRAPPED WITH 20 MIL POLYETHYLENE PLASTIC SHEETING AT THRUST BLOCK.
3. ALL TAPS MUST BE OF A SMALLER SIZE THAN THE MAIN BEING TAPPED & PLACED NO CLOSER THAN 30" OR A DISTANCE EQUAL TO (1) MAIN PIPE DIAMETER PLUS (2) TAP PIPE DIAMETERS (WHICHEVER IS GREATER) FROM A JOINT OR FITTING.
4. CONTRACTOR TO SUPPLY A DRY HOLE FOR TAPPING CREW TO WORK IN AND A BACK-HOE TO LOWER TAPPING MACHINE INTO THE HOLE.
5. WHERE THRUST BLOCK NOT USED, RESTRAINED JOINTS MUST THEN EXTEND FROM TEE FULL LENGTH SPECIFIED FOR "TEES."
6. TRACER WIRE TEST STATION BOX IS REQUIRED AT CONNECTIONS TO EXISTING MAINS.
7. SEE SECTION 1.11 TAPPING SLEEVES AND VALVES IN THE PUBLIC WORKS UTILITY STANDARDS MANUAL FOR FURTHER DETAILS.

MANATEE COUNTY PUBLIC WORKS DEPARTMENT		TAPPING SLEEVE AND VALVE (FORCE MAINS)	US-12
REV. BY	DATE		
		February 25, 2020	
		DATE OF APPROVAL	

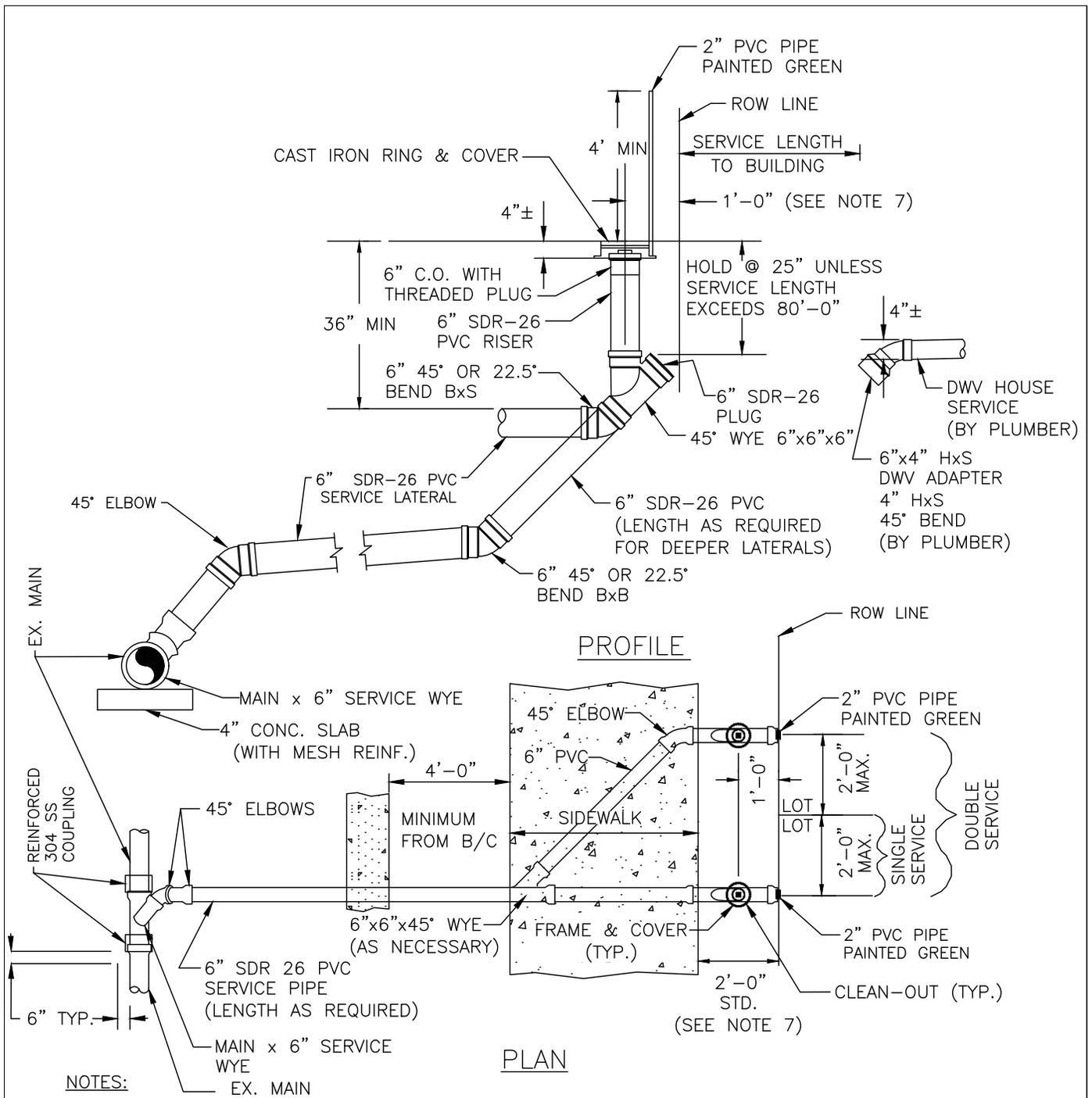

NOTES:

1. RUBBER DONUTS ARE NOT TO BE USED.
2. "SCO" TO BE IMPRESSED INTO THE NEWLY-POURED CONCRETE CURB, ALONG WITH DISTANCE IN FEET TO THE CLEAN-OUT. IF NO CURB INSTALL A GREEN DISC WITH "SCO" AND 1/8" X 1" GALVANIZED STEEL SCREW IN THE EDGE OF PAVEMENT WITH THE FOOTAGE FROM THE DISC TO THE CLEAN-OUT.
3. SANITARY SEWER CLEAN-OUTS SHALL NOT BE LOCATED IN DRAINAGE SWALES, EASEMENTS, SIDEWALKS OR DRIVEWAYS.
4. NO SERVICE CONNECTIONS TO BE MADE TO THE CLEAN-OUT RISER. ALL DOMESTIC CONNECTIONS SHALL BE MADE TO THE STUB-OUT PROVIDED.
5. SEWER SERVICE SHALL BE 5' MIN. FROM WATER SERVICE OR FIRE HYDRANT.
6. CLEAN-OUT ADAPTER TO BE SOLVENT-WELDED TO RISER TOP. CLEAN-OUT THREADS SHALL BE WRAPPED WITH TEFLON PLUMBERS TAPE TO SEAL PLUG WATERTIGHT.
7. WHEN THE DISTANCE BETWEEN THE EDGE OF THE SIDEWALK & THE ROW LINE IS ONE FOOT (CUL-DE-SAC W/MEDIAN) THE DISTANCE BETWEEN THE CENTER OF THE CLEAN-OUT RISER & THE ROW LINE SHALL BE 6".

MANATEE COUNTY PUBLIC WORKS DEPARTMENT		CUT-IN SINGLE AND DOUBLE SERVICE WYES	US-13B
REV. BY	DATE		
		February 25, 2020	
		DATE OF APPROVAL	

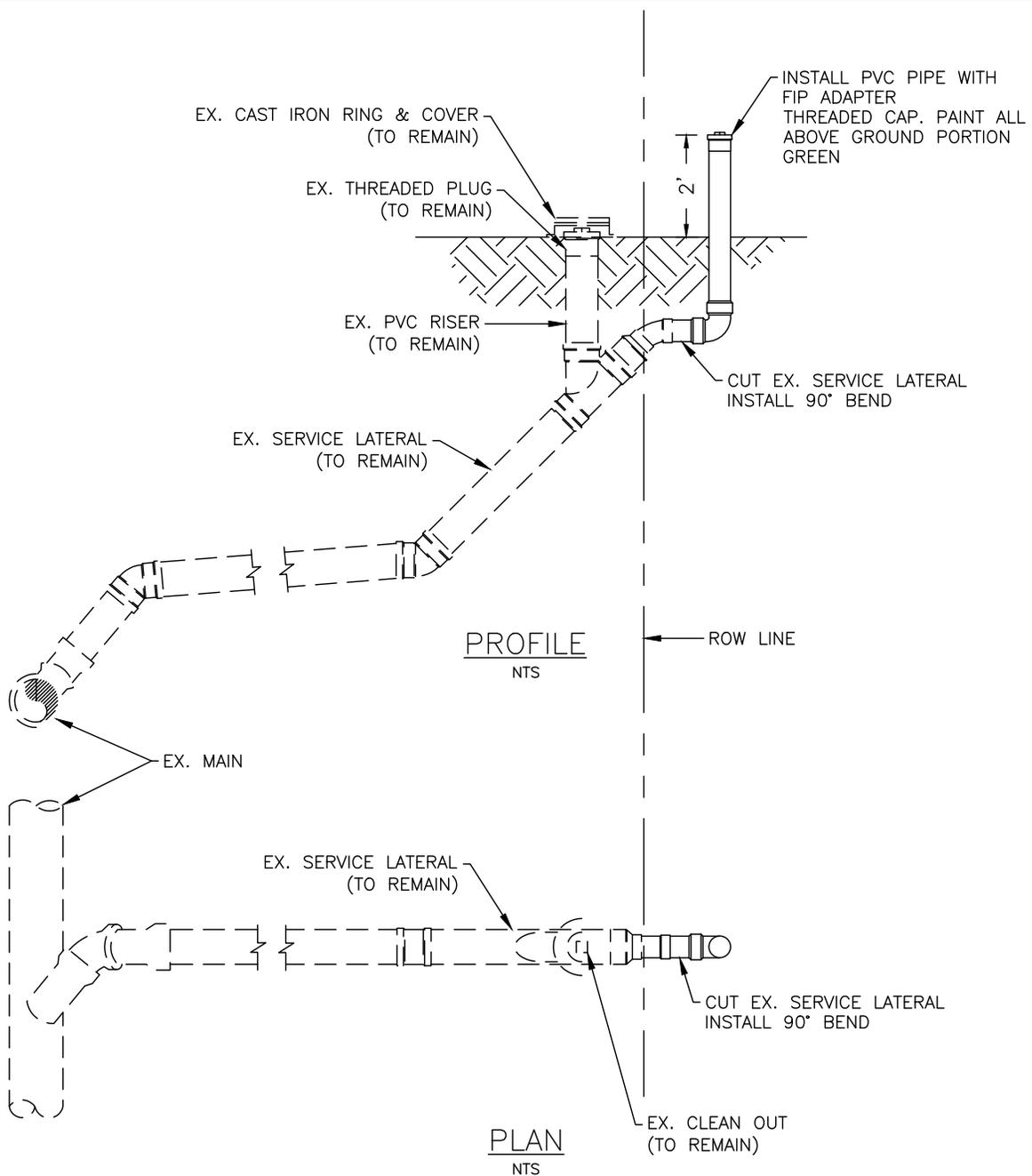

NOTES:

1. RUBBER DONUTS ARE NOT TO BE USED.
2. ALL CONNECTIONS TO BE SOLVENT WELDED, OR WATER-TIGHT PUSH ON JOINTS W/ ELASTOMERIC GASKETS, AWWA C907.

MANATEE COUNTY
PUBLIC WORKS DEPARTMENT

EXISTING SERVICE
CONNECTION
(BUILDING DEMOLITION)

US-13C

REV. BY	DATE

February 25, 2020
DATE OF APPROVAL

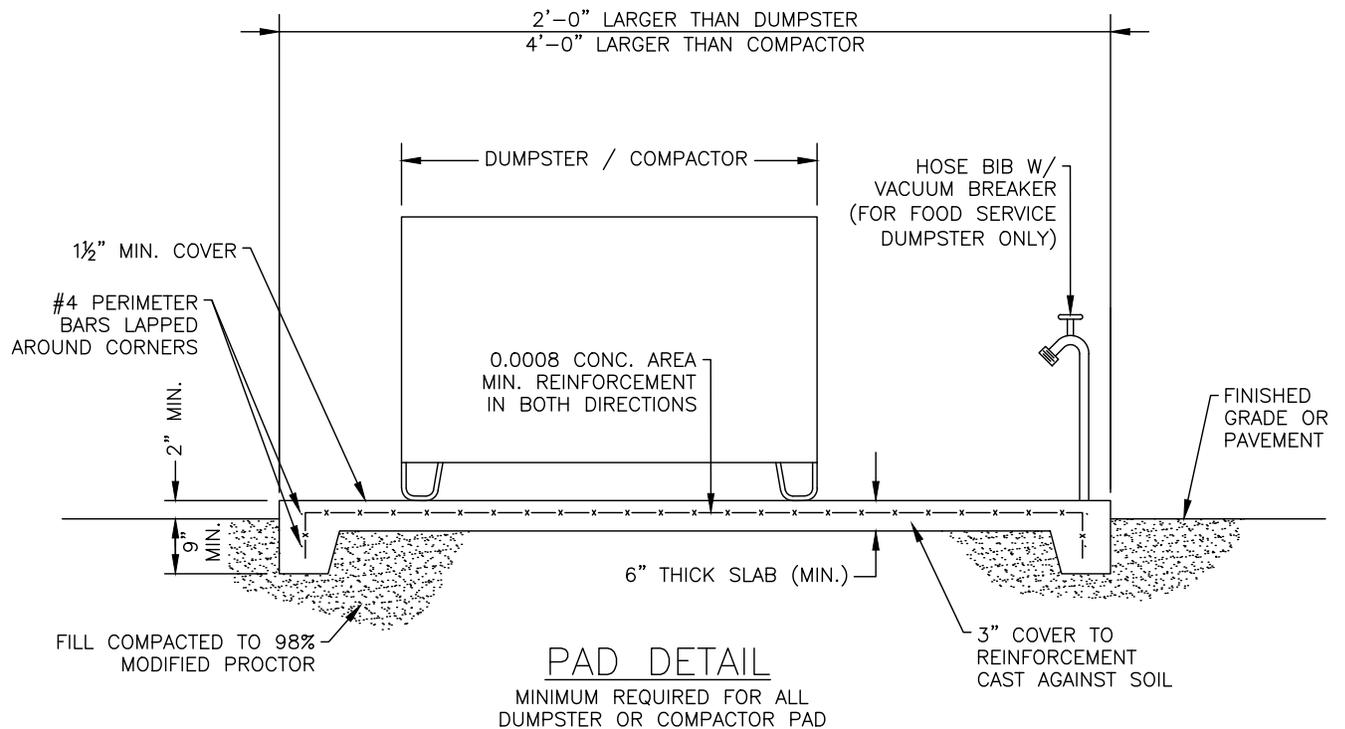

NOTES:

1. DUMPSTER PAD SHALL BE CLASS I CONCRETE W/ MIN. COMP. STRENGTH $f'_c = 3000$ P.S.I. & MIN. REINFORCEMENT STRENGTH $f_y = 60,000$ P.S.I.
2. DUMPSTER PAD SHALL BE FENCED IN ACCORDANCE WITH THE MANATEE COUNTY LAND DEVELOPMENT CODE.
3. ENCLOSURE SIZE TO BE A MINIMUM 10'x20' TO ACCOMMODATE RECYCLING CONTAINERS AND HAVE A MIN. TEN (10') FOOT GATE OPENING FOR EACH CONTAINER.
4. DISCHARGE FROM THE DUMPSTER PAD SHALL BE DIRECTED TO THE ONSITE STORMWATER MANAGEMENT SYSTEM, I.E. CATCH BASIN, SWALES, RETENTION AREA, ETC.
5. WHEN DUMPSTER PAD IS LOCATED ADJACENT TO PROPERTY LINE, DISCHARGE SHALL BE DIRECTED IN THE OPPOSITE DIRECTION AND SHALL NOT DISCHARGE ONTO ADJACENT PROPERTY.

MANATEE COUNTY PUBLIC WORKS DEPARTMENT		COMPACTOR AND DUMPSTER PADS	US-14A
REV. BY	DATE		
February 25, 2020 DATE OF APPROVAL			

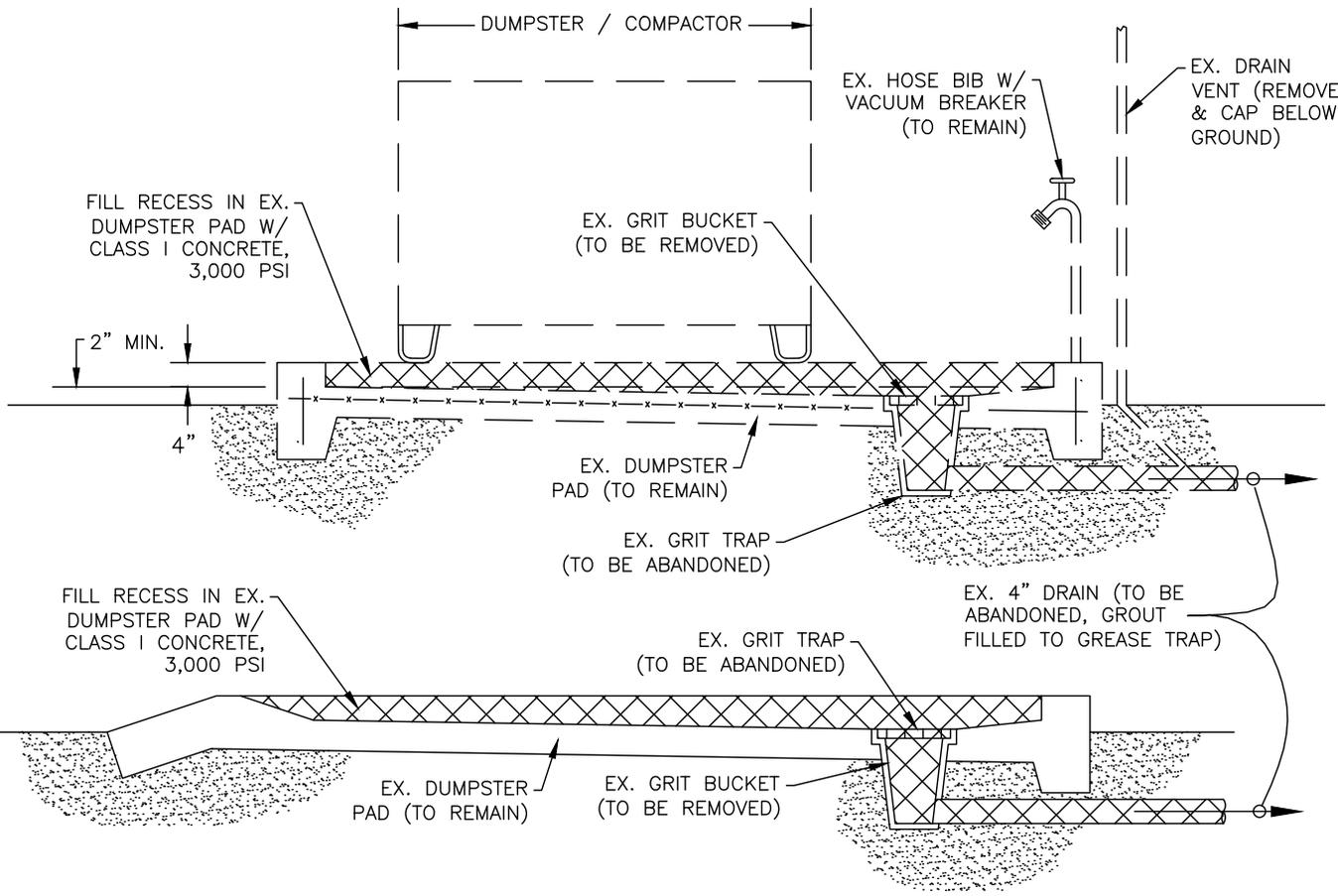

EX. PAD RETROFIT DETAIL
 (REQUIRED FOR EX. DUMPSTER OR COMPACTOR
 PAD AT FOOD SERVICE LOCATION)

NOTES:

1. EX. FOOD DUMPSTER PADS SHALL BE RETROFITTED W/ CONCRETE AND SLOPED TO DRAIN AS INDICATED BELOW TO REMOVE ANY DIRECT CONNECTION(S) TO A SANITARY SEWER SYSTEM.
2. CLASS I CONCRETE W/ MIN. COMP. STRENGTH $f'_c = 3000$ P.S.I. & MIN. REINFORCEMENT STRENGTH $f_y = 60,000$ P.S.I. SHALL BE USED. FLOWABLE FILL MAY BE USED TO ABANDONED THE EXISTING UNDERGROUND PIPING TO THE GREASE TRAP.
3. ALL SURFACE DISCHARGE FROM THE DUMPSTER PAD SHALL BE DIRECTED TO THE ONSITE STORMWATER MANAGEMENT SYSTEM, I.E. CATCH BASIN, SWALES, RETENTION AREA, ETC.
4. WHEN DUMPSTER PAD IS LOCATED ADJACENT TO PROPERTY LINE, DISCHARGE SHALL BE DIRECTED IN THE OPPOSITE DIRECTION AND SHALL NOT DISCHARGE ONTO ADJACENT PROPERTY.

MANATEE COUNTY
 PUBLIC WORKS DEPARTMENT

MODIFICATIONS TO
 EX. COMPACTOR AND
 DUMPSTER PADS

US-14B

REV.BY	DATE

February 25, 2020
 DATE OF APPROVAL

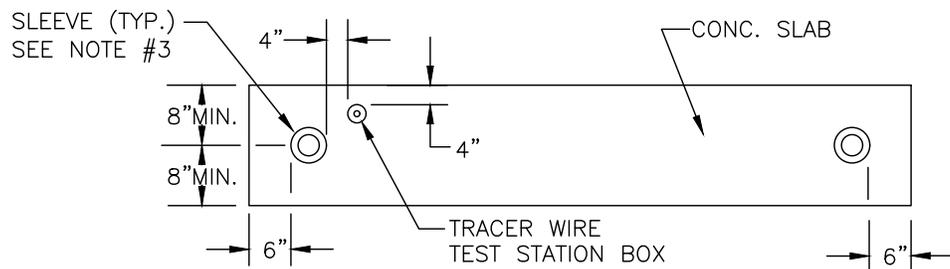
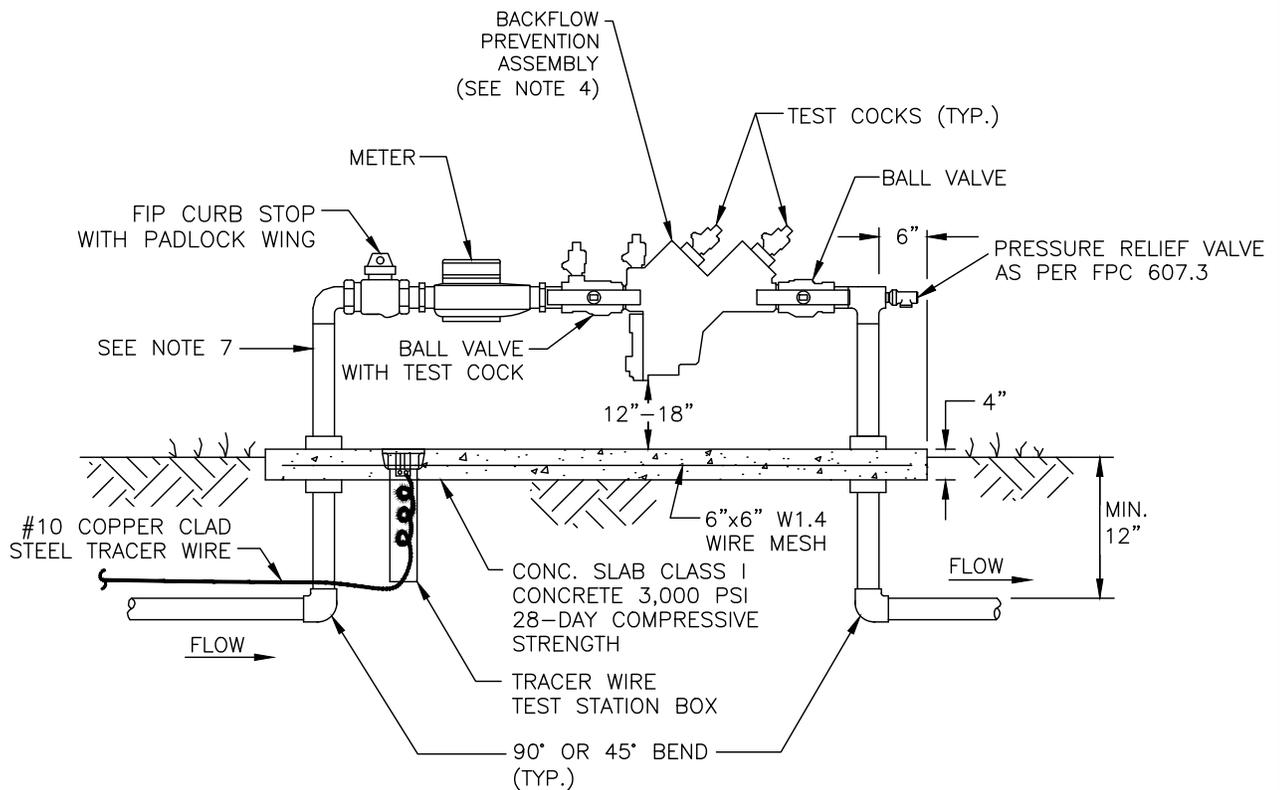

NOTES:

1. BACKFLOW PREVENTION ASSEMBLY DEVICE MUST BE INSTALLED DOWNSTREAM OF METER, AS CLOSE TO METER AS POSSIBLE.
2. COPPER PIPE TYPE ("K" OR "L") OR BRASS PIPE MINIMUM SCHEDULE 40 SHALL BE USED TO A MINIMUM DEPTH OF 12" BELOW GRADE.
3. PIPES PASSING THROUGH OR ENCASED IN CONCRETE MUST BE PROPERLY PROTECTED AND SLEEVED.
4. THE SYSTEM MUST MEET ALL REQUIREMENTS OF THE FLORIDA PLUMBING CODE (LATEST EDITION) AND CHAPTER 2-31, ARTICLE X OF THE MANATEE COUNTY CODE OF ORDINANCES.
5. ALL EXPOSED EDGES OF CONCRETE SHALL BE CHAMFERED 1/2".
6. BACKFLOW PREVENTER SHALL BE TESTED AT THE TIME OF INSTALLATION.
7. PRESSURE REDUCING VALVE REQUIRED UPSTREAM OF BACKFLOW PREVENTION ASSEMBLY, IF SYSTEM PRESSURE EXCEEDS 80 PSI.
8. 3' MIN. CLEARANCE FROM LANDSCAPING PLANTS AND 10' MIN. CLEARANCE FROM TREES TO EDGE OF CONCRETE SLAB AND CLEAR OPENING FOR ACCESS FROM STREET.
9. THE WATER METER AND BACKFLOW PREVENTION ASSEMBLY SHALL BE LOCATED AT THE ROW LINE. THE BACKFLOW PREVENTION ASSEMBLY FOR PRIVATE LIFT STATIONS SHALL BE LOCATED ADJACENT TO THE ROW LINE OR WITHIN AN EASEMENT OUTSIDE OF THE FENCING.
10. SATELLITE LIFT STATIONS SHALL HAVE A 5/8-INCH WATER METER, WITH A 3/4-INCH REDUCED PRESSURE (RPZ) BACKFLOW PREVENTION ASSEMBLY. STATIONS WITH WETWELL DIAMETERS 12 FEET AND LARGER TO HAVE A 2-INCH METER AND RPZ BACKFLOW PREVENTION ASSEMBLY.
11. BACKFLOW PREVENTION ASSEMBLIES USED FOR POTABLE APPLICATIONS SHALL BE LEAD FREE AS DEFINED IN THE REDUCTION OF LEAD IN DRINKING WATER ACT, SECTION 1417 OF THE SAFE DRINKING WATER ACT, 42 U.S.C. 300g-6, AS MAY BE AMENDED, AND IN COMPLIANCE WITH ALL APPLICABLE REGULATIONS

MANATEE COUNTY PUBLIC WORKS DEPARTMENT		WATER METER & BACKFLOW PREVENTION ASSEMBLY FOR LIFT STATIONS	US-15
REV. BY	DATE		
February 25, 2020 DATE OF APPROVAL			

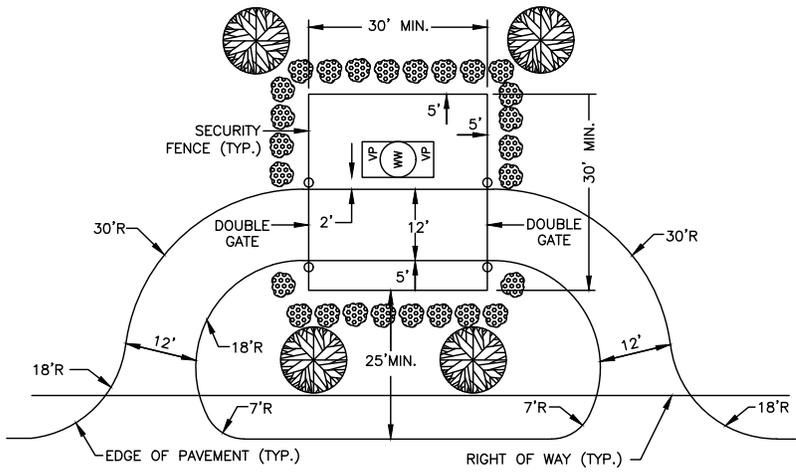

THOROUGHFARE DRIVEWAYS
N.T.S

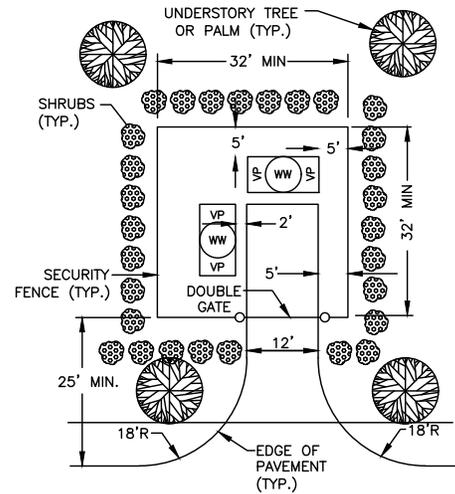

NON-THOROUGHFARE DRIVEWAY
N.T.S

- NOTES:**
1. A MINIMUM SETBACK OF 5 FT SHALL BE PROVIDED BETWEEN LIFT STATION STRUCTURES/EQUIPMENT/VALVE ASSEMBLY AND THE FENCE.
 2. DRIVEWAY SHALL EXTEND UP TO OR BE EVEN WITH THE FURTHEST POINT OF THE WET WELL OR VALVE PAD.
 3. LIFT STATION EASEMENT SHALL EXTEND A MINIMUM OF 15 FT BEYOND ALL FOUR SIDES OF THE LIFT STATION SECURITY FENCE.
 4. OPTIONS FOR PLACEMENT OF WW & VALVE ASSEMBLY (IF NEEDED) ARE INDICATED FOR CLARITY.
 5. A MINIMUM SETBACK OF 5 FT SHALL BE PROVIDED BETWEEN THE SHRUB'S BASE STEM AND THE LIFT STATION SECURITY FENCE.
 6. A MINIMUM SETBACK OF 10 FT SHALL BE PROVIDED BETWEEN THE TRUNK OF SMALL TREES AND THE LIFT STATION SECURITY FENCE.
 7. SPECIFIC LANDSCAPING REQUIREMENTS SHALL BE IN ACCORDANCE WITH SECTION 1.13.11 IN THE PUBLIC WORKS UTILITY STANDARDS MANUAL.
 8. DRIVEWAY MATERIAL SHALL BE CONCRETE AND SHALL BE IN ACCORDANCE WITH MANATEE COUNTY HIGHWAY & TRAFFIC STANDARDS MANUAL FOR THE ENTIRE LENGTH OF THE DRIVEWAY.
 9. DRIVEWAY WILL BE INSTALLED AT GRADE OF SHELL SURROUNDING WET WELL & VALVE ASSEMBLY.

MANATEE COUNTY	
PUBLIC WORKS DEPARTMENT	
REV. BY	DATE
February 25, 2020	
DATE OF APPROVAL	

MINIMUM ACCESS/EGRESS
AND LANDSCAPING
REQUIREMENTS FOR
LIFT STATIONS

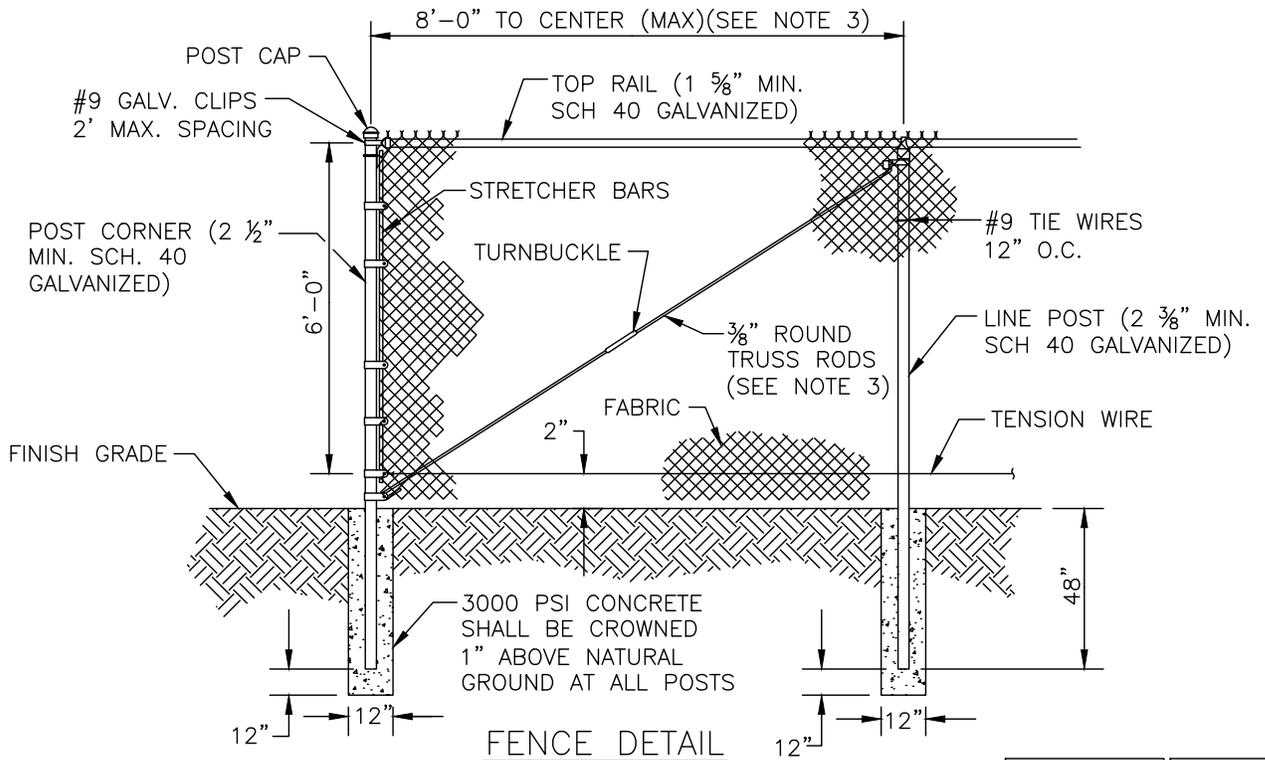
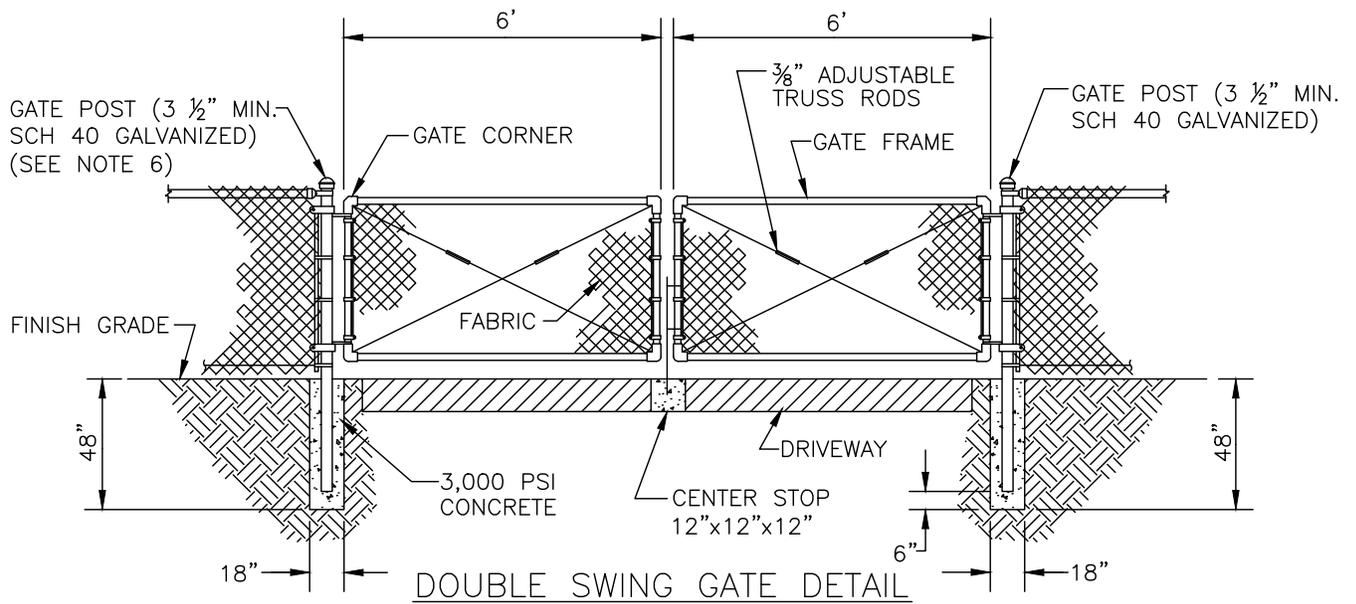

NOTES:

1. FENCING SHALL BE CHAIN LINK, W/ PRIVACY DECORATIVE SLATS (COLOR MATCHED).
2. CHAIN LINK FENCING SHALL BE #9 GAUGE, GALVANIZED STEEL WITH VINYL COATING (BLACK OR GREEN).
3. TRUSS BARS ON CHAIN LINK FENCES ARE REQUIRED FOR THE FIRST SPAN ON EACH SIDE OF THE CORNER POST AND FOR EACH GATE SECTION.
4. LANDSCAPE SCREENING SHALL BE LOCATED ON THE EXTERIOR OF LIFT STATION FENCING.
5. SWING GATES SHALL BE CAPABLE OF SWINGING BOTH INWARDS AND OUTWARDS. CANTILEVER SLIDE GATES AND ROLL SLIDE GATES MEETING FDOT DESIGN STANDARDS MAY BE USED AS AN OPTION TO SWING GATES.
6. GATE POSTS AND TRACK LINE POSTS SHALL BE 4 INCH SCHEDULE 40 FOR CANTILEVER SLIDE GATES AND ROLL SLIDE GATES.

END & CORNER POST TOP OPTIONS		TOP & BOTTOM FABRIC OPTIONS	
STANDARD	DOME	TWIST	KNUCKLE

MANATEE COUNTY PUBLIC WORKS DEPARTMENT		SECURITY FENCING	US-17
REV. BY	DATE		
	February 25, 2020		
	DATE OF APPROVAL		

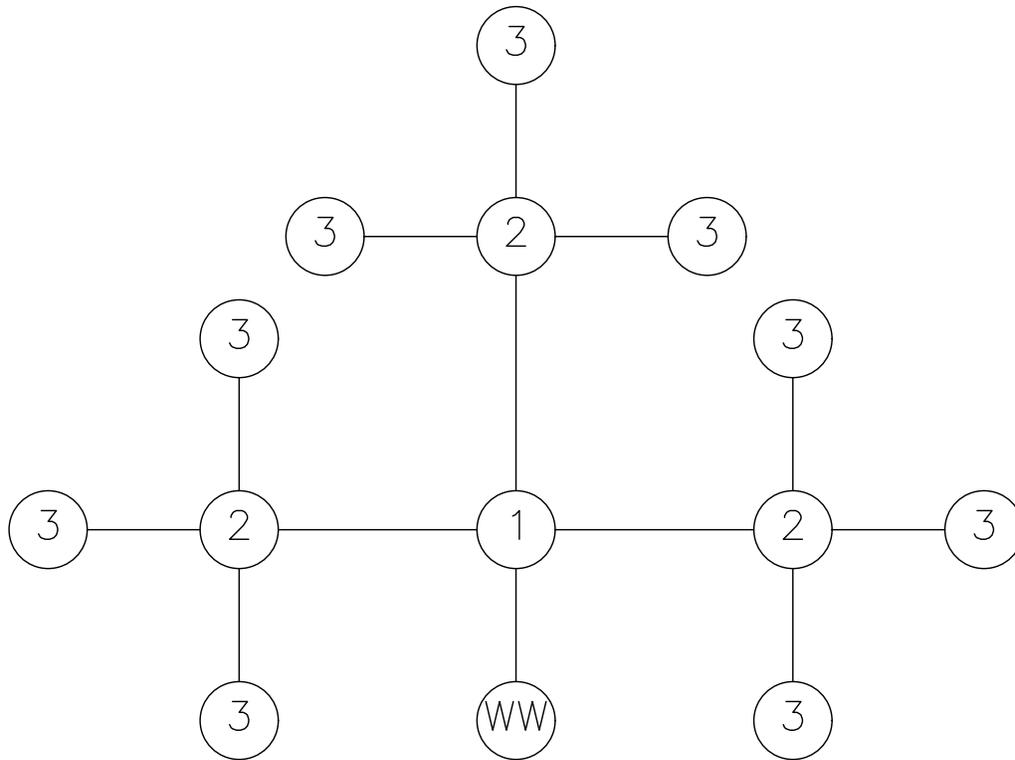

EXAMPLE OF ALL POSSIBLE SCENARIOS

⊙ # # = THE STEP NUMBER FROM THE WET WELL.

NOTES:

1. UPSTREAM MANHOLES WITHIN THREE "STEPS" FROM THE WET WELL SHALL BE POLYMER CONCRETE MANHOLES AS DESCRIBED IN US-3 STANDARD PRE-CAST POLYMER CONCRETE SANITARY SEWER MANHOLE FOR TURBULENT FLOW.
2. THE ABOVE SCHEMATIC SHOWS THE OVERALL INTENT OF WHICH MANHOLES SHALL BE POLYMER CONCRETE AS COUNTED UPSTREAM FROM THE WET WELL.
3. THE FOURTH MANHOLE MAY BE A STANDARD PORTLAND CEMENT CONCRETE MANHOLE, UNLESS THE MANHOLE IS A TURBULENT FLOW MANHOLE AS DESCRIBED IN US-3.

MANATEE COUNTY
PUBLIC WORKS DEPARTMENT

POLYMER CONCRETE
MANHOLES
UPSTREAM FROM
LIFT STATIONS

US-17A

REV.BY	DATE

February 25, 2020
DATE OF APPROVAL

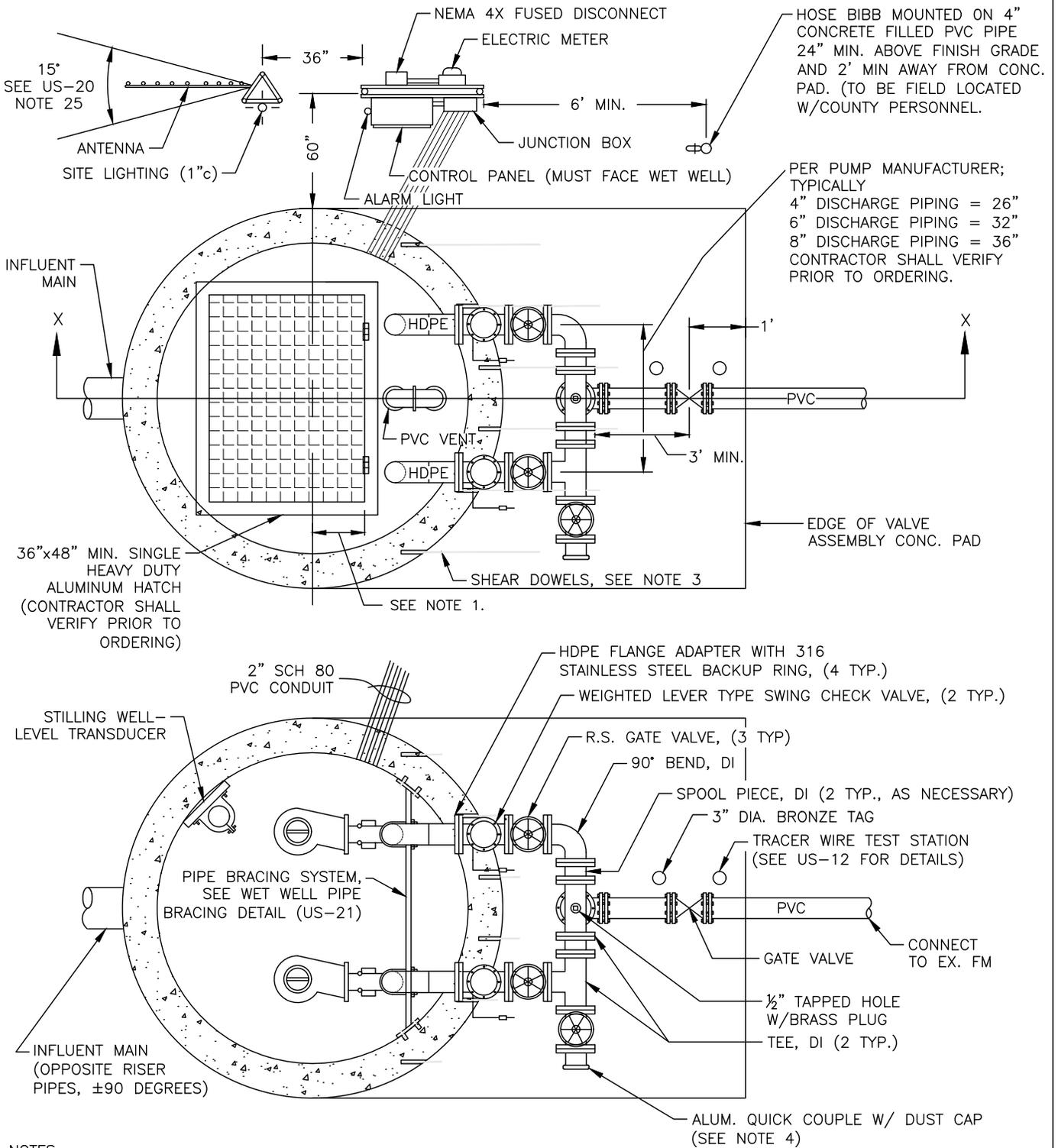

NOTES:

- FOR 6' DIA. WET WELLS, THE HINGED SIDE OF THE HATCH OPENING SHALL BE OFFSET 12" FROM CENTERLINE.
- A FLOW METER SHALL BE INSTALLED UPSTREAM OF ISOLATION GATE VALVE FOR ALL LIFT STATIONS THAT RE-PUMP SEWAGE FROM OTHER LIFT STATIONS.
- #5 REBAR (6 TYP.) SHALL BE EPOXY EMBEDDED INTO THE WET WELL TOP 3-4 INCHES DEEP AND CAST 3-4 FEET INTO THE VALVE ASSEMBLY PAD TO ENSURE THE TOPS OF THE WET WELL AND VALVE ASSEMBLY PAD WILL REMAIN FLUSH.
- QUICK COUPLE SHALL BE PLACED ON THE SIDE CLOSEST TO THE LIFT STATION DRIVEWAY.
- POLYMER CONCRETE W/ 9,000 PSI COMPRESSIVE STRENGTH SHALL BE USED IN THE WET WELL CONSTRUCTION. STANDARD PORTLAND CONCRETE MAY BE USED FOR THE VALVE ASSEMBLY PAD, 3,000 PSI 28-DAY COMPRESSIVE STRENGTH.
- FOR SECTION X-X SEE SEWAGE LIFT STATION, SECTION VIEW ON DETAIL US-19.

MANATEE COUNTY PUBLIC WORKS DEPARTMENT		SEWAGE LIFT STATION PLAN VIEW	US-18
REV. BY	DATE		
	February 25, 2020		
	DATE OF APPROVAL		

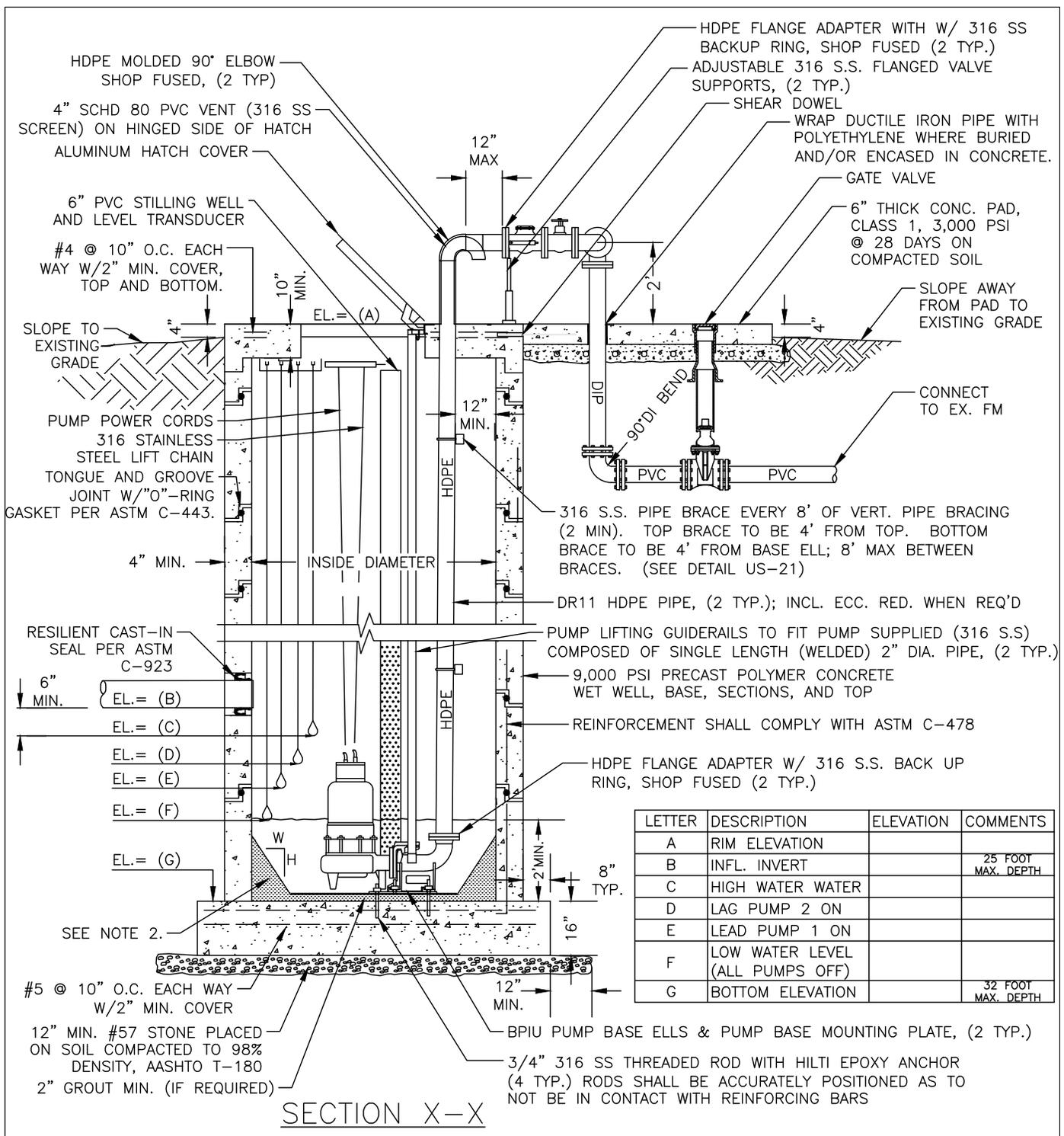

SECTION X-X

- 6" MINIMUM VERTICAL SPACING BETWEEN ALL PUMP AND ALARM CONTROL LEVELS.
- POLYMER CONCRETE FILLET ALL AROUND WET WELL: 6-FT DIA.=12"H x 6"W; 8-FT DIA. & GREATER=18"H x 12"W.
- THE VALVE CONCRETE PAD SHALL BE GIVEN A BROOM FINISH. THE SURFACE VARIATIONS SHALL BE NOT MORE THAT 1/4" UNDER A TEN FOOT (10') STRAIGHT EDGE, NOT MORE THAN 1/8" ON A FIVE FOOT (5') TRANSVERSE SECTION. THE EDGE OF THE CONCRETE PAD SHALL BE CAREFULLY FINISHED WITH A EDGING TOOL HAVING A RADIUS OF 1/2".
- EXPANSION JOINT: EXPANSION JOINTS BETWEEN THE CONC. PAD AND THE WET WELL SHALL BE 1/2" MATERIAL AND SHALL MEET THE REQUIREMENTS OF AASHTO M153 OR AASHTO M213.
- THIS DETAIL SHALL APPLY TO LIFT STATIONS WITH 4" OR GREATER FORCE MAINS. LIFT STATIONS WITH FORCE MAINS LESS THAN 4" REFER TO DETAIL US-27A.

MANATEE COUNTY PUBLIC WORKS DEPARTMENT		SEWAGE LIFT STATION SECTION VIEW	US-19
REV. BY	DATE		
February 25, 2020 DATE OF APPROVAL			

GENERAL LIFT STATION NOTES:

1. ALL ACCESS COVERS SHALL BE ALUMINUM, WITH 316 STAINLESS STEEL HARDWARE AND RATED FOR 300 P.S.F. LOADING. ALL ALUMINUM SURFACES IN CONTACT WITH CONCRETE SHALL HAVE 2 COATS BITUMASTIC EPOXY, TOTAL 16 MILS DFT. ALL ACCESS COVERS SHALL BE EQUIPPED WITH A LOCKING STAPLE OR BAR FOR USE WITH A PADLOCK. PADLOCKS FOR WETWELL, FENCE GATE AND CONTROL PANELS OF PUBLICLY OWNED & MAINTAINED LIFT STATIONS SHALL BE FURNISHED BY THE MANATEE COUNTY UTILITIES DEPARTMENT, UPON ACCEPTANCE.
2. INSTALL WET WELL VENT ON THE HINGED SIDE OF THE WET WELL HATCH COVER, BETWEEN DISCHARGE PIPING AND MATCH HEIGHT.
3. GROUND SHALL BE SLOPED AWAY FROM SLAB TO NATURAL GROUND ELEVATION IN ALL DIRECTIONS. A 4-INCH REVEAL SHALL BE PROVIDED AROUND THE STRUCTURES. SITE SHALL INCLUDE A WEED BARRIER FABRIC THAT IS COVERED WITH WASHED SHELL OR ROCK WITHIN LIFT STATION FENCING; SITE SHALL INCLUDE A WEED BARRIER FABRIC THAT IS COVERED WITH SHREDDED WOOD TYPE MULCH UNDER THE SHRUBS AND UP TO OUTSIDE OF THE FENCE. WEED BARRIER FABRIC THAT IS COVERED WITH SHREDDED WOOD-TYPE MULCH SHALL BE LOCATED UNDER THE TREES FOR A MINIMUM DISTANCE OF 3 FEET FROM THE TREE. SODDING OR SHREDDED WOOD-TYPE MULCH SHALL BE INSTALLED ON THE REMAINDER OF THE SITE TO THE EDGE OF THE EASEMENT.
4. ALL FORCE MAIN PIPING AND FITTINGS FROM THE PUMP BASE ELBOW IN THE WETWELL UP TO THE CHECK VALVE IN THE ABOVE GROUND VALVE ASSEMBLY, SHALL BE DR11 HDPE. THE HDPE FITTINGS SHALL BE MOLDED FITTINGS. ALL CONNECTIONS TO IRON BODIED FLANGE FITTINGS IN THE WETWELL (PUMP BASE ELLS) AND TO THE CHECK VALVES SHALL BE MADE USING HDPE FLANGE ADAPTERS WITH 316 STAINLESS STEEL BACKUP RINGS. ALL HDPE CONNECTIONS SHALL BE THERMAL FUSED. ALL PIPING DOWNSTREAM OF THE VALVE ASSEMBLY TO THE FIRST BURIED FITTING SHALL BE DUCTILE IRON PIPE (CL-53), THEN PVC (DR18).
5. ALL PIPING BELOW GROUND SHALL BE COLOR CODED IN ACCORDANCE WITH THESE STANDARDS. GREEN-RAW SEWAGE; PURPLE-RECLAIMED; BLUE-POTABLE WATER.
6. ANCHORS & LIFTING DEVICES SHALL NOT PENETRATE THE WALLS OF THE WET WELL.
7. ALL TOP, SECTIONS, AND BASE SHALL BE PRECAST POLYMER CONCRETE, MIN. 9,000 PSI COMPRESSIVE STRENGTH. SEE PRECAST POLYMER CONCRETE SANITARY SEWER MANHOLE FOR TURBULENT FLOW DETAIL.
8. ALL ABOVE-GROUND METAL APPURTENANCES INCLUDING BOLTS, NUTS AND WASHERS SHALL BE 316 STAINLESS STEEL. ALL STAINLESS STEEL BOLTS SHALL BE TREATED WITH NEVER-SEIZE PRIOR TO ASSEMBLY.
9. VERTICAL HDPE PUMP DISCHARGE PIPE IN THE WET WELL SHALL BE BRACED PER DETAIL US-21. THE PIPE SHALL BE CLAMPED TO A SINGLE LENGTH OF 2" 316 SS TUBING (OR 2" 316 SS ANGLE) INSTALLED HORIZONTALLY. THE TUBE SHALL HAVE 6"x6"x1/4" PLATES WELDED TO EACH END AND ATTACH TO THE WALL BY 316 SS ANCHORS. THE PIPE SHALL BE CLAMPED TO THE TUBING WITH CUSHIONED 316 SS U-BOLTS.
10. CONTRACTOR SHALL TAKE ALL NECESSARY PRECAUTIONS TO PREVENT FLOTATION.
11. TOP OF WET WELL AND VALVE ASSEMBLY SLAB SHALL BE AT THE SAME ELEVATION.
12. THE EXTERIOR SURFACES OF THE CONCRETE WET WELL AND VALVE ASSEMBLY PAD EXPOSED ABOVE GRADE SHALL BE COATED WITH A LEAST TWO COATS OF H&C SILICONE ACRYLIC CONCRETE STAIN, PATIO GREEN, MANUFACTURED BY FLR PAINTS, INC. ABOVE GROUND VALVE ASSEMBLY & PIPING SHALL BE PAINTED, RUSTOLEUM 7538 HUNTER GREEN. CONTRACTOR SHALL TAKE PRECAUTIONS TO AVOID OVER-SPRAY ONTO THE VALVE ASSEMBLY CONCRETE PAD.
13. FOR 5/8" WATER METER, PROVIDE POTABLE WATER SERVICE CONNECTION WITH 3/4" BRASS HOSE BIB. PROVIDE AN APPROVED BACKFLOW PREVENTION ASSEMBLY INSTALLED AT THE ROW. ALL WATER SERVICE PIPING FROM WATER METER TO BE TYPE "K" COPPER OR BRASS; 3/4" MIN. DIAMETER FOR 5/8" METER AND 2" MIN. DIAMETER PIPING FOR 2" METER.
14. LANDSCAPING SHALL BE IRRIGATED WITH NON-POTABLE WATER. A RAIN SENSOR SHALL BE FURNISHED AND INSTALLED.
15. HOSE BIB TO BE A MINIMUM OF 6 FEET FROM THE ELECTRICAL CONTROL PANEL, 24" ABOVE THE SURROUNDING FINISH GRADE, AND ANCHORED TO A 4" PVC CONCRETE FILLED PIPE. EXACT LOCATION TO BE DETERMINED IN THE FIELD W/COUNTY PERSONNEL.
16. WATER METER ASSEMBLY TO BE INSTALLED BY CONTRACTOR AS PART OF WATER SERVICE CONNECTION WITH FEES PAID BY THE DEVELOPER.
17. BASE AND FIRST WALL SECTION OF WET WELL SHALL BE MONOLITHIC.
18. EVERY EFFORT SHALL BE MADE BY THE CONTRACTOR TO CONSTRUCT WATERTIGHT STRUCTURES WITH NO VISIBLE LEAKS. COMPLETED STRUCTURES THAT ARE NOT WATERTIGHT AND/OR DO NOT MEET THE REQUIREMENTS OF ASTM C-443 WILL BE REJECTED.
19. FLEXIBLE GASKET CONNECTORS SHALL MEET THE REQUIREMENTS OF ASTM C-923 LATEST REVISION.
20. ALL GATE VALVES SHALL BE RESILIENT SEAT NON-RISING STEM TYPE IN ACCORDANCE WITH THESE STANDARDS.
21. ELECTRICAL SERVICE SHALL BE 3 PHASE MINIMUM, UNLESS THE ELECTRICAL UTILITY PROVIDES CORRESPONDENCE STATING THAT 3 PHASE SERVICE IS UNAVAILABLE.
22. ELECTRICAL CONDUIT SHALL BE RUN BY THE SHORTEST ROUTE POSSIBLE FROM THE ELECTRICAL SOURCE TO THE CONTROL PANEL AND FROM THE CONTROL PANEL TO THE LIFT STATION WET WELL.
23. A FLOW METER AND EMERGENCY BACKUP PUMP SHALL BE REQUIRED FOR ALL LIFT STATIONS THAT MEET THE CRITERIA LISTED IN SECTION 1.14.14 OF THE PUBLIC WORKS UTILITY STANDARDS MANUAL.
24. THE CONTROL PANEL, HOSE BIB, EMERGENCY BACKUP PUMP, FUEL STORAGE TANK AND ANTENNA SHALL NOT BE LOCATED BETWEEN THE WET WELL, VALVE ASSEMBLY AND THE DRIVEWAY. THE PUMP SHALL NOT BE LOCATED WITHIN 25 FEET OF THE EDGE OF THE LIFT STATION EASEMENT AT THE ROW LINE.
25. THE ANTENNA FOR THE RADIO TELEMETRY UNIT REQUIRES DIRECT LINE-OF-SIGHT SIGNALING CAPABILITY TO THE UTILITIES DEPARTMENT'S OFFICE THAT WILL RECEIVE THE SIGNAL. THERE SHALL BE AN UNOBSTRUCTED HORIZONTAL ANGLE OF FIFTEEN (15) DEGREES FROM THE ANTENNA MAST (7.5 DEGREES ON BOTH SIDES OF THE DIRECT LINE-OF-SIGHT AZIMUTH). NO TREE SHALL BE PLANTED WITHIN THE DESIGNATED UNOBSTRUCTED ANGLE FOR A TWENTY (20) FEET HORIZONTAL DISTANCE MEASURED FROM THE MAST. LANDSCAPE BUFFER PLANTINGS ARE TO BE FIELD ADJUSTED IN COORDINATION WITH THE LOCATION OF THE CONSTRUCTED TELEMETRY ANTENNA. THE ANTENNA TOWER/MAST SHALL BE TO THE LEFT OF THE CONTROL PANEL.

MANATEE COUNTY PUBLIC WORKS DEPARTMENT		LIFT STATION NOTES	US-20
REV. BY	DATE		
February 25, 2020 DATE OF APPROVAL			

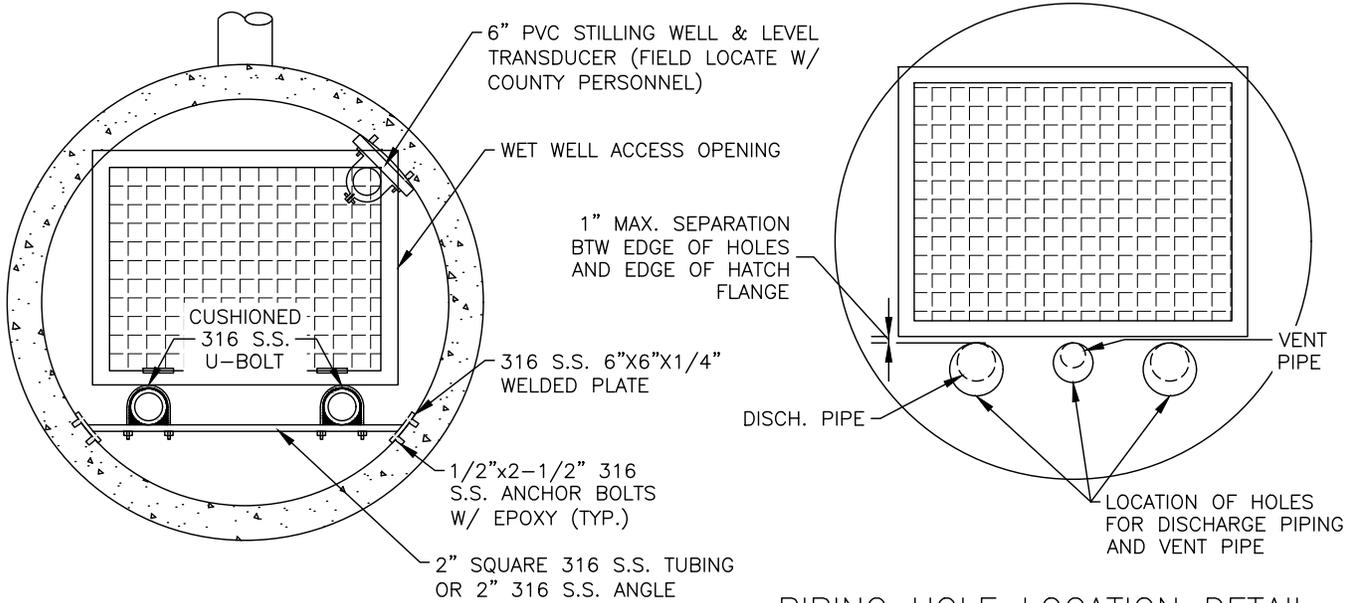

WET WELL PIPE BRACING DETAIL

PIPING HOLE LOCATION DETAIL

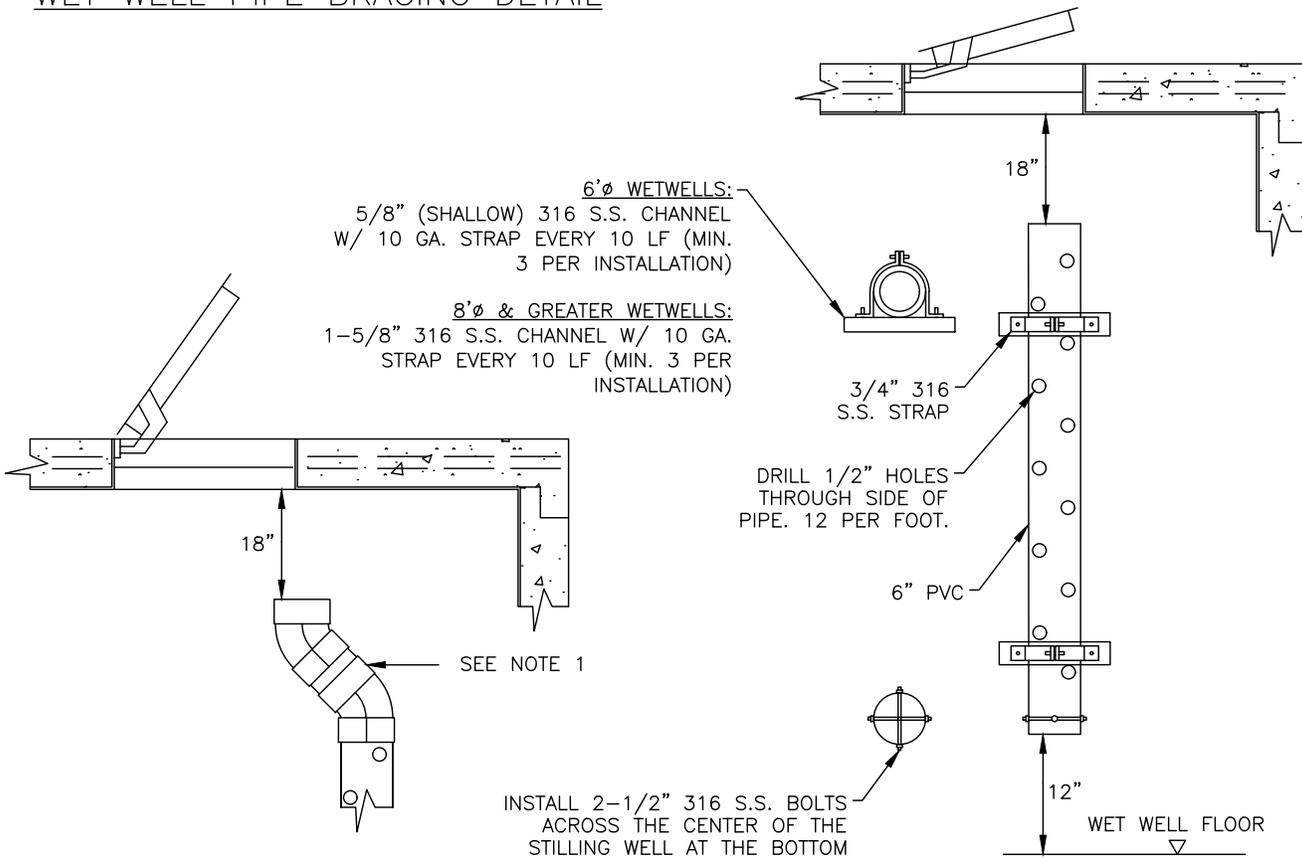

NOTES:

STILLING WELL DETAILS

1. FOR LARGER LIFT STATIONS, PROVISIONS SHALL BE MADE TO MAKE THE TOP OF THE STILLING WELL VISIBLE AND ACCESSIBLE FROM THE HATCH OPENING, I.E. 45° FITTINGS, ETC.
2. REFER TO STANDARD DETAILS US-18, US-19 & US-20 FOR LIFT STATION DETAILS.
3. NYLON LOCK NUTS SHALL NOT BE USED ON WEDGE ANCHORS.

MANATEE COUNTY
PUBLIC WORKS DEPARTMENT

REV. BY	DATE

February 25, 2020
DATE OF APPROVAL

LIFT STATION PIPE
BRACING, & STILLING
WELL DETAILS

US-21

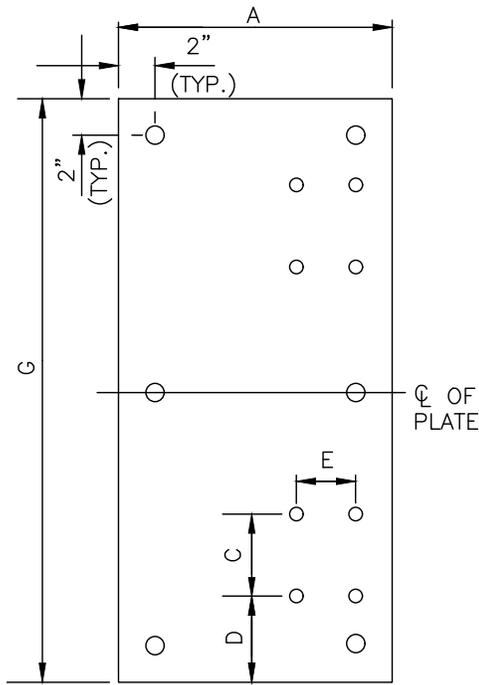

PLAN FOR PUMPS 2" AND SMALLER

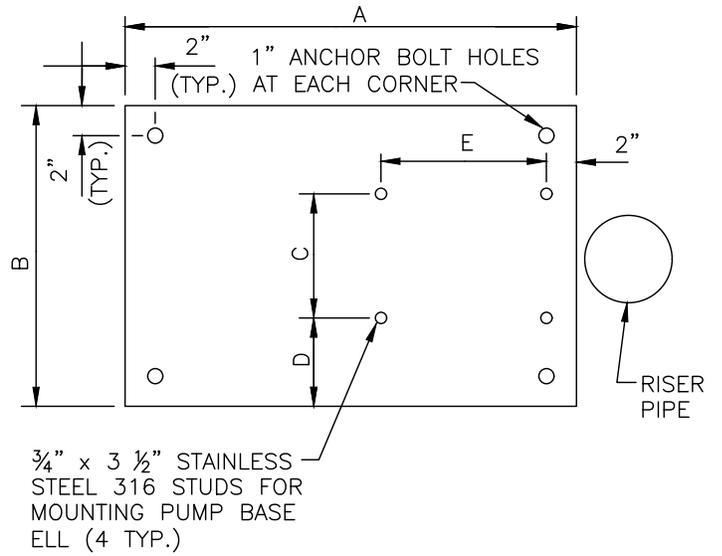

PLAN

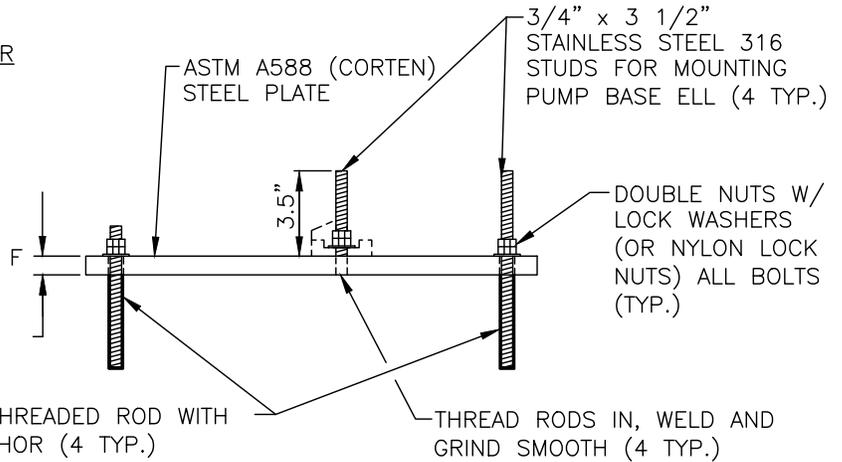

PROFILE

PUMP BASE ELL MOUNTING PLATE DIMENSIONS							
DIMENSIONS	A	B	C	D	E	F	G
FOR 6" PUMPS	24"	20"	8.25"	5.875"	11"	3/4"	N/A
FOR 4" PUMPS	20"	16"	6"	5"	10"	1/2"	N/A
2" PUMPS & SMALLER	15"	N/A	4.5"	4.75"	3.25"	1/2"	32"

NOTES:

1. INSTALL DOUBLE NUTS (OR NYLON LOCK NUTS) ON ALL EIGHT (8) THREADED RODS.
2. THE PLATE EDGES AND ALL HOLES SHALL BE GROUND SMOOTH TO REMOVE ALL BURRS.
3. DIMENSIONS "C" & "E" ARE FOR BARNEY'S PUMPS, INC. BASE ELLS.
4. FOR PUMPS WITH A 2-INCH DISCHARGE OR LESS, A SINGLE BASE PLATE SHALL BE INSTALLED UNDER BOTH GRINDER PUMPS.

MANATEE COUNTY PUBLIC WORKS DEPARTMENT		PUMP BASE ELL MOUNTING PLATE	US-22
REV. BY	DATE		
February 25, 2020 DATE OF APPROVAL			

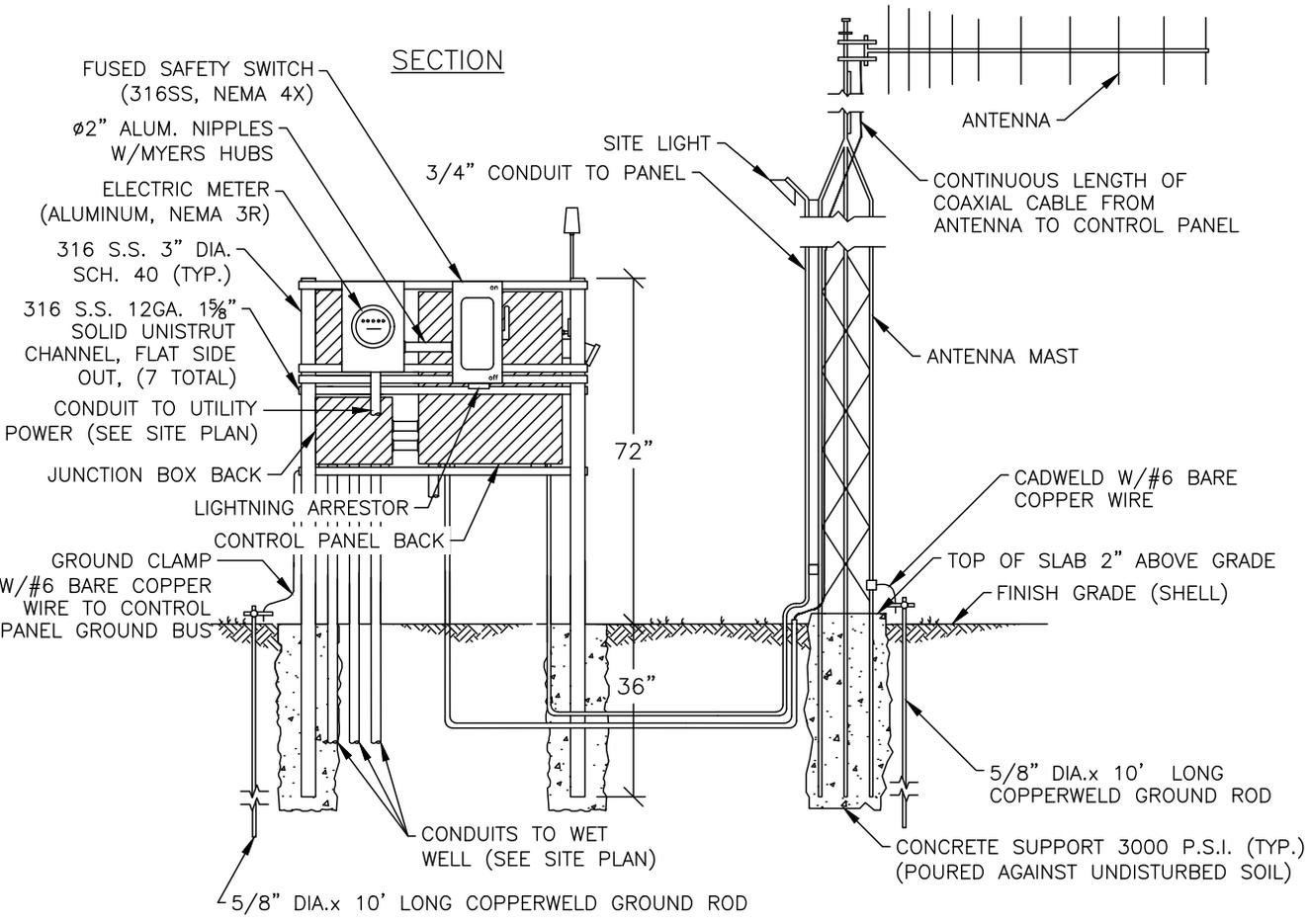
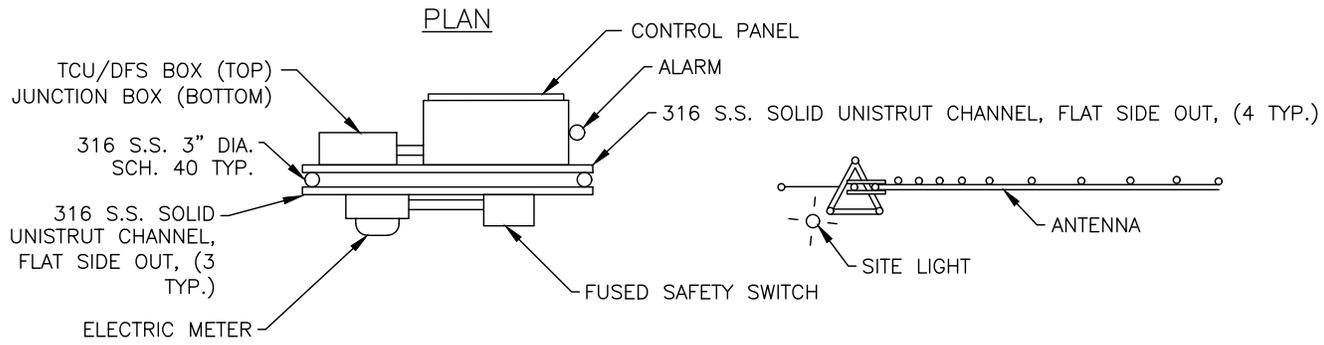

TYPICAL SERVICE ENTRANCE STRUCTURE

NOTES

1. ALL EQUIPMENT FURNISHED FOR THE LIFT STATION SHALL CONFORM TO MANATEE COUNTY PUBLIC WORKS UTILITY STANDARDS.
2. POWER TO BE SUPPLIED AS DIRECTED, THE CONTRACTOR SHALL BE RESPONSIBLE FOR ALL COSTS ASSOCIATED WITH PROVIDING TEMPORARY AND PERMANENT ELECTRICAL SERVICE.
3. STAINLESS STEEL CONTROL PANEL SUPPORT POSTS SHALL BE TREATED WITH TWO COATS OF BITUMINOUS EPOXY TO 16 MILS WHERE EMBEDDED IN CONCRETE.
4. CONTROL AND FLOW METER ENCLOSURE TO BE NEMA 3R/12 304 STAINLESS STEEL WITH RAIN SHIELD. DISCONNECT ENCLOSURE TO BE NEMA 4X 304 STAINLESS. STEEL.
5. ALL P.V.C. CONDUIT SHALL BE SCHEDULE 80.
6. ANTENNA MAST SHALL BE RATED FOR 150 MPH WINDS.
7. IF ANTENNA MAST IS MORE THAN 18" FROM PANEL, RUN CONDUIT FOR SITE LIGHT UNDERGROUND.

MANATEE COUNTY
PUBLIC WORKS DEPARTMENT

SEWAGE LIFT STATION
METER & ELECTRICAL
DETAILS

US-23

REV. BY DATE

February 25, 2020
DATE OF APPROVAL

NOTES

1. TYPICAL CONTROL PANEL SHALL BE 30"X36". CONTROL PANEL DIMENSIONS MAY INCREASE WITH L.S. PUMPS GREATER THAN 20 H.P. 230V PANEL ILLUSTRATED, (30" WIDE)
2. ALL HARDWARE SHALL BE 316 STAINLESS STEEL.
3. PUMP CONTROL PANEL AND JUNCTION BOX ARE TO BE POWDER COATED WHITE.

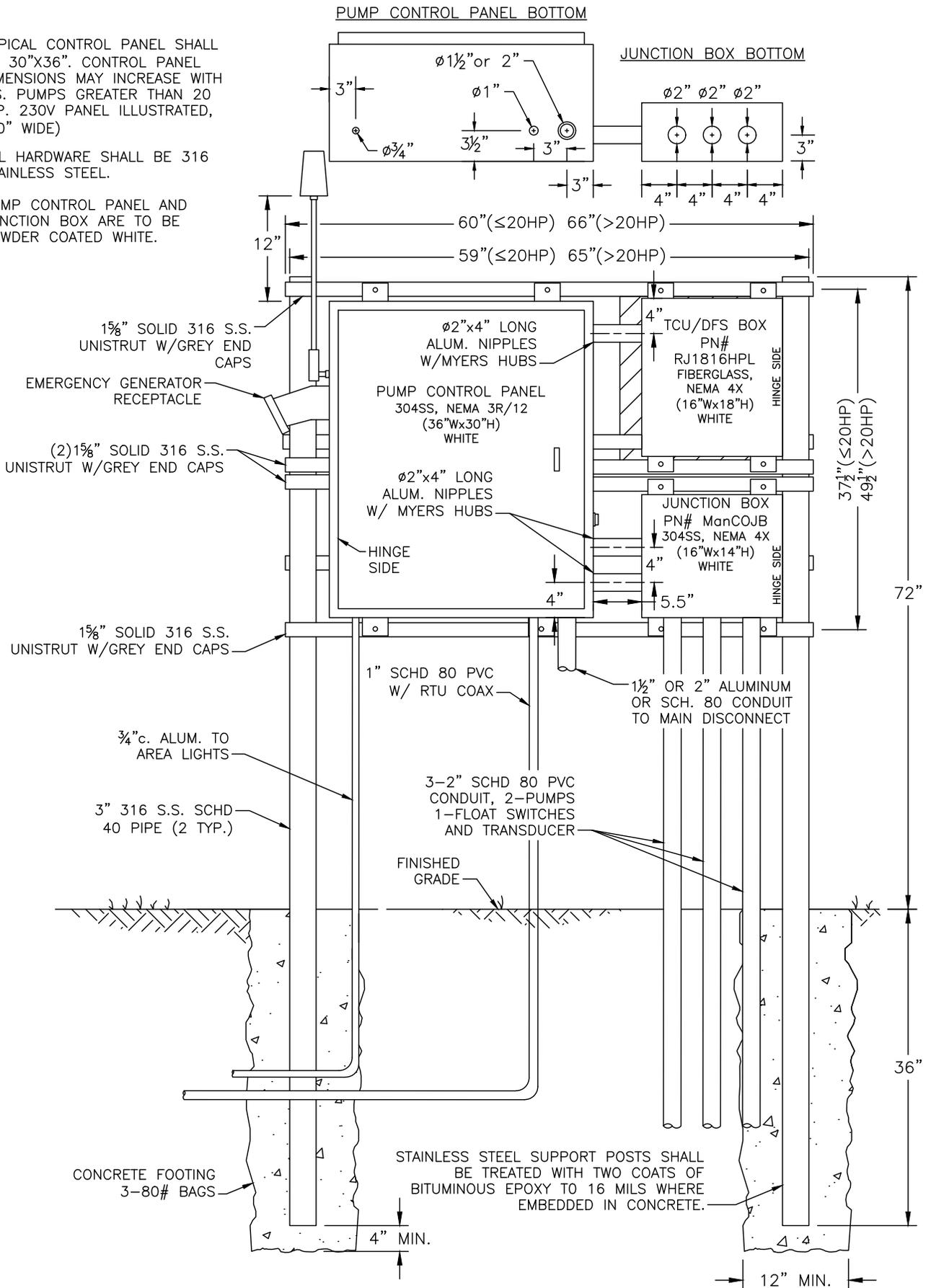

MANATEE COUNTY		SEWAGE LIFT STATION CONTROL PANEL	US-24
PUBLIC WORKS DEPARTMENT			
REV. BY	DATE	<p style="font-size: 1.2em; margin: 0;">February 25, 2020</p> <p style="margin: 0;">DATE OF APPROVAL</p>	

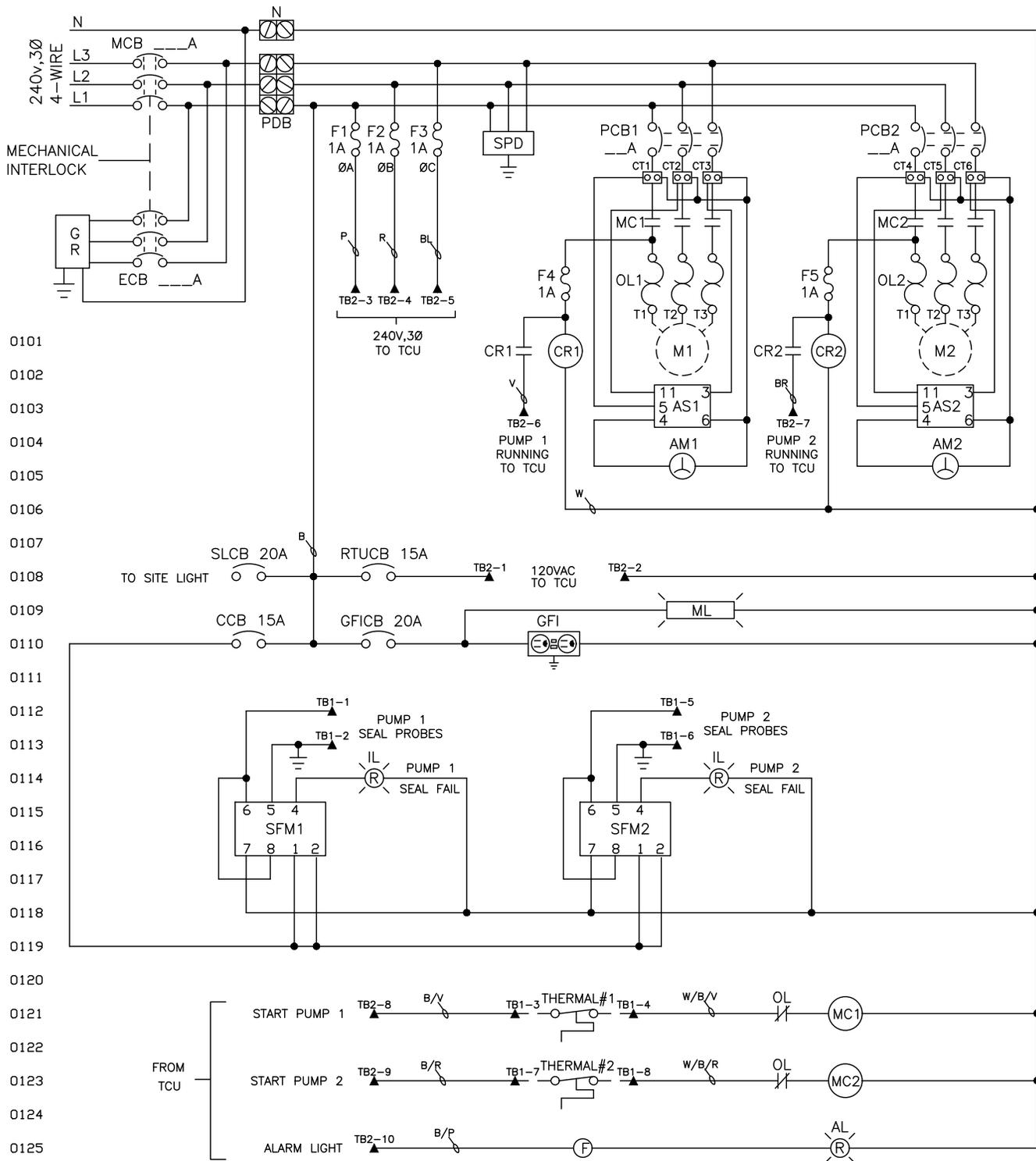

MANATEE COUNTY
PUBLIC WORKS DEPARTMENT

SEWAGE LIFT STATION
CONTROL PANEL
(230V)

US-25A

February 25, 2020
DATE OF APPROVAL

REV. BY	DATE

TERMINALS

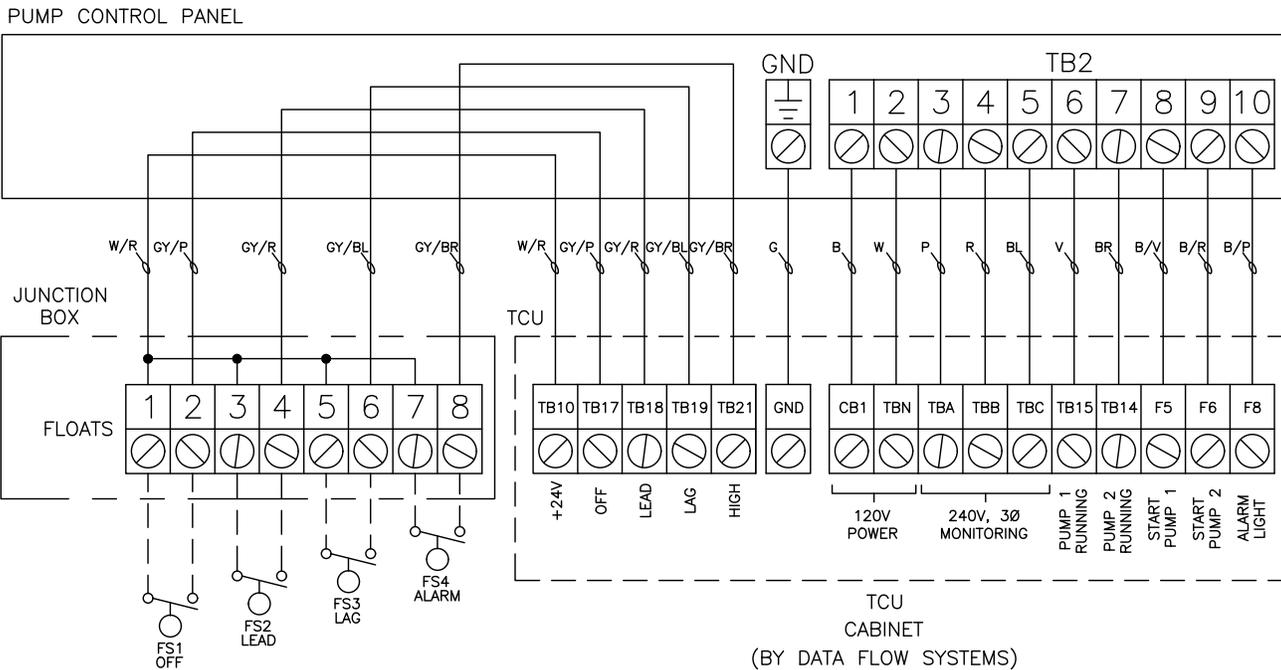
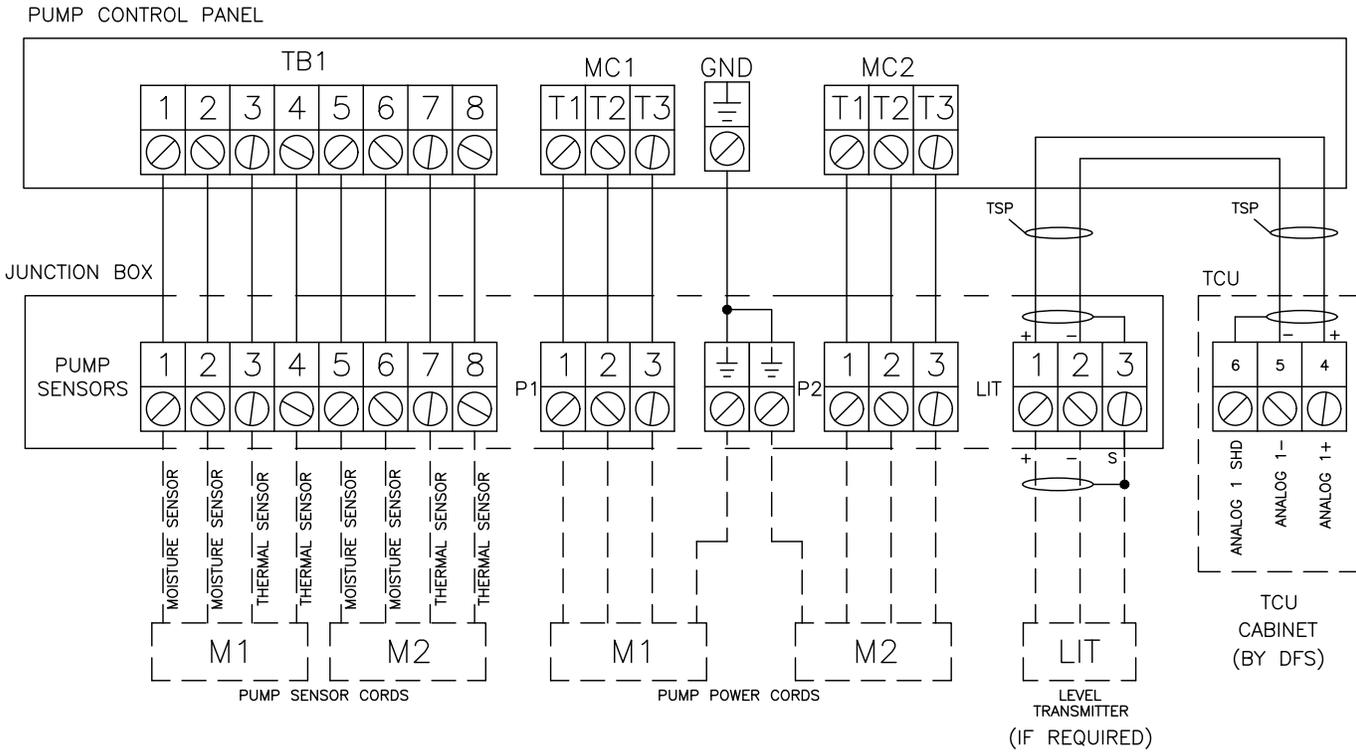

MANATEE COUNTY
PUBLIC WORKS DEPARTMENT

SEWAGE LIFT STATION
CONTROL PANEL
(230V)

US-25C

REV. BY DATE

February 25, 2020
DATE OF APPROVAL

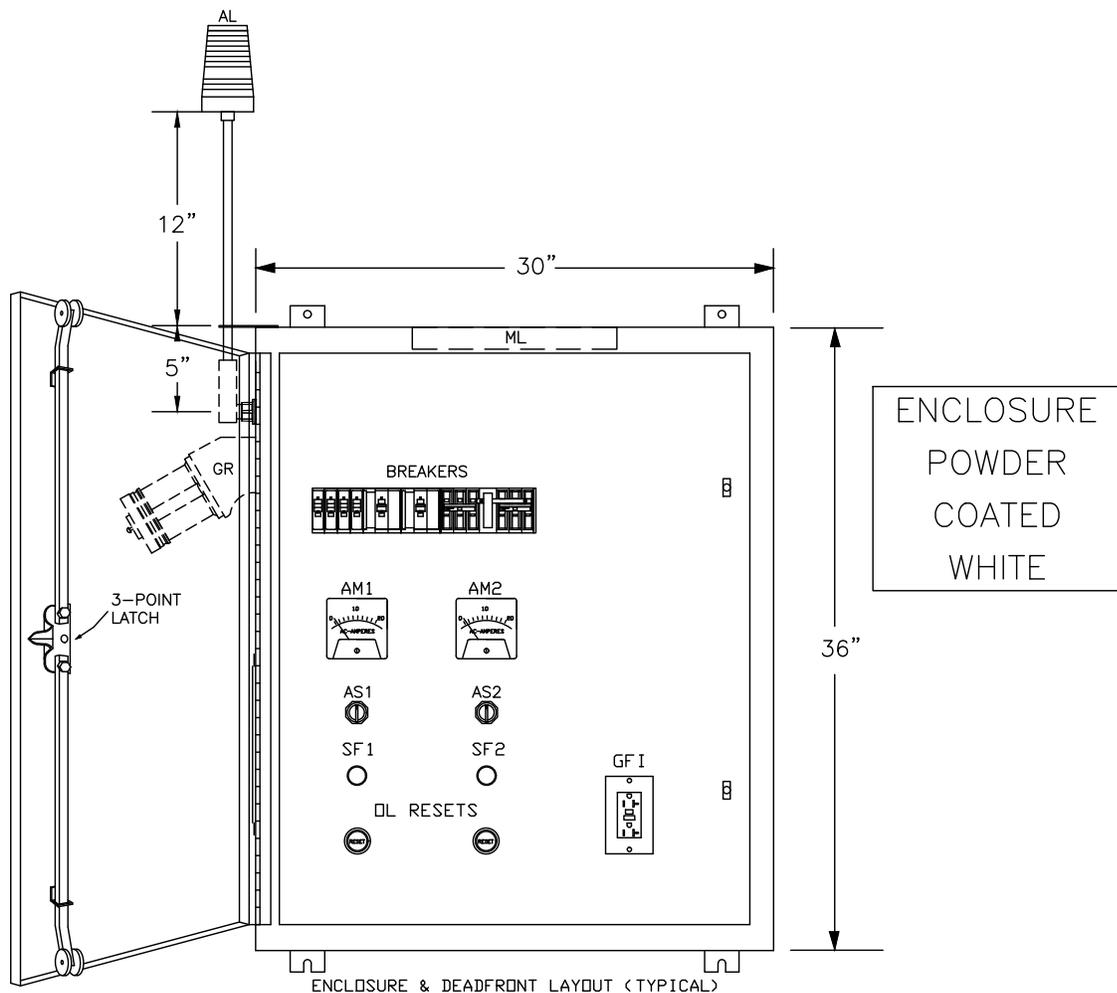

ENCLOSURE
POWDER
COATED
WHITE

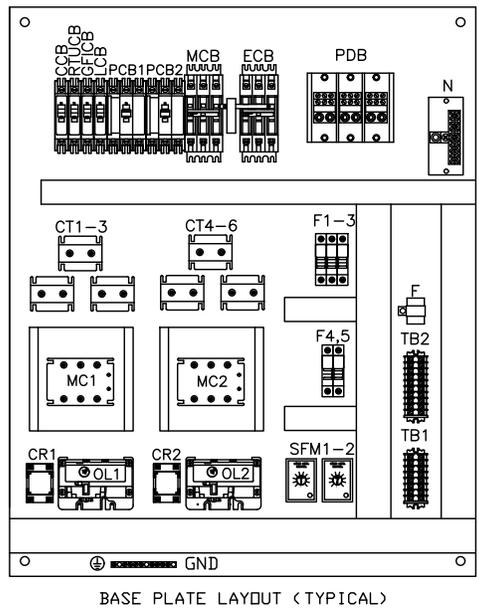

MANATEE COUNTY PUBLIC WORKS DEPARTMENT	
REV. BY	DATE
	February 25, 2020
	DATE OF APPROVAL

SEWAGE LIFT STATION
CONTROL PANEL
(230V)

US-25D

JUNCTION BOX BILL OF MATERIALS			
QTY.	ABBR.	DESCRIPTION	MANUFACTURER, PART#
1	ENC	ENCLOSURE, 304SS N4X (WHITE)	SCHAEFER'S, SPN4SS-14168-587
2		8-POINT TERMINAL BLOCK	IDEAL, 89-208
1		3-POINT TERMINAL BLOCK	IDEAL, 89-203
2		PUMP TERMINAL BLOCK	MARATHON, 1323572
1	G	GROUND BAR	EATON, GBK5

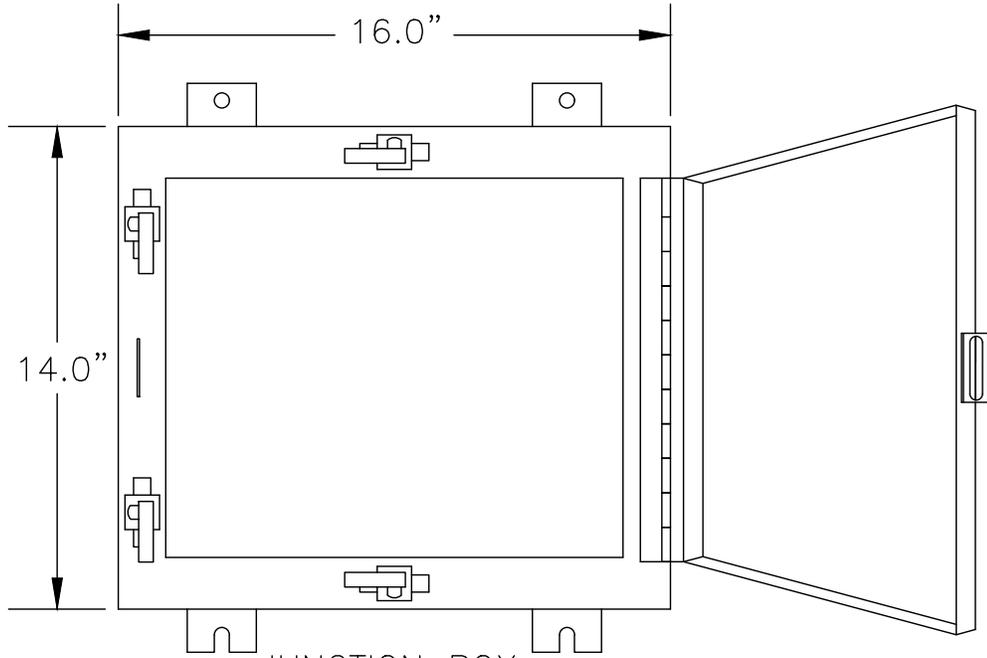

JUNCTION BOX
(POWDER COATED WHITE)

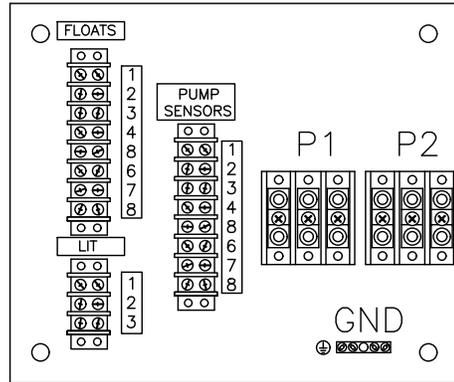

BASE PLATE

NOTE: J-BOX GROUND
MUST BE BONDED TO
CONTROL PANEL GROUND

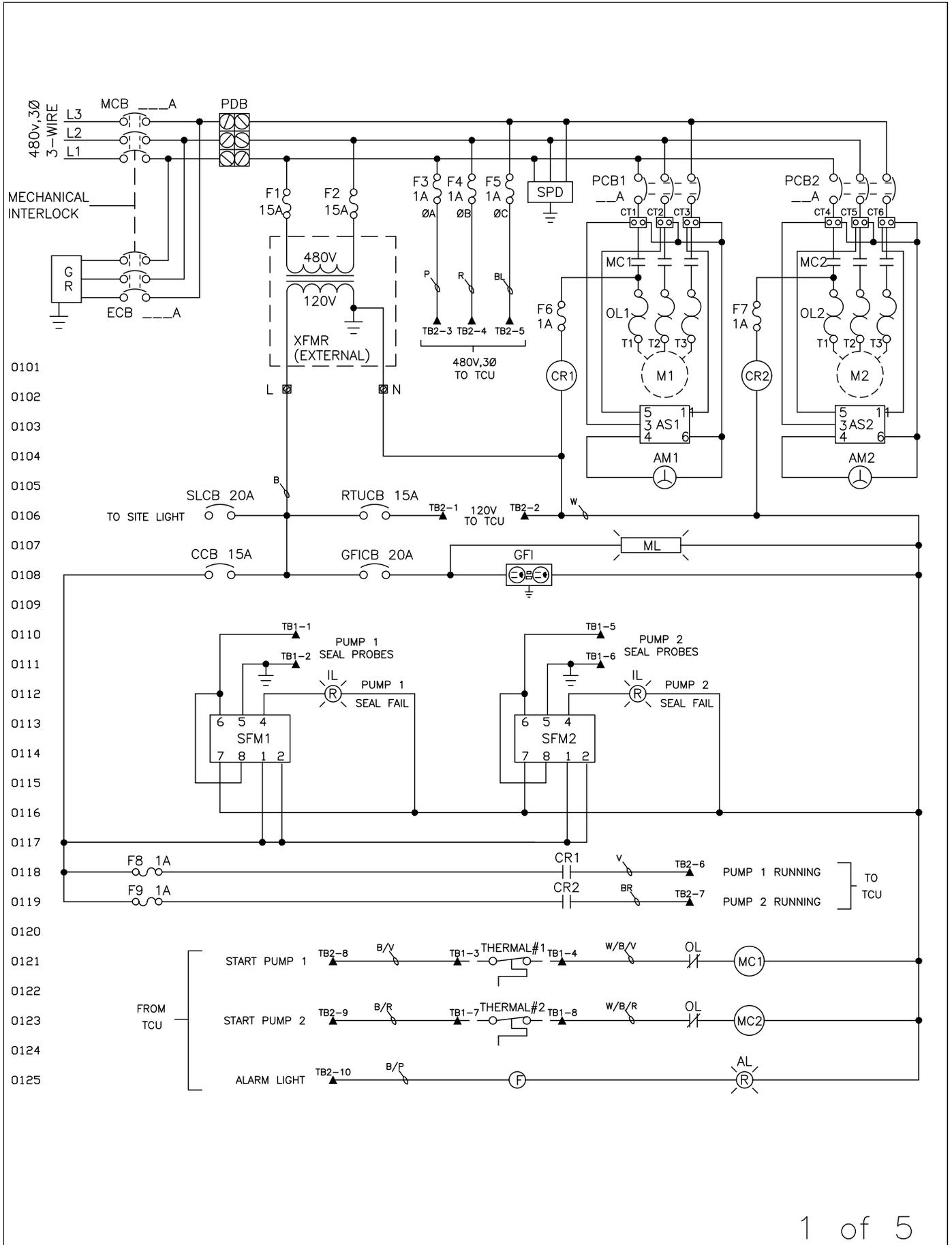

MANATEE COUNTY PUBLIC WORKS DEPARTMENT	
REV. BY	DATE
	February 25, 2020
	DATE OF APPROVAL

SEWAGE LIFT STATION
CONTROL PANEL
(460V)

US-26A

PUMP CONTROL PANEL BILL OF MATERIALS

QTY.	ABBR.	DESCRIPTION	MANUFACTURER, PART#
1	ENC	ENCLOSURE, 304SS N3R/12 (WHITE)	HOFFMAN, A36H3012SSLP-P8743 (MINIMUM SIZE)
1	MCB	MAIN CIRCUIT BREAKER	SQ.D, HGL (SIZE AS REQUIRED - 100A MIN.)
1	ECB	EMERGENCY CIRCUIT BREAKER	SQ.D, HGL (SIZE AS REQUIRED - 100A MIN.)
2	PCB1,2	PUMP CIRCUIT BREAKER	SQ.D, HGL (SIZE AS REQUIRED) + S29450
1	CCB	CONTROL CIRCUIT BREAKER	SQ.D, QOU115
1	RTUCB	RTU CIRCUIT BREAKER	SQ.D, QOU115
1	GFICB	GFI CIRCUIT BREAKER	SQ.D, QOU120
1	SLCB	SITE LIGHT CIRCUIT BREAKER	SQ.D, QOU120
2	MC1,2	NEMA 4 CONTACTOR	CRYDOM, A53TP_____ (SIZE AS REQUIRED)
2	CR1-2	CURRENT RELAY	CRYDOM, CWA2410 + HS501DR + HSP-2
2	OL1-2	OVERLOAD RELAY	SIEMENS, ESP200 (SIZE AS REQUIRED)
1	GR	GENERATOR RECEPTACLE	RUSSELL STOLL, JRSB2034HR
1	SPD	SURGE PROTECTOR	DITEK, DTK-4803CMX+
6	CT1-6	CURRENT TRANSFORMER __:5	ELECTRO. IND, 2SFT-_____ (SIZE AS REQUIRED)
2	AS1-2	AMMETER SELECTOR SWITCH	SPRECHER & SCHUH, LE2-12-8751
2	AM1-2	AMMETER 0-__ A	CROMPTON, 013-75AA-LS__-C6-B3 (SIZE AS REQD)
2	F1-2	FUSE, 15A	FERRAZ, ATQR-15
1	XFMR	TRANSFORMER, 480V/120VAC 3KVA	SQ.D, 7400-3S1F (SHIPPED LOOSE)
7	F3-9	FUSE, 1A	FERRAZ, ATMR-1
1	GFI	120V RECEPTACLE	PASS & SEYMOUR, 1597-I
1	ML	MAINTENANCE LIGHT, LED	HOFFMAN, LEDA1S35
2	SFM1,2	SEAL FAIL MODULE	SYRELEC, PNRU-110A
2	IL	INDICATING LIGHT, RED LED	EATON, C22-L-XR-120
1	F	FLASHER	INGRAM, SSF-150W
1	AL	ALARM LIGHT, 120V LED	FEDERAL, LP3PL-120R

WIRE COLOR CODE	
SYMBOL	COLOR
B	BLACK
W	WHITE
G	GREEN
BL	BLUE
R	RED
P	PINK
V	VIOLET
BR	BROWN
B/R	BLACK/RED
B/V	BLACK/VIOLET
B/P	BLACK/PINK
GY/P	GREY/PINK
GY/R	GREY/RED
GY/BL	GREY/BLUE
GY/BR	GREY/BROWN
W/R	WHITE/RED
W/B/V	WHT/BLK/VIOLET
W/B/R	WHT/BLK/RED

MANATEE COUNTY PUBLIC WORKS DEPARTMENT		SEWAGE LIFT STATION CONTROL PANEL (460V)	US-26B
REV.BY	DATE		
	February 25, 2020		
	DATE OF APPROVAL		

TERMINALS

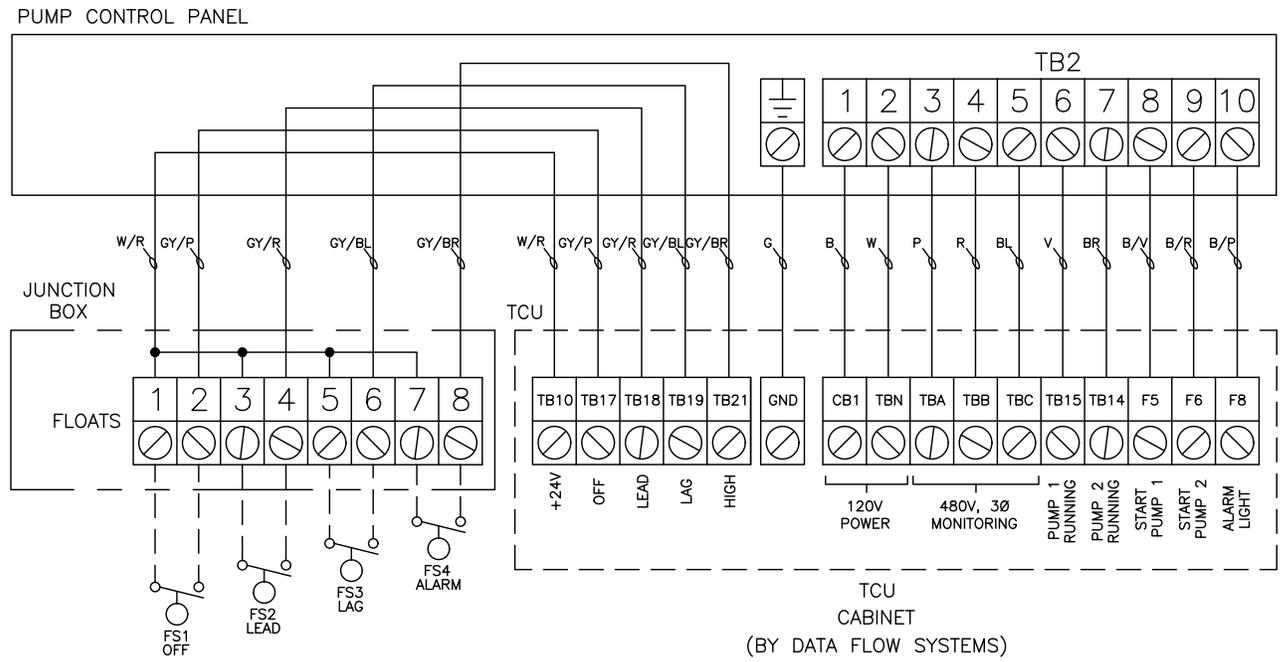
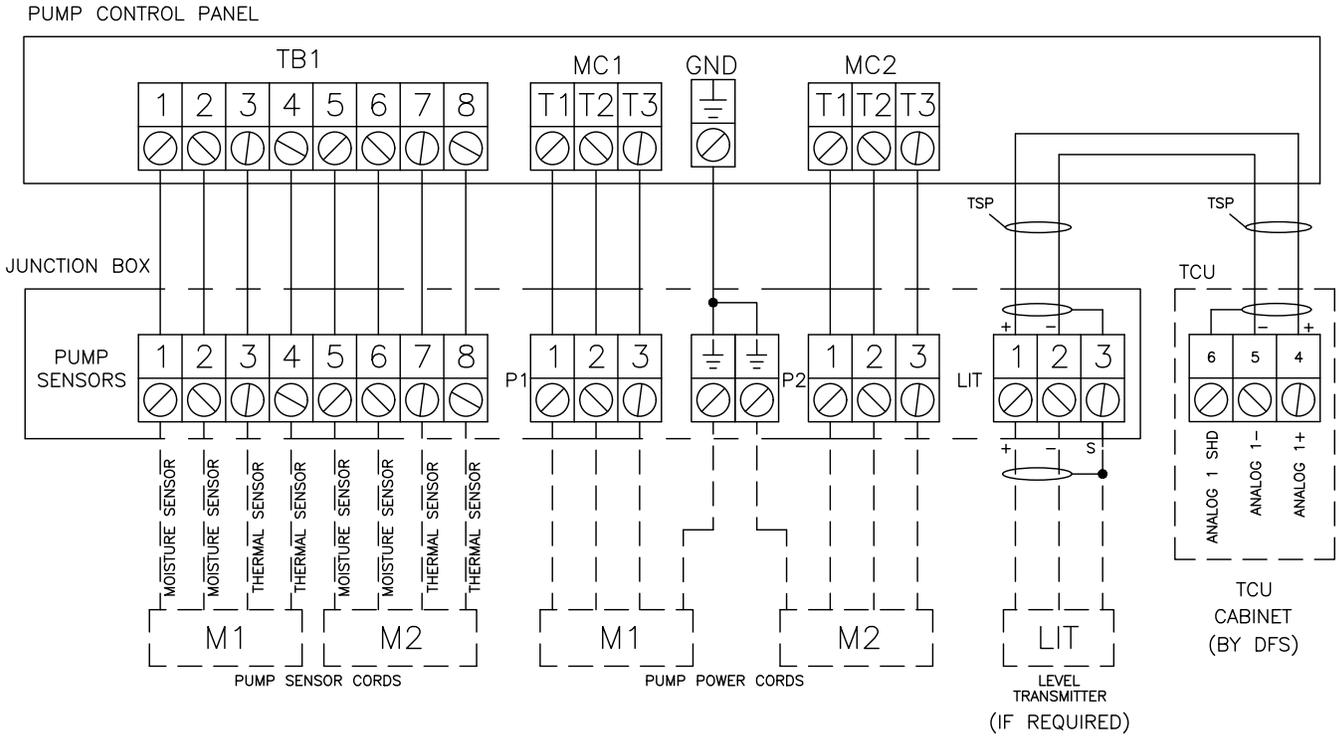

MANATEE COUNTY PUBLIC WORKS DEPARTMENT		SEWAGE LIFT STATION CONTROL PANEL (460V)	US-26C
REV. BY	DATE		
February 25, 2020 DATE OF APPROVAL			

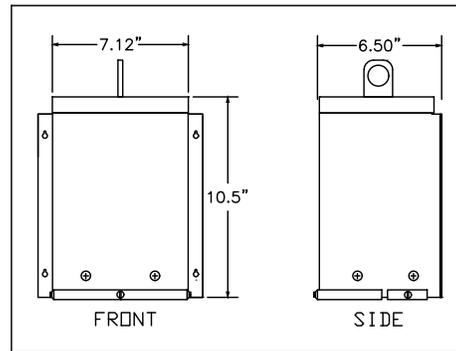
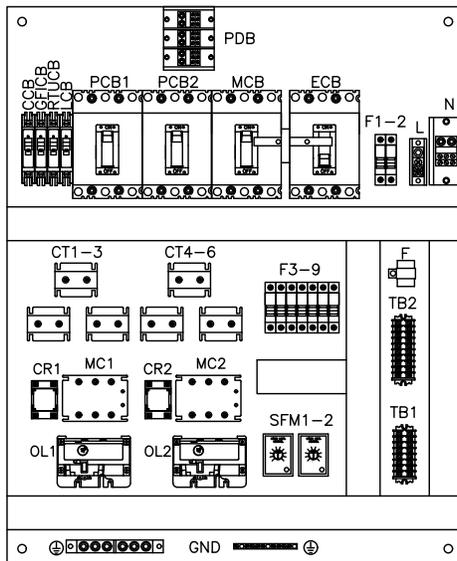
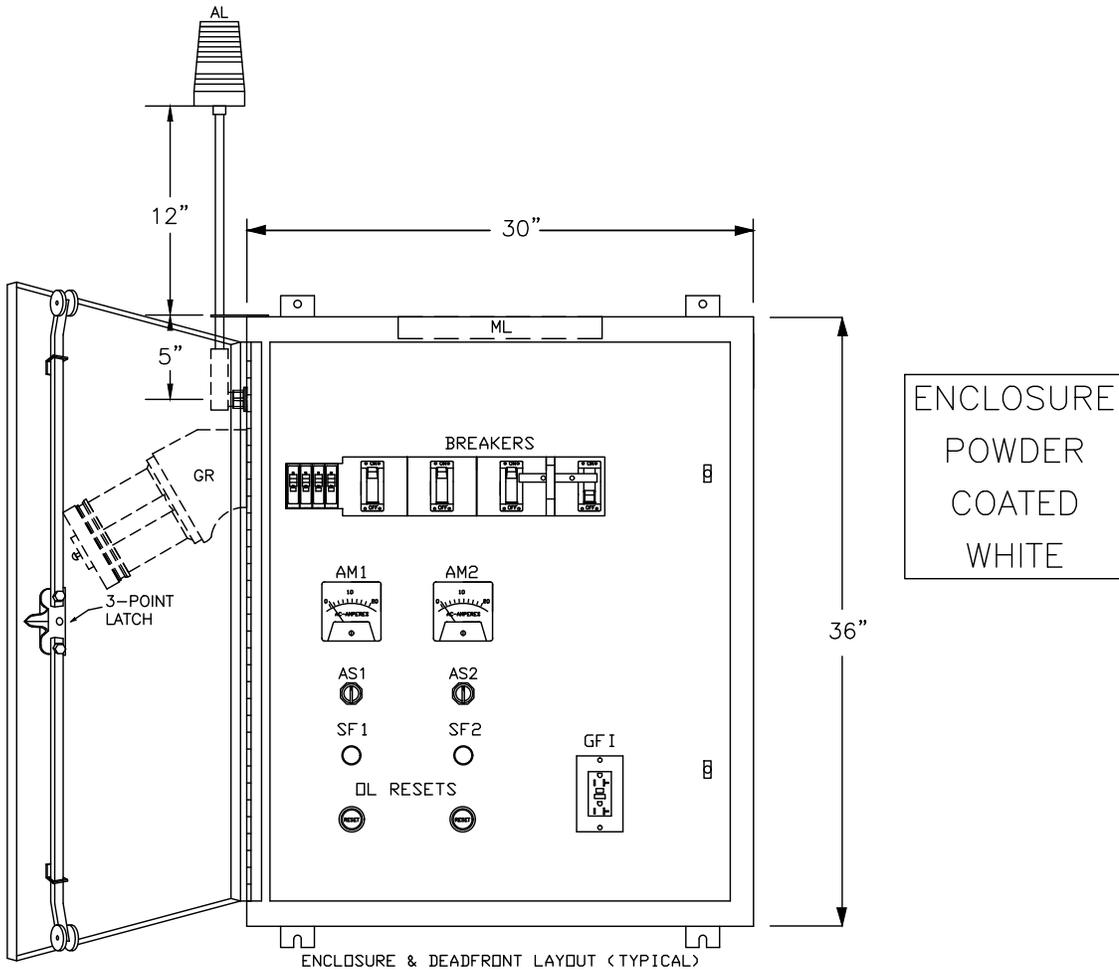

TRANSFORMER
(SHIPPED LOOSE - TO BE
INSTALLED ON EQUIPMENT RACK)

MANATEE COUNTY
PUBLIC WORKS DEPARTMENT

SEWAGE LIFT STATION
CONTROL PANEL
(460V)

US-26D

REV. BY DATE

February 25, 2020
DATE OF APPROVAL

JUNCTION BOX BILL OF MATERIALS			
QTY.	ABBR.	DESCRIPTION	MANUFACTURER, PART#
1	ENC	ENCLOSURE, 304SS N4X (WHITE)	SCHAEFER'S, SPN4SS-14168-587
2		8-POINT TERMINAL BLOCK	IDEAL, 89-208
1		3-POINT TERMINAL BLOCK	IDEAL, 89-203
2		PUMP TERMINAL BLOCK	MARATHON, 1323572
1	G	GROUND BAR	EATON, GBK5

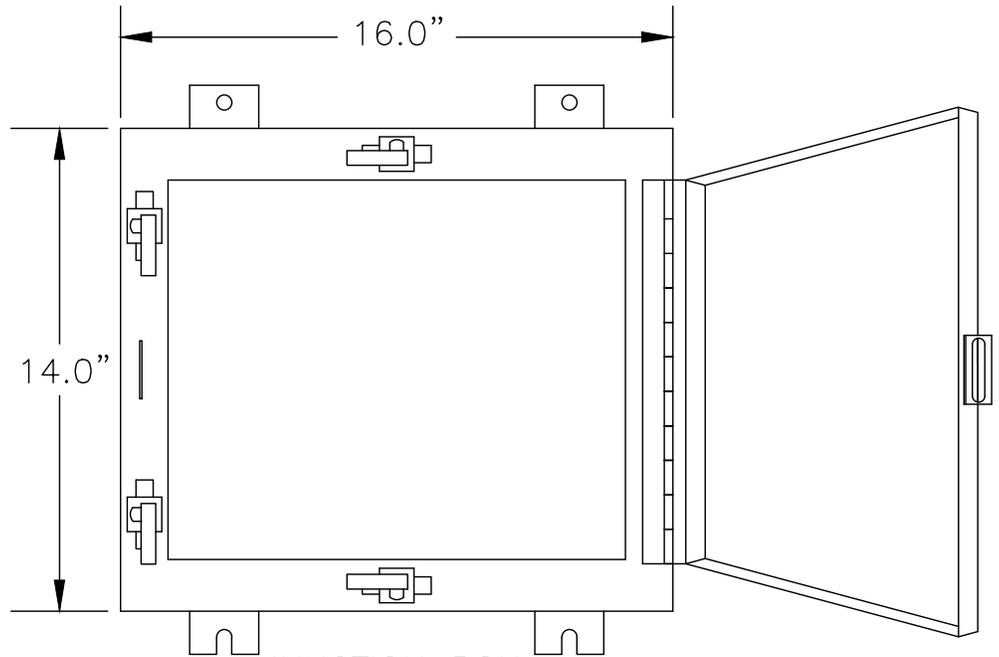

JUNCTION BOX
(POWDER COATED WHITE)

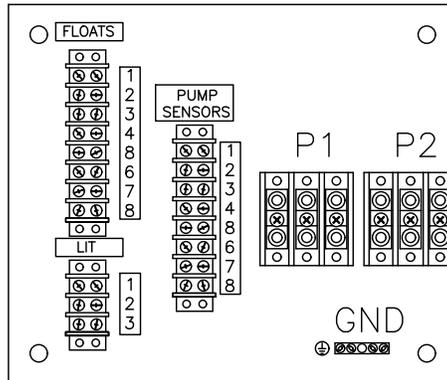

BASE PLATE

NOTE: J-BOX GROUND
MUST BE BONDED TO
CONTROL PANEL GROUND

MANATEE COUNTY PUBLIC WORKS DEPARTMENT		SEWAGE LIFT STATION CONTROL PANEL (460V)	US-26E
REV. BY	DATE		
	February 25, 2020		
	DATE OF APPROVAL		

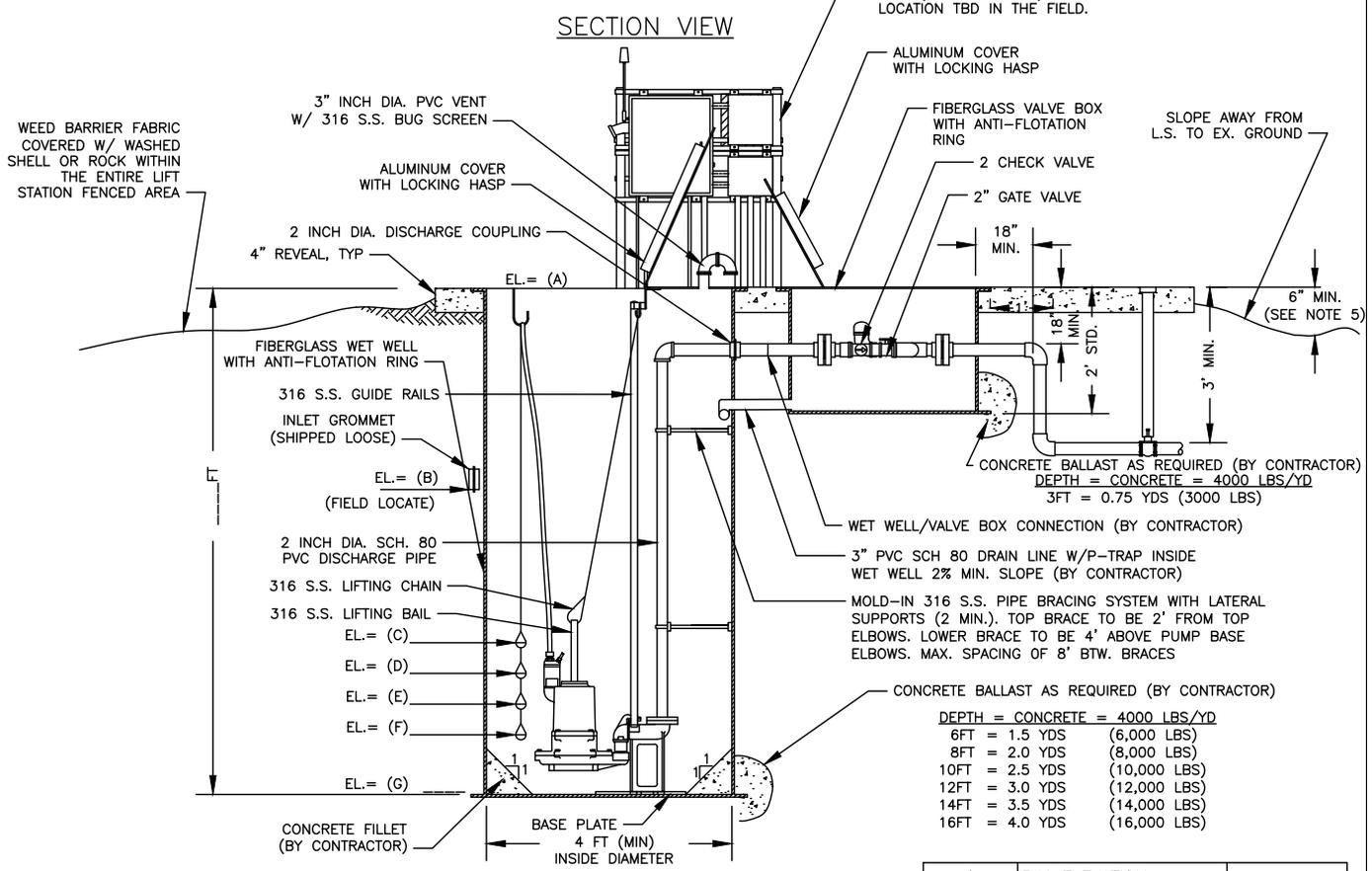
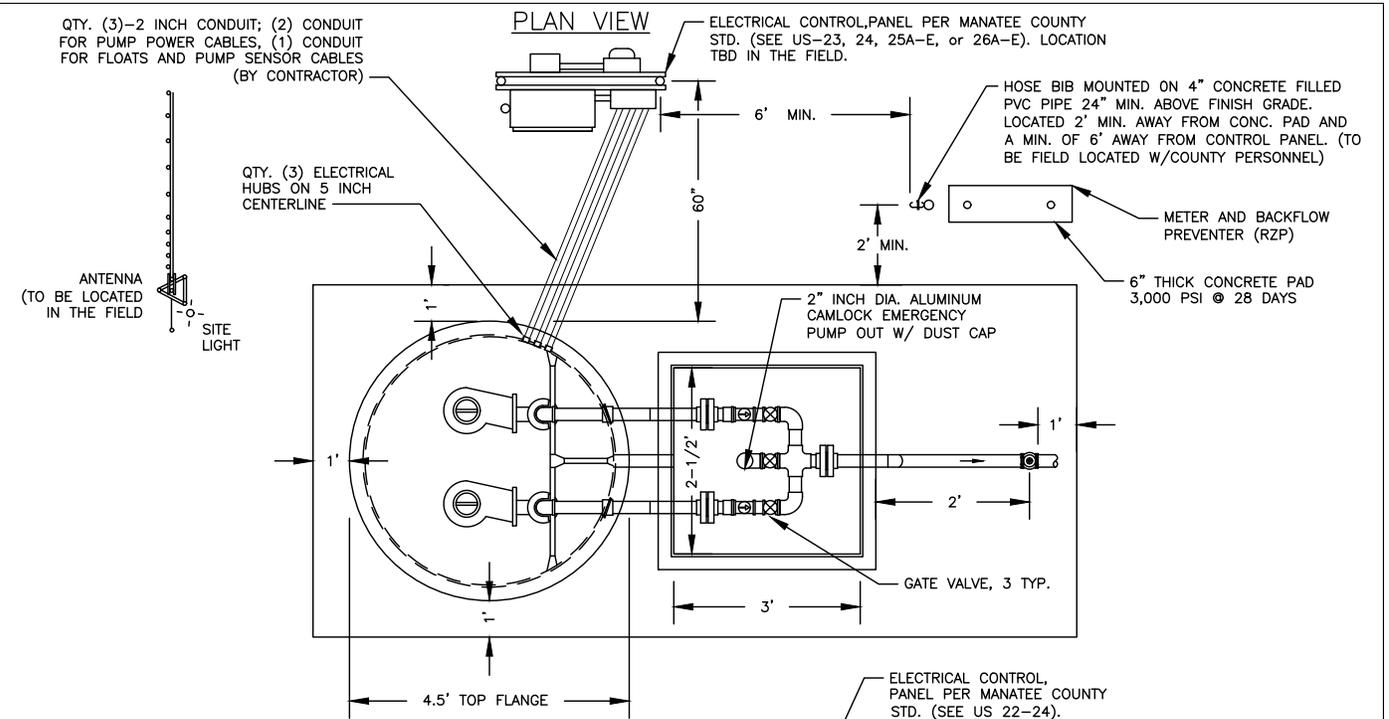

NOTES:

1. THE GRINDER LIFT STATION SHALL MEET THE CRITERIA OF THE LATEST MANATEE COUNTY PUBLIC WORKS UTILITY STANDARDS FOR LIFT STATIONS, SECTION 1.14 IN THE PUBLIC WORKS UTILITY STANDARDS MANUAL.
2. METER, BFP, & HOSE BIB SHALL BE PER M.C. UTILITY STANDARDS & LOCATED AS SUCH TO PROVIDE UNIMPEDED VEHICULAR ACCESS TO THE LIFT STATION FOR PUMP REMOVAL. COORDINATE LOCATION WITH COUNTY PERSONNEL.
3. ALL ELECTRICAL PANELS SHALL BE ABOVE THE REQUIRED 100 YEAR FLOOD PROTECTION ELEVATION (FPE).
4. FENCING AROUND THE GRINDER LIFT STATION SHALL BE FIELD LOCATED AND INSTALLATION COORDINATED WITH MANATEE COUNTY PERSONNEL.
5. SEE "ENTRANCE HATCH ELEVATION" CRITERIA IN THE M.C. P.W. UTILITY STANDARDS, 1.14.6

A	RIM ELEVATION	
B	INFL. INVERT	
C	HIGH WATER WATER	
D	LAG PUMP 2 ON	
E	LEAD PUMP 1 ON	
F	LOW WATER LEVEL (ALL PUMPS OFF)	
G	BOTTOM ELEVATION	

MANATEE COUNTY
PUBLIC WORKS DEPARTMENT

REV. BY	DATE

February 25, 2020
DATE OF APPROVAL

GRINDER LIFT STATION

US-27A

INTENTIONALLY
LEFT
BLANK



UTILITY APPROVED PRODUCT LIST

FEBRUARY 2020

Category				Submittal	Potable Water	Reclaimed Water	Wastewater	Manufacturer	Model Number	Notes	
Piping	Pressurized PVC AWWA C900-16	Standard Push-On Joint	4" and Larger	✓	✓	✓	JM Eagle	Blue Brute (C900)/ Big Blue (C905)	<p>Pipe size 14" shall only be used with prior written approval by Manatee County All PVC pipe shall be color-coded per service application</p> <p>Potable/Reclaimed Water: Pipe sizes 4" - 12": Pressure Class 235, DR 18, Ductile Iron Pipe Size (DIPS), AWWA C900-16 Shall have EPDM rubber gaskets with the letters "EPDM" factory embossed or etched into the gasket Pipe and gaskets for potable water shall be NSF61 certified</p> <p>Wastewater: Pipe sizes 4" - 36": Pressure Class 235, DR 18, DIPS, AWWA C900-16</p> <p>Self-Restrained Push-On Joint: All self-restrained push-on joint pipe shall be field checked for proper engagement per manufacturer's recommendations Pipe shall have weather-resistant, min. 6 mil thick, 4" wide, solid red PVC marking tape around bell</p> <p>RieberLok: Gaskets shall only be used on manufacturer approved pipe Bulldog Restraint: Gaskets shall only be factory applied to Diamond Plastic "Lok 21" and JM Eagle "Eagle Loc 900" Pipe</p>		
				✓	✓	✓	Diamond Plastics Corp.	C900/Trans-21			
				✓	✓	✓	North American Pipe Corp.	C900/IB			
				✓	✓	✓	National Pipe & Plastics	Dura-Blue C900			
				✓	✓	✓	Sanderson Pipe	C900			
	Self-Restrained Push-On Joint	4" - 24"	✓	✓	✓	Bulldog Restraint	Bulldog Gasket				
		4" - 12"	✓	✓	✓	RieberLok	RieberLok Gasket				
	Gravity Sewer PVC	4" - 15"			✓	✓	✓	JM Eagle		Ring-Tite Gravity Sewer	<p>Pipe size 14" shall only be used with prior written approval by Manatee County</p> <p>Push-on joints shall use elastomeric gaskets in accordance with ASTM D3212 Pipe shall be color coded green for sewer applications</p> <p>Pipe sizes 4" - 15": Pipe Stiffness 115, SDR 26, ASTM D3034</p>
					✓	✓	✓	Diamond Plastics Corp.		Sani-21	
					✓	✓	✓	North American Pipe Corp.		ASTM D3034/IB	
✓					✓	✓	National Pipe & Plastics	Sewer ASTM D3034/F679			
✓					✓	✓	Sanderson Pipe	ASTM D3034/IB			
18" - 54"					✓	✓	✓	JM Eagle	Big Blue (C905)		
					✓	✓	✓	Diamond Plastics Corp.	C900/Trans-21		
					✓	✓	✓	North American Pipe Corp.	C900/IB		
					✓	✓	✓	National Pipe & Plastics	Dura-Blue C900		

Contractor shall check/mark which product is intended to be used in the submittal box. If multiple manufacturers are to be used, each manufacturer shall be marked.



UTILITY APPROVED PRODUCT LIST

FEBRUARY 2020

Category				Submittal	Potable Water	Reclaimed Water	Wastewater	Manufacturer	Model Number	Notes
Piping	HDPE	For Mains	4" and Larger	✓	✓	✓	JM Eagle	HDPE (DIPS) Pressure Pipe	Pressure Class 200, PE4710, Ductile Iron Pipe Size (DIPS), DR 11, AWWA C906 Min. Cell Classification per ASTM D3350 shall be 445574 Pipe sizes 3" and 14" shall only be used with prior written approval by Manatee County All HDPE pipe must have color coded striping on 3-sides (120 degree apart) per service application <u>Potable/Reclaimed Water:</u> For pipe sizes 4" - 12" HDPE pipe shall not be installed in roadways, unless in a casing Pipe sizes 16" and larger shall only be used with prior written approval by Manatee County Pipe for potable water shall be NSF61 certified <u>Wastewater:</u> For pipe sizes 4" - 36"	
				✓	✓	✓	WL Plastics	PE 4710 (DIPS)		
				✓	✓	✓	GF Central Plastics	Design-Flow PE100/PE4710		
				✓	✓	✓	Performance Pipe	DriscoPlex 4000		
				✓	✓	✓	Endot	PE 4710 (DIPS)		
				✓	✓	✓	Charter Plastics	PE 4710 - Blue/Lavender/ Green Stripe		
	PE	For Services	2" and Smaller	✓	✓		Endot	Endopure	Pressure Class 250, PE4710, Copper Tube Size (CTS), SDR 9, AWWA C901 Min. Cell Classification per ASTM D3350 shall be 445574 Tubing shall be fully color coded blue for potable water or purple for reclaimed water services Tubing for potable water shall be NSF61 certified PE Tubing shall only be used if water main is not under pavement Butt-Fusion or CTS brass connections shall be used	
				✓	✓		ADS	Polyflex		
				✓			Charter Plastics	4710 - CTS Tubing		
	PEX			✓	✓		Rehau	Municipex	Pressure Class 200, PEXa 3306, Copper Tube Size (CTS), SDR 9, AWWA C904 Tubing shall be fully color coded blue for potable water or purple for reclaimed water services Tubing for potable water shall be NSF61 certified PEX Tubing shall only be used if water main is not under pavement Butt-Fusion or CTS brass connections shall be used	

Contractor shall check/mark which product is intended to be used in the submittal box. If multiple manufacturers are to be used, each manufacturer shall be marked.



UTILITY APPROVED PRODUCT LIST

FEBRUARY 2020

Category				Submittal	Potable Water	Reclaimed Water	Wastewater	Manufacturer	Model Number	Notes
Piping	Ductile Iron AWWA C150/C151	Flanged Joint	4" and Larger	✓	✓	✓	✓	American Cast Iron Pipe Company	Flanged Joint	<p style="text-align: center;">Pipe Ratings: Aboveground Installation: Flanged Joint, 250 PSI, Special Class 53 Buried Installation: Mechanical Joint, 350 PSI for 4" - 16", 250 PSI for 18" and larger</p> <p>Buried pipe shall be wrapped with an approved external polyethylene encasement color coded blue for potable water, purple for reclaimed water, and green for sewer</p> <p>Pipe size 14" shall only be used with prior written approval by Manatee County</p> <p style="text-align: center;">Potable/Reclaimed Water: For pipe sizes 4" and larger</p> <p style="text-align: center;">Interior Coating: Std. thickness cement lining per AWWA C104</p> <p style="text-align: center;">Exterior Coating: Buried pipe shall have a std. 1-mil asphaltic coating per AWWA C151; aboveground pipe shall have a factory-applied epoxy primer</p> <p>For uncontaminated soils: Shall have EPDM rubber gaskets with the letters "EPDM" factory embossed and/or etched into gasket</p> <p style="text-align: center;">For contaminated soils: Shall have NBR or FKM rubber gasket</p> <p>Refer to Manatee County Public Works Utility Standards Section 1.4.2.F for gasket material details Pipe and gaskets for potable water shall be NSF61 certified</p> <p style="text-align: center;">Wastewater: For force mains: Pipe sizes 36" and larger</p> <p style="text-align: center;">For lift station aboveground valve and metering assemblies: Pipe sizes 4" and larger</p> <p>Holiday-free factory certification per ASTM G62, Method B (High-Voltage) shall be provided for the interior coating at the point of delivery</p> <p style="text-align: center;">Interior Coating: Green, factory applied dry film thickness 40-mil Tnemec Series 431 Perma-Shield PL or Permax CTF coating</p> <p style="text-align: center;">Exterior Coating: Buried pipe shall have a std. 1-mil asphaltic coating per AWWA C151; aboveground pipe shall have a factory-applied epoxy primer</p> <p style="text-align: center;">Self-Restrained Push-On Joint: All self-restrained push-on joint pipe shall have weather-resistant, min. 6 mil thick, 4" wide, solid red PVC marking tape around bell</p>
				✓	✓	✓	✓	McWane Ductile	Flanged Joint	
				✓	✓	✓	✓	U.S. Pipe	Flanged Joint	
		Standard Push-On Joint		✓	✓	✓	✓	American Cast Iron Pipe Company	Fastite Joint	
				✓	✓	✓	✓	McWane Ductile	Tyton Joint	
				✓	✓	✓	✓	U.S. Pipe	Tyton Joint	
		Self- Restrained Push-On Joint		American Cast Iron Pipe Company	✓	✓	✓	✓	Fastite Joint w/ Amarillo Fast-Grip Gasket (4" - 24")	
					✓	✓	✓	✓	Lok-Ring Joint (54" - 64")	
					✓	✓	✓	✓	Flex-Ring Joint (4" - 54")	
	McWane Ductile		✓	✓	✓	✓	Tyton Joint w/ Sure Stop 350 Gasket (4" - 24")			
			✓	✓	✓	✓	TR Flex Joint (4" - 36")			
			✓	✓	✓	✓	Tyton Joint w/ Field Lok 350 Gasket (4" - 16")			
	U.S. Pipe	✓	✓	✓	✓	HP Lok Joint (30" - 64")				
		✓	✓	✓	✓	TR Flex Joint (4" - 36")				



UTILITY APPROVED PRODUCT LIST

FEBRUARY 2020

Category		Submittal	Potable Water	Reclaimed Water	Wastewater	Manufacturer	Model Number	Notes
Piping	Pressurized PVC ASTM D2241	3" and Smaller	✓	✓		JM Eagle	Ring-Tite	<u>Shall only be used for potable/reclaimed water service casings under pavement</u> Pressure Class 200, SDR 21, Iron Pipe Size (IPS), ASTM D2241
			✓	✓		Diamond Plastics Corp.	D2241	
			✓	✓		North American Pipe Corp.	ASTM D2241/IB	
			✓	✓		National Pipe & Plastics	Dura-Flow SDR Series	
	Pressurized Sch. 80 PVC ASTM D1785	2" and Smaller			✓	North American Pipe Corp. Products	-	<u>Shall only be used for grinder pump stations</u> Iron Pipe Size (IPS), ASTM D1785 Only for working pressures up to 125 psi
					✓	JM Eagle Products	-	
					✓	GF Central Plastics Products	-	
					✓	Charlotte Pipe Products	-	
					✓	Harrison Plastic Products	-	
	Fiberglass	Centrifugally Cast			✓	Hobas Products	-	<u>Shall only be used for slip lining existing gravity sewer main</u> Bell and Spigot shall meet requirements of ASTM D3262 O-ring or profile type elastomeric gasket shall meet requirements of ASTM F477
		Filament Wound			✓	Flowtite Products	-	



UTILITY APPROVED PRODUCT LIST

FEBRUARY 2020

Category			Submittal	Potable Water	Reclaimed Water	Wastewater	Manufacturer	Model Number	Notes
Fittings	Ductile Iron AWWA C110/C153	For Pressurized PVC C900-16 and DI Pipe	✓	✓	✓		Sigma Corp. Products	-	<p><u>Mechanical Joint Fittings (Buried Installations Only):</u> 4" - 16": 350 psi pressure rating 18" and larger: 250 psi pressure rating</p> <p><u>Flanged Fittings (Aboveground Installations Only):</u> All sizes: 250 psi pressure rating</p> <p>Buried fittings shall be wrapped with an approved external polyethylene encasement color coded blue for potable water, purple for reclaimed water, and green for sewer</p> <p><u>For buried installations:</u> T-bolts, bolts, tie rods, nuts, and washers shall be High Strength, Low Alloy Steel conforming to AWWA C111/ANSI A21.11-17 or ASTM A242. Hardware referenced above shall be coated with a blue fluoropolymer coating (Xylan 1424, FluoroKote #1 or AFT-PTFE-Blue). Alternatively, hardware shall be 316 SS.</p> <p><u>For aboveground installations:</u> T-bolts, bolts, tie rods, nuts, and washers shall be 316 SS</p> <p><u>Potable/Reclaimed Water:</u> <u>Interior Coating:</u> Double the std. thickness cement lining per AWWA C104 <u>Exterior Coating:</u> Buried fittings shall have a std. 1-mil asphaltic coating per AWWA C110/C153; aboveground fittings shall have a factory-applied epoxy primer <u>For uncontaminated soils:</u> Shall have EPDM rubber gaskets with the letters "EPDM" embossed and/or etched into gasket <u>For contaminated soils:</u> Shall have NBR or FKM rubber gasket Refer to Manatee County Public Works Utility Standards Section 1.4.2.F for gasket material details Fittings and gaskets for potable water shall be NSF61 certified</p> <p><u>Wastewater:</u> Holiday-free factory certification per ASTM G62, Method B (High-Voltage) shall be provided for the interior coating at the point of delivery <u>Interior Coating:</u> Green, factory applied dry film thickness 40-mil Tnemec Series 431 Perma-Shield PL or Permox CTF coating <u>Exterior Coating:</u> Buried fittings shall have a std. 1-mil asphaltic coating per AWWA C110/C153; aboveground fittings shall have a factory-applied epoxy primer</p>
			✓	✓	✓		Star Pipe Products	-	
			✓	✓	✓		Infact Corp.	Flex T-2/T-3	
			✓	✓	✓		SIP Industries Products	-	
			✓	✓	✓		Tyler/Union Products	-	



UTILITY APPROVED PRODUCT LIST

FEBRUARY 2020

Category		Submittal	Potable Water	Reclaimed Water	Wastewater	Manufacturer	Model Number	Notes
Fittings	Molded and Fabricated HDPE	For HDPE AWWA C906 Pipe	✓			GF Central Plastics Products	-	<p style="text-align: center;"><u>Shall only be used in lift stations</u></p> <p style="text-align: center;">Refer to Manatee County Public Works Utility Standards Detail US-19</p> <p style="text-align: center;">Pressure Class 200, PE4710, Ductile Iron Pipe Size (DIPS), DR 11, AWWA C906</p> <p style="text-align: center;">Min. Cell Classification per ASTM D3350 shall be 445574</p> <p style="text-align: center;">Fittings shall be fused per manufacturer's recommendations</p>
			✓			Charter Plastics Products	-	
			✓			Performance Pipe Products	-	
			✓			Specified Fittings Products	-	
			✓			Integrity Fusion Products	-	
	Molded and Fabricated PVC	For Pressurized PVC AWWA C900-16 Pipe	✓			NACO	Pressure Gasketed Fittings	<p style="text-align: center;"><u>Shall only be used for P-traps and drop manholes</u></p> <p style="text-align: center;">All fittings shall be connected via water-tight push-on joints using elastomeric gaskets per ASTM D3139 rated for pressurized PVC pipe</p> <p style="text-align: center;">Pressure Class 150, DR 18, AWWA C900-16/C907</p>
			✓			Harrington Corp	C900 Fittings	
			✓			Multi Fittings Corp.	C900/C905 Fittings	
			✓			Specified Fittings	C900 Fittings	
		For Gravity Sewer PVC AWWA C900-16 Pipe (18" and Larger)	✓			Harrington Corp	C900 Fittings	<p style="text-align: center;"><u>Shall only be used for drop manholes</u></p> <p style="text-align: center;">All fittings shall be connected via water-tight push-on joints using elastomeric gaskets per ASTM D3212 rated for gravity sewer PVC pipe</p> <p style="text-align: center;">Pipe sizes 18" - 54": DR 25, AWWA C900-16/C907</p>
✓					Multi-Fittings Corp.	C900/C907 Fittings		
✓					North American Pipe Corp.	N-Series		
For Gravity Sewer PVC ASTM D3034 Pipe		✓			Harrington Corp.	SDR 26 Fittings	<p style="text-align: center;"><u>Shall only be used for sewer laterals and drop manholes</u></p> <p style="text-align: center;">All fittings shall be connected via water-tight push-on joints using elastomeric gaskets per ASTM D3212 rated for gravity sewer PVC pipe</p> <p style="text-align: center;">Pipe sizes 4" - 15": SDR 26, ASTM D3034</p>	
		✓			Multi Fittings Corp.	Trench Tough Plus		
		✓			Tigre-ADS USA	SDR 26 Gasketed		
	✓			North American Pipe Corp.	G-Series			



UTILITY APPROVED PRODUCT LIST

FEBRUARY 2020

Category				Submittal	Potable Water	Reclaimed Water	Wastewater	Manufacturer	Model Number	Notes
External Thrust Restraint Devices	PVC AWWA C900-16 (4" - 12")	Pipe to Pipe connections	Split-Casing Restraint	✓	✓	✓	Ford Meter Box Co.	Series UFR1390-C (DI, PVC) (4" - 12")	<p><u>All sizes:</u> 235 psi rating</p> <p>Buried thrust restraints shall be wrapped with an approved external polyethylene encasement color coded blue for potable water, purple for reclaimed water, and green for sewer</p> <p><u>For buried installations:</u> T-bolts, tie rods, nuts, and washers shall be High Strength, Low Alloy Steel conforming to AWWA C111/ANSI A21.11-17 or ASTM A242.</p> <p>Side clamping bolts shall be medium carbon steel per SAE J429 Grade 5/ASTM A449</p> <p>Side clamping nuts shall be medium carbon steel per SAE J995 Grade 2/ASTM A449</p> <p>Hardware referenced above shall be coated with a blue fluoropolymer coating (Xylan 1424, FluoroKote #1, or AFT-PTFE-Blue).</p> <p>Alternatively, hardware shall be 316 SS.</p> <p><u>For aboveground installations:</u> T-bolts, tie rods, nuts, and washers shall be 316 SS</p> <p>Side clamping bolts shall be min. 316 SS per ASTM A193 Grade B8M, Class 2</p> <p>Side clamping nuts shall be min. 316 SS per ASTM A194 Grade 8M, Class 1</p> <p><u>Restraint devices shall have the following factory applied high performance coatings:</u></p> <p>Star Pipe Products: Starbond System</p> <p>Sigma Corp.: CORRSAFE System</p> <p>EBAA Iron: MEGA-BOND System</p> <p>Ford Meter Box Co.: Armorguard E-Coat System</p> <p>SIP Industries: EZ Shield System</p> <p><u>Potable/Reclaimed Water:</u></p> <p><u>For uncontaminated soils:</u> Shall have EPDM rubber gaskets with the letters "EPDM" factory embossed and/or etched into gasket</p> <p><u>For contaminated soils:</u> Shall have NBR or FKM rubber gasket</p> <p>Refer to Manatee County Public Works Utility Standards Section 1.4.2.F for gasket material details</p>	
				✓	✓	✓	EBAA Iron	Series 1900 (4" - 12")		
				✓	✓	✓	Star Pipe Products	PVC Series 1100G2C (4" - 12")		
				✓	✓	✓	Sigma Corp.	PV-LOK Series D-PWP (DI, PVC) (4" - 12")		
		Wedge-Action Restraint	✓	✓	✓	Star Pipe Products	PVC Stargrip Series 4100P (4" - 12")			
			✓	✓	✓	Sigma Corp.	ONE-LOK Series SLCEH (4" - 12")			
		Pipe to MJ Fittings connections	Split-Casing Restraint	✓	✓	✓	Star Pipe Products	PVC Series 1000G2 (DI, PVC) (4" - 12")		
				✓	✓	✓	Sigma Corp.	PV-LOK Series PWM-C (4" - 12")		
	Wedge-Action Restraint		✓	✓	✓	EBAA Iron	Series 2000PV (4" - 12")			
			✓	✓	✓	Star Pipe Products	PVC Stargrip Series 4000 (HDPE, PVC) (4" - 12")			
			✓	✓	✓	SIP Industries	EZ Grip Series EZPVCP (4" - 12")			
			✓	✓	✓	Sigma Corp.	ONE-LOK Series D-SLCE (4" - 12")			
	Pipe to PVC Fittings connections	Split-Casing Restraint	✓	✓	✓	EBAA Iron	Series 2600 (4" - 12")			
			✓	✓	✓	Star Pipe Products	Series 1200G2C (4" - 12")			
			✓	✓	✓	SIP Industries	Series PTPFC (4" - 12")			
			✓	✓	✓	Sigma Corp.	PV-LOK Series PWPF (4" - 12")			

Contractor shall check/mark which product is intended to be used in the submittal box. If multiple manufacturers are to be used, each manufacturer shall be marked.



UTILITY APPROVED PRODUCT LIST

FEBRUARY 2020

Category		Submittal	Potable Water	Reclaimed Water	Wastewater	Manufacturer	Model Number	Notes
External Thrust Restraint Devices	PVC AWWA C900-16 (14" - 36")	Pipe to Pipe connections	Split-Casing Restraint	✓	✓	✓	Star Pipe Products	Series 1100C (14" - 36")
				✓	✓	✓	Sigma Corp.	PV-LOK Series D-PWP (DI, PVC) (14" - 36")
			Wedge-Action Restraint	✓	✓	✓	EBA Iron	Megalug Series 2800 (14" - 16")
				✓	✓	✓	Star Pipe Products	PVC Stargrip Series 4400 (14" - 20")
				✓	✓	✓		Series 1100C* (24" - 36")
				✓	✓	✓	Ford Meter Box Co.	Series UFR1390-C* (DI, PVC) (24" - 36")
	Pipe to MJ Fittings connections	Split-Casing Restraint	✓	✓	✓	Star Pipe Products	Series 1000C (14" - 36")	
			✓	✓	✓	Sigma Corp.	PV-LOK Series D-PWM (14" - 24")	
		Wedge-Action Restraint	✓	✓	✓	EBA Iron	Series 2000PV (HDPE, PVC) (14" - 16", 24")	
			✓	✓	✓	Star Pipe Products	PVC Stargrip Series 4000 (HDPE, PVC) (14" - 36")	
			✓	✓	✓	SIP Industries	EZ Grip Series EZPVCP (14" - 36")	
			✓	✓	✓	Sigma Corp.	ONE-LOK Series D-SLCE (HDPE, PVC) (24" - 36")	
		Pipe to PVC Fittings connections	Split-Casing Restraint	✓	✓	✓	Sigma Corp.	PV-LOK Series PWP (14" - 24")

All sizes: 235 psi rating

Buried thrust restraints shall be wrapped with an approved external polyethylene encasement color coded blue for potable water, purple for reclaimed water, and green for sewer

For buried installations: T-bolts, tie rods, nuts, and washers shall be High Strength, Low Alloy Steel conforming to AWWA C111/ANSI A21.11-17 or ASTM A242.

Side clamping bolts shall be medium carbon steel per SAE J429 Grade 5/ASTM A449
Side clamping nut shall be medium carbon steel per SAE J995 Grade 2/ASTM A449

Hardware referenced above shall be coated with a blue fluoropolymer coating (Xylan 1424, FluoroKote #1, or AFT-PTFE-Blue).
Alternatively, hardware shall be 316 SS.

For aboveground installations: T-bolts, tie rods, nuts, and washers shall be 316 SS
Side clamping bolts shall be min. 316 SS per ASTM A193 Grade B8M, Class 2
Side clamping nuts shall be min. 316 SS per ASTM A194 Grade 8M, Class 1

Restraint devices shall have the following factory applied high performance coatings:
 Star Pipe Products: Starbond System
 Sigma Corp.: CORRSAFE System
 EBA Iron: MEGA-BOND System
 Ford Meter Box Co.: Armorguard E-Coat System
 SIP Industries: EZ Shield System

Potable/Reclaimed Water:

For uncontaminated soils: Shall have EPDM rubber gaskets with the letters "EPDM" factory embossed and/or etched into gasket
For contaminated soils: Shall have NBR or FKM rubber gasket

Refer to Manatee County Public Works Utility Standards Section 1.4.2.F for gasket material details



UTILITY APPROVED PRODUCT LIST

FEBRUARY 2020

Category				Submittal	Potable Water	Reclaimed Water	Wastewater	Manufacturer	Model Number	Notes
External Thrust Restraint Devices	HDPE AWWA C906	Pipe to MJ Fittings connections	Split-Casing Restraint	✓	✓	✓	EBAA Iron	Series 15PF00 (4" - 12")	<p><u>All sizes:</u> 160 psi rating</p> <p>Buried thrust restraints shall be wrapped with an approved external polyethylene encasement color coded blue for potable water, purple for reclaimed water, and green for sewer</p> <p><u>For buried installations:</u> T-bolts, tie rods, nuts, and washers shall be High Strength, Low Alloy Steel conforming to AWWA C111/ANSI A21.11-17 or ASTM A242.</p> <p>Side clamping bolts shall be medium carbon steel per SAE J429 Grade 5/ASTM A449</p> <p>Side clamping nut shall be medium carbon steel per SAE J995 Grade 2/ASTM A449</p> <p>Hardware referenced above shall be coated with a blue fluoropolymer coating (Xylan 1424, FluoroKote #1, or AFT-PTFE-Blue).</p> <p>Alternatively, hardware shall be 316 SS.</p> <p><u>For aboveground installations:</u> T-bolts, tie rods, nuts, and washers shall be 316 SS</p> <p>Side clamping bolts shall be min. 316 SS per ASTM A193 Grade B8M, Class 2</p> <p>Side clamping nuts shall be min. 316 SS per ASTM A194 Grade 8M, Class 1</p> <p>All restrained joints shall be designed for HDPE Pipe conforming to AWWA C906 and Ductile Iron Pipe Size (DIPS) Dimensions</p> <p>Shall include 316 SS pipe stiffening insert</p> <p>ABS Spacers shall not be removed from actuating bolts on HDPE Pipe (DIPS)</p> <p><u>Restraint devices shall have the following factory applied high performance coatings:</u></p> <p>Star Pipe Products: Starbond System</p> <p>Sigma Corp.: CORRSAFE System</p> <p>EBAA Iron: MEGA-BOND System</p> <p>Ford Meter Box Co.: Armorguard E-Coat System</p> <p>SIP Industries: EZ Shield System</p> <p><u>Potable/Reclaimed Water:</u></p> <p><u>For uncontaminated soils:</u> Shall have EPDM rubber gaskets with the letters "EPDM" factory embossed and/or etched into gasket</p> <p><u>For contaminated soils:</u> Shall have NBR or FKM rubber gasket</p> <p>Refer to Manatee County Public Works Utility Standards Section 1.4.2.F for gasket material details</p>	
				✓	✓	✓		Series 15MJ00 (4" - 12")		
				✓	✓	✓		Sigma Corp. PV-LOK Series PVM-C (4" - 12)		
			Wedge-Action Restraint	✓	✓	✓	EBAA Iron	Series 2000PV (HDPE, PVC) (4" - 12")		
				✓	✓	✓		Star Pipe Products PVC StarGrip Series 4000 (HDPE, PVC) (4" - 18")		
				✓	✓	✓		Sigma Corp. ONE-LOK Series D-SLCE (HDPE, PVC) (4" - 12")		

Contractor shall check/mark which product is intended to be used in the submittal box. If multiple manufacturers are to be used, each manufacturer shall be marked.



UTILITY APPROVED PRODUCT LIST

FEBRUARY 2020

Category				Submittal	Potable Water	Reclaimed Water	Wastewater	Manufacturer	Model Number	Notes
External Thrust Restraint Devices	Ductile Iron Pipe AWWA C150 & C151	Pipe to Pipe connections	Split-Casing Restraint	✓	✓	✓	EBAA Iron	Series 1500TD (4" - 12")	<p style="text-align: center;"><u>Pipe sizes 2" - 16"</u>: 350 psi rating <u>Pipe sizes 18" and larger</u>: 250 psi rating</p> <p>Buried thrust restraints shall be wrapped with an approved external polyethylene encasement color coded blue for potable water, purple for reclaimed water, and green for sewer</p> <p><u>For buried installations</u>: T-bolts, tie rods, nuts, and washers shall be High Strength, Low Alloy Steel conforming to AWWA C111/ANSI A21.11-17 or ASTM A242. Side clamping bolts shall be medium carbon steel per SAE J429 Grade 5/ASTM A449 Side clamping nuts shall be medium carbon steel per SAE J995 Grade 2/ASTM A449 Hardware referenced above shall be coated with a blue fluoropolymer coating (Xylan 1424, FluoroKote #1, or AFT-PTFE-Blue). Alternatively, hardware shall be 316 SS.</p> <p><u>For aboveground installations</u>: T-bolts, tie rods, nuts, and washers shall be 316 SS Side clamping bolts shall be min. 316 SS per ASTM A193 Grade B8M, Class 2 Side clamping nuts shall be min. 316 SS per ASTM A194 Grade 8M, Class 1</p> <p><u>Restraint devices shall have the following factory applied high performance coatings:</u> Star Pipe Products: Starbond System Sigma Corp.: CORRSAFE System EBAA Iron: MEGA-BOND System Ford Meter Box Co.: Armorguard E-Coat System SIP Industries: EZ Shield System</p> <p style="text-align: center;"><u>Potable/Reclaimed Water:</u></p> <p><u>For uncontaminated soils</u>: Shall have EPDM rubber gaskets with the letters "EPDM" factory embossed and/or etched into gasket <u>For contaminated soils</u>: Shall have NBR or FKM rubber gasket Refer to Manatee County Public Works Utility Standards Section 1.4.2.F for gasket material details</p> <p><u>MJ Fitting to MJ Fitting Connections in Potable/Reclaimed Water:</u> <u>Interior Coating</u>: Std. thickness cement lining per AWWA C104 <u>Exterior Coating</u>: Std. 1-mil asphaltic coating per AWWA C110/C153</p> <p style="text-align: center;"><u>MJ Fitting to MJ Fitting Connections in Wastewater:</u></p> <p>Holiday-free factory certification per ASTM G62, Method A (Low-Voltage) shall be provided for the interior coating at the point of delivery <u>Interior Coating</u>: Green, factory applied dry film thickness 40-mil Tnemec Series 431 Perma-Shield PL or Permax CTF coating <u>Exterior Coating</u>: Std. 1-mil asphaltic coating per AWWA C151</p>	
				✓	✓	✓	Star Pipe Products	Stargrip Series 3100S (3" - 48")		
				✓	✓	✓	Sigma Corp.	ONE-LOK Series SSLDH (4" - 36")		
			Wedge-Action Restraint	✓	✓	✓	EBAA Iron	Series 1700 (4" - 48")		
				✓	✓	✓	Star Pipe Products	Stargrip Series 3100P (4" - 48")		
				✓	✓	✓	Sigma Corp.	ONE-LOK Series SLDEH (4" - 36")		
		✓		✓	✓	EBAA Iron	Series 1100SD (4" - 48")			
		Pipe to MJ Fittings connections	Split-Casing Restraint	✓	✓	✓	Star Pipe Products	Split Stargrip Series 3000S (4" - 48")		
				✓	✓	✓	Sigma Corp.	ONE-LOK Series SSLDH (4" - 36")		
				✓	✓	✓	EBAA Iron	Series 1100 (4" - 48")		
	Wedge-Action Restraint		✓	✓	✓	Star Pipe Products	Stargrip Series 3000 (4" - 48")			
			✓	✓	✓	SIP Industries	EZ Grip Series EZDP (DI, PVC) (3" - 48")			
			✓	✓	✓	Sigma Corp.	ONE-LOK Series D-SLDE (4" - 48")			
	MJ Fitting to MJ Fitting Connections	✓	✓	✓	Star Pipe Products	Series 100 (3" - 36")				
		✓	✓	✓	SIP Industries	MJ x MJ Adapter (3" - 12")				
✓		✓	✓	Infact Corp.	Foster Adapter (3" - 36")					

Contractor shall check/mark which product is intended to be used in the submittal box. If multiple manufacturers are to be used, each manufacturer shall be marked.



UTILITY APPROVED PRODUCT LIST

FEBRUARY 2020

Category		Submittal	Potable Water	Reclaimed Water	Wastewater	Manufacturer	Model Number	Notes
Plain End Couplings	Gravity Sewer PVC ASTM D3034 Plain End to Plain End Couplings	4" - 12"			✓	Fernco Products	Series 5000 RC	Shall be reinforced with 316 SS clamp band, bolts, and nuts Shear band shall be min. 304 SS
	Dissimilar Pipe Materials Plain End to Plain End Couplings	2" - 12"	✓	✓		Romac	Macro	<p><u>For buried installations:</u> T-bolts, bolts, tie rods, nuts, and washers shall be High Strength, Low Alloy Steel conforming to AWWA C111/ANSI A21.11-17 or ASTM A242. Hardware referenced above shall be coated with a blue fluoropolymer coating (Xylan 1424, FluoroKote #1, or AFT-PTFE-Blue). Alternatively, hardware shall be 316 SS.</p> <p><u>For aboveground installations:</u> T-bolts, bolts, tie rods, nuts, and washers shall be 316 SS</p> <p><u>Couplings shall have the following factory applied high performance coatings:</u> Romac: Romacoat System Krausz: Factory std. min. 14 mil fusion bonded epoxy EBAA Iron: MEGA-BOND System Holiday-free factory certification per ASTM G62, Method A (Low-Voltage) shall be provided for the interior coating at the point of delivery</p> <p><u>Potable/Reclaimed Water:</u> Couplings and gaskets for potable water shall be NSF61 certified</p> <p><u>For uncontaminated soils:</u> Shall have EPDM rubber gaskets with the letters "EPDM" factory embossed and/or etched into gasket</p> <p><u>For contaminated soils:</u> Shall have NBR or FKM rubber gasket</p> Refer to Manatee County Public Works Utility Standards Section 1.4.2.F for gasket material details
		2" - 12"	✓	✓		Krausz	Hymax 2 Coupling (Series 860)	
		4" - 48"	✓	✓		EBAA Iron	Mega-Coupling Series 3800	

Contractor shall check/mark which product is intended to be used in the submittal box. If multiple manufacturers are to be used, each manufacturer shall be marked.



UTILITY APPROVED PRODUCT LIST

FEBRUARY 2020

Category		Submittal	Potable Water	Reclaimed Water	Wastewater	Manufacturer	Model Number	Notes	
Flange Adapters	HDPE AWWA C906 Flange and MJ Adapters	✓	✓	✓	✓	Charter Plastics Products	-	Pressure Class 200, PE4710, Ductile Iron Pipe Size (DIPS), DR 11, AWWA C906 Min. Cell Classification per ASTM D3350 shall be 445574 Fittings shall be fused per manufacturer's recommendations Shall have 316 SS back-up ring <u>Potable/Reclaimed Water:</u> For uncontaminated soils: Shall have EPDM rubber gaskets with the letters "EPDM" factory embossed and/or etched into gasket For contaminated soils: Shall have NBR or FKM rubber gasket Refer to Manatee County Public Works Utility Standards Section 1.4.2.F for gasket material details	
		✓	✓	✓	✓	Improved Piping Products	-		
		✓	✓	✓	✓	Integrity Fusion Products	-		
		✓	✓	✓	✓	Performance Pipe Products	-		
	Pressurized PVC AWWA C900-16 Flange Adapters	4" - 20"	✓	✓	✓	✓	EBA Iron	Megaflange Series 2100 (DI, PVC)	<u>PVC Flange Adapter:</u> Pipe sizes 4"-36": 235 psi rating <u>DIP Flange Adapter:</u> Pipe sizes 2"-16": 350 psi rating Pipe sizes 18" and larger: 250 psi rating For aboveground installations: T-bolts, bolts, tie rods, nuts, and washers shall be 316 SS <u>Flange adapters shall have the following factory applied high performance coatings:</u> Star Pipe Products: Starbond System Sigma Corp.: CORRSafe System EBA Iron: MEGA-BOND System Ford Meter Box Co.: Armorguard E-Coat System <u>Potable/Reclaimed Water:</u> Flange adapters and gaskets for potable water shall be NSF61 certified Shall have EPDM rubber gaskets with the letters "EPDM" factory embossed and/or etched into gasket
		3" - 36"	✓	✓	✓	✓	Sigma Corp.	Sigmaflange SFA Series CP	
		4" - 20"	✓	✓	✓	✓	Star Pipe Products	Super Flange Series 7200 (DI, PVC)	
		3" - 36"	✓	✓	✓	✓		Starflange Series 4200	
	DIP AWWA C110 Flange Adapters	2" - 12"	✓	✓	✓	✓	Ford Meter Box Co.	Series 420	
		3" - 20"	✓	✓	✓	✓	EBA Iron	Megaflange Series 2100 (DI, PVC)	
			✓	✓	✓	✓	Star Pipe Products	Super Flange Series 7200 (DI, PVC)	
		All sizes except 18"	✓	✓	✓	✓		Starflange Series 3200	
All sizes except 18"		✓	✓	✓	✓	Sigma Corp.	Sigmaflange SFA Series DP		

Contractor shall check/mark which product is intended to be used in the submittal box. If multiple manufacturers are to be used, each manufacturer shall be marked.



UTILITY APPROVED PRODUCT LIST

FEBRUARY 2020

Category		Submittal	Potable Water	Reclaimed Water	Wastewater	Manufacturer	Model Number	Notes			
Valves	Air Release Valves		✓	✓	✓	GA Industries	Fig-929	Min. inlet size shall be 2" Orifice, float, linkage, and hardware shall be 316 SS The seal shall be made of Buna N elastomer			
			✓	✓	✓	H-TEC	Model 986-SS	<u>For waterway and canal crossings only</u> Min. inlet size shall be 2" Body, bolts, nuts, and washers shall be 316 SS The seal shall be made of Buna N elastomer			
	Privately-Owned		✓			-	-	Any privately-owned backflow prevention assembly that is approved by the University of Southern California (USC), with the exception of Wilkins 375XL (3/4" and 1"), Watts LF009QT (3/4" and 1"), and Ames LF4000B (3/4" and 1"), will be accepted by Manatee County County-Owned approved models are also acceptable			
	Backflow Prevention Assembly		County-Owned		2-1/2" - 12"		Wilkins (Zurn)	350DA	Double Check Valve Assembly w/ Meter		
								375DA	Reduced Pressure Zone Assembly w/ Meter		
								375DA-OS&Y	Reduced Pressure Zone Assembly w/ Meter (OS&Y)		
							Ames	2000SS	Double Check Valve Assembly		
								3000SS	Double Check Valve Assembly w/ Meter		
								4000SS	Reduced Pressure Zone Assembly		
								5000SS	Reduced Pressure Zone Assembly w/ Meter		
							1/2" - 2"		Apollo Valves	RPLF-4A Series	Reduced Pressure Zone Assembly
									Wilkins (Zurn)	975XL2	Reduced Pressure Zone Assembly
									Watts	Model LF007 Series	Double Check Valve Assembly
	Model 909 Series	Reduced Pressure Zone Assembly									
	Pressure Relief Valves		✓			Apollo Valves	16LF-202	For use with backflow prevention assemblies			
	Ball Valves		✓	✓	✓	FNW	Fig. 200A	<u>For use with ARV</u> Body, cap, stem, and ball shall be 316 SS/CF8M Min. Cold-Working Pressure shall be 1000 PSI			
			✓	✓	✓	Apollo Valves	Model 76F				
	Automatic Flushing Systems		On Ground Discharge		✓	Mueller	Hydro-Guard HG-1	Design considerations shall minimally include site drainage patterns, cross connection prevention, grounding, dichlorination requirements, and discharge permits			
✓					Hydro-Guard HG-2						

Contractor shall check/mark which product is intended to be used in the submittal box. If multiple manufacturers are to be used, each manufacturer shall be marked.



UTILITY APPROVED PRODUCT LIST

FEBRUARY 2020

Category				Submittal	Potable Water	Reclaimed Water	Wastewater	Manufacturer	Model Number	Notes		
Valves	Corporation Stops	For Copper Pipe and HDPE Tubing	All joints made to CTS size HDPE tubing shall use SS insert stiffeners	✓	✓	✓	✓	Ford Meter Box Co.	FB1000-x-NL	Pack Joint x AWWA Taper Thread (3/4" - 2")		
				✓	✓	✓	✓		FB1000-x-G-NL	Grip Joint Compression x AWWA Taper Thread (3/4" - 2")		
				✓	✓	✓	✓		FB1000-x-Q-NL	Quick Joint Compression x AWWA Taper Thread (3/4" - 2")		
				✓	✓	✓	✓		FB1100-x-NL	Pack Joint x MIP Thread (3/4" - 2")		
				✓	✓	✓	✓		FB1100-x-G-NL	Grip Joint Compression x MIP Thread (3/4" - 2")		
				✓	✓	✓	✓	A.Y. McDonald	74704B-22	Pack Joint x MIP Thread (3/4" - 2")		
				✓	✓	✓	✓		74701B-22	Pack Joint x AWWA Taper Thread (3/4" - 2")		
				✓	✓	✓	✓		74701BQ	Quick Joint Compression x AWWA Taper Thread (3/4" - 2")		
				✓	✓	✓	✓		74704BQ	Quick Joint Compression x MIP Thread (3/4" - 2")		
				✓	✓	✓	✓		74701BG	Grip Joint Compression x AWWA Taper Thread (3/4" - 2")		
		For Copper Pipe Only	✓	✓	✓	✓	✓	✓	✓	Ford Meter Box Co.	FB600-x-NL	Flare x AWWA Taper Thread (3/4" - 2")
											FB700-x-NL	Flare x MIP Thread (3/4" - 2")
										A.Y. McDonald	74704B	Flare x MIP Thread (3/4" - 2")
											74701B	Flare x AWWA Taper Thread (3/4" - 2")
											74704BG	Grip Joint Compression x MIP Thread (3/4" - 2")
	For Stainless Steel Pipe Only	✓	✓	✓	✓	✓	✓	Ford Meter Box Co.	FB1600-x-NL	FIP Thread x AWWA Taper Thread (3/4" - 2")		
									FB1700-x-NL	FIP Thread x MIP Thread (3/4" - 2")		
								A.Y. McDonald	73149B	FIP Thread x MIP Thread (3/4" - 2")		
									73148B	FIP Thread x AWWA Taper Thread (3/4" - 2")		
									73149N	Pack Joint x FIP Thread (3/4" - 2")		
									73148N	Grip Joint Compression x FIP Thread (3/4" - 2")		
	Curb Stops	For Copper Pipe and HDPE Tubing	All joints made to CTS size HDPE tubing shall use SS insert stiffeners	✓	✓	✓	✓	Mueller	P25170N	Pack Joint x FIP Thread (3/4" - 2")		
									G25170N	Grip Joint Compression x FIP Thread (3/4" - 2")		
								Ford Meter Box Co.	B41-xxxW-NL	Pack Joint x FIP Thread (3/4" - 2")		
									B41-xxxW-G-NL	Grip Joint Compression x FIP Thread (3/4" - 2")		
									76100W-22	Compression x Compression (3/4" - 2")		
									76100WT	Pack Joint x Pack Joint (3/4" - 2")		
									76102WG	Compression x FIP Thread (3/4" - 2")		
									76107T	Compression x MIP Thread (3/4" - 2")		
									76107-22	Pack Joint x MIP Thread (3/4" - 2")		
76107-2N									Pack Joint x FIP Thread (1/2" - 2")			
For Stainless Steel Pipe Only		✓	✓	✓	✓	✓	✓	Mueller	B20200N	FIP Thread x FIP Thread (1/2" - 2")		
									B20242N	MIP Thread x FIP Thread (1/2" - 2")		
									B51-xxxW-NL	Pack Joint x FIP Thread (1/2" - 2")		
								Ford Meter Box Co.	B11-xxxW-NL	FIP Thread x FIP Thread (1/2" - 2")		
									B81-xxxW-NL	MIP Thread x FIP Thread (1/2" - 2")		
A.Y. McDonald	76107	FIP Thread x MIP Thread (3/4" - 2")										
	76107WP	MIP Thread x MIP Thread (3/4" - 2")										
	76102W-44	PVC (DIOD) Compression x FIP Thread (3/4" - 2")										
	76101W	FIP Thread x FIP Thread (3/4" - 2")										

Contractor shall check/mark which product is intended to be used in the submittal box. If multiple manufacturers are to be used, each manufacturer shall be marked.



UTILITY APPROVED PRODUCT LIST

FEBRUARY 2020

Category			Submittal	Potable Water	Reclaimed Water	Wastewater	Manufacturer	Model Number	Notes
Valves	Gate Valves	Flange x Flange (NRS)	3" - 54"	✓	✓	✓	American Flow Control	Series 2500 FL x FL	<p style="text-align: center;"><u>All sizes:</u> min. 250 psi rating</p> <p style="text-align: center;"><u>Gate Valves larger than 2":</u> Shall be resilient seated valves conforming to AWWA C515</p> <p style="text-align: center;"><u>2" Gate Valves:</u> Shall be resilient seated valves conforming to applicable requirements of AWWA C509 or C515</p> <p style="text-align: center;">Body and bonnet shall be ductile iron</p> <p style="text-align: center;">Buried valves shall have external nuts, bolts, and washers be min. 304 SS</p> <p style="text-align: center;">Buried valves shall have min. 304 SS stems</p> <p style="text-align: center;">Aboveground valves shall have external nuts, bolts and washers be 316 SS</p> <p style="text-align: center;">Aboveground valves shall have 316 SS stems</p> <p style="text-align: center;">Stem nut shall be bronze/copper</p> <p style="text-align: center;">Wedge shall be ductile iron fully encapsulated in EPDM rubber with the letters "EPDM" factory embossed and/or etched into the wedge</p> <p style="text-align: center;">Valves shall have factory applied, min. 8 mils DFT fusion bonded epoxy coating on the interior and exterior</p> <p style="text-align: center;">Holiday-free factory certification per ASTM G62, Method A (Low-Voltage) shall be provided for the interior coating at the point of delivery</p> <p style="text-align: center;">Valves 16" and larger shall be equipped with manufacturer-standard heavy duty gear type actuators with 2" square AWWA operating nut or handwheel</p> <p style="text-align: center;">Gearbox shall be externally adjustable, totally enclosed to prevent water infiltration, and conform to ISO 9001 standards</p> <p style="text-align: center;">Vertical installation shall use spur-type gear</p> <p style="text-align: center;">Horizontal installation shall use bevel-type gear</p> <p style="text-align: center;">All horizontally-installed gate valves shall require flush line</p> <p style="text-align: center;"><u>Potable/Reclaimed Water:</u></p> <p style="text-align: center;">Aboveground gate valves shall be Outside Stem & Yoke (OS&Y) type</p> <p style="text-align: center;"><u>Wastewater:</u></p> <p style="text-align: center;">Valves shall only be installed vertically</p> <p style="text-align: center;"><u>For Force Mains:</u> Gate valves only allowed for sizes 24" and larger</p> <p style="text-align: center;">Refer to Plug Valve Section for Force Mains sizes 20" and smaller</p> <p style="text-align: center;"><u>For Lift Stations:</u> Gate valves allowed for sizes 3" and larger</p> <p style="text-align: center;">Aboveground valve assembly gate valves shall be Non-Rising Stem (NRS) type</p> <p style="text-align: center;"><u>Valves 16" and larger shall come with torque-limiting device with torque trip limits preset at factory:</u></p> <p style="text-align: center;"><u>Kennedy Valves:</u></p> <p style="text-align: center;">16": 250 lb-ft, 18" - 54": 450 lb-ft</p> <p style="text-align: center;"><u>American Flow Control Valves:</u></p> <p style="text-align: center;">16" - 20": 250 lb-ft, 24": 300 lb-ft, 30" - 54": 500 lb-ft</p> <p style="text-align: center;"><u>Clow Valves:</u></p> <p style="text-align: center;">16": 250 lb-ft, 18" - 54": 450 lb-ft</p> <p style="text-align: center;"><u>Mueller Valves:</u></p> <p style="text-align: center;">16" - 24": 100 lb-ft, 30" - 36": 200 lb-ft, 42" - 54": 350 lb-ft</p>
			4" - 54"	✓	✓	✓	Kennedy	Model KS-RW/2638 FL x FL	
			4" - 54"	✓	✓	✓	Mueller	Model A-2361 FL x FL	
			4" - 48"	✓	✓	✓	Clow	Model 2638 FL x FL	
		Flange x Flange (OS & Y)	3" - 54"	✓	✓	✓	American Flow Control	Series 2500 FL x FL (OS & Y)	
			4" - 54"	✓	✓	✓	Kennedy	Model KS-RW/2638 FL x FL (OS & Y)	
			4" - 54"	✓	✓	✓	Mueller	Model A-2361 FL x FL (OS & Y)	
			4" - 24"	✓	✓	✓	Clow	Model 2638 FL x FL (OS & Y)	
		Mechanical Joint x Mechanical Joint	4" - 48"	✓	✓	✓	American Flow Control	Series 2500 MJ x MJ	
				✓	✓	✓	Mueller	Model A-2361 MJ x MJ	
				✓	✓	✓	Kennedy	Model KS-RW/2638 MJ x MJ	
				✓	✓	✓	Clow	Model 2638 MJ x MJ	
		Threaded x Threaded	2"	✓	✓	✓	American Flow Control	Series 2500 FIP x FIP	
				✓	✓	✓	Clow	Model 2639	

Contractor shall check/mark which product is intended to be used in the submittal box. If multiple manufacturers are to be used, each manufacturer shall be marked.



UTILITY APPROVED PRODUCT LIST

FEBRUARY 2020

Category		Submittal	Potable Water	Reclaimed Water	Wastewater	Manufacturer	Model Number	Notes	
Valves	Hydrants		✓	✓		AVK	Series 2780	<p>Shall be nostalgic-style, dry barrel conforming to AWWA C502 and be UL/FM certified Main valve shall be faced or covered with EPDM elastomer with the letters "EPDM" factory embossed and/or etched into the rubber</p> <p>Shall have one 5-inch Storz connection and two 2-1/2 inch hose nozzles All external nuts, bolts, and washers shall be min. 304 SS Upper and lower stem rod shall be min. 304 SS</p> <p><u>Hydrant Elbow</u>: Shall have a fusion bonded epoxy coating on the interior and exterior <u>Stand Pipe</u>: Shall have std. thickness cement lining on the interior and 1 mil asphaltic coating on the exterior; Alternatively it shall have a fusion bonded epoxy coating on the interior and exterior</p> <p><u>Aboveground parts shall have an external UV-resistant top coat of min. 4 mils DFT as follows:</u> Kennedy: Ken-Guard TGIC Polyester Mueller: Amercoat 370 AVK: Sherwin Williams Acrolon 218 HS Polyurethane Clow: TGIC Polyester Super Coat American Flow Control: Axalta Imron 3.5 HG+ Polyurethane</p>	
			✓	✓		Mueller	Super Centurion 250		
			✓	✓		Kennedy	K81D Guardian		
			✓	✓		Clow	Medallion		
			✓	✓		American Flow Control	Darling B-84-B-5		
	Insertion Valves		4" - 12"	✓	✓		TEAM	InsertValve	<p>Shall be resilient seated valves conforming to AWWA C515 All nuts, bolts, washers, and non-rising stem shall be min. 304 SS</p> <p>Wedge shall be ductile iron fully encapsulated in EPDM rubber with the letters "EPDM" factory embossed and/or etched into the wedge</p> <p>Valves shall have factory applied, min. 8 mils DFT fusion bonded epoxy coating on the interior and exterior</p>
	Check Valves	Flapper Disk	2" - 48"	✓	✓		Valmatic	Series 500ABF	<p><u>All sizes</u>: min. 250 psi rating</p> <p>Check valve shall be lead free, ductile iron construction conforming to NSF 61 Shall be equipped with min. 17-4 SS seat position indicator and min. 304 SS backflow actuator</p> <p>Disk shall be fully encapsulated in EPDM rubber with the letters "EPDM" factory embossed and/or etched into the disk All external bolts, nuts, and washers shall be min. 304 SS</p> <p>Valve shall have factory-applied, min. 8 mils DFT fusion bonded epoxy coating on the interior and exterior Holiday-free factory certification per ASTM G62, Method A (Low-Voltage) shall be provided for the interior coating at the point of delivery</p>
			2" - 24"	✓	✓		Pratt	RD Series	
			3" - 16"	✓	✓		American Cast Iron Pipe Company	Series 2100	
		Lever & Weight			✓	✓		AVK	Series 41
✓					✓		American Flow Control	Series 52	
✓					✓		Kennedy	106 LW	
✓	✓					1106 LW			
				✓	✓	Mueller	Series 8001		
				✓	✓			No. A-2600-6-01	

Contractor shall check/mark which product is intended to be used in the submittal box. If multiple manufacturers are to be used, each manufacturer shall be marked.



UTILITY APPROVED PRODUCT LIST

FEBRUARY 2020

Category		Submittal	Potable Water	Reclaimed Water	Wastewater	Manufacturer	Model Number	Notes	
Valves	Combination Pressure Reducing and Pressure Sustaining	✓	✓			Cla-Val Company	8" Model 52-01	Pressure sustaining and check valve shall be pilot operated diaphragm actuated valve with cast iron body, bronze trim, and 125-lb flanges Pilot system shall consist of two direct acting, adjustable, spring loaded diaphragm valves Pilot control valves shall be cast brass with min. 304 SS trim	
		✓	✓			Singer	8" Model A106-RPS		
		✓	✓			Watts	8" Model LFF116-52		
	Plug Valves	2"				✓	Pratt	Series 611A/613A	<p>Plug valves shall be 100% circular port, non-lubricated, eccentric type Shall be installed with the shaft laying horizontally so that the seat rests on the top portion of body when open Shall shut off bubble tight bidirectionally when pressure tested at 175 PSI for 3"-12" and 150 PSI for 14" and larger Valve body, bonnet, and gland shall be ASTM A126 cast iron or ASTM A526 Grade 65-45-12 ductile iron per AWWA C517 Plug shall be ASTM A-526 Grade 65-45-12 ductile iron per AWWA C517 Plug shall be fully vulcanized with nitrile (Buna N) rubber with a min. peel strength of 75 PSI per ASTM D429, method B Top and bottom bearings shall be 316 SS All external nuts, bolts, and washers shall be min. 304 SS Valve shall be equipped with manufacturer-standard worm gear type actuators with 2" square AWWA operating nut Gearbox shall be externally adjustable, totally enclosed to prevent water infiltration, and conform to ISO 9001 standards Gearbox bearings shall be oil impregnated bronze or hardened steel Gearbox worm gear shall be hardened steel or ductile iron ASTM A536 Class 65-45-12 Gearbox shaft shall be hardened steel</p> <p><u>2"</u>: Valve seat shall have an overlay of min. 16 mils DFT high solids epoxy Shall only be allowed at grinder pump stations <u>3" and larger</u>: Valve seat shall have a welded-in overlay of at least 95% pure nickel</p> <p style="text-align: center;"><u>Refer to Gate Valve Section for applications larger than 20"</u></p> <p><u>Valves shall come with torque-limiting device with torque trip limits preset at factory:</u> 3" - 6": 150 ft-lb 8" - 20": 180 ft-lb</p> <p>All valves shall have internal and external min. 16 mils DFT high solids epoxy coating Holiday-free factory certification per ASTM G62, Method A (Low-Voltage) shall be provided for the interior coating at the point of delivery</p>
		3" - 12"				✓		Series 600FP/601FP	
		2"				✓	Milliken	Series 611A/613A	
		3" - 12"				✓		Series 600F/601F	
		ye				✓	GA Industries	Figure 517-T	
		3" - 20"				✓		Figure 517 Eco-Centric	
	Torque Limiting Device	Trip Torque Limit: 25-250 lb-ft	✓	✓	✓		Aunspach Controls	Model D86-250	Torque limits shall be preset at factory (See gate/plug valve section for torque limits) Permanently mount overtorque protector on the valve operating nut All hardware shall be min. 304 SSS Shall have min. 8 mils DFT fusion bonded epoxy on the interior and exterior Torque set point shall be engraved on the torque limiting device
Trip Torque Limit: 251-500 lb-ft		✓	✓	✓		Model D86-500			
Valve Extension Stem		✓	✓	✓		Mueller Co.	-	Extension stems and hardware shall be min. 304 SS	
		✓	✓	✓		CS3 Waterworks	-		
		✓	✓	✓		GPM Fab	-		

Contractor shall check/mark which product is intended to be used in the submittal box. If multiple manufacturers are to be used, each manufacturer shall be marked.

Category		Submittal	Potable Water	Reclaimed Water	Wastewater	Manufacturer	Model Number	Notes
Valves	Tapping Valves	✓	✓	✓	American Flow Control	Series 2500 FL x MJ	<p>Shall be resilient seated valves conforming to AWWA C515 Shall be furnished with an alignment lip All external nuts, bolts, washers, and non-rising stem shall be min. 304 SS Wedge shall be ductile iron fully encapsulated in EPDM rubber with the letters "EPDM" factory embossed and/or etched into the wedge Valves shall have factory applied min. 8 mils DFT fusion bonded epoxy coating on the interior and exterior Holiday-free factory certification per ASTM G62, Method A (Low-Voltage) shall be provided for the interior coating at the point of delivery Valve 16" and larger shall be equipped with manufacturer-standard heavy duty gear type actuators with 2" square AWWA operating nut Gearbox shall be externally adjustable, totally enclosed to prevent water infiltration, and conform to ISO 9001 standards Vertical installation shall use spur-type gear Horizontal installation shall use bevel-type gear</p> <p>Wastewater: Valves shall only be installed vertically</p> <p><u>Tapping valves 16" and larger shall come with torque-limiting device with torque trip limits preset at factory:</u> Refer to Gate Valve section for trip limits</p>	
		✓	✓	✓	Kennedy	Model KS-RW/2638 FL x MJ		
		✓	✓	✓	Mueller	Model T-2361 FL X MJ		
		✓	✓	✓	Clow	Series 2638 FL x MJ		
Tapping Sleeves	HDPE	4" - 30"	✓	✓	JCM Industries	Model 6452/6459 (HDPE)	<p>Sleeve and straps shall be 316 SS T-bolts, bolts, tie rods, nuts, and washers shall be 316 SS Shall have 3/4" 316 SS test plug</p> <p>Potable/Reclaimed Water: Must hold 180 PSI for one hour Tapping sleeve and gaskets for potable water shall be NSF61 certified For uncontaminated soils: Shall have min. 1/8" thick EPDM full face gasket Shall have EPDM rubber wrap around gasket The letters "EPDM" and company logo shall be factory stamped with white ink on full face gasket The letters "EPDM" and company logo shall be factory stamped with white ink on the wrap around gasket Alternatively, the letters "EPDM" shall be factory embossed and/or etched on the exterior shell of the tapping sleeve if wrap around gasket does not have the EPDM designation For contaminated soils: Shall have NBR or FKM rubber gasket Refer to Manatee County Public Works Utility Standards Section 1.4.2.F for gasket material details</p> <p>Wastewater: Must hold 150 PSI for one hour Shall have min. 1/8" thick full face gasket</p>	
		4" - 24"		✓	Ford Meter Box Co.	FTSSP-xxx-x-MAN		
		4" - 12"		✓		STS423-H		
	PVC, Ductile Iron, Steel, AC	6" - 48"		✓	Romac	STS420 (316 SS)		
		6" - 12"	✓	✓		STS420 (316 SS)		
		4" - 24"		✓	Ford Meter Box Co.	FTSS-xxx-x-MAN		
				✓	Cascade Waterworks	Series CST-EX (316 SS)		
				✓	PowerSeal	Series 3490 (316 SS)		
4" - 30"	✓	✓	JCM Industries	Model 6452/6459				



UTILITY APPROVED PRODUCT LIST

FEBRUARY 2020

Category		Submittal	Potable Water	Reclaimed Water	Wastewater	Manufacturer	Model Number	Notes
Service Saddles	HDPE	4" - 12"	✓	✓	✓	Romac	STS423T-H	<p>Potable/Reclaimed Water: Must hold 180 PSI for one hour Saddle body shall be made of red brass, alloy 85-5-5-5 or min. 304 SS Saddle strap shall be made of silicon bronze or min. 304 SS T-bolts, bolts, tie rods, nuts, and washers shall be red brass, alloy 85-5-5-5 or min. 304 SS Service saddle and gasket shall be NSF61 certified for potable water</p> <p>For uncontaminated soils: Shall have EPDM rubber gasket The letters "EPDM" and company logo shall be factory stamped with white ink on gasket Alternatively, the letters "EPDM" shall be factory embossed and/or etched on the exterior saddle body</p> <p>For contaminated soils: Shall have NBR or FKM rubber gasket Refer to Manatee County Public Works Utility Standards Section 1.4.2.F for gasket material details</p> <p>Wastewater: Must hold 150 PSI for one hour Saddle body and extra wide strap shall be 316 SS T-bolts, bolts, tie rods, nuts, and washers shall be 316 SS</p>
		2" - 12"	✓	✓	✓	Ford Meter Box Co.	FSP313-xxx-TAP-EPDM	
		10" - 18"	✓	✓	✓		FSP323-xxx-TAP-EPDM	
		20" - 34"	✓	✓	✓		FSP333-xxx-TAP-EPDM	
		2" - 3"	✓	✓	✓		FS313W-xxx-TAP-EPDM	
	PVC, Ductile Iron, Steel, AC	Romac	4" - 16"	✓	✓	✓	202BS (Double Bolt)	
			6" - 12"	✓	✓	✓	Model STS420T	
			6" - 42"	✓	✓	✓	Model STS420T (316 SS)	
		JCM Industries	3" - 54"	✓	✓	✓	Model 6438	
			3" - 54"	✓	✓	✓	Model 438	
			2" - 12"	✓	✓	✓	Model 502	
		Ford Meter Box Co.	4" - 12"	✓	✓	✓	202B (DI and AC only)	
			4" - 12"	✓	✓	✓	202BS	
			4" - 30"	✓	✓	✓	202BSD	
			2" - 12"	✓	✓	✓	FS313-xxx-TAP-MAN	
			4" - 18"	✓	✓	✓	FS323-xxx-TAP-MAN	
			20" - 30"	✓	✓	✓	FS333-xxx-TAP-MAN	
			2" - 12"	✓	✓	✓	FS313-xxx-TAP-EPDM	
			4" - 18"	✓	✓	✓	FS323-xxx-TAP-EPDM	
			20" - 30"	✓	✓	✓	FS333-xxx-TAP-EPDM	



UTILITY APPROVED PRODUCT LIST

FEBRUARY 2020

Category		Submittal	Potable Water	Reclaimed Water	Wastewater	Manufacturer	Model Number	Notes		
Jack and Bore Devices	Casing Spacers	Metallic	✓	✓	✓	BWM Company	Model BWM-SS-8	<p><u>Metallic Casing Spacers:</u> Bolts, nuts, and washers shall be 316 SS Shell/band shall be min. 14 gauge 304 SS Risers shall be min. 10 gauge 304 SS Each shell section shall have a hardness of Durometer "A" 85-90 and be lined with a min. thickness of 0.090" of ribbed PVC extrusion, EPDM, glass reinforced polymer, or ultra high molecular weight polyethylene.</p>		
			✓	✓	✓		Model BWM-SS-12			
			✓	✓	✓	Advanced Products & Systems, Inc.	Model SS18			
			✓	✓	✓		Model SS12			
			✓	✓	✓	CCI Pipeline Systems	Model CSS-8			
			✓	✓	✓		Model CSS-12			
			✓	✓	✓	Cascade Waterworks	Series CCS 8"			
			✓	✓	✓		Series CCS 12"			
			Non-Metallic	✓	✓	✓	RACI Products		-	<p><u>Non-Metallic Casing Spacers:</u> Shall be constructed of non-metallic virgin polypropylene or HDPE Shall be sized/spaced per manufacturer's recommendations</p>
				✓	✓	✓	GPT Industries		Ranger II	
	End Seals			✓	✓	✓	BWM Company	Model BWM-PO	<p>Shell/band shall be min. 14 gauge 304 SS</p> <p><u>For buried installations:</u> T-bolts, bolts, tie rods, nuts, and washers shall be High Strength, Low Alloy Steel conforming to AWWA C111/ANSI A21.11-17 or ASTM A242.</p> <p>Hardware referenced above shall be coated with a blue fluoropolymer coating (Xylan 1424, FluoroKote #1, or AFT-PTFE-Blue). Alternatively, hardware shall be 316 SS.</p>	
				✓	✓	✓		Model BWM-WR		
				✓	✓	✓	Advanced Products & Systems, Inc.	Model AC		
				✓	✓	✓		Model AM		
				✓	✓	✓		Model AZ		
				✓	✓	✓		Model AW		
				✓	✓	✓	CCI Pipeline Systems	Model ESC		
				✓	✓	✓		Model ESW		
✓				✓	✓	Cascade Waterworks	Model CCES			
✓				✓	✓	GPT Industries Products	-			



UTILITY APPROVED PRODUCT LIST

FEBRUARY 2020

Category		Submittal	Potable Water	Reclaimed Water	Wastewater	Manufacturer	Model Number	Notes		
Asset Protection/Locators	Tracer Wire	✓	✓	✓		Proline Safety	Pro-Trace HF-CSS	To be used for <u>open cut installations</u> Solid #10 gauge, high strength, copper clad steel wire (Min. 448 PSI break load) Min. 30-mils polyethylene insulation Color coded blue for water, purple for reclaimed water, or green for sanitary sewer		
		✓	✓	✓		Copperhead Industries	1030-HS			
		✓	✓	✓		Proline Safety	Pro-Trace HDD-CSS			
		✓	✓	✓		Copperhead Industries	1045-EHS			
	Tracer Wire Connection		✓	✓	✓	Dryconn	King 6 Blue	-		
			✓	✓	✓		Direct Bury Lug Aqua			
	Tracer Wire Boxes		Non-traffic rated	✓	✓	✓	Copperhead Industries	Model LD14*TP	Shaft size shall be min. 2-1/2" I.D. and 15" length Rim shall be ABS plastic with cast iron lid	
				✓	✓	✓	Bingham & Taylor	Model P202CNG		
			Traffic-rated	✓	✓	✓	Copperhead Industries	Model RB14*TP		Tracer wire box shall be encased in a 6" concrete square, 6" in depth Shaft size shall be min. 2-1/2" I.D. and 14-1/2" length Rim and lid shall be cast iron
				✓	✓	✓	Bingham & Taylor	Model P2B202CNGHVY15SPB		
	Path Marking Tape	Electronic	✓	✓	✓	3M	Series 7600XR	All underground pipe shall have electronically detectable path marking tape made of polyethylene, minimum 6" wide and 6 mm thick The tape shall have embedded detectable markers spaced every 8 feet along the warning tape The tape shall be color coded blue for potable water, purple for reclaimed water, or green for sanitary sewer Shall be marked "CAUTION _____ LINE BURIED BELOW"		
	Polyethylene Encasement Tubing		✓	✓	✓	T. Christy's Enterprises	-	Shall be min. 8 mil thick, low density polyethylene tubing conforming to AWWA C105 Shall be color coded blue for potable water, purple for reclaimed water, and green for sanitary sewer		
✓			✓	✓	AA Thread	-				
✓			✓	✓	Trumbull	-				

Contractor shall check/mark which product is intended to be used in the submittal box. If multiple manufacturers are to be used, each manufacturer shall be marked.



UTILITY APPROVED PRODUCT LIST

FEBRUARY 2020

Category		Submittal	Portable Water	Reclaimed Water	Wastewater	Manufacturer	Model Number	Notes
		✓	✓	✓	✓			
Valve Boxes	Valve Boxes and Lid Assembly	✓	✓	✓	✓	Pro Select	Series PSVB 461 - 664	<p style="text-align: center;">Assembly shall be cast iron, screw type boxes & lids Alternatively, HDPE boxes shall be two-piece adjustable, min. 1/4-inch thick wall, w/ cast iron lid Bottom Barrel shall be 5-1/4 inches inside diameter, with a flanged bottom Lids shall have color coded tops with the lettering "WATER" or "SEWER"</p> <p style="text-align: center;">Roadway Applications: Shall use heavy duty, min. 24 lbs cast iron drop-type lid</p> <p style="text-align: center;">Reclaimed Water: Shall have square 9" x 9" lid labeled "Reclaimed Water" Shall be colored purple</p>
		✓	✓	✓	✓	Tyler Union	Series 6500/6850/6860	
		✓	✓	✓	✓	East Jordan Company Products	Series 8550	
		✓	✓	✓	✓		6800045 (Roadway)	
		✓	✓	✓	✓		6800073 (Roadway)	
		✓	✓	✓	✓	Sigma Corp./Russell Pipe Company Products	Series VB261 - VB268	
		✓	✓	✓	✓		Series VB630	
		✓	✓	✓	✓	Star Pipe Products	Series VB-0001/VB-0002	
		✓	✓	✓	✓		Series VB-0005/VB-0006	
		✓	✓	✓	✓		Series VB-0023	
	✓	✓	✓	✓	American Flow Control	Trench Adapter		
Box Alignment Rings	✓	✓	✓	✓	Boxlok Products	Model 3 & 4	Contractor is responsible for verifying alignment ring model number will properly fit valve model	
Air Release Valve Enclosure	✓	✓	✓	✓	Allied Molded Products	ARVC-2439	All enclosures shall comply with Manatee County standard detail for shape and size 24" square by 39" tall <u>fiberglass</u> enclosure with a hasp for a padlock Shall have polyester infused aggregate protective coating color coded per application	
Service Lateral Clean Out Lid	✓	✓	✓	✓	US Foundry	USF 7621	Clean out lid shall have the letter "S" engraved and pick holes	
Meter Boxes	✓	✓	✓	✓	SIP Industries	6423-WNL	Non-locking, colored blue for potable water	
	✓	✓	✓	✓		6423-WL	Locking, colored blue for potable water	
	✓	✓	✓	✓		6423-RWNL	Non-locking, colored purple for reclaimed water	
	✓	✓	✓	✓		6423-RWL	Locking, colored purple for reclaimed water	
Meter Resetters	✓	✓	✓	✓	Ford Meter Box Co.	VB 42-7W (5/8" X 3/4")	<p style="text-align: center;">Shall conform to AWWA C800 Meter resetters shall have padlock wing on angle ball valve Riser Height shall be 7 inch</p>	
	✓	✓	✓	✓		VB 43-7W (3/4")		
	✓	✓	✓	✓		VB 44-7W (1")		
	✓	✓	✓	✓	A.Y. McDonald	718-207WX (5/8" X 3/4")		
	✓	✓	✓	✓	Mueller Co.	B-24118		
Water Sample Stations	✓	✓	✓	✓	Safety Guard	Model B.O.S.S.	Bacteriological sample station with built in flush system Shall be installed with UV-protected enclosure	

Contractor shall check/mark which product is intended to be used in the submittal box. If multiple manufacturers are to be used, each manufacturer shall be marked.



UTILITY APPROVED PRODUCT LIST

FEBRUARY 2020

Category		Submittal	Potable Water	Reclaimed Water	Wastewater	Manufacturer	Model Number	Notes	
Manholes	Precast Polymer Concrete Manholes				✓	US Composite Pipe	-	<p style="text-align: center;"><u>Manholes shall be made of precast polymer concrete in the following applications:</u></p> <ul style="list-style-type: none"> • Manholes receiving force main flow and the next two (2) downstream manholes • Manholes upstream of a lift station (Refer to Manatee County Public Works Utility Standards detail US-17A) • Manholes that have turbulent opposing flows (Refer to Manatee County Public Works Utility Standards detail US-3) <ul style="list-style-type: none"> • Manholes with 12-inch and greater gravity sewer pipes • Outside drop manholes <p style="text-align: center;">Refer to Manatee County Public Works Utility Standards Section 1.13 for details</p> <p style="text-align: center;">Manholes shall be furnished with an approved heavy duty composite frame & lid Frame & lid shall have min. three (3) 316 SS locking bolts Refer to Frame & Lids section of this Approved Product List for approved manufacturers</p>	
					✓	Armorock	-		
	Precast Concrete Manholes					✓	-	-	<p>Precast concrete manholes shall be installed for all applications <u>except</u> where a polymer concrete manhole is required as identified in the Precast Polymer Concrete Manholes section</p> <p style="text-align: center;">Refer to Manatee County Public Works Utility Standards Section 1.12 for details</p> <p style="text-align: center;">Only premade O-ring gaskets shall be allowed for joint connection Ramnek or similar products shall not be an acceptable method of joint connection</p>
	Flexible Pipe Connectors	Cast-In Boot (New Construction Only)				✓	A-Lok Products	Z-Lok	Must meet ASTM C923
						✓	Trelleborg	Series 706	<p><u>Contractor shall grout the annular space between the pipe and wall penetration per manufacturer's recommendations with the following:</u></p> <p><u>Polymer Concrete Manholes:</u> Sauereisen 165/Sikadur 42 Epoxy/ArmorRock Grout <u>Precast Concrete Manholes:</u> Avanti Multi-Grout AV-202/AV-118</p> <p style="text-align: center;"><u>Cast-In Boot:</u> Shall have external take down clamp and hardware made of 316 SS</p> <p style="text-align: center;"><u>Jack-In Boot:</u> Shall have external take down clamp and hardware made of 316 SS Shall have internal expansion band and hardware made of min. 304 SS</p>
						✓	Press-Seal Corp.	Cast-A-Seal Series	
		Jack-In Boot (Existing Construction Only)				✓	Trelleborg	Kor-N-Seal Series 106/206/406	
						✓	Press-Seal Corp.	PSX Direct Drive	
						✓	Hamilton Kent	Tylox MIB Series	
	Rainwater Inserts	Stainless Steel				✓	SSI Sealing Systems	304 SS	
					✓	Rowland	InflowShield		
Plastic					✓	USSI	TPO Inflow Defender Max		

Contractor shall check/mark which product is intended to be used in the submittal box. If multiple manufacturers are to be used, each manufacturer shall be marked.



UTILITY APPROVED PRODUCT LIST

FEBRUARY 2020

Category		Submittal	Potable Water	Reclaimed Water	Wastewater	Manufacturer	Model Number	Notes	
Manholes	Standard				✓	U.S. Foundry	USF 170-CE-1	Shall be used for <u>precast concrete manholes</u> Lids be marked with the letters: "MANATEE COUNTY", "SANITARY SEWER", AND "YEAR"	
	Rim Elevation below Floodplain				✓	U.S. Foundry	USF 170-CE-BWT	Shall be used for <u>precast concrete manholes with lids that are located at less than the flood plain elevations</u> as specified in the Manatee County Public Works Utility Standards Section 1.12.12 Shall have gasketed seals Shall have min. three (3) 316 SS locking bolts	
	ARV Manholes with < 44" From Top of Pipe to Cover	✓	✓	✓	✓	Pamrex	Pamtight		
		✓	✓	✓	✓	Pamrex	Pamrex 32"	Shall be used for <u>ARV hinged manholes with less than 44" from top of pipe to cover</u> In roadways, the lid shall open in the direction opposite of incoming traffic	
	Heavy Duty Composite	✓	✓	✓	✓	U.S. Foundry	USF 324-UT-LOC		
					✓	Composite Access Products	CAP ONE	Shall be used with all <u>precast polymer concrete manholes</u> Must have "MANATEE COUNTY", "SANITARY SEWER", AND "YEAR" formed/molded Shall have min. three (3) 316 SS locking bolts	
					✓	Trumbull	Model 367		
				✓	Aquatechnology Group	ATG-2400			
	Grade Adjustment Ring Adhesives					✓	Henry	Ram-Nek RN101	Butyl rubber sealant strips shall be used to seal grade adjustment rings to manhole cone Min. 3" wide x 1/2" thick
						✓	Martin Asphalt	Evergrip 990	
	External Joint Wrap	Heat Shrink-Wrap				✓	GPT Industries	Riser-Wrap	To be used on Bell and Spigot or Tongue and Groove Smooth Wall Manhole Joints: A min. of eighteen (18) inches wide heat shrinkable joint wrap shall be centered over all new manhole joints including chimney to manhole frame section
						✓	CCI Pipeline Systems	WrapidSeal	
		Non-Shrink Wrap				✓	GPT Industries	Boa-Tape	To be used on all Tongue and Groove Smooth Wall Manhole Joints: A min. of twelve (12) inches wide elastomeric plastic joint wrap shall be centered over all new and existing manhole joints including chimney to manhole frame section
					✓	Henry	Rubr-Nek RU116		
	Polymer Grout					✓	Armorock	ArmorRock Grout	Non-shrink, polymer grout shall be used for grouting applications in precast polymer concrete manholes including wall penetrations and adjusting benches
					✓	Sauereisen	No. 165		
					✓	Sikadur	No. 42		
Grout					✓	Avanti	Multi-Grout AV-202/AV-118	Shall be used for grouting applications in precast concrete manholes including wall penetrations and adjusting benches	
Internal Joint Sealants	Bell and Spigot Manhole Joints				✓	Henry	Ram-Nek RN101	Butyl rubber sealant strips shall be applied to the interior of bell and spigot manhole joints per manufacturer's recommendations Min. 3" wide x 1/2" thick	
					✓	Martin Asphalt	Evergrip 990		
					✓	ConSeal	CS102		
	Tongue and Groove Smooth Wall Manhole Joints				✓	Chemlink	M-1	A bead of sealant shall be applied to the interior of tongue and groove smooth wall manhole joints per manufacturer's recommendations Min. 3/4" wide x 1/2" thick	
				✓	Adeka	UltraSeal P-201			
Protective Liners (Rehabilitation)					✓	Raven Lining Systems	Raven 405	Liners shall only be used with written approval from Manatee County to rehabilitate existing manhole concrete surfaces Liners shall be installed per manufacturer's recommendations	
					✓	GML Coatings	Green Monster		

Contractor shall check/mark which product is intended to be used in the submittal box. If multiple manufacturers are to be used, each manufacturer shall be marked.



UTILITY APPROVED PRODUCT LIST

FEBRUARY 2020

Category		Submittal	Potable Water	Reclaimed Water	Wastewater	Manufacturer	Model Number	Notes		
Electrical	Site Lighting				✓	Regent	Model EQ300M1	Min. 6000 lumens LED		
	Level Switches and Sensors				✓	MDI Products	-	Float switch		
					✓	Connery Manufacturing	-	Float switch		
					✓	Dylix	Model GXS3-PP300-A49-B49-50-C01-D49	Pressure transmitter mounted inside a stilling well acting as the primary level sensor For pump stations that re-pump sewage flows from other pump stations		
Flow Meters				✓	McCrometer	Ultra Mag Model UM06	Shall be used for lift stations that re-pump sewage flows (directly or indirectly) from other lift stations			
Lift Stations	Submersible Pumps	Satellite			✓	ABS	-	Refer to Manatee County Public Works Utility Standards Section 1.14 for details Pumps shall have oil-filled cooling system		
					✓	Barnes	-			
					✓	Crane	Sithe Series			
					✓	Hydromatic	-			
		Master			✓	Hydromatic				
					✓	Flygt	-			
	Mechanical	Pumps			✓	Godwin Pumps	-		Refer to Manatee County Public Works Utility Standards Section 1.14.14 for details	
			Cooling System Fluid			✓	Prestone Products		-	
					✓	Zerex Products	-			
		Diesel Backup Pumps	Protective Coating			✓	Carboline		Bitumastic 300M	Pump/Engine enclosures shall have a coal tar epoxy coating, min. 16 mils DFT, for all metal surfaces coming in contact with concrete or grout
						✓	Tnemec		46H-413	Alternatively, a 1/32-inch neoprene gasket between any metal surface and the concrete or masonry shall be used. Gasket shall be installed along the entire perimeter of the metallic surface, not just the fastening hardware.
					✓	Sherwin Williams	SherGlass FF		Fuel tank/skid base shall have haze grey, two coats of min. 12-15 mils DFT on top of a stripe coat over all welds, crevices, edges and sharp angles	



UTILITY APPROVED PRODUCT LIST

FEBRUARY 2020

Category		Submittal	Potable Water	Reclaimed Water	Wastewater	Manufacturer	Model Number	Notes
Lift Stations	Structural	Lift Station Wetwell			✓	US Composite Pipe	-	All lift station wetwells shall be made of precast polymer concrete Refer to Manatee County Public Works Utility Standards Section 1.13 for details
					✓	Armorock	-	
		Drop Bowl			✓	Reliner/Duran Products	-	If required, shall be installed per Manatee County Standard Details
		Wall Penetration Seals			✓	GPT Industries	Link-Seal Model S-316	All hardware shall be 316 SS
					✓	CCI Pipeline Systems	Wrap-IT Link WL-SS Series	
					✓	Proco Products	PenSeal ES Series (Standard)	
		Horizontal Support Channels (For Control Panels Only)			✓	Unistrut Products	-	Min. 1-5/8", 12 gauge solid min. 304 SS channels, attached with 3/8" min. 304 SS all thread rod with min. 304 SS flat washers and nuts Refer to Manatee County Public Works Utility Standards details
					✓	BLine Products	-	
		U-Bolt Clamps			✓	ZSI Inc.	Alpha Series	Riser pipes shall be attached to riser pipe brackets by cushioned 316 stainless steel U-bolt clamps and nylon insert locknuts Thermoplastic cushion shall be resistant to Hydrogen Sulfide gas
		Pump Mounting Systems			✓	Barney's Pumps	-	All systems shall be of the front loading slide rail type BPIU All rail and mounting hardware shall be 316 SS
Lift Station Towers			✓	Rohn	Series RG-45	For heights above 20 feet		
Aluminum Access Covers			✓	U.S. Foundry Products	-	Shall be aluminum have min. load rating of 300 PSF All hardware, hinges, and locking hasp shall be 316 SS Covers shall be equipped with a locking staple or bar for use with a padlock Shall have 2 coats of bitumastic epoxy, 16 mils DFT For Duplex Stations: 4" Base Elbow Wetwell: hatch shall be minimum 36" x 48" 6" Base Elbow Wetwell (8' Dia. Wetwell): hatch shall be minimum 42" x 60"		
			✓	Bilco Products	-			
			✓	Halliday Products	-			

Contractor shall check/mark which product is intended to be used in the submittal box. If multiple manufacturers are to be used, each manufacturer shall be marked.



UTILITY APPROVED PRODUCT LIST

FEBRUARY 2020

Category		Submittal	Potable Water	Reclaimed Water	Wastewater	Manufacturer	Model Number	Notes
Lift Stations	Surface Protection	Protective Insert Liners			✓	GU Florida	FRP GU Liner	<p style="text-align: center;">Liners shall only be used with written approval from Manatee County Liners shall be installed per manufacturer's recommendations</p> <p style="text-align: center;">Sealant, adhesive, and bonding agent products shall be compatible with liner material</p>
					✓	AGRU	HDPE Sure Grip Liner	
		Protective Liners (Rehabilitation)			✓	Raven Lining Systems	Raven 405	<p style="text-align: center;">Liners shall only be used with prior written approval from Manatee County to rehabilitate existing lift station concrete surfaces Liners shall be installed per manufacturer's recommendations</p>
					✓	GML Coatings	Green Monster	
					✓	CCI Spectrum	SpectraShield	
					✓	Sauereisen Products	210T & 210GL (MC Light Brown Formula)	
		Polymer Grout			✓	Armorock	ArmorRock Grout	<p style="text-align: center;">Non-shrink, polymer grout shall be used for grouting applications in polymer concrete lift stations including wall penetrations</p>
					✓	Sauereisen	No. 165	
					✓	Sikadur	No. 42	
	Grout Applications				✓	Avanti	Multi-Grout AV-202/AV-118	<p style="text-align: center;">Shall be used for grouting applications in precast concrete lift stations including wall penetrations</p>
	Coating	Valve Vault Interior			✓	Tnemec	Series 69 Hi-Build Epoxy Coating	<p style="text-align: center;">Interior surfaces of existing vaults shall have two (2) coats of min. 8 mils DFT each</p>
		Exposed Concrete			✓	FLR Paints, Inc.	H&C Silicone Acrylic Concrete Stain, Patio Green	<p style="text-align: center;">Exterior surfaces of valve vaults, wetwells, and valve assembly pads exposed above grade shall have at least two (2) coats of min. 8 mils DFT each</p>
		Exposed Valve Assembly			✓	Rustoleum	Series 7538	<p style="text-align: center;">Aboveground valve assembly & piping shall be painted Hunter Green per manufacturer's recommendations</p>
	Internal Joint Sealants	Bell and Spigot Wetwell Joints			✓	Henry	Ram-Nek RN101	<p style="text-align: center;">Butyl rubber sealant strips shall be applied to the interior of bell and spigot wetwell joints per manufacturer's recommendations Min. 3" wide x 1/2" thick</p>
					✓	Martin Asphalt	Evergrip 990	
				✓	ConSeal	CS102		
Tongue and Groove Smooth Wall Wetwell Joints				✓	Chemlink	M-1	<p style="text-align: center;">A bead of sealant shall be applied to the interior of tongue and groove smooth wall wetwell joints per manufacturer's recommendations Min. 3/4" wide x 1/2" thick</p>	
				✓	Adeka	UltraSeal P-201		

Contractor shall check/mark which product is intended to be used in the submittal box. If multiple manufacturers are to be used, each manufacturer shall be marked.

**ATTENDANCE RECORD for RFQ 21-TA003841CD – DESIGN-BUILD SERVICES
FOR COLONY COVE PIPELINE REPLACEMENTS AND PHASE 1 REPLACEMENTS
NON-MANDATORY INFORMATION CONFERENCE**

Location: Public Works Complex, Conference Room PW1,
1022 26th Ave East, Bradenton, FL 34208

Date/Time: December 16 2021 @ 10:00AM

Attendee Name	Company	Phone and Email Address
Chris Daley	MCG Procurement	941-749-3048 Chris.daley@mymanatee.org
Mike Beukema	Westra Const.	941-723-1611 Mike@westraconst.com
Blake Peters	Mckim & Creed	941-379-3404 bpeters@mckimcreed.com
Valerie Ciudad-Real	THE VALERIN GROUP Community Outreach	813-404-1572 VALERIEC@valerin-group.com
Sean McCarty	The Valerin Group	352-328-9401 Sean@valerin-group.com
Jim Penneberg	Manatee County PW	Jim.Penneberg@mymanatee.org 941-708-7450 x7220
Ed Penneberg	MC	ed.penneberg@mymanatee.org 941-219-6673
SAM FLOWERS	GARNER	sflowers@garner.com 941-725-2208
David Hunniford	V&A Consulting Engineers, Inc	dhunniford@vaengineering.com 941-928-3427
Matt Anderson	Woodruff & Sons	MattA@woodruffandsons.com 941-756-1871
HEATHER RIPLEY	KIMLEY HORN	heather.ripley@kimley-horn.com 330-763-6484
Lou Gaudio	Quality Enterprises USA, Inc.	LGaudio@QEUSA.com 239-207-0660
Joe DiStefano	Tienna, Inc.	813-439-8276 jdistefano@tiennaeng.com
Norman Robertson	Ardurra	850-251-1495 nrobertson@ardurra.com
ALBERT ROSENSTEIN	MCPW	albert.rosenstein@mymanatee.org 708-7450-32919