



**INVITATION FOR BID
IFB 17-0413OV
Intelligent Transportation Systems
Advanced Traffic Management System (ATMS)
SR 70 Adaptive Signal Control Project
(Project #6084261 6.2)
Financial Project ID (Federal Funds) 438870-1-58-01**

Manatee County, a political subdivision of the State of Florida, (hereinafter "County") will receive sealed bids from individuals, corporations, partnerships, and other legal entities organized under the laws of the State of Florida or authorized to conduct business in the State of Florida.

NON-MANDATORY INFORMATION CONFERENCE

In order to ensure all prospective bidders have sufficient information and understanding of County's needs, an Information Conference will be held at: **2:00 PM on January 27, 2017** at the **Public Works Department, 1022 26th Avenue East, Bradenton, FL 34208, Room "1"**. Attendance is not mandatory, but is highly encouraged.

DEADLINE FOR CLARIFICATION REQUESTS: **5:00 PM on February 2, 2017**

Reference Bid Article A.06

BID OPENING TIME AND DATE DUE: **3:30 PM on February 10, 2017**

FOR INFORMATION CONTACT:

Olga Valcich, CPPB, Contract Specialist
941-749-3055

Olga.valcich@mymanatee.org

Manatee County Financial Management Department
Procurement Division

AUTHORIZED FOR RELEASE: _____

A handwritten signature in black ink, appearing to be "OVA", is written over a horizontal line.

Table of Contents
IFB 17-0413OV
Intelligent Transportation Systems
Advanced Traffic Management System (ATMS)
SR 70 Adaptive Signal Control Project
(Project 6084261 6.2)
Financial Project ID (Federal Funds) 438870-1-58-01

Section A Information to Bidders.....A-1-15

Section B Scope of WorkB-1-2

Section C Bid Summary C-1-2

Section D Insurance and Bonding Requirements.....D1-7

Bid FormBid Form 1-5

Plan Set (Signed and Sealed October 21, 2016).....1 - 21 pages

Specifications Package Financial Project ID(S). 438870-1-58-01 dated December 20, 2016
..... 1 - 48 pages

Special Provisions dated December 5, 2016.....1 - 17 pages

Local Agency Program Supplemental Conditions (LAP) dated January 10, 2017...1 - 5 pages

FHWA 1273 (Revised May, 2012).....1 - 12 pages

LAP Certification of Current Capacity (Form 525-010-46).....1 – 2 pages

DBE Bid & Bid Opportunity (Form 275-030-11).....1 – 2 pages

Certification for Disclosure of Lobbying Activities on Federal – Aid Contracts1 page
(Form 373-030-33)

Disclosure of Lobbying Activities (Form 373-030-34).....1 – 3 pages

Non-Collusion Declaration and Compliance with 49 CFR § (Form 575-060-13).....1 – 3 pages

Certification Regarding Debarment and Suspension (Form 375-030-32).....1 page

Title VI Compliance and Nondiscrimination (Appendices A and E).....1 – 2 pages

Wage Determination Table Number FL160218 dated January 8, 2016.....1 – 5 pages

Attachments:

Attachment A Bidder's Questionnaire 1-3

Attachment B Public Contracting & Environmental Crimes Certification 1-2

Attachment C The Florida Trench Safety Act..... 1

Attachment D ePayables Application 1

Attachment E Vendor Certification Regarding Scrutinized Companies List.....1

Attachment F Wage Determination Table, FL 160218, FL218, Construction Type Highway
Manatee County, FL.....1-5

Construction Agreement for Stipulated Sum1-29

General Conditions of the Construction AgreementGC 1-50

SECTION A
INFORMATION TO BIDDERS

A.01 OPENING LOCATION

Sealed bids will be **publicly opened** at the **Manatee County Procurement Division, 1112 Manatee Avenue West, Suite 803, Bradenton, Florida 34205** in the presence of County officials at the time and date stated, or soon thereafter. All bidders or their representatives are invited to attend the sealed bid opening.

Any bids received after the stated time and date will not be considered. It shall be the sole responsibility of the bidder to have their bid delivered to the Manatee County Procurement Division for receipt on or before the stated time and date. Bidder shall be solely and strictly responsible for its timely delivery to the Procurement Division. Bids delayed by mail, courier, or bids delayed for any other reason, shall not be considered, shall not be opened at the public opening, and arrangements shall be made for their return at the bidder's request and expense.

A.02 SEALED & MARKED

Bids shall be submitted in **duplicate, one original (marked Original) and one copy/copies (marked Copy)** of your **signed bid** shall be submitted in one **sealed** package, clearly marked on the outside **"Sealed Bid 17-0413OV, Intelligent Transportation Systems, Advanced Traffic Management System (ATMS), SR 70 Adaptive Signal Control Project (Project #6084261 6.2), Financial Project ID (Federal Funds) 438870-1-58-01"** along with your company name.

For your convenience, a mailing label is provided with this Invitation for Bid (IFB) package. Or, you may address the package as follows:

Manatee County Procurement Division
1112 Manatee Avenue West, Suite 803
Bradenton, Florida 34205

Sealed Bid 17-0413OV, Intelligent Transportation Systems,
Advanced Traffic Management System (ATMS), SR 70 Adaptive Signal Control
Project (Project #6084261 6.2), Financial Project ID (Federal Funds) 438870-1-58-01"

All blank spaces on the bid form must be filled in as noted with amounts extended and totaled and no changes shall be made in the wording of the forms or in the items thereupon. In the event a change is made in your submittal, the bidder shall write its initials by the change. Any bid may be rejected which contains any omissions, alterations, irregularities of any kind, or which shall in any manner fail to conform to the requirements of this IFB.

A bid made by an individual, either in his/her own or proper person or under a trade or firm name, shall be executed under the individual's signature. If made by a partnership, the bid shall be executed by two or more of the general partners. If made by a corporation, the bid shall be executed by its President or other legally authorized corporate officer or agent.

A.03 SECURING BID DOCUMENTS

IFB's and related documents are available on <http://www.mymanatee.org/purchasing> for download in a portable document format (.PDF) file by clicking on "Bids and Proposals" from the Procurement Division's web page. You may view and print these files using Adobe Reader software. If necessary, you may download a free copy of Adobe Reader from the link provided on the "Bids and Proposals" page.

Additionally, Manatee County collaborates with the Manatee Chamber of Commerce by announcing solicitation opportunities to the Chamber which are then passed to its members.

Manatee County may also use DemandStar to distribute bids. On the DemandStar website, <http://www.DemandStar.com>, click on the tab titled "My DemandStar" for more information regarding this service. Participation in the DemandStar system is not a requirement for doing business with Manatee County.

Complete copies of the IFB and all related documents are available for public inspection at the Manatee County Procurement Division, 1112 Manatee Avenue West, Suite 803, Bradenton, FL 34205, or by calling (941) 749-3014. Appointments are encouraged. Documents are available between the hours of 9:00 AM and 4:00 PM Monday through Friday, with the exception of holidays. A complete set of the IFB documents must be used in preparing bids. County assumes no responsibility for errors and misinterpretations resulting from the use of incomplete sets of bid documents.

A.04 EXAMINATION OF BID DOCUMENTS AND SITE(S)

It is the responsibility of each bidder before submitting a bid, to (a) examine the IFB documents thoroughly; (b) visit the Project Site(s) to become familiar with local conditions that may affect cost, progress, performance, or furnishing of the Work; (c) consider federal, state, and local codes, laws, and regulations that may affect costs, progress, performance, or furnishing of the Work; (d) study and carefully correlate bidder's observations with the IFB documents; and (e) notify County of all conflicts, errors, or discrepancies in the IFB documents.

Each bidder may, at bidder's own expense, make or obtain any additional examinations, investigations, explorations, tests and studies, and obtain any additional information and data which pertain to the physical conditions at or contiguous to the Project Site(s) or otherwise which may affect cost, progress, performance or furnishing of the Work and which bidder deems necessary to determine his bid for performing and furnishing the Work in accordance with the time, price and other terms and conditions of the IFB documents. County will provide each bidder access to the site(s) to conduct such explorations and tests.

Bidder shall fill all holes, clean up and restore the Project Site(s) to its former condition upon completion of such explorations. The lands upon which the Work is to be performed, rights-of-way and easements for access thereto, and other lands designated for use by successful bidder in performing the Work are identified in the IFB documents.

All additional lands and access thereto required for temporary construction facilities or storage of materials and equipment are to be provided by successful bidder. Easements for permanent structures or permanent changes in existing structures are to be obtained and paid for by County unless otherwise provided in the IFB documents.

Inspection of the Project Site(s) is a **requirement** to be considered for award of this bid. Prior to submitting a bid, each bidder shall examine the Project Site(s) and all conditions thereon fully familiarizing themselves with the full scope of the Work. Failure to become familiar with Project Site conditions will in no way relieve the successful bidder from the necessity of furnishing any materials or performing any Work that is required to complete the Project in accordance with the Project Plans and Specifications. Bidder shall acknowledge inspection of the Project Site(s) on his/her signed, submitted Bid Form.

A.05 MODIFICATION OF BID DOCUMENTS

If a bidder wishes to recommend changes to the IFB documents, the bidder shall furnish, in writing, data and information necessary to aid County in evaluating the request to modify the IFB documents. County is not obligated to make any changes to the IFB documents. Unless an addendum is issued, the IFB documents shall remain unaltered. **Bidders must fully comply with the IFB documents in their entirety.**

A.06 CLARIFICATION & ADDENDA

Each bidder shall examine all IFB documents and shall judge all matters relating to their adequacy and accuracy. Any inquiries, suggestions or requests concerning interpretation, clarification or additional information pertaining to this IFB shall be made through the Manatee County Procurement Division. County shall not be responsible for oral interpretations given by any County employee, representative, or others.

The deadline to submit to the Procurement Division, in writing, all inquiries, suggestions, or requests concerning interpretation, clarification or additional information pertaining to this IFB can be located on the cover page of this IFB document.

This deadline has been established to maintain fair treatment of all potential bidders, while maintaining progression of the Work.

If any addenda are issued to this IFB, County will post the documents on the Procurement Division's web page at <http://www.myanatee.org/purchasing>, and then by clicking on "Bids and Proposals." If the original solicitation was broadcast via DemandStar, the addenda will also be broadcast on the DemandStar distribution system to "Planholders" on this web service.

The issuance of a written addendum is the only official method whereby interpretation, clarification or additional information can be given.

It shall be the **responsibility of each bidder, prior to submitting a bid**, to contact the Procurement Division (see contact information on the cover page) to **determine if any addenda were issued** and to make such addenda a part of their bid.

A.07 CONFIDENTIALITY OF SECURITY RELATED RECORDS

(a) Pursuant to Florida Statutes § 119.071(3), the following records (hereinafter referred to collectively as “the Confidential Security Records”) are confidential and exempt from the disclosure requirements of Florida Statutes § 119.07(1):

1. A Security System Plan or portion thereof for any property owned by or leased to the County or any privately owned or leased property held by the County.
2. Building plans, blueprints, schematic drawings, and diagrams, including draft, preliminary, and final formats, which depict the internal layout and structural elements of a building, arena, stadium, water treatment facility, or other structure owned or operated by the County.
3. Building plans, blueprints, schematic drawings, and diagrams, including draft, preliminary, and final formats, which depict the internal layout or structural elements of an attractions and recreation facility, entertainment or resort complex, industrial complex, retail and service development, office development, or hotel or motel development in the possession of, submitted to the County.

(b) Contractor/Vendor agrees that it shall not, as a result of a public records request or for any other reason disclose the contents of, or release or provide copies of the Confidential Security Records to any other party absent the express written authorization of the County’s Property Management Director or to comply with a court order requiring such release or disclosure. To the extent Contractor/Vendor receives a request for such records, it shall immediately contact the County’s designated Contract Manager who shall coordinate the County’s response to the request. Notwithstanding the foregoing, the Contractor/Vendor may

1. Disclose or release Security System Plans to:

- (A) The property owner or leaseholder; or
- (B) Another state or federal agency to prevent, detect, guard against, respond to, investigate, or manage the consequences of any attempted or actual act of terrorism, or to prosecute those persons who are responsible for such attempts or acts.

2. Disclose or release building plans, blueprints, schematic drawings, and diagrams, including draft, preliminary, and final formats, which depict the internal layout and structural elements of a building, arena, stadium, water treatment facility, or other structure owned or operated by the County:

- (A) To another governmental entity if disclosure is necessary for the

receiving entity to perform its duties and responsibilities;

(B) To a licensed architect, engineer, or contractor who is performing work on or related to the building, arena, stadium, water treatment facility, or other structure owned or operated by the County and is contractually bound by the Contractor/Vendor to comply with this Article/Section; or

(C) Upon a showing of good cause before a court of competent jurisdiction.

(c) For purposes of this Article/Section, the term "Security System Plan" includes all:

1. Records, information, photographs, audio and visual presentations, schematic diagrams, surveys, recommendations, or consultations or portions thereof relating directly to the physical security of the facility or revealing security systems;
2. Threat assessments conducted by any agency or any private entity;
3. Threat response plans;
4. Emergency evacuation plans;
5. Sheltering arrangements; or
6. Manuals for security personnel, emergency equipment, or security training.

A.08 LOBBYING

After the issuance of any IFB, prospective bidders or their agents, representatives or persons acting at the request of such bidder shall not contact, communicate with or discuss any matter relating to the IFB with any officer, agent or employee of Manatee County other than the Purchasing Official or the contact identified in this IFB, pursuant to the Manatee County Code of Laws. This prohibition includes copying such persons on all written communication, including email correspondence. This requirement begins with the issuance of an IFB and ends upon execution of the final Agreement or when the IFB has been cancelled. Violators of this prohibition shall be subject to sanctions as provided in the Manatee County Code of Laws.

A.09 UNBALANCED BIDDING PROHIBITED

County recognizes that large and/or complex projects will often result in a variety of methods, sources, and prices. However, where in the opinion of County such variation does not appear to be justified, given bid requirements and industry and market conditions, the bid will be presumed to be unbalanced. Examples of unbalanced bids will include:

- a. Bids showing omissions, alterations of form, additions not specified, or required conditional or unauthorized alternate bids.
- b. Bids quoting prices that substantially deviate, either higher or lower, from those included in the bids of competitive bidders for the same line item unit costs.
- c. Bids where the unit costs offered are in excess of or below reasonable cost analysis values.

In the event County determines that a bid is presumed unbalanced, it will request the opportunity to and reserves the right to, review all source quotes, bids, price lists, letters of intent, etc., which the bidder obtained and upon which the bidder relied upon to develop its bid. County reserves the right to reject as nonresponsive any presumptive unbalanced bids where the bidder is unable to demonstrate the validity and/or necessity of the unbalanced unit costs.

A.10 FRONT LOADING OF BID PRICING PROHIBITED

Prices offered for performance and/or acquisition activities which occur early in the Project Schedule, such as mobilization; clearing and grubbing; or maintenance of traffic; that are substantially higher than pricing of competitive bidders within the same portion of the Project Schedule, will be presumed to be front loaded. Front loaded bids could reasonably appear to be an attempt to obtain unjustified early payments creating a risk of insufficient incentive for the bidder to complete the Work or otherwise creating an appearance of an undercapitalized bidder.

In the event County determines that a bid is presumed to be front loaded, it will request the opportunity to, and reserves the right to, review all source quotes, bids, price lists, letters of intent, etc., which the bidder obtained and upon which the bidder relied upon to develop the pricing or acquisition timing for these bid items. County reserves the right to reject as nonresponsive any presumptive front loaded bids where the bidder is unable to demonstrate the validity and/or necessity of the front loaded costs.

A.11 WITHDRAWAL OF BIDS

Bidders may withdraw bids as follows:

- a. Mistakes discovered before the public bid opening may be withdrawn by written notice from the bidder submitting the bid. This request must be received in the Procurement Division prior to the time set for delivery and opening of the bids. A copy of the request shall be retained and the unopened bid returned to the bidder; or
- b. After the bids are opened or a selection has been determined, but before an Agreement is signed, a bidder alleging a material mistake of fact may be permitted to withdraw their bid if:
 1. The mistake is clearly evident in the solicitation document; or
 2. Bidder submits evidence which clearly and convincingly demonstrates that a mistake was made. Request to withdraw a bid must be in writing and approved by the Purchasing Official.

A.12 IRREVOCABLE OFFER

Any bid may be withdrawn up until the time and date set for opening of the bid. Any bid not so withdrawn shall, upon opening, constitute an irrevocable offer for a period of

ninety (90) days to sell to Manatee County the goods or services set forth in the attached IFB until one or more of the bids have been duly accepted by County.

A.13 BID EXPENSES

All expenses for making bids to County are to be borne by the bidder.

A.14 RESERVED RIGHTS

County reserves the right to accept or reject any and/or all bids, to waive irregularities and technicalities, and to request resubmission. Also, County reserves the right to accept all or any part of the bid and to increase or decrease quantities to meet additional or reduced requirements of County. Any sole response received by the first submission date may or may not be rejected by County depending on available competition and current needs of County. For all items combined, the bid of the lowest, responsive, responsible bidder will be accepted, unless all bids are rejected.

The lowest, responsible bidder shall mean that bidder who makes the lowest bid to sell goods and/or services of a quality which meets or exceeds the quality of goods and/or services set forth in the IFB documents or otherwise required by County.

To be responsive, a bidder shall submit a bid which conforms in all material respects to the requirements set forth in the IFB.

To be a responsible bidder, the bidder shall have the capability in all respects to perform fully the bid requirements, and the tenacity, perseverance, experience, integrity, reliability, capacity, facilities, equipment, and credit which will assure good faith performance.

Also, County reserves the right to make such investigation as it deems necessary to determine the ability of any bidder to furnish the service requested. Information County deems necessary to make this determination shall be provided by the bidder. Such information may include, but shall not be limited to current financial statements, verification of availability of equipment and personnel, and past performance records.

A.15 APPLICABLE LAWS

Bidder must be authorized to transact business in the State of Florida. All applicable laws and regulations of the State of Florida and ordinances and regulations of Manatee County will apply to any resulting Agreement. Any involvement with the Manatee County Procurement Division shall be in accordance with the Manatee County Procurement Ordinance as amended.

A.16 COLLUSION

By submitting a bid to this IFB, bidder certifies that it has not divulged, discussed or compared its bid with any other bidder, and has not colluded with any other bidder or parties to this bid whatsoever. Also, bidder certifies, and in the case of a joint bid each party thereto certifies as to their own organization, that in connection with this bid:

- a. any prices and/or cost data submitted have been arrived at independently, without consultation, communication, or agreement, for the purpose of restricting competition, as to any matter relating to such prices and/or cost data, with any other bidder or with any competitor;
- b. any prices and/or cost data quoted for this bid have not been knowingly disclosed by the bidder and will not knowingly be disclosed by the bidder, prior to the scheduled opening, directly or indirectly to any other bidder or to any competitor;
- c. no attempt has been made or will be made by the bidder to induce any other person or firm to submit or not to submit a bid for the purpose of restricting competition;
- d. the only person or persons interested in this bid, principal or principals is/are named therein and that no person other than therein mentioned has any interest in this bid or in the resulting Agreement to be entered into; and
- e. no person or agency has been employed or retained to solicit or secure the resulting Agreement upon an agreement or understanding or a commission, percentage, brokerage, or contingent fee except bona fide employees or established commercial agencies maintained by bidder for purpose of doing business.

A.17 CODE OF ETHICS

With respect to this bid, if any bidder violates, directly or indirectly, the ethics provisions of the Manatee County Procurement Ordinance and/or Florida criminal or civil laws related to public procurement, including but not limited to Chapter 112, Part III, Code of Ethics for Public Officers and Employees, Florida Statutes, such bidder will be disqualified from eligibility to perform the Work described in this IFB, and may also be disqualified from furnishing future goods or services to, and from submitting any future bids to supply goods or services to, Manatee County.

By submitting a bid, the bidder represents to County that all statements made and materials submitted are truthful, with no relevant facts withheld. If a bidder is determined to have been untruthful in their bid or any related presentation, such bidder will be disqualified from eligibility to perform the Work described in this IFB, and may also be disqualified from furnishing future goods or services to, and from submitting any future bids to supply goods or services to, Manatee County.

A.18 PUBLIC CONTRACTING AND ENVIRONMENTAL CRIMES

A person or affiliate who has been placed on the convicted vendor list following a conviction for a public entity crime, as that term is defined in Section 287.133, Florida Statutes, may not submit a bid to provide any goods or services to a public entity; may not submit a bid with a public entity for the construction or repair of a public building or public work; may not submit bids on leases of real property to a public entity; may not be awarded or perform Work as a contractor, supplier, Subcontractor, or consultant under an agreement with any public entity; and may not transact business with any public entity in excess of the threshold amount provided in Section 287.017, Florida

Statutes, for CATEGORY TWO for a period of thirty-six (36) months following the date of being placed on the convicted list.

In addition, the Manatee County Code of Laws prohibits the award of any bid to any person or entity who/which has, within the past five (5) years, been convicted of, or admitted to in court or sworn to under oath, a public entity crime or of any environmental law that, in the reasonable opinion of the Purchasing Official, establishes reasonable grounds to believe the person or business entity will not conduct business in a responsible matter.

To ensure compliance with the foregoing, the Code requires all persons or entities desiring to do business with County to execute and file with the Purchasing Official an affidavit, executed under the pain and penalties of perjury, confirming that person, entity and any person(s) affiliated with the entity, does not have such a record and is therefore eligible to seek and be awarded business with County. In the case of a business entity other than a partnership or a corporation, such affidavit shall be executed by an authorized agent of the entity. In the case of a partnership, such affidavit shall be executed by the general partner(s). A Public Contracting and Environmental Crimes Certification form is attached herein for this purpose.

A.19 SCRUTINIZED COMPANIES

Florida Statutes § 287.135, as amended from time to time, may contain limitations on the part of a company to conduct business with the County. Submission of a response to this solicitation shall be subject to all procedural requirements contained within that statute including the submission of any required certification of eligibility to contract with the County. It shall be the responsibility of the company responding to this solicitation to concurrently review the current version of the statute and ensure it is compliant. To the extent a certification is required, it shall be provided on the form located at **Attachment E Vendor Certification Regarding Scrutinized Companies Lists**.

A.20 BID FORMS

Bids must be submitted on the provided forms, although additional pages may be attached. **Bidders must fully complete all pages of the Bid Forms. Bid Forms must be executed by an authorized signatory who has the legal authority to make the bid and bind the company. Bidders must fully comply with all requirements of this IFB in its entirety.** Failure to comply shall result in bidder being deemed nonresponsive.

A.21 AGREEMENT FORMS

The Agreement resulting from the Acceptance of a bid shall be in the form of the Agreement stated in this IFB, which is attached herein.

A written notice confirming award or recommendation thereof will be forwarded to the successful bidder accompanied by the required number of unsigned counterparts of the Agreement. Within ten (10) days thereafter, successful bidder shall sign and deliver the required number of counterparts of the Agreement with any other required documents

to County. (Note: Agreement must be approved in accordance with Chapter 2-26 of the Manatee County Code of Laws and the Administrative Standards and Procedures Manual approved by the County Administrator).

A.22 LEGAL NAME

Bids shall clearly indicate the legal name, address and telephone number of the bidder on the Bid Form. Bid Forms shall be signed above the typed or printed name and title of the signer. The signer must have the authority to bind the bidder to the submitted bid.

When bidder is a partnership, the Bid Form shall be signed in the name of the firm and by all partners required under the terms of the partnership agreement. When a corporation is a bidder, the authorized corporate officers shall sign.

Bidders who are corporations or limited partnerships shall provide a certified copy of their permit to transact business in the State of Florida, preferably along with the Bid Form, or within forty-eight (48) hours after request by County.

When submitting a bid as a joint venture, it must have filed paper documents with the Division of Profession's Construction Industry Licensing Board prior to submitting a bid.

A.23 DISCOUNTS

Any and all discounts must be incorporated in the prices contained in the bid and not shown separately. The prices indicated on the Bid Form shall be the prices used in determining award.

A.24 TAXES

Manatee County is exempt from Federal Excise and State Sales Taxes. (F.E.T. Cert. No. 59-78-0089K; Florida Sales Tax Exempt Cert. No. 85-8012622206C-6); therefore, the bidder is prohibited from delineating a separate line item in his bid for any sales or service taxes. Nothing herein shall affect the bidder's normal tax liability.

The Contractor shall be responsible for the payment of taxes of any kind and character, including, but not limited to sales, consumer, use, and other similar taxes payable on account of the work performed and materials furnished under the award in accordance with the laws and Regulations of the place of the project which are applicable during the performance of the work. Nothing herein shall affect the bidder's normal tax liability.

A.25 DESCRIPTIVE INFORMATION

Unless otherwise specifically provided in the IFB documents, all equipment, materials and articles provided shall be new and of the most suitable grade for the purpose intended. Unless otherwise specifically provided in the IFB documents, reference to any equipment, material, article or patented process, by trade name, brand name, make or catalog number, shall be regarded as establishing a standard of quality and shall not be construed as limiting competition.

A.26 AUTHORIZED PRODUCT REPRESENTATION

The bidder, by virtue of submitting the name and specifications of a manufacturer's product, will be required to furnish the named manufacturer's product. Failure to perform accordingly may, in County's sole discretion, be deemed a material breach of the resulting Agreement, and shall constitute grounds for County's immediate termination of the resulting Agreement.

A.27 ROYALTIES AND PATENTS

The successful bidder shall pay all royalties and license fees for equipment or processes in conjunction with the equipment and/or services being furnished. Successful bidder shall defend all suits or claims for infringement of any patent, trademark or copyright, and shall save County harmless from loss on account thereof, including costs and attorney's fees.

A.28 AMERICANS WITH DISABILITIES ACT

County does not discriminate upon the basis of any individual's disability status. This non-discrimination policy involves every aspect of County's functions including one's access to, participation, employment, or treatment in its programs or activities. Anyone requiring **reasonable accommodation** for an Information Conference or Bid Opening should contact the person named on the cover page of this IFB document at least twenty-four (24) hours in advance of either activity.

A.29 EQUAL EMPLOYMENT OPPORTUNITY

In accordance with the provisions of Title VI of the Civil Rights Act of 1964 and Title 15, Part 8 of the Code of Federal Regulations, County hereby notifies all bidders that they will affirmatively ensure minority business enterprises will be afforded full opportunity to participate in response to this advertisement and will not be discriminated against on the grounds of race, color or national origin in consideration for bid award.

A.30 MBE/DBE

The State of Florida Office of Supplier Diversity provides the certification process and the database for identifying certified MBE/DBE firms. This service may be directly accessed at: <http://www.osd.dms.state.fl.us/iframe.htm>. If you have any questions regarding this State service, please contact their office at (850) 487-0915.

A.31 MATHEMATICAL ERRORS

Bid Forms without mathematical formulas:

In the event of multiplication/extension error(s), the unit price shall prevail. In the event of addition error(s) the extension totals will prevail. In the event the dollar amount for contract contingency is omitted, it will be added to the total price of the bid.

Bid Forms with mathematical formulas:

Interactive Bid Forms that contain mathematical formulas may be used for automating lengthy and complex bid forms. In the event these forms are used and a multiplication/extension error(s) is discovered, the unit price entered by the vendor shall prevail. The vendor shall assume the responsibility and accuracy of the information

input in the bid form and therefore shall verify that the calculations are correct before submitting their bid.

Regardless of which type of bid form is used, all bids shall be reviewed mathematically and corrected, if necessary, using these standards, prior to additional evaluation.

A.32 SUBCONTRACTORS

The successful bidder will obtain prior written approval from the County for any subcontractor(s) and the work they will perform. A subcontractor is defined as any entity performing work within the scope of the project who is not an employee of the successful bidder.

Bidders subcontracting any portion of the work shall include a list of subcontractors along with their bid. The list shall include: name and address of subcontractor, type of work to be performed and the percent of the contract amount to be subcontracted.

Prior to the employment of any person under this contract, the successful bidder shall utilize the U.S. Department of Homeland Security's E-Verify system to verify the employment eligibility of (a) all persons employed during the contract term by the successful bidder to perform employment duties within Florida and (b) all persons, including subcontractors, assigned by the successful bidder to perform work pursuant to the contract with Manatee County. For more information on this process, please refer to United States Citizenship and Immigration Service site at: <http://www.uscis.gov/>.

Only those individuals determined eligible to work within the United States shall be employed under this contract.

By submission of a bid in response to this IFB, the successful bidder commits that all employees and subcontractors will undergo e-verification before placement on this contract.

If County has reasonable objection to any subcontractor, the County may request the successful bidder to submit an acceptable substitute without an increase in contract sum or contract time.

If successful bidder declines to make any such substitution, the County may award the resulting agreement to the next lowest qualified bidder that proposes to use acceptable subcontractors, who County does not make written objection to. In the event the successful bidder declines to make any such substitution post award, the County may exercise its right to terminate the agreement.

The successful bidder shall maintain sole responsibility for the actions of its employees and subcontractors. New employees brought in after contract award shall follow the same requirement stated above for the life of the contract.

A.33 DISCLOSURE

Upon receipt, all inquiries and responses to inquiries related to this IFB become "Public Records," and shall be subject to public disclosure consistent with Florida Statutes, Chapter 119.

Bids become subject to disclosure thirty (30) days after the opening or if a notice of intent to award decision is made earlier than this time as provided by Florida Statutes § 119.071(1)(b). No announcement or review of the bids shall be conducted at the public opening.

Based on the above, County will receive bids at the time and date stated and will make public at the opening the names of the business entities of all that submitted a bid.

If County rejects all bids and concurrently notices its intent to reissue the solicitation, the rejected bids are exempt from public disclosure until such time as County provides notice of an intended decision concerning the reissued solicitation or until County withdraws the reissued solicitation. A bid is not exempt for longer than twelve (12) months after the initial notice rejecting all bids.

Pursuant to Florida Statutes 119.0701, to the extent Successful Bidder is performing services on behalf of the County, Successful Bidder must:

- a. Keep and maintain public records required by public agency to perform the service.
- b. Upon request from the public agency's custodian of public records, provide the public agency with a copy of the requested records or allow the records to be inspected or copied within a reasonable time at a cost that does not exceed the cost provided in Florida Statutes, Chapter 119, or as otherwise provided by law.
- c. Ensure that public records that are exempt or confidential and exempt from public records disclosure requirements are not disclosed except as authorized by law for the duration of the contract term and following completion of the contract if the Successful Bidder does not transfer the records to the public agency.
- d. Upon completion of the contract, transfer, at no cost, to the public agency all public records in possession of contractor or keep and maintain public records required by the public agency to perform the service. If the Successful Bidder transfers all public records to the public agency upon completion of the contract, the Successful Bidder shall destroy any duplicate public records that are exempt or confidential and exempt from public records disclosure requirements. If the Successful Bidder keeps and maintains public records upon completion of the contract, the Successful Bidder shall meet all applicable requirements for retaining public records. All records stored electronically must be provided to the public agency, upon request from public agency's custodian of public records, in a format that is compatible with the information technology systems of the public agency.

IF THE SUCCESSFUL BIDDER HAS QUESTIONS REGARDING THE APPLICATION OF CHAPTER 119, FLORIDA STATUTES, TO THE SUCCESSFUL BIDDER'S DUTY TO PROVIDE PUBLIC RECORDS RELATING TO ANY RESULTING CONTRACT, CONTACT COUNTY'S CUSTODIAN OF PUBLIC RECORDS AT: (941) 742-5845, debbie.scaccianoce@mymanatee.org, Attn: Records Manager, 1112 Manatee Ave W., Bradenton, FL 34205.

A.34 VENDOR REGISTRATION

Registering your business with Manatee County will enhance our opportunities to identify sources for goods and services, plus identify local businesses. This information is used for soliciting quotations up to \$250,000.00 and for competitive solicitations of larger purchases.

Our staff can assist you with your registration as needed. Our office hours are 8:00 A.M. to 5:00 P.M., Monday through Friday on regular business days. Please call (941) 749-3014 if you wish to have a Procurement staff member assist you.

Quick steps to registration: **www.mymanatee.org/purchasing**

A link to Vendor Registration is listed on the Procurement Division's web page under "Register as a Vendor." Click on "Vendor Registration Form" for on-line input.

Registration is not mandatory; however, by taking the time to register, you are helping County to provide timely notification of quotation, bid and proposal opportunities to your business.

A.35 ENVIRONMENTAL SUSTAINABILITY

All bidders are encouraged to use as many environmentally preferable "green" products, materials, supplies, etc. as possible in order to promote a safe and healthy environment. Environmentally preferable are products or services that have a reduced adverse effect on the environment.

Bidders shall acknowledge whether or not their organization has an environmental sustainability initiative by checking the appropriate box on the bid form. In addition, the bidder shall submit a summary of their environmental sustainability initiative along with their bid. This information will be used as a determining factor in the award decision when all other evaluative factors, including local preference policies are otherwise equal.

A.36 ePAYABLES

Manatee County and Clerk of the Circuit Court have partnered to offer the ePayables program, which allows payments to be made to vendors via credit cards. The Clerk will issue a unique credit card number to each vendor; the card has a zero balance until payments have been authorized.

If you are interested in participating in this program, please complete the ePayables Application attached herein and return the completed form via email to Lori Bryan at lori.bryan@manateeclerk.com.

NOTE: ANY OR ALL STATEMENTS CONTAINED IN THE FOLLOWING SECTIONS: SCOPE OF WORK, BID SUMMARY, CONSTRUCTION AGREEMENT FOR STIPULATED SUM, AND GENERAL CONDITIONS OF THE CONSTRUCTION AGREEMENT, WHICH VARY FROM THE INFORMATION TO BIDDERS, SHALL HAVE PRECEDENCE.

END OF SECTION A

SECTION B
SCOPE OF WORK

B.01 SCOPE OF WORK

The Work consists of the installation of conduit through open trench, directional drill and above ground as necessary to house multi conductor communication cable for new Vehicle Detection Electronics. Some sidewalk and driveway demolition and construction will be necessary in order to construct the new Vehicle Detection Electronics. The project area occurs at ten (10) different signal (intersection) locations as follows:

1. SR 70 (53rd Ave E) at 5th St W
2. SR 70 (53rd Ave E) at 9th St E
3. SR 70 (53rd Ave E) at 15th St E
4. SR 70 (53rd Ave E) at I-75 SB Off Ramp
5. SR 70 (53rd Ave E) at I-75 NB Off Ramp
6. SR 70 (53rd Ave E) at 87th St E / Ranch Lake Boulevard
7. SR 70 (53rd Ave E) at Braden River Run
8. SR 70 (53rd Ave E) at Forest Run Dr / River Club Boulevard
9. SR 70 (53rd Ave E) Lakewood Ranch Boulevard
10. US 301 (SR 683) / 15th St Boulevard at 51st Ave E

The Governing standards Specifications for this project shall be Division II and III, the Florida Department of Transportation (FDOT) Standard Specifications for Road and Bridge Construction, 2017 Edition and all Supplemental Specifications thereto, hereinafter referred to as the Standard Specifications for roadway construction, except as amended under this contract.

The Contractor's work shall follow the Manatee County Public Works Utility Standards and Specifications (July 2016) for any utility work.

All required MOT shall be provided by the Contractor and approved by Owner.

For the Standard Specifications for Road and Bridge Construction click on the "Specifications" link at the following web site:

<http://www.dot.state.fl.us/programmanagement/Specs.shtm>

The Successful Bidder shall furnish all Shop Drawings, work drawings, labor, materials, equipment, tools, services and incidentals necessary to complete all Work required by these Specifications.

The Successful Bidder shall perform the Work complete, in place and ready for continuous service and shall include any repairs, replacements, and / or restoration required as a result of damages caused prior to acceptance by the Owner.

The Successful Bidder shall furnish and install all materials, equipment and labor which is reasonably and properly inferable and necessary for the proper completion of the Work, whether specifically indicated in the Bid Documents or not.

B.02 COMPLETION OF WORK

The Work will be completed and ready for final inspection within the specified calendar days from the date the Contract Time commences to run. Only one (1) Work Schedule, based on **120 calendar days** shall be considered.

B.03 LIQUIDATED DAMAGES

If the successful bidder fails to achieve Substantial Completion of the Work within the Contract Time and as otherwise required by the Contract Documents, the Owner shall be entitled to retain or recover from the successful bidder, as liquidated damages and not as a penalty, **the sum of \$958.00 per calendar day**, commencing upon the first day following expiration of the Contract Time and continuing until the actual date of Substantial Completion. Such liquidated damages are hereby agreed to be a reasonable estimate of damages the Owner will incur as a result of delayed completion of the Work. The Owner may deduct liquidated damages as described in this paragraph from any unpaid amounts then or thereafter due the successful bidder under this Agreement. Any liquidated damages not so deducted from any unpaid amounts due the successful bidder shall be payable to the Owner at the demand of the Owner, together with interest from the date of the demand at the maximum allowable rate.

B.04 CONTRACT CONTINGENCY WORK

Contract contingency is a monetary allowance used solely at Owner's discretion to handle unexpected conditions as required to satisfactorily complete the Work in accordance with the IFB documents. A Field Directive must be issued by an authorized Owner representative to authorize use of contract contingency funds.

The percentage for contract contingency is listed on the Bid Form. Bidder shall enter the dollar amount for contract contingency based on the percentage of the total base bid. The total contract award will include contract contingency.

Appropriate uses of contract contingency include increases to existing bid item quantities that do not change the initial scope of Work, which may be directed by staff; modification items not originally bid which were unforeseen yet necessary during the Work to provide a safe, complete Project and that do not change the initial scope of Work; and unanticipated conflicts and/or design changes required during construction which are necessary to provide a safe, complete Project and that do not change the initial scope of Work.

Inappropriate uses of contract contingency include anything that changes the initial scope of Work, including the Contract Sum and Contract Time, and adding bid items not previously contemplated that change the initial scope of Work.

END OF SECTION B

SECTION C
BID SUMMARY

C.01 MINIMUM QUALIFICATIONS OF BIDDERS

No person who is not **Pre-Qualified with the Florida Department of Transportation** in the category of **Traffic Signal** in accordance with Florida Chapter 337.14 on the day the bid is submitted, and who has continuously held that **Qualification** for a period of at least three (3) consecutive years immediately prior to the day the bid is submitted, may be qualified to bid on this Work. In the event that a bidder is a business organization, including a partnership, corporation, business trust or other legal entity as set forth in Section 489.119(2), Florida Statutes, then the bidder shall only be qualified to bid on this Work if: 1) the bidder (the business organization) is on the day the bid is submitted, and for at least three (3) consecutive years immediately prior to the day the bid is submitted has been, in continuous existence, properly licensed and registered as required by Florida law; and 2) the bidder, on the day the bid is submitted, has a certified or registered Qualifying Agent, as required by Section 489.119, Florida Statutes, and that Qualifying Agent has been the same Qualifying Agent of the bidder for a period of at least three (3) consecutive years immediately prior to the day the bid is submitted.

A copy of the certification with the Florida Department of Transportation shall be included with the bid submittal.

C.02 BASIS OF AWARD

County may not make award to a bidder who is delinquent in payment of any taxes, fees, fines, contractual debts, judgments, or any other debts due and owed to the County, or is in default on any contractual or regulatory obligation to the County. By submitting this solicitation response, bidder attests that it is not delinquent in payment of any such debts due and owed to the County, nor is it in default on any contractual or regulatory obligation to the County. In the event the bidder's statement is discovered to be false, bidder will be subject to suspension and/or debarment and the County may terminate any award it has with bidder.

Award shall be to the lowest, responsive, responsible bidder meeting specifications and having the **lowest total offer** based on a 120 calendar day construction time period as set forth in this IFB. Bid prices shall include costs for furnishing all labor, equipment and/or materials for the completion of the Work in accordance with and in the manner set forth and described in the IFB documents to Owner's satisfaction within the prescribed time.

One (1) Work Schedule for completion of Work shall be considered. Bids received for completion by the specified stated time shall be offered as a "total offer".

NOTE: Inspection of the all site is a pre-requisite to be considered for award of this bid.

In evaluating bids, Owner shall consider the qualifications of the bidders; and if required, may also consider the qualifications of the Subcontractors, suppliers, and other persons and organizations proposed. Owner may also consider the operating costs, maintenance requirements, performance data and guarantees of major items of materials and equipment proposed for incorporation in the Work.

Whenever two or more bids are equal with respect to price, the bid received from a local business shall be given preference in award.

Whenever two or more bids are equal with respect to price, and all other evaluative factors are otherwise equal, including local preference policies, if the company provides documented environmentally preferable "green" products, materials, or supplies, they shall be given preference in award.

Whenever two or more bids which are equal with respect to price are received, and neither of these bids are from a local business, and neither of these bids provides documented "green" products, the award shall be determined by a chance drawing, coin toss, or similar tie-breaking method conducted by the Purchasing Division and open to the public.

END OF SECTION C

**SECTION D
IFB17-04130V**

**Intelligent Transportation Systems / Advanced Traffic Management System (ATMS)
SR 70 Adaptive Signal Control Project / (Project #6084261 6.2)
Financial Project ID (Federal Funds) 438870-1-58-01)
INSURANCE AND BONDING REQUIREMENTS**

The successful bidder will not commence Work under the resulting Agreement until all insurance under this section, and such insurance coverage as might be required by Owner, has been obtained. The successful bidder shall obtain, and submit to the Procurement Division within ten (10) calendar days from the date of notice of intent to award, at his expense, the following minimum amounts of insurance (inclusive of any amounts provided by an umbrella or excess policy):

Insurance / Bond Type	Required Limits
1. <input checked="" type="checkbox"/> Automobile Liability:	Bodily Injury and Property Damage, Owned/Non-Owned/Hired; Automobile included \$ <u>1,000,000</u> combined single limit or \$500,000 Bodily Injury and \$500,000 Property Damage, each occurrence <i>This policy shall contain severability of interests' provisions.</i>
2. <input checked="" type="checkbox"/> Commercial General Liability: (Occurrence Form - patterned after the current ISO form)	Bodily Injury and Property Damage \$ <u>2,000,000</u> single limit per occurrence; \$ <u>4,000,000</u> aggregate This shall include Premises and Operations; Independent Contractors; Products and Completed Operations and Contractual Liability. <i>This policy shall contain severability of interests' provisions.</i>
3. <input checked="" type="checkbox"/> Employer's Liability:	\$ <u>100,000</u> single limit per occurrence
4. <input checked="" type="checkbox"/> Worker's Compensation:	Statutory Limits of Chapter 440, Florida Statutes, and all Federal Government Statutory Limits & Requirements
5. <input checked="" type="checkbox"/> Other Insurance, as noted:	a. <input type="checkbox"/> Aircraft Liability \$ _____ per occurrence Coverage shall be carried in limits of not less than \$5,000,000 each occurrence if applicable to the completion of the services under this Agreement. b. <input checked="" type="checkbox"/> Installation Floater \$ <u>214,000.00</u> or the value of the project, whichever is greater. If the resulting Agreement does not include construction of or additions to above ground building or structures, but does involve the installation of machinery or equipment, successful bidder shall provide an " Installation Floater " with the minimum amount of insurance to be 100% of the value of such addition(s), building(s), or structure(s).

Insurance / Bond Type	Required Limits
	<p>c. <input type="checkbox"/> Maritime Coverage (Jones Act) \$ _____ per occurrence</p> <p>Coverage shall be maintained where applicable to the completion of the Work.</p>
	<p>d. <input type="checkbox"/> Pollution \$ _____ per occurrence</p> <p>e. <input type="checkbox"/> Professional Liability \$ _____ per claim and in the aggregate</p> <ul style="list-style-type: none"> • \$1,000,000 per claim and in the aggregate • \$2,000,000 per claim and in the aggregate <p>f. <input type="checkbox"/> Project Professional Liability \$ _____ per occurrence</p> <p>g. <input type="checkbox"/> Property Insurance \$ _____</p> <p>If the resulting Agreement includes construction of or additions to above ground buildings or structures, bidder shall provide “Builder’s Risk” insurance with the minimum amount of insurance to be 100% of the value of such addition(s), building(s), or structure(s).</p> <p><i>To the extent that property damage is covered by commercial insurance, Owner and successful bidder agree to waive all subrogation rights against each other, except such rights as they may have to the proceeds of such insurance. Successful bidder shall require a similar waiver of subrogation from each of its bidder personnel and sub-consultants, to include Special Consultants; successful bidder shall provide satisfactory written confirmation to Owner of these additional waivers.</i></p> <p>h. <input type="checkbox"/> U.S. Longshoreman’s and Harborworker’s Act Coverage shall be maintained where applicable to the completion of the Work.</p> <p>i. <input type="checkbox"/> Valuable Papers Insurance \$ _____ per occurrence</p> <p>j. <input type="checkbox"/> Watercraft \$ _____ per occurrence</p>
<p>6. <input checked="" type="checkbox"/> Bid Bond:</p>	<p>Bid bond shall be 5% of the total offer of the bid. Bid bond shall be submitted with the bid and shall include project name, location, and / or address and project number.</p> <p>In lieu of the bond, the contractor may file an alternative form of security in the amount of 5% of the total offer, in the form of a money order, a certified check, a cashier’s check, or an</p>

Insurance / Bond Type	Required Limits
	irrevocable letter of credit.
7. <input checked="" type="checkbox"/> Payment and Performance Bond:	Payment and Performance Bond shall be submitted by bidder for 100% of the award amount and shall be presented to Manatee County within ten (10) calendar days of issuance of the notice of intent to award.

Reviewed by Risk: 

INSURANCE REQUIREMENTS

The amounts and types of insurance coverage shall conform to the minimum requirements set forth in this Exhibit, with the use of Insurance Services Office (ISO) forms and endorsements or their equivalents. If successful bidder has any self-insured retentions or deductibles under any of the listed minimum required coverage, successful bidder must identify on the certificate of insurance the nature and amount of such self-insured retentions or deductibles and provide satisfactory evidence of financial responsibility for such obligations. All self-insured retentions or deductibles will be successful bidder's sole responsibility.

Nothing herein shall in any manner create any liability of Owner in connection with any claim against the successful bidder for labor, services, or materials, or of Subcontractors; and nothing herein shall limit the liability of the successful bidder or successful bidder's sureties to Owner or to any workers, suppliers, material men or employees in relation to the resulting Agreement.

Builder's Risk Coverage. The successful bidder shall procure and maintain during the entire course of the Work a builder's risk policy, completed value form, insured to provide coverage on an all risk basis, including coverage for off-site stored materials and including coverage for theft. This coverage shall not be lapsed or cancelled because of partial Acceptance by the Owner prior to final Acceptance of the Project. Successful bidder shall recommend to Owner any additions to the Project Costs resulting from any casualty described in Article XII General Conditions of the Construction Agreement, including those costs, expenses and other charges (including normal and ordinary compensation to the successful bidder) necessary for reconstruction of the Project substantially in accordance with the Project Plans and Specifications. The nature, level and type of builder's risk coverage (including completed value or replacement cost coverage) shall be determined by Owner through insurers selected by successful bidder and approved by Owner.

Excess Policy or Umbrella. An excess policy or umbrella may be used to cover limits over and above Commercial General Liability.

Subcontractor's Public Liability and Property Damage Insurance. The successful bidder shall require each Subcontractor to procure and maintain during the term of the subcontract, insurance of the type specified above, or insure the activities of Subcontractors in its policy, as approved by Owner prior to performance of any services. The levels of coverage as set forth in the table above may be adjusted to require a reduced level of coverage consistent with the scope of Work to be provided by that particular Subcontractor. Any reduction in the levels of insurance coverage required by the successful bidder's standard form of subcontract shall be approved by the Owner.

Waiver of Subrogation. Owner and successful bidder waive against each other and the Owner's separate Vendors, Contractors, Design Consultants, Subcontractors agents and employees of each and all of them, all damages covered by property insurance provided herein, except such rights as they may have to the proceeds of such insurance.

The successful bidder and Owner shall, where appropriate, require similar waivers of subrogation from the Owner's separate Vendors, Design Consultants and Subcontractors and shall require each of them to include similar waivers in their contracts.

Worker's Compensation Insurance. The successful bidder shall procure and maintain during the term of the Contract Documents, workers' compensation insurance for all its employees connected with the Work and shall require all Subcontractors similarly to provide workers' compensation insurance for all their employees unless such employees are covered by the protection afforded by successful bidder. Such insurance shall comply with the Florida Workers' Compensation Law. The successful bidder shall provide adequate insurance, satisfactory to Owner, for the protection of employees not otherwise protected.

By way of its submission of a bid hereto, bidder:

- a. Represents that bidder maintains, and will maintain during the term of any Agreement arising from this solicitation, all insurance coverage required herein from responsible companies duly authorized to do business under the laws of the State of Florida that hold a rating of "A-" or better by Best's Key Guide, latest edition, and are deemed acceptable to Owner as set forth in this solicitation.
- b. Agrees that insurance, as specified herein, shall remain in force and effect without interruption from the date of commencement of the Work throughout the duration of the Project, and shall remain in effect for at least two (2) years after the termination of the Contract Documents.
- c. Agrees that if the initial or any subsequently issued certificate of insurance expires prior to completion of the Work, successful bidder shall furnish to Owner renewal or replacement certificate(s) of insurance no later than ten (10) calendar days after the expiration date on the certificate. Failure of successful bidder to provide Owner with such renewal certificate(s) shall be considered justification for Owner to terminate any and all Agreements.
- d. Agrees that bidder and/or its insurance carrier shall provide thirty (30) days written notice to Owner of policy cancellation or non-renewal on the part of the insurance carrier or the successful bidder. Successful bidder shall also notify Owner, in a like manner, within twenty-four (24) hours after receipt, of any notices of expiration, cancellation, non-renewal or material change in coverage or limits received by successful bidder from its insurer and nothing contained herein shall relieve successful bidder of this requirement to provide notice. In the event of a reduction in the aggregate limit of any policy to be provided by successful bidder hereunder, successful bidder shall immediately take steps to have the aggregate limit reinstated to the full extent permitted under such policy.
- e. Agrees that failure of successful bidder to obtain and maintain proper amounts of insurance at all times as called for herein shall constitute a material breach of the resulting Agreement, which may result in immediate termination.
- f. Agrees that, should at any time the successful bidder not maintain the insurance coverage(s) required herein, Owner may terminate the Agreement or at its sole discretion shall be authorized to purchase such coverage(s) and charge successful bidder for such coverage(s) purchased. If successful bidder fails to reimburse Owner for such costs within thirty (30) days after demand, Owner has the right to offset these costs from any amount

due successful bidder under this Agreement or any other agreement between Owner and successful bidder. Owner shall be under no obligation to purchase such insurance, nor shall it be responsible for the coverage(s) purchased or the insurance companies used. The decision of Owner to purchase such insurance coverage(s) shall in no way be construed to be a waiver of any of its rights under the Contract Documents.

- g. Agrees to provide, upon request, the entire and complete insurance policies required herein.
- h. The payment of deductibles for insurance required of the successful bidder by the Contract Documents shall be the sole responsibility of the successful bidder.

Certificate of Insurance Requirements:

- a. Certificates of insurance in duplicate evidencing the insurance coverage specified herein shall be filed with the Procurement Division before operations are begun. The required certificates of insurance shall name the types of policy, policy number, date of expiration, amount of coverage, companies affording coverage, and also shall refer specifically to the bid number and title of the Project, and must read: For any and all work performed on behalf of Manatee County.
- b. **Additional Insured:** The Automobile Liability and Commercial General Liability policies provided by the successful bidder to meet the requirements of this IFB shall name Manatee County, Board of County Commissioners, as an additional insured as to the operations of the successful bidder under this IFB and shall contain severability of interests provisions.
- c. In order for the certificate of insurance to be accepted it **must** comply with the following:
 - 1. The "Certificate Holder" shall be:
**Manatee County
Board of County Commissioners
Bradenton, FL
IFB17-0413OV, Intelligent Transportation Systems
Aerial Traffic Management System (ATMS) / SR 70 Adaptive
Signal Control Project, (Project #6084261 6.2)
Financial Project ID (Federal Funds) 438870-1-58-01
For any and all work performed on behalf of Manatee County.**

**Additional "Certificate Holder" shall be:
Florida Department of Transportation.**

- 2. Certificate shall be mailed to:
**Manatee County Procurement Division
1112 Manatee Avenue West, Suite 803
Bradenton, FL 34205
Attn: Olga Valcich, CPPB, Contract Specialist**

BONDING REQUIREMENTS

Bid Bond/Certified Check. By submitting a bid to this IFB, the bidder agrees should the bidder's bid be accepted, **to execute the form of Agreement and present the same to Manatee County for approval within ten (10) calendar days after notice of intent to award.** The bidder further agrees that failure to execute and deliver said form of Agreement **within ten (10) calendar days** will result in damages to Manatee County and as guarantee of

payment of same a bid bond/certified check shall be enclosed within the submitted sealed bid in the amount of five (5%) percent of the total amount of the bid.

The bidder further agrees that in case the bidder fails to enter into an Agreement, as prescribed by Manatee County, the bid bond/certified check accompanying the bid shall be forfeited to Manatee County as agreed liquidated damages. If Owner enters into an Agreement with a bidder, or if Owner rejects any and/or all bids, accompanying bond will be promptly returned.

Payment and Performance Bonds. Prior to commencing Work, the successful bidder shall obtain, for the benefit of and directed to Owner, a Payment and Performance Bond satisfying the requirements of Section 255.05, Florida Statutes, covering the faithful performance by the successful bidder of its obligation under the Contract Documents, including but not limited to the construction of the Project on the Project Site and the payment and obligations arising thereunder, including all payments to Subcontractors, laborers, and materialmen. The surety selected by the successful bidder to provide the Payment and Performance Bond shall be approved by Owner prior to issuance of such Bond, which approval shall not be unreasonably withheld or delayed provided that surety is rated A- or better by Best's Key Guide, latest edition.

Failure to provide the required bonds on the prescribed form may result in successful bidder being deemed nonresponsive. Bonds must be in the form prescribed in Section 255.05, Florida Statutes, and must not contain notice, demand or other terms and conditions, including informal pre-claim meetings, not provided for in Section 255.05, Florida Statutes.

Surety of such bonds shall be in an amount equal to 100% of the Contract Price issued by a duly authorized and nationally recognized surety company, authorized to do business in the State of Florida, satisfactory to Owner. **Surety shall be rated as "A-" or better by Best's Key Guide, latest edition.** The attorney-in-fact who signs the bonds must file with the bonds, a certificate and effective dated copy of power-of-attorney. Payment and Performance Bonds shall be issued to Manatee County, a political subdivision of the State of Florida, **within ten (10) calendar days after notice of intent to award.**

In addition, pursuant to Section 255.05(1)(b), Florida Statutes, prior to commencing Work, the successful bidder shall be responsible and bear all costs associated to record the Payment and Performance Bond with the Manatee County Clerk of the Circuit Court. A certified copy of said recording shall be furnished to the Procurement Division upon filing. Pursuant to Section 255.05(1)(b), Florida Statutes, Owner will make no payment to the successful bidder until the successful bidder has complied with this paragraph.

Furnishing Payment and Performance Bonds shall be requisite to execution of an Agreement with Owner. Said Payment and Performance Bonds will remain in force for the duration of the Agreement with the premiums paid by the successful bidder. Failure of the successful bidder to execute such Agreement and to supply the required bonds shall be just cause for cancellation of the award. Owner may then contract with the next lowest, responsive and responsible bidder or re-advertise this IFB. If another bidder is accepted, and notice given within ninety (90) days after the opening of the bids, this Acceptance shall bind the bidder as though they were originally the successful bidder.

Failure of Owner at any time to require performance by the successful bidder of any provisions set out in the resulting Agreement will in no way affect the right of Owner, thereafter, to enforce those provisions.

BIDDER'S INSURANCE STATEMENT

THE UNDERSIGNED hereto have read and understand the aforementioned insurance requirements of this IFB and note that the evidence of insurability shall be required within ten (10) days from the date of notice of intent to award.

Bidder Name: _____ Date: _____

Bidder's Signature: _____

Print Name: _____

Insurance Agency: _____

Agent Name: _____ Agent Phone: _____

Please return this completed and signed statement with your bid.

BID FORM

**For: IFB17-0413OV
Intelligent Transportation Systems
Advanced Traffic Management System (ATMS)
SR 70 Adaptive Signal Control Project
Financial Project ID (Federal Funds) 438870-1-58-01**

Total Offer: \$ _____
Based on a completion time of <u>120</u> calendar days

We, the undersigned, hereby declare that we have carefully reviewed the IFB Documents in their entirety and with full knowledge and understanding of the aforementioned herewith submit this bid, completely meeting each and every specification, term, and condition contained therein.

One schedule for completion of the Work shall be considered. The bid for completion by the specified stated time shall be offered as a "total offer". Only one (1) award shall be made.

As bidder, we understand that the IFB documents, in its entirety, including but not limited to, all specifications, terms, and conditions shall be made a part of any resulting Agreement between Manatee County and the successful bidder. Failure to comply shall result in Agreement default, whereupon, the defaulting successful bidder shall be required to pay for any and all re-procurement costs, damages, and attorney fees as incurred by County, and agrees to forfeit his/her bid bond.

Communications concerning this bid shall be addressed as follows: **(Complete all fields)**

Bidder's Name: _____

Mailing Address: _____

Telephone: () _____ Fax: () _____

Email Address: _____

A bid bond, certified check, or cashier's check in the amount of 5% of the total bid offer is attached herein.

I, _____ on [date(s)] _____ attest that I have visited the project site(s) to familiarize myself with the full scope of work required for the bid.

Acknowledge Addendum No. _____ Dated: _____	Acknowledge Addendum No. _____ Dated: _____
Acknowledge Addendum No. _____ Dated: _____	Acknowledge Addendum No. _____ Dated: _____
Acknowledge Addendum No. _____ Dated: _____	Acknowledge Addendum No. _____ Dated: _____

Authorized Signature(s): _____

Name and Title of Above Signer(s): _____

Date: _____

BID FORM
(Submit in Duplicate)
IFB17-04130V

IFB 17-04130V

Intelligent Transportation Systems , Advanced Traffic Management System (ATMS)
SR 70 Adaptive Signal Control Project (Project 6084261 6.2)
Financial Project ID (Federal Funds) 438870-1-58-01
BID Based on Completion Time of 120 Calendar Days

ITEM #	FDOT ITEM	DESCRIPTION	QTY	U/M	BID PRICE PER UNIT	TOTAL BID PRICE
1	101-1	MOBILIZATION	1	LS	\$	\$
2	102-1	MAINTENANCE OF TRAFFIC	1	LS	\$	\$
3	522-1	CONCRETE SIDEWALK AND DRIVEWAYS, 4" THICK	135	SY	\$	\$
4	630-2-11	CONDUIT, F & I OPEN TRENCH	360	LF	\$	\$
5	630-2-12	CONDUIT, F & I DIRECTIONAL BORE	1020	LF	\$	\$
6	630-2-14	CONDUIT, F & I ABOVEGROUND	30	LF	\$	\$
7	633-8-1	MULTI-CONDUCTOR COMMUNICATION CABLE, FURNISH, ETHERNET	6,747	LF	\$	\$
8	633-8-6	MULTI-CONDUCTOR COMMUNICATION CABLE, REMOVE	750	LF	\$	\$
9	635-2-11	PULL & SPLICE BOX, F & I, 17" x 30" x 12"	18	EA	\$	\$
10	660-4-31	VEHICLE DETECTION SYSTEM, VIDEO INSTALL, CABINET EQUIPMENT	10	EA	\$	\$

Bidder: _____

Authorized
Signature: _____

00300-2
SR 70 Adaptive Signal Control Project
Based on 120 Cal. Day Completion
IFB17-04130V

BID FORM
 (Submit in Duplicate)
 IFB17-04130V

Intelligent Transportation Systems , Advanced Traffic Management System (ATMS)
SR 70 Adaptive Signal Control Project (Project 6084261 6.2)
Financial Project ID (Federal Funds) 438870-1-58-01
BID Based on Completion Time of 120 Calendar Days

ITEM #	FDOT ITEM	DESCRIPTION	QTY	U/M	BID PRICE PER UNIT	TOTAL BID PRICE
11	660-4-32	VEHICLE DETECTION SYSTEM, VIDEO INSTALL, ABOVE GROUND EQUIPMENT MOUNTING HARDWARE FURNISH BY CONTRACTOR, CAMERA INSTALLATION BY CONTRACTOR	38	EA	\$	\$
12	660-4-42	VEHICLE DETECTIN SYSTEM, VIDEO RELOCATE ABOVE CABINET EQUIPMENT	2	EA	\$	\$
13	660-4-60	VEHICLE DETECTION SYSTEM, VIDEO REMOVE	16	EA	\$	\$
14	660-6-121	VEHICLE DETECTION SYSTEM-AVI, BLUETOOTH, F & I, CABINET EQUIPMENT	3	EA	\$	\$
15	660-6-122	VEHICLE DETECTION SYSTEM-AVI, BLUETOOTH, F & I, ABOVE GROUND EQUIPMENT	3	EA	\$	\$
		TOTAL BASE BID BASED ON A COMPLETION TIME OF 120 CALENDAR DAYS				\$
		CONTRACT CONTINGENCY (10% OF TOTAL BASE BID (Used only with County Approval)				\$
		TOTAL CONTRACT AWARD WITH 10% CONTRACT CONTINGENCY				\$

Bidder: _____

Authorized Signature: _____

00300-3
 SR 70 Adaptive Signal Control Project
 Based on 120 Cal. Day Completion
 IFB17-04130V

BID FORM
 (Submit in Duplicate)
 IFB 17-04130V

Intelligent Transportation Systems, Advanced Traffic Management System (ATMS)
SR 70 Adaptive Signal Control Project

Financial Project ID (Federal Funds) 438870-1-58-01
BID Based on Completion Time of 120 Calendar Days

ITEM #	FDOT ITEM	DESCRIPTION	%	DBE/WBE	DESCRIPTION OF WORK BY SUBCONTRACTOR
1	101-1	MOBILIZATION			
2	102-1	MAINTENANCE OF TRAFFIC			
3	522-1	CONCRETE SIDEWALK AND DRIVEWAYS, 4" THICK			
4	630-2-11	CONDUIT, F & I OPEN TRENCH			
5	630-2-12	CONDUIT, F & I DIRECTIONAL BORE			
6	630-2-14	CONDUIT, F & I ABOVEGROUND			
7	633-8-1	MULTI-CONDUCTOR COMMUNICATION CABLE, FURNISH, ETHERNET			
8	633-8-6	MULTI-CONDUCTOR COMMUNICATION CABLE, REMOVE			
9	635-2-11	PULL & SPLICE BOX, F & I, 17" x 30" x 12"			
10	660-4-31	VEHICLE DETECTION SYSTEM, VIDEO INSTALL, CABINET EQUIPMENT			

Bidder: _____

Authorized Signature: _____

00300-4
 SR 70 Adaptive Signal Control Project
 Based on 120 Cal. Day Completion
 %Of Subcontractor
 IFB17-04130V

BID FORM
 (Submit in Duplicate)
 IFB 17-04130V
Intelligent Transportation Systems, Advanced Traffic Management System (ATMS)
SR 70 Adaptive Signal Control Project
Financial Project ID (Federal Funds) 438870-1-58-01

FDOT		DESCRIPTION OF WORK BY	
ITEM #	ITEM	DESCRIPTION	SUBCONTRACTOR
		%	DBE/WBE
11	660-4-32	VEHICLE DETECTION SYSTEM, VIDEO INSTALL, ABOVE GROUND EQUIPMENT MOUNTING HARDWARE FURNISH BY CONTRACTOR, CAMERA INSTALLED BY CONTRACTOR	
12	660-4-42	VEHICLE DETECTION SYSTEM, VIDEO RELOCATE ABOVE CABINET EQUIPMENT	
13	660-4-60	VEHICLE DETECTION SYSTEM, VIDEO REMOVE	
14	660-6-121	VEHICLE DETECTION SYSTEM-AVI, BLUETOOTH, F & I CABINET EQUIPMENT	
15	660-6-122	VEHICLE DETECTIN SYSTEM-AVI, BLUETOOTH F & I, ABOVE GROUND EQUIPMENT	

THIS IS A DUPLICATION OF THE BID ITEMS WHERE THE BIDDER SHALL STATE THE PERCENT OF WORK (OF EACH ITEM LISTED) AND A DESCRIPTION OF THE WORK WHICH SHALL BE PERFORMED BY A SUBCONTRACTOR

Bidder: _____
 Authorized Signature: _____

00300-5
 SR 70 Adaptive Signal Control Project
 Based on 120 Cal. Day Completion
 %Of Subcontractor
 IFB17-04130V

MAILING LABEL

Cut along the outside border and affix this label to your sealed bid envelope to identify it as a "Sealed Bid". Be sure to include the name of the company submitting the bid and the bid due date and time where requested.

MAILING LABEL TO AFFIX TO OUTSIDE OF SEALED BID PACKAGE:

BIDDER: _____

INVITATION FOR BID No.: IFB17-0413OV

BID TITLE: Intelligent Transportation Systems

**Advanced Traffic Management System (ATMS) / SR 70 Adaptive
Signal Control Project (Project No. 6084261 6.2)**

Financial Project ID (Federal Funds) 438870-1-58-01)

**Bid Location: Manatee County Administration Building,
1112 Manatee Avenue West, Suite 803, Bradenton, FL 34205
(Project No. 6084261 6.2)**

DUE DATE/TIME:

**MANATEE COUNTY
PUBLIC WORKS DEPARTMENT**

CONTRACT PLANS

(FEDERAL FUNDS)
MANATEE COUNTY (13160)

STATE ROAD NO. 70

FINANCIAL PROJECT ID: 438870-1-58-01

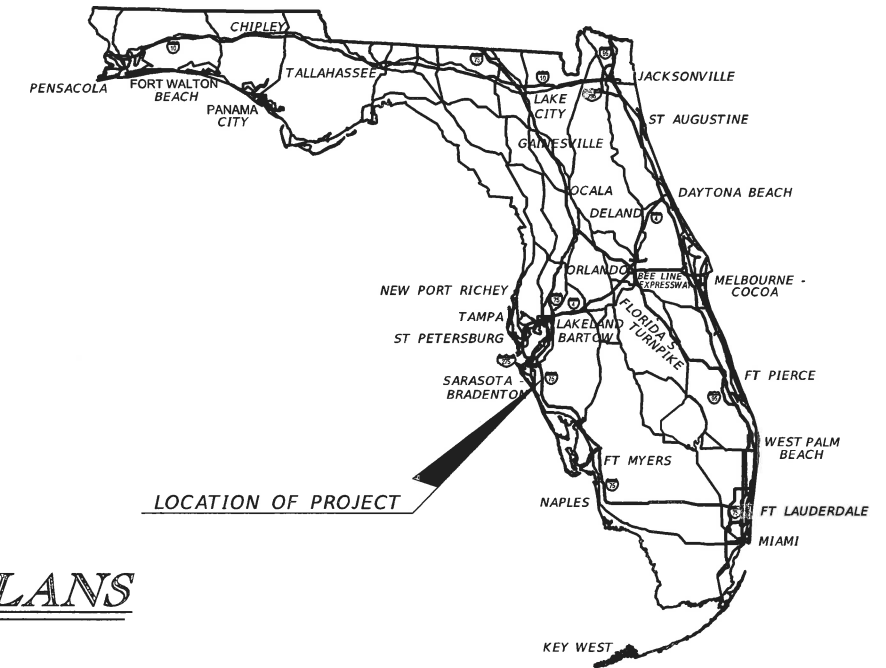

INDEX OF ITS PLANS

SHEET NO.	SHEET DESCRIPTION
IT-1	KEY SHEET
IT-1A	SUMMARY OF QUANTITIES
IT-2	TABULATION OF QUANTITIES
IT-3 - IT-4	GENERAL NOTES
IT-5 - IT-6	PROJECT LAYOUT
IT-7 TO IT-16	PLAN SHEETS
IT-17	ASC MAST ARM DETAIL
IT-18	ASC SPAN WIRE DETAIL
IT-19	DIRECTIONAL BORE AND TRENCHING DETAIL
IT-20	ITS PULL BOX AND CONDUIT DETAIL

INTELLIGENT TRANSPORTATION SYSTEMS PLANS

THIS DOCUMENT HAS BEEN DIGITALLY SIGNED & SEALED BY:

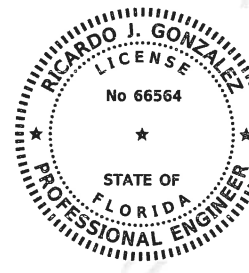

Digitally signed by Ricardo J Gonzalez
DN: c=US, o=IdenTrust ACES Business Representative, ou=METRIC ENGINEERING INC., cn=Ricardo J Gonzalez,
0.9.2342.19200300.100.1.1=A01097C0000013FD44ED95E000035C8
Date: 2016.10.21 14:59:25 -04'00'
Adobe Acrobat version: 11.0.17

PRINTED COPIES OF THIS DOCUMENT ARE NOT CONSIDERED SIGNED AND SEALED. THE SIGNATURE MUST BE VERIFIED ON THE ELECTRONIC DOCUMENTS.

METRIC ENGINEERING, INC.
615 CRESCENT EXECUTIVE CT
SUITE 524
LAKE MARY, FLORIDA 32746
TEL. (407) 644-1898
FAX. (407) 644-2376
CERTIFICATE OF AUTHORIZATION 2294

THE ABOVE NAMED PROFESSIONAL ENGINEER SHALL BE RESPONSIBLE FOR ALL SHEETS IN ACCORDANCE WITH RULE 61G15-23.004, F.A.C.

BEGIN PROJECT (WEST SEGMENT) STA. 125+80

BEGIN PROJECT (EAST SEGMENT) STA. 470+00

T345
T355

T355
T365

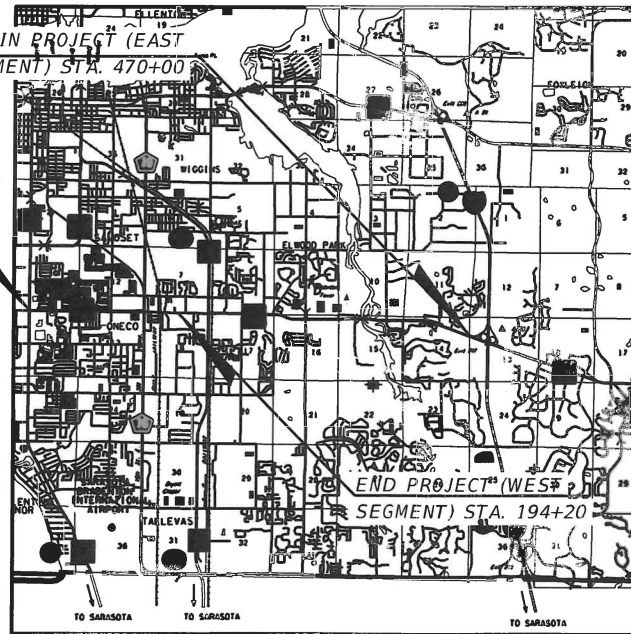

END PROJECT (EAST SEGMENT) STA. 587+60

INTELLIGENT TRANSPORTATION SYSTEMS PLANS SHOP DRAWINGS TO BE SUBMITTED TO:

RICARDO J. GONZALEZ, P.E.
METRIC ENGINEERING, INC.
615 CRESCENT EXECUTIVE CT, SUITE 524
LAKE MARY, FL 32746

PLANS PREPARED BY:

METRIC ENGINEERING, INC.
615 CRESCENT EXECUTIVE CT, SUITE 524
LAKE MARY, FLORIDA 32746
TEL. (407) 644-1898
FAX. (407) 644-2376
FLORIDA CERT. NO. EB-0002294
VENDOR NO. F-59-1685550
CONTRACT NO. C-8T94

NOTE: THE SCALE OF THESE PLANS MAY HAVE CHANGED DUE TO REPRODUCTION.

GOVERNING STANDARDS AND SPECIFICATIONS:

Florida Department of Transportation, 2016 Design Standards and revised Index Drawings as appended herein, and January 2016 Standard Specifications for Road and Bridge Construction, as amended by Contract Documents.

For Design Standards click on the "Design Standards" link at the following web site:
<http://www.dot.state.fl.us/rddesign/DesignStandards>

For the Standard Specifications for Road and Bridge Construction click on the "Standard Specifications Library" link at the following web site:
<http://www.dot.state.fl.us/programmanagement/Specs.shtm>

KEY SHEET REVISIONS	
DATE	DESCRIPTION

INTELLIGENT TRANSPORTATION SYSTEMS PLANS
ENGINEER OF RECORD: **RICARDO J. GONZALEZ, P.E.**

P.E. NO.: 66564

FISCAL YEAR	SHEET NO.
16	IT-1

MANATEE COUNTY PROJECT MANAGER: **VISHAL S. KAKKAD, P.E.**

THE OFFICIAL RECORD OF THIS SHEET IS THE ELECTRONIC FILE DIGITALLY SIGNED AND SEALED UNDER RULE 61G15-23.004, F.A.C.

SUMMARY OF LUMP SUM ITEMS					
PAY ITEM NO.	PAY ITEM DESCRIPTION	QUANTITY		DESIGN NOTES	CONSTRUCTION REMARKS
		PLAN	FINAL		
101-1	MOBILIZATION	1			
102-1	MAINTENANCE OF TRAFFIC	1			

SUMMARY OF TEMPORARY SIGNALIZATION & DETECTION													
PHASE	DURATION	102-104 TEMPORARY SIGNALIZATION & MAINTENANCE OF INTERSECTION, EACH DAY						102-107-1 TEMPORARY TRAFFIC DETECTION & MAINTENANCE OF INTERSECTION, EACH DAY					
		EXISTING			TEMPORARY			EXISTING			TEMPORARY/NEW		
	DAYS	#	PLAN	FINAL	#	PLAN	FINAL	#	PLAN	FINAL	#	PLAN	FINAL
1	120	10	1200					10	1200				
SUB-TOTAL:			1200						1200				
TOTAL:						1200						1200	

NO.	REVISIONS	DATE	BY	SCALE AS NOTED	RICARDO J. GONZALEZ, P.E. P.E. NO.: 66564 METRIC ENGINEERING, INC. 615 CRESCENT EXECUTIVE CT, SUITE 524 LAKE MARY, FLORIDA 32746 TEL. (407) 644-1898 FAX. (407) 644-2376 CERTIFICATE OF AUTHORIZATION: 2294	DATE 04-01-2016 PROJECT NO. 438870-1-58-01	 MANATEE COUNTY PUBLIC WORKS	DESIGN ENGINEER RICARDO GONZALEZ FL. LICENSE NO. 66564	SUMMARY OF QUANTITIES	SHEET NO. IT-1A
-----	-----------	------	----	-------------------	--	---	---	---	------------------------------	--------------------

THE OFFICIAL RECORD OF THIS SHEET IS THE ELECTRONIC FILE DIGITALLY SIGNED AND SEALED UNDER RULE 61G15-23.004, F.A.C.

PAY ITEM NO.	DESCRIPTION	UNIT	SHEET NUMBERS																								GRAND TOTAL		REF. SHEET
			IT-7		IT-8		IT-9		IT-10		IT-11		IT-12		IT-13		IT-14		IT-15		IT-16		SHEET						
			PLAN	FINAL	PLAN	FINAL	PLAN	FINAL	PLAN	FINAL	PLAN	FINAL	PLAN	FINAL	PLAN	FINAL	PLAN	FINAL	PLAN	FINAL	PLAN	FINAL	PLAN	FINAL	PLAN	FINAL			
522-1	CONCRETE SIDEWALK AND DRIVEWAYS, 4" THICK	SY													55		60		20								135		
630-2-11	CONDUIT,F&I OPEN TRENCH	LF	42						117				92		19		25		49							16		360	
630-2-12	CONDUIT,F&I,DIRECTIONAL BORE	LF											153		363		182		322									1020	
630-2-14	CONDUIT,F&I,ABOVEGROUND	LF																								30		30	
633-8-1	MULTI-CONDUCTOR COMMUNICATION CABLE, F & I, ETHERNET	LF	303		360		108		890		830		1240		866		976		118		1056						6747		
633-8-6	MULTI-CONDUCTOR COMMUNICATION CABLE, REMOVE	LF	205		335		100											110									750		
635-2-11	PULL & SPLICE BOX, F&I, 17" x 30" X 12"	EA							4		3		4		3		4										18		
660-4-31	VEHICLE DETECTION SYSTEM,VIDEO, FURNISH HARDWARE, INSTALL CABINET EQUIPMENT	EA	1		1		1		1		1		1		1		1		1		1		1		1		10		
660-4-32	VEHICLE DETECTION SYSTEM,VIDEO, FURNISH HARDWARE, INSTALL ABOVE GROUND EQUIPMENT	EA	3		4		4		4		3		4		4		4		4		4		4		4		38		
660-4-42	VEHICLE DETECTION SYSTEM,VIDEO, RELOCATE ABOVE GROUND EQUIPMENT	EA																									2		
660-4-60	VEHICLE DETECTION SYSTEM,VIDEO, REMOVE	EA	3		4		4		1										4								16		
660-6-121	VEHICLE DETECTION SYSTEM-AVI, BLUETOOTH, F & I, CABINET EQUIPMENT	EA	1														1								1		3		
660-6-122	VEHICLE DETECTION SYSTEM-AVI, BLUETOOTH, F & I, ABOVE GROUND EQUIPMENT	EA	1														1								1		3		

PAY ITEM NOTES:

- PAY ITEM 102-1, 102-104, AND 102-107-1 SHALL INCLUDE ALL ITEMS USED FOR TEMPORARY TRAFFIC CONTROL.
- PAY ITEM 630-2-14 SHALL INCLUDE A WEATHERHEAD TO BE FURNISHED AND INSTALLED AT THE TOP OF THE RISER.
- PAY ITEM 633-8-1 INCLUDES FURNISHING OF CAT-5E CABLE ENVIRONMENTALLY HARDENED, SHIELDED, AND OUTDOOR RATED AS WELL AS #14 AWG 3-CONDUCTOR INSIDE CABLE. THIS PAY ITEM SHALL INCLUDE THE FURNISH AND INSTALL OF AN ETHERNET REPEATER FOR PROPOSED COMMUNICATION CABLE RUNS GREATER THAN 320' AS REQUIRED PER PLANS.
- PAY ITEM 660-4-31: INCLUDES COMPLETE INSTALLATION OF VIDEO PROCESORS TO BE FURNISHING BY FDOT FOR ALL V.D.C. TO BE INSTALLED AT THE INTERSECTION SUPPLEMENTAL INTERFACE HARDWARE, CABLING, AND OTHER COMPONENTS ARE INCIDENTAL TO VIDEO PROCESSOR.
- PAY ITEM 660-4-32: INCLUDES FURNISHING OF CAMERA MOUNTING HARDWARE, CABLING, AND COMPLETE INSTALLATION OF THE CAMERA TO BE FURNISHING BY FDOT.
- PAY ITEM 660-4-60: INCLUDES COMPLETE REMOVAL OF VIDEO PROCESSORS LOCATED IN THE TRAFFIC CABINET.
- PAY ITEM 660-6-121/122 INCLUDES FURNISHING AND COMPLETE INSTALLATION OF A BLUETOOTH READER POWERED OVER ETHERNET (POE) UNIT CAPABLE OF EXPORTING RAW TRAVEL TIME COLLECTION DATA IN CSV FORMAT. THESE PAY ITEMS SHALL ALSO INCLUDE FURNISHING AND COMPLETE INSTALLATION OF ALL NECESSARY HARDWARE TO MOUNT THE BLUETOOTH UNIT AND THE CONNECTION TO A SPARE PORT AT THE EXISTING ETHERNET SWITCH LOCATED IN EACH TRAFFIC CABINET. BLUETOOTH READERS HAVE TO BE COMPATIBLE WITH THE EXISTING MANATEE COUNTY'S SYSTEM AND STANDARDS.

SCALE AS NOTED		RICARDO J. GONZALEZ, P.E. P.E. NO.: 66564 METRIC ENGINEERING, INC. 615 CRESCENT EXECUTIVE CT, SUITE 524 LAKE MARY, FLORIDA 32746 TEL. (407) 644-1898 FAX. (407) 644-2376 CERTIFICATE OF AUTHORIZATION: 2294		DATE 04-01-2016	 MANATEE COUNTY PUBLIC WORKS	DESIGN ENGINEER RICARDO GONZALEZ	TABULATION OF QUANTITIES	SHEET NO. IT-2
NO.	REVISIONS	DATE	BY	PROJECT NO. 438870-1-58-01		FL. LICENSE NO. 66564		

THE OFFICIAL RECORD OF THIS SHEET IS THE ELECTRONIC FILE DIGITALLY SIGNED AND SEALED UNDER RULE 61G15-23.004, F.A.C.

GENERAL NOTES:

1. CONTACT MANATEE COUNTY PROJECT MANAGEMENT DEPARTMENT BEFORE STARTING WORK, CHECKING FOR UPDATES ON STANDARDS OR OTHER INFORMATION.
2. ONE WEEK PRIOR TO THE BEGINNING OF THE CONSTRUCTION, THE CONTRACTOR SHALL NOTIFY:
 MANATEE COUNTY PROJECT MANAGEMENT DEPT.
 1026 26TH AVENUE EAST
 BRADENTON, FLORIDA 34208
 PHONE: (941) 708-7450
 MANATEE COUNTY TRAFFIC MANAGEMENT DEPT.
 1026 26TH AVENUE EAST
 BRADENTON, FLORIDA 34208
 PHONE: (941) 708- 7463
3. ALL F.D.O.T. SPECIFICATIONS WILL BE FOLLOWED, EXCEPT WHEN F.D.O.T. AND MANATEE COUNTY SPECIFICATIONS DIFFER, MANATEE COUNTY SPECIFICATIONS TAKE PRECEDENCE, IF MANATEE COUNTY IS MORE STRINGENT. MANATEE COUNTY TRAFFIC SIGNAL SPECIFICATIONS WILL BE SUPPLIED TO THE CONTRACTOR BY THE PROJECT MANAGEMENT DEPARTMENT.
4. BASELINES ON SR-70 SHOWN ON THE PLANS ARE FOR INFORMATION PURPOSES ONLY AND ARE NOT STAKED IN THE FIELD.
5. THE CONTRACTOR SHALL BE RESPONSIBLE FOR MAINTAINING ALL PROPOSED EQUIPMENT UNTIL FINAL ACCEPTANCE. IN ADDITION, THE CONTRACTOR SHALL MAINTAIN ALL EXISTING EQUIPMENT THAT IS IDENTIFIED TO BE EITHER MODIFIED OR RE-CONFIGURED AS A PART OF THIS PROJECT. COST FOR THIS MAINTENANCE SHALL BE INCLUDED IN THE ASSOCIATED ITEM.
6. ALL NEW UNDERGROUND CONDUIT SHALL BE SEALED AT BOTH ENDS WITH PLUGS TO PREVENT THE ENTRY OF DUST, DIRT OR MOISTURE.
7. THE CONTRACTOR SHALL BE ADVISED THAT OTHER PROJECTS MAY BE UNDER CONSTRUCTION CONCURRENTLY WITH THIS PROJECT AND THAT COORDINATION EFFORTS MAY BE NECESSARY. THE CONTRACTOR SHALL BE RESPONSIBLE FOR DETERMINING THE CONSTRUCTION SCHEDULE AND FOR THE AMOUNT OF COORDINATION REQUIRED. CONTRACTOR SHALL COORDINATE ANY AND ALL CONSTRUCTION ACTIVITIES AND TRAFFIC CONTROL PHASES WITH ANY CONTRACTOR WITHIN THE PROJECT LIMITS.
8. ALL FIELD WIRING SHALL BE NEATLY BUNDLED AND CLEARLY IDENTIFIED WITH PERMANENT LEGIBLE, WEATHER PROOF TAGS THAT ARE SECURELY ATTACHED TO EACH CABLE. THE TAGGING SYSTEM PROPOSED SHALL BE SUBMITTED FOR APPROVAL WITH THE OTHER EQUIPMENT SUBMITTALS REQUIRED FOR THIS PROJECT.
9. AT THE TIME OF FINAL INSPECTION OF THE PROJECT, THE CONTRACTOR SHALL FURNISH FDOT AND MANATEE COUNTY, THREE COMPLETE SETS OF AS-BUILT PLANS EACH.
10. ANY EXISTING LOOPS DAMAGED DURING CONSTRUCTION SHALL BE REPLACED BY THE CONTRACTOR AT CONTRACTOR'S EXPENSE.
11. UNLESS OTHERWISE NOTED, ANY REMOVED EQUIPMENT SHALL BE TURNED OVER TO MANATEE COUNTY AS DIRECTED BY THE ENGINEER.
12. IT SHALL BE THE CONTRACTOR'S RESPONSIBILITY TO EXAMINE THE JOB SITE CONDITIONS BEFORE SUBMITTING BID PROPOSALS IN ACCORDANCE WITH SECTION 2-4 OF THE SPECIFICATIONS.
13. THE CONTRACTOR SHALL VERIFY COLOR CODES FOR SIGNAL CABLE WITH MANATEE COUNTY.
14. SIGNAL SYSTEM MUST BE ABLE TO MAINTAIN COORDINATION AND PEDESTRIAN TRAFFIC.
15. INSTALLATION OF SPARE CONDUIT SHALL INCLUDE A #14 XHHW PULL STRING FOR FUTURE USE. COST OF PULL STRING SHALL BE INCIDENTAL TO PAY ITEM OF CONDUIT INSTALLATION.
16. CONCRETE SIDEWALK AND DRIVEWAY RESTORATION SHALL BE DONE JOINT BY JOINT. COST OF CONCRETE RESTORATION SHALL BE INCIDENTAL TO THE RELATED PAY ITEM.

TEMPORARY TRAFFIC CONTROL NOTES:

1. THE EXISTING POSTED SPEED LIMITS SHALL BE MAINTAINED AT ALL TIMES.
 SR 70 FROM 5TH ST TO 15TH ST 40 MPH
 SR 70 FROM I-75 SB OFF-RAMP TO LAKEWOOD RANCH BLVD 50 MPH
 US 301 FROM SR 70 TO 51ST AVE E. 55 MPH
2. THERE SHALL BE NO LANE CLOSURES ON SR 70 OR US 301 AND ON SIDE STREET/MINOR ROADS FROM 6:00 AM TO 9:00PM. LANE CLOSURES SHALL BE RESTRICTED TO ACTIVE WORK PERIODS.
3. DURING NON-WORKING HOURS, NO EQUIPMENT, VEHICLE OR MATERIAL SHALL BE PARKED OR STORED WITHIN THE CLEAR ZONE OF A ROADWAY OPEN TO VEHICULAR TRAFFIC.
4. PORTABLE CHANGEABLE MESSAGE SIGNS (PCMS) ARE TO BE USED DURING LANE CLOSURES.
5. PCMS MESSAGES MAY INCLUDE, BUT ARE NOT LIMITED TO THE FOLLOWING:
 A) FOR ALL LANES OPEN, DISPLAY 1) "CONST. AHEAD" 2) "USE CAUTION"
 B) FOR LEFT LANE CLOSURES, DISPLAY 1) "LFT LANE CLOSED" 2) "MERGE RT"
 C) FOR RIGHT LANE CLOSURES, DISPLAY 1) "RT LANE CLOSED" 2) "MERGE LFT"
 D) FOR CENTER LANE CLOSURES, DISPLAY 1) "LANE SHIFT AHEAD" 2) "USE CAUTION"
6. THE CONTRACTOR SHALL MAINTAIN TEMPORARY VEHICLE DETECTION ON ALL APPROACHES OF ALL AFFECTED TRAFFIC SIGNALS WITHIN THE PROJECT LIMITS THROUGHOUT CONSTRUCTION UNTIL MANATEE COUNTY ACCEPTS THE PROJECT. ANY DAMAGE TO THE EXISTING DETECTION SYSTEM AT AN INTERSECTION MUST BE RESTORED WITHIN TWENTY-FOUR (24) HOURS AT NO ADDITIONAL COST TO THE COUNTY. MANATEE COUNTY TRAFFIC OPERATIONS DIVISION WILL ASSIST AS NEEDED WHEN POSSIBLE.

MATERIALS TO BE PROVIDED BY FDOT:

1. A.S.C. EQUIPMENT WILL BE PROVIDED BY FDOT INCLUDING VIDEO DETECTION CAMERAS.

ABBREVIATIONS

- A.S.C. - ADAPTIVE SYSTEM CONTROL
- CAT-5E - CATEGORY 5E CABLE
- COAX - COAXIAL CABLE
- E.P.B. - ELETRICAL PULL BOX
- F.O.P.B. - FIBER OPTIC PULL BOX
- F.O.S.V. - FIBER OPTIC SPLICE VAULT
- G - GROUND
- L - LINE
- L.P.B - LOOP PULL BOX
- M.A. - MAST ARM
- M.C. - MEDIA CONVERTER
- N - NEUTRAL
- PTZ - PAN, TILT, AND ZOOM
- PB - PULL BOX
- S.P.B. - SIGNAL PULL BOX
- SM - SINGLE MODE
- ST - STRAIGHT TIP
- TTS - TRAVEL TIME SYSTEM
- VMS - VARIABLE MESSAGE SIGN
- V.D.C. - VIDEO DETECTION CAMERA

				SCALE AS NOTED	RICARDO J. GONZALEZ, P.E. P.E. NO.: 66564 METRIC ENGINEERING, INC. 615 CRESCENT EXECUTIVE CT, SUITE 524 LAKE MARY, FLORIDA 32746 TEL. (407) 644-1898 FAX. (407) 644-2376 CERTIFICATE OF AUTHORIZATION: 2294	DATE 04-01-2016	 MANATEE COUNTY PUBLIC WORKS	DESIGN ENGINEER RICARDO GONZALEZ	<h2 style="margin: 0;">GENERAL NOTES</h2>	SHEET NO.
				DRAWN BY JUSTIN SCHICK	PROJECT NO. 438870-1-58-01	FL. LICENSE NO. 66564				IT-3
NO.	REVISIONS	DATE	BY	CHECKED BY ROLANDO RAMIREZ						

THE OFFICIAL RECORD OF THIS SHEET IS THE ELECTRONIC FILE DIGITALLY SIGNED AND SEALED UNDER RULE 61G15-23.004, F.A.C.

UTILITY NOTES:

1. THE CONTRACTOR SHALL VERIFY VERTICALLY AND HORIZONTALLY (VVH) EXISTING UTILITIES PRIOR TO ANY DIRECTIONAL BORES, COST SHALL BE INCLUDED IN THE COST OF THE BORE.
2. HAND DIGGING SHALL BE USED AROUND ALL KNOWN AND LOCATED UTILITIES. CONTACT MANATEE COUNTY FOR LOCATES ON COUNTY UTILITIES.
3. THE CONTRACTOR SHALL EXERCISE ALL APPROPRIATE SAFETY MEASURES WHEN WORKING IN OR AROUND AREAS OF OVERHEAD ELECTRICAL DISTRIBUTION/TRANSMISSION LINES OR UNDERGROUND UTILITIES.
4. CONTRACTOR SHALL MAKE SURE THAT ALL NECESSARY PROTECTIVE MEASURES ARE TAKEN TO SAFEGUARD EXISTING UTILITIES DURING FIBER/EQUIPMENT INSTALLATION.
5. ALL APPLICABLE PROVISIONS OF EXISTING UTILITY EASEMENT WILL BE ADHERED TO BY THE CONTRACTOR.
6. THE LOCATION OF THE CONDUITS AND PULL BOXES ARE DIAGRAMMATIC ONLY AND MAY BE SHIFTED BY THE ENGINEER TO ACCOMMODATE LOCAL CONDITIONS AND EXISTING UTILITY LOCATIONS. CONDUIT SHALL BE PLACED WITHIN EXISTING RIGHT-OF-WAY. PULL BOXES AND SPLICE BOXES SHALL NOT BE INSTALLED AT THE BOTTOM OF DITCHES AND PONDS.
7. THE CONTRACTOR SHALL BE PRESENT WHEN THE UTILITY COMPANIES LOCATE THEIR FACILITIES. THE CONTRACTOR IS RESPONSIBLE FOR COORDINATING WITH ALL UTILITY OWNERS WHERE CONFLICTS BETWEEN THE CONTRACTOR'S ACTIVITIES AND EXISTING UTILITIES MAY OCCUR.
8. THE CONTRACTOR SHALL NOTIFY THE APPROPRIATE UTILITY DEPARTMENT(S) AT LEAST TWO BUSINESS DAYS IN ADVANCE OF EXCAVATION OPERATIONS WHERE CONFLICT WITH UTILITIES IS EXPECTED.
9. THE CONTRACTOR IS REQUIRED TO INSPECT THE TRAFFIC SIGNAL ACCORDANCE WITH THE STANDARD SPECIFICATIONS. THE CONTRACTOR SHALL COORDINATE THE FINAL ACCEPTANCE INSPECTION IN ACCORDANCE WITH FDOT SPECIFICATION 611-2.2 WITH THE ENGINEER AT LEAST TEN DAYS IN ADVANCE. MANATEE COUNTY TRAFFIC ENGINEER VISHAL S. KAKKAD, P.E., PTOE AT (941) 749-3500 EXT. 7812 SHOULD ALSO BE CONTACTED TEN DAYS BEFORE THE INSPECTION IS TO BE PERFORMED.

UTILITY CONTACTS:

	COMPANY	NAME	PHONE
1	AT&T	STEVE HAMMER	813-888-8300
2	BRADEN RIVER UTILITIES	DAVE HOWE	941-757-1578
3	BRIGHT HOUSE NETWORKS MANATEE	JIM CRUZAN	727-329-2846
4	FLORIDA POWER & LIGHT	GREG COKER	941-723-4430
5	MANATEE COUNTY UTILITY OPERATIONS	DAVE BRANNING	941-708-7450
6	PEACE RIVER ELECTRIC COOPERATIVE	CLAY STANPHILL	863-781-0863
7	TECO - PEOPLE'S GAS	DANNY SHANAHAN	941-342-4006
8	VERIZON FLORIDA INC.	DENISE HUTTON	941-906-6722

LEGEND:

	<u>EXISTING</u>	<u>PROPOSED</u>	<u>RELOCATED</u>
TRAFFIC SIGNAL PULL BOX			
ITS PULL BOX			
POLE MOUNT CABINET			
GROUND MOUNT CABINET			
FIBER OPTIC PULL BOX			
FIBER OPTIC PULL BOX W/ SPLICE ENCLOSURE			
FIBER OPTIC SPLICE VAULT			
VIDEO DETECTION CAMERA			
EXISTING PTZ CCTV			
BLUETOOTH TTS			
EXISTING ROUND POLE			
PEDESTRIAN SIGNAL			
SIGNAL HEAD			
SIGNAL STRAIN POLE			
UTILITY POWER POLE			
AERIAL DROP			
DIRECTIONAL BORE CONDUIT			
UNDERGROUND CONDUIT			
OVERHEAD ELECTRIC			
SIGNAL SPAN WIRE			
MAST ARM			
VMS			
WETLANDS			

NO.	REVISIONS	DATE	BY	SCALE AS NOTED	RICARDO J. GONZALEZ, P.E. P.E. NO.: 66564 METRIC ENGINEERING, INC. 615 CRESCENT EXECUTIVE CT, SUITE 524 LAKE MARY, FLORIDA 32746 TEL. (407) 644-1898 FAX. (407) 644-2376 CERTIFICATE OF AUTHORIZATION: 2294	DATE 04-01-2016 PROJECT NO. 438870-1-58-01	MANATEE COUNTY PUBLIC WORKS	DESIGN ENGINEER RICARDO GONZALEZ FL. LICENSE NO. 66564	SHEET NO. IT-4
-----	-----------	------	----	-------------------	--	---	--------------------------------	---	-----------------------

GENERAL NOTES

THE OFFICIAL RECORD OF THIS SHEET IS THE ELECTRONIC FILE DIGITALLY SIGNED AND SEALED UNDER RULE 61G15-23.004, F.A.C.



NO.	REVISIONS	DATE	BY

SCALE AS NOTED
 DESIGNED BY RICARDO GONZALEZ
 DRAWN BY JUSTIN SCHICK
 CHECKED BY ROLANDO RAMIREZ

RICARDO J. GONZALEZ, P.E.
 P.E. NO.: 66564
 METRIC ENGINEERING, INC.
 615 CRESCENT EXECUTIVE CT, SUITE 524
 LAKE MARY, FLORIDA 32746
 TEL. (407) 644-1898
 FAX. (407) 644-2376
 CERTIFICATE OF AUTHORIZATION: 2294

DATE 04-01-2016
 PROJECT NO. 438870-1-58-01



MANATEE COUNTY PUBLIC WORKS

DESIGN ENGINEER RICARDO GONZALEZ
 FL. LICENSE NO. 66564

PROJECT LAYOUT

SHEET NO. IT-5

THE OFFICIAL RECORD OF THIS SHEET IS THE ELECTRONIC FILE DIGITALLY SIGNED AND SEALED UNDER RULE 61G15-23.004, F.A.C.

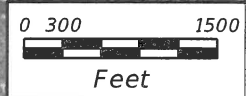
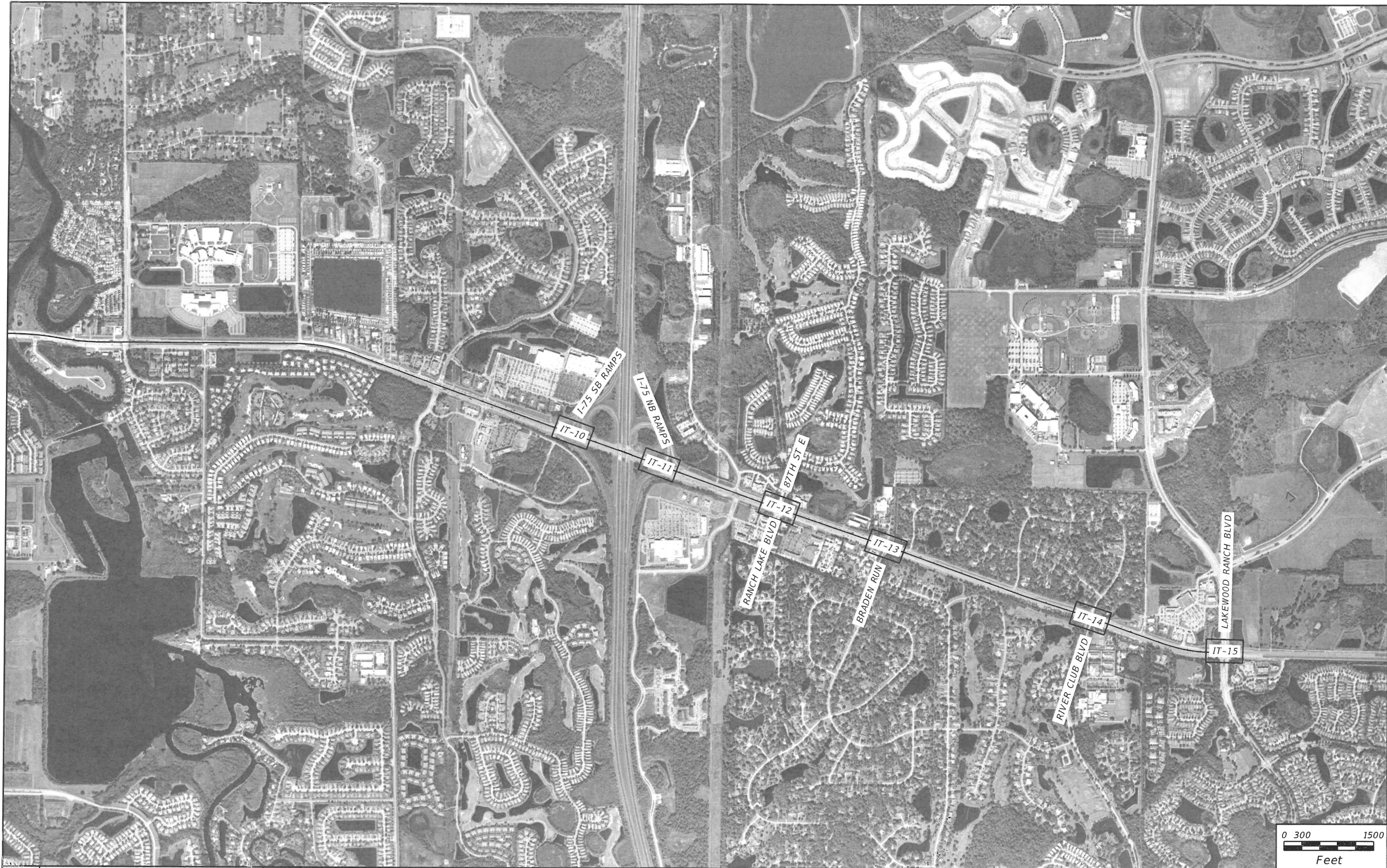

NO.	REVISIONS	DATE	BY

SCALE AS NOTED

RICARDO J. GONZALEZ, P.E.
 P.E. NO.: 66564
 METRIC ENGINEERING, INC.
 615 CRESCENT EXECUTIVE CT, SUITE 524
 LAKE MARY, FLORIDA 32746
 TEL. (407) 644-1898
 FAX. (407) 644-2376
 CERTIFICATE OF AUTHORIZATION: 2294

DATE
04-01-2016

PROJECT NO.
438870-1-58-01

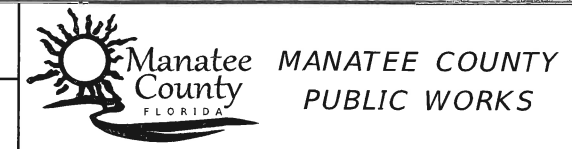

DESIGN ENGINEER
RICARDO GONZALEZ

FL. LICENSE NO.
66564

PROJECT LAYOUT

SHEET NO.
IT-6

THE OFFICIAL RECORD OF THIS SHEET IS THE ELECTRONIC FILE DIGITALLY SIGNED AND SEALED UNDER RULE 61G15-23.004, F.A.C.

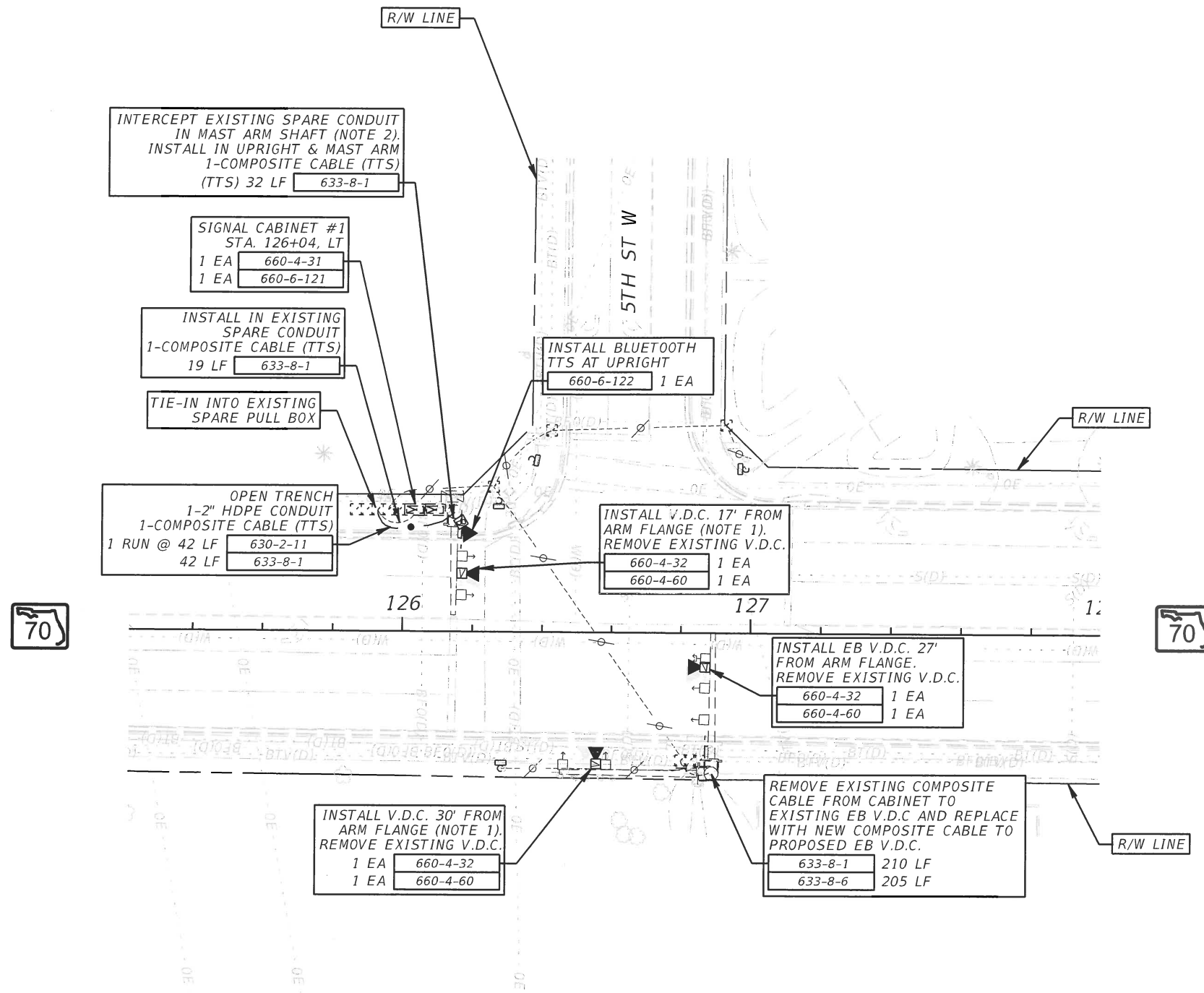

NOTES:

- 1- UTILIZE EXISTING COMPOSITE CABLE.
- 2- IF NO SPARE CONDUIT IS FOUND, INSTALL AN UNDERGROUND CONDUIT FROM SPARE OR PROPOSED PULL BOX TO VIDEO DETECTION PULL BOX AND UTILIZE EXISTING VIDEO DETECTION CONDUIT.

SIGNAL LOCATION NO. 1
 SR 70 (53RD AVE. E.) AT
 5TH ST W.
 MP 0.503

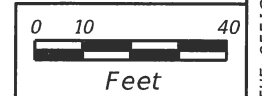

		SCALE AS NOTED	RICARDO J. GONZALEZ, P.E. P.E. NO.: 66564		DATE 04-01-2016	MANATEE COUNTY PUBLIC WORKS	DESIGN ENGINEER RICARDO GONZALEZ	<p style="text-align: center;">PLAN SHEET</p>	SHEET NO.
		DESIGNED BY RICARDO GONZALEZ	615 CRESCENT EXECUTIVE CT, SUITE 524 LAKE MARY, FLORIDA 32746 TEL. (407) 644-1898 FAX. (407) 644-2376		PROJECT NO. 438870-1-58-01		FL. LICENSE NO. 66564		IT-7
NO.	REVISIONS	DATE	BY	CHECKED BY ROLANDO RAMIREZ	CERTIFICATE OF AUTHORIZATION: 2294				

THE OFFICIAL RECORD OF THIS SHEET IS THE ELECTRONIC FILE DIGITALLY SIGNED AND SEALED UNDER RULE 61G15-23.004, F.A.C.

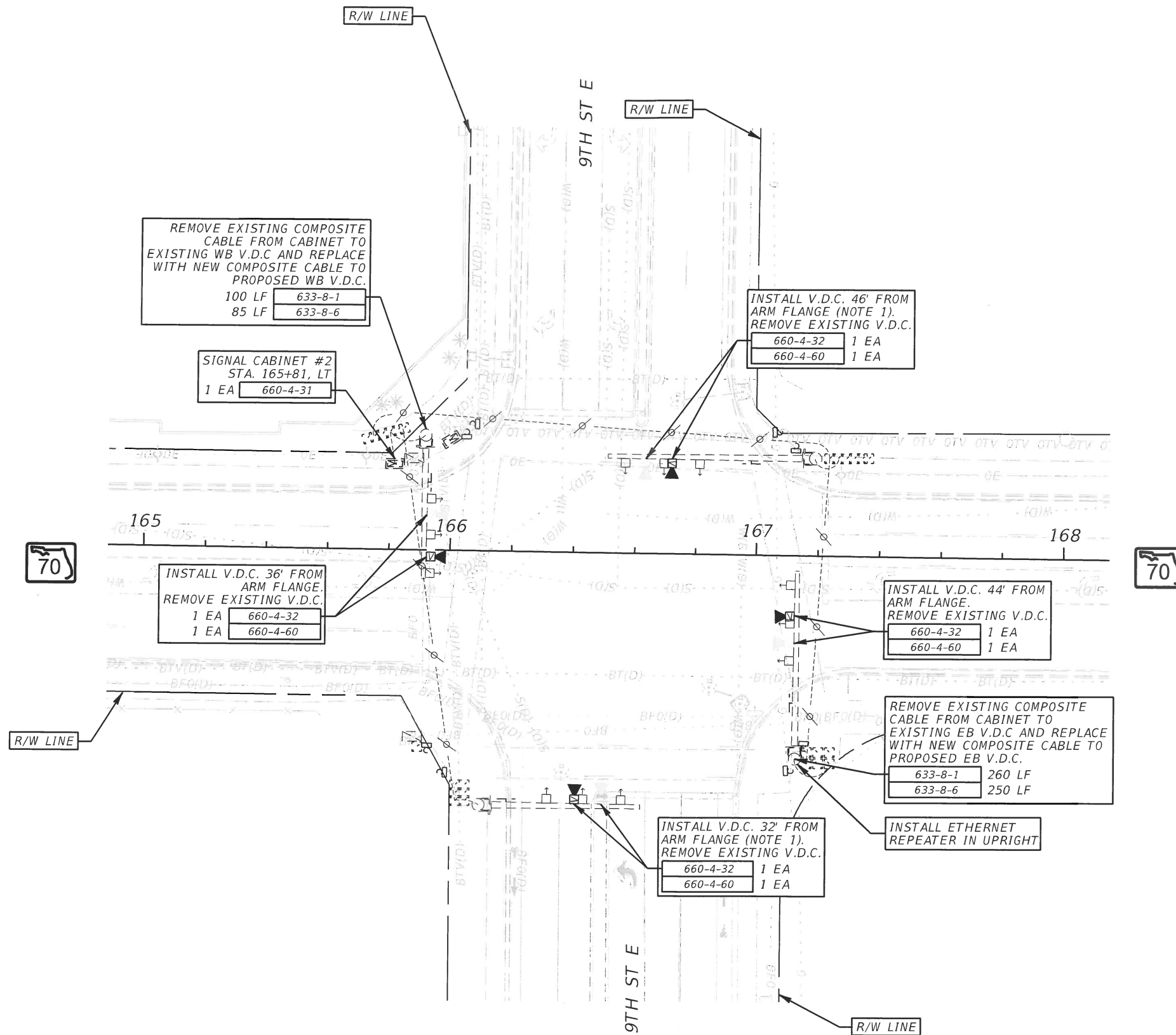

NOTES:
1- UTILIZE EXISTING COMPOSITE CABLE.

SIGNAL LOCATION NO. 2
SR 70 (53RD AVE. E.) AT
9TH ST W.
MP 1.260
SIGNAL ID #541

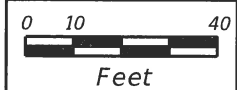

SCALE		AS NOTED		RICARDO J. GONZALEZ, P.E. P.E. NO.: 66564		DATE		10/21/2016		DESIGN ENGINEER		RICARDO GONZALEZ		SHEET NO.	
DESIGNED BY		RICARDO GONZALEZ		METRIC ENGINEERING, INC. 615 CRESCENT EXECUTIVE CT, SUITE 524 LAKE MARY, FLORIDA 32746		PROJECT NO.		438870-1-58-01		FL. LICENSE NO.		66564		IT-8	
DRAWN BY		JUSTIN SCHICK		CERTIFICATE OF AUTHORIZATION: 2294		MANATEE COUNTY PUBLIC WORKS				PLAN SHEET					
CHECKED BY		ROLANDO RAMIREZ													
NO.		REVISIONS		DATE		BY									

THE OFFICIAL RECORD OF THIS SHEET IS THE ELECTRONIC FILE DIGITALLY SIGNED AND SEALED UNDER RULE 61G15-23.004, F.A.C.

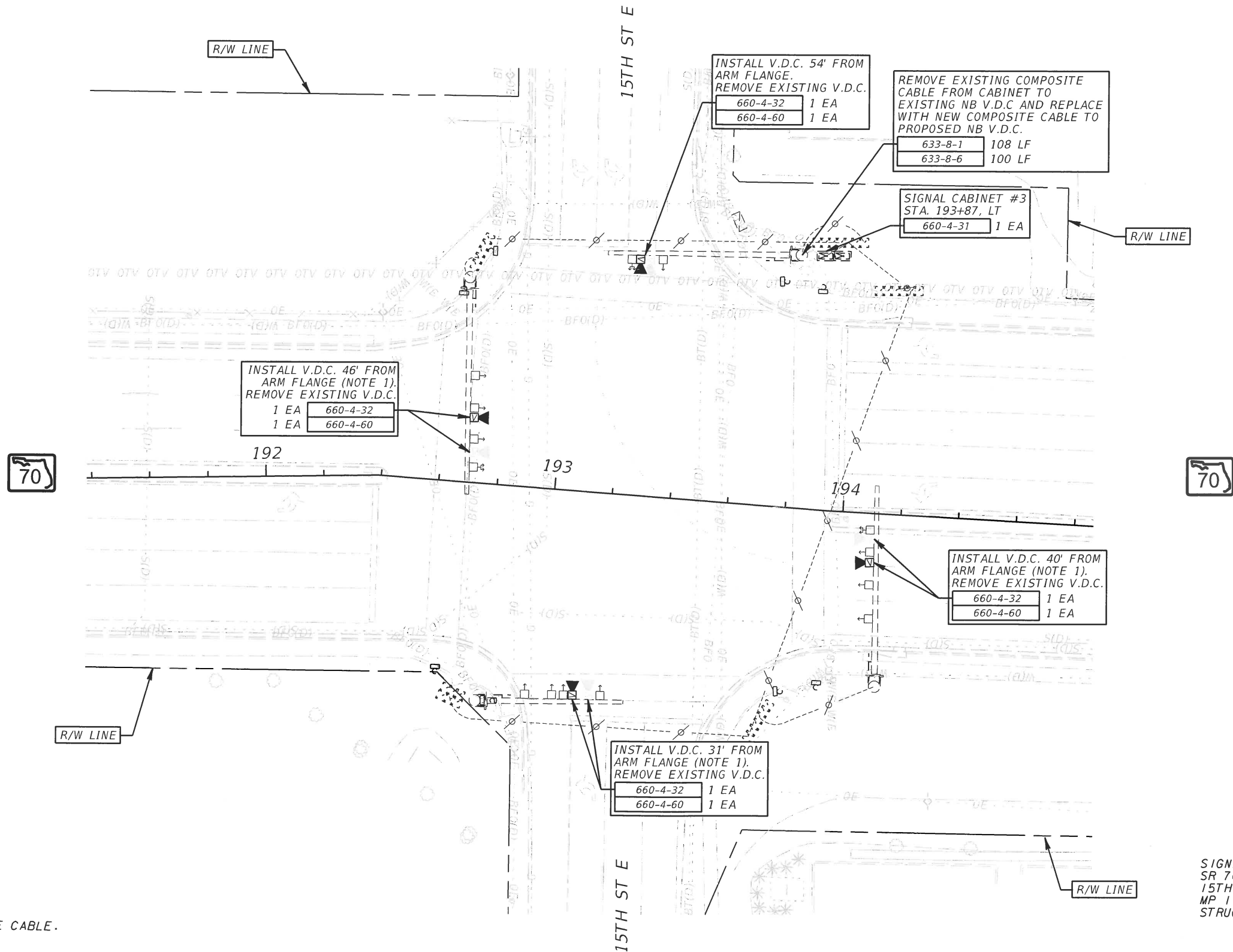

NOTES:
 1 - UTILIZE EXISTING COMPOSITE CABLE.

SIGNAL LOCATION NO. 3
 SR 70 (53RD AVE. E.) AT
 15TH ST W.
 MP 1.761
 STRUCTURE NUMBER: 13M055

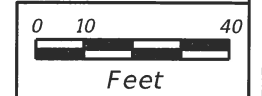

SCALE AS NOTED		RICARDO J. GONZALEZ, P.E. P.E. NO.: 66564 METRIC ENGINEERING, INC. 615 CRESCENT EXECUTIVE CT, SUITE 524 LAKE MARY, FLORIDA 32746 TEL. (407) 644-1898 FAX. (407) 644-2376 CERTIFICATE OF AUTHORIZATION: 2294	DATE	 MANATEE COUNTY PUBLIC WORKS	DESIGN ENGINEER	PLAN SHEET	SHEET NO.
DESIGNED BY	RICARDO GONZALEZ		04-01-2016		RICARDO GONZALEZ		IT-9
DRAWN BY	JUSTIN SCHICK	PROJECT NO.	438870-1-58-01	FL. LICENSE NO.	66564		
CHECKED BY	ROLANDO RAMIREZ						
NO.	REVISIONS	DATE	BY				

THE OFFICIAL RECORD OF THIS SHEET IS THE ELECTRONIC FILE DIGITALLY SIGNED AND SEALED UNDER RULE 61G15-23.004, F.A.C.

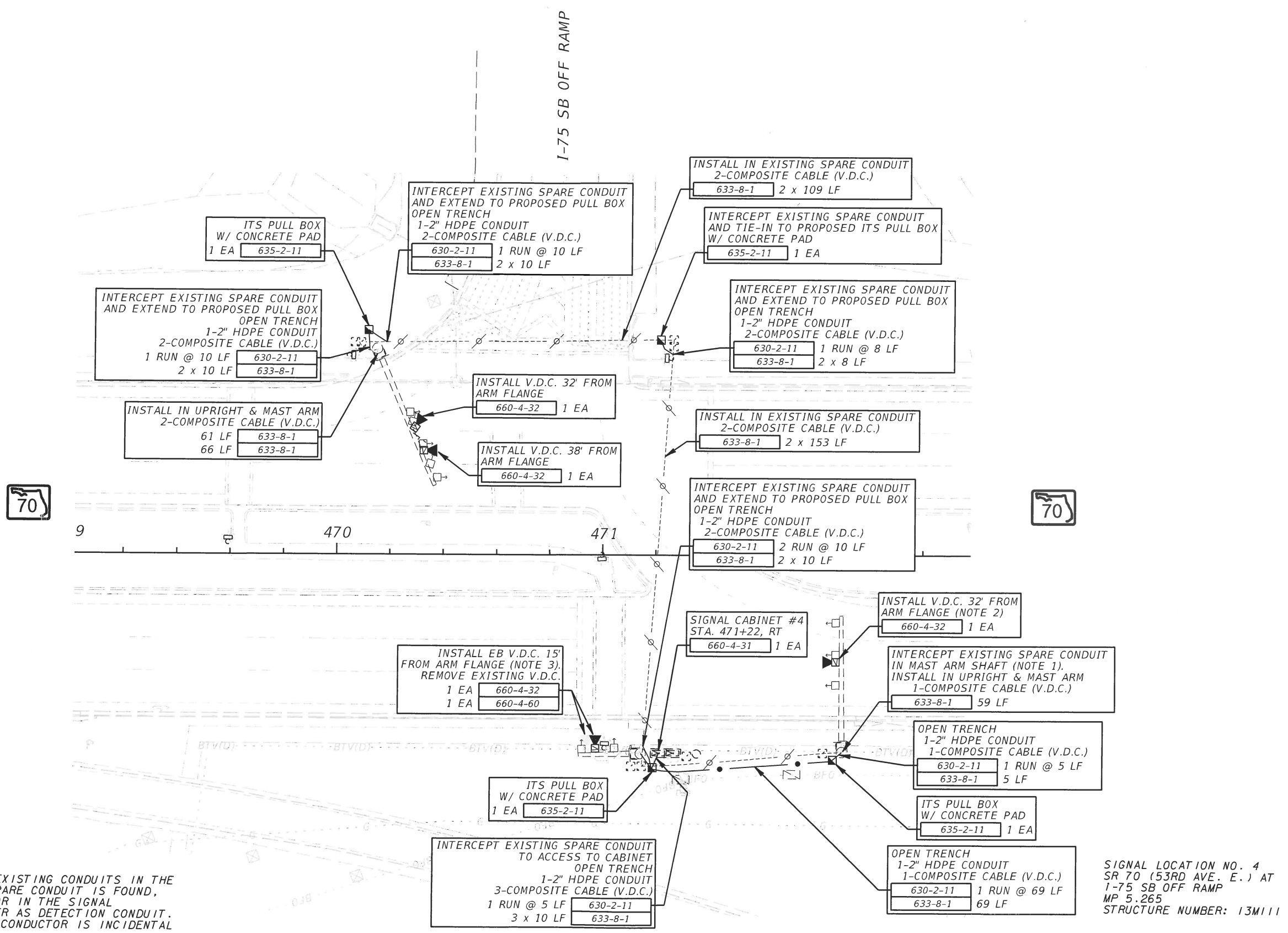

- NOTES:**
- 1- THERE ARE AT LEAST TWO EXISTING CONDUITS IN THE MAST ARM SHAFT. IF NO SPARE CONDUIT IS FOUND, RELOCATE GROUND CONDUCTOR IN THE SIGNAL CONDUIT AND USE THE OTHER AS DETECTION CONDUIT. COST TO RELOCATE GROUND CONDUCTOR IS INCIDENTAL OF PAY ITEM NO. 633-8-1.
 - 2- INSTALL VIDEO/RADAR SENSOR.
 - 3- UTILIZE EXISTING COMPOSITE CABLE.

SIGNAL LOCATION NO. 4
 SR 70 (53RD AVE. E.) AT
 I-75 SB OFF RAMP
 MP 5.265
 STRUCTURE NUMBER: 13M111



SCALE AS NOTED		RICARDO J. GONZALEZ, P.E. P.E. NO.: 66564 METRIC ENGINEERING, INC. 615 CRESCENT EXECUTIVE CT, SUITE 524 LAKE MARY, FLORIDA 32746 TEL. (407) 644-1898 FAX. (407) 644-2376 CERTIFICATE OF AUTHORIZATION: 2294	DATE 04-01-2016	MANATEE COUNTY PUBLIC WORKS	DESIGN ENGINEER RICARDO GONZALEZ	PLAN SHEET	SHEET NO.
DESIGNED BY RICARDO GONZALEZ DRAWN BY JUSTIN SCHICK CHECKED BY ROLANDO RAMIREZ			PROJECT NO. 438870-1-58-01		FL. LICENSE NO. 66564		IT-10
NO.	REVISIONS	DATE	BY				

THE OFFICIAL RECORD OF THIS SHEET IS THE ELECTRONIC FILE DIGITALLY SIGNED AND SEALED UNDER RULE 61G15-23.004, F.A.C.



I-75 NB
ON-RAMP

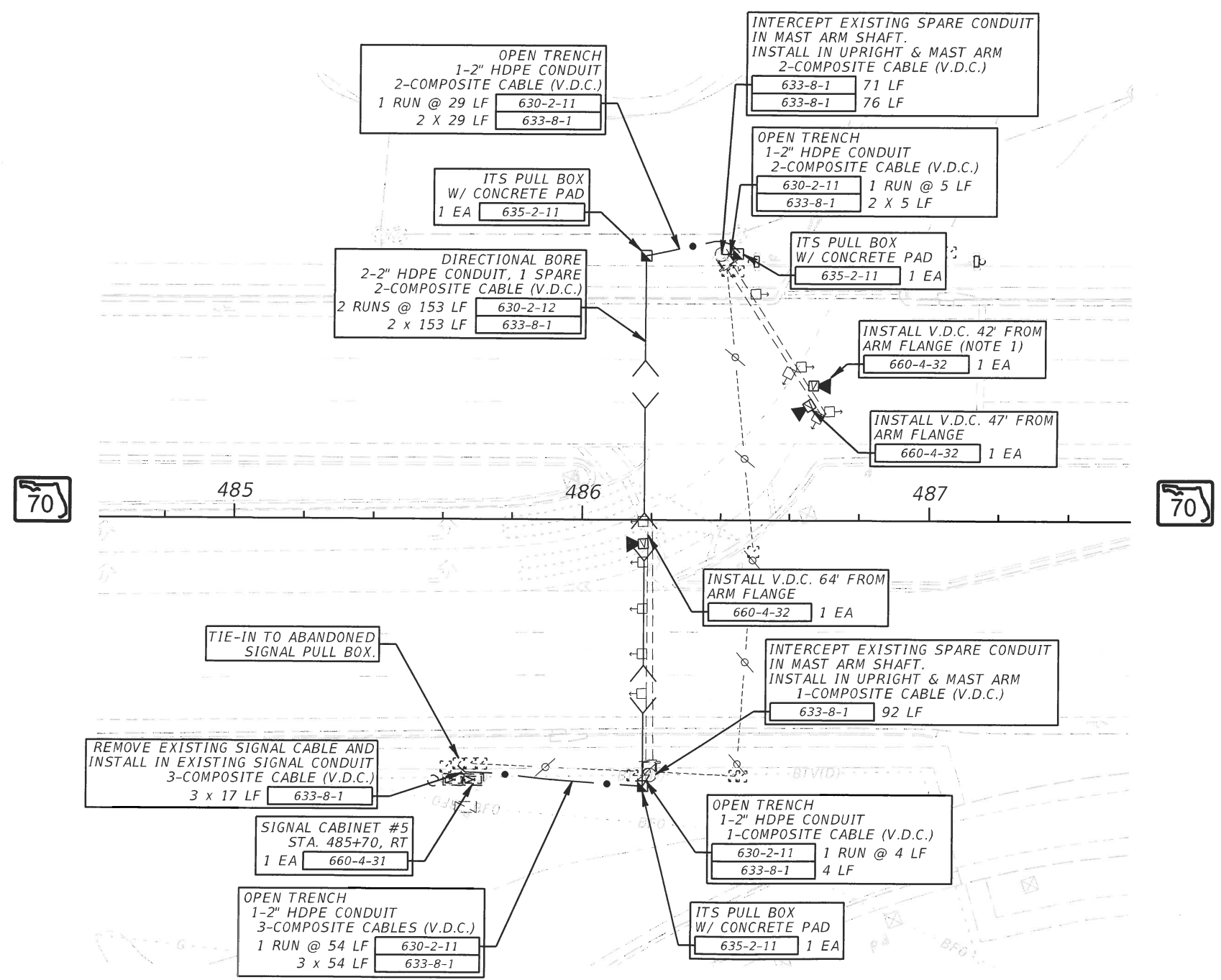

NOTES:
1- INSTALL VIDEO/RADAR SENSOR.

SIGNAL LOCATION NO. 5
SR 70 (53RD AVE. E.) AT
I-75 NB OFF RAMP
MP 5.549
STRUCTURE NUMBER: 13M054

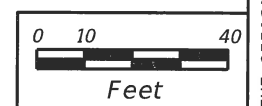

SCALE AS NOTED		RICARDO J. GONZALEZ, P.E. P.E. NO.: 66564		DATE 04-01-2016		DESIGN ENGINEER RICARDO GONZALEZ		SHEET NO.	
DESIGNED BY RICARDO GONZALEZ		METRIC ENGINEERING, INC. 615 CRESCENT EXECUTIVE CT, SUITE 524 LAKE MARY, FLORIDA 32746 TEL. (407) 644-1898 FAX. (407) 644-2376		PROJECT NO. 438870-1-58-01		FL. LICENSE NO. 66564		PLAN SHEET	
DRAWN BY JUSTIN SCHICK		CERTIFICATE OF AUTHORIZATION: 2294		MANATEE COUNTY PUBLIC WORKS				IT-11	
CHECKED BY ROLANDO RAMIREZ				Manatee County FLORIDA					
NO.	REVISIONS	DATE	BY						

THE OFFICIAL RECORD OF THIS SHEET IS THE ELECTRONIC FILE DIGITALLY SIGNED AND SEALED UNDER RULE 61G15-23.004, F.A.C.

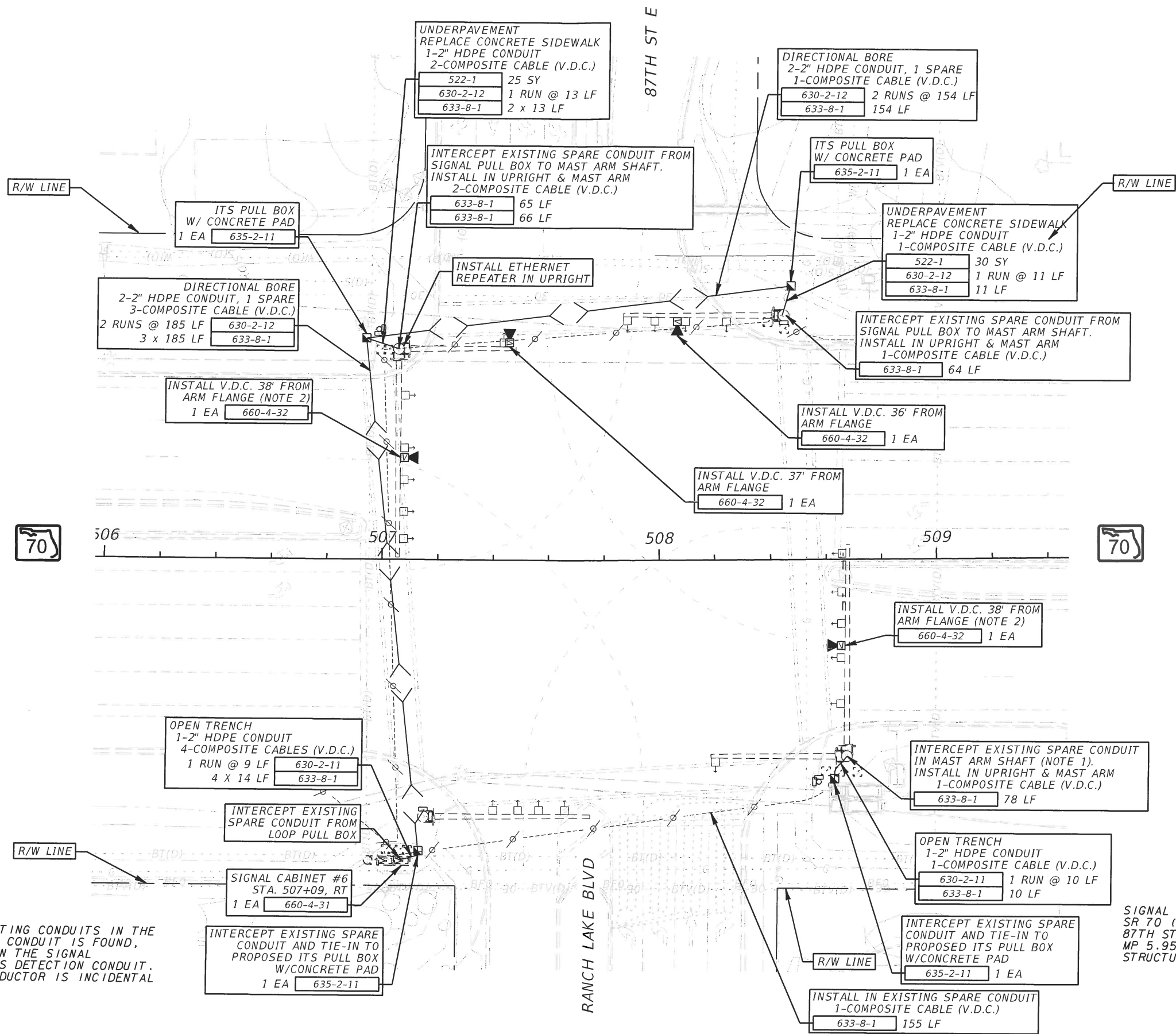

- NOTES:**
- 1- THERE ARE AT LEAST TWO EXISTING CONDUITS IN THE MAST ARM SHAFT. IF NO SPARE CONDUIT IS FOUND, RELOCATE GROUND CONDUCTOR IN THE SIGNAL CONDUIT AND USE THE OTHER AS DETECTION CONDUIT. COST TO RELOCATE GROUND CONDUCTOR IS INCIDENTAL OF PAY ITEM NO. 633-8-1.
 - 2- INSTALL VIDEO/RADAR SENSOR.

SIGNAL LOCATION NO. 6
 SR 70 (53RD AVE. E.) AT
 87TH ST E./RANCH LAKE BLVD.
 MP 5.957
 STRUCTURE NUMBER: 13M050

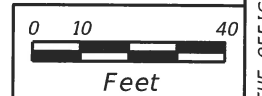

SCALE AS NOTED		RICARDO J. GONZALEZ, P.E. P.E. NO.: 66564 METRIC ENGINEERING, INC. 615 CRESCENT EXECUTIVE CT, SUITE 524 LAKE MARY, FLORIDA 32746 TEL. (407) 644-1898 FAX. (407) 644-2376 CERTIFICATE OF AUTHORIZATION: 2294	DATE	 MANATEE COUNTY PUBLIC WORKS	DESIGN ENGINEER	PLAN SHEET	SHEET NO.
DESIGNED BY RICARDO GONZALEZ			04-01-2016		RICARDO GONZALEZ		IT-12
DRAWN BY JUSTIN SCHICK			PROJECT NO.		FL. LICENSE NO.		
CHECKED BY ROLANDO RAMIREZ		438870-1-58-01	66564				
NO.	REVISIONS	DATE	BY				

THE OFFICIAL RECORD OF THIS SHEET IS THE ELECTRONIC FILE DIGITALLY SIGNED AND SEALED UNDER RULE 61G15-23.004, F.A.C.

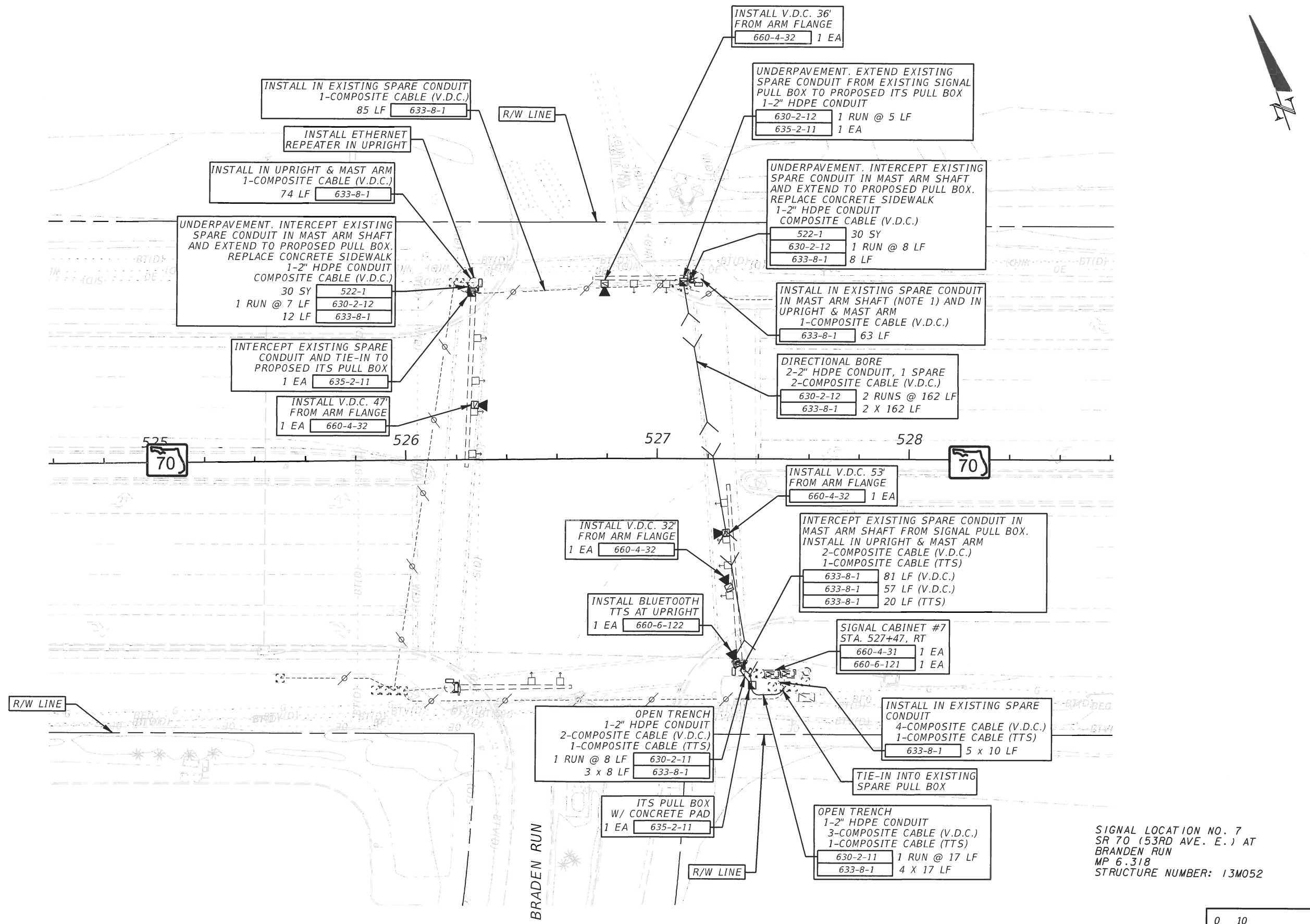

SIGNAL LOCATION NO. 7
 SR 70 (53RD AVE. E.) AT
 BRANDEN RUN
 MP 6.318
 STRUCTURE NUMBER: 13M052

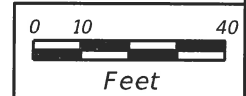

SCALE AS NOTED		RICARDO J. GONZALEZ, P.E. P.E. NO.: 66564 METRIC ENGINEERING, INC. 615 CRESCENT EXECUTIVE CT, SUITE 524 LAKE MARY, FLORIDA 32746 TEL. (407) 644-1898 FAX. (407) 644-2376 CERTIFICATE OF AUTHORIZATION: 2294	DATE 04-01-2016	MANATEE COUNTY PUBLIC WORKS	DESIGN ENGINEER RICARDO GONZALEZ	PLAN SHEET	SHEET NO.	
DESIGNED BY RICARDO GONZALEZ			PROJECT NO. 438870-1-58-01		FL. LICENSE NO. 66564		IT-13	
DRAWN BY JUSTIN SCHICK								
CHECKED BY ROLANDO RAMIREZ								
NO.	REVISIONS	DATE	BY					

THE OFFICIAL RECORD OF THIS SHEET IS THE ELECTRONIC FILE DIGITALLY SIGNED AND SEALED UNDER RULE 61G15-23.004, F.A.C.

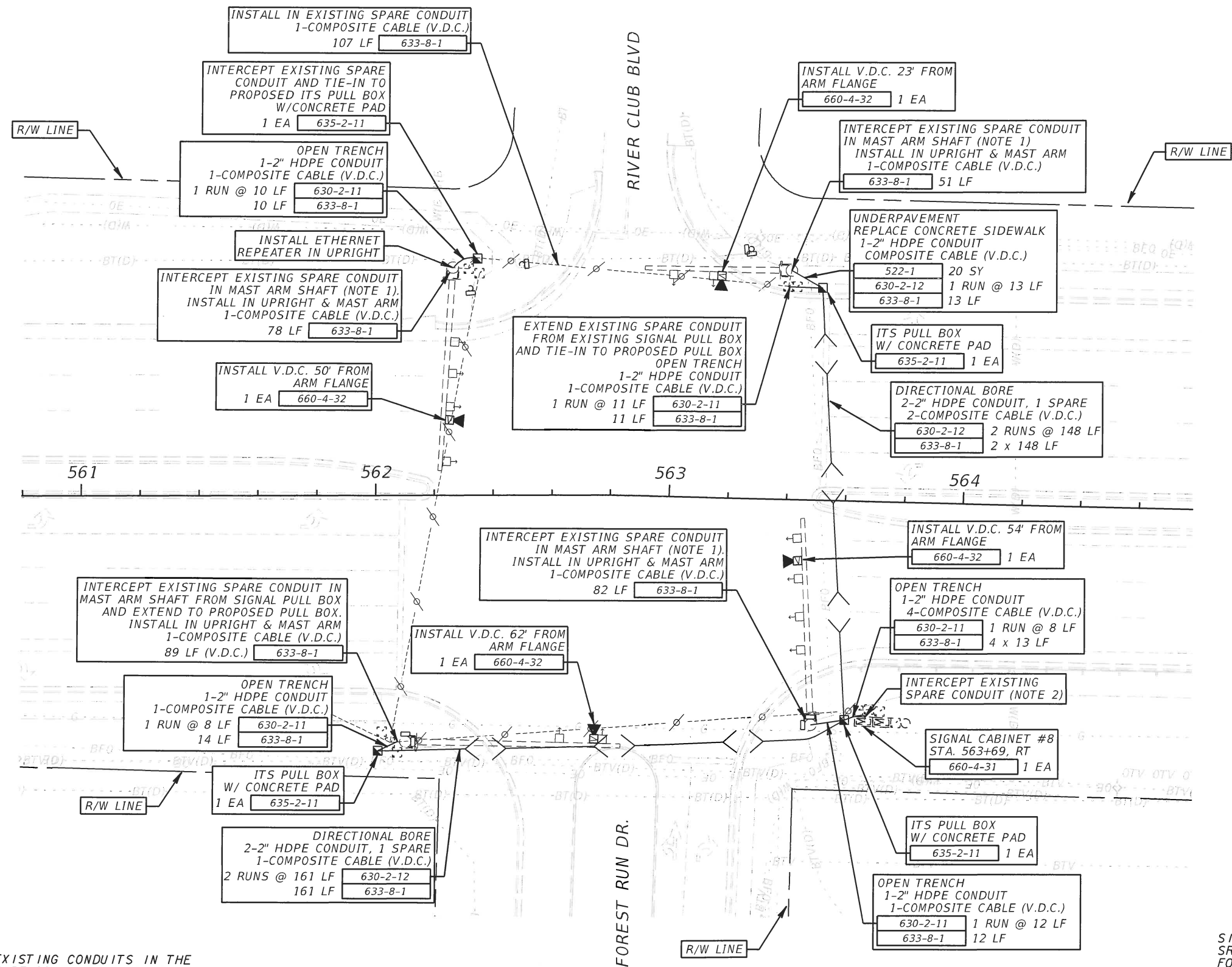

- NOTES:
- 1- THERE ARE AT LEAST TWO EXISTING CONDUITS IN THE MAST ARM SHAFT. IF NO SPARE CONDUIT IS FOUND, RELOCATE GROUND CONDUCTOR IN THE SIGNAL CONDUIT AND USE THE OTHER AS DETECTION CONDUIT. COST TO RELOCATE GROUND CONDUCTOR IS INCIDENTAL OF PAY ITEM NO. 633-8-1.
 - 2- IF NO SPARE CONDUIT IS FOUND, USE EXISTING LOOP DETECTION CONDUIT.

SIGNAL LOCATION NO. 8
 SR 70 (53RD AVE. E.) AT
 FOREST RUN DR./RIVER CLUB BLVD
 MP 7.003
 STRUCTURE NUMBER: 13M053

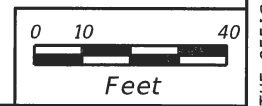

SCALE AS NOTED		RICARDO J. GONZALEZ, P.E. P.E. NO.: 66564 METRIC ENGINEERING, INC. 615 CRESCENT EXECUTIVE CT, SUITE 524 LAKE MARY, FLORIDA 32746 TEL. (407) 644-1898 FAX. (407) 644-2376 CERTIFICATE OF AUTHORIZATION: 2294	DATE	MANATEE COUNTY PUBLIC WORKS	DESIGN ENGINEER	RICARDO GONZALEZ FL. LICENSE NO. 66564	SHEET NO.
DESIGNED BY RICARDO GONZALEZ			04-01-2016		PROJECT NO.		
DRAWN BY JUSTIN SCHICK			438870-1-58-01				
CHECKED BY ROLANDO RAMIREZ							
NO.	REVISIONS	DATE	BY				IT-14

THE OFFICIAL RECORD OF THIS SHEET IS THE ELECTRONIC FILE DIGITALLY SIGNED AND SEALED UNDER RULE 61G15-23.004, F.A.C.

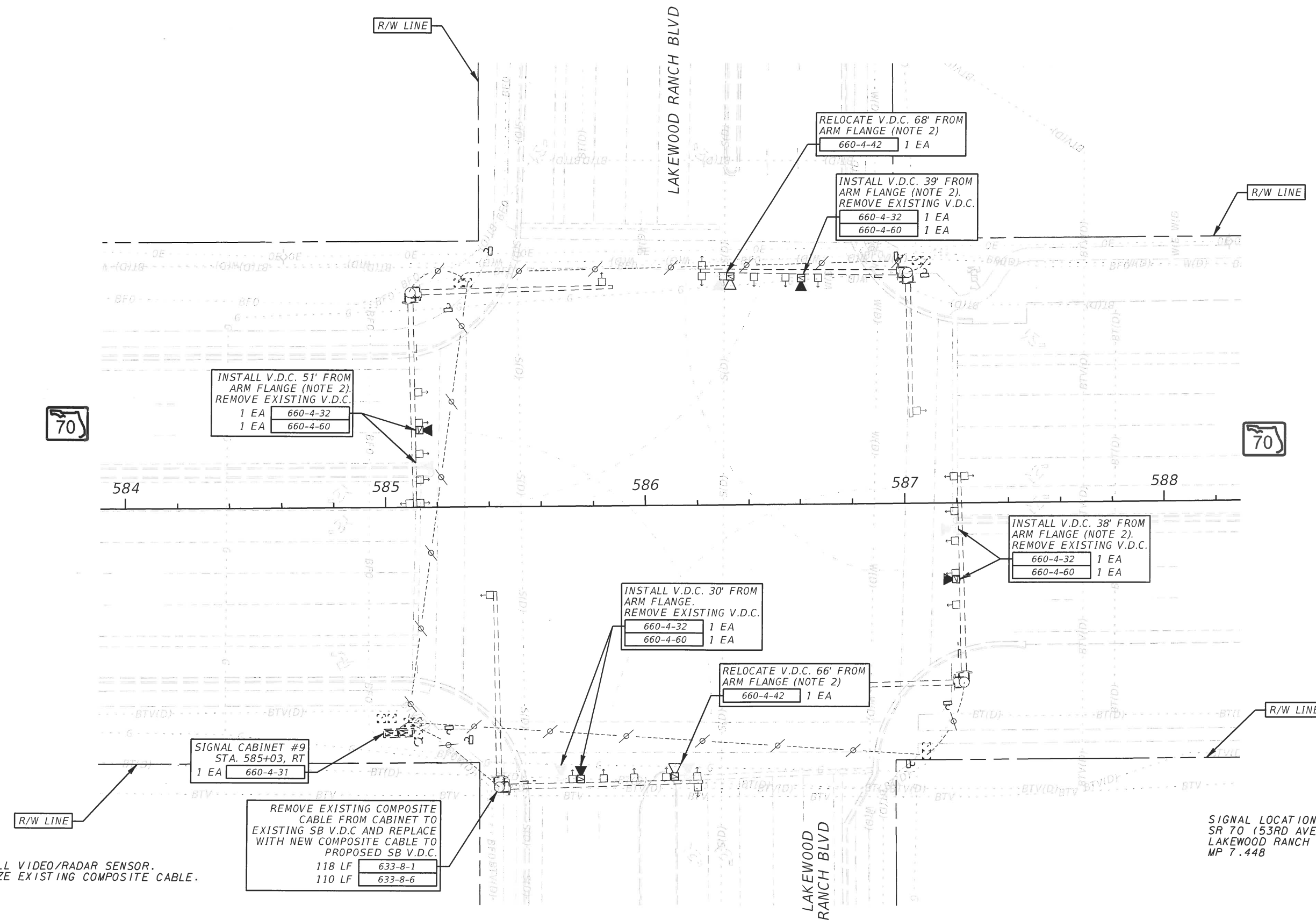

NOTES:
 1- INSTALL VIDEO/RADAR SENSOR.
 2- UTILIZE EXISTING COMPOSITE CABLE.

SIGNAL LOCATION NO. 9
 SR 70 (53RD AVE. E.) AT
 LAKEWOOD RANCH BLVD
 MP 7.448

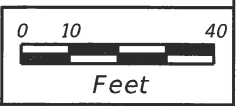

SCALE AS NOTED				RICARDO J. GONZALEZ, P.E. P.E. NO.: 66564 METRIC ENGINEERING, INC. 615 CRESCENT EXECUTIVE CT, SUITE 524 LAKE MARY, FLORIDA 32746 TEL. (407) 644-1898 FAX. (407) 644-2376 CERTIFICATE OF AUTHORIZATION: 2294		DATE 04-01-2016		 MANATEE COUNTY PUBLIC WORKS	DESIGN ENGINEER RICARDO GONZALEZ		PLAN SHEET	SHEET NO. IT-15	
DESIGNED BY RICARDO GONZALEZ DRAWN BY JUSTIN SCHICK CHECKED BY ROLANDO RAMIREZ				PROJECT NO. 438870-1-58-01		FL. LICENSE NO. 66564			JUSTIN.SCHICK 10/21/2016 1:30:34 PM J:\Orlando Jobs\Traffic 2 (R)\Old Projects\SR 70\43887015801\ITS\PLANIT20.DGN				

THE OFFICIAL RECORD OF THIS SHEET IS THE ELECTRONIC FILE DIGITALLY SIGNED AND SEALED UNDER RULE 61G15-23.004, F.A.C.

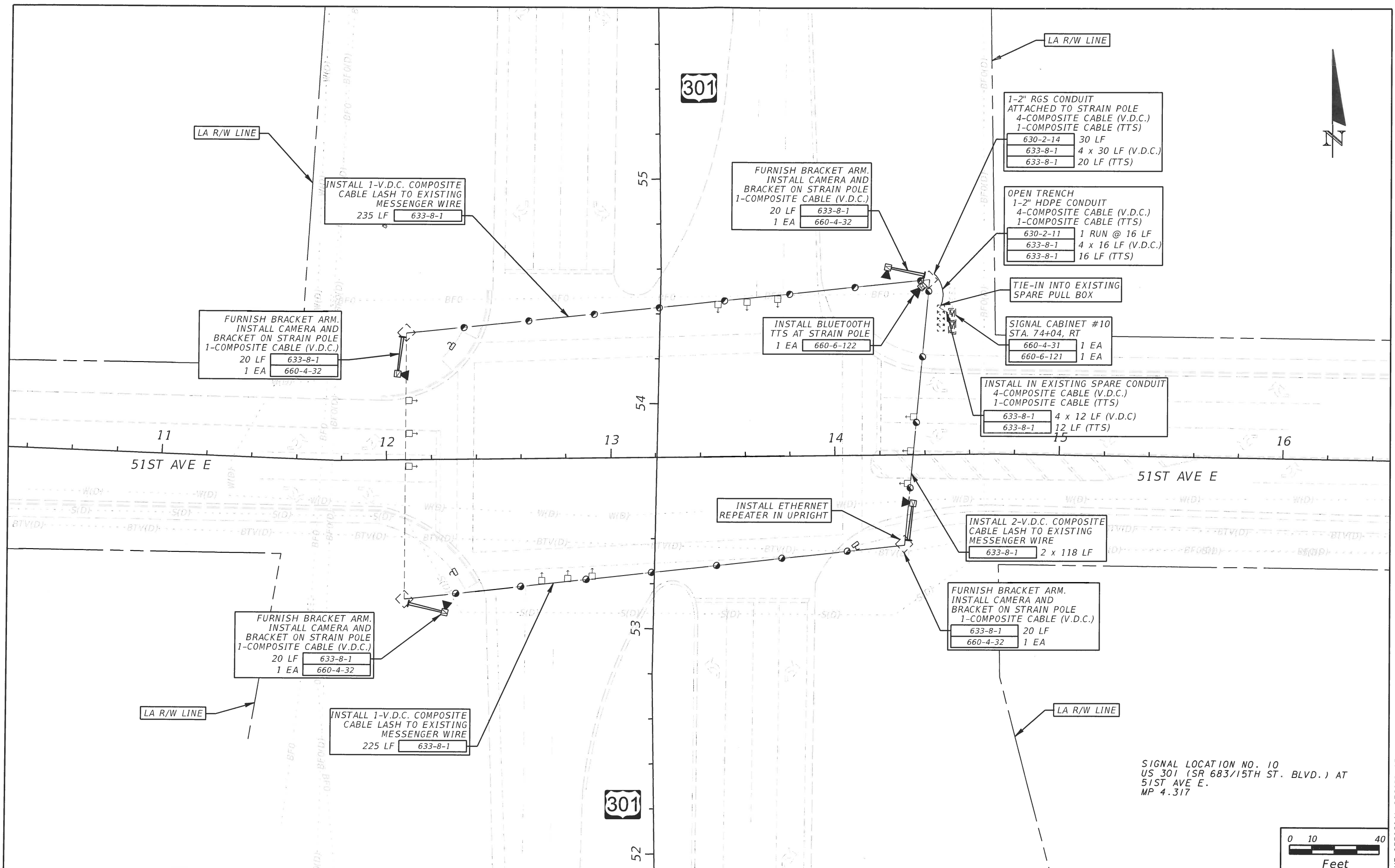

SIGNAL LOCATION NO. 10
 US 301 (SR 683/15TH ST. BLVD.) AT
 51ST AVE E.
 MP 4.317

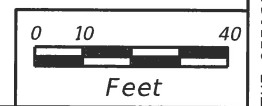

NO.	REVISIONS	DATE	BY

SCALE AS NOTED
 DESIGNED BY RICARDO GONZALEZ
 DRAWN BY JUSTIN SCHICK
 CHECKED BY ROLANDO RAMIREZ
 RICARDO J. GONZALEZ, P.E.
 P.E. NO.: 66564
 METRIC ENGINEERING, INC.
 615 CRESCENT EXECUTIVE CT, SUITE 524
 LAKE MARY, FLORIDA 32746
 TEL. (407) 644-1898
 FAX. (407) 644-2376
 CERTIFICATE OF AUTHORIZATION: 2294

DATE 04-01-2016
 PROJECT NO. 438870-1-58-01

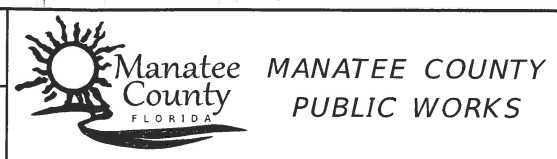

DESIGN ENGINEER RICARDO GONZALEZ
 FL. LICENSE NO. 66564

PLAN SHEET

SHEET NO. IT-16

THE OFFICIAL RECORD OF THIS SHEET IS THE ELECTRONIC FILE DIGITALLY SIGNED AND SEALED UNDER RULE 61G15-23.004, F.A.C.

NOTES:

1. WIRE ACCESS HOLES SHALL NOT EXCEED 1" DIAMETER AND SHALL INCLUDE A RUBBER GROMMET. ROUTE COMPOSITE CABLE(S) THROUGH MAST ARM. DRILL HOLE AS TO NOT DAMAGE EXISTING SIGNAL WIRE. UTILIZE EXISTING SIGNAL ACCESS HOLE IF POSSIBLE.
2. DETAIL FOR ASC DETECTION CAMERA ARE NOT SHOWN FOR CLARITY.
3. SEE PLANS FOR ACCESSING MAST ARM UPRIGHT.
4. MEET ALL GROUNDING REQUIREMENTS OF SECTION 620 OF THE STANDARD SPECIFICATIONS.
5. PLACE CAMERA AS CLOSE AS POSSIBLE TO THE CENTER OF THE APPROACH OF THROUGH AND LEFT TURN LANE.

ETHERNET REPEATERS TO BE INSTALLED			
No.	LOCATION / INTERSECTION	V.D.C. APPROACH LOCATION	REPEATER LOCATION
1	9TH ST W.	WEST	UPRIGHT AT SE CORNER
2	15TH ST W.	SOUTH	UPRIGHT AT SW CORNER
3	RANCH LAKE BLVD	SOUTH	UPRIGHT AT NW CORNER
4	BRANDEN RUN	EAST	UPRIGHT AT NW CORNER
5	FOREST RUN DR.	EAST	UPRIGHT AT NW CORNER
6	LAKWOOD RANCH BLVD	SOUTH (TWO V.C.D.)	UPRIGHT AT NE CORNER

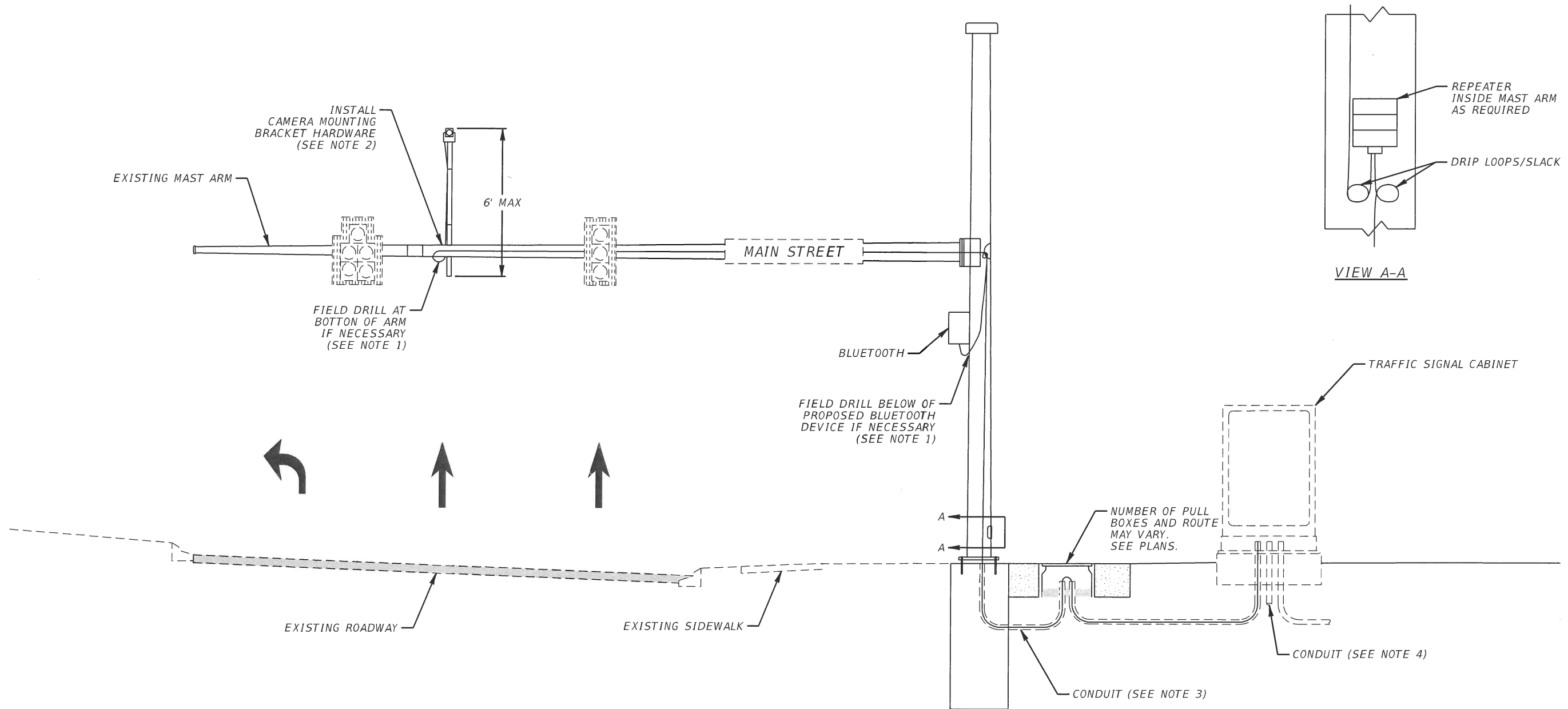

SCALE AS NOTED		RICARDO J. GONZALEZ, P.E. P.E. NO.: 66564 METRIC ENGINEERING, INC. 615 CRESCENT EXECUTIVE CT, SUITE 524 LAKE MARY, FLORIDA 32746 TEL. (407) 644-1898 FAX. (407) 644-2376 CERTIFICATE OF AUTHORIZATION: 2294		DATE 04-01-2016	MANATEE COUNTY PUBLIC WORKS	DESIGN ENGINEER RICARDO GONZALEZ	ASC MAST ARM DETAIL	SHEET NO. IT-17
DESIGNED BY RICARDO GONZALEZ		PROJECT NO. 438870-1-58-01		FL. LICENSE NO. 66564				
NO.	REVISIONS	DATE	BY	CHECKED BY ROLANDO RAMIREZ				

THE OFFICIAL RECORD OF THIS SHEET IS THE ELECTRONIC FILE DIGITALLY SIGNED AND SEALED UNDER RULE 61G15-23.004, F.A.C.

NOTES:

- ROUTE CAMERA CABLE(S) FROM CAMERA TO SIGNAL CABINET.
- DETAILS FOR ASC DETECTION CAMERA ARE NOT SHOWN FOR CLARITY.
- ABOVE GROUND RISER MAY BE REQUIRED. SEE PLANS FOR ACCESSING STRAIN POLE.
- MEET ALL GROUNDING REQUIREMENTS OF SECTION 620 OF THE STANDARD SPECIFICATIONS.
- PLACE CAMERA AS CLOSE AS POSSIBLE TO THE CENTERLINE OF THE THROUGH LANES, USING BRACKET ARMS ANGLE CAMERA TOWARDS CENTER OF THROUGH LANES PER MANUFACTURE'S RECOMMENDATIONS.
- CONTRACTOR TO SIZE LUMINAIRE ARM TO MEET REQUIREMENTS OF NOTE 5 BUT LUMINAIRE ARM SHALL NOT EXCEED 15'.
- IF ASC DETECTOR CAMERA CABLES CAN NOT FIT THROUGH EXISTING WEATHER HEAD, INSTALL NEW SURFACE MOUNT CONDUIT. SECURE RIGID GALVANIZED CONDUIT IN ACCORDANCE WITH LATEST EDITION OF NEC AND FDOT SPECIFICATIONS.
- NO HOLES ARE TO BE DRILLED IN EXISTING SIGNAL STRAIN POLES. CONTRACTOR SHALL SUBMIT ARMS FOR ACCEPTANCE BY EITHER FDOT CERTIFICATION OR BY A SHOP DRAWING SUBMITTAL WITH CALCULATIONS.
- CONTRACTOR SHALL ADHERE TO OSHA INSTALLATION AND CONSTRUCTION REQUIREMENTS REGARDING SAFE DISTANCE FROM OVERHEAD POWER LINES.

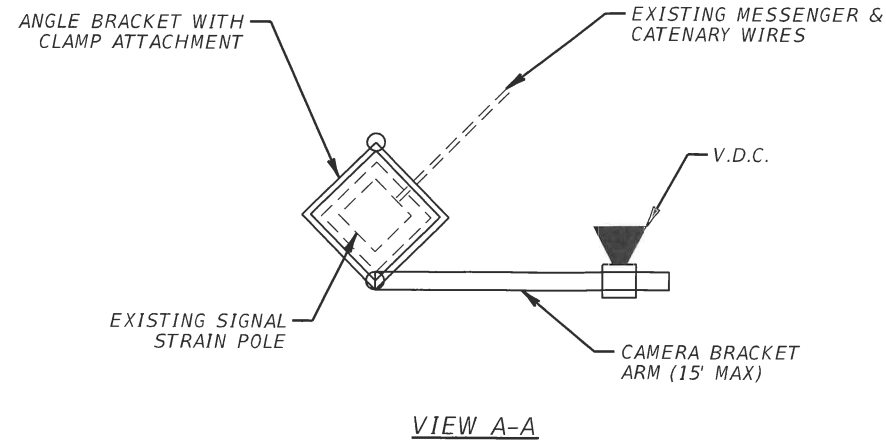

V.D.C. TO BE INSTALLED			
ID	INTERSECTION	QUADRANT	DETECTION AREA
10	US 301	NE CORNER	NB THRU LANES
10	US 301	SW CORNER	SB THRU LANES

ETHERNET REPEATERS TO BE INSTALLED			
No.	INTERSECTION	V.D.C. APPROACH LOCATION	REPEATER LOCATION
10	US 301	NORTH	STRAIN POLE AT SE CORNER

- NOTES:
- INSTALL V.D.C. AS CLOSE AS POSSIBLE TO 38' HEIGHT.

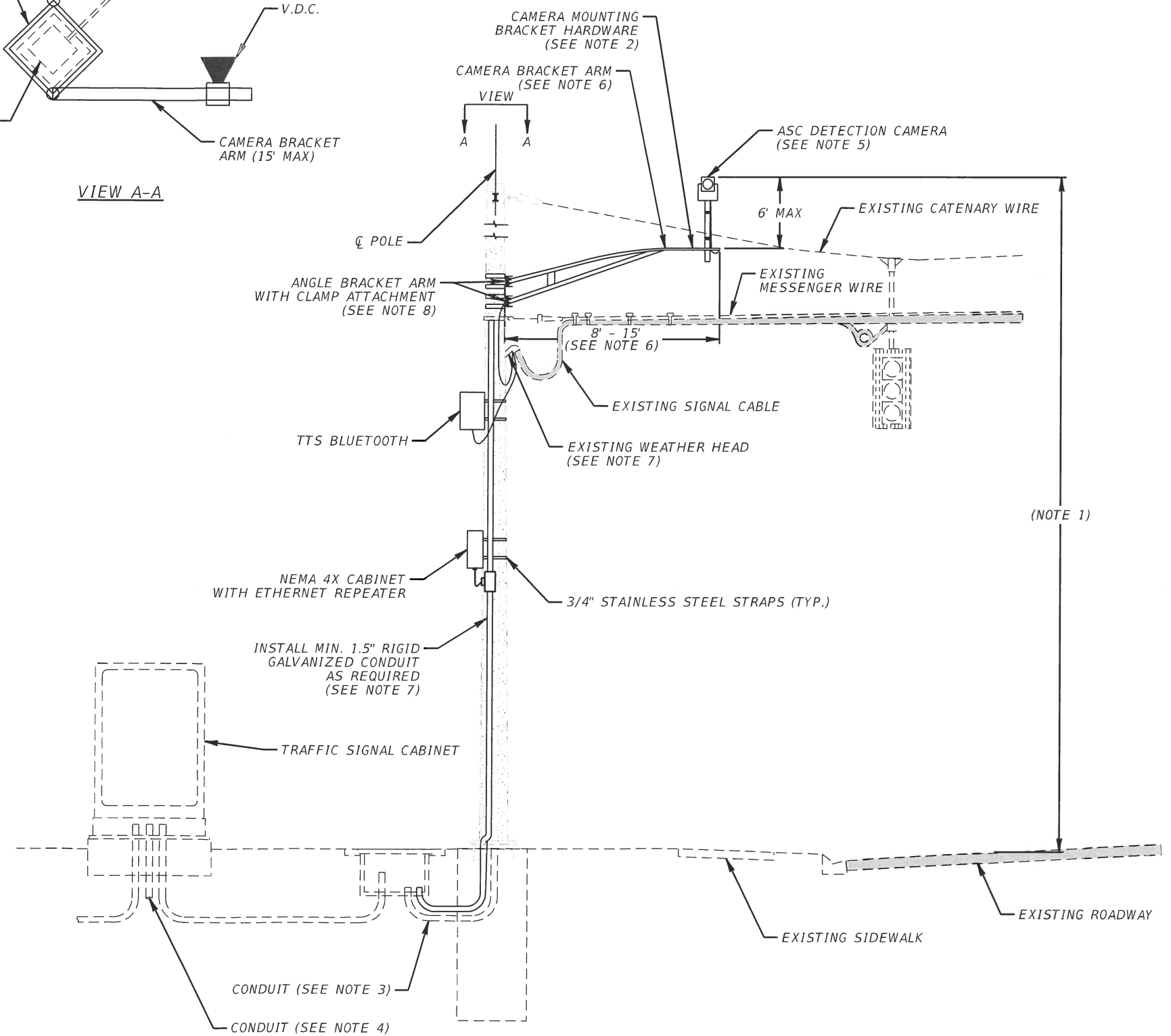

THE OFFICIAL RECORD OF THIS SHEET IS THE ELECTRONIC FILE DIGITALLY SIGNED AND SEALED UNDER RULE 61G15-23.004, F.A.C.

SCALE	AS NOTED	DESIGNED BY	RICARDO GONZALEZ	DATE	04-01-2016	DESIGN ENGINEER	RICARDO GONZALEZ	SHEET NO.
DRAWN BY	JUSTIN SCHICK	CHECKED BY	ROLANDO RAMIREZ	PROJECT NO.	438870-1-58-01	FL. LICENSE NO.	66564	IT-18
NO.	REVISIONS	DATE	BY	MANATEE COUNTY PUBLIC WORKS		ASC SPAN WIRE DETAIL		

DIRECTIONAL BORE AND TRENCHING DETAIL
NTS

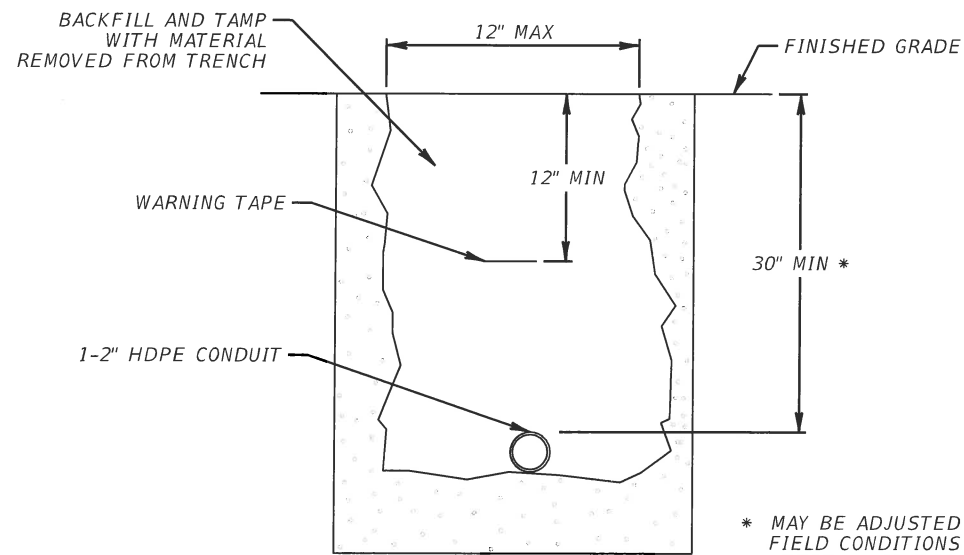

TYPICAL TRENCHING

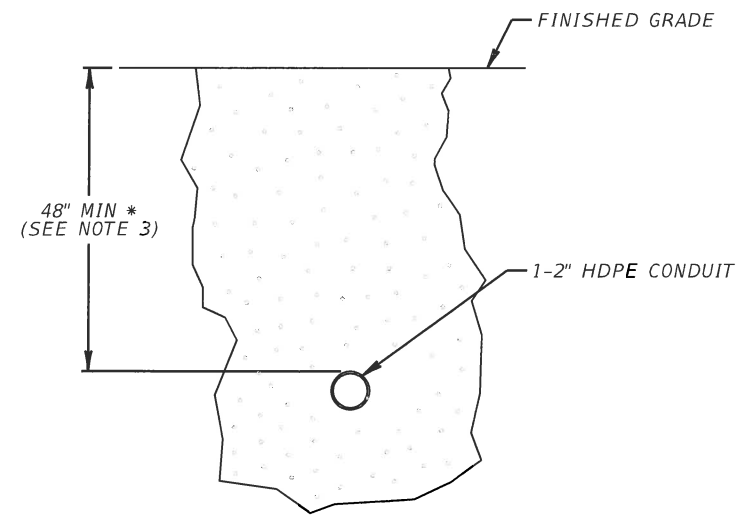
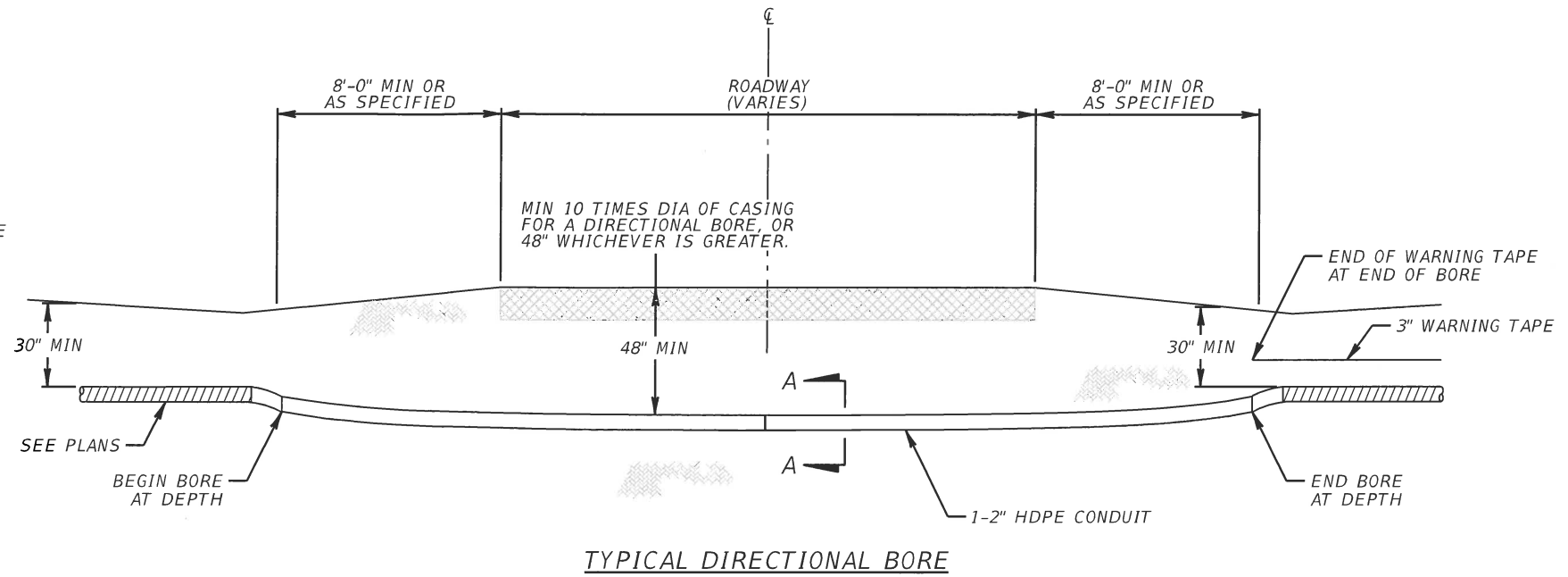

SECTION A-A

GENERAL NOTES:

- UTILITY IN THE PATH OF THE BORE SHALL BE LOCATED AND THE DEPTH OF THE BORE CROSSING SHALL BE DELINEATED TO CROSS UNDER OR OVER UTILITY WITH 12" MINIMUM SEPARATION.
- HORIZONTAL DEPTH SHALL BE IN ACCORDANCE WITH FDOT UTILITY ACCOMMODATION MANUAL SECTION 9.3 AND 12.3.
- FOR BORES WITH REAMER SIZE GREATER THAN 6", THE DEPTH FOR ROADWAY CROSSINGS SHALL BE GREATER THAN 10 TIMES THE BORE REAMER SIZE. THIS WILL AFFECT THE REQUIRED SETBACK DISTANCES IN ORDER TO MEET PROPER DRILL ENTRY AND EXIT ANGLE CRITERIA (NOT TO EXCEED A 1:4 OR 25% SLOPE).

SCALE AS NOTED		RICARDO J. GONZALEZ, P.E. P.E. NO.: 66564 METRIC ENGINEERING, INC. 615 CRESCENT EXECUTIVE CT, SUITE 524 LAKE MARY, FLORIDA 32746 TEL. (407) 644-1898 FAX. (407) 644-2376 CERTIFICATE OF AUTHORIZATION: 2294	DATE 04-01-2016	 MANATEE COUNTY PUBLIC WORKS	DESIGN ENGINEER RICARDO GONZALEZ	DIRECTIONAL BORE AND TRENCHING DETAIL	SHEET NO.
DESIGNED BY RICARDO GONZALEZ			PROJECT NO. 438870-1-58-01		FL. LICENSE NO. 66564		IT-19
DRAWN BY JUSTIN SCHICK							
CHECKED BY ROLANDO RAMIREZ							
NO.	REVISIONS	DATE	BY				

THE OFFICIAL RECORD OF THIS SHEET IS THE ELECTRONIC FILE DIGITALLY SIGNED AND SEALED UNDER RULE 61G15-23.004, F.A.C.

ITS PULL BOX AND CONDUIT DETAIL
NTS

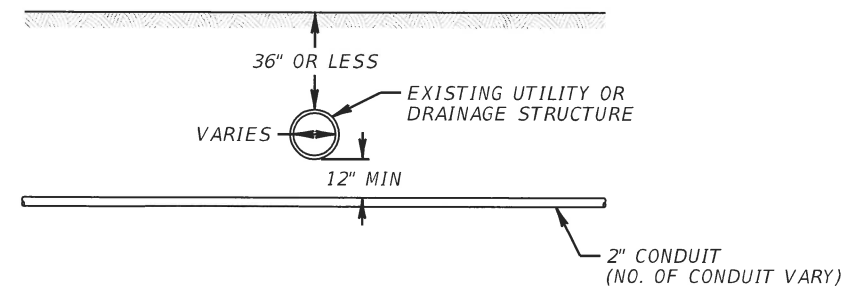
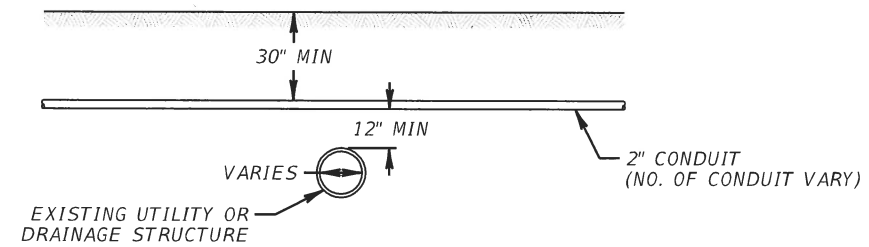
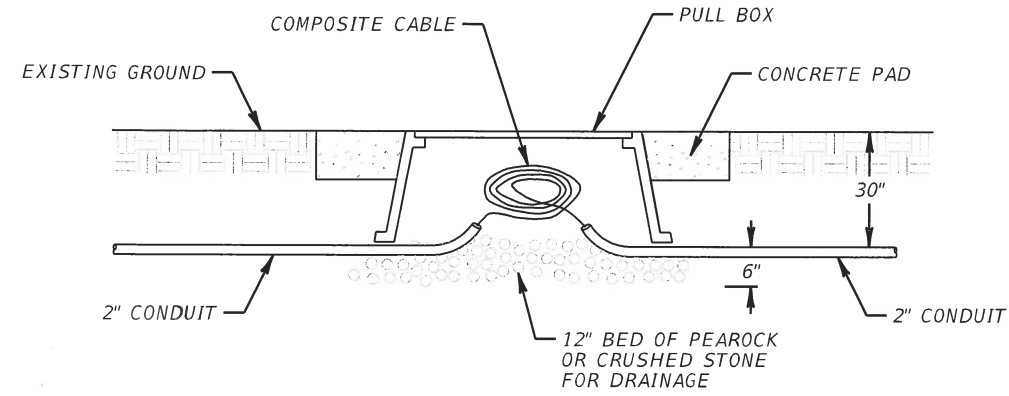
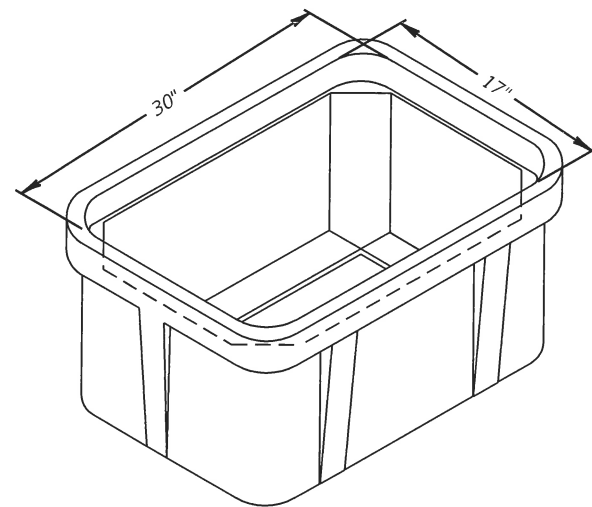
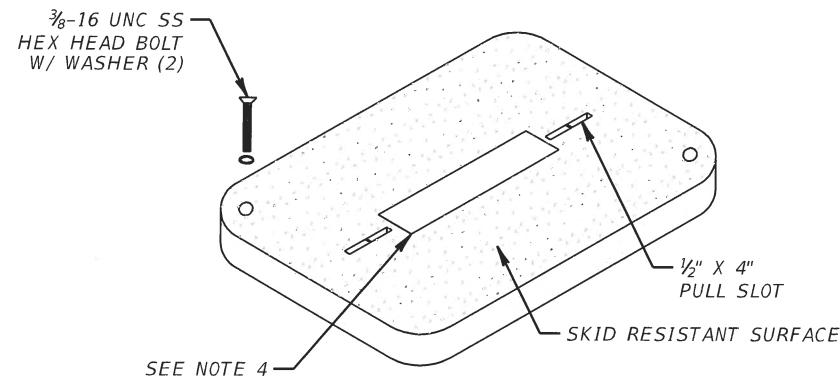

PULL BOX NOTES:

1. PULL BOX SHALL NOT BE INSTALLED IN ROADWAYS, DRIVEWAYS, PEDESTRIAN RAMPS, OR FLARES.
2. PULL BOX LENGTH (LONG SIDE) SHALL BE PARALLEL TO THE CONDUIT RUN. WHEN THE CONDUIT RUN IS PERPENDICULAR AT THE JUNCTION POINT, THE PULL BOX SHALL BE PARALLEL TO THE ROADWAY.
3. CONDUIT ϕ SHALL BE ALIGNED TO TOP EDGE OF PULL BOX TO FACILITATE CABLE PULLING.
4. PULL BOX SHALL BEAR LEGEND: "MANATEE COUNTY TRAFFIC SIGNALS"

SCALE		AS NOTED		RICARDO J. GONZALEZ, P.E. P.E. NO.: 66564		DATE 04-01-2016		 MANATEE COUNTY PUBLIC WORKS		DESIGN ENGINEER RICARDO GONZALEZ		ITS PULL BOX AND CONDUIT DETAIL		SHEET NO. IT-20	
DESIGNED BY RICARDO GONZALEZ		DRAWN BY JUSTIN SCHICK		METRIC ENGINEERING, INC. 615 CRESCENT EXECUTIVE CT, SUITE 524 LAKE MARY, FLORIDA 32746 TEL. (407) 644-1898 FAX. (407) 644-2376		PROJECT NO. 438870-1-58-01				FL. LICENSE NO. 66564					
NO.		REVISIONS		DATE		BY		CHECKED BY ROLANDO RAMIREZ		CERTIFICATE OF AUTHORIZATION: 2294					

THE OFFICIAL RECORD OF THIS SHEET IS THE ELECTRONIC FILE DIGITALLY SIGNED AND SEALED UNDER RULE 61G15-23.004, F.A.C.