



Geotechnical Engineering Report

**Port Harbor Pkwy. & Upper Manatee River Rd.
Manatee County, Florida**

December 11, 2019

Terracon Project No. HC195029

Prepared for:

HDR, Inc.
Sarasota, FL

Prepared by:

Terracon Consultants, Inc.
Sarasota, Florida



December 11, 2019

HDR, Inc.
2601 Cattlemen Road, Suite 400
Sarasota, FL 34232



Attn: Mr. Jason Starr, P.E.
P: (941) 342-2711
E: Jason.Starr@hdrinc.com

Re: Geotechnical Engineering Report
Port Harbor Pkwy. & Upper Manatee River Rd.
Project Address
Manatee County, Florida
Terracon Project No. HC195029

Dear Mr. Starr:

We have completed the Geotechnical Engineering services for the above referenced project. This study was performed in general accordance with Terracon Proposal No. PHC195029 dated May 7, 2019 and authorized on June 14, 2019. This report presents the findings of the subsurface exploration and provides geotechnical recommendations concerning the new signal pole foundations for the project.

We appreciate the opportunity to be of service to you on this project. If you have any questions concerning this report or if we may be of further service, please contact us.

Sincerely,
Terracon Consultants, Inc.

James M. Jackson, P.E.
Department Manager
FL License No. 77733

Douglas S. Dunkelberger, P.E.
Principal
FL License No. 33317

REPORT TOPICS

INTRODUCTION	1
SITE CONDITIONS	1
PROJECT DESCRIPTION	2
GEOTECHNICAL CHARACTERIZATION	2
GEOTECHNICAL OVERVIEW	3
GENERAL COMMENTS	4

Note: This report was originally delivered in a web-based format. **Orange Bold** text in the report indicates a referenced section heading. The PDF version also includes hyperlinks which direct the reader to that section and clicking on the **GeoReport** logo will bring you back to this page. For more interactive features, please view your project online at client.terracon.com.

ATTACHMENTS

EXPLORATION AND TESTING PROCEDURES
SITE LOCATION PLAN
EXPLORATION RESULTS
SUPPORTING INFORMATION

Note: Refer to each individual Attachment for a listing of contents.

Geotechnical Engineering Report
Port Harbor Pkwy. & Upper Manatee River Rd.
Manatee County, Florida
Terracon Project No. HC195029
December 11, 2019

INTRODUCTION

This report presents the results of our subsurface exploration and geotechnical engineering services performed for the proposed new signal pole foundations to be located at the intersection of Upper Manatee River Road and Port Harbor Parkway in Manatee County, Florida. The purpose of these services is to provide information and geotechnical engineering recommendations relative to:

- Subsurface soil conditions
- Groundwater conditions
- Soil parameters for pole foundation design

The geotechnical engineering Scope of Services for this project included the advancement of four test borings to depths of approximately 30 feet below existing site grades.

Maps showing the site and boring locations are shown in the **Site Location** and **Report of Core Borings** sections, respectively. The results of the laboratory testing performed on soil samples obtained from the site during the field exploration are included on the **Report of Core Borings** in the **Exploration Results** section.

SITE CONDITIONS

The following description of site conditions is derived from our site visit in association with the field exploration and our review of publicly available geologic and topographic maps.

Item	Description
Parcel Information	The project is located at the intersection of Upper Manatee River Road and Port Harbor Parkway in Manatee County, Florida. See Site Location
Existing Improvements	Upper Manatee River Road is a two-lane road with grass shoulders. Port Harbor Parkway is still under construction.
Current Ground Cover	Short grasses and bare soil.
Existing Topography	Based on the topographic information provided by you via email, the west side of the intersection is at an elevation of about +16 feet-NAVD and the east side is at an elevation of about +14 feet-NAVD.

Item	Description
Prior Land Use	Review of aerial photographs (ref. Google Earth) indicate the site has been developed with Upper Manatee River Road from sometime prior to 1995 to the present day.
Surficial Soil Conditions	<p>Review of the Soil Survey for Manatee County, Florida issued April 1983 indicates the site is mapped with Soil Unit 48, Wabasso fine sand. The typical soil profile consists of fine sand to a depth of 37 inches, followed by loamy material to a depth of 65 inches, and underlain by sand with shell fragments to a depth of 80 inches. Under natural (pre-development) conditions, groundwater is reported to be between 10 and 40 inches below the ground surface.</p> <p>Additionally, our experience near the vicinity of the proposed site indicates that subsurface conditions will likely consist of sands with varying amounts of silt and clay from the surface to a depth of about 25 feet followed by weathered limestone.</p>

PROJECT DESCRIPTION

Our final understanding of the project conditions is as follows:

Item	Description
Information Provided	The following information was provided by you via e-mail on April 3, 2019.
Project Description	The project includes four new mast arm signal poles.
Proposed Structure	The project includes four new mast arm signal poles supported on drilled shaft foundations (to be designed by others).
Maximum Loads	Structural loads for the new mast arm foundations were not provided.
Grading/Slopes	We expect existing site grades on the west side of the road are to be maintained and the east side is to be raised by up to 2 feet of grading fill.

GEOTECHNICAL CHARACTERIZATION

We have developed a general characterization of the subsurface conditions based upon our review of the subsurface exploration, laboratory data, geologic setting and our understanding of the project. Conditions encountered at each exploration point are indicated on the attached **Report of Core Borings** in the **Exploration Results** section.

As part of our analyses, we identified the following model layers within the subsurface profile.

Model Layer	Layer Name	General Description
1	Sand	Fine sand with silt and trace to some shell fragments (A-3, SP-SM), loose to medium dense
2	Clayey Sand	Clayey sand (A-2-6, SC)*
3	Silty Sand	Silty sand (A-2-4, SM), very loose to loose
4	Clay	Clay (A-7-5, A-7-6, CH), stiff to hard

*relative density not determined as layer occurred within depth zone of hand augering

Groundwater

Groundwater was found at a depth of about 4 feet bgs while sampling. The groundwater levels shown are not fully stabilized as evidenced by higher readings in Borings B-2 and B-4 which found a layer of low permeability clayey sand that likely restricted groundwater flow into the boreholes. Groundwater fluctuations occur due to seasonal variations in the amount of rainfall, runoff and other factors not evident at the time the borings were performed. Therefore, groundwater levels during construction or at other times in the life of the structure may be higher or lower than the levels indicated on the boring logs. The possibility of groundwater level fluctuations should be considered when developing the design and construction plans for the project.

If more accurate groundwater data is desired, we recommend the installation of piezometers that could be monitored over a period of time.

GEOTECHNICAL OVERVIEW

The table on the **Report of Core Boring for Signal Pole** presents design parameters for the different soil strata encountered at the boring location. The soil parameters (unit weight, friction angles, and soil moduli) were based on empirical correlations (ref: Florida Department of Transportation Soils and Foundations Handbook, 2020) with average SPT blow counts (N-Values) for the different soil strata. The effective cohesion values were based on correlations with average N-Values for the clay strata (ref: Essentials of Soil Mechanics and Foundations, 7th Edition). Lateral earth pressure coefficients were based on the estimated friction angles. It is our understanding that the pole foundations will be drilled shafts designed by others. The pole foundations should be designed based on frictional resistance (side shear) only using the soil parameters provided on the exhibit.

The **General Comments** section provides an understanding of the report limitations.

GENERAL COMMENTS

Our analysis and opinions are based upon our understanding of the project, the geotechnical conditions in the area, and the data obtained from our site exploration. Natural variations will occur between exploration point locations or due to the modifying effects of construction or weather. The nature and extent of such variations may not become evident until during or after construction. Terracon should be retained as the Geotechnical Engineer, where noted in this report, to provide observation and testing services during pertinent construction phases. If variations appear, we can provide further evaluation and supplemental recommendations. If variations are noted in the absence of our observation and testing services on-site, we should be immediately notified so that we can provide evaluation and supplemental recommendations.

Our Scope of Services does not include either specifically or by implication any environmental or biological (e.g., mold, fungi, bacteria) assessment of the site or identification or prevention of pollutants, hazardous materials or conditions. If the owner is concerned about the potential for such contamination or pollution, other studies should be undertaken.

Our services and any correspondence or collaboration through this system are intended for the sole benefit and exclusive use of our client for specific application to the project discussed and are accomplished in accordance with generally accepted geotechnical engineering practices with no third-party beneficiaries intended. Any third-party access to services or correspondence is solely for information purposes to support the services provided by Terracon to our client. Reliance upon the services and any work product is limited to our client, and is not intended for third parties. Any use or reliance of the provided information by third parties is done solely at their own risk. No warranties, either express or implied, are intended or made.

Site characteristics as provided are for design purposes and not to estimate excavation cost. Any use of our report in that regard is done at the sole risk of the excavating cost estimator as there may be variations on the site that are not apparent in the data that could significantly impact excavation cost. Any parties charged with estimating excavation costs should seek their own site characterization for specific purposes to obtain the specific level of detail necessary for costing. Site safety, and cost estimating including, excavation support, and dewatering requirements/design are the responsibility of others. If changes in the nature, design, or location of the project are planned, our conclusions and recommendations shall not be considered valid unless we review the changes and either verify or modify our conclusions in writing.

ATTACHMENTS

EXPLORATION AND TESTING PROCEDURES

Field Exploration

Number of Borings	Boring Depth (feet)	Location
4	30	Planned signal pole locations

Boring Layout and Elevations: Unless otherwise noted, Terracon personnel provided the boring layout. Coordinates were obtained with a handheld GPS unit (estimated horizontal accuracy of about ± 10 feet). If elevations and a more precise boring layout are desired, we recommend borings be surveyed following completion of fieldwork.

Subsurface Exploration Procedures: We advanced the borings with a track-mounted rotary drill rig using mud rotary procedures. Five samples were obtained in the upper 10 feet of each boring and at intervals of 5 feet thereafter. In the split-barrel sampling procedure, a standard 2-inch outer diameter split-barrel sampling spoon was driven into the ground by a 140-pound rope and cathead operated safety hammer falling a distance of 30 inches. The number of blows required to advance the sampling spoon the last 12 inches of a normal 18-inch penetration or the middle 12 inches of a 24-inch penetration is recorded as the Standard Penetration Test (SPT) resistance value. The SPT resistance values, also referred to as N-values, are indicated on the boring logs at the test depths. We observed and recorded groundwater levels during drilling. All borings were backfilled with cement grout at their completion.

The sampling depths, penetration distances, and other sampling information was recorded on the field boring logs. The samples were placed in appropriate containers and taken to our soil laboratory for testing and classification by a Geotechnical Engineer. Our exploration team prepared field boring logs as part of the drilling operations. These field logs included visual classifications of the materials encountered during drilling and our interpretation of the subsurface conditions between samples. Final boring logs were prepared from the field logs. The final boring logs represent the Geotechnical Engineer's interpretation of the field logs and include modifications based on observations and tests of the samples in our laboratory.

Laboratory Testing

The project engineer reviewed the field data and assigned laboratory tests to understand the engineering properties of the various soil strata, as necessary, for this project. Procedural standards noted below are for reference to methodology in general. In some cases, variations to methods were applied because of local practice or professional judgment. Standards noted below include reference to other, related standards. Such references are not necessarily applicable to describe the specific test performed.

Geotechnical Engineering Report

Port Harbor Pkwy. & Upper Manatee River Rd. ■ Manatee County, Florida
December 11, 2019 ■ Terracon Project No. HC195029



- ASTM D2216 Standard Test Methods for Laboratory Determination of Water (Moisture) Content of Soil and Rock by Mass
- ASTM D1140-17 Standard Test Method for Amount of Material in Soils Finer than No. 200 (75- μ m) Sieve)

Our laboratory testing program also includes examination of soil samples by an engineer. Based on observation and test data, the engineer classified the soil samples in accordance with the American Association of State Highway and Transportation Officials (AASHTO) soil classification system and the Unified Soil Classification System (USCS).

SITE LOCATION AND EXPLORATION PLANS

Contents:

Site Location Plan

Note: All attachments are one page unless noted above.

SITE LOCATION

Port Harbor Pkwy. & Upper Manatee River Rd. ■ Manatee County, Florida
December 11, 2019 ■ Terracon Project No. HC195029

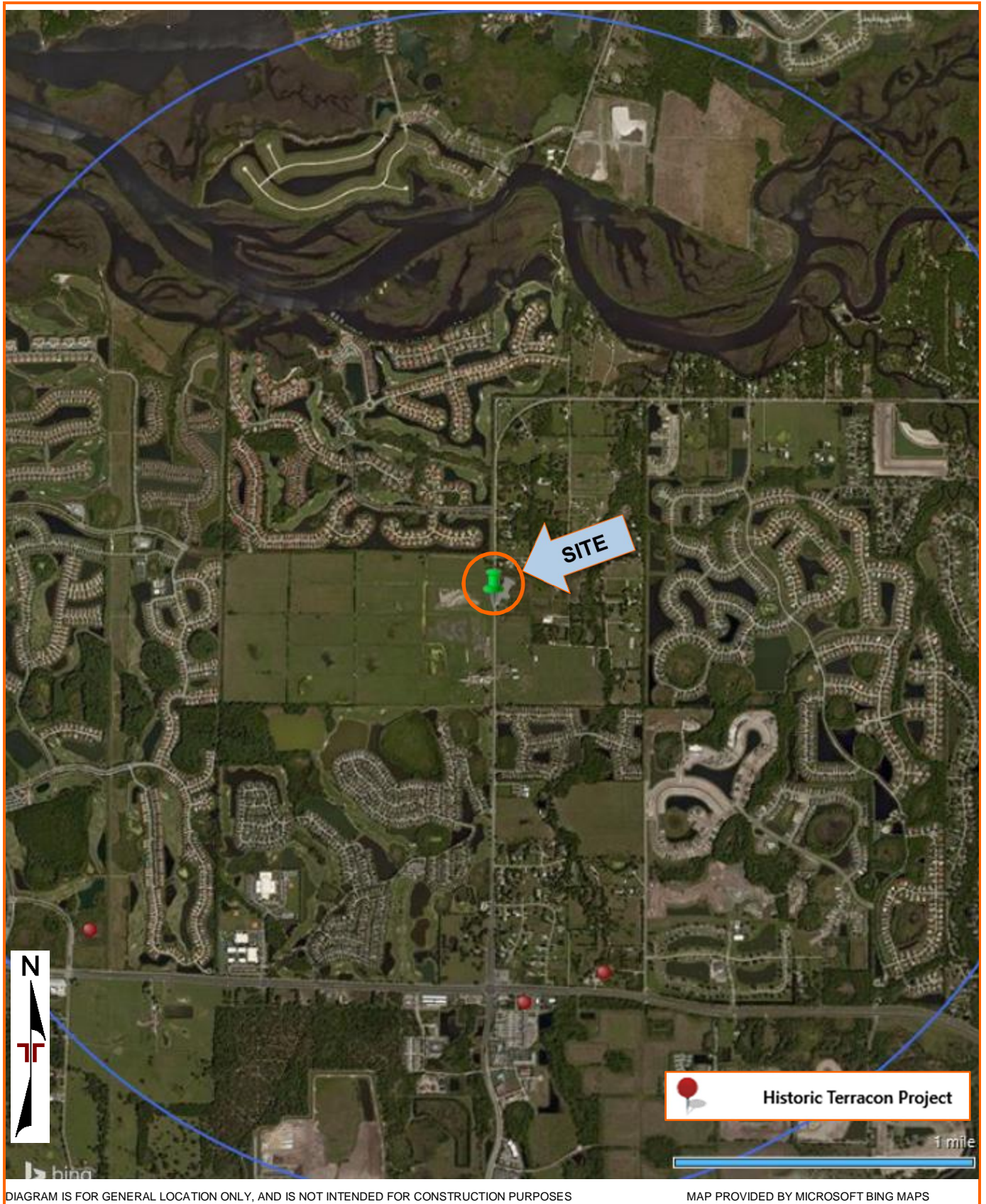

DIAGRAM IS FOR GENERAL LOCATION ONLY, AND IS NOT INTENDED FOR CONSTRUCTION PURPOSES

MAP PROVIDED BY MICROSOFT BING MAPS

EXPLORATION RESULTS

Contents:

Report of Core Borings

Note: All attachments are one page unless noted above.

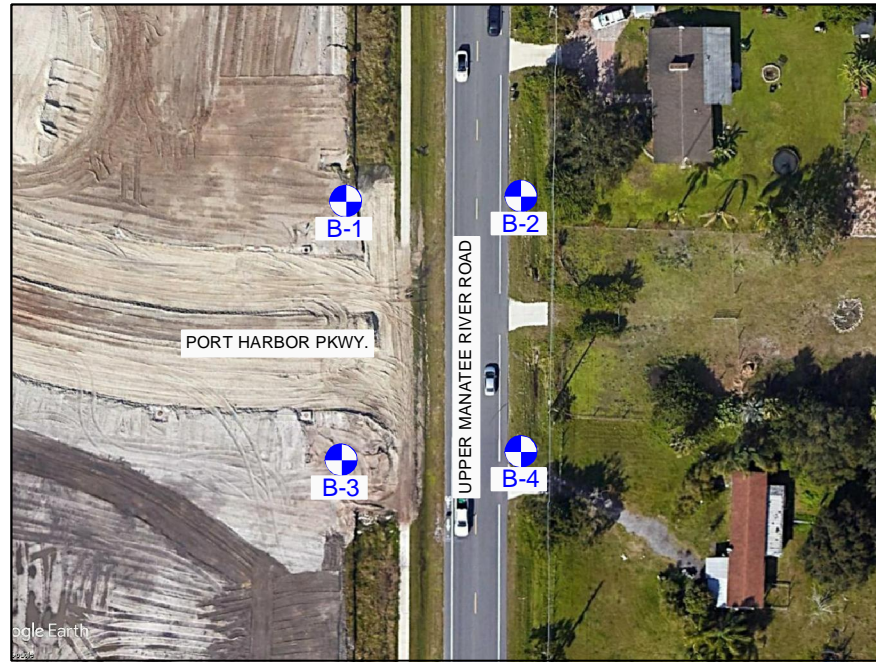

SOURCE: GOOGLE EARTH PRO



LEGEND



APPROXIMATE LOCATION OF STANDARD PENETRATION TEST BORING

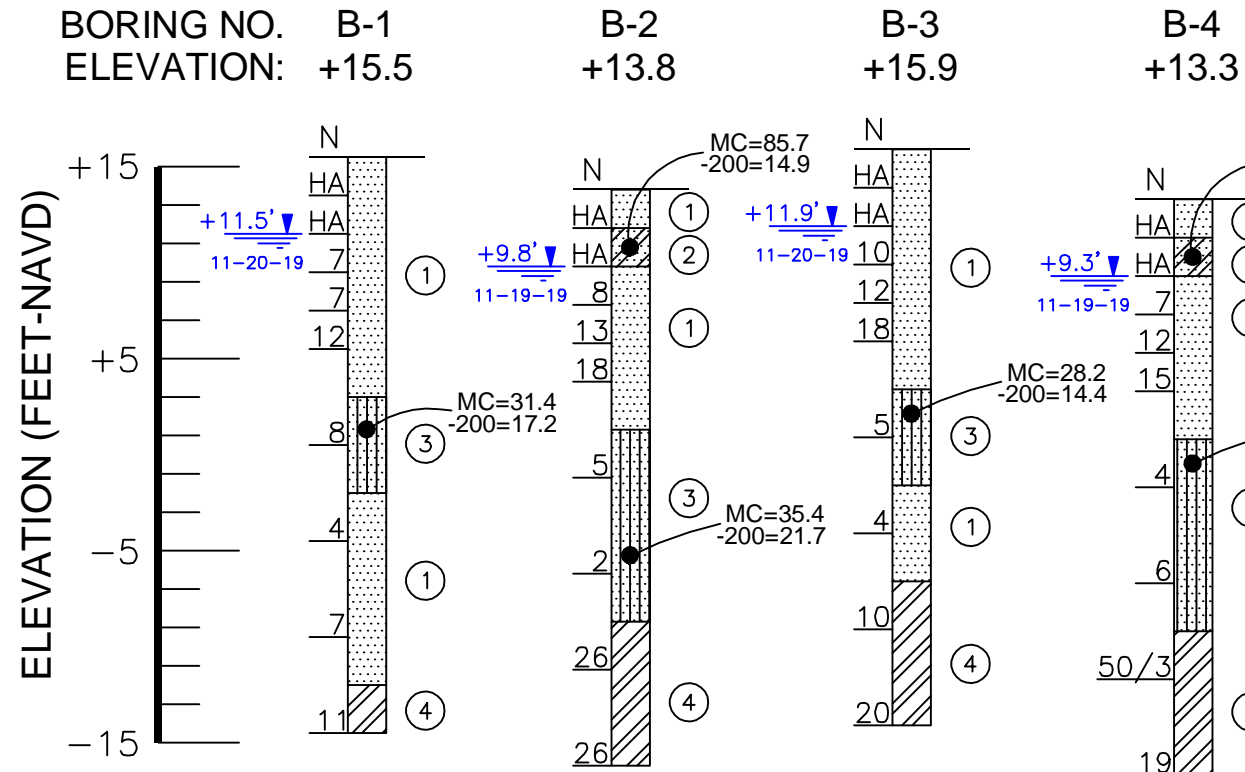

GENERAL LEGEND

- ① Brown, light brown, and gray fine SAND with silt and trace to some shell fragments (A-3, SP-SM)
- ② Orange and gray clayey SAND (A-2-6, SC)
- ③ Gray to black silty SAND (A-2-4, SM)
- ④ Bluish gray to gray CLAY (A-7-5, A-7-6, CH)
- HA – Hand auger 4 feet in order to avoid possible conflict with underground utilities
- N – Standard penetration resistance in blows per foot unless otherwise noted
- SP – Unified Soil Classification System Group Symbol (ASTM D 2487)
- +11.5' 11-20-19 – Elevation of groundwater (feet-NAVD) & date measured
- MC – Moisture Content (%)
- 200 – Amount Finer Than The U.S. Standard No. 200 Sieve (%)
- 50/3 – Indicates fifty SPT hammer blows were required to drive the sampler 3 inches

SUMMARY OF FOUNDATION DESIGN PARAMETERS FOR B-1

Depth (feet)	Soil Type	Unit Weight (pcf)		Angle of Internal Friction (degrees)	Effective Cohesion (psf)	Earth Pressure Coefficients		Soil Modulus, k (pci)
		Moist	Submerged			Ka	Kp	
0 to 28	SAND	105	43	29	0	0.347	2.88	15
28 to 30	CLAY	120	58	0	1,100	1.00	1.00	-

SUMMARY OF FOUNDATION DESIGN PARAMETERS FOR B-3

Depth (feet)	Soil Type	Unit Weight (pcf)		Angle of Internal Friction (degrees)	Effective Cohesion (psf)	Earth Pressure Coefficients		Soil Modulus, k (pci)
		Moist	Submerged			Ka	Kp	
0 to 23	SAND	105	43	30	0	0.333	3.00	20
23 to 30	CLAY	125	63	0	2,600	1.00	1.00	-

SUMMARY OF FOUNDATION DESIGN PARAMETERS FOR B-2 & B-4

Depth (feet)	Soil Type	Unit Weight (pcf)		Angle of Internal Friction (degrees)	Effective Cohesion (psf)	Earth Pressure Coefficients		Soil Modulus, k (pci)
		Moist	Submerged			Ka	Kp	
0 to 2	SAND	105	43	29	0	0.347	2.88	10
2 to 4	SAND	105	43	27	0	0.376	2.66	10
4 to 13	SAND	110	48	30	0	0.333	3.00	25
13 to 23	SAND	100	38	26	0	0.391	2.56	8
28 to 30	CLAY	120	58	0	1,500	1.00	1.00	-

ENGINEERING CLASSIFICATION (SAFETY HAMMER)

GRANULAR MATERIALS		SILTS AND CLAYS	
Relative Density	SPT BLOW-COUNTS	Consistency	SPT BLOW-COUNTS
Very Loose	Less than 4	Very Soft	Less than 2
Loose	4 - 10	Soft	2 - 4
Medium Dense	10 - 30	Firm	4 - 8
Dense	30 - 50	Stiff	8 - 15
Very Dense	Greater than 50	Very Stiff	15 - 30
		Hard	Greater than 30

STANDARD PENETRATION TEST DATA

SPOON INSIDE DIA.	1.375 inch
SPOON OUTSIDE DIA.	2.00 inches
AVG. HAMMER DROP	30 inches
HAMMER WEIGHT	140 pounds

NOTES

- (1) Borings were drilled on November 19 and 20, 2019 using a BR 2500 drilling rig equipped with a safety hammer.
- (2) Strata boundaries are approximate and represent soil strata at each test hole location only. Soil transitions may be more gradual than implied.
- (3) Groundwater elevations shown on the subsurface profiles represent the groundwater levels on the dates shown. Groundwater level fluctuations should be anticipated throughout the year.
- (4) Elevations were provided by HDR.

JAMES M. JACKSON, P.E
FL LICENSE NO. 77733

Project Mngr:	JMJ	Project No.:	HC195029
Drawn By:	JMJ	Scale:	AS-SHOWN
Checked By:	JMJ	File No.:	1
Approved By:	DSD	Date:	12-4-19

Terracon
Consulting Engineers and Scientists

8260 VICO COURT, UNIT B SARASOTA, FL 34240
PH. (941) 379-0621 FAX. (941) 379-5061

REPORT OF CORE BORINGS
GEOTECHNICAL ENGINEERING REPORT
UPPER MANATEE RIVER ROAD
& PORT HARBOR PARKWAY
MANATEE COUNTY, FLORIDA

EXHIBIT
1

SUPPORTING INFORMATION

Contents:









General Notes

Unified Soil Classification System

Note: All attachments are one page unless noted above.

GENERAL NOTES

DESCRIPTION OF SYMBOLS AND ABBREVIATIONS

SAMPLING	 Auger Cuttings  Grab Sample  Shelby Tube	 Rock Core  No Recovery  Standard Penetration Test	WATER LEVEL	 Water Initially Encountered  Water Level After a Specified Period of Time  Water Level After a Specified Period of Time Water levels indicated on the soil boring logs are the levels measured in the borehole at the times indicated. Groundwater level variations will occur over time. In low permeability soils, accurate determination of groundwater levels is not possible with short term water level observations.	FIELD TESTS	(HP) Hand Penetrometer (T) Torvane (DCP) Dynamic Cone Penetrometer (PID) Photo-Ionization Detector (OVA) Organic Vapor Analyzer
-----------------	--	---	--------------------	--	--------------------	---

DESCRIPTIVE SOIL CLASSIFICATION

Soil classification is based on the Unified Soil Classification System. Coarse Grained Soils have more than 50% of their dry weight retained on a #200 sieve; their principal descriptors are: boulders, cobbles, gravel or sand. Fine Grained Soils have less than 50% of their dry weight retained on a #200 sieve; they are principally described as clays if they are plastic, and silts if they are slightly plastic or non-plastic. Major constituents may be added as modifiers and minor constituents may be added according to the relative proportions based on grain size. In addition to gradation, coarse-grained soils are defined on the basis of their in-place relative density and fine-grained soils on the basis of their consistency.

LOCATION AND ELEVATION NOTES

Unless otherwise noted, Latitude and Longitude are approximately determined using a hand-held GPS device. The accuracy of such devices is variable. Surface elevation data annotated with +/- indicates that no actual topographical survey was conducted to confirm the surface elevation. Instead, the surface elevation was approximately determined from topographic maps of the area.

STRENGTH TERMS	RELATIVE DENSITY OF COARSE-GRAINED SOILS <small>(More than 50% retained on No. 200 sieve.) Density determined by Standard Penetration Resistance</small>		CONSISTENCY OF FINE-GRAINED SOILS <small>(50% or more passing the No. 200 sieve.) Consistency determined by laboratory shear strength testing, field visual-manual procedures or standard penetration resistance</small>		
	Descriptive Term (Density)	Standard Penetration or N-Value Blows/Ft.	Descriptive Term (Consistency)	Unconfined Compressive Strength Qu, (psf)	Standard Penetration or N-Value Blows/Ft.
	Very Loose	0 - 3	Very Soft	less than 500	0 - 1
	Loose	4 - 9	Soft	500 to 1,000	2 - 4
	Medium Dense	10 - 29	Medium Stiff	1,000 to 2,000	4 - 8
	Dense	30 - 50	Stiff	2,000 to 4,000	8 - 15
	Very Dense	> 50	Very Stiff	4,000 to 8,000	15 - 30
		Hard	> 8,000	> 30	

RELATIVE PROPORTIONS OF SAND AND GRAVEL

Descriptive Term(s) of other constituents	Percent of Dry Weight
Trace	< 15
With	15 - 29
Modifier	> 30

GRAIN SIZE TERMINOLOGY

Major Component of Sample	Particle Size
Boulders	Over 12 in. (300 mm)
Cobbles	12 in. to 3 in. (300mm to 75mm)
Gravel	3 in. to #4 sieve (75mm to 4.75 mm)
Sand	#4 to #200 sieve (4.75mm to 0.075mm)
Silt or Clay	Passing #200 sieve (0.075mm)

RELATIVE PROPORTIONS OF FINES

Descriptive Term(s) of other constituents	Percent of Dry Weight
Trace	< 5
With	5 - 12
Modifier	> 12

PLASTICITY DESCRIPTION

Term	Plasticity Index
Non-plastic	0
Low	1 - 10
Medium	11 - 30
High	> 30

Criteria for Assigning Group Symbols and Group Names Using Laboratory Tests ^A				Soil Classification		
				Group Symbol	Group Name ^B	
Coarse-Grained Soils: More than 50% retained on No. 200 sieve	Gravels: More than 50% of coarse fraction retained on No. 4 sieve	Clean Gravels: Less than 5% fines ^C	$Cu \geq 4$ and $1 \leq Cc \leq 3$ ^E	GW	Well-graded gravel ^F	
			$Cu < 4$ and/or $[Cc < 1 \text{ or } Cc > 3.0]$ ^E	GP	Poorly graded gravel ^F	
		Gravels with Fines: More than 12% fines ^C	Fines classify as ML or MH	GM	Silty gravel ^{F, G, H}	
			Fines classify as CL or CH	GC	Clayey gravel ^{F, G, H}	
	Sands: 50% or more of coarse fraction passes No. 4 sieve	Clean Sands: Less than 5% fines ^D	$Cu \geq 6$ and $1 \leq Cc \leq 3$ ^E	SW	Well-graded sand ^I	
			$Cu < 6$ and/or $[Cc < 1 \text{ or } Cc > 3.0]$ ^E	SP	Poorly graded sand ^I	
		Sands with Fines: More than 12% fines ^D	Fines classify as ML or MH	SM	Silty sand ^{G, H, I}	
			Fines classify as CL or CH	SC	Clayey sand ^{G, H, I}	
Fine-Grained Soils: 50% or more passes the No. 200 sieve	Silts and Clays: Liquid limit less than 50	Inorganic:	$PI > 7$ and plots on or above "A" line	CL	Lean clay ^{K, L, M}	
			$PI < 4$ or plots below "A" line ^J	ML	Silt ^{K, L, M}	
		Organic:	Liquid limit - oven dried	< 0.75	OL	Organic clay ^{K, L, M, N}
			Liquid limit - not dried			Organic silt ^{K, L, M, O}
	Silts and Clays: Liquid limit 50 or more	Inorganic:	PI plots on or above "A" line	CH	Fat clay ^{K, L, M}	
			PI plots below "A" line	MH	Elastic Silt ^{K, L, M}	
		Organic:	Liquid limit - oven dried	< 0.75	OH	Organic clay ^{K, L, M, P}
			Liquid limit - not dried			Organic silt ^{K, L, M, Q}
Highly organic soils:	Primarily organic matter, dark in color, and organic odor			PT	Peat	

^A Based on the material passing the 3-inch (75-mm) sieve.

^B If field sample contained cobbles or boulders, or both, add "with cobbles or boulders, or both" to group name.

^C Gravels with 5 to 12% fines require dual symbols: GW-GM well-graded gravel with silt, GW-GC well-graded gravel with clay, GP-GM poorly graded gravel with silt, GP-GC poorly graded gravel with clay.

^D Sands with 5 to 12% fines require dual symbols: SW-SM well-graded sand with silt, SW-SC well-graded sand with clay, SP-SM poorly graded sand with silt, SP-SC poorly graded sand with clay.

$$E \quad Cu = D_{60}/D_{10} \quad Cc = \frac{(D_{30})^2}{D_{10} \times D_{60}}$$

^F If soil contains ³ 15% sand, add "with sand" to group name.

^G If fines classify as CL-ML, use dual symbol GC-GM, or SC-SM.

^H If fines are organic, add "with organic fines" to group name.

^I If soil contains ³ 15% gravel, add "with gravel" to group name.

^J If Atterberg limits plot in shaded area, soil is a CL-ML, silty clay.

^K If soil contains 15 to 29% plus No. 200, add "with sand" or "with gravel," whichever is predominant.

^L If soil contains ³ 30% plus No. 200 predominantly sand, add "sandy" to group name.

^M If soil contains ³ 30% plus No. 200, predominantly gravel, add "gravelly" to group name.

^N $PI \geq 4$ and plots on or above "A" line.

^O $PI < 4$ or plots below "A" line.

^P PI plots on or above "A" line.

^Q PI plots below "A" line.

